



## Enterprise Architect User Guide

*Enterprise Architect is an intuitive, flexible and powerful UML analysis and design tool for building robust and maintainable software. From requirements gathering, through analysis, modeling, implementation and testing to deployment and maintenance, Enterprise Architect is a fast, feature-rich, multi-user UML modeling tool, driving the long-term success of your software project.*



# Enterprise Architect User Guide

## Introduction

---

*by Geoffrey Sparks*

*Enterprise Architect is a complete UML-based solution for analysing, designing, managing, sharing and building software systems.*

# Enterprise Architect User Guide

© 1998-2010 Sparx Systems Pty Ltd

All rights reserved. No parts of this work may be reproduced in any form or by any means - graphic, electronic, or mechanical, including photocopying, recording, taping, or information storage and retrieval systems - without the written permission of the publisher.

Products that are referred to in this document may be either trademarks and/or registered trademarks of the respective owners. The publisher and the author make no claim to these trademarks.

While every precaution has been taken in the preparation of this document, the publisher and the author assume no responsibility for errors or omissions, or for damages resulting from the use of information contained in this document or from the use of programs and source code that may accompany it. In no event shall the publisher and the author be liable for any loss of profit or any other commercial damage caused or alleged to have been caused directly or indirectly by this document.

Printed: August 2010

## **Publisher**

*Sparx Systems*

## **Managing Editor**

*Geoffrey Sparks*

## **Technical Editors**

*Geoffrey Sparks*

*Dermot O'Bryan*

*Simon McNeilly*

*Neil Capey*

*Sam Mancarella*

*John Redfern*

*Vimal Kumar*

*Howard Britten*

*Brad Maxwell*

*Steve Meagher*

## **Special thanks to:**

*All the people who have contributed suggestions, examples, bug reports and assistance in the development of Enterprise Architect. The task of developing and maintaining this tool has been greatly enhanced by their contribution.*

# Table of Contents

Foreword .....	1
<b>Part I Introduction</b> .....	<b>3</b>
Overview .....	4
What You Can Do .....	4
Key Benefits .....	5
Key Features .....	8
Enterprise Architect Editions .....	10
The Trial Version .....	10
Editions Available .....	12
The Read-only 'Lite' Edition .....	15
Formal Statements .....	16
Copyright Notice .....	16
End User License Agreement .....	16
Trademarks .....	19
Acknowledgements .....	20
Installation .....	21
Register a Full License .....	22
Help and Support .....	23
Available Helpfile Formats .....	24
Support .....	24
<b>Part II Getting Started</b> .....	<b>26</b>
Basics .....	27
A Quickstart Tutorial .....	28
Add a View to a Model .....	29
Add a Package To a Model .....	30
Add a Diagram to a Package .....	30
Add Elements .....	31
Add Connectors .....	32
Define Properties .....	33
Move Components .....	34
Delete Components .....	35
Save Changes .....	36
Typical Project Roles .....	37
Summary of Typical Tasks .....	37
Business Analysts .....	38
Software Architects .....	40
Software Engineers .....	41
Developers .....	42
Project Managers .....	43
Testers .....	43
Implementation Managers .....	45
Technology Developers .....	46
Database Developers .....	47
User Interface Guide .....	48
Introduction .....	48
Start Page .....	50
Tasks Pane .....	51
Main Menu .....	54

File .....	56
Remove Recent Projects.....	56
Edit .....	57
Paste Elements Submenu.....	58
View.....	58
View Submenus.....	59
Project.....	60
Documentation Submenu .....	61
Source Code Engineering Submenu.....	62
Execution Analyzer Submenu.....	62
Database Engineering Submenu.....	63
Transformations Submenu.....	63
Model Validation Submenu.....	64
Web Services Submenu.....	64
XML Schema Submenu.....	64
Security Submenu.....	64
Version Control Submenu.....	65
Import/Export Submenu.....	65
Diagram.....	65
Element.....	67
Inline Features Submenu.....	68
Advanced Submenu.....	68
Source Code Engineering Submenu.....	69
Appearance Submenu.....	69
Position Submenus.....	70
Tools .....	70
Data Management Submenu.....	71
Manage .EAP File Submenu.....	71
Addins.....	72
Settings.....	73
Window.....	74
Help .....	74
<b>Standard Windows .....</b>	<b>75</b>
Dock Windows.....	76
Autohide Windows.....	78
<b>Standard Toolbars .....</b>	<b>79</b>
Default Tools Toolbar.....	80
Project Toolbar.....	81
Code Generation Toolbar.....	81
UML Elements Toolbar.....	83
Diagram Toolbar.....	83
Current Element Toolbar.....	84
Current Connector Toolbar.....	84
Format Toolbar.....	85
Workspace Layouts.....	86
Status Bar.....	89
<b>Customization .....</b>	<b>90</b>
The Customize Dialog.....	90
Customize Commands.....	91
Customize Toolbars.....	92
Custom Tools.....	94
Open External Tools.....	96
Pass Parameters to Applications.....	97
Customize Keyboard.....	98
Customize Menu.....	100
Customize Options.....	101
Visual Styles.....	101
<b>Other Windows .....</b>	<b>102</b>

The Output Window.....	102
The Web Browser.....	103
<b>Keyboard Shortcuts .....</b>	<b>104</b>
Keyboard-Mouse Shortcuts.....	109

## **Part III Projects and Teams 111**

<b>Introduction .....</b>	<b>112</b>
<b>What is a Project? .....</b>	<b>113</b>
<b>Open a Project .....</b>	<b>114</b>
<b>Model Shortcuts .....</b>	<b>115</b>
Create Copy Or Shortcut.....	116
Capture Current Work Environment.....	117
Encrypt Repository Password.....	119
<b>File Based Repositories .....</b>	<b>120</b>
Copy a Base Project .....	121
<b>Server Based Repositories .....</b>	<b>122</b>
<b>Create a Repository .....</b>	<b>123</b>
Access 2007.....	123
MySQL Repository.....	123
SQL Server Repository.....	126
Oracle Server Repository.....	129
PostgreSQL Repository .....	129
Adaptive Server Anywhere Repository.....	132
MSDE Server Repository.....	134
Progress OpenEdge Repository.....	134
<b>Set Up an ODBC Driver for a Connection to a Repository .....</b>	<b>135</b>
MySQL ODBC Driver.....	135
PostgreSQL ODBC Driver.....	138
ASA ODBC Driver.....	141
Progress OpenEdge ODBC Driver.....	145
<b>Connect to a Data Repository .....</b>	<b>147</b>
MySQL Data Repository.....	148
SQL Server Data Repository.....	150
Oracle Data Repository.....	153
PostgreSQL Data Repository.....	160
ASA Data Repository .....	162
MSDE Server Data Repository.....	165
Progress OpenEdge Repository.....	165
<b>Upsize to Access 2007 .....</b>	<b>169</b>
<b>Upsize to Sybase ASA .....</b>	<b>170</b>
<b>Upsize to Progress OpenEdge .....</b>	<b>171</b>
<b>Upsize to MSDE .....</b>	<b>173</b>
<b>Upsize to PostgreSQL .....</b>	<b>173</b>
<b>Upsize to Oracle 9i, 10g or 11g .....</b>	<b>175</b>
<b>Upsize to SQL Server .....</b>	<b>176</b>
<b>Upsize to MySQL .....</b>	<b>178</b>
<b>The WAN Optimizer .....</b>	<b>180</b>
<b>Team Development .....</b>	<b>182</b>
<b>Project Sharing .....</b>	<b>182</b>
Share Enterprise Architect Projects.....	183
Share Projects on Network Drive.....	183
Distributed Development.....	183
Replication .....	184
Design Masters.....	185
Create Replicas.....	185
Synchronize Replicas.....	186
Remove Replication.....	186

Upgrade Replicas.....	186
Resolve Conflicts.....	187
<b>Configure User Security .....</b>	<b>188</b>
Enable Security.....	189
Security Policy.....	190
Maintain Users.....	191
Import User IDs From Active Directory.....	192
Assign User To Groups.....	194
Set Up Single Permissions.....	195
View All User Permissions.....	196
Maintain Groups.....	197
Set Group Permissions.....	197
List of Available Permissions.....	198
View and Manage Locks.....	200
Password Encryption.....	200
Change Password.....	202
Lock Model Elements.....	204
Add Connectors To Locked Elements.....	204
Lock Packages.....	205
Apply a User Lock.....	205
Locked Element Indicators.....	206
Identify Who Has Locked An Object.....	207
Manage Your Own Locks.....	207
<b>Team Review Tools .....</b>	<b>208</b>
Context Menu.....	209
Add a New Category.....	211
Add a New Topic.....	212
Add a New Post.....	213
Reply to a Post.....	214
Edit an Item.....	215
Team Review Editor.....	215
Add Object Links.....	216
Team Review Resources.....	217
Search Team Review.....	217
Copy Path to Clipboard.....	218
Team Review Options.....	218
Team Review Connections.....	218
<b>Workflow Scripts .....</b>	<b>220</b>
Workflow Script Functions.....	220
<b>Sharing Reference Data .....</b>	<b>223</b>
Export Reference Data.....	223
Import Reference Data.....	225
<b>Change Management .....</b>	<b>228</b>
<b>Version Control .....</b>	<b>228</b>
Introduction.....	229
System Requirements and Configuration.....	229
Version Control Usage.....	230
Version Control Basics.....	230
Version Control and Reference Data.....	231
Apply Version Control To Models.....	231
Version Control & Team Deployment.....	232
Project Browser Indicators.....	233
Version Control Setup.....	233
Version Control Settings Dialog.....	234
Version Control Nested Packages.....	236
Version Control with SCC.....	236
Upgrade at Enterprise Architect 4.5.....	239
Version Control with CVS.....	240

CVS with Remote Repositories.....	240
CVS with Local Repositories.....	244
Version Control with Subversion.....	247
Set up Subversion.....	247
Create a new Repository Sub-tree.....	248
Create a Local Working Copy.....	249
Subversion Under WINE-Crossover.....	249
Version Control Configuration.....	250
TortoiseSVN.....	252
Version Control with TFS.....	253
Connect an Enterprise Architect Model to Version Control using TFS .....	253
Use Version Control.....	256
Project Version Control Menu.....	256
Package Version Control Menu.....	257
Configure Controlled Package.....	259
Use Existing Configuration.....	260
Validate Package Configurations.....	260
Check In and Check Out Packages.....	261
Include Other Users' Packages.....	263
Apply Version Control To Branches.....	264
Export Controlled Model Branch.....	264
Import Controlled Model Branch.....	265
Review Package History.....	266
Refresh View of Shared Project.....	267
Resynchronize the Status of Version Controlled Packages.....	267
Offline Version Control.....	268
<b>Tracking Changes .....</b>	<b>269</b>
Auditing.....	270
Auditing Quickstart.....	271
Auditing Settings.....	271
Audit Scope.....	272
Audit Logs.....	272
Auditing Level.....	273
Audit Options.....	273
The Audit View.....	274
Audit View Controls.....	276
Audit History Tab.....	278
Auditing Performance Issues.....	279
Audit View Performance Issues.....	279
Package Baselines.....	279
Baselines .....	280
Manage Baselines.....	281
Create Baselines.....	282
The Compare Utility (Diff).....	283
Compare Options.....	284
Example Comparison.....	284
Compare Utility Tab Options.....	285
<b>Model Transfer .....</b>	<b>287</b>
XMI Import and Export.....	288
Export to XMI.....	289
Import from XMI.....	290
Import EMX/UML2 Files.....	291
Limitations of XMI.....	293
The UML DTD.....	293
Controlled Packages.....	293
Controlled Package Menu.....	294
Configure Packages.....	295
Remove Package from Control.....	296



Save a Package.....	297
Load a Package.....	297
Batch XMI Export.....	298
Batch XMI Import.....	298
Manual Version Control with XMI.....	299
CSV Import and Export.....	300
CSV Specifications.....	300
CSV Export.....	303
CSV Import.....	305
Project Data Transfer.....	306
Perform a Project Data Transfer.....	307
Why Compare Projects?.....	308
Compare Projects.....	308
Copy Packages Between Projects.....	309
<b>Project Management .....</b>	<b>312</b>
<b>The Project Management Window .....</b>	<b>312</b>
<b>Project Resources .....</b>	<b>313</b>
Resource Allocation.....	314
Effort Management.....	315
Risk Management.....	316
Metrics.....	317
Resource Report.....	318
Effort Types.....	319
Metric Types.....	320
Risk Types.....	322
<b>The System Window .....</b>	<b>323</b>
<b>Project Glossary .....</b>	<b>323</b>
The Glossary Dialog.....	324
Project Glossary Tab.....	325
Generate a Report.....	328
Glossary Report Output Sample.....	328
<b>Project Tasks .....</b>	<b>329</b>
Add, Modify and Delete Tasks.....	330
<b>Project Issues .....</b>	<b>331</b>
Project Issues Dialog.....	331
Project Issues Tab.....	332
Add, Delete and Modify Issues.....	334
Report From Project Issues Dialog.....	334
Report From Project Issues Tab.....	334
Report Output Sample.....	335
<b>Use Case Estimation .....</b>	<b>335</b>
Technical Complexity Factors.....	336
Environment Complexity Factors.....	337
Estimating Project Size.....	338
Default Hours.....	340
<b>Update Package Status .....</b>	<b>340</b>
<b>Manage Bookmarks .....</b>	<b>341</b>
<b>Monitor Events .....</b>	<b>342</b>
<b>Maintenance .....</b>	<b>344</b>
<b>Project Data Integrity .....</b>	<b>344</b>
Check Project Data Integrity.....	344
Run SQL Patches.....	346
<b>Project Upgrade .....</b>	<b>346</b>
The Upgrade Wizard.....	347
Upgrade Replicas.....	347
<b>Rename a Project .....</b>	<b>348</b>
<b>Compact a Project .....</b>	<b>348</b>
<b>Repair a Project .....</b>	<b>348</b>

<b>Local Options .....</b>	<b>350</b>
<b>General .....</b>	<b>351</b>
<b>Standard Colors .....</b>	<b>353</b>
<b>Diagram .....</b>	<b>355</b>
Appearance.....	356
Set Default Fonts.....	357
Behavior.....	359
Sequence.....	360
<b>Objects .....</b>	<b>362</b>
Element Visibility.....	363
<b>Links .....</b>	<b>364</b>
<b>Communication Message Colors .....</b>	<b>366</b>
<b>XML Specifications .....</b>	<b>367</b>
<b>Part IV Modeling Fundamentals .....</b>	<b>370</b>
<b>Modeling .....</b>	<b>371</b>
<b>Models .....</b>	<b>372</b>
<b>Model Wizard .....</b>	<b>372</b>
<b>Model Templates .....</b>	<b>373</b>
Business Process Model Template.....	374
Requirements Model Template.....	374
Use Case Model Template.....	375
Domain Model Template.....	376
Class Model Template.....	376
Database Model Template.....	377
Component Model Template.....	378
Deployment Model Template.....	378
Testing Model Template.....	380
Maintenance Model Template.....	381
Project Model Template.....	381
<b>Views .....</b>	<b>383</b>
Add Views .....	383
Rename Views .....	384
Delete Views .....	385
<b>Packages .....</b>	<b>387</b>
Open Package in the Project Browser .....	387
Add a Package .....	387
Rename a Package .....	388
Copy a Package .....	388
Drag a Package Onto a Diagram .....	389
Show or Hide Package Contents .....	389
Delete a Package .....	390
<b>Diagrams .....</b>	<b>391</b>
<b>Diagram Context Menu .....</b>	<b>394</b>
Insert Elements and Connectors.....	395
<b>Print Preview .....</b>	<b>395</b>
<b>Diagram View .....</b>	<b>396</b>
<b>Diagram Tabs .....</b>	<b>397</b>
<b>Diagram Toolbox .....</b>	<b>399</b>
Toolbox Appearance Options.....	401
Toolbox Shortcut Menu.....	403
Common Group.....	405
Use Case Group.....	406
Class Group.....	407
Object Group.....	408
Composite Group.....	409

Communication Group.....	409
Interaction Group.....	410
Timing Group.....	410
State Group.....	411
Activity Group.....	412
Component Group.....	412
Deployment Group.....	413
Profile Group.....	414
Metamodel Group.....	415
Analysis Group.....	416
Custom Group.....	417
Requirement Group.....	418
Maintenance Group.....	418
User Interface Group.....	419
WSDL Group.....	420
XML Schema Group.....	420
Data Modeling Group.....	421
<b>Diagram Tasks .....</b>	<b>421</b>
Add New Diagrams.....	422
Diagram Properties.....	423
General Tab.....	424
Diagram Tab.....	425
Elements Tab.....	426
Features Tab.....	427
Connectors Tab.....	428
Visible Class Members.....	429
Paste from Project Browser.....	430
Paste Multiple Items.....	431
Paste Composite Elements.....	431
Paste Activities.....	432
Copy And Paste Diagram Element.....	433
Place Related Elements on Diagram.....	433
Delete Diagram.....	434
Rename Diagram.....	434
Change Diagram Type.....	434
Diagram Navigation Hotkeys.....	435
Copy Image to Disk.....	435
Copy Image to Clipboard.....	436
Copy (Duplicate) Diagram.....	436
Z Order Elements.....	437
Set the Default Diagram.....	437
Open Package From Diagram.....	438
Feature Visibility.....	438
Insert Diagram Properties Note.....	440
Create Legends.....	441
Autosize Elements.....	444
Swimlanes Matrix.....	444
Using the Image Manager.....	447
Create Custom Diagram Background.....	448
Import Image Library.....	449
Swimlanes.....	450
Show Realized Interfaces of Class.....	452
Label Menu Section.....	452
Pan and Zoom a Diagram.....	453
Move Elements In Diagram Sections.....	454
View Last and Next Diagram.....	455
Set Diagram Page Size.....	455
Scale Image to Page Size.....	456

Lock Diagram.....	457
Undo Last Action.....	458
Redo Last Action.....	458
<b>Layout Diagrams .....</b>	<b>458</b>
Circular/Elliptical Layout.....	459
Box Layout.....	463
Per Page Layout.....	464
Digraph Layout.....	465
Spring Layout.....	466
Neaten Layout.....	467
Converge/Diverge Layout.....	467
Fan Relations Layout.....	469
Auto Route Layout.....	470
Lay Out a Diagram Automatically.....	471
<b>The Quick Linker .....</b>	<b>474</b>
Create New Elements.....	475
Create Connectors.....	476
<b>Elements .....</b>	<b>478</b>
<b>Element Property Displays .....</b>	<b>480</b>
Properties Dialog.....	481
General Settings.....	482
Advanced Settings.....	483
Details .....	484
Requirements.....	485
External Requirements.....	487
Constraints.....	488
Links .....	489
Scenarios.....	490
Structured Specification Tab.....	493
Set Up Scenario Specification.....	494
Structured Specification Toolbar.....	495
Structured Specification Item Context Menu.....	496
Structured Specification Selected Text Context Menu.....	497
Structured Specification Entry Points Context Menu.....	498
Structured Specification Floating Toolbar.....	499
Generate Diagrams.....	499
Generated Activity Diagram.....	500
Generated RuleFlow Diagram.....	501
Generated State Machine Diagram.....	501
Generated Sequence Diagram.....	503
Generated Robustness Diagram.....	504
Generate Test Cases.....	505
Context References Tab.....	506
Scenario Constraints Tab.....	507
Associated Files.....	507
Tagged Values Tab.....	508
Properties Docked Window.....	508
The Element Browser.....	510
Generate Scenario From Activity Diagram.....	513
The Scenarios & Requirements Window .....	514
Select <Item> Dialog.....	515
Select Property Dialog.....	517
<b>Object Classifiers .....</b>	<b>519</b>
Using Classifiers.....	520
<b>Visual Representation .....</b>	<b>520</b>
Element Icons.....	521
Compartments.....	521
<b>Element Tasks .....</b>	<b>522</b>

Create Elements .....	523
Add Elements Directly To Packages.....	524
Use Auto Naming and Auto Counters.....	525
Set Element Parent.....	526
Show Element Use.....	526
Set Up Cross References .....	527
Move Elements Within Diagrams.....	529
Move Elements Between Packages.....	530
Copy Elements Between Packages.....	531
Change Element Type .....	532
Align Elements.....	532
Resize Elements.....	533
Delete Elements.....	534
Customize Visibility of Elements.....	535
Create Notes and Text.....	536
Link Note to Internal Documentation.....	537
Set an Element's Default Appearance.....	538
Get/Set Project Custom Colors.....	540
Set Element Templates Package.....	542
Highlight Context Element.....	543
Make Linked Element a Local Copy.....	544
Copy Features Between Elements.....	544
Move Features Between Elements .....	545
<b>Element Context Menu .....</b>	<b>547</b>
Properties Menu Section.....	548
Advanced Submenu.....	549
Custom Properties Dialog.....	550
Add Submenu .....	550
Insert Related Elements.....	551
Find Submenu.....	552
Embedded Elements Submenu .....	552
Embedded Elements Window.....	553
Features Menu Section.....	554
Code Engineering Menu Section .....	554
Appearance Menu Section.....	555
Set Element Font.....	556
Element Multiple Selection Menu.....	557
<b>Attributes .....</b>	<b>558</b>
Attributes Dialog - General Tab.....	560
Attributes Dialog - Detail .....	562
Attributes Dialog - Constraints .....	563
Attribute Tagged Values.....	564
Create Properties.....	565
Display Inherited Attributes.....	567
Create Object From Attribute.....	568
<b>Behavior .....</b>	<b>569</b>
Operations.....	569
Operations Dialog - General.....	570
Operations Dialog - Behavior.....	573
Initial Code.....	576
Operations Dialog - Constraints.....	577
Operation Tagged Values.....	577
Override Parent Operations.....	578
Display Inherited Operations.....	579
Interactions and Activities .....	581
Behavior Calls.....	581
Associate with Different Behaviors .....	582
Synchronize Arguments.....	582

Behavior Call Arguments.....	582
Behavior Parameters.....	583
Parameters Dialog.....	583
Parameter Tagged Values.....	585
Operation Parameters by Reference.....	586
<b>In-place Editing Options .....</b>	<b>586</b>
In-place Editing Tasks.....	586
Edit Element Item Name.....	588
Edit Feature Stereotype.....	588
Edit Feature Scope.....	589
Edit Attribute Keyword.....	590
Edit Operation Parameter Keyword.....	591
Edit Parameter Kind.....	592
Insert New Feature.....	592
Insert Operation Parameter.....	593
Insert Maintenance Feature.....	594
Insert Testing Features.....	595
<b>Linked Documents .....</b>	<b>597</b>
Create Document Artifact.....	599
Link Document to UML Element.....	599
Edit Linked Documents.....	600
Hyperlink From Linked Document.....	601
Create Element From Document.....	602
Replace or Delete Documents.....	602
Create Linked Document Templates.....	603
Edit Linked Document Templates.....	604
<b>Connectors .....</b>	<b>606</b>
<b>Connector Context Menu .....</b>	<b>606</b>
Properties Menu Section.....	607
Type-Specific Menu Section.....	607
Advanced Menu Section.....	608
Style Menu Section.....	608
Appearance Menu Section.....	609
<b>Connector Tasks .....</b>	<b>609</b>
Connect Elements.....	610
Connect to Element Feature.....	611
Add a Note to a Connector.....	612
Arrange Connectors.....	613
Change Connector Type.....	614
Change the Source or Target Element.....	614
Connector Styles.....	615
Create Connector in Project Browser.....	618
Relationship Visibility.....	619
Delete Connectors.....	619
Generalization Sets.....	620
Hide/Show Connectors.....	621
Hide/Show Labels.....	622
Connector In-place Editing Options.....	623
Reverse Connector.....	623
Set Association Specializations.....	623
Change Sequence Message Scope.....	624
Show Uses Arrow Head.....	625
Tree Style Hierarchy.....	625
<b>Connector Properties .....</b>	<b>626</b>
Connector Constraints.....	628
Source Role.....	629
Target Role.....	631
Connector Tagged Values.....	631

<b>Tagged Values .....</b>	<b>632</b>
Quick Add - Tagged Value To Elements .....	634
Assign a Tagged Value to an Item .....	635
Assign Notes to a Tagged Value .....	636
Show Duplicate Tags .....	637
Advanced Tag Management .....	638
<b>Notes .....</b>	<b>641</b>
Notes Toolbar .....	642
<b>Reference Data .....</b>	<b>644</b>
<b>People .....</b>	<b>645</b>
Project Authors.....	645
Project Roles.....	648
Project Resources.....	650
Project Clients.....	651
<b>General Types .....</b>	<b>653</b>
Status Types.....	653
Constraint Types.....	655
Constraint Status Types.....	656
Requirement Types.....	657
Scenario Types.....	658
Metrics and Estimation.....	659
<b>Maintenance .....</b>	<b>660</b>
Problem Types.....	660
Testing Types.....	661
<b>UML Types .....</b>	<b>662</b>
Stereotype Settings.....	662
Shape Editor.....	664
Tagged Value Types.....	664
Cardinality.....	665
Data Types.....	666
<b>Resources .....</b>	<b>667</b>
Favorites.....	669

## **Part V Modeling Languages 671**

<b>Standard UML Models .....</b>	<b>672</b>
<b>UML Diagrams .....</b>	<b>673</b>
Behavioral Diagrams.....	673
Activity Diagram.....	674
Use Case Diagram.....	676
State Machine Diagrams.....	678
Regions .....	681
Pseudo-States.....	682
State Machine Table.....	682
State Machine Table Options.....	684
State Machine Table Operations.....	686
Change State Machine Table Position.....	687
Change State Machine Table Size.....	687
Insert New State.....	687
Insert Trigger.....	688
Insert/Change Transition.....	688
Reposition State or Trigger Cells.....	689
Add Legend.....	689
Find Cell in State Machine Diagram.....	689
State Machine Table Conventions.....	689
Export State Table To CSV File.....	690
Timing Diagram.....	690
Create a Timing Diagram.....	692

Set a Time Range.....	692
Edit a Timing Diagram.....	692
Add and Edit State Lifeline.....	693
Edit States In State Lifeline.....	693
Edit Transitions In State Lifeline.....	694
Add and Edit Value Lifeline.....	696
Add States In Value Lifeline.....	696
Edit Transitions In Value Lifeline.....	696
Configure Timeline - States.....	697
Configure Timeline - Transitions.....	699
Time Intervals.....	700
Time Interval Operations.....	703
Sequence Diagram.....	706
Denote Lifecycle of an Element.....	708
Layout of Sequence Diagrams.....	709
Sequence Elements.....	710
Sequence Diagrams and Version Control.....	710
Sequence Element Activation.....	711
Lifeline Activation Levels.....	712
Sequence Message Label Visibility.....	714
Change the Top Margin.....	714
Inline Sequence Elements.....	714
Communication Diagram.....	715
Communication Diagrams in Color.....	716
Interaction Overview Diagram.....	717
Structural Diagrams.....	719
Package Diagram.....	720
Class Diagram.....	721
Object Diagram.....	723
Composite Structure Diagram.....	724
Properties.....	726
Deployment Diagram.....	727
Component Diagram.....	730
Profile Diagram.....	732
Extended Diagrams.....	733
Analysis Diagram.....	733
Custom Diagram.....	734
Requirements Diagram.....	736
Maintenance Diagram.....	737
User Interface Diagram.....	738
Database Schema.....	739
Business Modeling/Interaction.....	739
<b>UML Elements .....</b>	<b>741</b>
Behavioral Diagram Elements.....	742
Action .....	743
Action Notation.....	745
Set Feature Dialog.....	748
Action Expansion Node.....	749
Action Pin.....	749
Assign Action Pins.....	751
Local Pre/Post Conditions.....	752
Activity .....	753
Activity Notation.....	754
Activity Parameter Nodes.....	755
Activity Partition.....	756
Actor .....	757
Central Buffer Node.....	758
Choice .....	758



Combined Fragment.....	759
Create a Combined Fragment.....	761
Interaction Operators.....	762
Datastore.....	764
Decision.....	765
Diagram Frame.....	766
Diagram Gate.....	767
Endpoint.....	768
Entry Point.....	769
Exception.....	769
Expansion Region.....	769
Add Expansion Region.....	771
Exit Point.....	771
Final.....	772
Flow Final.....	772
Fork/Join.....	773
Fork.....	775
Join.....	776
History.....	777
Initial.....	778
Interaction.....	779
Interaction Occurrence.....	780
Interruptible Activity Region.....	781
Add Interruptible Activity Region.....	782
Junction.....	782
Lifeline.....	783
Merge.....	784
Message Endpoint.....	784
Message Label.....	785
Note.....	785
Partition.....	786
Receive.....	787
Region.....	788
Send.....	789
State.....	789
Composite State.....	790
State/Continuation.....	792
Continuation.....	792
State Invariant.....	793
State Lifeline.....	794
State Machine.....	796
Structured Activity.....	796
Structured and Sequential Nodes.....	798
Loop and Conditional Nodes.....	798
Synch.....	802
System Boundary.....	802
Boundary Element Settings.....	803
Terminate.....	804
Trigger.....	804
Use Case.....	806
Use Case Extension Points.....	807
Rectangle Notation.....	808
Value Lifeline.....	808
Structural Diagram Elements.....	809
Artifact.....	810
Class.....	811
Active Classes.....	812
Parameterized Classes (Templates).....	813

Collaboration.....	814
Collaboration Occurrence.....	815
Component.....	816
Data Type.....	817
Deployment Spec.....	818
Device .....	818
Document Artifact.....	819
Enumeration.....	819
Execution Environment.....	820
Expose Interface.....	820
Information Item.....	821
Interface .....	821
Node .....	822
Object .....	823
Run-time State.....	823
Define a Run-time Variable.....	824
Remove a Defined Variable.....	824
Object State.....	824
Package .....	825
Part .....	825
Add Property Value.....	826
Port .....	826
Add a Port to an Element.....	827
Inherited and Redefined Ports.....	827
The Property Tab.....	829
Primitive .....	829
Qualifiers .....	830
Qualifiers Dialog.....	832
Signal .....	834
Inbuilt and Extension Stereotypes.....	835
Analysis Stereotypes.....	835
Boundary .....	836
Create a Boundary.....	836
Composite Elements.....	837
Control .....	838
Create a Control Element.....	838
Entity .....	839
Create an Entity.....	839
Event .....	839
Feature .....	840
Hyperlinks.....	840
Hyperlinks To Files.....	842
Script Hyperlinks.....	842
Add Action As Hyperlink.....	842
Hyperlinks Between Diagrams.....	842
N-Ary Association.....	844
Packaging Component.....	845
Process .....	846
Requirements.....	846
Screen .....	847
Test Case.....	848
Table .....	849
UI Control Element.....	849
Web Stereotypes.....	851
<b>UML Connectors .....</b>	<b>852</b>
Aggregate.....	854
Change Aggregation Connector Form.....	855
Assembly.....	855

Associate.....	855
Association Class.....	856
Connect New Class to Association.....	857
Communication Path.....	858
Compose.....	858
Connector.....	859
Control Flow.....	860
Delegate.....	861
Dependency.....	861
Apply a Stereotype.....	862
Deployment.....	862
Extend.....	862
Generalize.....	863
Include.....	864
Information Flow.....	864
Convey Information on a Flow.....	865
Realize an Information Flow.....	866
Interrupt Flow.....	867
Manifest.....	867
Message.....	867
Message (Sequence Diagram).....	868
Self-Message.....	871
Call.....	872
Message Examples.....	873
Change the Timing Details.....	874
General Ordering.....	876
Asynchronous Signal Message.....	877
Message (Communication Diagram).....	879
Create a Communication Message.....	880
Re-Order Messages.....	880
Message (Timing Diagram).....	882
Create a Timing Message.....	883
Nesting.....	885
Notelink.....	886
Object Flow.....	886
Object Flows in Activity Diagrams.....	886
Occurrence.....	888
Package Import.....	888
Package Merge.....	888
Realize.....	889
Recursion.....	890
Role Binding.....	890
Represents.....	891
Representation.....	891
Trace.....	892
Transition.....	892
Use.....	894
<b>UML Stereotypes .....</b>	<b>895</b>
Apply Stereotypes.....	896
Stereotype Selector.....	897
Stereotype Visibility.....	898
Standard Stereotypes.....	899
Stereotypes with Alternative Images.....	900
<b>UML Patterns .....</b>	<b>901</b>
Create a Pattern.....	902
Import a Pattern.....	904
Use a Pattern.....	904
<b>UML Profiles .....</b>	<b>906</b>

Use Profiles.....	907
Import a UML Profile.....	908
Add Profile Objects and Features to a Diagram .....	909
Tagged Values in Profiles.....	910
Synchronize Tagged Values and Constraints.....	910
Profile References.....	912
Supported Types.....	912
Profile Structure.....	913
Attributes Supported in XML Profile.....	914
Example Profile.....	915
<b>Specialized UML Models .....</b>	<b>917</b>
<b>Requirements .....</b>	<b>917</b>
Create Requirements.....	918
Requirement Properties.....	919
Color Code External Requirements.....	920
Extend Requirement Properties.....	920
Display Tagged Values On Diagrams.....	921
Connect Requirements.....	921
Import Requirements and Hierarchies in CSV.....	922
Model Requirements.....	922
Internal Requirements.....	925
Make Internal Requirement External.....	926
Manage Requirements.....	927
View Requirements.....	928
Trace Use of Requirements.....	928
Manage Requirement Changes.....	928
Report on Requirements.....	929
<b>Business Models .....</b>	<b>930</b>
Analysis Models.....	931
Process Modeling Notation.....	931
Inputs, Resources and Information.....	931
Events .....	932
Outputs .....	932
Goals .....	933
A Complete Business Process.....	933
<b>Business Rules .....</b>	<b>934</b>
Model Business Rules For RuleTasks.....	937
Create a Business Domain Model.....	938
Create a Rule Flow Model.....	939
Pass Parameters to Rule Flow Activity.....	942
Model Rules In an Operation .....	943
Compose Business Rules.....	945
Validate Business Rules.....	950
Code Generation For Business Rules.....	951
<b>BPMN Models .....</b>	<b>952</b>
Change BPMN Element Appearance.....	956
Migrate BPMN 1.0 Model to BPMN 1.1.....	957
<b>BPEL Models .....</b>	<b>958</b>
Create a BPEL Model.....	959
Model a BPEL Process.....	961
Model Start Event.....	962
Model End Event.....	965
Model Intermediate Event.....	968
Model Gateway.....	972
Model Activity.....	974
Model Pool.....	979
Model a Sequence Flow Connector.....	980
Create Assignments.....	981

Generate BPEL.....	983
Create a BPEL Web Service.....	983
BPEL Model Validation.....	984
<b>Systems Engineering .....</b>	<b>986</b>
SysML.....	989
SysML Model Elements.....	991
SysML Block Definition.....	992
SysML Internal Block.....	994
SysML Parametrics.....	995
SysML Activity.....	996
SysML Interaction.....	998
SysML State Machine.....	999
SysML Use Case.....	1000
SysML Requirements.....	1001
SysML Parametric Models.....	1002
Simulate a SysML Model.....	1005
Create a Requirements Model.....	1007
Create an Operational Domain Model.....	1007
Compose System Design.....	1009
Create Reusable Subsystems.....	1011
<b>Data Models .....</b>	<b>1011</b>
A Data Model Diagram.....	1013
Create a Table.....	1013
Working with Tables.....	1014
Set Table Owner.....	1016
Set MySQL Options.....	1016
Set Oracle Table Properties.....	1017
Create Columns.....	1019
Create Oracle Packages.....	1022
Primary Key.....	1022
SQL Server Non Clustered Keys.....	1024
Foreign Key.....	1024
Create Foreign Key.....	1025
Define Foreign Key Name Template.....	1028
Stored Procedures.....	1030
Create Individual Class Procedure.....	1030
Advanced Topics.....	1031
Views.....	1032
Index, Trigger, Check Constraint.....	1033
Data Type Conversion Procedure.....	1035
Data Type Conversion for a Package.....	1036
DBMS Datatypes.....	1037
<b>XML Schema - XSD .....</b>	<b>1039</b>
XML Technologies.....	1039
Model XSD.....	1040
UML Profile for XSD.....	1041
XSD Datatypes Package.....	1047
Abstract XSD models.....	1047
Default UML to XSD Mappings.....	1049
<b>Web Services - WSDL .....</b>	<b>1049</b>
Model WSDL.....	1050
WSDL Namespace.....	1051
WSDL Document.....	1053
WSDL Service.....	1054
WSDL Port Type.....	1056
WSDL Message.....	1056
WSDL Binding.....	1057
WSDL Port Type Operation.....	1059

WSDL Message Part.....	1060
<b>SPEM .....</b>	<b>1061</b>
SPEM Toolbox Pages.....	1062
<b>MDG Technologies - Using .....</b>	<b>1066</b>
Work with MDG Technologies.....	1067
Manage MDG Technologies.....	1069
Access Remote MDG Technologies.....	1070
Import MDG Technologies.....	1071
Extensions - MDG Technologies.....	1073
Archimate.....	1073
Data Flow Diagrams.....	1076
Entity Relationship Diagrams (ERDs).....	1077
Eriksson-Penker Extensions.....	1080
GoF Patterns.....	1083
ICONIX.....	1084
Mind Mapping.....	1087
SoaML.....	1089
<b>Build Your Own Modeling Language .....</b>	<b>1092</b>
<b>MDG Technology SDK .....</b>	<b>1092</b>
Developing Profiles.....	1093
Custom Stereotypes.....	1093
Create Profiles.....	1095
Create a Profile Package.....	1095
Add Stereotypes and Metaclasses.....	1096
Define Stereotype Tagged Values .....	1098
With Predefined Tag Types.....	1099
With Supported Attributes.....	1100
Use the Tagged Value Connector.....	1101
Define Stereotype Constraints.....	1101
Add Enumeration Elements .....	1103
Add Shape Scripts .....	1104
Set Default Appearance.....	1106
Export a Profile.....	1106
Save Profile Options.....	1107
Supported Attributes .....	1108
Define a Stereotype as a Metatype.....	1109
Define Multiple-Stereotype Level .....	1110
Define Creation of Instance.....	1110
Create Composite Elements.....	1111
Define Child Diagram Types.....	1111
Stereotype Profiles.....	1113
Quick Linker.....	1113
Quick Linker Definition Format.....	1113
Quick Linker Example.....	1115
Hide Default Quick Linker Settings .....	1117
Quick Linker Object Names .....	1117
MDG Technologies - Creating.....	1118
Create MDG Technologies.....	1118
Add a Profile.....	1122
Add a Pattern .....	1123
Add a Diagram Profile.....	1124
Add a Toolbox Profile.....	1125
Add Task Panel Pages.....	1126
Add Tagged Value Types.....	1127
Add Code Modules.....	1128
Add MDA Transforms.....	1130
Add Images.....	1130
Add Scripts.....	1131

Add RTF Report Templates.....	1132
Add Linked Document Templates.....	1133
Working with MTS Files.....	1133
Customize Toolbox Profiles.....	1134
Create Toolbox Profiles.....	1134
Toolbox Page Attributes.....	1135
Create Hidden Sub-Menus.....	1135
Override Default Toolboxes.....	1136
Assign Icons To Toolbox Items.....	1136
List of Enterprise Architect Toolboxes.....	1137
Elements Used in Toolboxes.....	1137
Connectors Used In Toolboxes.....	1138
Create Diagram Profiles.....	1139
Built-In Diagram Types.....	1140
Attribute Values - stylex & pdata.....	1140
Create Tasks Pane Profiles.....	1141
Define Tasks Pane Toolboxes.....	1141
Built-In Tasks Pane Commands.....	1142
Run Add-In Functions.....	1143
Define Tasks Pane Contexts.....	1144
Allocate Tasks Pane Contexts.....	1144
Save a Tasks Pane Profile.....	1145
Define Validation Configuration.....	1145
Incorporate Model Templates.....	1146
Deploy An MDG Technology.....	1146
Shape Scripts.....	1147
Getting Started With Shape Scripts.....	1148
Shape Editor.....	1150
Write Scripts.....	1151
Syntax Grammar.....	1151
Shape Attributes.....	1152
Drawing Methods.....	1154
Color Queries.....	1158
Conditional Branching.....	1158
Query Methods.....	1158
Display Element/Connector Properties.....	1158
Sub-Shapes.....	1160
Reserved Names.....	1161
Miscellaneous.....	1162
Example Scripts.....	1163
Tagged Value Types.....	1166
Predefined Structured Types.....	1166
Create Structured Tagged Values.....	1168
Predefined Reference Data Types.....	1169
Create Reference Data Tagged Values.....	1170
Create Custom Tagged Value Type.....	1171
Code Template Framework.....	1172
Code Template Syntax.....	1172
Literal Text.....	1172
Macros.....	1173
Template Substitution Macros.....	1173
Field Substitution Macros.....	1174
Tagged Value Substitution Macros.....	1186
Function Macros.....	1187
Control Macros.....	1190
EASL Code Generation Macros.....	1193
EASL Collections.....	1194
EASL Properties.....	1196

Variables .....	1200
The Code Template Editor in MDG Development .....	1202
Custom Templates .....	1202
Override Default Templates .....	1204
Add New Stereotyped Templates .....	1205
Create Custom Language Template .....	1206

## Part VI Navigate, Search and Trace 1208

<b>The Project Browser .....</b>	<b>1209</b>
<b>Order Package Contents .....</b>	<b>1210</b>
<b>Set Default Behavior .....</b>	<b>1210</b>
<b>Project Browser Toolbar .....</b>	<b>1212</b>
<b>Project Browser Icon Overlays .....</b>	<b>1213</b>
<b>Project Browser Context Menus .....</b>	<b>1213</b>
Model (Root Node) Context Menu .....	1213
Package Menu .....	1214
Add Sub-Menu .....	1216
Documentation Sub-Menu .....	1216
Code Engineering Sub-Menu .....	1217
Execution Analyzer Sub-Menu .....	1217
Import/Export Sub-Menu .....	1218
Contents Sub-Menu .....	1218
Element Menu - Project Browser .....	1218
Add Sub Menu .....	1219
Diagram Menu - Project Browser .....	1220
Operation Menu - Project Browser .....	1221
<b>Model Views .....</b>	<b>1222</b>
<b>Model Views Toolbar .....</b>	<b>1223</b>
<b>Model Views Context Menus .....</b>	<b>1224</b>
<b>Model Views Operations .....</b>	<b>1226</b>
<b>Diagram Slide Show .....</b>	<b>1228</b>
<b>Model Search .....</b>	<b>1231</b>
<b>Use the Model Search .....</b>	<b>1233</b>
<b>Work On Objects In Search .....</b>	<b>1234</b>
<b>Search Definitions .....</b>	<b>1235</b>
Advanced Search Options .....	1238
Create Search Definitions .....	1239
Pre-defined Searches .....	1241
Add Filters .....	1242
Fields and Conditions .....	1243
<b>Traceability .....</b>	<b>1245</b>
<b>Packages and Elements .....</b>	<b>1246</b>
<b>Create Traceability Diagrams .....</b>	<b>1250</b>
<b>Traceability Tools .....</b>	<b>1251</b>
<b>The Traceability Window .....</b>	<b>1253</b>
<b>Element List .....</b>	<b>1255</b>
<b>Element List Options .....</b>	<b>1258</b>
<b>Relationship Matrix .....</b>	<b>1261</b>
<b>Open the Relationship Matrix .....</b>	<b>1262</b>
<b>Set Element Type .....</b>	<b>1262</b>
<b>Set Connector Type and Direction .....</b>	<b>1263</b>
<b>Set Source and Target Package .....</b>	<b>1264</b>
<b>Relationship Matrix Options .....</b>	<b>1265</b>
<b>Modify Relationships in Matrix .....</b>	<b>1266</b>
<b>Export to CSV .....</b>	<b>1267</b>
<b>Matrix Profiles .....</b>	<b>1267</b>



Review Source and Target Elements .....	1268
<b>The Relationships Window .....</b>	<b>1269</b>
<b>Diagram Filters .....</b>	<b>1271</b>
Work With Diagram Filters .....	1272
<b>The Pan &amp; Zoom Window .....</b>	<b>1275</b>
<b>Part VII Software Development .....</b>	<b>1277</b>
<b>Overview of Development .....</b>	<b>1279</b>
<b>Software Engineering .....</b>	<b>1281</b>
<b>Modeling Conventions .....</b>	<b>1282</b>
ActionScript Conventions.....	1283
Ada 2005.....	1284
C Conventions.....	1285
Object Oriented Programming In C.....	1286
C# Conventions.....	1287
C++ Conventions.....	1289
Managed C++ Conventions.....	1290
C++/CLI Conventions.....	1291
Delphi Conventions.....	1292
Java Conventions.....	1293
AspectJ Conventions.....	1294
PHP Conventions.....	1294
Python Conventions.....	1295
System C Conventions.....	1295
VB.Net Conventions.....	1296
Verilog Conventions.....	1298
VHDL Conventions.....	1299
Visual Basic Conventions.....	1301
<b>Code Template Framework .....</b>	<b>1301</b>
Code Templates.....	1302
Base Templates.....	1302
The Code Template Editor.....	1305
Synchronize Code.....	1307
Synchronize Existing Sections.....	1308
Add New Sections.....	1308
Add New Features and Elements.....	1308
<b>Generate Source Code .....</b>	<b>1308</b>
Generate a Single Class.....	1309
Generate a Group of Classes.....	1311
Generate a Package.....	1311
Update Package Contents.....	1313
Namespaces.....	1313
<b>Generate From Behavioral Models .....</b>	<b>1314</b>
SW Code Generation - State Machine Diagrams.....	1316
Java Code Generated From State Machine Diagram.....	1317
State Machine Modeling For HDLs.....	1319
Code Generation - Interaction Diagrams.....	1322
Code Generation - Activity Diagrams.....	1323
<b>Synchronize Model and Code .....</b>	<b>1327</b>
<b>Import Source Code .....</b>	<b>1328</b>
Import Source Code.....	1329
Notes on Source Code Import.....	1331
Import a Directory Structure.....	1332
Import Binary Module.....	1334
MDG Integration and Code Engineering.....	1334
Classes Not Found During Import.....	1335

<b>Other Settings .....</b>	<b>1335</b>
Source Code Engineering.....	1336
Source Code Options.....	1336
Import Component Types.....	1337
Options - Code Editors.....	1337
Editor Language Properties.....	1338
Options - Object Lifetimes.....	1340
Options - Attribute/Operations.....	1341
Code Page for Source Editing.....	1342
Local Paths.....	1343
Local Paths Dialog.....	1343
Language Macros.....	1344
Set Collection Classes.....	1345
Language Options.....	1347
ActionScript Options.....	1348
Ada 2005 Options.....	1348
C Options.....	1349
C# Options.....	1350
C++ Options.....	1351
Delphi Options.....	1352
Delphi Properties.....	1353
Java Options.....	1355
PHP Options.....	1356
Python Options.....	1356
SystemC Options.....	1357
VB.Net Options.....	1358
Verilog Options.....	1358
VHDL Options.....	1359
Visual Basic Options.....	1360
MDG Technology Language Options.....	1360
Reset Options.....	1361
<b>Database Engineering .....</b>	<b>1363</b>
<b>Import Database Schema .....</b>	<b>1363</b>
Select a Data Source.....	1365
Select Tables.....	1366
The Imported Class Elements.....	1367
<b>Generate DDL .....</b>	<b>1367</b>
Generate DDL For a Table.....	1367
Generate DDL for a Package.....	1369
<b>XML Engineering .....</b>	<b>1373</b>
<b>Import XSD .....</b>	<b>1373</b>
Global Element and ComplexType.....	1375
<b>Import WSDL .....</b>	<b>1376</b>
<b>Generate XSD .....</b>	<b>1376</b>
Generate Global Element.....	1378
<b>Generate WSDL .....</b>	<b>1379</b>
<b>Generate MOF .....</b>	<b>1380</b>
Getting Started.....	1381
Export MOF to XMI.....	1383
<b>Model Transformations - MDA .....</b>	<b>1385</b>
<b>Transform Elements .....</b>	<b>1387</b>
Chaining Transformations.....	1388
<b>Built-in Transformations .....</b>	<b>1388</b>
C# Transformation.....	1389
Data Model To ERD Transformation.....	1390
DDL Transformation.....	1393
EJB Transformations.....	1397

ERD To Data Model Transformation.....	1399
Java Transformation.....	1403
JUnit Transformation.....	1405
JUnit Transformation.....	1407
WSDL Transformation.....	1408
XSD Transformation.....	1409
<b>Transformation Templates .....</b>	<b>1412</b>
Import Transformations.....	1414
<b>Write Transformations .....</b>	<b>1414</b>
Default Transformation Templates.....	1415
Intermediary Language.....	1415
Objects.....	1415
Connectors.....	1419
Copy Information.....	1421
Convert Types.....	1421
Convert Names.....	1422
Cross References.....	1423
<b>Integrated Development .....</b>	<b>1424</b>
<b>Getting Started .....</b>	<b>1424</b>
Prerequisites.....	1424
Available Tools.....	1424
Workspace Layout.....	1424
General Workflow.....	1425
Code Generation and Synchronization - Safeguards.....	1425
Code Editing For MDDE.....	1425
<b>Setup .....</b>	<b>1425</b>
Managing Scripts.....	1426
Defining Script Actions.....	1427
Setting the Default Script.....	1428
<b>Code Editors .....</b>	<b>1428</b>
Syntax Highlighting.....	1429
Bookmarks.....	1430
Cursor History.....	1430
Brace Matching.....	1430
Automatic Indentation.....	1431
Commenting Selections.....	1431
Scope Guides.....	1431
Zooming.....	1432
Line Selection.....	1432
Intellisense.....	1432
Code Editor Key Bindings.....	1433
Code Editor Context Menu.....	1437
Script Editor.....	1439
The Source Code Viewer.....	1441
Source Code Viewer Toolbar.....	1442
<b>Build .....</b>	<b>1443</b>
Add Commands.....	1444
Recursive Builds.....	1446
<b>Debugging .....</b>	<b>1446</b>
How it Works.....	1446
Setup for Debugging.....	1447
Operating System Specific Requirements.....	1447
UAC-Enabled Operating Systems.....	1448
WINE Debugging.....	1450
Microsoft C++ and Native (C, VB).....	1451
Debug Symbols.....	1452
Java .....	1452
General Setup for Java.....	1453

Advanced Techniques.....	1454
Attach to Virtual Machine.....	1454
Internet Browser Java Applets.....	1454
Working with Java Web Servers.....	1456
JBOSS Server.....	1458
Apache Tomcat Server.....	1459
Apache Tomcat Windows Service.....	1460
.NET .....	1460
General Setup for .NET.....	1461
Debug Assemblies.....	1461
Debug - CLR Versions.....	1462
Debug COM Interop.....	1463
Debug ASP .NET.....	1463
The Debug Window.....	1467
Breakpoint and Marker Management.....	1468
How Markers are Stored.....	1469
Setting Code Breakpoints.....	1469
Setting Data Breakpoints.....	1470
Debugging Actions.....	1470
Displaying Windows.....	1471
Start & Stop Debugger.....	1471
Debug Another Process.....	1472
Step Over Lines of Code.....	1472
Step Into Function Calls.....	1473
Step Out of Functions.....	1473
View the Call Stack.....	1473
View the Local Variables.....	1474
View Content Of Long Strings.....	1474
View Variables in Other Scopes.....	1475
Inspect Process Memory.....	1476
Break When a Variable Changes Value.....	1477
Show Loaded Modules.....	1478
Show Output from Debugger.....	1478
Debug Tooltips in Code Editors.....	1479
Recording Actions.....	1480
Step Through Function Calls.....	1480
Create Sequence Diagram of Call Stack.....	1480
Saving the Call Stack.....	1482
<b>Run .....</b>	<b>1482</b>
Add Run Command.....	1482
<b>Testing .....</b>	<b>1483</b>
Add Testing Command.....	1483
<b>Deploying .....</b>	<b>1484</b>
Add Deploy Command.....	1484
<b>Searching Files .....</b>	<b>1485</b>
Search in Files.....	1485
<b>Visual Execution Analysis .....</b>	<b>1488</b>
<b>Introducing the Visual Execution Analyzer .....</b>	<b>1488</b>
<b>Structure of the Visual Execution Analyzer .....</b>	<b>1489</b>
<b>Execution Analysis .....</b>	<b>1490</b>
Recording Sequence Diagrams.....	1490
How it Works.....	1491
Setup for Recording.....	1492
Pre-Requisites.....	1492
Configure Recording Detail.....	1492
Enable Filter.....	1493
Record Arguments To Function Calls.....	1494
Record Calls To External Modules.....	1494

Record Calls to Dynamic Modules.....	1495
Limit Auto Recording.....	1496
Enable Diagnostic Messages.....	1496
Advanced Techniques.....	1497
Recording Activity for a Class.....	1497
Recording Activity for a Single Method.....	1498
Place Recording Markers.....	1499
Marker Types.....	1499
Setting Recording Markers.....	1502
The Breakpoints and Markers Window.....	1503
Activate and Disable Markers.....	1503
Working with Marker Sets.....	1503
Differences to Breakpoints.....	1503
Control the Recording Session.....	1504
Auto-Recording.....	1504
Manual Recording.....	1504
Pause Recording.....	1505
Resume Recording.....	1505
Stop Capture.....	1505
Generating Sequence Diagrams.....	1505
The Recording History.....	1506
Generate a Diagram.....	1507
Diagram Features.....	1507
Saving Recording.....	1507
Add State Transitions.....	1507
Setup for Capturing State Changes.....	1508
The State Machine.....	1509
Recording and Mapping State Changes.....	1511
Unit Testing.....	1512
Set Up Unit Testing.....	1512
Run Unit Tests.....	1513
Record Test Results.....	1514
Profiling Native Applications.....	1514
System Requirements.....	1516
Getting Started.....	1516
Start & Stop the Profiler.....	1517
Profiler Operation.....	1517
Setting Options.....	1518
Save and Load Reports.....	1518
Save Report in Team Review.....	1519
Object Workbench.....	1519
How it Works.....	1520
Workbench Variables.....	1521
Create Workbench Variables.....	1521
Invoke Methods.....	1522

**Part VIII Test and Quality Control 1527**

<b>Model Validation .....</b>	<b>1528</b>
<b>Configure Model Validation .....</b>	<b>1530</b>
<b>Rules Reference .....</b>	<b>1530</b>
Well-Formedness.....	1531
Element Composition.....	1531
Property Validity.....	1532
OCL Conformance.....	1532
<b>Testing .....</b>	<b>1536</b>
<b>The Testing Workspace .....</b>	<b>1537</b>
<b>The Test Details Dialog .....</b>	<b>1538</b>

Unit Testing .....	1539
Integration Testing .....	1540
System Testing .....	1541
Acceptance Testing .....	1542
Scenario Testing .....	1543
Move or Copy Tests Between Categories .....	1544
Import Scenario as Test .....	1544
Import Test From Other Elements .....	1546
Import Responsibility or Constraint as Test .....	1547
Create Maintenance Item From Test .....	1548
Testing Details Report .....	1549
Show Test Script Compartments .....	1549
Test Documentation .....	1550
<b>Spell Checking .....</b>	<b>1552</b>
Using the Spell Checker .....	1552
Correcting Words .....	1553
Select a Different Language .....	1554
<b>Part IX Maintenance and Bug Tracking .....</b>	<b>1557</b>
<b>Maintenance .....</b>	<b>1558</b>
The Maintenance Workspace .....	1558
Maintenance Item Properties .....	1559
Move or Copy Maintenance Items .....	1561
Create Elements From Maintenance Item .....	1561
Show Maintenance Script in Diagram .....	1561
<b>Changes and Defects .....</b>	<b>1563</b>
Defects (Issues) .....	1563
Changes .....	1564
Element Properties .....	1565
Assign People to Defects or Changes .....	1566
<b>Part X Report Generation .....</b>	<b>1568</b>
<b>RTF Documents .....</b>	<b>1569</b>
<b>Generate RTF Documents .....</b>	<b>1570</b>
Diagram Options .....	1571
Exclude Package from Report .....	1573
Generate RTF Documentation Dialog .....	1573
RTF Templates Tab .....	1576
RTF Style Template Editor .....	1578
Select Components for Reporting .....	1579
Tabular Sections .....	1581
Child Sections .....	1584
Constraint and Scenario Sections .....	1585
Add Content .....	1586
RTF Style Template Editor Options .....	1587
Scroll Through Text .....	1588
File and Print Options .....	1588
Cut and Paste Options .....	1589
View Options .....	1590
Image and Object Inserts .....	1591
Character Formatting .....	1592
Paragraph Formatting .....	1593
Tab Support .....	1595
Page Breaks and Repagination .....	1595
Headers and Footers .....	1596
Hyperlinks and Bookmarks .....	1597

Table Commands.....	1597
Sections and Columns.....	1599
Stylesheets and Table of Contents.....	1600
User-Defined Section Numbering.....	1601
Frames and Drawing Objects.....	1604
Search and Replace Commands.....	1605
Import RTF Template.....	1606
Resource Documents.....	1606
Document Options.....	1607
Element Filters.....	1611
Other Filters.....	1612
Project Constants.....	1614
Word Substitution.....	1615
Language Substitution.....	1615
<b>Virtual Documents .....</b>	<b>1616</b>
Create Master Document.....	1618
Create Model Document.....	1619
Add Packages to Model Document.....	1620
Delete Package in Model Document.....	1621
Document Order.....	1622
Section Numbering in Virtual Documents.....	1623
Generate the Document.....	1623
<b>Other Documents .....</b>	<b>1624</b>
Dependency Report.....	1624
Diagrams Only Report.....	1625
Implementation Report.....	1626
Set Target Types Dialog.....	1627
Testing Report.....	1627
<b>The Legacy RTF Report Generator .....</b>	<b>1628</b>
Document a Single Element.....	1629
Set the Main RTF Properties.....	1629
Apply a Filter.....	1630
Exclude Elements.....	1630
RTF Diagram Format.....	1631
Model Include.....	1631
RTF Report Options.....	1632
RTF Report Selections.....	1633
Generate the Report.....	1634
Legacy RTF Style Templates.....	1634
Save as Document.....	1636
Custom Language Settings.....	1637
<b>Use MS Word .....</b>	<b>1638</b>
Open a Report in Microsoft Word.....	1638
Change Linked Images to Embedded.....	1638
RTF Bookmarks.....	1639
Other Features of Word.....	1641
Add Table of Contents.....	1641
Add Table of Figures.....	1642
Add Headers and Footers.....	1643
Manipulate Tables in Word.....	1644
Refresh Links.....	1646
<b>HTML Reports .....</b>	<b>1647</b>
<b>Create an HTML Report .....</b>	<b>1647</b>
<b>The Generate HTML Report Dialog .....</b>	<b>1648</b>
<b>Web Style Templates .....</b>	<b>1649</b>
<b>HTML Template Fragments .....</b>	<b>1651</b>

<b>Scripting .....</b>	<b>1660</b>
<b>Scripts Tab .....</b>	<b>1661</b>
Script Group Properties.....	1663
<b>Console Tab .....</b>	<b>1663</b>
<b>Enterprise Architect Object Model .....</b>	<b>1666</b>
<b>Using the Automation Interface .....</b>	<b>1666</b>
Connect to the Interface.....	1666
Set References In Visual Basic.....	1668
Examples and Tips.....	1669
Call from Enterprise Architect.....	1670
Available Resources.....	1671
<b>Reference .....</b>	<b>1671</b>
Interface Overview .....	1672
App.....	1674
Enumerations.....	1675
ConstLayoutStyles Enum.....	1675
CreateBaselineFlag Enum.....	1676
CreateModelType Enum.....	1676
EAEditionTypes Enum.....	1676
EnumRelationSetType Enum.....	1676
ExportPackageXMIFlag Enum.....	1677
MDGMenus Enum.....	1677
ObjectType Enum.....	1677
PropType Enum.....	1678
ReloadType Enum.....	1678
ScenarioDiagramType Enum.....	1678
ScenarioStepType Enum.....	1679
ScenarioTestType Enum.....	1679
XMIFlag Enum.....	1679
Repository.....	1679
Repository.....	1680
Author .....	1693
Client .....	1694
Collection.....	1695
Datatype.....	1696
EventProperties.....	1697
EventProperty.....	1697
ModelWatcher.....	1698
Package.....	1698
ProjectIssues.....	1703
ProjectResource.....	1704
PropertyType.....	1704
Reference.....	1705
Stereotype.....	1706
Task .....	1707
Term .....	1708
Element.....	1708
Constraint.....	1710
Effort .....	1710
Element .....	1711
File .....	1717
Issue (Maintenance).....	1718
Metric .....	1719
Requirement.....	1719
Resource.....	1720
Risk .....	1721
Scenario.....	1722
ScenarioExtension.....	1723



ScenarioStep.....	1723
TaggedValue.....	1724
Test .....	1725
Element Features.....	1726
Attribute .....	1727
AttributeConstraint.....	1729
AttributeTag.....	1730
CustomProperties.....	1730
EmbeddedElements.....	1731
Method .....	1732
MethodConstraint.....	1733
MethodTag.....	1734
Parameter.....	1735
Partitions.....	1736
Properties.....	1736
Transitions.....	1737
Connector.....	1738
ConnectorConstraint.....	1738
Connector.....	1739
ConnectorEnd.....	1742
ConnectorTag.....	1744
RoleTag.....	1744
Diagram.....	1745
Diagram .....	1746
DiagramLinks.....	1749
DiagramObjects.....	1750
SwimlaneDef.....	1751
Swimlanes.....	1751
Swimlane.....	1752
Project Interface.....	1753
Project .....	1753
Code Samples.....	1765
Open the Repository.....	1765
Iterate Through a .EAP File .....	1766
Add and Manage Packages.....	1766
Add and Manage Elements.....	1767
Add a Connector.....	1767
Add and Manage Diagrams .....	1768
Add and Delete Features.....	1769
Element Extras.....	1769
Repository Extras.....	1772
Stereotypes.....	1773
Work With Attributes.....	1773
Work With Methods.....	1774
<b>Enterprise Architect Add-In Model .....</b>	<b>1776</b>
<b>Add-In Tasks .....</b>	<b>1777</b>
Create Add-Ins.....	1777
Define Menu Items.....	1777
Deploy Add-Ins.....	1778
Tricks and Traps.....	1779
<b>The Add-In Manager .....</b>	<b>1781</b>
<b>Add-In Search .....</b>	<b>1781</b>
XML Format (Search Data).....	1782
<b>Add-In Events .....</b>	<b>1782</b>
EA_Connect.....	1782
EA_Disconnect.....	1783
EA_GetMenuItems.....	1783
EA_GetMenuState.....	1784

EA_MenuClick.....	1785
EA_OnOutputItemClicked.....	1785
EA_OnOutputItemDoubleClicked.....	1786
EA_ShowHelp.....	1787
<b>Broadcast Events .....</b>	<b>1787</b>
EA_FileOpen.....	1788
EA_FileClose.....	1788
EA_FileNew.....	1789
EA_OnPostCloseDiagram.....	1789
EA_OnPostOpenDiagram.....	1789
Pre-Deletion Events.....	1790
EA_OnPreDeleteElement.....	1790
EA_OnPreDeleteAttribute.....	1791
EA_OnPreDeleteMethod.....	1791
EA_OnPreDeleteConnector.....	1792
EA_OnPreDeleteDiagram.....	1792
EA_OnPreDeletePackage.....	1793
Pre-New Events.....	1793
EA_OnPreNewElement.....	1793
EA_OnPreNewConnector.....	1794
EA_OnPreNewDiagram.....	1795
EA_OnPreNewDiagramObject.....	1795
EA_OnPreNewAttribute.....	1796
EA_OnPreNewMethod.....	1797
EA_OnPreNewPackage.....	1797
EA_OnPreExitInstance.....	1798
Post-New Events.....	1798
EA_OnPostNewElement.....	1798
EA_OnPostNewConnector.....	1799
EA_OnPostNewDiagram.....	1800
EA_OnPostNewDiagramObject.....	1800
EA_OnPostNewAttribute.....	1801
EA_OnPostNewMethod.....	1801
EA_OnPostNewPackage.....	1802
EA_OnPostInitialized.....	1802
EA_OnPostTransform.....	1803
Technology Events.....	1803
EA_OnInitializeTechnologies.....	1803
EA_OnPreActivateTechnology.....	1804
EA_OnPostActivateTechnology.....	1805
EA_OnPreDeleteTechnology.....	1805
EA_OnDeleteTechnology.....	1806
EA_OnImportTechnology.....	1806
Context Item Events.....	1807
EA_OnContextItemChanged.....	1807
EA_OnContextItemDoubleClicked.....	1808
EA_OnNotifyContextItemModified.....	1809
Compartment Events.....	1809
EA_QueryAvailableCompartments.....	1809
EA_GetCompartmentData.....	1810
Model Validation Broadcasts.....	1811
EA_OnInitializeUserRules.....	1812
EA_OnStartValidation.....	1812
EA_OnEndValidation.....	1813
EA_OnRunElementRule.....	1813
EA_OnRunPackageRule.....	1813
EA_OnRunDiagramRule.....	1814
EA_OnRunConnectorRule.....	1814

EA_OnRunAttributeRule.....	1815
EA_OnRunMethodRule.....	1815
EA_OnRunParameterRule.....	1816
Model Validation Example.....	1816
EA_OnRetrieveModelTemplate.....	1820
<b>Custom Views .....</b>	<b>1820</b>
Create a Custom View.....	1821
<b>MDG Add-Ins .....</b>	<b>1821</b>
MDG Events.....	1822
MDGBuild Project.....	1822
MDGConnect.....	1822
MDGDisconnect.....	1823
MDGGetConnectedPackages.....	1824
MDGGetProperty.....	1824
MDGMerge.....	1825
MDGNewClass.....	1826
MDGPostGenerate.....	1827
MDGPostMerge.....	1827
MDGPreGenerate.....	1828
MDGPreMerge.....	1828
MDGPreReverse.....	1829
MDGRunExe.....	1830
MDGView.....	1830

**Part XII Glossary of Terms 1833**

<b>A .....</b>	<b>1834</b>
<b>B .....</b>	<b>1836</b>
<b>C .....</b>	<b>1837</b>
<b>D .....</b>	<b>1840</b>
<b>E .....</b>	<b>1842</b>
<b>F .....</b>	<b>1843</b>
<b>G .....</b>	<b>1844</b>
<b>H .....</b>	<b>1845</b>
<b>I .....</b>	<b>1846</b>
<b>J .....</b>	<b>1848</b>
<b>L .....</b>	<b>1849</b>
<b>M .....</b>	<b>1850</b>
<b>N .....</b>	<b>1852</b>
<b>O .....</b>	<b>1853</b>
<b>P .....</b>	<b>1854</b>
<b>Q .....</b>	<b>1857</b>
<b>R .....</b>	<b>1858</b>
<b>S .....</b>	<b>1860</b>
<b>T .....</b>	<b>1863</b>
<b>U .....</b>	<b>1864</b>
<b>V .....</b>	<b>1865</b>

**Part XIII License Management 1867**

<b>Finding Your License Information .....</b>	<b>1869</b>
---	-------------

<b>Add License Key .....</b>	<b>1870</b>
<b>Keystore Troubleshooting .....</b>	<b>1872</b>
<b>Upgrade an Existing License .....</b>	<b>1873</b>
<b>Register Add-In .....</b>	<b>1876</b>
<b>Index</b>	<b>1878</b>

# Foreword

This user guide provides an introduction to the features contained in Enterprise Architect - a UML modeling tool for developing and building software systems with UML.

**Part**



# 1 Introduction



Welcome to Sparx Systems *Enterprise Architect*, a UML 2.3 based modeling tool for designing and constructing software systems, for business process modeling, and for generalized modeling purposes such as visualizing existing systems and processes.

The *Enterprise Architect User Guide* provides tutorials, guidance and reference material to help you use Enterprise Architect in:

- [Model Development](#) <sup>[370]</sup>
- [Model Management](#) <sup>[111]</sup>
- [Project Management](#) <sup>[312]</sup>
- [Model Auditing](#) <sup>[270]</sup>
- [Model Baselineing and Differencing](#) <sup>[279]</sup>
- [Model User Security](#) <sup>[188]</sup>
- [Model Version Control](#) <sup>[228]</sup>
- [Using and Creating Modeling Languages](#) <sup>[67]</sup>
- [Code Engineering](#) <sup>[128]</sup>
- [Visualization and Analysis of Code Execution](#) <sup>[148]</sup>
- [RTF and HTML Document Creation](#) <sup>[158]</sup> (Reports)

See the [Overview](#) <sup>[4]</sup> for further details of what Enterprise Architect can do and what you can use it for.

Enterprise Architect makes extensive use of UML, so we describe the [Enterprise Architect representations](#) <sup>[370]</sup> of UML diagrams, elements and connectors. Enterprise Architect also includes a Technology Developer's interface (see [Automation and Scripts](#) <sup>[165]</sup>) that enables you to extend and customize the tool.

## To Use This Guide

If you are new to modeling and UML as well as Enterprise Architect, or otherwise want a rapid review of the process of modeling with Enterprise Architect, go to the [Quickstart Tutorial](#) <sup>[26]</sup>. This is not just a theoretical description - the first things you do are start Enterprise Architect and immediately create a model project.

Enterprise Architect is very flexible and has lots of features. When working through the Quickstart tutorial you will see many links to more extensive descriptions of features, functions, tasks and procedures, in the [User Interface Guide](#) <sup>[48]</sup>. You can follow any of these immediately if you require more information.

You should read the Sparx Systems [Formal Statements](#) <sup>[16]</sup>, including the Copyright Notice and our End User Licensing Agreement.

You can also check the [Glossary](#) <sup>[183]</sup> for definitions of various terms and concepts used in this guide.

## Your Feedback

Sparx Systems likes to stay in touch with what Enterprise Architect users require in order to accomplish their tasks efficiently and effectively. We value any suggestions, feedback and comments you might have regarding this product, documentation or install process.

You can access our online feedback pages at:

- [www.sparxsystems.com/bug\\_report.htm](http://www.sparxsystems.com/bug_report.htm) and
- [www.sparxsystems.com/feature\\_request.htm](http://www.sparxsystems.com/feature_request.htm).

Alternatively, you can contact Sparx Systems by email at: [support@sparxsystems.com](mailto:support@sparxsystems.com).

## 1.1 Overview



### Powerful UML Analysis and Design Tool

Enterprise Architect is a comprehensive UML analysis and design tool, covering all aspects of the software development cycle, from requirements gathering through analysis, model design, testing, change control and maintenance to implementation, with full traceability. Enterprise Architect combines the power of the latest UML 2.3 specification with a high performance, intuitive interface, to bring advanced modeling to the whole development team. It is a multi-user, visual tool with a great [feature set](#)<sup>[8]</sup>, helping analysts, testers, project managers, quality control staff and deployment staff around the world to build and document robust, maintainable systems and processes.

### The UML Modeling Tool of Choice, Globally

With over 200,000 licenses sold, Enterprise Architect has proven highly popular across a wide range of industries and is used by thousands of companies world-wide. From large, well-known, multi-national organizations to smaller independent companies and consultants, Enterprise Architect has become the UML modeling tool of choice for developers, consultants and analysts in over 130 countries.

Sparx Systems software is used in the development of many kinds of application and system in a wide range of industries, including: aerospace, banking, web development, engineering, finance, medicine, military, research, academia, transport, retail, utilities (such as gas and electricity) and electrical engineering. It is also used effectively for UML and enterprise architecture training in many prominent colleges, training companies and universities around the world.

Now see:

- [Key Benefits of Enterprise Architect](#)<sup>[5]</sup>
- [Enterprise Architect Key Features](#)<sup>[8]</sup>

#### 1.1.1 What You Can Do

This topic introduces the fundamental processes that Enterprise Architect supports.

Enterprise Architect is a powerful CASE tool for specifying, documenting and building software projects. Using Enterprise Architect's support for UML and its related standards, you can model new complex software and business systems, or visualize and maintain existing systems.

### Modeling

Enterprise Architect is a comprehensive model analysis and design tool. To create models with Enterprise Architect, you therefore should become familiar with:

- how Enterprise Architect **implements** the UML standards and
- how you apply UML in Enterprise Architect to **develop your models**.

For more information, see [Modeling Fundamentals](#)<sup>[370]</sup>.

### Managing Models

To manage the models in your projects, you both protect and manage the **model data** itself, and communicate information on the data in the form of RTF and HTML **documentation and reports**.

For more information, see [Projects and Teams](#)<sup>[111]</sup>.

### Code Engineering

In Enterprise Architect, UML modeling both depends on and supports code engineering - you generate and update code from a model, and you create and update models from code. In this broad sense, Enterprise



Architect enables you to:

- **Forward engineer, reverse engineer**, round-trip and **synchronize** code in a **range of programming languages**
- **Debug and profile** code
- Model and generate code for **XML Technologies**
- Perform **database modeling** and database design for a **range of database management systems**
- Convert model components from one **domain** to another using **Model Driven Architecture (MDA) Transformations**.

For more information, see [Software Development](#)<sup>[1278]</sup>.

## Managing Projects

Enterprise Architect provides strong support for Project Management, particularly in the following areas:

- **Project estimation** - working out how much time and effort is required to build and deploy a solution, using the **Use Case metrics** facility and carefully-calibrated **metrics**
- Defining, assigning and **managing resources**
- Monitoring and managing **problems, changes, issues and tasks** that affect both individual **elements** and the **project** as a whole
- Managing the development, execution and results of **testing**, from Integration through to User Acceptance, and
- Maintaining a **project glossary** of terms, procedures and policies applied to the project.

For more information, see [Projects and Teams](#)<sup>[111]</sup>.

Project management discussions and decisions can be communicated to the project through the [Team Review Tools](#)<sup>[208]</sup>.

The scope of your project management might include upgrades to Enterprise Architect and installation of related technologies. In this case, also see [License Management](#)<sup>[1867]</sup>.

## Extending Enterprise Architect Facilities

Experienced Technology Developers can **develop customized additions** to the functionality already present within Enterprise Architect. These additions include:

- **UML Profiles and Stereotypes**
- **UML Patterns**
- **Code Templates**
- **Tagged Value Types**
- **MDG Technologies** and
- Enterprise Architect **Add-Ins**.

By creating these extensions the Technology Developer can customize the Enterprise Architect modeling process to specific tasks and speed up development.

For more information, see [Build Your Own Modeling Language](#)<sup>[1092]</sup>.

### 1.1.2 Key Benefits

Enterprise Architect is a powerful tool for specifying, documenting and building your software and business process projects. Using Enterprise Architect's **support for UML** and its related standards, you can model new complex software and business systems, or visualize and maintain existing systems.

## Design and Build Diverse Systems Using UML

[UML 2.3](#)<sup>[672]</sup> is an open standard that provides a rich language for describing, documenting and designing software, business and IT systems in general.

Enterprise Architect enables you to [leverage the full expressive power](#)<sup>[376]</sup> of UML 2.3 to model, design and build diverse systems in an open and well understood manner. You can generate code, database structures, documentation and metrics; transform models; or specify behavior and structure as the basis for contractual agreements.

## Model and Manage Complexity

Enterprise Architect helps individuals, groups and large organizations model and manage complex information.

Often this relates to software development and IT systems design and deployment, but it can also relate to business analysis and business process modeling. Enterprise Architect integrates and connects a wide range of structural and behavioral information, helping to build a coherent and verifiable architectural model, either what-is or what-will-be. Tools to manage [version control](#) [228], track and [compare differences](#) [283], [audit](#) [276] changes and enforce [security](#) [188], help control project development and enforce compliance to standards .

## Structured Use Case Scenarios

Enterprise Architect's [Structured Scenario](#) [493] editor enables you to develop structured Use Case Scenarios, to capture vital analysis information in the form of natural language descriptions.

The editor helps you use this information to drive downstream development and maximize traceability across the development life-cycle. The editor also helps you to dynamically link scenario steps to associated model elements, such as domain elements, business rules and glossary terms. From structured scenarios, you can automatically generate test case descriptions, and Activity and other UML behavioral diagrams. You can even reverse engineer existing process diagrams into structured, textual specifications to produce documentation deliverables.

## Share Models

Enterprise Architect enables you to share complete models or specific aspects of a model between members of a team, including (through the '[Lite](#)', [read-only](#)' [15] edition) stakeholders who can study a model but not change or manage it.

You can make your project .EAP file available on a [shared network drive](#) [183], or [replicate](#) [184] the .EAP file for complex distributed development. Alternatively, you can develop the project in one of several [shared DBMS repositories](#) [122], such as Access 2007, SQL Server; My SQL; PostgreSQL; Oracle 9i, 10g or 11g; and Sybase ASA. You can import and export data as [XML files](#) [288] to distribute and update frameworks and other package-based model structures. You control changes through the [version control](#) [228] repository. Enterprise Architect provides a [data transfer wizard](#) [307] that enables you to upsize or downsize the complete model for maximum flexibility, and it enables you to export and import [reference data](#) [223] so that you do not have to recreate it for related projects.

## Model, Manage and Trace Requirements

Enterprise Architect enables you to capture [requirements](#) [917] and use full [traceability](#) [1245] from base requirements to design, build, deployment and beyond. You can use impact analysis to trace from proposed changes to original requirements, and build the 'right' system.

## Develop Personal Views and Extracts of the Model

Enterprise Architect enables you to develop any number of different views of your model, or parts of it, either for your personal use or for the use of your team.

These [Model Views](#) [1227] are generated by reports, so they can be set up to always show the current status of the selected view. The facility also enables you to create Favorites folders of hyperlinks to frequently-used data structures.

## Track and Trace Model Structures

In even a small model, it can be difficult to locate specific packages, diagrams or elements, even if you apply a rigorous naming and structure policy.

Enterprise Architect has a wealth of facilities that enable you to locate structures quickly and easily, through the [Model Search](#) [1237], [Element List](#) [1255], [Auditing facility](#) [270], [Traceability](#) [1253] window, [Relationship Matrix](#) [1267] and [reports](#) [1624]. The [Element](#) [67] menu, [Diagram](#) [65] menu and [Project Browser context menus](#) [1213] also enable you to locate elements in diagrams and in the [Project Browser](#), and you can store hyperlinks to important or commonly-used elements and diagrams in the [Model Views](#) [1227]. Finally, having located one element you can [import any related elements](#) [557] into a diagram in a single operation.

## Generate Documentation

Enterprise Architect provides powerful document generation and reporting tools with a full WYSIWYG

template editor for [RTF](#) or [HTML](#) output. You can generate complex and detailed reports from Enterprise Architect with the information you require in the format your company or client demands.

## Generate and Reverse Engineer Source Code

Enterprise Architect supports [generation](#) and [reverse engineering](#) of source code for many popular languages, such as C++, C#, Java, Delphi, VB.Net, Visual Basic, ActionScript, Python and PHP.

With a built in 'syntax highlighting' [source code editor](#), Enterprise Architect enables you to quickly navigate and explore your model source code in the same environment. [Code generation templates](#) enable you to customize the generated source code to your company specifications.

## Visualize, Inspect and Understand Complex Software

Software is complex and often hard to understand. You can use Enterprise Architect to [reverse engineer](#) code in a wide range of software development languages and database repository schema, to understand static structure.

To complete the picture, use the unique built-in [profiling and debugging](#) tools to capture and visualize executing software at run-time. Create run-time instances of model elements and invoke methods using the built in [Object Workbench](#).

You can also bring in complete frameworks from [source code](#) or Java .jar files - or even [.Net binary](#) assemblies! By importing frameworks and library code, you can maximize re-use and understanding of your existing investment.

## Perform MDA Transformations

Model Driven Architecture (MDA) is an open standard designed to facilitate rapid application development in a platform independent manner. Models can be built at a high level of abstraction and, using MDA based tools, transformed into models and code targeting a specific platform or domain.

Enterprise Architect supports advanced [MDA transformations](#) using easily edited and developed transformation templates. With [built-in transformations](#) for DDL, C#, Java, EJB and XSD, you can quickly develop complex solutions from simple platform independent models (PIMs) targeted at platform specific models (PSMs). One PIM can be used to generate and synchronize multiple PSMs, providing a significant productivity boost.

## SOA (Service Oriented Architecture) Support

Enterprise Architect enables you to rapidly model and forward- and reverse-engineer two key W3C XML technologies: [XML Schema](#) (XSD) and [Web Service Definition Language](#) (WSDL).

XSD and WSDL support is critical for the development of a complete Service Oriented Architecture (SOA), and the coupling of UML 2.3 and XML provides the natural mechanism for specifying, constructing and deploying XML-based SOA artifacts within an organization.

## Systems Engineering support

Integrating many high-end features for Systems Engineers, the [Ultimate](#) and [Systems Engineering](#) editions of Enterprise Architect provide built-in support for [SysML 1.1](#), parametric model simulation, [executable code generation](#), as well as model to code transformations for [Hardware Description Languages](#) and [Ada 2005](#).

## Model Databases

Enterprise Architect enables you to reverse engineer from many popular DBMS systems, including Oracle 9i, 10g or 11g; SQL Server; My SQL; Access 2007 and PostgreSQL.

You can [model database](#) tables, columns, keys, foreign keys and complex relationships using UML and an inbuilt data modeling profile, and forward generate DDL scripts to create target database structures.

## Customize Enterprise Architect

Enterprise Architect also includes facilities that enable experienced tool developers to customize and extend Enterprise Architect to suit the specific requirements of their organization with, for example, in-house [UML Profiles](#), [Add-Ins](#) and [Code Templates](#).

The very detailed [Automation Interface](#) gives you access to most element features, major functions such

as XMI import/export, and attached information. Most properties are fully writable from the automation client. The Automation Interface provides great support for plug-ins, with the ability to embed automation client windows in the main diagram view. The Interface is accessible from any automation-aware client language, such as VB, C#, C++ and Delphi.

## Link Enterprise Architect to IDEs

Using Sparx Systems Model Driven Generation (MDG) *Link* plug-ins, you can develop source code in your preferred Integrated Development Environment such as [Visual Studio .NET](#) or [Eclipse](#), while you use Enterprise Architect to locate the source code for Classes, attributes and operations, and to model, navigate, track, reverse engineer, build and run your project.

The MDG *Integration* products for [Eclipse](#) and [Visual Studio 2008](#) provide an even closer, seamless integration of Enterprise Architect and UML 2.3 with your IDE, bringing the functionality required of a fully fledged modeling platform right inside the IDE.

### 1.1.3 Key Features

Enterprise Architect is renowned for its rich feature set. Some of the key features are highlighted in the following list:

- Model complex information, software and hardware systems using UML-compliant notation (comprehensive **UML 2.3** support for all 14 UML diagrams)
- Extended modeling for **Requirements, User Interface Design, Mind Mapping, Data Modeling, SysML, SPEM, BPMN 1.1** and more
- Generate **BPEL** scripts automatically from **Business Process** models
- Built-in **Requirements Management** enables you to specify, trace and verify requirements directly against the design, right through to the deployed solution
- Comprehensive and flexible MS Word-compatible **HTML and RTF report options**
- Leverage industry-standard **Enterprise Architecture** frameworks (**Zachman, TOGAF, DoDAF-MODAF**)
- Support in **forward and reverse code engineering** for many software and hardware languages 'out of the box': ActionScript 3.0, Java, C#, C++, VB.Net, Delphi, Visual Basic, Python, PHP, Verilog, VHDL and SystemC
- Ability to perform **database modeling**, to **reverse engineer** from a range of DBMSs via ODBC, and to **forward generate DDL scripts** to create database structures
- Connect to **shared database repositories** using MS SQL Server, MySQL, Oracle and more
- **Manage, track and control change** using **baseline** model merge and **auditing** capabilities
- **Centralize enterprise-wide documentation** of processes and information systems
- **Model dependencies** between elements, system dynamics and state
- **Model class hierarchies**, deployment, components and implementation details
- **Record project issues, tasks** and system glossary
- **Assign resources** to model elements and **track effort expended** against required effort
- **Testing support** for test cases, JUnit and NUnit
- Integrated **Debug Workbench** for visualizing executable Java and .Net applications, instantiating run-time model objects and generating Sequence diagrams from a stack trace
- **Migrate changes** across a distributed environment using **Controlled XMI Packages**
- Manage **Version control** through XMI using **SCC CVS** and **Subversion** configurations
- Inbuilt user and group **security** and access control management
- **Distributed development** through shareable files, use of **shared repositories** in a range of major Database Management Systems, file replication, data transfer, and import and export of reference data
- **Share models** using the latest **XMI 2.1** format
- **Import models** in XMI format from other tools
- Built-in Model Driven Architecture (**MDA**) **Transformations**, and facilities to import or create others
- Facilities to **import database schema, XSD and WSDL source, .NET and Java binaries**
- Use **UML Profiles** to create custom extensions for domain-specific modeling
- Save and load complete diagrams as **UML Patterns**
- Create and share dynamic views of model elements and diagram sets using **Model Views**
- Analyze and trace relationships between elements using the tabular **Relationship Matrix**
- Generate **executable business logic** from **rule tasks** and trace to natural language **business rules**

- Transform **behavioral models** into executable source code for software and **hardware description languages** (HDLs) such as Verilog, VHDL, and SystemC
- **Simulate SysML parametric models**
- Script and automate common tasks using a detailed **Automation Interface** and **Model Scripts**
- A range of internal and external **commercial MDG Add-Ins**<sup>[1073]</sup> to integrate the facilities of Enterprise Architect with IDEs and other technologies, and templates to write your own
- **Read-only Viewer** enables stakeholders to view but not change milestone deliverables
- **Price:** Enterprise Architect is priced to outfit the entire team, making collaboration and team development a real possibility
- **Speed:** Enterprise Architect is quick to load and a spectacularly fast performer, even with large models
- **Scalability:** Enterprise Architect supports single users and the development of small models, or many concurrent users developing extremely large models, with equal ease
- **Usability:** many of our users agree, Enterprise Architect gets you started and productive quickly, with a rich user interface and the ability to create **templates, model views** and 'favorites' collections of commonly-used elements and diagrams.

For a complete list of the new features of the latest version of Enterprise Architect, click on the **Help | Read Me** menu option.

Enterprise Architect is available in six editions: **Ultimate, Business and Software Engineering, Systems Engineering, Corporate, Professional**, and **Desktop**, each of which offers a different range of features. For a comparison of the Enterprise Architect editions, see the [Editions Available](#)<sup>[12]</sup> topic.

## 1.2 Enterprise Architect Editions



Enterprise Architect is available in a number of different editions, each tailored to support a particular business case.

- Before purchase, you can test the product in a number of configurations in the [Trial version](#)<sup>[10]</sup>.
- Whilst using the Trial version, consider the specific features of the six work environment [editions available](#)<sup>[12]</sup> - Desktop, Professional, Corporate, Business and Software Engineering, Systems Engineering, and Ultimate.
- For project reviews and other read-only tasks, you can use the free, [read-only or 'Lite' edition](#)<sup>[15]</sup>.

### 1.2.1 The Trial Version

The trial version of Enterprise Architect is identical to the registered edition with the exception that all diagrams are output to files with an embedded watermark.

If you are evaluating the Enterprise Architect trial version, note that the software operates for a limited period. The trial software stops working after the trial period has elapsed. To continue using Enterprise Architect when the trial period expires, you can either apply to extend the trial period (see [below](#)<sup>[11]</sup>), or purchase and register a full license. On purchase of a suitable license or licenses, the registered version is made available for download.

The latest information on pricing and purchasing is available at: [Sparx Systems Purchase/Pricing Website](#).

For more information, contact [sales@sparxsystems.com](mailto:sales@sparxsystems.com).

When you order and pay for an edition of Enterprise Architect, you receive installation instructions and the location of the executable files for download. See the following topics:

- [Installation](#)<sup>[21]</sup>
- [Register a Full License](#)<sup>[22]</sup>

If you already have a full license edition of Enterprise Architect and want to register Add-Ins or upgrade to the Professional, Corporate, Business and Software Engineering, Systems Engineering or Ultimate editions, see the [License Management](#)<sup>[186]</sup> topic.

### Try Out Editions

When you start up the Enterprise Architect trial version, the **Select Trial Version** prompt displays:

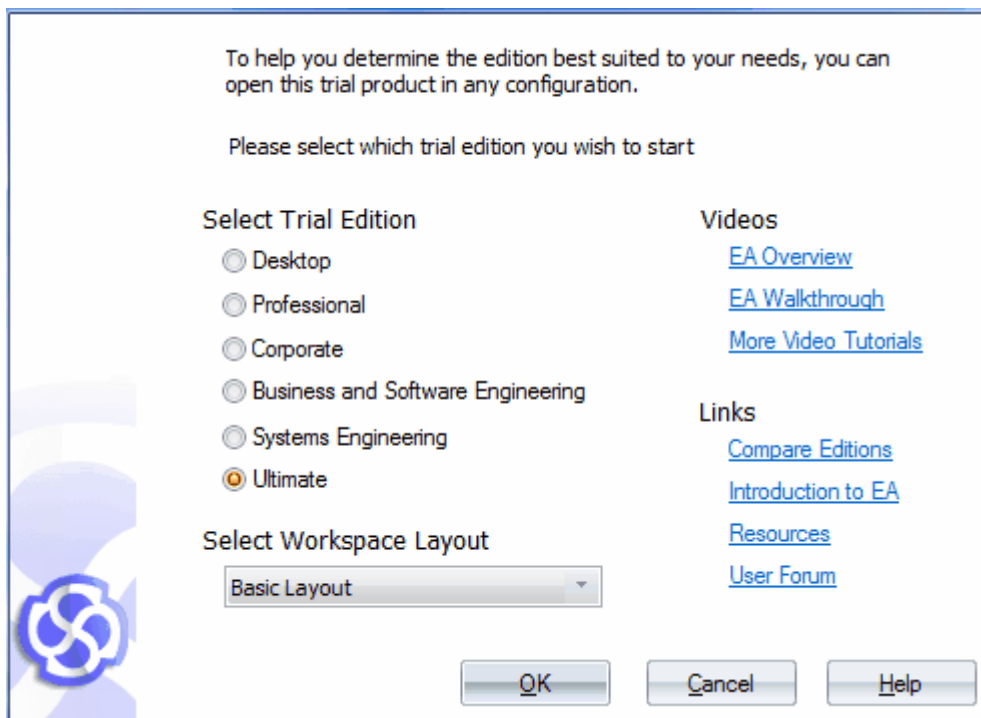

This enables you to select the edition of Enterprise Architect to evaluate, by clicking on the appropriate radio button. The prompt also directs you to useful information such as a comparison of the different editions, or a walkthrough of the Enterprise Architect facilities. When using Enterprise Architect, you can select from a range of [workspace layouts](#)<sup>[86]</sup>; the **Select Trial Version** prompt enables you to select the initial layout to use.

## Extend Trial Period

If you are testing the trial version and need more than 30 days to evaluate it, you can apply to Sparx Systems Sales ([sales@sparxsystems.com](mailto:sales@sparxsystems.com)) for an extension of the trial period. This extension can be an additional 30 to 150 days; if you do not request a long enough extension in the first place, you can submit further requests. Sparx Systems Sales send you an extension key by email.

### Note:

The trial period must expire before you can enter the extension key.

To extend the trial period, after receipt of your extension key, follow the steps below:

1. Open the Enterprise Architect trial version. The **Evaluation Version of Enterprise Architect** dialog displays.

**Note:**

Once the trial period has expired, you cannot proceed beyond this dialog without extending the trial period.

2. Press **[Ctrl]** whilst you click on the **Continue Trial** button. The **Upgrade Key** dialog displays.

3. In the **Upgrade Key** field, type or copy-and-paste the extension key you received from Sparx Systems Sales.
4. Click on the **OK** button. Enterprise Architect confirms that your trial period has been extended. Your trial period is extended by the period of days stated in the email from Sparx Systems Sales. You can now *restart* and use the Trial version of Enterprise Architect.

### 1.2.2 Editions Available

Enterprise Architect is available in six editions: the **Ultimate**, **Business and Software Engineering**, and **Systems Engineering** 'suite' editions, and the **Corporate**, **Professional**, and **Desktop** editions.

Functionality for each edition is described below; the features of and differences between the editions are listed in the table provided on the [Sparx Systems website](#).



**Tip:**

To help you understand the differences between these editions and the advantages and limitations of each, the [Trial version](#) of Enterprise Architect can be opened in any required configuration. When Enterprise Architect starts, select the mode to trial; you can close down Enterprise Architect and restart it in another mode for comparison.

The fully functional 30 day trial version of Enterprise Architect is available free of charge at [www.sparxsystems.com/bin/easetup.exe](http://www.sparxsystems.com/bin/easetup.exe).



### Ultimate Edition

The Ultimate edition is designed for power users and those working across multiple domains, providing deep support for Business, for Software Engineering and for Systems Development seamlessly integrated into a single development environment. It enables you to drill down to the lowest levels of systems design and construction, with SysML and executable code generation for standard and hardware description languages. Business users can leverage BPEL, the Rules Composer and executable UML, in addition to all the advanced features of the other editions of Enterprise Architect. Software developers can integrate their Eclipse and Visual Studio projects with their UML models and leverage the advanced executable code generators to target different domains.

This edition enables end to end traceability throughout a global vision of your enterprise - unifying strategy, business process, interfaces, software, rules, data and fine grained systems. Powerful tools, domain-specific technologies, frameworks, integration platforms and a consistent, scalable, and robust interface work in unison to help you deliver on the promise of Model Driven Development.

As explained above, the Ultimate edition incorporates a number of [MDG Technologies](#) and Add-Ins. The Ultimate edition and MDG Technologies are all available in either Fixed License or Floating License form. The Floating License arrangement is particularly useful for companies that manage a central store of license keys, which can be used by different employees over time, temporarily or permanently.

The Ultimate edition provides:

- Executable Code Generation - support for generating functional source code for State Machines, Interactions and Activities in C, C++, C#, Java and VBNet
- Full round trip support for Hardware Description Languages (Verilog, VHDL and SystemC) including support for generating State Machine code
- SysML Simulation Support - including support for simulating SysML 1.1 constraint models with results graphing capabilities
- BPEL Generation – transform BPMN 1.1 Business process models down to BPEL 1.1 code
- Business Rules – trace from abstract business rules down to automatically generated behavioral code.



### Business and Software Engineering Edition

The Business and Software Engineering edition is aimed at software development professionals, business modelers, architects, requirements experts, project managers and others involved in the design and construction of quality software and business services. It combines powerful new features such as executable code generation from UML models, BPEL, advanced scripting and a multi-purpose Rules Composer targeting executable code from Business Domain models, and bundles licenses for integration products and frameworks such as DoDAF-MODAF, TOGAF and Zachman, to provide advanced model-driven construction tools to tightly bind your code development in Eclipse or Visual Studio.

As explained above, the Business and Software Engineering edition incorporates a number of [MDG Technologies](#) and Add-Ins. The Business and Software Engineering edition and MDG Technologies are all available in either Fixed License or Floating License form. The Floating License arrangement is particularly useful for companies that manage a central store of license keys, which can be used by different employees over time, temporarily or permanently.

The Business and Software Engineering edition provides:

- Generation of Behavioral Code from State, Sequence and Activity models, supporting standard programming languages such as Java and .NET
- Advanced math functions within the scripting engine
- BPEL Generation from BPMN 1.1 models - including validation and WSDL support
- A Business Rules Composer that enables you to build Business Domain models and generate code to implement complex business rules in standard programming languages.



### Systems Engineering Edition

The Systems Engineering edition is designed for systems and software development professionals working on real-time, embedded and systems solutions. It combines new features such as executable code generation from UML models (including support for hardware languages such as Verilog and VHDL), Ada, SysML 1.1, executable SysML Parametric diagrams and advanced scripting, and bundles licenses for DoDAF-MODAF, SysML, DDS, TcSE and integration products to provide powerful model-driven construction tools for the Systems Engineering domain to tightly bind your code development in Eclipse or Visual Studio with the UML/SysML models developed in Enterprise Architect.

As explained above, the Systems Engineering edition incorporates a number of [MDG Technologies](#) and Add-Ins. The Systems Engineering edition and MDG Technologies are all available in either Fixed License or Floating License form. The Floating License arrangement is particularly useful for companies that manage a central store of license keys, which can be used by different employees over time, temporarily or permanently.

This edition provides:

- Executable Code Generation - support for generating functional source code for State Machines, Interactions and Activities in C, C++, C#, Java and VBNet
- Full round trip support for Hardware Description Languages, including Verilog, VHDL and SystemC, with support for generating State Machine code
- SysML Simulation Support - Includes support for simulating SysML 1.1 constraint models with results graphing capabilities.



### Corporate Edition

Aimed at larger development teams, the Corporate edition enables you to connect to the following DBMS back ends as the shared repository: MySQL, SQL Server, PostgreSQL, Sybase Adaptive Server Anywhere, Access 2007 and Oracle 9i, 10g or 11g. This provides additional scalability and improved concurrency over the shared .EAP file approach to model sharing. User security, user logins, user groups and user level locking of elements, user/group based security (with locking at diagram and element levels) are also supported. Security comes in two modes: in the first mode, all elements are considered 'writeable' until explicitly locked by a user or group; in the second mode, all elements are considered locked until checked out with a user lock.

The Corporate edition forms the base for the three extended editions described above. Like those editions, it is available in either Fixed License or Floating License form. The Floating License arrangement is particularly useful for companies that manage a central store of license keys, which can be used by different employees over time, temporarily or permanently.



### Professional Edition

Aimed at work groups and developers, the Professional edition supports shared projects through replication and shared network files. This edition has an ActiveX interface for interrogating Enterprise Architect projects and extracting information in XML format. The Professional edition fully supports code import/export and synchronization of model elements with source code. It enables reverse engineering of SQL Server; MS Access 97, 2000 and 2003; and Oracle 9i, 10g or 11g databases. Support for MDG Technologies and MDG Link (sold separately) is included with the Professional version of Enterprise Architect. The shared repository available in the Professional edition is restricted to the .EAP file format (JET database).



### Desktop Edition

The Desktop edition is targeted at single analysts and developers producing UML analysis and design models. It provides facilities for UML modeling, XML import/export, document generation, version control integration and profile/metamodel extensibility.

## 1.2.3 The Read-only 'Lite' Edition

*Enterprise Architect Lite* is a **free, read-only** edition of Enterprise Architect that enables people such as project sponsors to review the project without making any changes.

However, users of Enterprise Architect Lite also have wider access to:

- The [Team Review](#)<sup>[208]</sup>, where readers can create and respond to posts, and link their comments to elements
- The [Source Code Viewer](#)<sup>[144]</sup>, where readers can open and edit external source code files, debug code, and configure and run package build scripts
- The [File](#)<sup>[56]</sup> menu, where readers can copy the project or create a shortcut to access it
- The [Relationship Matrix](#), where readers can [export the matrix contents](#)<sup>[126]</sup> to a CSV file to be opened in a spreadsheet application
- The [Default Hours](#)<sup>[340]</sup> tab to review project metrics.

You can download the Enterprise Architect Lite edition (as the *Enterprise Architect Viewer*) from the Sparx Systems website at <http://www.sparxsystems.com/products/ea/downloads.html>.

### Other Read-Only Options

You can also make your model available to others in a read-only format by:

- Running Enterprise Architect over a VPN connection
- Generating an [HTML report](#)<sup>[164]</sup> on the model, which can be published on the web with read-only access.

## 1.3 Formal Statements



Please take the time to read the following legal statements concerning Sparx Systems Enterprise Architect:

- [Software Copyright Notice](#)<sup>[16]</sup>
- [Enterprise Architect End User Licensing Agreement](#)<sup>[16]</sup>
- [Acknowledgement of Trademarks](#)<sup>[19]</sup>

Sparx Systems would also like to gratefully [acknowledge contributions](#)<sup>[20]</sup> to the development of Enterprise Architect.

### 1.3.1 Copyright Notice

#### Copyright © 1998 - 2010 Sparx Systems Pty. Ltd. All rights reserved.

The software contains proprietary information of Sparx Systems Pty Ltd. It is provided under a license agreement containing restrictions on use and disclosure and is also protected by copyright law. Reverse engineering of the software is prohibited. Please read the [license agreement](#)<sup>[16]</sup> for full details.

Due to continued product development, this information can change without notice. The information and intellectual property contained herein is confidential between Sparx Systems and the client and remains the exclusive property of Sparx Systems. If you find any problems in the documentation, please report them to us in writing. Sparx Systems does not warrant that this document is error-free. No part of this publication may be reproduced, stored in a retrieval system, or transmitted in any form or by any means, electronic, mechanical, photocopying, recording or otherwise without the prior written permission of Sparx Systems. Licensed users are granted the right to print a single hardcopy of the user manual per licensed copy of the software, but may not sell, distribute or otherwise dispose of the hardcopy without written consent of Sparx Systems.

#### **Sparx Systems Pty. Ltd.**

7 Curtis St,  
Creswick, Victoria 3363,  
AUSTRALIA

Phone: +61 (3) 5345 1140  
Fax: +61 (3) 5345 1104

Support Email: [support@sparxsystems.com](mailto:support@sparxsystems.com)  
Sales Email: [sales@sparxsystems.com](mailto:sales@sparxsystems.com)

Website: [www.sparxsystems.com](http://www.sparxsystems.com)

#### **Scintilla and SciTE**

**Copyright 1998-2003 by Neil Hodgson <[neilh@scintilla.org](mailto:neilh@scintilla.org)> All Rights Reserved.**

Permission to use and distribute this (Scintilla) software and its documentation for any purpose and without fee is hereby granted, provided that the above copyright notice appears in all copies and that both that copyright notice and this permission notice appear in supporting documentation.

### 1.3.2 End User License Agreement

**Enterprise Architect Modeling Tool Version 8.0**

**Desktop, Professional, Corporate, Business and Software Engineering, Systems Engineering & Ultimate Editions**

**Copyright (C) 1998-2010 Sparx Systems Pty Ltd. All Rights Reserved**

**IMPORTANT- READ CAREFULLY:** This End User License Agreement ("EULA") is a legal agreement between YOU as Licensee and SPARX SYSTEMS ("SPARX") for the SOFTWARE PRODUCT identified

above. By installing, copying, or otherwise using the SOFTWARE PRODUCT, YOU agree to be bound by the terms of this EULA. If YOU do not agree to the terms of this EULA, promptly return the unused SOFTWARE PRODUCT to the place of purchase for a full refund.

The copyright in the SOFTWARE PRODUCT and its documentation is owned by Sparx Systems Pty Ltd A.C.N 085 034 546. Subject to the terms of this EULA, YOU are granted a non-exclusive right for the duration of the EULA to use the SOFTWARE PRODUCT. YOU do not acquire ownership of copyright or other intellectual property rights in any part of the SOFTWARE PRODUCT by virtue of this EULA.

Your use of this software indicates your acceptance of this EULA and warranty.

## DEFINITIONS

In this End User License Agreement, unless the contrary intention appears:

- "ACADEMIC EDITION" means an edition of the SOFTWARE PRODUCT purchased for educational purposes at an academic discount price.
- "EULA" means this End User License Agreement.
- "SPARX" means Sparx Systems Pty Ltd A.C.N 085 034 546.
- "Licensee" means YOU, or the organization (if any) on whose behalf YOU are taking the EULA.
- "Registered Edition of Enterprise Architect" means the edition of the SOFTWARE PRODUCT which is available for purchase from the web site: [http://www.sparxsystems.com/ea\\_purchase.htm](http://www.sparxsystems.com/ea_purchase.htm).
- "SOFTWARE PRODUCT" or "SOFTWARE" means Enterprise Architect, UML Case Tool, Desk Top, Professional, Corporate, Business and Software Engineering, Systems Engineering and Ultimate editions, which includes computer software and associated media and printed materials, and may include online or electronic documentation.
- "Support Services" means email based support provided by SPARX, including advice on usage of Enterprise Architect, investigation of bugs, fixes, repairs of models if and when appropriate, and general product support.
- "SPARX support engineers" means employees of SPARX who provide on-line support services.
- "Trial edition of Enterprise Architect" means the edition of the SOFTWARE PRODUCT which is available free of charge for evaluation purposes for a period of thirty (30) days.
- "EA LITE" means the LITE version of Enterprise Architect that is distributed free of charge as a read-only viewer of .EAP files.

## GRANT OF LICENSE

In accordance with the terms of this EULA YOU are granted the following rights:

- a) To install and use one copy of the SOFTWARE PRODUCT or, in its place, any prior version for the same operating system, on a single computer. As the primary user of the computer on which the SOFTWARE PRODUCT is installed, YOU may make a second copy for your exclusive use on either a home or portable computer.
- b) To store or install a copy of the SOFTWARE PRODUCT on a storage device, such as a network server, used only to install or run the SOFTWARE PRODUCT over an internal network. If YOU want to increase the number of users entitled to concurrently access the SOFTWARE PRODUCT, YOU must notify SPARX and agree to pay an additional fee.
- c) To make copies of the SOFTWARE PRODUCT for backup and archival purposes only.

## EVALUATION LICENSE

The Trial version of Enterprise Architect is not free software. Subject to the terms of this agreement, YOU are hereby licensed to use this software for evaluation purposes without charge for a period of thirty (30) days.

Upon expiration of the thirty (30) days, the SOFTWARE PRODUCT must be removed from the computer. Unregistered use of Enterprise Architect after the 30-day evaluation period is in violation of Australian, U.S. and international copyright laws.

SPARX may extend the evaluation period on request and at their discretion.

If YOU choose to use this software after the 30 day evaluation period a license must be purchased (as described at [http://www.sparxsystems.com/ea\\_purchase.htm](http://www.sparxsystems.com/ea_purchase.htm)). Upon payment of the license fee, YOU will be sent details on where to download the registered edition of Enterprise Architect and will be provided with a suitable software 'key' by email.

## EA LITE

Subject to the terms of this Agreement [EA LITE](#)<sup>15)</sup> may be installed on any machine indefinitely and free of charge. There are no fees or Sparx support services in relation to EA LITE.

## ADDITIONAL RIGHTS AND LIMITATIONS

YOU hereby undertake not to sell, rent, lease, translate, adapt, vary, modify, decompile, disassemble, reverse engineer, create derivative works of, modify, sub-license, loan or distribute the SOFTWARE PRODUCT other than as expressly authorized by this EULA.

YOU further undertake not to reproduce or distribute license key-codes except under the express and written permission of SPARX.

If the Software Product purchased is an Academic Edition, YOU ACKNOWLEDGE THAT the license is limited to use in an educational context, either for self-education or use in a registered teaching institution. The Academic Edition may not be used to produce commercial software products or be used in a commercial environment, without the express written permission of SPARX.

## ASSIGNMENT

YOU may only assign all your rights and obligations under this EULA to another party if YOU supply to the transferee a copy of this EULA and all other documentation including proof of ownership. Your license is then terminated.

## TERMINATION

Without prejudice to any other rights, SPARX may terminate this EULA if YOU fail to comply with the terms and conditions. Upon termination YOU or YOUR representative shall destroy all copies of the SOFTWARE PRODUCT and all of its component parts or otherwise return or dispose of such material in the manner directed by SPARX.

## WARRANTIES AND LIABILITY

### WARRANTIES

SPARX warrants that the SOFTWARE PRODUCT will perform substantially in accordance with the accompanying written materials for a period of ninety (90) days from the date of receipt, and any Support Services provided by SPARX shall be substantially as described in applicable written materials provided to YOU by SPARX, and SPARX support engineers will make commercially reasonable efforts to solve any problems associated with the SOFTWARE PRODUCT.

### EXCLUSIONS

To the maximum extent permitted by law, SPARX excludes, for itself and for any supplier of software incorporated in the SOFTWARE PRODUCT, all liability for all claims, expenses, losses, damages and costs made against or incurred or suffered by YOU directly or indirectly (including without limitation lost costs, profits and data) arising out of:

- YOUR use or misuse of the SOFTWARE PRODUCT
- YOUR inability to use or obtain access to the SOFTWARE PRODUCT
- Negligence of SPARX or its employees, contractors or agents, or of any supplier of software incorporated in the SOFTWARE PRODUCT, in connection with the performance of SPARX' obligations under this EULA, or
- Termination of this EULA by either party for any reason.

### LIMITATION

The SOFTWARE PRODUCT and any documentation are provided "AS IS" and all warranties whether express, implied, statutory or otherwise, relating in any way to the subject matter of this EULA or to this EULA generally, including without limitation, warranties as to: quality, fitness; merchantability; correctness; accuracy; reliability; correspondence with any description or sample, meeting your or any other requirements; uninterrupted use; compliance with any relevant legislation and being error or virus free are excluded. Where any legislation implies in this EULA any term, and that legislation avoids or prohibits provisions in a contract excluding or modifying such a term, such term shall be deemed to be included in this EULA. However, the liability of SPARX for any breach of such term shall if permitted by legislation be limited, at SPARX's option to any one or more of the following upon return of the SOFTWARE PRODUCT and a copy of the receipt:

- If the breach relates to the SOFTWARE PRODUCT:

- the replacement of the SOFTWARE PRODUCT or the supply of an equivalent SOFTWARE PRODUCT
- the repair of such SOFTWARE PRODUCT
- the payment of the cost of replacing the SOFTWARE PRODUCT or of acquiring an equivalent SOFTWARE PRODUCT, or
- the payment of the cost of having the SOFTWARE PRODUCT repaired.
- If the breach relates to services in relation to the SOFTWARE PRODUCT:
  - the supplying of the services again, or
  - the payment of the cost of having the services supplied again.

## TRADEMARKS

All names of products and companies used in this EULA, the SOFTWARE PRODUCT, or the enclosed documentation may be trademarks of their corresponding owners. Their use in this EULA is intended to be in compliance with the respective guidelines and licenses.

Windows®, Windows 98, Windows NT, Windows ME, Windows XP, Windows Vista, Windows 2000 and Windows 2003 Server are trademarks of Microsoft®.

## GOVERNING LAW

This agreement shall be construed in accordance with the laws of the Commonwealth of AUSTRALIA, in the state of Victoria.

### 1.3.3 Trademarks

#### Trademarks of Microsoft

- Microsoft Word
- Microsoft Office
- Windows®
- ActiveX

#### Registered Trademarks of The OMG

- CORBA®
- the OMG Object Management Group logo
- The Information Brokerage®
- CORBA Academy®
- IOP®
- XMI®
- UML®
- The UML Cube logo

#### Trademarks of The OMG

- OMG™
- Object Management Group™
- The CORBA logo
- ORB™
- Object Request Broker™
- The CORBA Academy design
- OMG Interface Definition Language™
- IDL™
- CORBAservices™
- CORBAfacilities™
- CORBAmed™
- CORBAnet™
- Unified Modeling Language™
- MOF™

- CWM™
- Model Driven Architecture™
- MDA™
- OMG Model Driven Architecture™
- OMG MDA™

### 1.3.4 Acknowledgements

Some parts of this application include code originally written by various authors and modified for use in Enterprise Architect.

#### Marquet Mike

Print listview contents  
[mike.marquet@altavista.net](mailto:mike.marquet@altavista.net)

#### Davide Pizzolato

CXImage Library  
© 7-Aug-2001  
[ing.davide.pizzolato@libero.it](mailto:ing.davide.pizzolato@libero.it)

#### Neil Hodgson

Scintilla editor  
© 1998-2003  
[neilh@scintilla.org](mailto:neilh@scintilla.org)

Also, many thanks to all those who have made suggestions, reported bugs, offered feedback and helped with the beta-testing of Enterprise Architect. Your help has been invaluable.



## 1.4 Installation

Enterprise Architect is distributed as a single executable setup file (.exe). After you execute this file, Enterprise Architect is immediately available to create projects as .EAP files.

If you plan to use the Corporate, Business and Software Engineering, Systems Engineering or Ultimate edition with SQL Server, MySQL, PostgreSQL, Access 2007, Sybase Adaptive Server Anywhere or Oracle 9i, 10g or 11g as a model repository (see below), you require additional files and supplementary installation processes. Please note that installation and maintenance of these database management systems is not covered under the support agreement.

The latest evaluation and registered versions of Enterprise Architect are always available from the [Sparx Systems](#) website. The registered version is available through the registered user area of the web site, which requires a username and password to access. These are provided upon purchase of a license.

### System Requirements

The system requirements for installing Enterprise Architect are defined on the [Enterprise Architect | System Requirements](#) page of the Sparx Systems website.

#### Windows Vista

Under Windows Vista (with User Account Control turned on) an application starts with only Standard permissions, regardless of what level of authority the current user has. As a result, an installer run normally with an Admin account under Vista only has Standard privileges and either is not able to write to certain critical areas of the registry/file system, or redirects the write requests to a per-user virtualized registry/file system.

Sparx Systems recommend that if you are installing on Windows Vista, always run the Enterprise Architect installer with Administrator privileges (right-click on the downloaded installer icon and select the **Run as administrator** menu option).

### Install Enterprise Architect

Run the Enterprise Architect setup program. Generally you can accept all the default options without change.

To place Enterprise Architect in a directory other than the default, enter the name of the destination when prompted.

You might be prompted to restart your computer when the installation completes. Although this is not always necessary (if you already have the components Enterprise Architect requires installed on your computer), you should restart just to be certain.

If you intend to run Enterprise Architect on Linux, refer to the [Installation and Use](#) page on the Sparx Systems website. To support the Scripting facility in the Corporate and extended editions of Enterprise Architect, you must also install Internet Explorer 6.0 or later revisions.

Corporate, Business and Software Engineering, Systems Engineering and Ultimate edition users planning to use SQL Server, MySQL, PostgreSQL, Sybase Adaptive Server Anywhere, Access 2007 or Oracle 9i, 10g or 11g as their model repository can access scripts that create the required data structures for the choice of DBMS. You can find these at one of the following pages:

- The Corporate edition [Resources](#) page
- The Trial Corporate edition [Resources](#) page.

#### Note:

Enterprise Architect requires *Read/Write* access to the program files directory where Enterprise Architect has been installed.

## 1.5 Register a Full License

The trial version of Enterprise Architect available for download is an evaluation version only. For the full version you must first purchase one or more *licenses*.

The license supplied determines which edition (Enterprise Architect Desktop, Professional, Corporate, Business and Software Engineering, System Engineering or Ultimate) is activated after installation.

The Corporate, Business and Software Engineering, System Engineering and Ultimate editions can be activated by either a private license key or a shared (floating) license key. Shared license keys, for a user population that includes temporary users, are checked out of and in to a Sparx Systems keystore.

Private license keys and shared license keys have different formats, so you cannot use one in place of the other.

### Register Enterprise Architect

To obtain the full version and complete the registration process, follow the steps below:

1. Purchase one or more licenses.

Once you have paid for a licensed version of Enterprise Architect, you receive (via email or other suitable means):

- a license key or keys
- the address of a web site from which to download the full version
- if you have purchased a Sparx Systems key store, the address of a web site from which to download the keystore.

2. Save the license key(s) and download the latest full install package from the address supplied.
3. Run the setup program to install the full version.
4. Open Enterprise Architect from the **Start Menu** or desktop icon. The **License Management** dialog displays.

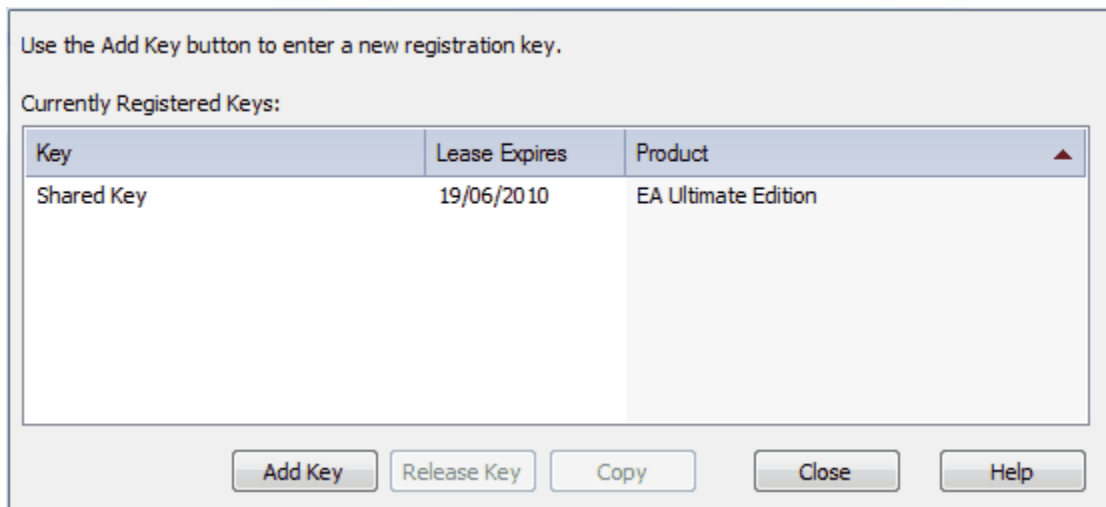

5. Click on the **Add Key** button. The **Add Registration Key** dialog displays.
6. Refer to the [Add License Key](#)<sup>[1870]</sup> topic.
7. Click on the **OK** button. The full version is now activated on your PC, and Enterprise Architect displays the message: *Registration succeeded! Thank you for purchasing Enterprise Architect <type> Edition.*

**See Also** (in *Project Development in Enterprise Architect*):

- [Upgrade an Existing License](#)<sup>[1873]</sup>
- [Register Add-In](#)<sup>[1876]</sup>

## 1.6 Help and Support

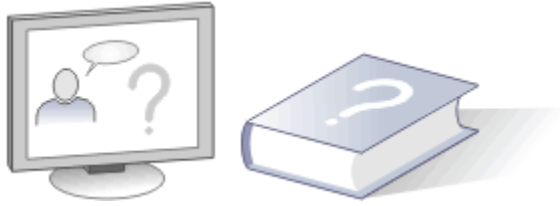

Enterprise Architect has three main help and information systems to assist you in using the product:

- **Tasks Pane**
- Enterprise Architect Help
- The Sparx Systems website.

In addition Sparx Systems recommend that you fully explore the sample project, *EAExample*, supplied with Enterprise Architect. This assists you in learning to use Enterprise Architect and offers tips on getting the most out of Enterprise Architect's features. Click on the **EAExample** option on the Enterprise Architect [Start Page](#) <sup>[50]</sup>.

If you have purchased Enterprise Architect and are a registered user, you can also contact [Sparx Support](#) <sup>[24]</sup> to answer any queries or problems.

### Tasks Pane

The Enterprise Architect [Tasks Pane](#) <sup>[51]</sup> provides context-sensitive guidance, tools, demonstrations and other online resources to help you understand any area of Enterprise Architect that you are interested in. The **Tasks Pane** automatically displays on the right of the screen when you first open Enterprise Architect, showing the *Getting Started* topics. You can select other task areas by clicking on the **More tasks** option in the toolbar.

### Enterprise Architect Help

Enterprise Architect Help provides comprehensive documentation of Enterprise Architect and covers every aspect and facility of the product. To access Help within Enterprise Architect, either:

- Click on the Help icon ( ? ) in the various toolbars
- Select the **Help | Help Contents** menu option, or
- Click on the **Help** button on a dialog (for Help specific to that dialog).

Enterprise Architect Help is extensive; if you cannot quickly locate the topic you require in the online contents list, you can use one of two search facilities:

- Click on the **Index** tab, type in a keyword or key phrase appropriate to the subject you require help for, and press **[Enter]**; double-click on the appropriate index item
- Click on the **Search** tab, type in a word or phrase to search for, and click on the **List Topics** button; double-click on the required topic.

The Enterprise Architect Help is also available separately from the product, in different formats. See the [Available Helpfile Formats](#) <sup>[24]</sup> topic.

### Sparx Systems Website

The Sparx Systems website is also extensive, and provides information and announcements concerning the company and its full range of products, as well as tutorials, white papers, templates and solutions. It also provides a user forum, community site (see below) and support network; Sparx Systems are highly responsive to user feedback and requirements, and the web site enables rapid communication concerning problems, solutions and enhancements.

You can access the web page and user forum within Enterprise Architect from the **View | Other Project Tools | Internal Web Browser** menu option, and through the **Online Resources** topics in the **Tasks Pane**.

If you do not have Enterprise Architect open, the Sparx Systems website address is <http://www.sparxsystems.com/>.

The user forum address is [www.sparxsystems.com/cgi-bin/yabb/YaBB.cgi](http://www.sparxsystems.com/cgi-bin/yabb/YaBB.cgi).

## Community Site

The Sparx Systems website also hosts the [Sparx Systems Enterprise Architect Community Site](#). This is a central location for the Enterprise Architect community to publish resources and share experiences.

From this site you can download the latest news, tutorials, resources, best practices, tips, techniques and user-generated content for Enterprise Architect. You can also, as a registered author, contribute content and share your expertise with the wider community.

### 1.6.1 Available Helpfile Formats

You can access the latest Enterprise Architect help files from the following locations:

- **.CHM** format: [www.sparxsystems.com/bin/EA.chm](http://www.sparxsystems.com/bin/EA.chm)
- **.CHM** format inside a **.ZIP** file: [www.sparxsystems.com/bin/EAHelp.zip](http://www.sparxsystems.com/bin/EAHelp.zip)
- **.PDF** format: [www.sparxsystems.com/bin/EAUserGuide.pdf](http://www.sparxsystems.com/bin/EAUserGuide.pdf)
- **.HTML** format: [www.sparxsystems.com/EAUserGuide/index.html](http://www.sparxsystems.com/EAUserGuide/index.html)

Version and release date information for the help files can be found at:

- [www.sparxsystems.com/ea\\_downloads.htm#Helpfiles](http://www.sparxsystems.com/ea_downloads.htm#Helpfiles), or
- [www.sparxsystems.com/registered/reg\\_ea\\_down.htm#Helpfiles](http://www.sparxsystems.com/registered/reg_ea_down.htm#Helpfiles) (registered users).

### 1.6.2 Support

Technical support for Enterprise Architect is available to registered users.

Responses to support queries are sent by email. Sparx Systems endeavors to provide a rapid response to all product-related questions or concerns.

Registered users can lodge a support request, by visiting:  
[http://www.sparxsystems.com/registered/reg\\_support.html](http://www.sparxsystems.com/registered/reg_support.html).

Trial users can contact Sparx Systems with questions regarding their evaluation at:  
[support@sparxsystems.com](mailto:support@sparxsystems.com).

An online user forum is also available for your questions and perusal, at  
<http://www.sparxsystems.com/cgi-bin/yabb/YaBB.cgi>.

**Part**

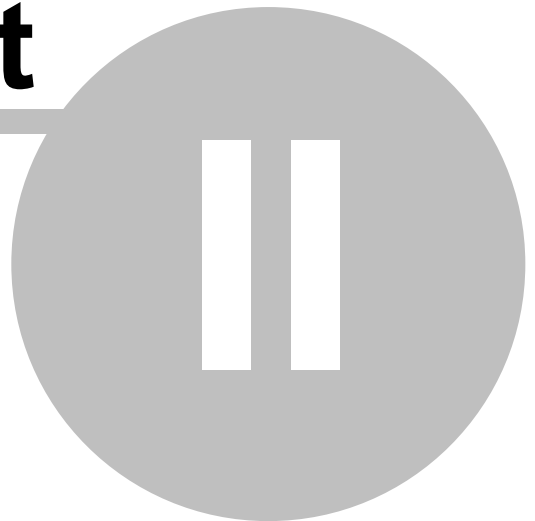

## 2 Getting Started

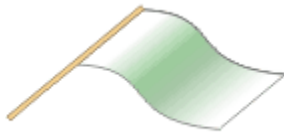

This guide helps you understand the options available when you [start Enterprise Architect](#)<sup>[27]</sup>, and to quickly gain an understanding of how to use these options to create models.

After starting Enterprise Architect, use the [Quick Start](#)<sup>[28]</sup> tutorial to immediately create a project.

The tutorial leads on to examining:

- Work areas applicable to certain [Project Roles](#)<sup>[37]</sup> and
- The [Enterprise Architect User Interface](#)<sup>[48]</sup>, or *workspace*.

At various points throughout the Enterprise Architect Help, there are further Quick Start topics and sections to help you use the system immediately to experiment with a feature of Enterprise Architect. Use the Help [Index](#) tab and search for *Quick Start* to locate these topics.

## 2.1 Basics



When you install Enterprise Architect on your computer, a new program folder called *Enterprise Architect* is created in your **Start** menu (unless you changed the default name during installation).

### Start Enterprise Architect

You can start Enterprise Architect from the icon created on your Windows desktop during installation, or alternatively:

1. Open the Windows **Start** menu.
2. Locate the Enterprise Architect program folder.
3. Select **Enterprise Architect**.

After a short pause, the [Start Page](#)<sup>[50]</sup> displays. From this page you can:

- [Open a project file](#)<sup>[114]</sup> (.EAP file)
- [Create a new project](#)<sup>[120]</sup> (.EAP file)
- [Connect to a DBMS repository](#)<sup>[147]</sup> (Corporate and extended editions).

#### Note:

By default, when you install Enterprise Architect, an empty 'starter' project called 'EABase.EAP' is installed, as well as an example project named 'EAExample.EAP'. We recommend that new users select the 'EAExample' file and explore it in some detail while you become familiar with UML and software engineering using Enterprise Architect.

To begin a guided exploration of Enterprise Architect immediately, go to the [A Quick Start Tutorial](#)<sup>[28]</sup> topic.

## 2.2 A Quickstart Tutorial



### Tutorial

Welcome to Enterprise Architect! This quick-start tutorial helps you start UML modeling with Enterprise Architect.

As you read through the Quick Start sections, have Enterprise Architect open so that you can explore and try out the functions described. By the end of the Quick Start tutorial you should be able to begin modeling your own software projects with Enterprise Architect and UML.

The tutorial guides you through creating a simple project. Throughout the descriptions there are hyperlinks to more detailed information on a range of topics. Follow these links if you would like more information, or ignore them if you want to just follow the steps.

Your task is to create a new [project](#)<sup>[113]</sup> and then add a View, a package, a diagram, elements and connectors.

### Create a Project

When you start Enterprise Architect it opens at the [Start Page](#)<sup>[50]</sup>:

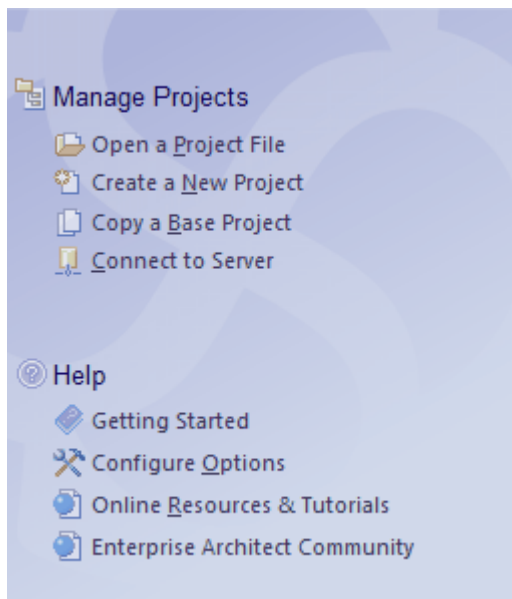

1. Click on the **Create a New Project** option. The **New Project** dialog displays.
2. In the **File name** field, type a meaningful name for the project and click on the **Save** button to create the project file. The [Select Model\(s\)](#)<sup>[372]</sup> dialog displays.
3. You now select one or more [model templates](#)<sup>[373]</sup> (these provide you with the basic structures - packages and diagrams - for your project, as well as references to useful help files to get you started). Select the checkbox of each model that interests you.
4. Click on the **OK** button. Enterprise Architect creates a Model Package for each selected template and displays it in the [Project Browser](#)<sup>[1203]</sup>, on the right-hand side of the screen.



**Note:**

You could also quickly create a project by copying an existing base project provided with Enterprise Architect; see the [Copy a Base Project](#)<sup>[127]</sup> topic.

## Expand The Project

To navigate through your project, in the **Project Browser** click on the 'plus' icon against each folder or *package* to expand it.

Double-click on the *diagram* icon displayed underneath a package name. Enterprise Architect displays the sample diagram for that model in the **Diagram View**<sup>[396]</sup>, which is in the middle of the screen.

## Add a View To Your Model

Now that you have created a project containing at least one model, you can add a **View**<sup>[297]</sup> to the model, and then add a package with diagram, elements and connectors (relationships).

### 2.2.1 Add a View to a Model

A **View**<sup>[383]</sup> is the highest-level container, or package, within a model.

There are six types of View, five of which represent conventional ways of categorizing the structures or purposes of a model, and one (*Simple View*) for developing your own categorization.

To create a View, follow the steps below:

1. Right-click on your model name in the **Project Browser**. The context menu displays.
2. Select the **New View** menu option. The **Create New View** dialog displays.

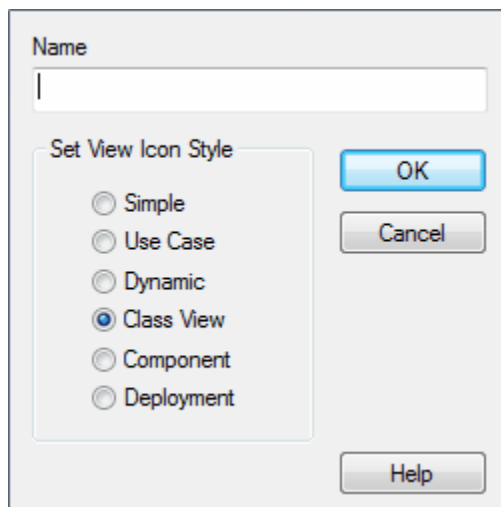

3. In the **Name** field, type the name of the View.
4. In the **Set View Icon Style** panel, click on the radio button for the type of View to create.
5. If the model root node had been under [version control](#)<sup>[228]</sup>, an **Add to Version Control** checkbox would display, defaulted to selected. Ignore this for now.
6. Click on the **OK** button.

## Add a Package To Your Model

Now that you have created a View in the model, you can add a **package**<sup>[307]</sup> and diagram to that View or any other in the model, and then add elements and connectors (relationships).

## 2.2.2 Add a Package To a Model

A *Package* is a container of model elements, and is displayed in the **Project Browser** as the 'folder' icon familiar to Windows users. Package contents are arranged alphabetically.

In the **Project Browser** click on a package and, in the **Project Browser** toolbar, click on the **New Package** icon



Enterprise Architect displays a prompt for the package name.

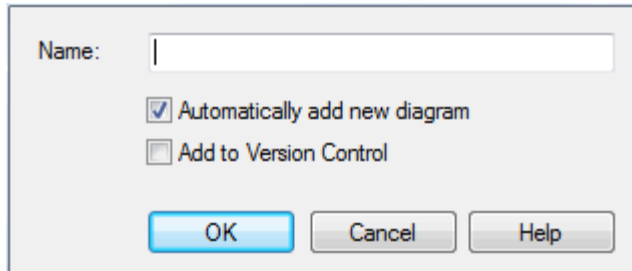

### Note:

This prompt also contains the **Automatically add new diagram** option for automatically creating a diagram for the package, which defaults to selected. This is very a useful feature, but for the purposes of this introduction deselect the checkbox against the option.

Type in a name and click on the **OK** button. Enterprise Architect adds the new package subordinate to the package you selected.

## Add a Diagram To a Package

Now [add a diagram](#)<sup>[30]</sup>.

### Additional Information

For additional information on packages, and adding packages and Views (top-level packages), see the [Packages](#)<sup>[387]</sup>, [Add a Package](#)<sup>[387]</sup> and [Add Views](#)<sup>[383]</sup> topics.

## 2.2.3 Add a Diagram to a Package

A diagram is a representation of the components or elements of your model and, depending on the type of diagram, how those elements are connected or how they interact.

When you first create a project, Enterprise Architect provides simple examples of diagrams appropriate to your selected model patterns, with annotations. You can edit these diagrams, but here we create a new one.

Click on your new package and, in the **Project Browser** toolbar, click on the **New Diagram** icon .

The **New Diagram** dialog displays.

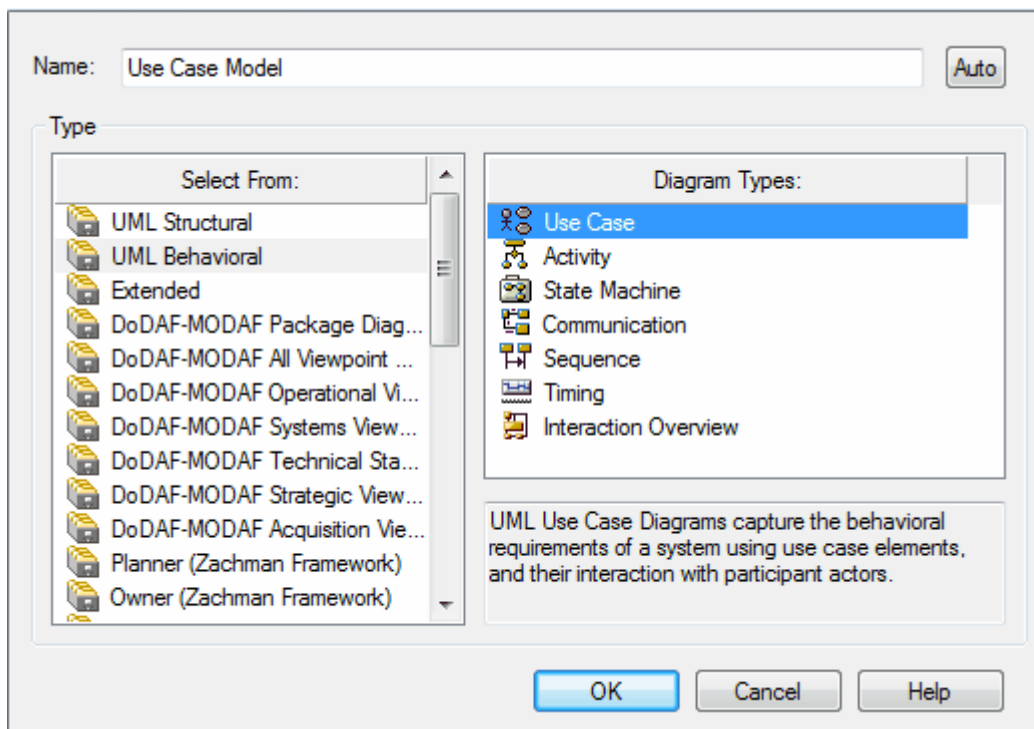
**Note:**

When you create a package, if you leave the **Automatically add new diagram** option selected, the **New Diagram** dialog displays automatically.

Click on a diagram category in the **Select From** panel, and a diagram type in the **Diagram Types** panel, then click on the **OK** button. Enterprise Architect adds a diagram object to the package, with the same name as the package. It also opens the **Diagram View** for your diagram, in the center of the screen.

## Add Elements to a Diagram and a Package

Now [add some elements](#)<sup>[37]</sup>.

### Additional Information

For additional information on diagrams and adding them to a project, see [UML Diagrams](#)<sup>[673]</sup> and [Add New Diagrams](#)<sup>[422]</sup>.

## 2.2.4 Add Elements

You have several options for adding elements (the model building units) to a package and/or diagram.

The simplest method is to use the **Toolbox** to the left of the diagram, which automatically lists the elements applicable to the type of diagram you have created. Just click on the required element and drag it onto your diagram.

Two things might occur before the element displays on the diagram:

- If you have selected an *Object* element, Enterprise Architect prompts you to define what stereotype the object is based on (an object can represent a wide range of things, and a stereotype helps you define what the object or element is); for now, select any value.
- The element [Properties](#)<sup>[33]</sup> dialog displays. If it does not display, double-click on the element on the diagram.

You can use the **Properties** dialog to define the characteristics of the element, such as its name. Type a name in the **Name** field, and click on the **OK** button. Look at the **Project Browser**, underneath the package in which you created the diagram. The element is listed.

**Tip:**

Enterprise Architect has two very useful features:

- To find out more about the type of element you have dragged on to a diagram, right-click on the element and select the **UML Help** menu option. This displays a Help page on the element type.
- If you are creating several elements of one type, after creating the first just press **[Shift]+[F3]** or **[Ctrl]+click** to create the next element of that type.

You can also drag or paste existing elements onto a diagram from the **Project Browser**. This enables you to make use of previous work in defining elements.

## Add Connectors Between Elements

Now [connect the elements](#)<sup>[32]</sup> with relationships.

### Additional Information

When you click on an element on a diagram, a number of icons display outside the top right corner. These are the [Quick Linker](#)<sup>[474]</sup> and [Toolbar](#)<sup>[521]</sup> icons that enable you to quickly add more elements and connectors and to operate on the elements. You can read about and experiment with these later.

For additional information on elements and adding elements to a project, see [UML Elements](#)<sup>[741]</sup>, [Create Elements](#)<sup>[523]</sup> and [Paste From the Project Browser](#)<sup>[430]</sup>.

## 2.2.5 Add Connectors

[Connectors](#)<sup>[852]</sup> define specific relationships between specific elements, so you usually [create them](#)<sup>[610]</sup> directly on the diagram by dragging the required relationship type from the **Toolbox**.

As for elements, the **Toolbox** automatically presents the connector or relationship types appropriate to the type of diagram.

Create two elements on the diagram. Click on a connector in the **Toolbox**, click on the source element in the relationship, then drag across to the target element. This creates the selected connection between the two elements. If you double-click on the connector, the connector [Properties](#)<sup>[33]</sup> dialog displays, and you can define the characteristics of the relationship.

**Tip:**

Enterprise Architect has three very useful features:

- To find out more about the type of connector you have dragged on to a diagram, right-click on the connector and select the **UML Help** menu option. This displays a Help page on the connector type.
- If you are creating several connectors of one type, after creating the first just click on the appropriate source element and press **[F3]** to create the next connector of that type.
- As you drag a connector, you can press **[Shift]** to create a bend in the connector. If necessary, you can put several bends in the connector line, pressing **[Shift]** every time you want to change direction. To roll back the bends, keep holding the left mouse button down and press **[Backspace]** as many times as is necessary.

## Moving and Deleting Elements and Connectors

Having created a model with some components, you can [move](#)<sup>[34]</sup> those components around and [delete](#)<sup>[35]</sup> them. You should also know how to [save](#)<sup>[36]</sup> your work.

### Additional Information

For further information on creating a connector through the **Project Browser**, or with the Quick Linker, see the [Create Connector in Project Browser](#)<sup>[618]</sup> topic and the [Quick Linker - Create Connectors](#)<sup>[476]</sup> topic.

## 2.2.6 Define Properties

When you create an element and connect it to another element, you usually have to define various characteristics of both the element and the connector to identify the purpose and function they represent. You do this using a **Properties** dialog.

Enterprise Architect is initially configured to display the **Properties** dialog automatically when you create an element or connector, but it is easy (and often convenient) to [turn the dialog display off](#)<sup>[48†]</sup>. If the default display has been turned off, you can display the dialog by:

- double-clicking on the element or connector in the diagram or
- right-clicking on it in the **Project Browser** and selecting the **Properties** menu option.

**Properties** dialogs vary between element types and between elements and connectors but, as you saw when you created your first element, they look something like this:

The screenshot shows the 'Properties' dialog for an 'Abstract Factory' class. The dialog has several tabs: General, Details, Requirements, Constraints, Links, Scenarios, Files, and Tagged Values. The 'General' tab is active. The 'Name' field contains 'AbstractFactory'. The 'Stereotype' field is empty, and the 'Abstract' checkbox is checked. The 'Author' field is empty. The 'Scope' is set to 'Public'. The 'Status' is 'Proposed'. The 'Complexity' is 'Easy'. The 'Language' is '<none>'. The 'Phase' is '1.0' and the 'Version' is '1.0'. There is an 'Advanced' button. The 'Notes' field contains the text: 'This **Class** declares an *interface* for operations that create **abstract product** objects.' The dialog has 'OK', 'Cancel', 'Apply', and 'Help' buttons at the bottom.

When you create elements, Enterprise Architect automatically names and numbers them by type - for example, Class1, Class2 - so you should at least change the **Name** field to more easily identify each element.

Enterprise Architect does not automatically name connectors, but for many connector types you should provide a name that describes the purpose of the connection.

See the [Properties Dialog](#)<sup>[48†]</sup> topic and the [Connector Properties](#)<sup>[626†]</sup> topic for a full description of the element and connector **Properties** dialogs.

## 2.2.7 Move Components

You have created a project containing packages, diagrams and elements, and you have connected the elements. You might have arranged your components in the wrong project structure. How do you change where things are?

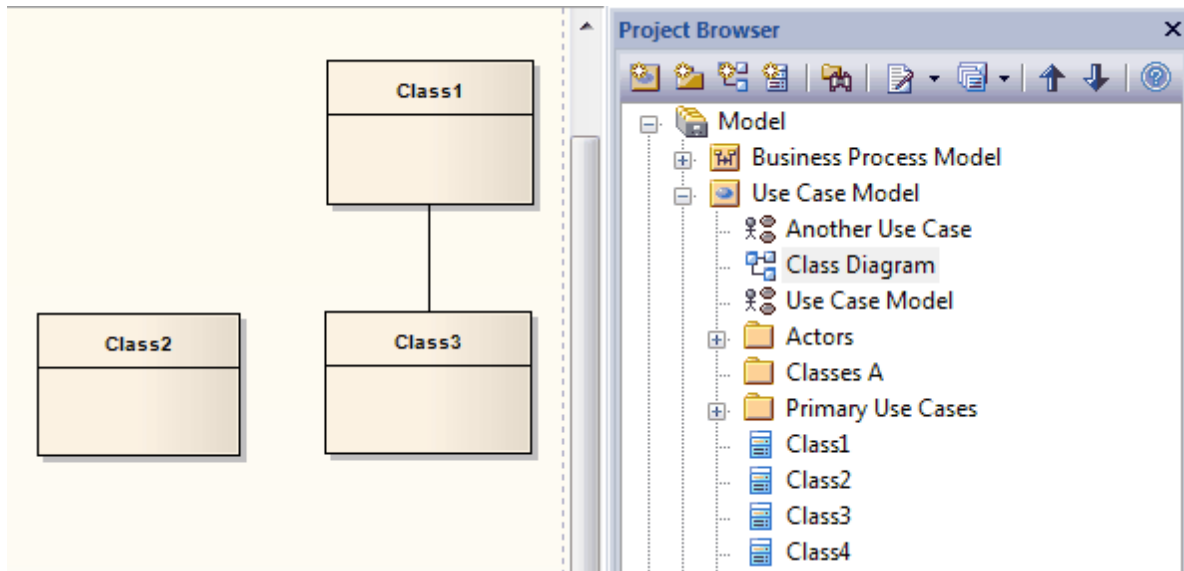

In this topic, the explanations refer to the following example:



### Notes:

- You display and work on your model in the **Project Browser**, and display and work on a diagram in the **Diagram View**.
- In the **Project Browser**, the contents of a package are listed in the order *diagrams | child packages | elements*. Elements are further arranged in type order. Within their types, components are initially listed in alphabetical or numerical order.
- Moving an element or package has no effect on any relationships that the element, package, or elements within the package have. You have to specifically create, delete or move the relationships themselves.

### Move Components Within a Package in the Project Browser

To move a diagram, child package or element within its parent package, click on it in the **Project Browser** and click on  or  in the toolbar at the top of the window.

You could move *Class3* in the **Project Browser** above *Class1*, or move the *Actors* package underneath *Classes A*.

To revert to listing components in alphabetical order, right-click on the package and select the **Contents | Reset Sort Order** menu option.

### Move Components Between Packages in the Project Browser

You might have created a diagram, child package or element in the wrong place in the **Project Browser**. To move a model component to another package, click on the component and drag it to the new package. This can be at either a higher level or a lower level.

You might, for example, drag *Class1* from the *Use Case Model* package into the *Business Process Model* package. *Class1* then is listed in the *Business Process Model* package in the **Project Browser**. As a similar example, you could drag *Class Diagram* into the *Business Process Model* package.

Moving elements in the **Project Browser** does not affect the use of elements in diagrams. In our example, *Class1* is initially in a diagram in the *Use Case Model* package. When you move *Class1* in the **Project Browser** from *Use Case Model* to *Business Process Model*, it still shows in the diagram in *Use Case Model*, and does not display in any diagram in *Business Process Model*.

**Note:**

Moving a diagram generally does not affect the location of elements in packages. If you move the *Class Diagram* out of *Use Case Model* into *Business Process Model*, all the elements in the diagram remain in the *Use Case Model* package.

However, elements of certain types might be used only within one diagram, have no meaning outside that diagram, and never be re-used in any other diagram. Such elements include [Decision](#)<sup>[765]</sup>, [Initial](#)<sup>[778]</sup> and [Final Node](#)<sup>[772]</sup> elements. Therefore, if you move a diagram containing these elements, they **are** moved to the new parent package with the diagram.

To remove *Class1* from the *Use Case Model* diagram, click on it on the diagram and [delete](#)<sup>[35]</sup> it. Nothing happens to the element in the **Project Browser**. To put *Class1* into a diagram in the *Business Process Model* package, open the diagram in that package and drag the element from the *Business Process Model* package in the **Project Browser** onto the diagram.

## Move Elements in a Diagram

If an element is not in the right position in the diagram, just click on the middle of it and drag it to the correct place. In the diagram above, you might move *Class2* below *Class 3*, and move *Class3* to the left. The element brings its connectors with it.

To make fine adjustments, press **[Shift]+[←]**, **[←]**, **[↑]** or **[↓]**.

## Move Elements Between Diagrams

If an element is in the wrong diagram, you can delete it from that diagram and then drag it from the **Project Browser** into the right diagram.

Alternatively, select the element and *cut* it from the source diagram (**[Ctrl]+[X]**, or the **Cut** icon in the **Default Tools** toolbar) and then paste the element (**[Shift]+[Insert]** or the **Paste** icon in the **Default Tools** toolbar) into the target diagram.

You can also copy and paste elements between diagrams. In the source diagram, select the element and press **[Ctrl]+[C]** (or click on the **Copy** icon in the **Default Tools** toolbar), then in the target diagram press **[Shift]+[Insert]** (or click on the **Paste** icon in the **Default Tools** toolbar).

## Move Connectors in a Diagram

You might have connected the wrong pair of elements. To move the end of a connector to a different element (for example, *Class2* instead of *Class3*), click on the end to display a black 'handle' box and drag the end to its new position. Be aware that the connector does not break from the original target element until the cursor is on the new target.

You can also tidy up a connection by dragging the end of the connector to a better position on the edge of the element, or move both ends at once by dragging the middle of the connector.

## Additional Information

See the [Delete Components](#)<sup>[35]</sup> and [Save Changes](#)<sup>[36]</sup> topics.

For additional information on moving connectors and elements, see the [Arrange Connectors](#)<sup>[613]</sup> topic and the [Order Package Contents](#)<sup>[1210]</sup> topic.

### 2.2.8 Delete Components

You can delete the components of a model from a diagram or from the **Project Browser**.

#### Delete From a Diagram

A diagram can contain elements, connectors, packages and other diagrams. To delete any of these from the diagram, click on it and press **[Delete]** on the keyboard.

**Notes:**

- Remember that the contents of the model are listed in the **Project Browser**. If you delete something from a diagram, it is not deleted from the **Project Browser**. This is because you can use the same component in several diagrams at once, so you only remove the representation of the component from a diagram.
- To delete a connector from a diagram, click on it and press **[Delete]**. This time, Enterprise Architect prompts you to select whether to delete the connector or just hide it. Unlike elements, the same connector is not reapplied in several places, so if you delete one it is removed completely from the model.
- Connectors can get confusing on a complex diagram, so it is useful to hide some of them to clarify a specific aspect of a more complex picture. To identify and reveal hidden connectors, see the [Links](#)<sup>[489]</sup> topic.

**Delete From Project Browser**

To delete a package, diagram or element from the **Project Browser**, right-click on the component and select the **Delete <name>** menu option.

For a package, this completely removes the package and all its contents - diagrams, child packages and elements - from the model.

For an element, this completely removes the element and its properties, connectors, child elements and child diagrams from the model, and from every diagram that contains it.

For a diagram, this completely removes the diagram and connectors from the model, but **not** the diagram's component elements. They remain in the parent package.

**Additional Information**

See the [Save Changes](#)<sup>[36]</sup> topic.

For additional information on deleting elements, connectors and model views in Enterprise Architect, see the [Delete Elements](#)<sup>[534]</sup>, [Delete Connectors](#)<sup>[619]</sup> and [Delete Views](#)<sup>[385]</sup> topics.

**2.2.9 Save Changes**

Throughout much of your work in Enterprise Architect, any changes you make are automatically saved when you close the *dialog* (data entry window) on which you made the changes. In some cases the dialog contains a **Save** or **Apply** button, which enables you to save your changes and then keep working on the dialog.

If there is no specific dialog, such as when you create a diagram, you can save your work by:

- Clicking on the **Save** icon in the **Diagram** toolbar ()
- Pressing the **[Ctrl]+[S]** keyboard keys, or
- Selecting the **Diagram | Save** menu option.

Often, Enterprise Architect does not let you close a screen without confirming that you want to save or discard your changes.

You can also save your diagram changes automatically, by selecting the **Auto Save Changes** checkbox on the [Diagram Behavior](#)<sup>[359]</sup> page of the **Options** dialog.

**Explore User Interface**

So far you have been using the **Project Browser** and **Diagram View** to develop your project. At this point you should find out a bit more about the other facilities of the Enterprise Architect [User Interface](#)<sup>[48]</sup> or *Application Workspace*.

When you have finished exploring the User Interface topics, go to [Summary of Typical Tasks](#)<sup>[37]</sup> to identify areas of Enterprise Architect that provide particular support for your job role.



## 2.3 Typical Project Roles

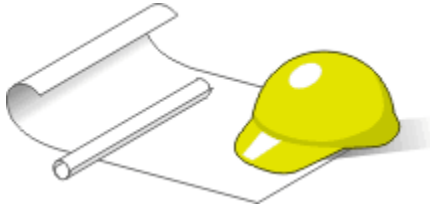

Enterprise Architect performs a number of tasks that are suited to a variety of professions. This topic describes some common working practices with Enterprise Architect for a range of project roles. There are tools for the roles of:

- [Business Analyst](#) <sup>[38]</sup>
- [Software Architect](#) <sup>[40]</sup>
- [Software Engineer](#) <sup>[41]</sup>
- [Developer](#) <sup>[42]</sup>
- [Project Manager](#) <sup>[43]</sup>
- [Tester](#) <sup>[43]</sup>
- [Implementation Manager](#) <sup>[45]</sup>
- [Technology Developer](#) <sup>[46]</sup>
- [Database Developer](#) <sup>[47]</sup>

You can review a summary of the [typical tasks](#) <sup>[37]</sup> supported for each role, or click on the appropriate role title to explore how Enterprise Architect can assist you in carrying out that role within a model driven project.

### 2.3.1 Summary of Typical Tasks

Throughout a design and development project there are many different tasks to be performed, which could be carried out either by one person or - more probably - by members of a team with different responsibilities. In either case, Enterprise Architect supports most - if not all - of the responsibilities you might have on your project.

Therefore, the next topics to explore depend on the work you normally do on a project.

The descriptions below cover a number of job roles that Enterprise Architect supports. For those that most resemble your role on a project, follow the job title hyperlink to display a description of how that role might use Enterprise Architect, then follow links within those topics to explore some of the Enterprise Architect features of importance to the role.

Most of these roles work with specific types of diagram, so you might want to [learn more about diagram types](#) in general and specific types of diagram in particular. See the [UML Diagrams](#) <sup>[673]</sup> topic

Several types of project team member might want to generate documentation on their work and reports on how the project is developing and changing. Enterprise Architect enables you to generate project documentation in either RTF or HTML format - see the [Report Generation](#) <sup>[1568]</sup> topic.

#### Note:

The Corporate, Business and Software Engineering, Systems Engineering and Ultimate editions of Enterprise Architect have a user security feature that can be applied or turned off. If security is turned on, you require the appropriate access permissions to use many of the Enterprise Architect facilities listed above. For further information, see the [List of Available Permissions](#) <sup>[198]</sup> topic.

### Business Analyst

A [Business Analyst](#)<sup>[38]</sup> might be responsible for modeling:

- Requirements
- High-level business processes
- Business activities
- Work flows
- System behavior.

### Software Architect

A [Software Architect](#)<sup>[40]</sup> might be responsible for:

- Mapping functional requirements of the system
- Mapping objects in real time
- Mapping the deployment of objects
- Defining deliverable components.

### Software Engineer

A [Software Engineer](#)<sup>[41]</sup> might be responsible for:

- Mapping Use Cases into detailed Classes
- Defining the interaction between Classes
- Defining system deployment
- Defining software packages and the software architecture.

### Developer

A [Developer](#)<sup>[42]</sup> might be responsible for:

- Forward, reverse and round-trip engineering
- Visualizing the system states
- Visualizing package arrangements
- Mapping the flow of code.

### Technology Developer

A [Technology Developer](#)<sup>[46]</sup> might be responsible for creating or customizing:

- UML Profiles
- UML Patterns
- Code Templates
- Tagged Value Types
- MDG Technologies
- Add-Ins.

## 2.3.2 Business Analysts

A Business Analyst can use Enterprise Architect to create high-level [models of business processes](#)<sup>[930]</sup>. These include business requirements, activities, work flow, and the display of system behavior.

Using Enterprise Architect, a Business Analyst can describe the procedures that govern what a particular business does. Such a model is intended to deliver a high-level overview of a proposed system.

### Database Developer

A [Database Developer](#)<sup>[47]</sup> might be responsible for:

- Developing databases
- Modeling database structures
- Creating logical data models
- Generating schema
- Reverse engineering databases.

### Tester

A [Tester](#)<sup>[43]</sup> might be responsible for:

- Developing test cases
- Importing requirements, constraints and scenarios
- Creating Quality Test documentation
- Tracking element defects and changes.

### Project Manager

A [Project Manager](#)<sup>[43]</sup> might be responsible for:

- Providing project estimates
- Resource Management
- Risk Management
- Maintenance Management.

### Implementation Manager

An [Implementation Manager](#)<sup>[45]</sup> might be responsible for:

- Modeling the tasks in rolling-out a project, including network and hardware deployment
- Assigning and tracking maintenance items on elements (issues, changes, defects and tasks).

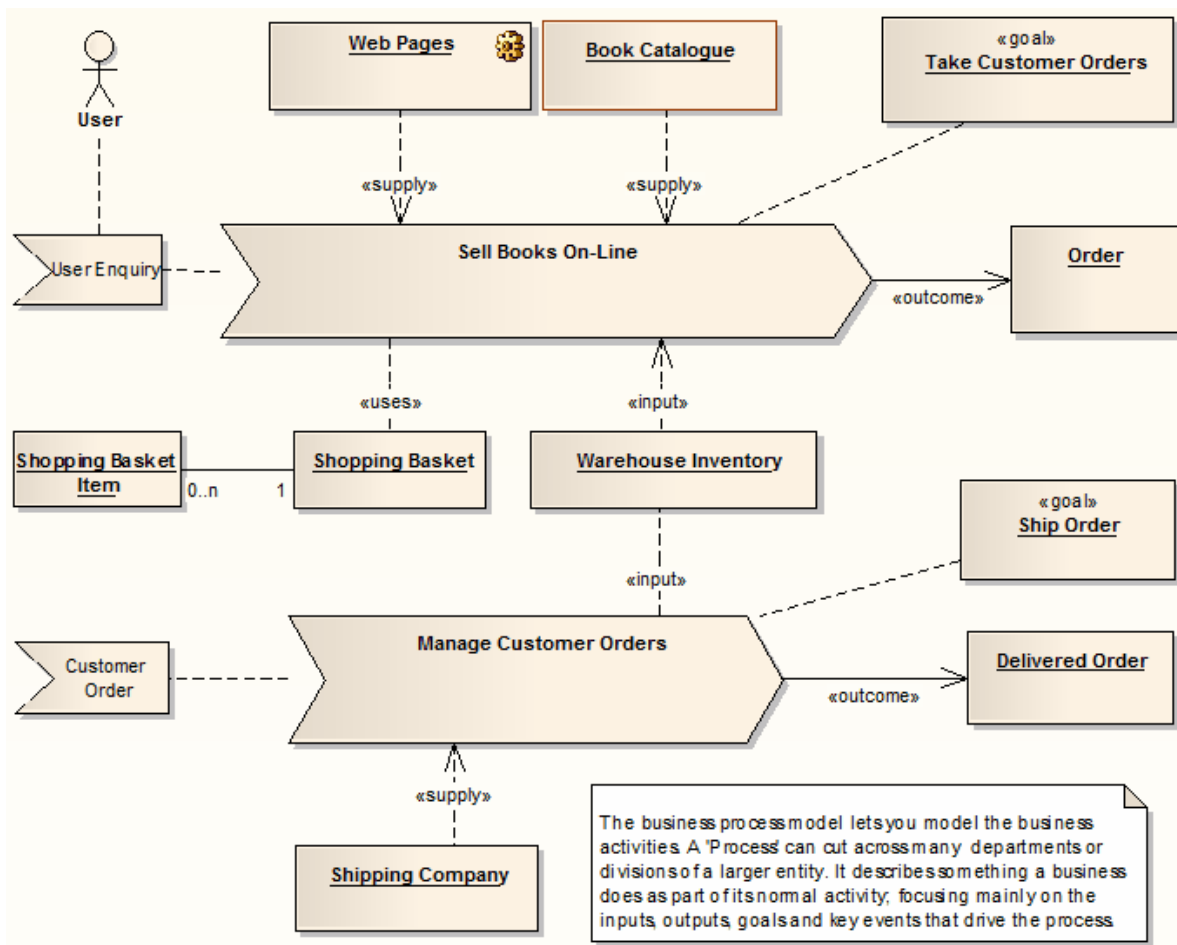

## Model High Level Business Processes

With Enterprise Architect the Business Analyst can model high level processes of the business with [Analysis diagrams](#) <sup>[733]</sup>. Analysis diagrams are a subset of UML 2.3 Activity diagrams and are less formal than other diagram types, but they provide a useful means for expressing essential business characteristics and requirements.

## Model Requirements

[Gathering requirements](#) <sup>[917]</sup> is typically the first step in developing a solution, be it for developing a software application or for detailing a business process. It is an important step in the implementation of a project. Enterprise Architect enables you to define the Requirement elements, connect Requirements to the model elements for implementation, connect Requirements together into a hierarchy, report on Requirements, and move Requirements out of model element responsibilities.

## Model Business Activities

The Business Analyst can use [Activity diagrams](#) <sup>[674]</sup> to model the behavior of a system and the way in which these behaviors are related to the overall flow of the system. Activity diagrams do not model the exact internal behavior of the system but show instead the general processes and pathways at a high level.

## Model Work Flow

To visualize the cooperation between elements involved in the work flow, the Business Analyst can use an [Interaction Overview diagram](#) <sup>[717]</sup>, which provides an overview of sub activities that are involved in a system.

## Display System Behavior

In displaying the behavior of a system as a [Use Case diagram](#) <sup>[676]</sup>, Enterprise Architect gives the Business Analyst an easily understood tool for mapping the functional requirements and behavior of a system.

### 2.3.3 Software Architects

Software Architects can use Enterprise Architect to map functional requirements with Use Cases, perform real time modeling of objects using *Interaction diagrams* ([Sequence](#) [706], [Timing](#) [690], [Communication](#) [715] or [Interaction Overview](#) [717]), design the [Deployment](#) [727] model and detail the deliverable components using [Component](#) [730] diagrams.

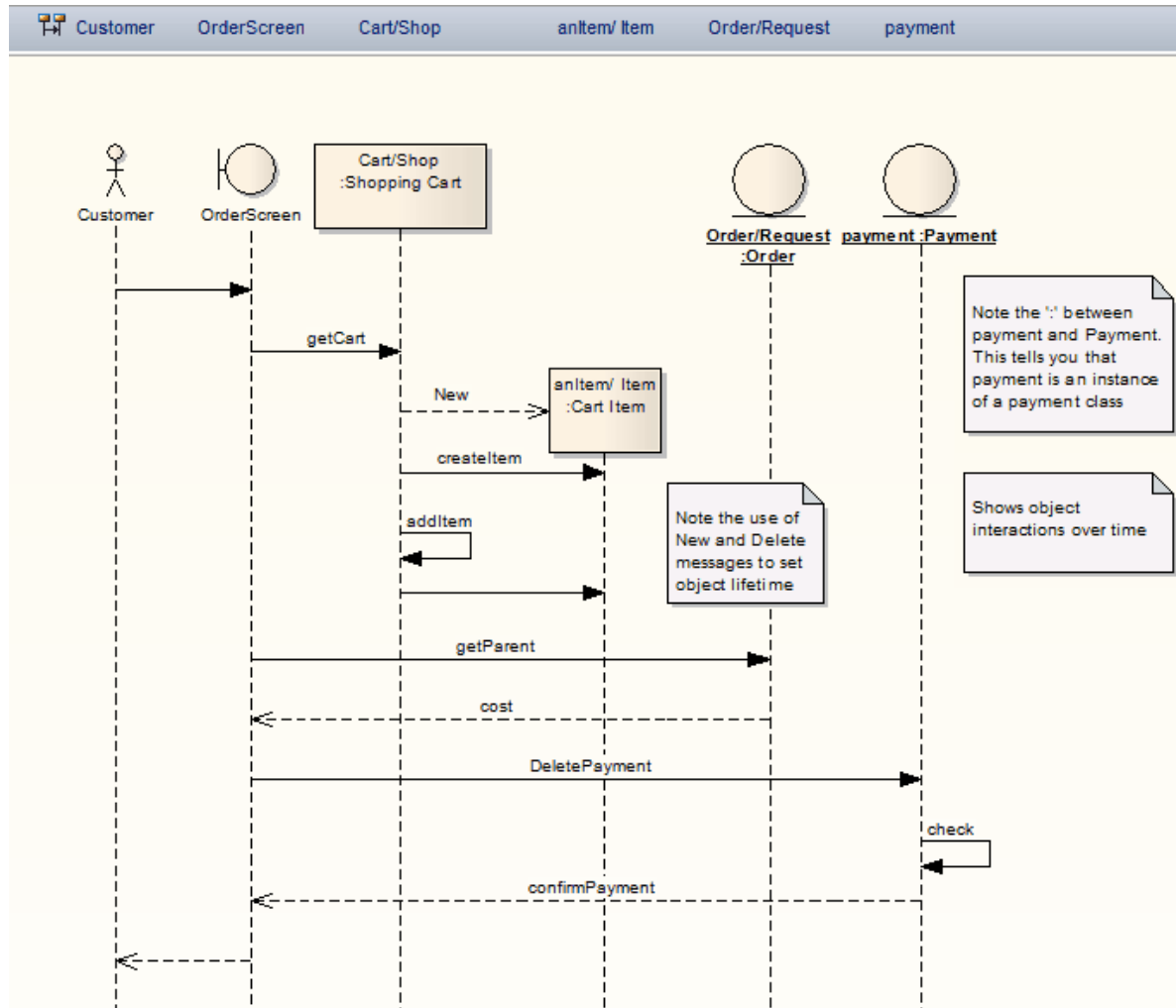

#### Map Functional Requirements of the System

With Enterprise Architect the Software Architect can take the high level business processes that have been modeled by the Business Analyst and create detailed [Use Cases](#) [806]. Use Cases are used to describe the proposed functionality of a system and are only used to detail a single unit of discrete work.

#### Map Objects in Real Time

The Software Architect can use Interaction diagrams (Sequence and Communication diagrams) to model the dynamic design of the system. Sequence diagrams are used to detail the messages that are passed between objects and the lifetimes of the objects. Communication diagrams are similar to Sequence diagrams, but are used instead to display the way in which the object interacts with other objects.

#### Map Deployment of Objects

The Software Architect can use Deployment diagrams to provide a static view of the run-time configuration of processing nodes and the components that run on the nodes. Deployment diagrams can be used to show the connections between hardware, software and any middleware that is used on a system.

## Detail Deliverable Components

Component diagrams enable the Software Architect to model the physical aspects of a system. Components can be executables, libraries, data files or another physical resource that is part of a system. The component model can be developed from scratch from the Class model or can be brought in from existing projects and from third-party vendors.

### See Also

- [Analysis Diagrams](#)<sup>[733]</sup>
- [Modeling Fundamentals](#)<sup>[370]</sup>
- [XML Import and Export](#)<sup>[288]</sup>
- [XML Technologies](#)<sup>[1039]</sup>

## 2.3.4 Software Engineers

Software Engineers using Enterprise Architect can map Use Cases onto [Class](#)<sup>[721]</sup> diagrams, detail the interactions between Classes, define the system deployment with [Deployment](#)<sup>[727]</sup> diagrams and define software packages with [Package](#)<sup>[720]</sup> diagrams.

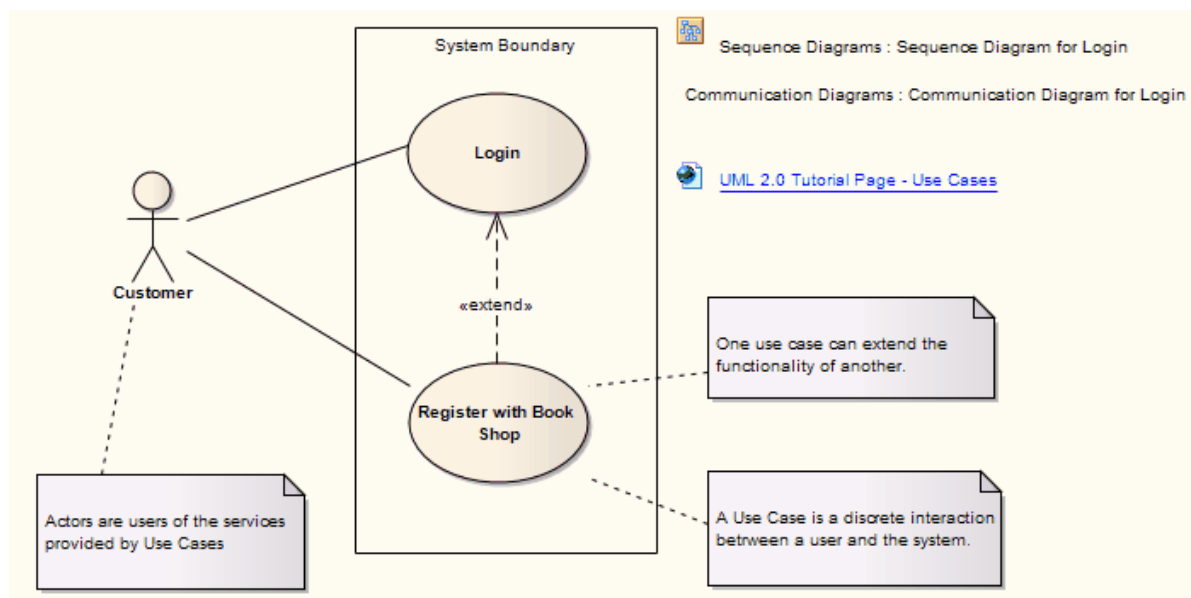

## Map Use Cases into Detailed Classes

In Enterprise Architect the Software Engineer can study the [Use Cases](#)<sup>[676]</sup> developed by the Software Architect, and with that information create Classes that fulfill the objectives defined in the Use Cases. A Class is one of the standard UML constructs that is used to detail the pattern from which objects are produced at run time. To record the relationships between Use Cases and Classes, the Software Engineer can create diagrams linking the elements with [Realize](#)<sup>[889]</sup> connectors, and/or map the Realize connectors in the [Relationship Matrix](#)<sup>[1267]</sup>.

## Detail Interaction Between Classes

Interaction diagrams ([Sequence](#)<sup>[706]</sup> and [Communication](#)<sup>[715]</sup> diagrams) enable the Software Engineer to model the dynamic design of the system. Sequence diagrams are used to detail the messages passed between objects and the lifetimes of the objects. Communication diagrams are similar to Sequence diagrams, but are used instead to display the way in which objects interact with other objects.

## Define System Deployment

Deployment diagrams can be used to provide a static view of the run-time configuration of processing nodes and the components that run on the nodes. Deployment diagrams can be used to show the connections between hardware, software and any middleware that is used on a system, to explain the connections and relationships of the components.

## Define Software Packages

The Software Engineer can use Package diagrams to detail the software architecture. Package diagrams are used to organize diagrams and elements into manageable groups, declaring the dependencies.

### See Also

- [Modeling Fundamentals](#)<sup>[370]</sup>

## 2.3.5 Developers

Developers can use Enterprise Architect to perform round trip [code engineering](#)<sup>[1281]</sup>, which includes reverse engineering of existing code and [generation of code](#)<sup>[1308]</sup> from [Class elements](#)<sup>[811]</sup>.

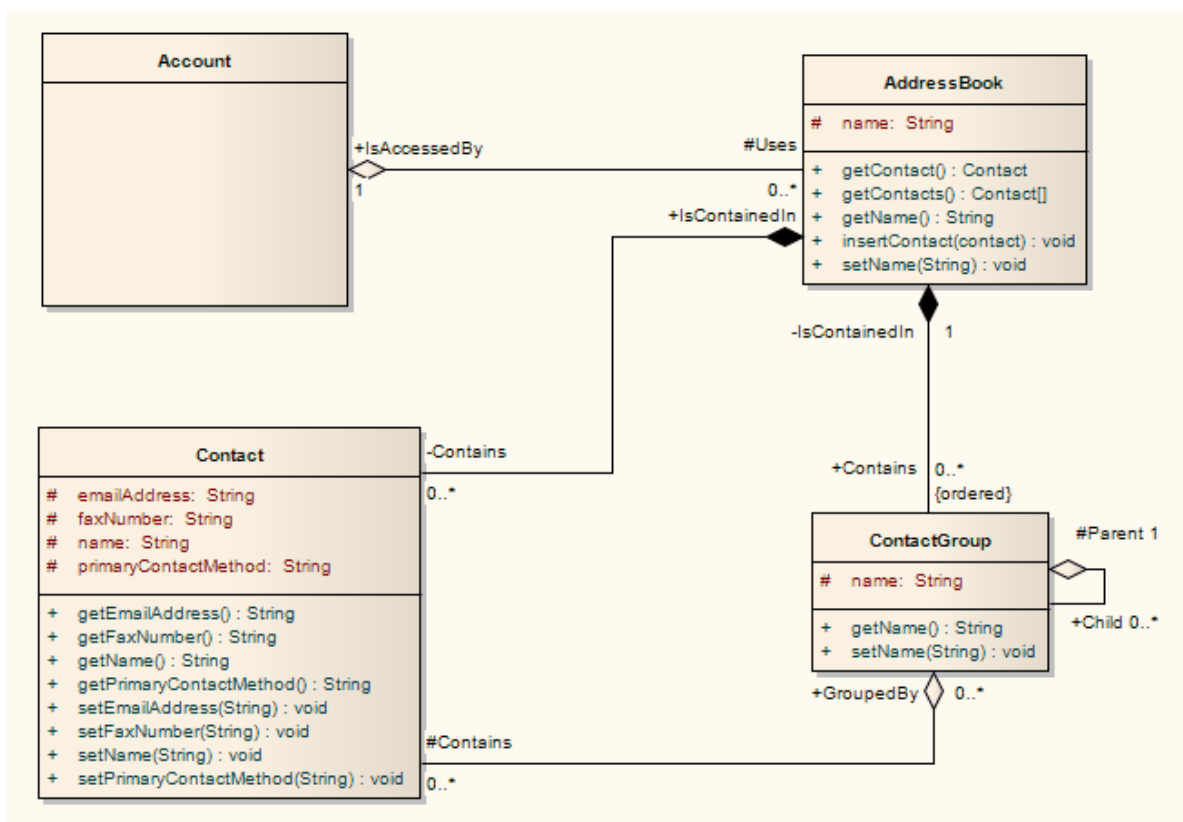

[State Machine](#)<sup>[678]</sup>, [Package](#)<sup>[720]</sup> and [Activity](#)<sup>[674]</sup> diagrams can be used by the developer to better understand the interaction between code elements and the arrangement of the code.

## Round Trip Engineering

Enterprise Architect gives the developer unparalleled flexibility, with the ability to round trip software from existing source code to UML 2.3 models and back again. Round trip Engineering involves both forward and reverse engineering of code. Keeping the [model and code synchronized](#)<sup>[1327]</sup> is an important aspect of round trip engineering.

## Reverse Engineering

Enterprise Architect enables developers to [reverse engineer](#)<sup>[1328]</sup> code from a number of supported languages and view the existing code as [Class](#)<sup>[721]</sup> diagrams. The developer can use Class diagrams to illustrate the static design view of the system. Class diagrams consist of Classes and interfaces and the relationships between them. The Classes defined in UML Class diagrams can have direct counterparts in the implementation of a programming language.

## Forward Engineering

As well as the ability to reverse engineer code, Enterprise Architect offers the developer the option of forward

engineering code (code generation). This enables the developer to make changes to their model with Enterprise Architect and have these changes implemented in the source code.

### Determine the System State

To visualize the state of the system the developer can use State Machine diagrams to describe how elements move between states, classifying their behavior according to transition triggers and constraining guards. State Machine diagrams are used to capture system changes over time, typically being associated with particular Classes (often a Class can have one or more State Machine diagrams used to fully describe its potential states).

### Visualize Package Arrangement

Package diagrams are used to help design the architecture of the system. They are used to organize diagrams and elements into manageable groups, and to declare their dependencies.

### Follow the Flow of Code

Activity diagrams are used to enable a better understanding of the flow of code. Activity diagrams illustrate the dynamic nature of the system. This enables modeling of the flow of control between Activities and represents the changes in state of the system.

#### See Also

- [XML Technologies](#) <sup>[1038]</sup>
- [Model Transformations - MDA](#) <sup>[1385]</sup>
- [Visual Execution Analysis](#) <sup>[1488]</sup>

## 2.3.6 Project Managers

Enterprise Architect provides support for the [management of projects](#) <sup>[312]</sup>. Project Managers can use Enterprise Architect to assign resources to elements, measure risk and effort, and estimate project sizes. Enterprise Architect also helps them manage element [status](#) <sup>[340]</sup>, change control and [maintenance](#) <sup>[1558]</sup>.

### Provide Project Estimates

With Enterprise Architect the Project Manager has access to a comprehensive project [estimation](#) <sup>[335]</sup> tool that calculates effort from Use Case and Actor objects, coupled with project configurations defining the technical and environmental complexity of the work environment.

### Resource Management

Managing the allocation of [resources](#) <sup>[313]</sup> in the design and development of system components is an important and difficult task. Enterprise Architect enables the Project Manager or Development Manager to assign resources directly to model elements and track progress over time.

### Risk Management

The **Project Management** window can be used to assign [Risk](#) <sup>[316]</sup> to an element within a project. The [Risk Types](#) <sup>[322]</sup> enable the Project Manager to name the risk, define the type of risk, and give it a weighting.

### Maintenance

Enterprise Architect enables the Project Manager to track and assign maintenance-related items to elements within Enterprise Architect. This enables rapid capture and record keeping for items such as [issues](#) <sup>[331]</sup>, [changes](#), [defects](#) <sup>[1563]</sup> and [tasks](#) <sup>[329]</sup>. They can also create and maintain a [project Glossary](#) <sup>[323]</sup> of processes, procedures, terms and descriptions.

## 2.3.7 Testers

Enterprise Architect provides support for design testing by enabling you to create test scripts against elements in the modeling environment.

You assign test cases to individual model elements, [requirements](#) <sup>[917]</sup> and [constraints](#) <sup>[488]</sup>. You can add scenarios to model elements, and use element [defects](#) <sup>[1559]</sup> to report problems associated with model elements.

For more detailed information on testing, see the [Introduction to Testing](#) topic.

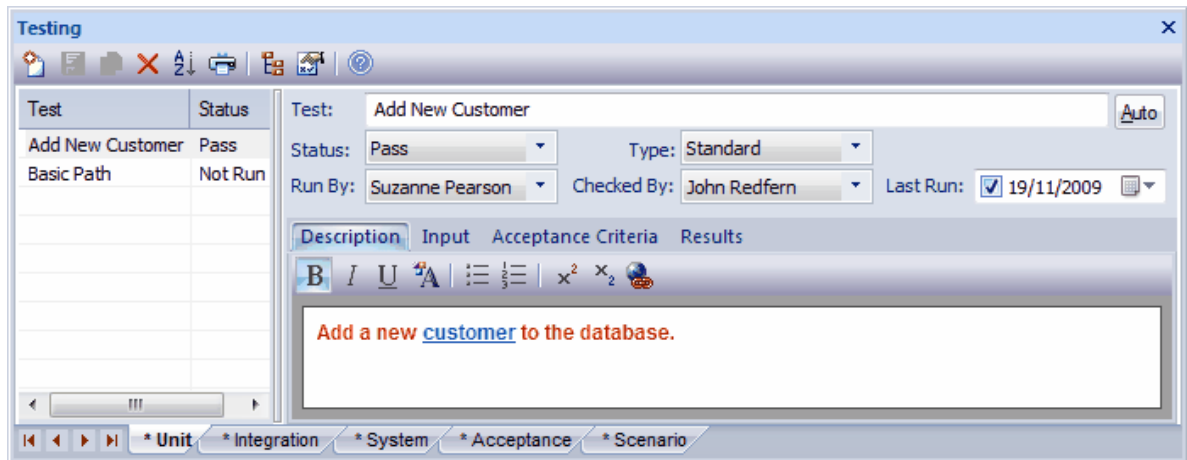

## Test Cases

With Enterprise Architect, Quality Assurance personnel can set a series of tests for each model element. The test types include Unit testing, Acceptance testing, System testing and Scenario testing.

## Import Requirements, Constraints and Scenarios

To help ensure that testing maintains integrity with the entire business process, Enterprise Architect enables the tester to import requirements, constraints and scenarios defined in earlier iterations of the development life cycle. Requirements indicate contractual obligations that elements must perform within the model. Constraints are conditions which must be met in order to pass the testing process. Constraints can be Pre-conditions (states which must be true before an event is processed), Post Conditions (events that must occur after the event is processed) or invariant constraints (which must remain true through the duration of the event). Scenarios are textual descriptions of an object's action over time and can be used to describe the way a test works.

## Create Quality Test Documentation

Enterprise Architect provides the facility to generate high quality test documentation. Enterprise Architect produces test documentation in the industry-standard .RTF file format.

## Element Defect Changes

Defect tracking enables you to allocate defect reports to any element within the Enterprise Architect model. This enables all who are involved in the project to quickly view the status of defects, to see which defects have to be addressed and which have been dealt with.



### 2.3.8 Implementation Managers

Using [Deployment](#) diagrams in Enterprise Architect, you can model the roll out of a project, including network deployment and workstation deployment. Users involved in project deployment can add maintenance tasks to the diagram elements.

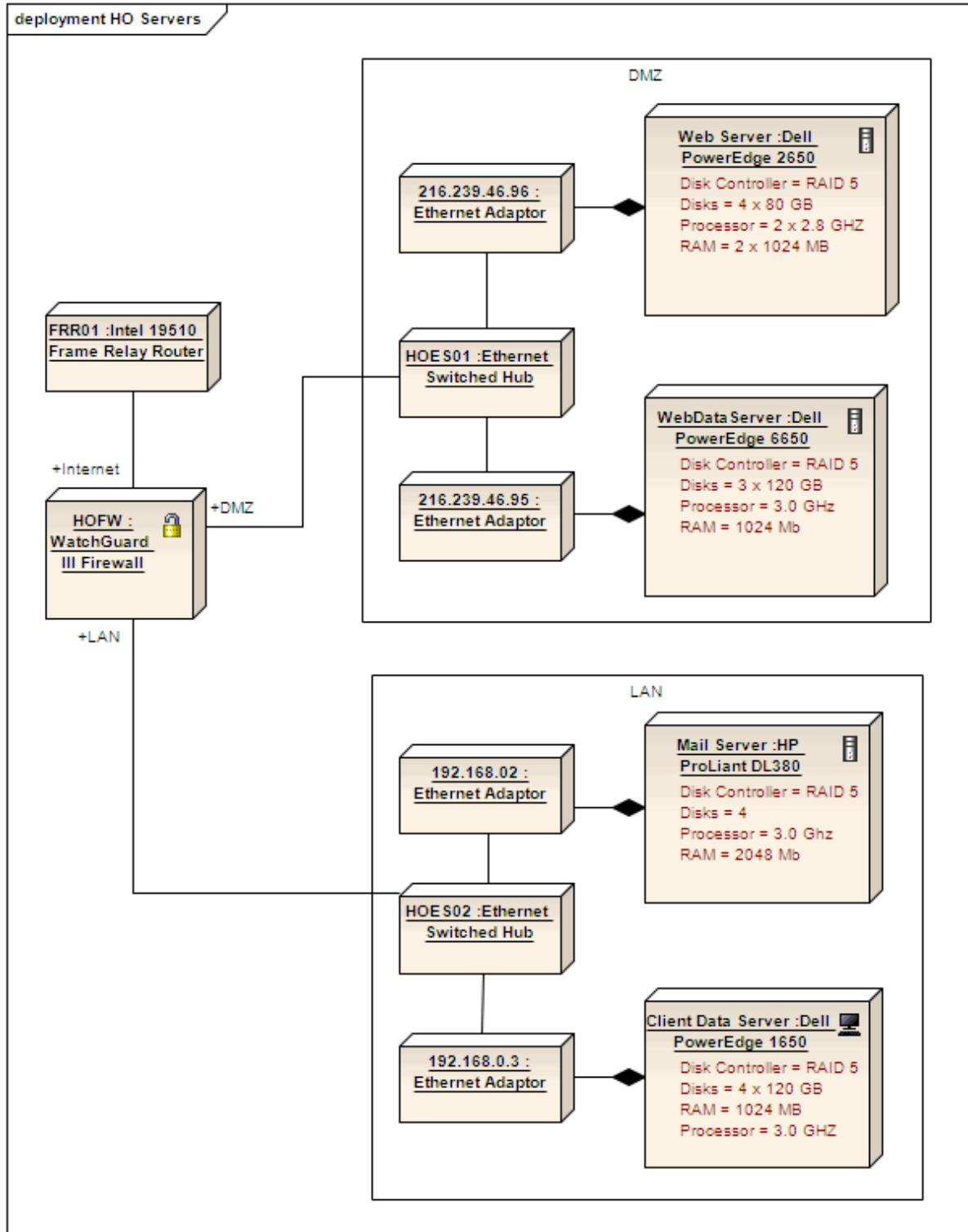

Deployment diagrams provide a static view of the run-time configuration of nodes on the network or of workstations, and the components that run on the nodes or are used in the workstations.

## Maintenance

Enterprise Architect enables you to track and assign [maintenance](#)<sup>[1558]</sup>-related items to elements within Enterprise Architect. This enables you to rapidly capture and keep records of maintenance tasks such as issues, changes, defects and tasks. By providing a centralized facility for each element involved in the deployment process Enterprise Architect offers a powerful solution for tracing the maintenance of the items and processes involved in system deployment.

### 2.3.9 Technology Developers

Technology Developers are Enterprise Architect users who create customized additions to the functionality already present within Enterprise Architect.

Additions include UML Profiles, UML Patterns, Code Templates, Tagged Value Types, Scripts, Custom Queries, Transformations, MDG Technologies and Enterprise Architect Add-Ins. By creating these extensions the Technology Developer can customize the Enterprise Architect modeling process to specific tasks and speed up development.

#### UML Profiles

By creating [UML Profiles](#)<sup>[906]</sup> the technology developer can create a customized extension for building UML models that are specific to a particular domain. Profiles are stored as XML files and can be imported into any model as required.

#### UML Patterns

[Patterns](#)<sup>[907]</sup> are sets of collaborating Objects and Classes that provide a generic template for repeatable solutions to modeling problems. As patterns are discovered in any new project, the basic pattern template can be created. Patterns can be re-used with the appropriate variable names modified for any future project.

#### Code Templates

[Code Templates](#)<sup>[1307]</sup> are used to customize the output of source code generated by Enterprise Architect. This enables the generation of code languages not specifically supported by Enterprise Architect and enables you to define the way Enterprise Architect generates source code to comply with your own company style guidelines.

#### Tagged Value Types

*Tagged Values* are used in Enterprise Architect to extend the information relating to an element in addition to the information directly supported by the UML language. A Tagged Value, strictly, is the *value* of a property of a modeling [item](#)<sup>[633]</sup>, the property being called a *tag*. For example, a Class element called *Person* might have a tag called **Age** with the Tagged Value of **42**. More loosely, the combination of tag and value can be referred to as a Tagged Value.

A [Tagged Value Type](#)<sup>[664]</sup> is a group of parameters that define and/or limit the possible values of a tag and, in many instances, how a specific value is assigned to the tag. For example, the tag **Age** might have a Tagged Value Type of **Integer**, so the user simply types in a numeric value. Alternatively, the type could be **Spin**, with lower and upper limits of, say, **20** and **120**, so the user sets a value by clicking on arrows in the field to increment or decrement the value within the limits of 20 and 120.

Typically, Tagged Values are used during the code generation process, or by other tools to pass on information that is used to operate on elements in particular ways.

#### MDG Technologies

[MDG Technologies](#)<sup>[1066]</sup> can be used to create a logical collection of resources that can contain UML Profiles, Patterns, Code Templates, Image files and Tagged Value types that are accessed through a technology file.

#### Enterprise Architect Add-Ins

[Enterprise Architect Add-Ins](#)<sup>[1776]</sup> enable you to build your own functionality into Enterprise Architect, creating your own mini programs that can extend the capabilities of Enterprise Architect, defining your own menus, and creating your own Custom Views.

## Enterprise Architect Technology Developer Support

For explanations of how the features identified above are used within Enterprise Architect, see [Build Your Own Modeling Language](#)<sup>[739]</sup>. However, [MDG Technology SDK](#)<sup>[1092]</sup> explains in detail how to *develop and integrate* these facilities.

### 2.3.10 Database Developers

Enterprise Architect supports a range of features for the [development of databases](#)<sup>[1011]</sup>, including modeling [database structures](#)<sup>[739]</sup>, importing database structures from an existing database and generating DDL for rapidly creating databases from a model.

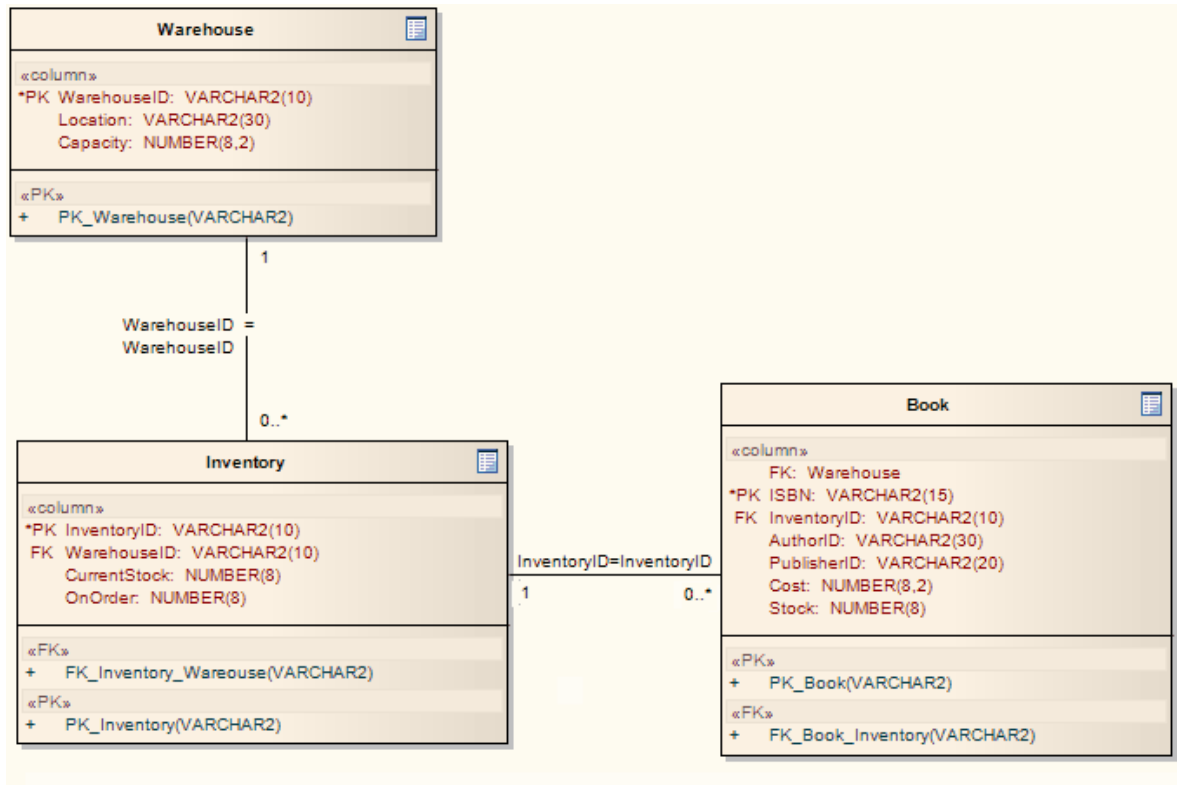

## Create Logical Data Models

With Enterprise Architect the Database developer can build database diagrams using the built-in UML Data Modeling Profile. This supports the definition of Primary and Foreign keys, cardinality, validation, triggers, constraints and indexes.

## Generate Schema

By using Enterprise Architect's DDL generation function the Database Administrator can create a DDL script for creation of the database table structure from the model. Enterprise Architect currently supports JET-based databases; DB2; InterBase; Informix; Ingres; MySQL; SQL Server; PostgreSQL; Sybase Adaptive Server Anywhere and Adaptive Server Enterprise; and Oracle 9i, 10g and 11g.

## Reverse Engineer Database

Using an ODBC data connection the Database Administrator can import a database structure from an existing database to create a model of the database. Generating the model directly from the database enables the DBA to quickly document their work and create a diagrammatic account of a complex database through the graphical benefits of UML.

## 2.4 User Interface Guide



This section provides a detailed exploration of the Enterprise Architect tools and features for modeling software systems and business processes, including:

- [The User Interface](#) <sup>[48]</sup>
- [Starting Enterprise Architect](#) <sup>[27]</sup>
- [The Start Page](#) <sup>[50]</sup>
- [The Tasks Pane](#) <sup>[51]</sup>
- [The Project Browser](#) <sup>[1208]</sup>
- [The Main Menu](#) <sup>[54]</sup>
- [The Diagram Toolbox](#) <sup>[399]</sup>
- [Workspace Toolbars](#) <sup>[79]</sup>
- [Diagram Tabs](#) <sup>[397]</sup>
- [The Element List](#) <sup>[1255]</sup>
- [Model Views](#) <sup>[1222]</sup>
- [Model Searches](#) <sup>[1231]</sup>
- [The Web Browser](#) <sup>[103]</sup>
- [Dockable Windows](#) <sup>[75]</sup>
- [Code Editors](#) <sup>[1428]</sup>
- [The Quick Linker](#) <sup>[474]</sup>
- [Defaults and User Settings](#) <sup>[90]</sup>
- [Keyboard Shortcuts](#) <sup>[104]</sup>
- [The Team Review Tools](#) <sup>[208]</sup>
- [The Spell Checker](#) <sup>[1552]</sup>

### 2.4.1 Introduction

The *Enterprise Architect Application Workspace* consists of a number of windows, menus and toolbars as described below. Together these elements provide a simple and flexible software engineering environment.

In concept the Application Workspace is similar to programs such as Microsoft Outlook and the Microsoft Visual Studio application suite; if you have used these applications you should find the Enterprise Architect interface quite familiar.

### Enterprise Architect in Action

[A demonstration of Enterprise Architect in use](#) is provided on the Sparx Systems website.

### Workspace Components

This section outlines the components of the Enterprise Architect Application Workspace. To obtain further information on specific features, follow the hyperlinks in each description.

#### Main Menu and Toolbars

At the top of the workspace are the [Main Menu](#) <sup>[54]</sup> and [toolbars](#) <sup>[79]</sup>. The **Main Menu** provides access to further submenus. There are several toolbars, which you can hide or display as necessary.

#### Context Menus

Throughout Enterprise Architect, if you right-click on work areas, lists and objects, Enterprise Architect displays a menu of options specific to the work context. For examples, see:

- [Package Context Menu \(Project Browser\)](#) <sup>[1214]</sup>
- [Diagram Context Menu \(Project Browser\)](#) <sup>[1220]</sup>
- [Element Context Menu \(Project Browser\)](#) <sup>[1218]</sup>
- [Diagram Context Menu \(Diagram\)](#) <sup>[394]</sup>
- [Element Context Menu \(Diagram\)](#) <sup>[547]</sup>

### Key Combinations

Many main menu and context menu options have alternative key combinations to perform the same operation. Instead of displaying a menu and selecting the required option, you can press the key combination. See [Keyboard Shortcuts](#) <sup>[104]</sup> for a full list of key combinations and their functions, or display the [Help Keyboard](#) <sup>[108]</sup> dialog (select the **Help | Keyboard Accelerator Map** menu option). You can also [customize](#) <sup>[98]</sup> these function keys.

### Toolbox

The Enterprise Architect Diagram [Toolbox](#) <sup>[399]</sup> is an Outlook-style toolbar from which you can select model elements and relationships to add to your modeling diagrams. This is an important feature of Enterprise Architect, as it provides all the components and connectors that you use to create your models in whatever diagrams are appropriate.

### Diagram View

The large central area of the Enterprise Architect display is the [Diagram View](#) <sup>[396]</sup>. This is where you can arrange new model elements and set their characteristics in a model diagram. Note that when you first open Enterprise Architect there is no active diagram; you must create and/or open the required diagram.

### Project Browser

The [Project Browser](#) <sup>[1209]</sup> is used to navigate your project. Double-click on package icons to open them and display the diagrams and elements they contain. Similarly, double-click on elements to open them, and on diagrams to display them in the [Diagram View](#). You can [drag elements](#) <sup>[430]</sup> from the [Project Browser](#) to add them to diagrams.

### Model Views

You can set up tailored views of your model, containing sections or organizations of your model that are of particular relevance to you or your team. [Model Views](#) <sup>[1222]</sup> are stored in the model and are visible to all users. You can set up Favorites folders to give you easy access (hyperlinks) to commonly-used packages and elements. You also have a My Views model stored locally on your machine and only visible to you, and Technology-defined views that are read only and stored with MDG technologies. You can associate each view with a query-built search that you can run by either double-clicking or expanding it.

### Visual Style

You can [configure the look and feel](#) <sup>[107]</sup> of Enterprise Architect to suit your working environment. Options range from a classic windows application to an enhanced XP appearance.

### Arranging Windows

You can rearrange windows and some menus to adapt the screen space to your work habits. You can:

- [Dock](#) <sup>[76]</sup> windows against any edge of the workspace, or move them freely (float them) as you work; for a list of dockable windows, see [Standard Windows](#) <sup>[75]</sup>
- [Autohide](#) <sup>[78]</sup> windows so that they display only when you are actually using them.

## 2.4.2 Start Page

When you start Enterprise Architect, the first page displayed is the **Start Page**.

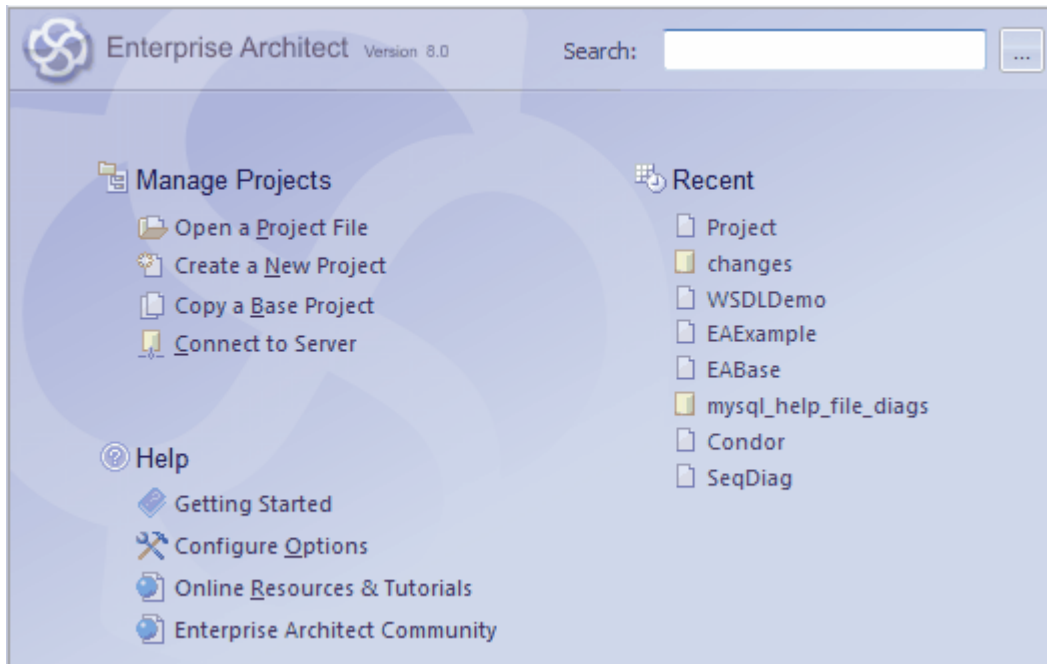

This page offers the following options:

Option	Use to
<b>Search</b>	Locate an object in Enterprise Architect. Type the name of the object in this field and click on the [ ... ] button. Enterprise Architect displays the results of the search on the <a href="#">Model Search</a> <sup>[1231]</sup> screen.  Click on an item in the search results to highlight it in the <a href="#">Project Browser</a> <sup>[1209]</sup> .
<b>Open a Project File</b>	Display the <a href="#">Open Project</a> <sup>[114]</sup> dialog, which you use to open an existing project (where you have more project files than can be listed in the <b>Recent</b> panel).
<b>Create a New Project</b> <sup>[120]</sup>	Save a new project and open the <a href="#">Model Wizard</a> <sup>[372]</sup> dialog.
<b>Copy a Base Project</b>	Select a different <a href="#">Base Project</a> <sup>[121]</sup> to generate a new project from.
<b>Connect to Server</b> <sup>[147]</sup>	Specify a Data Source name to connect to. <a href="#">MySQL</a> <sup>[123]</sup> , <a href="#">SQL Server</a> <sup>[126]</sup> , <a href="#">Oracle 9i, 10g and 11g</a> <sup>[129]</sup> , <a href="#">PostgreSQL</a> <sup>[129]</sup> , <a href="#">MSDE</a> <sup>[134]</sup> , <a href="#">Adaptive Server Anywhere</a> <sup>[132]</sup> , <a href="#">Access 2007</a> <sup>[123]</sup> and <a href="#">Progress OpenEdge</a> <sup>[134]</sup> repositories are supported.  <b>Note:</b>  This feature is available in the Corporate, Business and Software Engineering, Systems Engineering and Ultimate editions.
<b>Getting Started</b>	Open the <a href="#">Tasks Pane</a> <sup>[51]</sup> , to display useful topics and guides for various areas of work in Enterprise Architect.
<b>Configure Options</b>	Display the Help on the <a href="#">Options</a> <sup>[350]</sup> dialog, which enables you to define how Enterprise Architect displays and processes information.
<b>Online Resources &amp; Tutorials</b>	Open the <b>Resources</b> page of the Sparx Systems website, which provides access to a wide range of Enterprise Architect and UML tutorials, demonstrations, examples, Add-Ins and advice.

Option	Use to
<b>Enterprise Architect Community</b>	<p>Access the <a href="#">Sparx Systems Enterprise Architect Community Site</a>, which contains a range of articles, discussions, tools and resources provided by both Sparx Systems and the Enterprise Architect user community.</p> <p>You must register to use the facilities of the site; you can also register as an author and submit material yourself, for others to read and use.</p>
<b>Recent</b>	<p>Select from a list of the most recently used Enterprise Architect projects (both .EAP files and DBMS connections). Click on the required project to open it.</p> <p>If you have created and used <a href="#">shortcuts</a><sup>[115]</sup> to your models, a model might have two entries - one for the model accessed through Enterprise Architect and one for the model accessed through the desktop shortcut. These open the same model, although the shortcut entry also enacts any view profile you have defined.</p> <p>To remove a hyperlink to a project from this list, see <a href="#">Remove Recent Projects</a><sup>[56]</sup>.</p>

If your model has a [default diagram](#)<sup>[437]</sup> set, the default diagram opens immediately over the top of the **Start Page**. You can still access the **Start Page** from the [diagram tabs](#)<sup>[397]</sup> below the diagram. However, if you have set a shortcut view profile, that overrides the default diagram setting.

### 2.4.3 Tasks Pane

Access: **View | Other Project Tools | Tasks Pane**.

The **Tasks Pane** window provides access to a range of context-specific help topics, online resources and Enterprise Architect facilities to give you quick access to information and facilities in areas of interest in Enterprise Architect.

When you first open Enterprise Architect, the **Tasks Pane** automatically displays on the right of the screen.

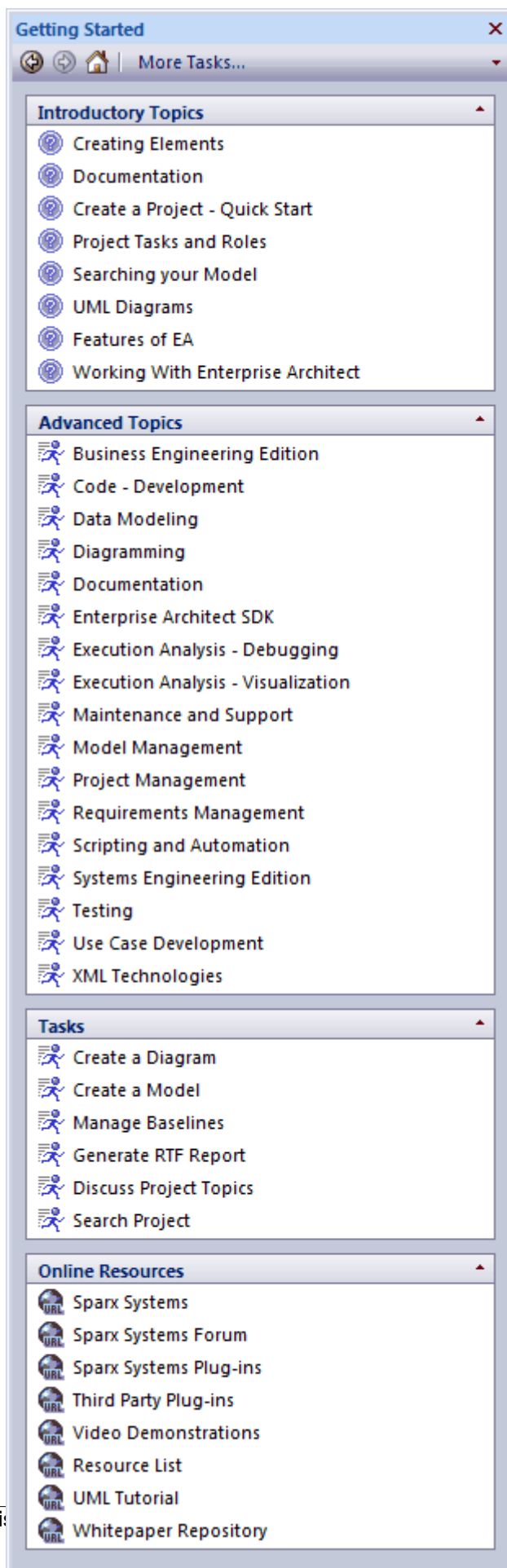



The **Tasks Pane** has several topic areas, including:



The list of topic areas varies, and can include topics specific to any [MDG Technologies](#) being used with Enterprise Architect.







To switch between the topic areas, either:

- Click on the **More Tasks** option in the toolbar and select the required area from the list, or
- Click on the left or right arrow buttons in the toolbar.

The 'Home' icon returns you to the **Getting Started** topic area.

## Tasks Pane Contents

The Tasks Pane provides several types of information and resources. Click on a:

-  icon to open appropriate topics from the Enterprise Architect Help file
-  icon to open web pages or documents on the Sparx Systems web site
-  icon to begin Enterprise Architect tasks appropriate to the **Tasks Pane** topic area; you must be in an appropriate functional area of Enterprise Architect in order for these tasks to function, such as in an open diagram
-  icon to begin Add-In tasks appropriate to the **Tasks Pane** topic area; you must be in an appropriate functional area in order for these tasks to function
-  icon to open report facilities to provide information or data collation tools
-  icon to start demonstrations of Enterprise Architect functions in action.

The selected information, web page or demonstration displays on a **Browser** tab in the main view, or the appropriate task or report window opens.

### 2.4.4 Main Menu

The Enterprise Architect **Main menu** provides mouse-driven access to many high-level functions related to the project life cycle, as well as administration functions.

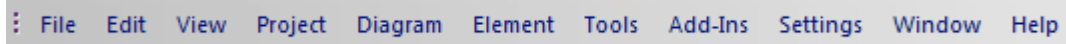







In order, the menus available are the:

- [File](#)<sup>[56]</sup> menu
- [Edit](#)<sup>[57]</sup> menu
- [View](#)<sup>[58]</sup> menu
- [Project](#)<sup>[60]</sup> menu
- [Diagram](#)<sup>[65]</sup> menu
- [Element](#)<sup>[67]</sup> menu
- [Tools](#)<sup>[70]</sup> menu
- [Add-Ins](#)<sup>[72]</sup> menu
- [Settings](#)<sup>[73]</sup> menu
- [Window](#)<sup>[74]</sup> menu
- [Help](#)<sup>[74]</sup> menu.

The above topics provide an overview of the functions available from the **Main** menu, and their general purposes.

Additionally, if you right-click on the Toolbar area just under the menu bar, a composite context menu displays providing options to display the toolbars and the more significant windows and views.

	Project Browser	Alt+0
<input checked="" type="checkbox"/>	Properties	Alt+1
	System	Alt+2
	Testing	Alt+3
	Maintenance	Alt+4
<input checked="" type="checkbox"/>	Toolbox	Alt+5
<input checked="" type="checkbox"/>	Resource Browser	Alt+6
	Source Code	Alt+7
	Execution Analyzer	Alt+8
	Element Browser	Alt+9
	Scripting	
	Tasks Pane	Ctrl+Shift+9
	Notes	Ctrl+Shift+1
	Traceability	Ctrl+Shift+4
	Tagged Values	Ctrl+Shift+6
	Project Management	Ctrl+Shift+7
	System Output	Ctrl+Shift+8
	Model Views	Ctrl+Shift+5
	Relationships	Ctrl+Shift+2
	Rules & Scenarios	Ctrl+Shift+3
	Web Browser	Ctrl+Alt+W
	Pan & Zoom	Ctrl+Shift+N
	Layout Tools	
	Add-Ins	
	Diagram Filters	
<input checked="" type="checkbox"/>	Default Tools	
	Project	
	Code Generation	
<input checked="" type="checkbox"/>	UML Elements	
<input checked="" type="checkbox"/>	Diagram	
	Current Element	
	Current Connector	
	Format Tool	
<input checked="" type="checkbox"/>	Workspace Layouts	
<input checked="" type="checkbox"/>	Status Bar	
	Customize...	

### 2.4.4.1 File

The **File** menu provides options to create, open, close and save projects, and also to perform print tasks.

Menu Option & Function Keys	Use to
<b>New Project</b> [Ctrl]+[N]	Create a <a href="#">new Enterprise Architect project</a> <sup>[120]</sup> .
<b>Open Project</b> [Ctrl]+[O]	<a href="#">Open a project</a> <sup>[114]</sup> .
<b>Open Source File</b> [Ctrl]+[Alt]+[O]	Open any type of source file (code, XML, DDL) for <a href="#">editing</a> <sup>[1442]</sup> .
<b>Close Project</b>	Close the current project.
<b>Save Project As</b>	<a href="#">Save the current model</a> <sup>[115]</sup> with a new name, or create a desktop shortcut to the current model.  (This option is also active in the ' <a href="#">Lite</a> ' <sup>[157]</sup> , read-only edition of Enterprise Architect.)
<b>Reload Current Project</b> [Ctrl]+[Shift]+[F11]	<a href="#">Reload the current project</a> <sup>[267]</sup> (use in a multi-user environment to refresh the <a href="#">Project Browser</a> ).
<b>Print Setup</b>	Configure your printer's settings.
<b>Page Setup</b>	Configure the page settings for printing.
<b>Print Preview</b>	<a href="#">Preview</a> <sup>[398]</sup> how the currently displayed diagram prints.
<b>Print</b> [Ctrl]+[P]	Print the currently displayed diagram.  Enterprise Architect provides facilities to change the <a href="#">scale</a> <sup>[456]</sup> of the printed diagram (the number of pages it takes up) and to print or omit page <a href="#">headers and footers</a> <sup>[425]</sup> on the diagram.
<b>Recent Files List</b>	Select from a list of the most recently opened projects.
<b>Exit</b>	Exit Enterprise Architect.

#### 2.4.4.1.1 Remove Recent Projects

To remove a project *hyperlink* from the **Recent** list on the [Start Page](#) <sup>[50]</sup>, follow the steps below:

1. Select **File | Open Project** from the menu bar or press [Ctrl]+[O]. The **Open Project** dialog displays.

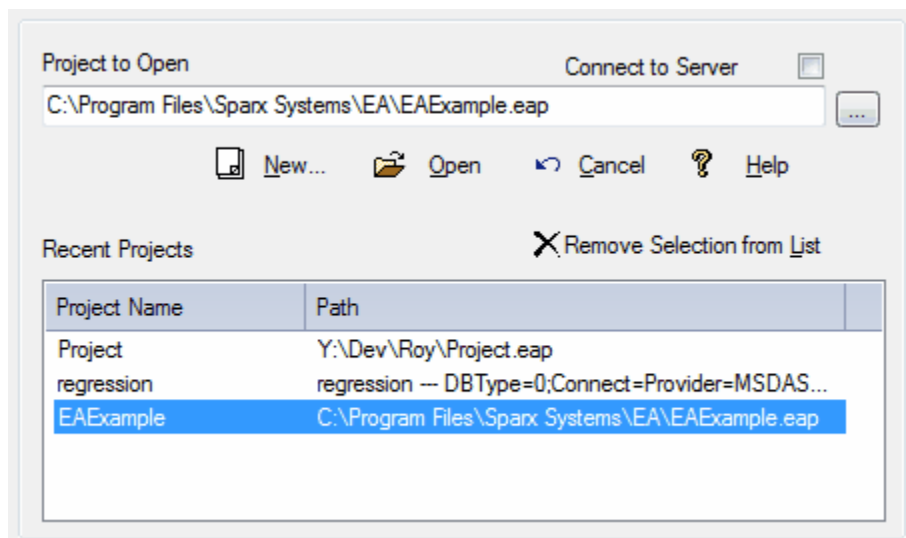

2. In the **Recent Projects** panel click on the project to remove.
3. Click on the **Remove Selection from List** button.

**Note:**

Removing the hyperlink to a project from the **Start Page** only removes the link to the project and does not remove the .EAP file from the file system.

**2.4.4.2 Edit**

The **Edit** menu provides a range of functions to apply to diagram elements for the currently open diagram.

Menu Option & Function Keys	Use to
<b>Undo</b> [Ctrl]+[Z]	<a href="#">Undo</a> <sup>[458]</sup> the last action performed; note that some actions cannot be undone.
<b>Redo</b> [Ctrl]+[Y]	Re-apply the last undone action.
<b>Copy</b> [Ctrl]+[C]	<ol style="list-style-type: none"> <li>1. Copy the selected elements to the MS Windows clipboard. To paste the selected elements, see the <a href="#">Paste Elements submenu</a> <sup>[58]</sup>.</li> <li>2. Copy an image of the selected elements to the clipboard. If no elements are selected, the entire diagram is copied.</li> </ol> <p>The image can be saved as a bitmap or a metafile; you set the format on the <a href="#">Options</a> <sup>[35]</sup> dialog.</p>
<b>Add to Project Clipboard</b> [Ctrl]+[Space]	Add the current element to the Enterprise Architect clipboard.
<b>Clear Project Clipboard</b>	Clear any elements from the Enterprise Architect clipboard.
<b>Paste Element(s)</b>	Paste clipboard elements into current diagram. See the <a href="#">Paste Elements</a> <sup>[58]</sup> submenu.
<b>Select All</b>	Select all elements concurrently on the current diagram.
<b>Select By Type</b>	Specify a particular type of element to select.
<b>Clear Selection</b>	Deselect all elements.
<b>Model Search</b> [Ctrl]+[Alt]+[A]	Display the <a href="#">Model Search</a> <sup>[1233]</sup> window, to search for particular phrases or words.
<b>File Search</b>	Display the <a href="#">File Search</a> <sup>[1485]</sup> window, to search for text in code files and scripts.
<b>Bookmark Selected</b> [Shift]+[Space]	<a href="#">Bookmark</a> <sup>[34]</sup> the selected element(s). If the selected element is already bookmarked, this option removes the bookmark.
<b>Clear All Bookmarks</b>	Clear <a href="#">bookmarks</a> <sup>[34]</sup> from any bookmarked elements in the current diagram.
<b>Delete Selected Element(s)</b> [Ctrl]+[D]	Delete the selected element from the diagram.

### 2.4.4.2.1 Paste Elements Submenu

To paste what is in the buffer either as a new element or as a hyperlink to the element, select the **Edit | Paste Element(s)** menu option.

**Note:**

You can paste images from the Enterprise Architect Clipboard or the MS Windows clipboard. The Enterprise Architect clipboard takes precedence, so you must clear that clipboard before you can paste from the MS Windows clipboard.

Menu Option & Function Keys	Use to
<b>as Link</b> [Shift]+[Insert]	Paste the element in the buffer <a href="#">as a link</a> (that is, a reference) to the element.  If there are images in the MS Windows clipboard and none in the Enterprise Architect clipboard, you can: <ul style="list-style-type: none"> <li>• Paste an image from the MS Windows clipboard into a new element as the appearance of the new element or</li> <li>• Paste an image from the MS Windows clipboard into the diagram as a new boundary's appearance.</li> </ul>
<b>as New</b> [Ctrl]+[Shift]+[V]	Paste the element in the buffer as a completely <a href="#">new</a> element.
<b>Paste Image From Clipboard</b> [Ctrl]+[Shift]+[Insert]	Paste the element in the Enterprise Architect Clipboard into the same diagram or a different diagram, as a metafile (that is, a definition of the element) as many times as is necessary.  If you paste the element into a different diagram, the classifier identifies the source diagram for the element.

### 2.4.4.3 View

From the **View** menu you can set local user preferences, including which toolbars or windows are hidden or visible.

Menu Option & Function Keys	Use to
<b>Project Browser</b> [Alt]+[0]	Show or hide the <a href="#">Project Browser</a> window.
<b>Model Views</b> [Ctrl]+[Shift]+[5]	Show or hide the <a href="#">Model Views</a> window.
<b>Team Review</b> [Ctrl]+[Alt]+[U]	Open the <a href="#">Team Review</a> window.
<b>Relationship Matrix</b>	Open the <a href="#">Relationship Matrix</a> to cross reference elements to each other by connector type.
<b>Element List</b> [Ctrl]+[Alt]+[R]	Display the current diagram or package in a context-sensitive, editable table, the <a href="#">Element List</a> .
<b>Other Project Tools</b>	Display a <a href="#">submenu</a> containing options for the <a href="#">Resources</a> , <a href="#">Tasks Pane</a> , <a href="#">System</a> , <a href="#">Audit View</a> windows, and the internal <a href="#">Web Browser</a> .
<b>Diagram Toolbox</b> [Alt]+[5]	Show or hide the Diagram <a href="#">Toolbox</a> .
<b>Diagram Filters</b>	Display the <a href="#">Diagram Filters</a> window, for selecting the elements to show or hide on a diagram.
<b>Pan and Zoom</b> [Ctrl]+[Shift]+[N]	Display the <a href="#">Pan &amp; Zoom</a> window for panning across a diagram to display sections at greater magnification.

Menu Option & Function Keys	Use to
<b>Layout Tools</b>	Display the <a href="#">Layout Tools</a> <sup>[458]</sup> window, for reformatting your diagram in one of a range of layouts.
<b>Element Browser</b> [Alt]+[9]	Explore the components of the selected element, in the <a href="#">Element Browser</a> <sup>[510]</sup> window.
<b>Traceability</b> [Ctrl]+[Shift]+[4]	Show or hide the <a href="#">Traceability</a> <sup>[1253]</sup> window, for tracing the relationships of an element through the model.
<b>Element Properties</b> [Alt]+[1]	Show or hide the <a href="#">Properties</a> <sup>[508]</sup> window for the selected element.
<b>Scenarios &amp; Requirements</b> [Ctrl]+[Shift]+[3]	Display the <a href="#">Scenarios, internal Constraints and Requirements</a> <sup>[514]</sup> for the selected element, as tabs of the main work space.
<b>Testing</b> [Alt]+[3]	Show or hide the <a href="#">Testing</a> <sup>[1537]</sup> window.
<b>Other Element Tools</b>	Display a <a href="#">submenu</a> <sup>[59]</sup> containing options for the <b>Project Management</b> , <b>Maintenance</b> , <b>Source Code</b> and <b>Relationships</b> tools.
<b>Execution Analyser</b>	Display the <b>Debug Workbench</b> options. See <a href="#">View Submenus</a> <sup>[60]</sup> .
<b>Scripting</b>	Show or hide the <a href="#">Scripter</a> <sup>[1660]</sup> window.
<b>System Output</b> [Ctrl]+[Shift]+[8]	Show or hide the <a href="#">Output</a> <sup>[102]</sup> window.
<b>Add-In Windows</b>	Display a window, or list of windows, provided by any Add-Ins you have installed and enabled. If no windows are provided, displays an empty, docked <b>Add-Ins</b> window.
<b>Notes</b> [Ctrl]+[Shift]+[1]	Show or hide the <a href="#">Notes</a> <sup>[64]</sup> window.
<b>Tagged Values</b> [Ctrl]+[Shift]+[6]	Show or hide the <a href="#">Tagged Values</a> <sup>[632]</sup> window.
<b>Toolbars</b>	Show or hide individual toolbars. See <a href="#">View Submenus</a> <sup>[60]</sup> .
<b>Visual Style</b>	See <a href="#">View Submenus</a> <sup>[60]</sup> .
<b>Workspace Layouts</b>	Displays the <b>Workspace Layout</b> dialog for <a href="#">changing the content and layout</a> <sup>[86]</sup> of the Enterprise Architect workspace.

### 2.4.4.3.1 View Submenus

#### The Other Project Tools Sub-Menu

Select the windows to be visible and deselect those to be hidden. You can select from:

- Resources [Alt]+[6] - Show or hide the [Resources](#) <sup>[667]</sup> window.
- Tasks Pane [Ctrl]+[Shift]+[9] - Show or hide the [Tasks Pane](#) <sup>[51]</sup>.
- System [Alt]+[2] - Show or hide the [System](#) <sup>[323]</sup> window.
- Audit View - Display the [Audit View](#) <sup>[274]</sup>, which shows the information that has been recorded by auditing.
- [Internal Web Browser](#) <sup>[103]</sup> [Ctrl]+[Alt]+[W] - Open the web browser page at the site you have specified on the [Options](#) <sup>[357]</sup> dialog, in the **Web Home** field.

#### The Other Element Tools Submenu

Select the windows to be visible and deselect those to be hidden. You can select from:

- Project Management [Ctrl]+[Shift]+[7] - Show or hide the [Project Management](#) <sup>[312]</sup> window.
- Maintenance [Alt]+[4] - Show or hide the [Maintenance](#) <sup>[1558]</sup> window.
- Source Code [Alt]+[7] - Show or hide the [Source Code Viewer](#) <sup>[1447]</sup> window.

- Relationships **[Ctrl]+[Shift]+[2]** - List the element's connectors on the [Relationships](#) window.

## The Execution Analyzer Menu

Select the aspect of the debugging process you want to explore, from the following options:

- Debugger **[Alt]+[8]** - Show or hide the [Debug](#) window, which also enables you to display some or all of the other debugger windows listed below, at the same time.
- [Profiler](#) - displays the **Profiler** window.
- [Call Stack](#)
- [Record & Analyze](#)
- [Locals](#)
- [Watches](#)
- [Modules](#)
- [Debug Output](#)
- [Workbench](#) - enables you to [create your own workbench variables](#) and [invoke methods](#) on them
- [Breakpoints & Markers](#)
- [Memory Viewer](#)

## The Toolbars Sub-Menu

Select the toolbars to be visible and deselect those to be hidden. You can select from:

- [Default Tools](#)
- [Project](#)
- [Code Generation](#)
- [UML Elements](#)
- [Diagram](#)
- [Current Element](#)
- [Current Connector](#)
- [Format Tool](#)
- [Workspace Layouts](#)
- [Status Bar](#)

## The Visual Style Sub-Menu

Presents options to:

- Select different [visual styles](#) or *themes* for the Enterprise Architect user interface
- Animate windows that have been [automatically hidden](#)
- Toggle the down-arrow on the end of each toolbar that enables you to customize the toolbar buttons, as shown below:



- Hide or redisplay the diagram [caption bar](#) at the top or bottom of a diagram. The caption bar is illustrated below:

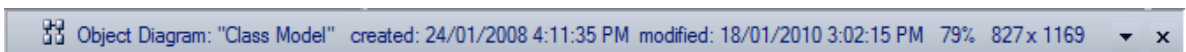

### 2.4.4.4 Project

Use the **Project** menu for tasks related to the management of your project, such as recording issues, setting estimation parameters and compiling a glossary.

Menu Option & Function Keys	Use to
Add Package <b>[Ctrl]+[W]</b>	<a href="#">Create a new package</a>



Menu Option & Function Keys	Use to
Add Diagram [Ctrl]+[Insert]	Create a new diagram <sup>[422]</sup> in the current package.
Add Element [Ctrl]+[M]	Create a new element <sup>[523]</sup> on the current diagram.
Documentation	See <a href="#">Documentation Submenu</a> <sup>[61]</sup> .
Source Code Engineering	See <a href="#">Source Code Engineering Submenu</a> <sup>[62]</sup> .
Execution Analyzer	See <a href="#">Execution Analyzer Submenu</a> <sup>[62]</sup> .
Database Engineering	See <a href="#">Database Engineering Submenu</a> <sup>[63]</sup> .
Transformations	See <a href="#">Model Transformations Submenu</a> <sup>[63]</sup> .
Model Validation	See <a href="#">Model Validation Submenu</a> <sup>[64]</sup> .
Web Services	See <a href="#">Web Services Submenu</a> <sup>[64]</sup> .
XML Schema	See <a href="#">XML Schema Submenu</a> <sup>[64]</sup> .
Security	See <a href="#">Security Submenu</a> <sup>[64]</sup> .
Version Control	See <a href="#">Version Control Submenu</a> <sup>[65]</sup> .
Import/Export	See <a href="#">Import/Export Submenu</a> <sup>[65]</sup> .
Manage Baselines [Ctrl]+[Alt]+[B]	Store a model branch as a snapshot or <a href="#">baseline</a> <sup>[281]</sup> . Available in the Corporate, Business and Software Engineering, Systems Engineering and Ultimate editions.
Use Case Metrics	Set <a href="#">Use Case Metrics</a> <sup>[338]</sup> to assist in estimating project size.
Project Statistics	View some basic project statistics.

#### 2.4.4.4.1 Documentation Submenu

To generate various types of documentation, select the **Project | Documentation** menu option.

Menu Option & Function Keys	Use to
Rich Text Format Report [F8]	Generate a report for the currently selected package in <a href="#">Rich Text Format</a> <sup>[1569]</sup> .
HTML Report [Shift]+[F8]	Generate a report for the currently selected package in <a href="#">HTML</a> <sup>[1647]</sup> format.
Diagrams Only Report [Ctrl]+[Shift]+[F8]	Generate an RTF report containing only <a href="#">diagrams</a> <sup>[1625]</sup> .
Testing Report	Generate an RTF report of the model's existing <a href="#">tests</a> <sup>[1550]</sup> .
Issues	Generate an RTF report of the model's <a href="#">issues</a> <sup>[331]</sup> .
Glossary	Generate an RTF report of the model's <a href="#">Glossary</a> <sup>[328]</sup> .
Implementation Details	Generate an <a href="#">implementation report</a> <sup>[1626]</sup> for the currently-selected package.
Dependency Details	Generate a <a href="#">dependency report</a> <sup>[1624]</sup> for the currently-selected package.
Testing Details	Generate <a href="#">test details</a> <sup>[1549]</sup> for the currently-selected package.
Resource and Tasking Details	View <a href="#">resource details</a> <sup>[318]</sup> .

#### 2.4.4.4.2 Source Code Engineering Submenu

To forward and reverse engineer code using the language of your choice select the **Project | Source Code Engineering** menu option (Professional, Corporate, Business and Software Engineering, Systems Engineering and Ultimate editions).

Menu Option & Function Keys	Use to
Generate Package Source Code [Ctrl]+[Alt]+[K]	<a href="#">Generate source code</a> <sup>[1331]</sup> for the currently selected package.
Synchronize Package Contents [Ctrl]+[Alt]+[M]	Synchronize selected package with the source code.
Import Source Directory [Ctrl]+[Shift]+[U]	<a href="#">Import</a> <sup>[1332]</sup> and reverse engineer an entire directory structure.
Import Binary Module	<a href="#">Import a binary module</a> <sup>[1334]</sup> .
Import ActionScript Files	Import code written in <a href="#">ActionScript</a> <sup>[1331]</sup> with the file extension .AS.
Import C Files	Import code written in <a href="#">ANSI C</a> <sup>[1331]</sup> with the file extension .C or .H.
Import C# Files	Import code written in the <a href="#">C#</a> <sup>[1331]</sup> programming language with the file extension .CS.
Import C++ Files	Import code written in the <a href="#">C++</a> <sup>[1331]</sup> programming language with the file extension .H, .HPP or .HH.
Import Delphi Files	Import code written in the <a href="#">Delphi</a> <sup>[1331]</sup> programming language with the file extension .PAS.
Import Java Files	Import code written in the <a href="#">Java</a> <sup>[1331]</sup> programming language with the file extension .JAVA.
Import PHP Files	Import code written in <a href="#">PHP</a> <sup>[1332]</sup> with the file extension .PHP, .PHP4, .INC.
Import Python Files	Import code written in <a href="#">Python</a> <sup>[1332]</sup> with the file extension .PY.
Import Visual Basic Files	Import code written in the <a href="#">Visual Basic</a> <sup>[1332]</sup> programming language with the file extension .FRM, .CLS, .BAS or .CTL.
Import VB.Net Files	Import code written in the <a href="#">VB.Net</a> <sup>[1332]</sup> programming language with the file extension .VB.

#### 2.4.4.4.3 Execution Analyzer Submenu

To link your project with a compiler for building, running and debugging, select the **Project | Execution Analyzer** menu option.

Menu Option & Function Keys	Use to
Package Build Scripts [Shift]+[F12]	Create and configure <a href="#">Package Build compiler scripts</a> <sup>[1426]</sup> .
Build [Ctrl]+[Shift]+[F12]	<a href="#">Build</a> <sup>[1444]</sup> the application for your current script. Execute the <b>Build</b> command in the <b>Build Scripts</b> dialog.
Test [Ctrl]+[Alt]+[T]	Execute the <a href="#">Test</a> <sup>[1483]</sup> command you configured in the <b>Build Scripts</b> dialog.

Menu Option & Function Keys	Use to
Run [Ctrl]+[Alt]+[N]	Execute the <a href="#">Run</a> <sup>[1482]</sup> command you configured in the <b>Build Scripts</b> dialog.
Deploy [Ctrl]+[Shift]+[Alt]+[F12]	Execute the <a href="#">Deploy</a> <sup>[1484]</sup> command you configured in the <b>Build Scripts</b> dialog.
Debug Run [F6]	Run the application and <a href="#">Debug</a> <sup>[1447]</sup> the <b>Run</b> command in the <b>Build Scripts</b> dialog.
Debug Pause	Pause and restart execution of a debug run.
Step Into [Shift]+[F6]	<a href="#">Step into</a> <sup>[1473]</sup> the current function.
Step Over [Alt]+[F6]	<a href="#">Step over</a> <sup>[1472]</sup> the current function.
Step Out [Ctrl]+[F6]	<a href="#">Step out</a> <sup>[1473]</sup> of the current function.
Debug Stop [Ctrl]+[Alt]+[F6]	<a href="#">Stop</a> <sup>[1471]</sup> the current debug session.
Start Debug Recording	<a href="#">Start recording</a> <sup>[1504]</sup> your trace for a debug session.
Stop Debug Recording	<a href="#">Stop a debug recording</a> <sup>[1504]</sup> .
Auto Record Thread	<a href="#">Autorecord</a> <sup>[1504]</sup> your debug session. The <b>Stack Trace History</b> , <b>Stack</b> tab and <b>Source Code Editor</b> dynamically update to reflect the current execution sequence for the thread; Stack Trace Recording ends when the thread ends or when you click on the <b>Stop</b> button.
Show/Hide Execution	Display the executing code when a thread has encountered a breakpoint. The option presents the source code file in an editor window with the current line of code highlighted for the thread that has the current focus.
Create Sequence Diagram	<a href="#">Create a Sequence diagram</a> <sup>[1507]</sup> from the <b>Stack Trace History</b> .

#### 2.4.4.4.4 Database Engineering Submenu

Select the **Project | Database Engineering** menu option.

Menu Option	Use to
Import DB Schema from ODBC	<a href="#">Import a database schema from an ODBC</a> <sup>[1363]</sup> data source.
Generate Package DDL	<a href="#">Generate a Package DDL</a> <sup>[1369]</sup> script to create the tables in the currently selected package.

#### 2.4.4.4.5 Transformations Submenu

Select the **Project | Transformations** menu option.

Menu Option & Function Keys	Use to
Transform Selected Elements [Ctrl]+[H]	Perform an MDA-style transformation to the currently selected <a href="#">elements</a> <sup>[1387]</sup> .
Transform Current Package [Ctrl]+[Shift]+[H]	Perform an MDA-style transformation to the currently selected <a href="#">package</a> <sup>[1387]</sup> .

#### 2.4.4.4.6 Model Validation Submenu

Select the **Project | Model Validation** menu option.

Menu Option & Function Keys	Use to
Validate Selected [Ctrl]+[Alt]+[V]	<a href="#">Validate</a> <sup>[1528]</sup> a selected element, diagram or package from the <b>Project Browser</b> .
Cancel Validation	Cancel the validation process.
Configure	<a href="#">Configure the Validation</a> <sup>[1530]</sup> rules from the list of available rules.

#### 2.4.4.4.7 Web Services Submenu

Select the **Project | Web Services** menu option.

Menu Option	Use to
Import WSDL	<a href="#">Reverse engineer</a> <sup>[1376]</sup> a Web Service Definition Language (WSDL) file as a UML Class model.
Generate WSDL	<a href="#">Forward</a> <sup>[1379]</sup> engineer a UML Class model to a WSDL file.

#### 2.4.4.4.8 XML Schema Submenu

Select the **Project | XML Schema** menu option.

Menu Option	Use to
Import XML Schema	<a href="#">Reverse</a> <sup>[1376]</sup> engineer a W3C XML Schema (XSD) file as a UML Class model.
Generate XML Schema	<a href="#">Forward</a> <sup>[1376]</sup> engineer a UML Class model to a W3C XML Schema (XSD) file.

#### 2.4.4.4.9 Security Submenu

To configure security settings for your project, select the **Project | Security** menu option.

##### Note:

This feature is available in the Corporate, Business and Software Engineering, Systems Engineering and Ultimate editions.

Menu Option & Function Keys	Use to
Manage Users	Add, modify and remove <a href="#">users</a> <sup>[197]</sup> , including maintaining permissions.
Manage Groups	Add, modify and remove security <a href="#">groups</a> <sup>[197]</sup> , including maintaining permissions.
Manage Locks	View and manage element <a href="#">locks</a> <sup>[207]</sup> .
Change Password	<a href="#">Change current security password</a> <sup>[207]</sup> .
Login as Another User	Switch the login to a different user ID.
My Locks [Ctrl]+[Shift]+[L]	View and delete your own <a href="#">locks</a> <sup>[207]</sup> .
Enable Security	Enable or disable <a href="#">user security</a> <sup>[189]</sup> to limit access to update functions in the model.

Menu Option & Function Keys	Use to
Require User Lock to Edit	Toggle the <a href="#">security policy</a> [190] in force.
Encrypt Password	Add <a href="#">encryption</a> [200] to your password (prior to Enterprise Architect Release 7.1).

#### 2.4.4.4.10 Version Control Submenu

Select the **Project | Version Control** menu option.

Menu Option & Function Keys	Use to
Configure Current Package [Ctrl]+[Alt]+[P]	Specify whether this <a href="#">package</a> [259] (and its children) is controlled and, if so, which file it is controlled through.
Version Control Settings	Specify the <a href="#">options</a> [234] required to connect to a Source Code Control (SCC) provider.
Validate Configurations	<a href="#">Validate the version control configuration</a> [260] of each package in the model.
Work Offline	Toggle between <a href="#">'offline' version control</a> [268] and online version control.

#### 2.4.4.4.11 Import/Export Submenu

To perform import and export to XMI and CSV, select the **Project | Import/Export** menu options.

Menu Option & Function Keys	Use to
Import Package from XMI [Ctrl]+[Alt]+[I]	<a href="#">Import a package</a> [290] from an XMI (XML based) file.
Export Package to XMI [Ctrl]+[Alt]+[E]	<a href="#">Export</a> [289] the currently selected package to an XMI (XML based) file.
CSV Import/Export [Ctrl]+[Alt]+[C]	<a href="#">Import</a> [305] or <a href="#">Export</a> [303] information on Enterprise Architect elements in CSV format.
CSV Import/Export Specifications	Set up <a href="#">CSV import Export Specifications</a> [300].
Batch XMI Export	<a href="#">Export a group</a> [298] of controlled packages in one action.
Batch XMI Import	Run a <a href="#">batch import</a> [298] of multiple packages.

#### 2.4.4.5 Diagram

The **Diagram** menu enables you to save diagram images to file as well as configure diagram properties and options.

Menu Option & Function Keys	Use to
Properties [F5]	View and edit the <a href="#">&lt;type&gt; Diagram: &lt;name&gt;</a> dialog for the current diagram.
Layout Diagram	Automatically <a href="#">layout</a> [47] the current diagram (not available for Behavioral diagrams).
Lock Diagram	Prevent the diagram from being edited, or release the locked diagram for

Menu Option & Function Keys	Use to
	<p>editing.</p> <p><b>Note:</b></p> <p>This does not apply in the Corporate, Business and Software Engineering, Systems Engineering and Ultimate editions if security is enabled. In that case, see <a href="#">Lock Model Elements</a><sup>[204]</sup>.</p>
<b>Save [Ctrl]+[S]</b>	Save the current position of all diagram elements.
<b>Save Image [Ctrl]+[T]</b>	Save the diagram as a bitmap file (.BMP), Graphics Interchange Format file (.GIF) or Windows Metafile (.WMF).
<b>Copy Image [Ctrl]+[B]</b>	Copy an image of the current diagram to the clipboard. The image can be in metafile or bitmap format; you set the format on the <a href="#">Options</a> <sup>[351]</sup> dialog.
<b>Save UML Pattern</b>	Save the current diagram as a <a href="#">UML pattern</a> <sup>[902]</sup> .
<b>Swimlanes and Matrix</b>	Add, modify and delete <a href="#">swimlanes</a> <sup>[450]</sup> or the <a href="#">swimlanes matrix</a> <sup>[444]</sup> for the current diagram.
<b>Visible Relations [Ctrl]+[Shift]+[I]</b>	Hide or show individual <a href="#">connectors</a> <sup>[619]</sup> for the current diagram.
<b>Property Note</b>	Display the <a href="#">properties note</a> <sup>[440]</sup> for the current diagram on screen.
<b>Sequence Messages</b>	<a href="#">Change</a> <sup>[880]</sup> the order of the <a href="#">communication messages</a> <sup>[879]</sup> in the current diagram.
<b>Find in Project Browser [Shift]+[Alt]+[G]</b>	Locate the current diagram in the <b>Project Browser</b> window.
<b>Make User Default</b>	<p>(Use in the Corporate, Business and Software Engineering, Systems Engineering and Ultimate editions of Enterprise Architect, if security is enabled.)</p> <p>Make the current diagram the default diagram opened when you re-open this model. The User Default diagram overrides the Model Default diagram (see <b>Make Model Default</b>, below).</p> <p>To cancel a User Default diagram, either:</p> <ul style="list-style-type: none"> <li>• Create a dummy diagram, set it as the User Default and delete it, or</li> <li>• Delete the original diagram (if it is no longer relevant).</li> </ul> <p>This still blocks the Model Default diagram, whilst Security is enabled. To re-establish the Model Default diagram, set it as the User Default.</p>
<b>Make Model Default</b>	<p>Make the current diagram the <a href="#">default diagram</a><sup>[437]</sup> opened when the current model is re-opened (unless you set a <i>User Default</i> diagram, which overrides the model default; see above).</p> <p>To cancel a Model Default diagram, either:</p> <ul style="list-style-type: none"> <li>• Create a dummy diagram, set it as the Model Default and delete it, or</li> <li>• Delete the original diagram (if it is no longer relevant).</li> </ul>
<b>Change Type</b>	<a href="#">Change the type</a> <sup>[434]</sup> of the current diagram.
<b>Repeat Last Element [Shift]+[F3]</b>	Create an instance of the same type as the last element created.
<b>Repeat Last Connector [F3]</b>	Create an instance of the same type as the last connector created.

Menu Option & Function Keys	Use to
Show Grid	Show or hide the diagram grid
Snap To Grid	Position elements on the diagram grid. There are two options: <ul style="list-style-type: none"> <li>Standard Grid - constrains elements to the grid when they are added to diagrams</li> <li>Smart Placement - places elements even distances away from other elements and spaces elements evenly.</li> </ul> If neither of these options are enabled, the elements can be placed freely on the diagram.
Zoom	Change the <a href="#">zoom</a> <sup>[453]</sup> factor on the current diagram.

#### 2.4.4.6 Element

You can configure and access element details using the **Element** menu. This enables you to control element layout, generate documentation and manage project resources.

Menu Option & Function Keys	Use to
Properties [Alt]+[Enter]	View the <a href="#">Properties</a> <sup>[481]</sup> dialog of the selected element.
Add Tagged Value [Ctrl]+[Shift]+[T]	<a href="#">Add a Tagged Value</a> <sup>[634]</sup> to the currently selected element.
Linked Document [Ctrl]+[Alt]+[D]	<a href="#">Link the element</a> <sup>[599]</sup> to a rich text document.
Attributes [F9]	View and edit the <a href="#">attributes</a> <sup>[560]</sup> for the selected element.
Operations [F10]	View and edit the <a href="#">operations</a> <sup>[570]</sup> (methods) for the selected element.
Inline Features	See the element <a href="#">Inline Features Submenu</a> <sup>[68]</sup> .
Feature Visibility [Ctrl]+[Shift]+[Y]	Select which features and characteristics of the selected element are <a href="#">visible</a> <sup>[438]</sup> on a diagram.
Advanced	See the element <a href="#">Advanced Submenu</a> <sup>[68]</sup> .
Rich Text Format (RTF) Report	Generate a report for the currently selected package in <a href="#">rich text format</a> <sup>[1568]</sup> .
Source Code Engineering	See the element <a href="#">Source Code Engineering Submenu</a> <sup>[69]</sup> .
Open Source in External Editor [F12]	Open the source code of the selected Class in the default external editor for that language. (Source code must have been <a href="#">generated</a> <sup>[1308]</sup> , and the selected element must be a Class.)
Find in Project Browser [Alt]+[G]	Find the currently selected element in the <b>Project Browser</b> window. (If no element is selected, finds the current diagram in the <b>Project Browser</b> window.)
Find in Diagrams [Ctrl]+[U]	Display all occurrences of the currently selected element.
Custom References [Ctrl]+[J]	Show model element <a href="#">cross references</a> <sup>[527]</sup> .
Appearance	See the element <a href="#">Appearance Submenu</a> <sup>[69]</sup> .
Alignment	
Make Same	

Menu Option & Function Keys	Use to
Z Order	
Size	
Move	
Space Evenly	

#### 2.4.4.6.1 Inline Features Submenu

The **Inline Features** sub-menu provides various options to directly edit Class diagram model elements from the Class diagram. Select the **Element | Inline Features** menu option to access this submenu.

Menu Option & Function Keys	Use to
Edit Selected [F2]	Attach a note or attach a constraint to the element.
View Properties	Open the dialog containing details of the selected element feature, or the element if no feature is selected.
Insert New After Selected	Insert a new item in the element.
Create Linked Note	Add a Note element linked to the selected item, reflecting the content of that item.
Add Attribute [Ctrl]+[Shift]+[F9]	Add an <a href="#">attribute</a> <sup>[558]</sup> to the element.
Add Operation [Ctrl]+[Shift]+[F10]	Add an <a href="#">operation</a> <sup>[569]</sup> to the element.
Add Other [Ctrl]+[F11]	Insert a feature on the specific element item, such as Maintenance features and Testing features.
Delete Selected from Model [Ctrl]+[Shift]+[Delete]	Delete the selected item from the model.

Other options that are available while in editing elements mode in a diagram (when an attribute or operation is highlighted) include:

Key	Use to
[Enter]	Accept current changes.
[Ctrl]+[Enter]	Accept current changes and open a new slot to add a new item.
[Esc]	Abort edit, without save.
[Shift]+[F10]	Display the context menu for in-place editing.
[Ctrl]+[L]	Invoke the <a href="#">Set Element Classifier</a> dialog.

#### 2.4.4.6.2 Advanced Submenu

The **Advanced** sub-menu provides various options to choose from to customize the appearance of model elements. Select the **Element | Advanced** menu option to display this submenu.

Menu Option & Function Keys	Use to
Overrides & Implementations	Automatically <a href="#">override</a> <sup>[578]</sup> methods from parent Classes and from



Menu Option & Function Keys	Use to
[Ctrl]+[Shift]+[O]	realized interfaces.
Set Parents and Interfaces [Ctrl]+[I]	Manually set the element's <a href="#">parents or an interface</a> <sup>[526]</sup> that it realizes.
Embedded Elements [Ctrl]+[Shift]+[B]	<a href="#">Attach elements</a> <sup>[553]</sup> to the currently selected element.
Change Type	<a href="#">Change the element type</a> <sup>[532]</sup> of the selected element.

#### 2.4.4.6.3 Source Code Engineering Submenu

To forward and reverse engineer code using the language of your choice, select the **Element | Source Code Engineering** menu option.

Menu Option & Function Keys	Use to
Generate Current Element [F11]	<a href="#">Generate source code</a> <sup>[1309]</sup> for the currently selected element.
Synchronize Current Element [F7]	Synchronize the selected Class with the source code.
Batch Generate Selected Element(s) [Shift]+[F11]	Batch generate source code for the currently selected element(s).
Batch Synchronize Selected Element(s) [Ctrl]+[R]	Batch synchronize the currently selected element(s) with source code.
Open Source Directory [Ctrl]+[Alt]+[Y]	Open the directory containing the source for this element.

#### 2.4.4.6.4 Appearance Submenu

The **Appearance** sub-menu provides various options to choose from to customize the appearance of model elements.

Menu Option & Function Keys	Use to
Autosize [Alt]+[Z]	Auto-size a group of elements in a diagram to a best fit.
Default Appearance [Ctrl]+[Shift]+[E]	Set border, font and background color and border thickness for the selected element, as its <a href="#">default appearance</a> <sup>[538]</sup> .
Alternate Image [Ctrl]+[Shift]+[W]	Select an alternative image for the selected element.
Apply Image From Clipboard	Insert the image currently held on the clipboard.
Set Font	Change the <a href="#">font</a> <sup>[556]</sup> of the text displayed on the element in a diagram.

#### 2.4.4.6.5 Position Submenus

These **Element** menu submenus enable you to size and position elements on the diagram, relative to each other.

##### The Alignment Sub-Menu

Use the **Alignment** sub-menu to align the selected element(s) to each other.

Menu Option & Function Keys	Use to
Left [Ctrl]+[Alt]+[Left]	Align left edges of elements.
Right [Ctrl]+[Alt]+[Right]	Align right edges of elements.
Top [Ctrl]+[Alt]+[Up]	Align top edges of elements.
Bottom [Ctrl]+[Alt]+[Down]	Align bottom edges of elements.
Centers	Align centers of elements, horizontally or vertically.

##### The Make Same Sub-Menu

Use the **Make Same** sub-menu to make the selected elements the same width, the same height or both.

##### The Z Order Sub-Menu

Use the **Z Order** sub-menu to move the selected element(s) back, forward, to the front of all other elements or behind all other elements.

##### The Size Sub-Menu

Use the **Size** sub-menu to make the selected element(s) wider, narrower, taller or shorter by one increment. Alternatively, press [Ctrl]+[→], [←], [↑] or [↓].

##### The Move Sub-Menu

Use the **Move** sub-menu to move the selected element(s) left, right, up or down by one increment. Alternatively, press [Shift]+[→], [←], [↑] or [↓].

##### The Space Evenly Sub-Menu

Use the **Space** sub-menu to distribute the selected elements evenly.

Menu Option & Function Keys	Use to
Across [Alt]+[-]	Space elements evenly, horizontally.
Down [Alt]+[=]	Space elements evenly, vertically.

#### 2.4.4.7 Tools

The **Tools** menu provides access to various tools including those related to code engineering, managing .EAP files, spelling options, external resources and customization of features such as configuring shortcuts.

Menu Option & Function Keys	Use to
Spell Check Project [Ctrl]+[F7]	<a href="#">Spell check</a> <sup>1552</sup> the current project.
Spell Check Current Package	<a href="#">Spell check</a> <sup>1552</sup> the current package.

Menu Option & Function Keys	Use to
[Ctrl]+[Shift]+[F7]	
Spelling Language	Select a <a href="#">language</a> <sup>[1564]</sup> other than English in which to perform the spell check (having downloaded the language dictionaries from the Sparx Systems website).
Data Management	<a href="#">Manage your project's data</a> <sup>[71]</sup> .
Manage .EAP File	<a href="#">Repair, compact or replicate</a> <sup>[71]</sup> your .EAP file.
Run Patch	<a href="#">Execute an SQL patch</a> <sup>[346]</sup> .
Export Reference Data	<a href="#">Export reference data</a> <sup>[223]</sup> to XML files for convenient model updating.
Import Reference Data	<a href="#">Import reference data</a> <sup>[223]</sup> from XML files for convenient model updating.
Import Technology	<a href="#">Import</a> <sup>[107]</sup> an MDG Technology file. (This method no longer recommended.)
Generate MDG Technology File	Display the <a href="#">MDG Technology Wizard</a> <sup>[1118]</sup> .
Wordpad	Open Wordpad.
Windows Explorer	Open Windows Explorer. (Different options might be listed, to open other applications.)
Customize	<a href="#">Customize</a> <sup>[90]</sup> the operation of Enterprise Architect.
Options [Ctrl]+[F9]	Customize your general settings through the <a href="#">Options</a> <sup>[35]</sup> <a href="#">dialog</a> <sup>[35]</sup> .

#### 2.4.4.7.1 Data Management Submenu

Use the options on the **Data Management** submenu to manage your project's data.

Menu Option & Function Keys	Use to
Project Transfer	<a href="#">Move a complete project</a> <sup>[306]</sup> from one repository to another.  <b>Note:</b> You cannot move a project from a source .EAP file of a version earlier than 3.5.0.
Project Compare	<a href="#">Compare</a> <sup>[308]</sup> the total project sizes of two projects.
Project Integrity Check [Shift]+[F9]	Check the <a href="#">data integrity</a> <sup>[344]</sup> of a project.

#### 2.4.4.7.2 Manage .EAP File Submenu

Use the options on this submenu to repair, compact or replicate your .EAP file.

Menu Option	Use to
Repair .EAP File	<a href="#">Repair</a> <sup>[348]</sup> an Enterprise Architect project. If a project has not been closed properly, in rare cases it might not open correctly. This option attempts to repair such projects.

Menu Option	Use to
	<p><b>Note:</b></p> <p>All users must be logged off the project while it is being repaired.</p>
Compact .EAP File	<p><a href="#">Compact</a> <sup>[348]</sup> an Enterprise Architect project. Eventually projects might benefit from compacting to conserve space.</p> <p><b>Note:</b></p> <p>Ensure everyone is logged off the target project, then select this option to compact the project.</p>
Make Design Master	<a href="#">Make a design master</a> <sup>[185]</sup> project; this is the master project for creating replicas.
Create New Replica	Create a new <a href="#">replica</a> <sup>[184]</sup> from the <a href="#">Design Master</a> <sup>[185]</sup> .
Synchronize Replicas	<a href="#">Copy changes</a> <sup>[186]</sup> from one replica set member to another.
Remove Replication	<a href="#">Remove</a> <sup>[186]</sup> all replication features if you no longer require a model to be replicable.
Resolve Replication Conflicts	<a href="#">Resolve any conflicts</a> <sup>[187]</sup> caused when multiple users have changed the same element between synchronization points.

#### 2.4.4.8 Addins

The **Add-Ins** menu enables you to connect to, display information on, work with and manage your Add-Ins. The option displays only after you have installed an Add-In on your system.

Menu Option	Use to
Connect External Project	List external Add-Ins and, when you select one of them, open a project list for the Add-in. If there is only one active project available, the Add-In might automatically go on to open that project.
<Add-In Name>	Access <a href="#">the Add-In submenu</a> <sup>[72]</sup> for the selected Add-In.
Manage Add-Ins	<p>Display the <a href="#">Manage Add-Ins</a> <sup>[178]</sup> dialog, which you use to enable or disable Add-Ins for use.</p> <p>Any technology loaded by an Add-In is automatically enabled; if you do not want to use it, you can disable it on the dialog.</p>

#### Add-In Submenu

Menu Option	Use to
<Add-In specific options>	List options to perform various functions specific to the Add-In. For example, the MDG Technology For Zachman Framework, as an Add-In, has the options <b>Open Example Model</b> and <b>Insert New Framework Model</b> .
Help	Display the Help subsystem for the Add-In.
About	Display information on the Add-In installation, such as version, registration details and copyright statement.

### 2.4.4.9 Settings

The **Settings** menu enables you to configure various settings for your overall project.

Configure: the resources involved, general types, maintenance types, metrics and estimation types, stereotypes, Tagged Values, cardinality values, datatypes, language macros, local directories, image management, CSV import and export specifications, and reference data export/import.

Menu Option & Function Keys	Use to
<b>People</b>	Display the <a href="#">People</a> [645] dialog, which enables you to configure the authors, clients, resources and roles for your project.
<b>General Types</b>	Display the <a href="#">General Types</a> [653] dialog, which enables you to configure requirements, status types, constraints and scenarios for your project.
<b>Maintenance</b>	Display the <a href="#">Maintenance</a> [660] dialog, which enables you to track problem types and test types.
<b>Project Indicators</b>	Define the project indicators ( <a href="#">risks</a> [322], <a href="#">efforts</a> [319] and <a href="#">metrics</a> [320]) used in <a href="#">Resource Management</a> [313].
<b>Estimation Factors</b>	Display the <b>Estimation factors</b> dialog, which enables you to configure <a href="#">estimation</a> [335] factor types ( <a href="#">Technical Complexity Factors</a> [336], <a href="#">Environmental Complexity Factors</a> [337], and <a href="#">Default Hour Rate</a> [340]) for your project.
<b>UML</b>	Configure <a href="#">stereotypes</a> [662], <a href="#">Tagged Value Types</a> [664] and the <a href="#">cardinality list</a> [665] for your project.
<b>MDG Technologies</b>	Display the <a href="#">MDG Technologies</a> [1069] dialog, which enables you to load in and use MDG Technology files.
<b>Namespaces</b>	Locate and delete model <a href="#">namespaces</a> [1313].
<b>Template Package</b>	Configure or change the default element template directory.
<b>Local Paths</b>	Configure <a href="#">local directories and paths</a> [1343].
<b>Auto Name Counters</b>	Configure <a href="#">automatic naming</a> [525] for elements.
<b>Code Datatypes</b>	Add, modify and delete <a href="#">programming languages datatypes</a> [666].
<b>Database Datatypes</b>	Add, modify and delete <a href="#">database datatypes</a> [1037].
<b>Preprocessor Macros</b>	Add and delete <a href="#">preprocessor macros</a> [1344].
<b>Code Generation Templates [Ctrl]+[Shift]+[P]</b>	Modify code generation templates using the <a href="#">Code Templates Editor</a> [1301].
<b>Transformation Templates [Ctrl]+[Alt]+[H]</b>	Modify transformation templates using the <a href="#">Transformation Templates Editor</a> [1412].
<b>Images</b>	Open the <a href="#">Image Manager</a> [447].
<b>Colors</b>	Configure the custom colors for the project. There are two options: <ul style="list-style-type: none"> <li>• <b>Get Project Custom Colors</b> - get the custom colors</li> <li>• <b>Set Project Custom Colors</b> - set the custom colors</li> </ul> Custom colors are as used in the <a href="#">Appearance</a> [538] dialog.

### 2.4.4.10 Window

The **Window** menu provides access to various actions related to configuring open windows.

Menu Option & Function Keys	Use to
<b>Full Screen</b>	Reset the display to full screen so that only the work area and main menu are shown - no toolbars or windows.  To return to your normal working display, either click on the <b>Full Screen</b> option again or click on the <b>Close Full Screen</b> pop-up menu option.  You can also restore individual menus and toolbars using the <b>View</b> menu options.
<b>Close Active Window</b> [Ctrl]+[F4]	Close the window that currently has focus.
<b>Autohide Active Window</b> [Ctrl]+[Shift]+[F4]	<a href="#">Autohide</a> <sup>[78]</sup> the window that currently has focus.
<b>Autohide All Docked Windows</b>	<a href="#">Autohide</a> <sup>[78]</sup> all windows that are docked.
<b>Close Current View</b>	Close the current view.
<b>Close All Except Current</b>	Close all except the currently selected view.
<b>Reload Current View</b>	<a href="#">Refresh the current view</a> <sup>[267]</sup> .
<b>Save All Modified</b>	Save all modified data.
<b>Close All</b>	Close all opened windows in the main tab view.
<b>Always on Top</b>	Force the main Enterprise Architect window to be on top of all other windows.
<b>Set Focus to Current View</b> [Ctrl]+[Shift]+[0]	Make the current view the active one, so that key strokes immediately act on that view.

### 2.4.4.11 Help

The **Help** menu provides access to the Enterprise Architect help files, the Read Me file, the Enterprise Architect End User License Agreement and various features on the [Spax Systems website](#).

Menu Option	Use to
<b>About EA</b>	View information about Enterprise Architect, including your registration details.
<b>Register and Manage License Key(s)</b>	Configure and manage the license keys used to register the name and keys for Enterprise Architect and its Add-Ins. For more information see the <a href="#">License Management</a> <sup>[1867]</sup> topic.
<b>Read Me</b>	View the <i>Readme.txt</i> file, which details the changes and enhancements in Enterprise Architect, build by build.
<b>Open Example Model</b>	Open the <i>EA.Example</i> model provided with the Enterprise Architect installer.
<b>View License Agreement</b>	View the Enterprise Architect End User License Agreement.
<b>Ordering Information</b>	View information on how to purchase Enterprise Architect.
<b>Help Contents</b>	Display the introductory page of the Enterprise Architect Help.

Menu Option	Use to
Keyboard Accelerator Map	View the keyboard accelerator map. You can <a href="#">customize your keyboard shortcuts</a> <sup>[98]</sup> , if required.
On-Line Resources	See below.
Enterprise Architect on the Web	Visit the <a href="#">Sparx Systems website</a> .

## The On-Line Resources Sub-Menu

Access help and resources on-line at the [Sparx Systems website](#).

Menu Option	Use to
User Forum and News	Visit the Enterprise Architect <a href="#">user forum</a> .
Request-a-Feature	<a href="#">Request a feature</a> you would like to see in Enterprise Architect.
Bug Report Page	<a href="#">Report the details of a bug</a> you have found in Enterprise Architect.
Latest Version Details	Display the <b>Announcements</b> folder of the user forum, providing <a href="#">details of the latest Enterprise Architect build</a> .
Automation Interface	Access the Enterprise Architect <a href="#">Automation Interface</a> pages on the Sparx Systems website.
Introducing UML	Access the Sparx Systems online <a href="#">UML tutorials</a> .
Pricing and Purchase Options	<a href="#">Purchase or upgrade Enterprise Architect</a> over the internet.

## 2.4.5 Standard Windows

There are many [dockable](#)<sup>[76]</sup> windows available to use in Enterprise Architect. These can be accessed either:

- Through the **View** menu, or
- Through the context menu accessed by right-clicking on the main menu.

Having displayed a window, you can also reduce it to a tab off to one side, or [autohide](#)<sup>[78]</sup> it.

The dockable windows available include:

- [Project Browser](#)<sup>[1209]</sup>
- [Properties](#)<sup>[508]</sup>
- [System](#)<sup>[323]</sup>
- [Testing](#)<sup>[1537]</sup>
- [Maintenance](#)<sup>[1558]</sup>
- [Toolbox](#)<sup>[399]</sup>
- [Resources](#)<sup>[667]</sup>
- [Source Code Viewer](#)<sup>[1441]</sup>
- [Scripter window](#)<sup>[1660]</sup>
- [Debug](#)<sup>[1471]</sup>
- [Tasks Pane](#)<sup>[511]</sup>
- [Notes](#)<sup>[641]</sup>
- [Traceability](#)<sup>[1253]</sup>
- [Tagged Values](#)<sup>[632]</sup>
- [Project Management](#)<sup>[312]</sup>
- [Model Views](#)<sup>[1222]</sup>
- [Element Browser](#)<sup>[510]</sup>
- [Relationships](#)<sup>[1269]</sup>
- [Scenarios & Requirements](#)<sup>[514]</sup>

- [Pan & Zoom](#) <sup>[1275]</sup>
- [Layout Tools](#) <sup>[456]</sup>
- [Team Review](#) <sup>[208]</sup>
- [Diagram Filters](#) <sup>[1271]</sup>

**Tip:**

If the text in a window panel is too small to read comfortably, click on it, press and hold **[Ctrl]** and use the mouse wheel to expand and reduce the text size.

**Note:**

On the **Testing**, **Maintenance** and **Project Management** windows, any descriptive, history, input or results text for a selected item is also displayed in the **Notes** window. You cannot edit this text in the **Notes** window.

### 2.4.5.1 Dock Windows

A number of Enterprise Architect windows can be freely positioned on the screen, or docked against any edge of the *application workspace*. These windows are collectively called [dockable windows](#) <sup>[75]</sup>.

Drag the window around the application workspace until you find a comfortable way of working. The examples below describe a few ways you can rearrange the windows to suit your work habits.

#### Floating Windows

To float a window anywhere on the screen, just drag the window by its title bar to the required position.

#### Dock a Window Against an Edge

The *navigation compass* enables you to dock windows against an edge of the application workspace. You drag the window over one of the points of the compass to dock it into a tabbed location. The window does not overlap any other window, so if you are docking several windows you could cover the workspace; however, you can avoid this by combining them in a single [tabbed frame](#) <sup>[77]</sup>.

To dock a window against an edge, follow the steps below:

1. Click on the item to move and start dragging it towards the required position. This activates the navigation compass.



2. Drag the window onto a compass point. The screen display shades the area where the window is to be placed.
3. Release the mouse button over the compass point to confirm the position; this docks the window.

In the example below, when the mouse button is released the **Model Views** window is docked into the shaded area.



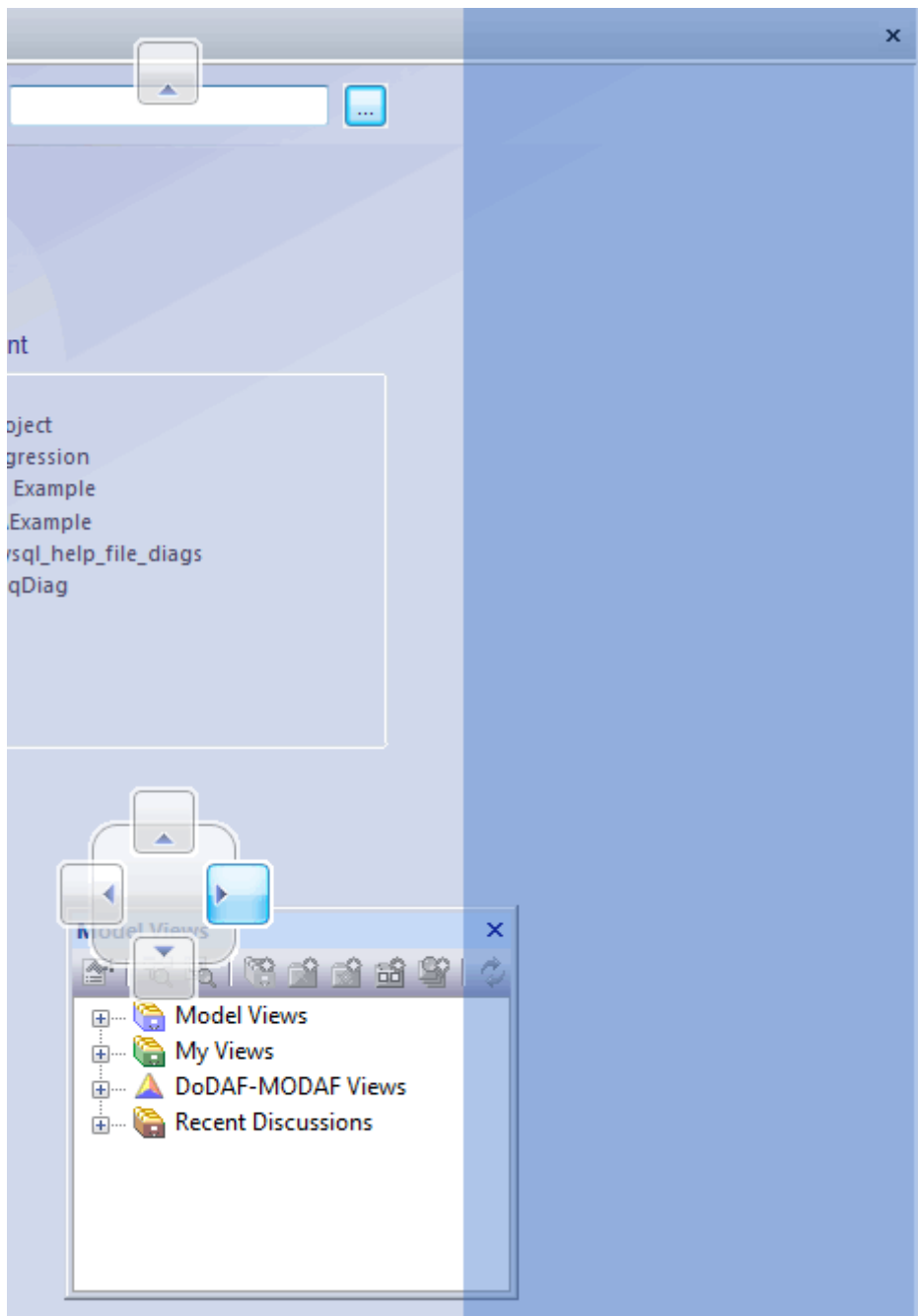

### Dock Required Windows into One Frame

You can also dock all of the windows you are using into a single frame, by either:

- Dragging the title bar of each window up to the title bar of the first docked window, or
- Dragging each window over the 'tabbed frame' icon in the middle of the compass, when another window is already docked.

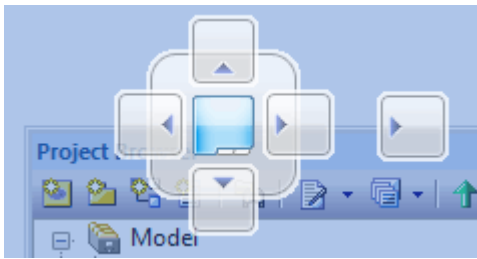

You can do this with all dockable windows. The following example shows the **Testing**, **Project Browser**, **Resources**, **Model Views** and **Tagged Values** windows all in one frame.

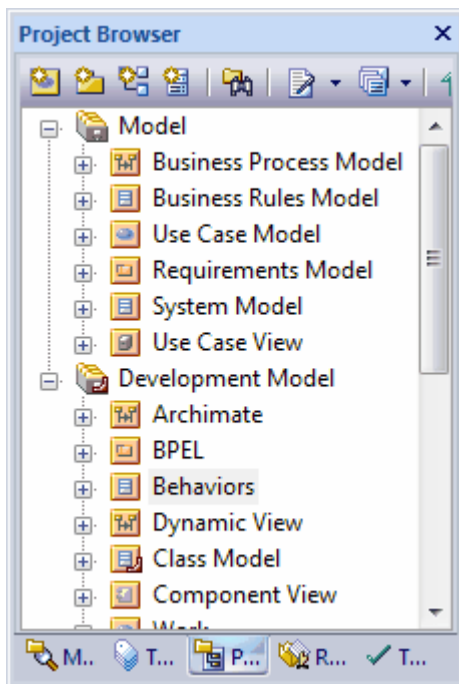

To separate a window from a combined frame, click on the window tab at the bottom of the frame and drag it away.

### 2.4.5.2 Autohide Windows

#### Autohide Using the Toggle Button

You can automatically hide browser frames by clicking on the  button, located in the top right corner of the frame.



To turn off the autohide for a particular set of windows within a frame, click on the  button.



## Use Automatically Hidden Windows

When you automatically hide a set of windows in a frame, the tabs contract to the outside of the application workspace.

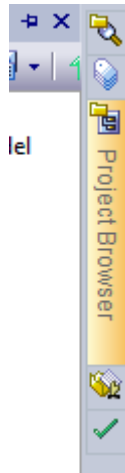

Hover the cursor over a window symbol to expand both the tab and the associated window.

### Tip:

You can also use the **View | Visual Style | Animate Autohide Windows** menu option to animate windows that have been automatically hidden.

## 2.4.6 Standard Toolbars

Enterprise Architect provides you with a selection of toolbars that you can drag and dock within the application frame.

These toolbars provide convenient shortcuts to common tasks. You can also float toolbars over the application by dragging them off the application toolbar section; this is useful when you are using a certain set of functions a lot in a particular area.

You can customize toolbars by deleting and reordering the default button set. See [Customize Commands](#) <sup>91</sup> for more information. You can customize which toolbars are active by right-clicking on the toolbar background and selecting the required items at the end of the context menu.

### Note:

You can dock toolbars to the edge of the Enterprise Architect workspace by dragging them by the title bar and placing them against the appropriate edge. The example below shows the **Default Tools** toolbar docked to the left side of the workspace:

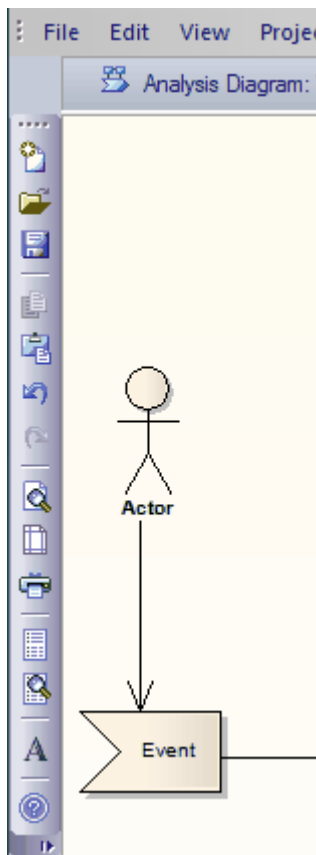

The toolbars available include:

- [Default Tools Toolbar](#) <sup>[80]</sup>
- [Project Toolbar](#) <sup>[81]</sup>
- [Code Generation Toolbar](#) <sup>[81]</sup>
- [UML Elements Toolbar](#) <sup>[83]</sup>
- [Diagram Toolbar](#) <sup>[83]</sup>
- [Current Element Toolbar](#) <sup>[84]</sup>
- [Current Connector Toolbar](#) <sup>[84]</sup>
- [Format Toolbar](#) <sup>[85]</sup>
- [Workspace Layouts Toolbar](#) <sup>[86]</sup>
- [Status Bar](#) <sup>[89]</sup>
- [Notes Toolbar](#) <sup>[642]</sup>

Each toolbar has a drop-down arrow at the right-hand end, , which can be [enabled or hidden](#) <sup>[60]</sup>. If you click on this drop-down arrow, the **Add or Remove Buttons** option displays. Select this option to show a context menu listing the toolbars that are currently displayed, and an option to [customize](#) <sup>[90]</sup> both your own toolbars and the system-provided toolbars.

You can select one of the toolbars identified on the context menu to list the icons available through that toolbar. Click on the icons as necessary to hide or show them in the toolbar.

### 2.4.6.1 Default Tools Toolbar



The **Default Tools** toolbar provides quick access to the following functions (in order):

- New project **[Ctrl]+[N]**
- Open a project **[Ctrl]+[O]** - click on the folder icon to display the [Open Project](#) <sup>[114]</sup> dialog, which enables you to open files or connect to a server, or click on the drop-down arrow to display a list of recently-opened projects and select one of those
- Save current diagram **[Ctrl]+[S]**
- Cut selected element(s) from diagram **[Ctrl]+[X]** (the element is not removed from the source diagram until it is pasted from the clipboard into another diagram)
- Copy to Enterprise Architect clipboard **[Ctrl]+[Space]**
- Paste from Enterprise Architect clipboard as instance **[Shift]+[Insert]**
- Undo last action **[Ctrl]+[Z]**
- Redo last undone action **[Ctrl]+[Y]**
- Print Preview (for generated documents and diagrams)
- Page setup
- Print **[Ctrl]+[O]**
- Show **Element List** for currently-selected package or diagram **[Ctrl]+[Alt]+[R]**
- Open **Model Search** **[Ctrl]+[Alt]+[A]**
- Select the layout of docked windows, toolbars and the **Toolbox** (<default> is Enterprise Architect, other options display for any [MDG Technologies](#) <sup>[1069]</sup> you have enabled)
- Help **[F1]**.

You can move this toolbar to any dockable position and it retains that position in subsequent sessions. You can hide or show the toolbar by clicking on the **View | Toolbars | Default Tools** menu option.

### 2.4.6.2 Project Toolbar



The **Project** toolbar provides quick access to the following functions (in order):

- [Reload current project](#) <sup>[267]</sup> **[Ctrl]+[Shift]+[F11]**
- New diagram
- New package **[Ctrl]+[W]**
- New element **[Ctrl]+[M]**
- Search **Project Browser** window **[Ctrl]+[Shift]+[F]**
- Search entire project, using [Model Search](#) <sup>[1233]</sup> **[Ctrl]+[F]**
- New RTF document **[F8]**
- Project issues
- Project glossary
- Options (preferences) **[Ctrl]+[F9]**

You can move this toolbar to any dockable position and it retains that position in subsequent sessions. You can hide or show the toolbar by clicking on the **View | Toolbars | Project** menu option.

### 2.4.6.3 Code Generation Toolbar



The **Code Generation** toolbar provides quick access to the following functions (in order):

- Set the default language
- Set the default database
- Import Classes and Interfaces from source files (see menu below)
- Generate code for a single selected Class **[F11]**

- Batch generate code for one or more selected Classes **[Shift]+[F11]**
- Synchronize selected Classes with source code **[F7]**
- [View code](#)  in default editor **[F12]**.

### Set Default Code Language

To set the default language for the model click on the **Default Language** drop-down arrow and select the appropriate language.

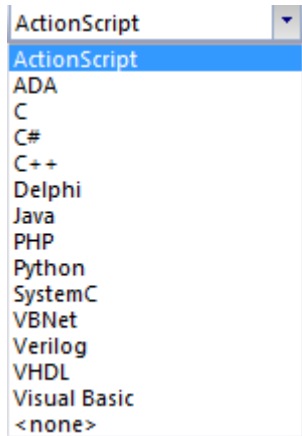

### Set Default Database

To set the default database type for modeling click on the **Default Database** drop-down arrow and select the appropriate database type.

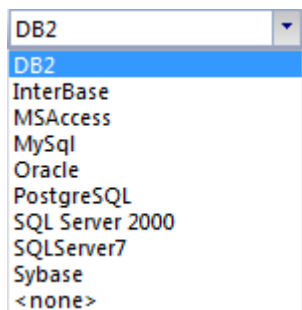

### Import Code

To select a language for code generation, click on the drop-down arrow for the **Import** button.

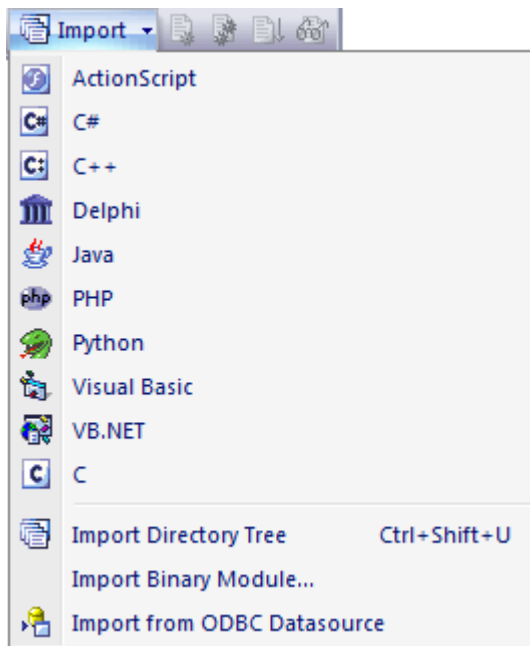

You can move this toolbar to any dockable position and it retains that position in subsequent sessions. You can hide or show the toolbar by clicking on the **View | Toolbars | Code Generation** menu option.

#### 2.4.6.4 UML Elements Toolbar



The **UML Elements** toolbar provides quick access to the following functions (in order):

- Insert new element - displays a [list of elements](#)<sup>[523]</sup> matching the content of the current **Toolbox** pages, with an **Other** option to list other elements
- Insert new [System Boundary](#)<sup>[802]</sup> element
- Insert new [Note](#)<sup>[536]</sup>
- Insert new [Text element](#)<sup>[536]</sup>
- Insert new [diagram note](#)<sup>[440]</sup>
- [Insert diagram Legend](#)<sup>[441]</sup>
- Insert new [hyperlink](#)<sup>[840]</sup>
- Insert [new note link](#)<sup>[886]</sup>.

You can move this toolbar to any dockable position and it retains that position in subsequent sessions. You can hide or show the toolbar by clicking on the **View | Toolbars | UML Elements** menu option.

The specific elements and the Notelink connector are also available in the [Common](#)<sup>[405]</sup> page of the **Toolbox**.

#### 2.4.6.5 Diagram Toolbar



The **Diagram** toolbar provides quick access to the following functions (in order):

- Align selected elements to the left **[Ctrl]+[Alt]+[←]**
- Align selected elements to the right **[Ctrl]+[Alt]+[→]**
- Align selected elements to the top **[Ctrl]+[Alt]+[↑]**

- Align selected elements to the bottom **[Ctrl]+[Alt]+[↓]**
- Bring selected element to top of Z order
- Move selected element to bottom of Z order
- Go to previous diagram **[Alt]+[←]**
- Go to next diagram **[Alt]+[→]**
- Go to default diagram
- Zoom In
- Zoom Out
- Zoom to fit diagram
- Zoom to fit page
- Zoom to 100%
- Auto-layout diagram (not for Behavioral diagrams) in the [Digraph](#)<sup>[465]</sup> layout
- Show diagram properties **[F5]**
- Paste appearance as copied into the Painter from an element's [Appearance](#)<sup>[555]</sup> context menu
- Delete selected element(s) **[Ctrl]+[D]**

Any actions that result in a change in diagram content and appearance (including Zoom) can be saved as changes to the diagram.

You can move this toolbar to any dockable position and it retains that position in subsequent sessions. You can hide or show the toolbar by clicking on the **View | Toolbars | Diagram** menu option.

#### 2.4.6.6 Current Element Toolbar



The **Current Element** toolbar provides quick access to the following functions (in order):

- View and modify element properties **[Alt]+[Enter]**
- Set an element's parent or implement interfaces **[Ctrl]+[I]**
- View and modify Operations **[F10]**
- View and modify Attributes **[F9]**
- Specify the visibility of element features and compartments **[Ctrl]+[Shift]+[Y]**
- Specify the run state of an element (or, for Parts, property value) **[Ctrl]+[Shift]+[R]**
- View use of element in other structures such as diagrams **[Ctrl]+[U]**
- Locate the element in the **Project Browser** window **[Alt]+[G]**
- View the cross reference list for this element **[Ctrl]+[J]**
- Lock or unlock the current element

##### Note:

This does not apply in the Corporate, Business and Software Engineering, Systems Engineering and Ultimate editions if security is enabled. In that case, see the [Lock Model Elements](#)<sup>[204]</sup> topic.

- Add a Tagged Value to the current element **[Ctrl]+[Shift]+[T]**

You can move this toolbar to any dockable position and it retains that position in subsequent sessions. You can hide or show the toolbar by clicking on the **View | Toolbars | Current Element** menu option.

#### 2.4.6.7 Current Connector Toolbar



The **Current Connector** toolbar provides quick access to the following functions (in order):

- View and modify properties for the current connector



- Set the connector line style

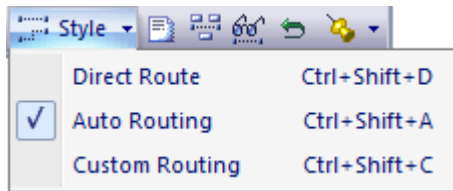

- Attach a note to the currently selected connector
- Set the visibility for labels of the connector
- Set the visible or hidden relations in the current diagram **[Ctrl]+[Shift]+[I]**
- Reverse the direction of the currently selected connector
- Pin the start and/or connector ends to a position on the target element (drop menu).

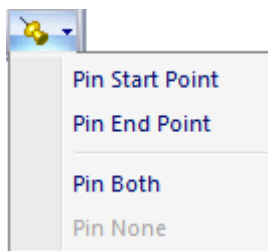

You can move this toolbar to any dockable position and it retains that position in subsequent sessions. You can hide or show the toolbar by clicking on the **View | Toolbars | Current Connector** menu option.

#### 2.4.6.8 Format Toolbar



Use the **Format** toolbar to change the appearance of a selected element (or several selected elements) in the current diagram; this does not affect any other occurrence of the selected elements anywhere else in the model.

##### Notes:

- To set the global appearance of all elements throughout a model, use the **Options** dialog. Select the **Tools | Options** menu option, then select **Standard Colors** <sup>(353)</sup> and **Diagram | Appearance** <sup>(356)</sup> from the options tree.
- To override the global appearance and define a default appearance of a selected element (or several selected elements) on all diagrams on which it occurs, right-click on the element and select the **Appearance | Default Appearance** context menu option. The **Default Appearance** <sup>(538)</sup> dialog displays.

The **Format** toolbar provides quick access to the following functions (in order):

- Text font, style, size and effects, through the **Font** <sup>(556)</sup> dialog
- Text Color (drop-down color palette)
- Fill Color (drop-down color palette)
- Border or Connector Line Color (drop-down color palette)
- Border or Connector Line Width (arrows increase/decrease between **1** and **5**)
- Apply Style to Element(s)
- Copy Style from Element
- Style list for selecting saved styles
- Save style (see below).

If you click on the drop-down arrow for the **Save Style** (pencil) button, you can select an option from the

following list:

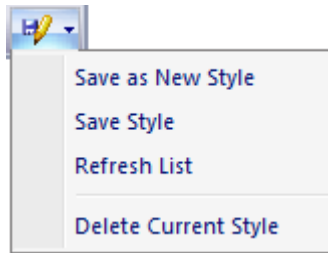

The **Fill Color** button can be used in conjunction with the **Project Custom Colors** menu options to enable users to have access to custom-defined project colors. To activate this feature select the **Tools | Options | Standard Colors** menu option and ensure that the **Show Project Custom Colors in Element Format** checkbox is selected. To define a set of custom colors see the [Get and Set Project Colors](#)<sup>[540]</sup> topic.

You can move this toolbar to any dockable position and it retains that position in subsequent sessions. You can hide or show the toolbar by clicking on the **View | Toolbars | Format Tool** menu option.

### 2.4.6.9 Workspace Layouts



The **Workspace Layouts** toolbar provides a range of facilities for changing the content and layout of the Enterprise Architect workspace.

You can move this toolbar to any dockable position and it retains that position in subsequent sessions. You can hide or show the toolbar by clicking on the **View | Toolbars | Workspace Layouts** menu option.

The facilities on the toolbar, from left to right, are described in the following paragraphs.

#### Save Workspace Layout As

If you have manually created or adjusted an arrangement of windows and toolbars to suit your work requirements, you can capture that layout for future use.

Click on the toolbar icon and, in the **Custom Workspace Layout Name** field at the bottom of the **Save Custom Workspace Layout** dialog, type a name for the layout. Click on the **Save** button. The layout is added to the **Available Custom Workspace Layouts** list.

You can also select an existing workspace layout from the list and save the new layout under the existing name.

#### Manage Workspace Layouts

The **Manage Workspace Layouts** icon displays the **Workspace Layout** dialog, which lists the currently-available user-defined and system layouts.

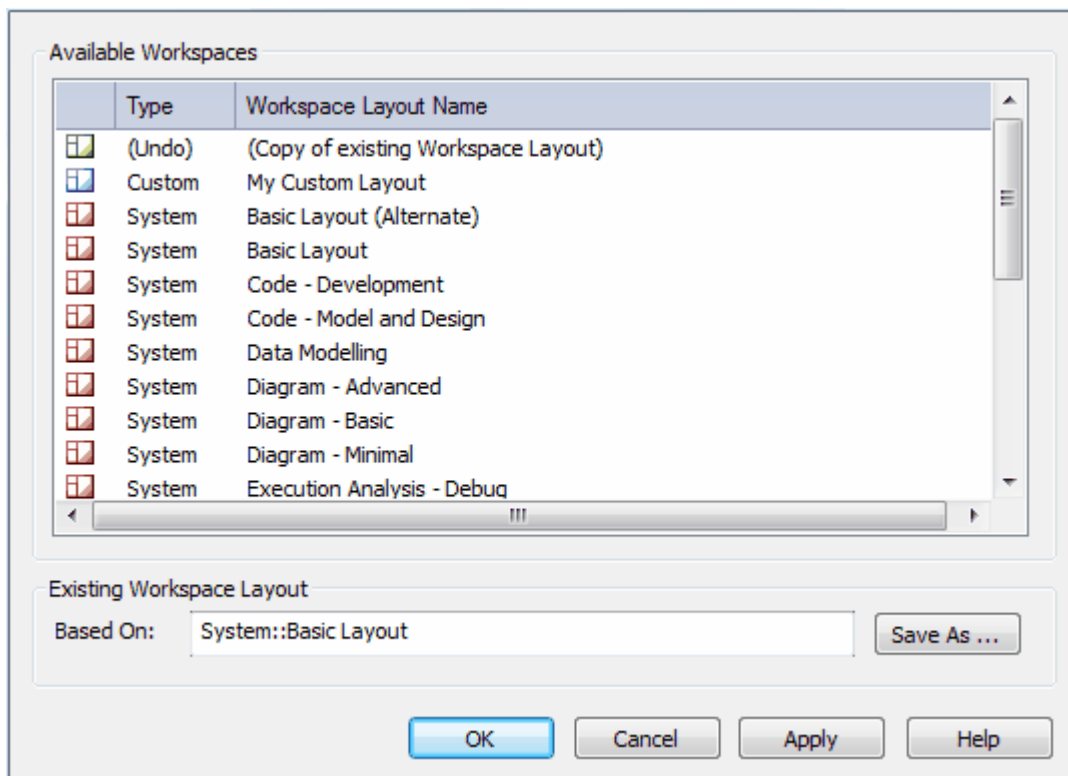

In the **Existing Workspace Layout** panel at the bottom of the dialog, the **Based On:** field identifies the defined layout that the current workspace layout was derived from - you might have moved or closed windows since applying that layout. The highlighted *(Copy of existing Workspace Layout)* at the top of the **Workspace Layout** dialog is a capture of the workspace layout immediately before you opened the dialog.

### Change Layout

You can now change the layout in the **Existing Workspace Layout** panel to:

- The original layout (as identified by the **Based On:** field), discarding any changes you might have made
- The *Copy of existing Workspace Layout*, preparatory to saving the changes in a new named layout
- One of the other named layouts.

To change the layout in use, either:

- Double-click on the required layout name
- Click on the layout name and click on the **Apply** button or **OK** button, or
- Right-click on the layout name and select the **Apply** context menu option.

When the layout in use changes, the layout name in the toolbar **Workplace Layout Selection** field also changes.

### Copy Layout

To copy a layout (such as the one at the top of the list), either:

- Change the layout in use to the required layout (as above) and click on the **Save As** button, or
- Right-click on the layout name and select the **Save As** context menu option.

The **Save Custom Workspace Layout** dialog displays.

Available Custom Workspace Layouts:

Type	Workspace Layout Name
------	-----------------------

Custom Workspace Layout Name:  
Copy of Code - Development

Include active custom views  
eg. Relationship Matrix, Rules/Scenarios

Save Cancel

In the **Custom Workspace Layout Name** field, type a name for the layout. Again, by selecting an existing name you can change an existing layout to something different. Click on the **Save** button.

If you already have tailored windows or views that you want to include in your selected layout, select the **Include active custom views** checkbox.

### Delete Layout

To delete a workspace layout, right-click on the layout name and select the **Delete** context menu option. Enterprise Architect prompts you to confirm or cancel the deletion.

### Workspace Layout Selection

Enterprise Architect provides a number of layouts of windows and toolbars to suit particular areas of work, such as Requirements Management, Code Engineering and Debugging. As described above, you can also add your own layouts to the drop-down list; these custom layout names have a preceding asterisk in the drop-down list for the field (the system-provided layouts are not marked with an asterisk).

To switch to another layout, click on the drop-down arrow and click on the required layout.

**Note:**

When you upgrade your system to a new edition of Enterprise Architect, the new edition might contain window or toolbar layout changes made by Sparx Systems. These changes might impact your previously-customized workspace layouts. In such cases, when you select each of your customized layouts in the **Selection** field, the following prompt displays:

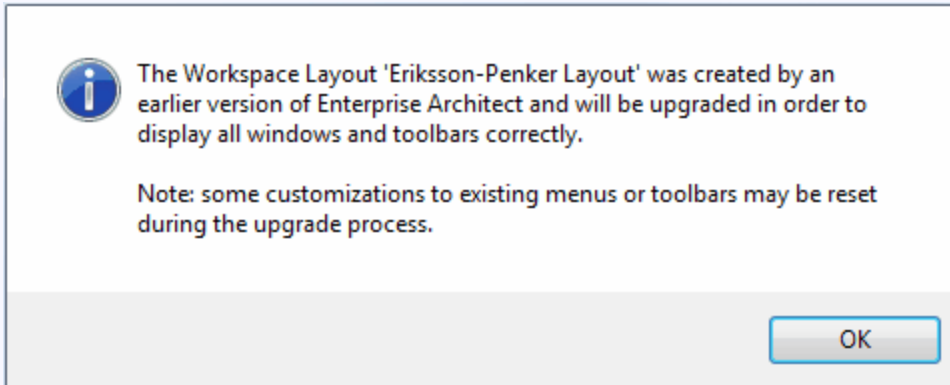

Click on the **OK** button to ensure that your customized layout contains the system upgrades.

**Views**

Clicking on the drop-down arrow for the **Views** icon lists options for displaying various views of information on model content, such as the [Element List](#)<sup>[125]</sup>, [Model Search](#)<sup>[123]</sup> and [Relationship Matrix](#)<sup>[126]</sup>. Click on the appropriate option to display the required view screen.

**Windows**

Clicking on the drop-down arrow for the **Windows** icon lists options for opening each of the Enterprise Architect windows (as on the [View](#)<sup>[58]</sup> menu options). Click on the appropriate option to open the required window, or to transfer control to the window if it is already open.

**Toolbars**

Clicking on the drop-down arrow for the **Toolbars** icon lists options for opening or hiding each of the nine Enterprise Architect main [toolbars](#)<sup>[79]</sup> and the diagram [Status Bar](#)<sup>[89]</sup>. Click on the appropriate option to hide or display the required toolbar.

**Full Screen**

Click on this icon to switch the Enterprise Architect display to [Full Screen](#)<sup>[74]</sup> mode. A small dialog displays to enable you to switch back to normal mode. Alternatively, click on the **Window | Full Screen** menu option.

**2.4.6.10 Status Bar**

The **Status** bar displays at the bottom of the Enterprise Architect workspace. It provides feedback on current operations and other status information, and enables you to enlarge the scale of the diagram.

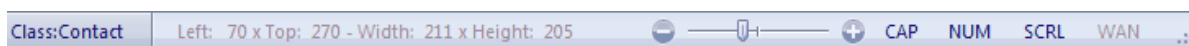

In particular the **Status** bar:

- Identifies the type and name of the currently selected element in a diagram (or the status of a **Model Search**)
- Identifies the name of the currently-selected feature, if one is selected
- Provides the current coordinates of the top left corner of the selected element, and its width and height

- Provides a zoom slider that enables you to enlarge the scale of the current diagram by up to 50%

**Note:**

This facility has no impact on other users who might view the diagram. It has the same function as the **Scale view by** field on the [Diagram Appearance](#) <sup>[356]</sup> page of the **Options** dialog; changes in the 'zoomed' display scale of a diagram update this field and are applied to any other diagrams that you open.

This also has no impact any other diagram Zoom facility in Enterprise Architect.

- Indicates the status of **[Caps Lock]**, **[Num Lock]**, **[ScrLk]** (scroll lock) and the WAN Optimizer (bold indicates 'in use', pale indicates 'off')
- Indicates, by the presence of a triangle in the bottom right corner, that the screen is not maximized; you can drag the screen corner to increase the size of the window.

If you right-click on the **Status** bar, a context menu displays that enables you to hide or show the element name, element coordinates, zoom slider or status indicators.

You can hide or show the **Status** bar from the **View | Toolbars | Status Bar** menu option, but you cannot dock it in any other position.

## 2.4.7 Customization

You can configure various settings using the [Options](#) <sup>[350]</sup> dialog, which you display by selecting the **Tools | Options** menu option. In addition, there are several options to change the [overall look and feel of Enterprise Architect](#) <sup>[107]</sup> in the **View | Visual Style** submenu. Those settings and options are explored in this topic.

On occasion, you might want to use Enterprise Architect for two distinct types of operation at the same time. You can do this by adding the following command line argument when you run Enterprise Architect:

```
/regkey:<regkeyname>
```

This stores registry settings - such as window layouts - to a different path in the registry.

**See Also**

- [Workspace Layouts](#) <sup>[86]</sup>

### 2.4.7.1 The Customize Dialog

The **Customize** dialog enables you to customize [Commands](#) <sup>[91]</sup>, [Toolbars](#) <sup>[92]</sup>, [Tools](#) <sup>[94]</sup>, [Keyboard Keystrokes](#) <sup>[98]</sup>, [Menus](#) <sup>[100]</sup> and [Options](#) <sup>[101]</sup> within Enterprise Architect. To display this dialog, either:

- Select the **Tools | Customize** <sup>[70]</sup> menu option, or
- At the far right of any [toolbar](#) <sup>[79]</sup>, click on the drop-down arrow (if it is [enabled](#) <sup>[60]</sup>) and on the **Add or Remove buttons** option, then select the **Customize** option.

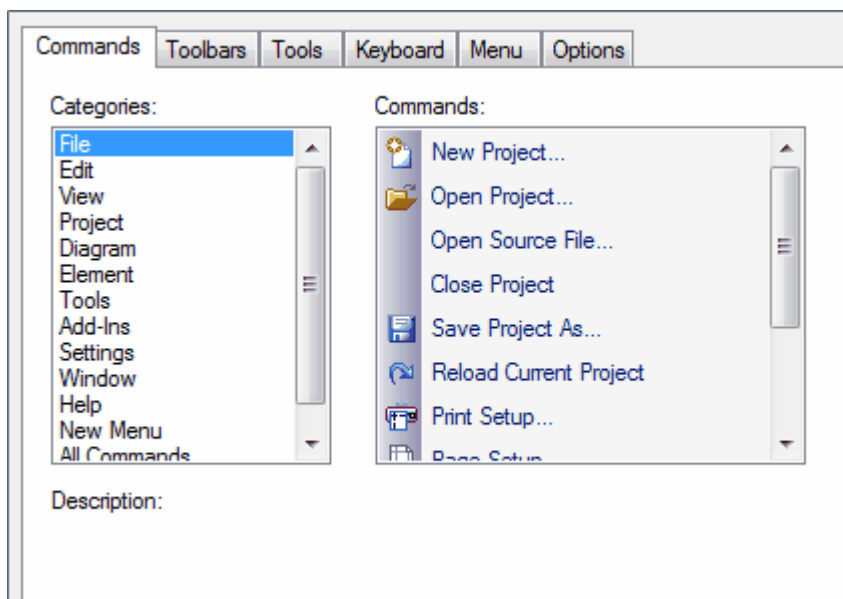

**Note:**

If a documented toolbar icon, keyboard combination or menu option does not appear to be available, select the appropriate tab and click on the **Reset** or **Reset All** button. This restores the toolbar, menu or key settings to the defaults.

**However:**

Be aware that this also removes any customized icons, options or combinations you might have set, because it is possible that the customization itself has displaced or affected the default setting.

**2.4.7.1.1 Customize Commands**

The **Customize** dialog **Commands** tab provides access to many of Enterprise Architect's functions, enabling you to place them into a toolbar.

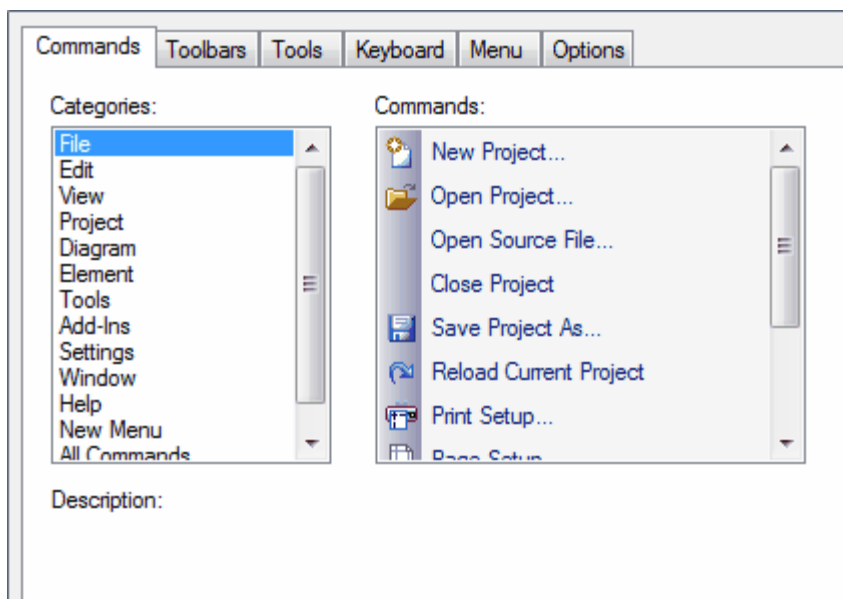

To add a command to a toolbar, click on the category in the **Categories:** panel and select the command from the list for that category in the **Commands:** panel. Drag the command on top of the toolbar to add it to.

If you right-click on the command icon in the toolbar while the **Customize** dialog is open, a context-sensitive menu displays. This menu offers options for deleting commands from a toolbar, and for changing the appearance of commands.

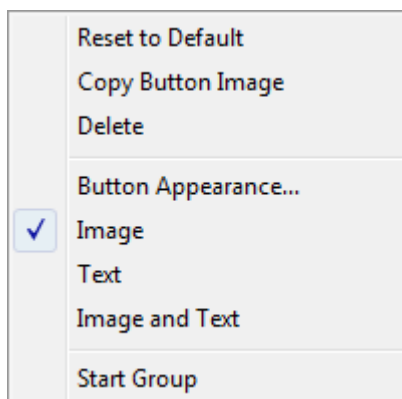

To remove a command from the toolbar, right-click on the command graphic or text and select the **Delete** menu option.

To change the appearance of a command graphic, right-click on the command graphic or text and select the

**Button Appearance** context menu option. The **Button Appearance** dialog displays, which you can use to add graphical icons to commands that do not have them by default.

**Note:**

Some commands do not come with a convenient icon, which results in an empty toolbar button. Either avoid placing these commands on toolbars or use the context-sensitive menu to select an appropriate icon for the command.

**Tip:**

Read the [Create a New Toolbar and Populate it with Commands](#)<sup>92</sup> procedure of the *Customize Toolbars* topic.

### 2.4.7.1.2 Customize Toolbars

The **Toolbars** tab on the **Customize** dialog enables you to:

- Hide or show toolbars by selecting the appropriate checkbox
- Rename toolbars
- Create new toolbars
- Delete toolbars
- Modify toolbar contents by dragging commands from the **Commands**<sup>91</sup> tab onto a visible toolbar
- Reset a toolbar (or all toolbars) to the default contents and position, and
- Display text labels under the toolbar icons (perhaps temporarily, just to check what the icons do).

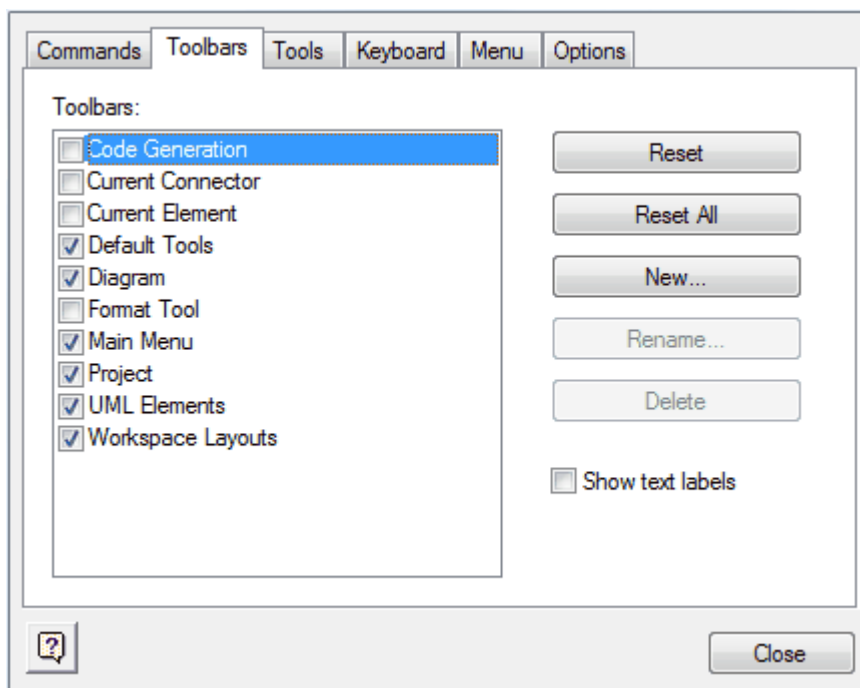

### Create a New Toolbar and Populate it with Commands

To create a new toolbar and populate it with commands:

1. Select the **Tools | Customize** menu option. The **Customize** dialog displays.
2. Click on the **Toolbars** tab.
3. Click on the **New** button. The **Toolbar Name** dialog displays.





Toolbar Name:

OK

Cancel

4. In the **Toolbar Name** field, type a name for your new toolbar and click on the **OK** button. Your new toolbar is created.

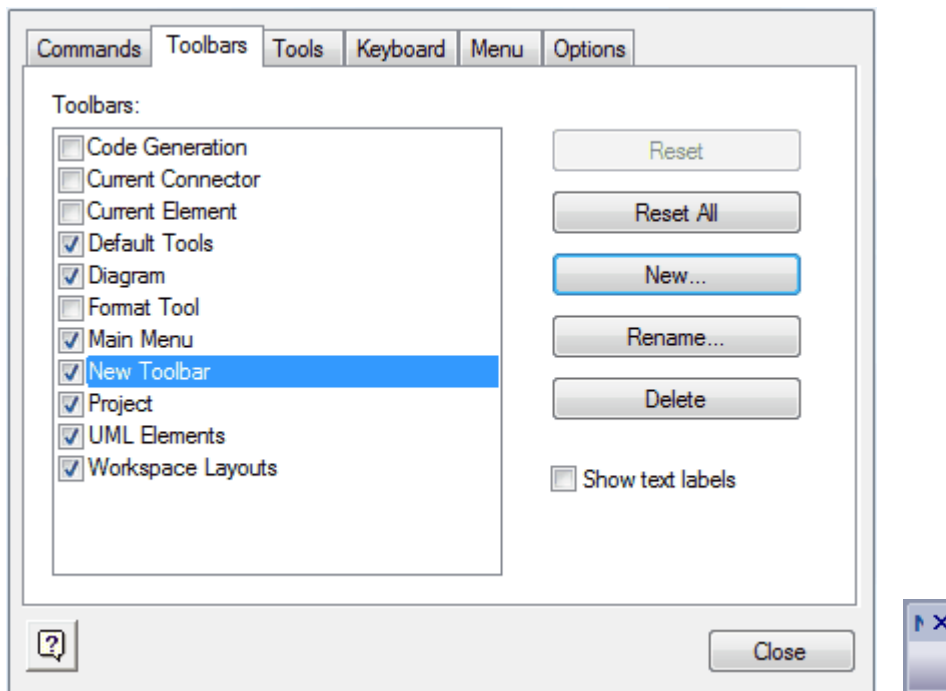
**Note:**

You can select the **Show text labels** checkbox to display textual descriptions of toolbar items.

5. Now add commands to your toolbar. Click on the **Commands** tab. This forces the new toolbar behind the **Customize** dialog, so you might have to drag the **Customize** dialog to the side to find your new toolbar.

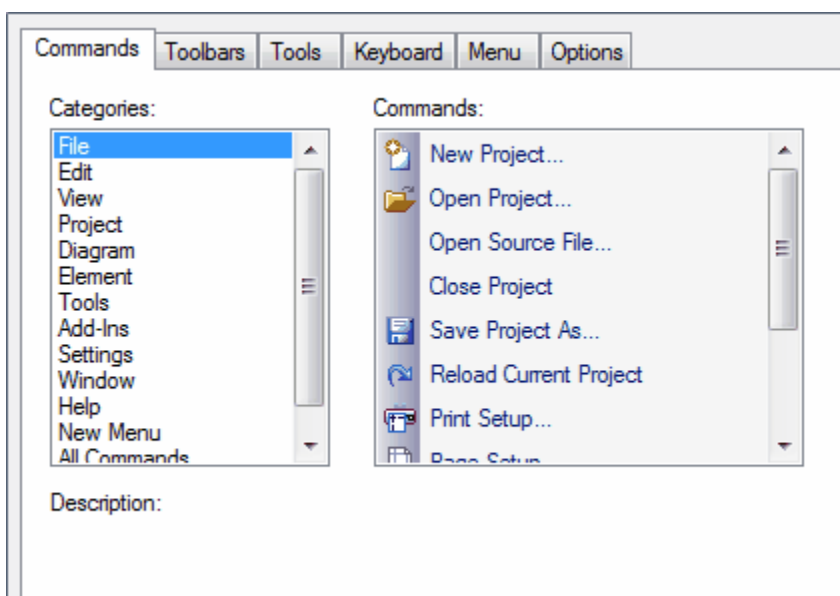

- Find the command to add to your toolbar in the **Commands** list. The **Categories** list on the left represents the Enterprise Architect menu structure and the **Commands** list updates each time you click on a different category.
- Drag the selected command from the list into the new toolbar. If you selected the **Show text labels** checkbox, your toolbar should now look like this:



If you did not select the **Show text labels** checkbox, your toolbar should look like this:



You can add as many commands to your toolbar as required. Your new toolbar behaves the same way as other toolbars; you can position it next to the other toolbars at the top of the application workspace, dock it to the side of the workspace or close it.

### 2.4.7.1.3 Custom Tools

The **Tools** tab on the **Customize** dialog provides a means of extending the power of the Enterprise Architect desktop.

From this toolbar you can configure custom tools and make them accessible from the **Main Menu**. You can create menu options that hyperlink to different applications, compilers, batch scripts, automation scripts, URLs or documentation.

#### Add and Configure Custom Tools

- Select the **Tools | Customize** menu option. The **Customize** dialog displays.
- Click on the **Tools** tab.

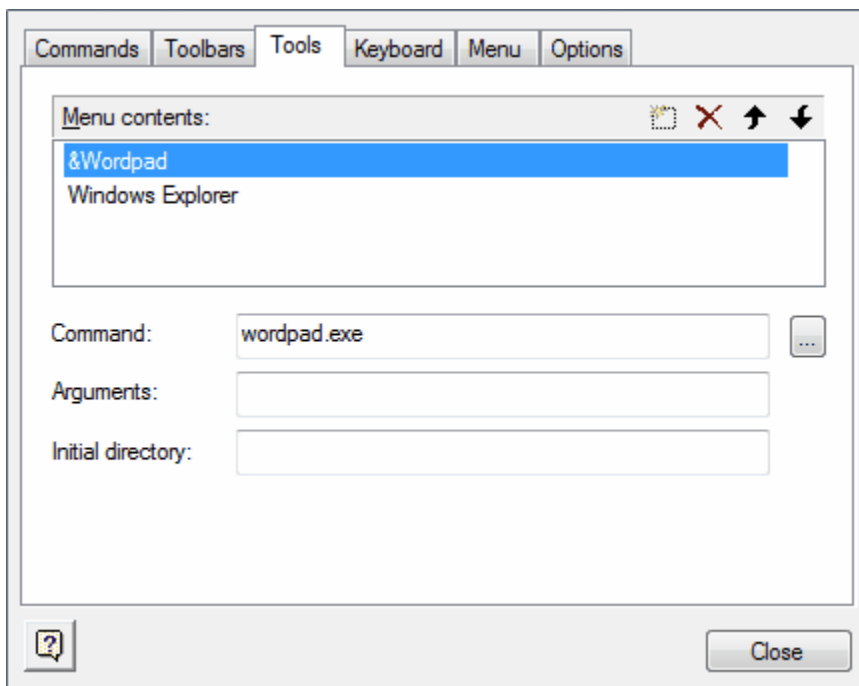

- Click on the **New** icon (left of the red **X**). A blank field displays in the **Menu contents** list.

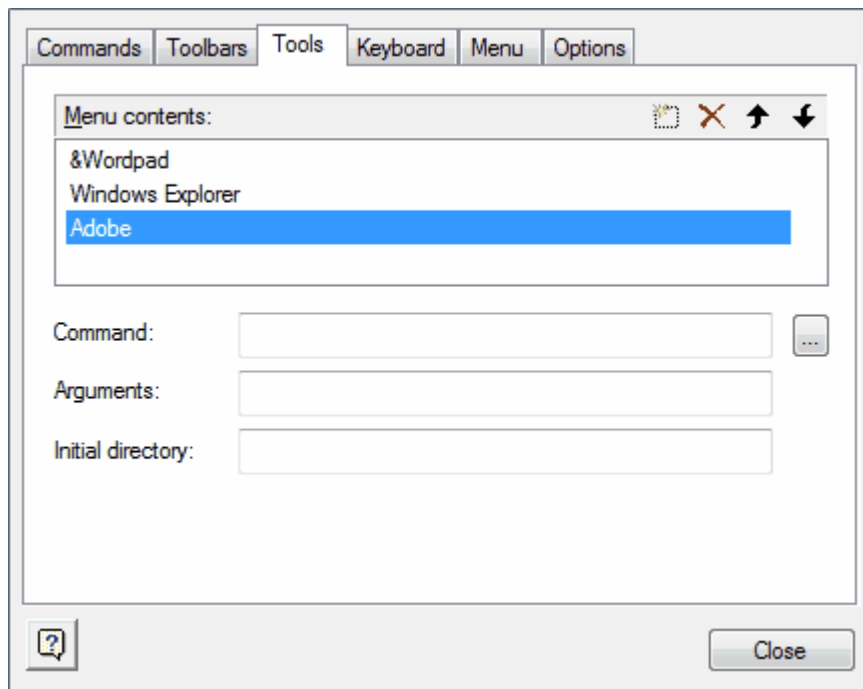

4. Type in the name of the tool as it should appear in the menu.
5. In the **Command** field, type the name of the tool .exe file to use; the tool must be a valid filename.

**Note:**

Programs installed with your operating system (such as Notepad, Wordpad) do not require a full file path. Programs installed separately (such as Microsoft Visual Studio) require the full file path in the **Command** field. If necessary, use the [ ... ] (Browse) button to locate the tool in the file system.

6. Add any arguments required by the tool (see [Opening External Tools](#)<sup>[96]</sup> and [Passing Parameters to External Applications](#)<sup>[97]</sup>), and specify an initial directory if required.
7. Close the **Customize** dialog. Your tool should have now been added to the **Tools** menu as shown below.

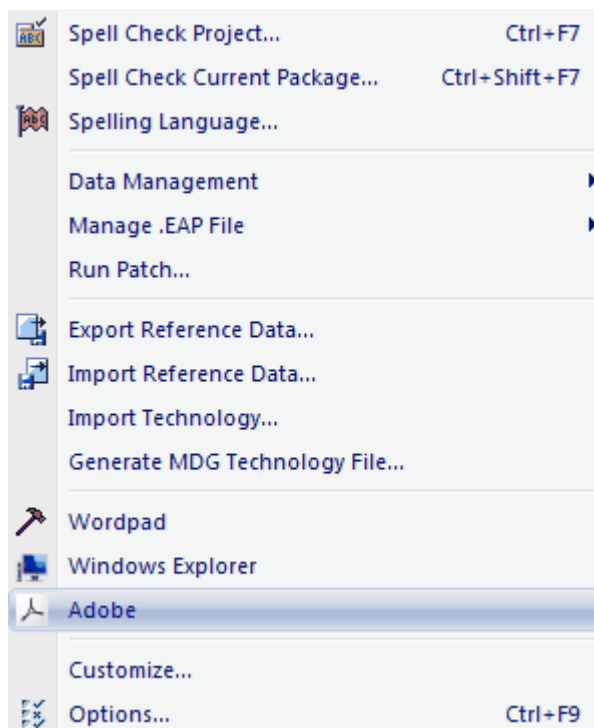

### 2.4.7.1.3.1 Open External Tools

When configuring custom tools in Enterprise Architect, you can specify a file to be opened by the external application.

Select the **Tools | Customize** menu option. The **Customize** dialog displays; click on the **Tools** tab. Now you can:

- Specify a [custom tool](#) <sup>[94]</sup> (application) using the **Command** field
- Define a file to open or [parameters to pass](#) <sup>[97]</sup> to this application, using the **Arguments** field.

#### Example 1

This example opens the file `c:\Temp\Customer Account.cls` using Wordpad. If you save from within Wordpad the initial directory is `c:\Temp`.

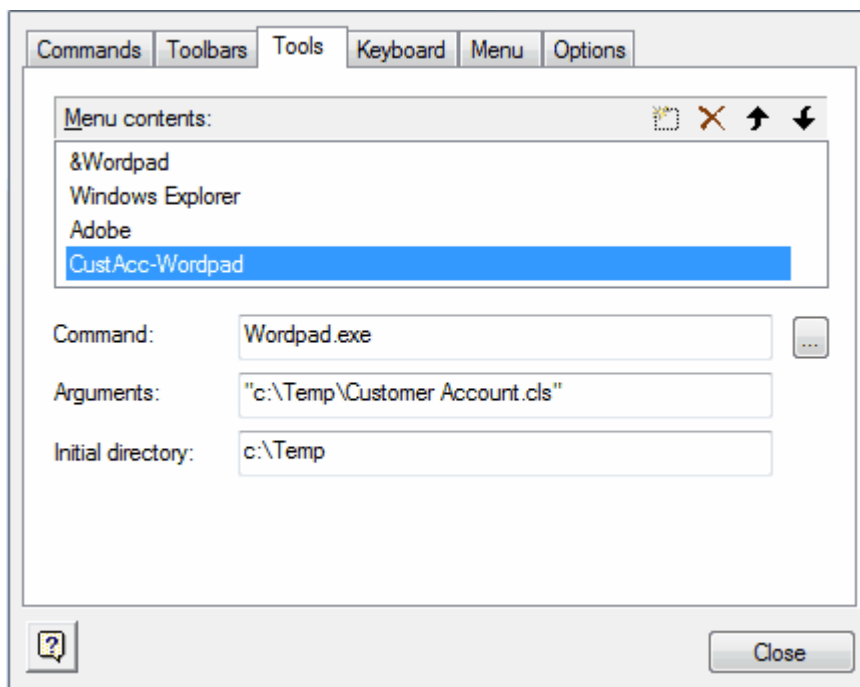

#### Tip:

If there are any spaces in the paths in the **Command**, **Arguments** or **Initial Directory** fields, you must enclose the whole path in double quotes. For example: `"c:\Temp\Customer Account.cls"` must have quotes but `c:\Temp\CustomerAccount.cls` does not have to have quotes.

#### Example 2

This example opens the file `c:\Temp\Customer Account.cls` using VB. As VB is not installed with the operating system, the whole file path for VB must be included in the **Command** field; you can select this using the [ ... ] (Browse) button to locate the VB executable. If you save from within VB the initial directory is `c:\Temp`.

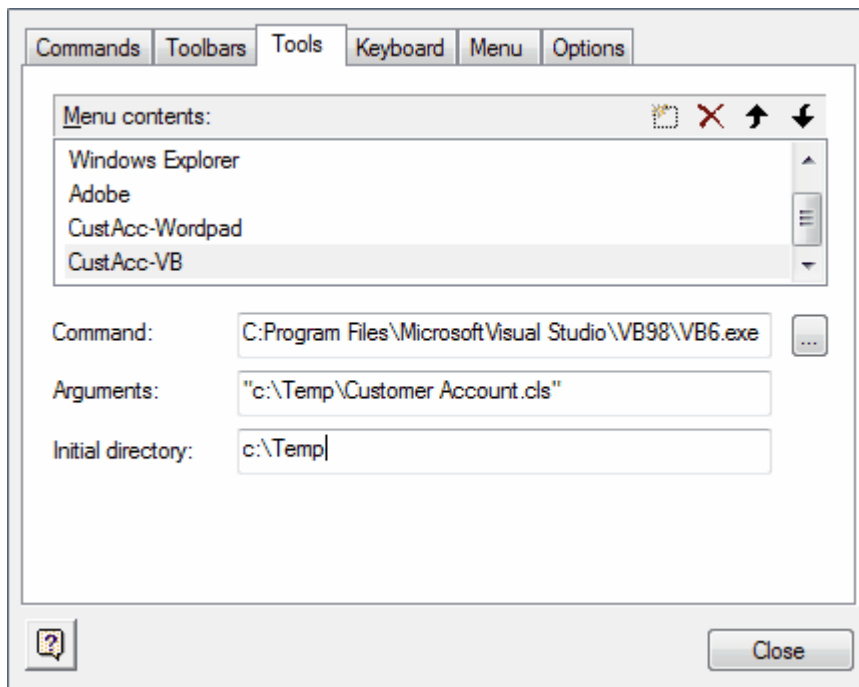

#### 2.4.7.1.3.2 Pass Parameters to Applications

When configuring custom tools in Enterprise Architect, you can pass parameters to the application.

Select the **Tools | Customize** menu option. The **Customize** dialog displays; click on the **Tools** tab. Now you can:

- Specify a [custom tool](#)<sup>94</sup> (application) using the **Command** field
- Define a [file to open](#)<sup>96</sup> or parameters to pass to this application using the **Arguments** field.

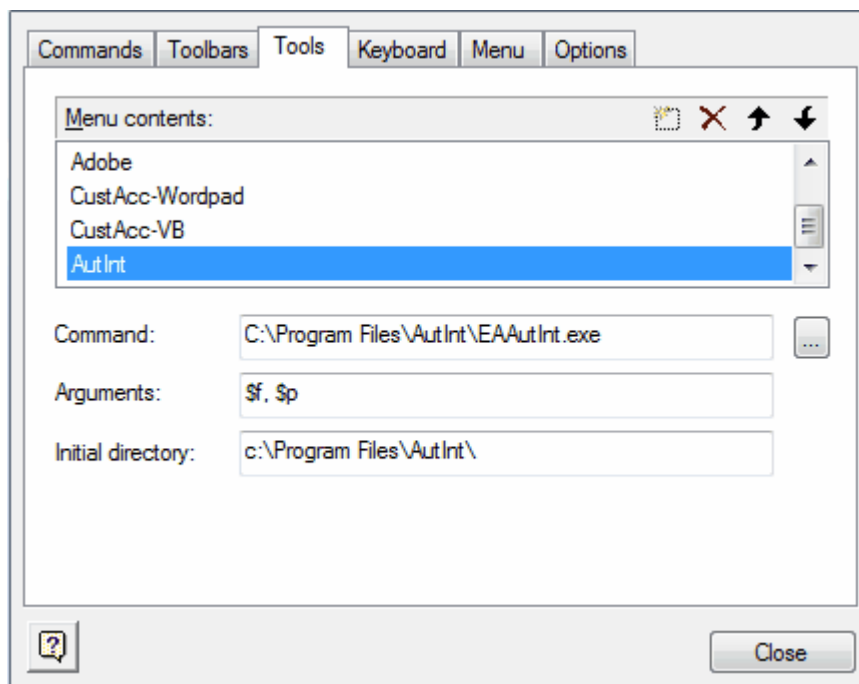

The available parameters for passing information to external applications are:

Parameter	Description	Notes
\$f	Project Name	For example, C:\projects\EAexample.eap.
\$F	Calling Application (Enterprise Architect)	Enterprise Architect.
\$p	Current Package ID	For example, <b>144</b> .
\$P	Package GUID	GUID for accessing this package.
\$d	Diagram ID	ID for accessing associated diagram.
\$D	Diagram GUID	GUID for accessing associated diagram.
\$e	Comma separated list of element IDs	All elements selected in the current diagram.
\$E	Comma separated list of element GUIDs	All elements selected in the current diagram.

**Tip:**

For more information on using the Automation Interface, visit [www.sparxsystems.com/AutIntVB.htm](http://www.sparxsystems.com/AutIntVB.htm).

#### 2.4.7.1.4 Customize Keyboard

The **Keyboard** tab on the **Customize** dialog enables you to configure shortcuts used to access main menu options. This is convenient for creating additional shortcut keys or for changing the current configuration to match your work habits or other applications.

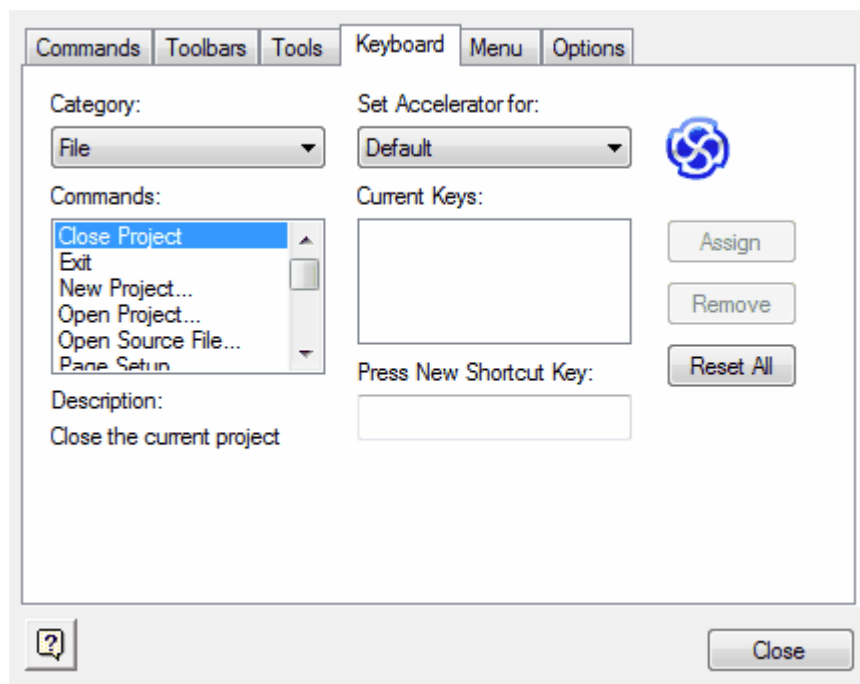

### Modify Keyboard Shortcuts

To modify a keyboard shortcut, follow the steps below:

1. Select the **Tools | Customize** menu option. The **Customize** dialog displays.
2. Click on the **Keyboard** tab, and in the **Category** field click on the drop-down arrow and select the menu containing the command to modify.
3. In the **Command** field, click on the drop-down arrow and select the command. The current shortcut key (if any) for the command is displayed in the **Current Keys** field.
4. Move the cursor to the **Press New Shortcut Key** field and press the required shortcut key(s) for this

command.

**Note:**

Press the actual keys to use. For example, to use **[F5]** press the **[F5]** key, don't type **F** then **5**.

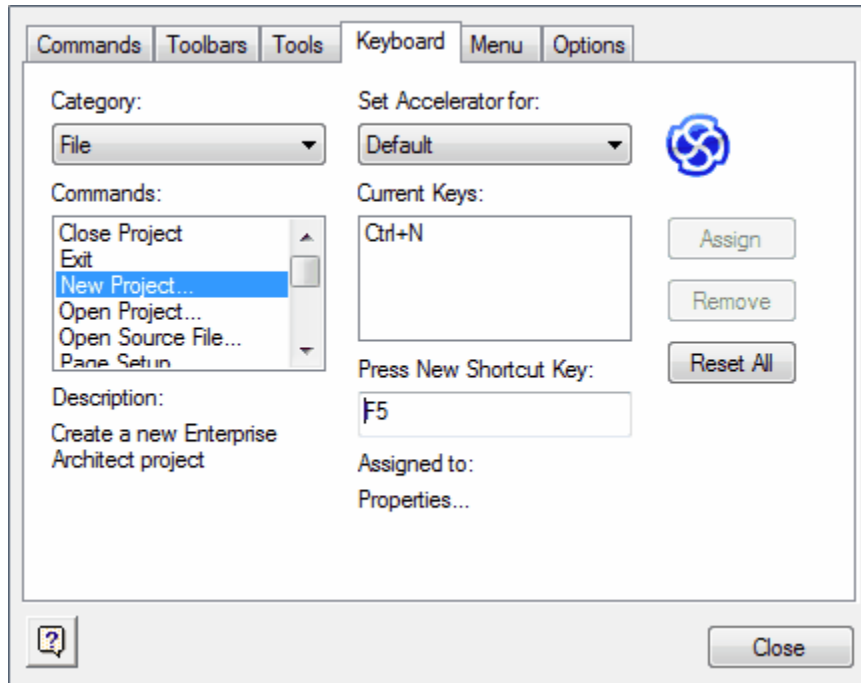
**Note:**

In the example above, the **Assign** button is disabled. This is because **[F5]** is already a shortcut to view diagram properties. If this occurs you must select a different shortcut key.

5. Once you have selected an available shortcut, click on the **Assign** button to apply the change. In the example below, the new shortcut is **[N]**.

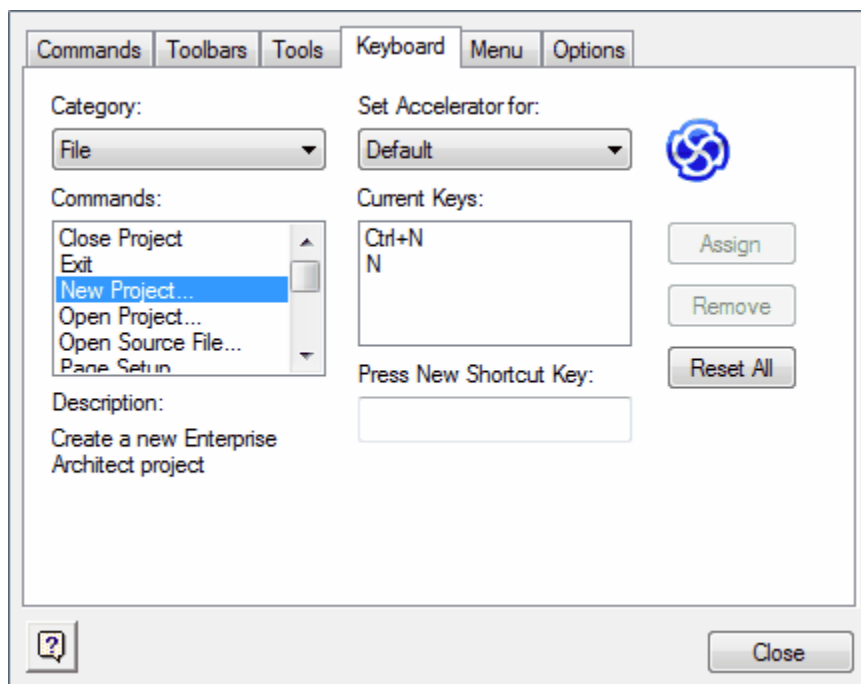

6. This has added a new shortcut so that both **[N]** and **[Ctrl]+[N]** create a new Enterprise Architect project.

If you intend **[N]** to be the only shortcut for this action, select **[Ctrl]+[N]** in the **Current Keys** list and click on the **Remove** button.

**Tip:**

Remember that you can always revert to the default shortcut keys by clicking on the **Reset All** button.

**Note:**

Modified shortcut keys are stored in the registry, so they only affect the current user.

### 2.4.7.1.5 Customize Menu

The **Menu** tab on the **Customize** dialog enables you to customize the appearance of your menus.

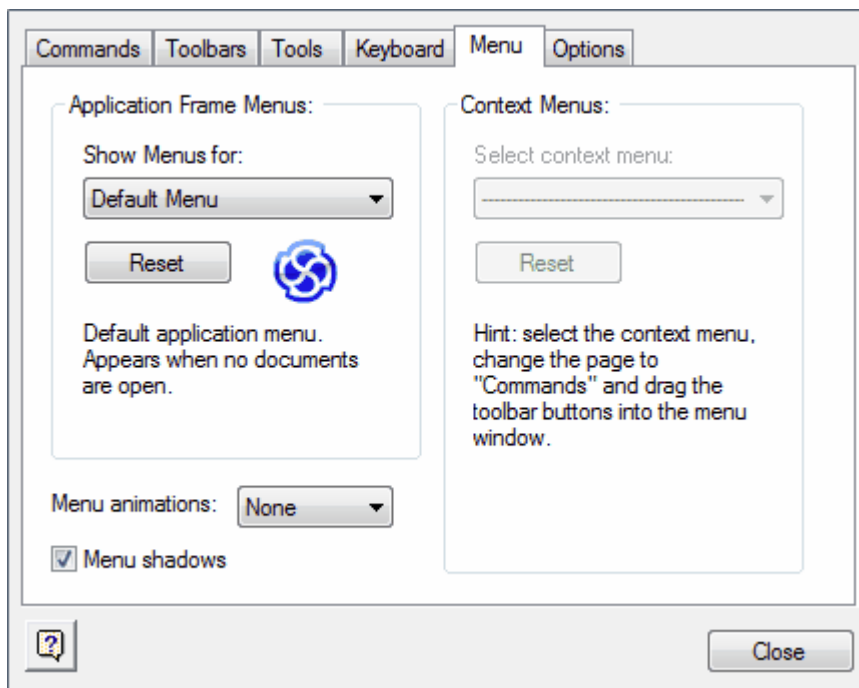

#### Application Frame Menus

Currently the **Show Menus For** feature is disabled as Enterprise Architect is not an MDI application.

#### Context Menus

Currently this feature is disabled.

#### Menu Animations

The following menu animations can be selected from the **Menu animations** drop-down list:

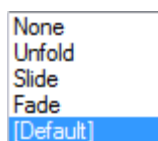

#### Menu Shadows

Menu shadows can be toggled on or off by selecting or clearing the **Menu shadows** checkbox.



## Remove Menu Options

Some menu options might not be of relevance to you. If you prefer not to display such options, follow the steps below:

1. Whilst the **Menu** tab of the **Customize** dialog is displayed, click on the appropriate chain of options in the main menu bar to display the option to delete.
2. Right-click on the option and select the **Delete** option from the context menu.

### Note:

When you perform a major upgrade of Enterprise Architect (such as from release 7.1 to 8.0) the menus are reset and deleted options are replaced.

### 2.4.7.1.6 Customize Options

The **Options** tab on the **Customize** dialog enables you to customize the appearance of toolbar items.

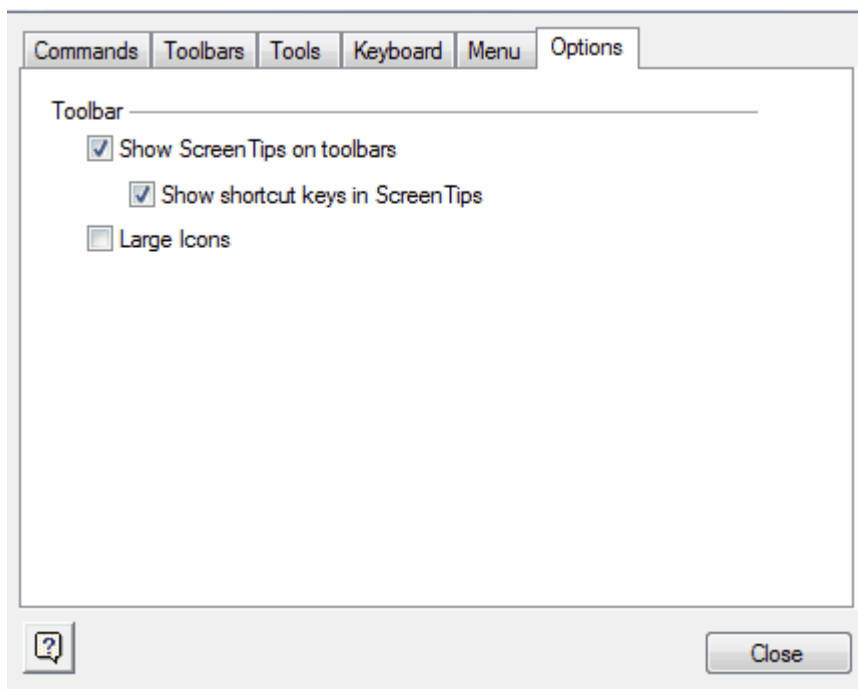

You can toggle the following options by selecting or clearing the checkboxes:

- **Show Screen Tips on toolbars**
- **Show shortcut keys in Screen Tips**
- Use **Large Icons**.

### 2.4.7.2 Visual Styles

You can configure the overall look and feel of Enterprise Architect to suit your working environment. Options include various Microsoft Office and Visual Studio styles, or themes.

To reset the appearance of Enterprise Architect, follow the steps below:

1. Select the **View | Visual Style | Select Visual Style** menu option. The **Application Look** dialog displays.

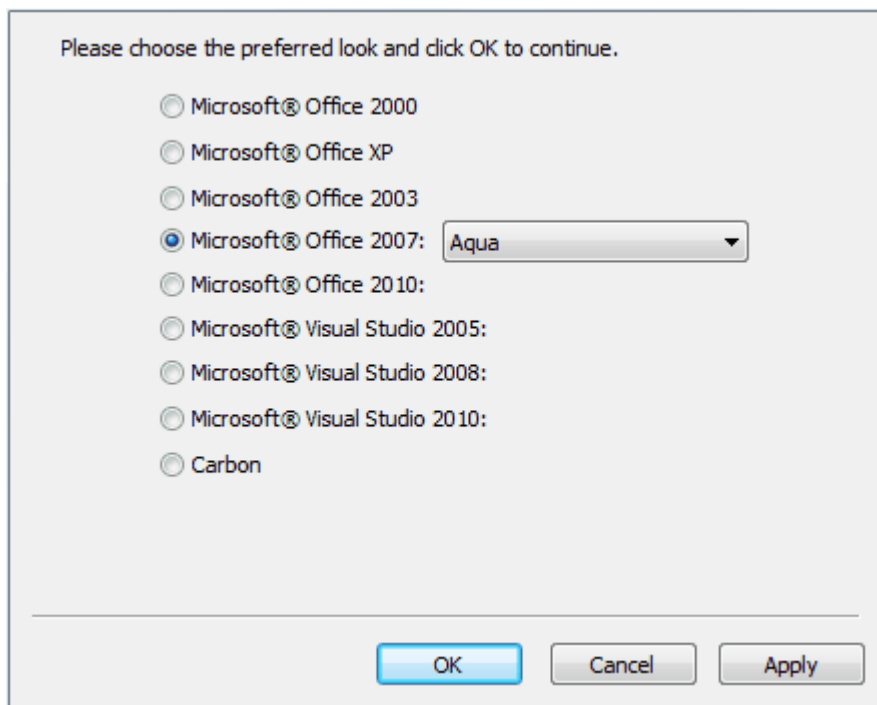

2. Select the required style from the list. If you select the **Microsoft Office 2007** radio button, you can also select from a number of base-color options.
  3. To try out styles, click on the **Apply** button. To set the style and resume work, click on the **OK** button.
- You can also [enable customization](#)<sup>[100]</sup> of toolbars and menus, and animate [auto-hidden](#)<sup>[78]</sup> windows.

## 2.4.8 Other Windows

Most of the windows in Enterprise Architect have a specific, task oriented purpose. Two windows have broader functions:

- The [Output](#)<sup>[102]</sup> window displays data that Enterprise Architect generates during each of a range of processes
- The [Web Browser](#)<sup>[103]</sup> enables you to search for and use internet facilities within your Enterprise Architect work area.

### 2.4.8.1 The Output Window

Access: **View | System Output**.

The **Output** window is used to display data that is either system generated or Add-In generated.

Examples of situations where Enterprise Architect generates items include:

- Validation Items
- Launch of external processes
- Command line output from Build and Test
- Parse errors generated during import
- (Corporate, Business and Software Engineering, Systems Engineering and Ultimate editions of Enterprise Architect) In the [Audit History](#)<sup>[278]</sup> tab, a history of changes to any element or connector selected from the [Audit View](#), the [Element List](#), the [Project Browser](#) or the current diagram ([Auditing](#)<sup>[270]</sup> must be turned on)
- Re-docking the [Model Search](#)<sup>[123]</sup> results into the **Output** window.

You can drag suitable items out of the **Output** window and add them to diagrams.

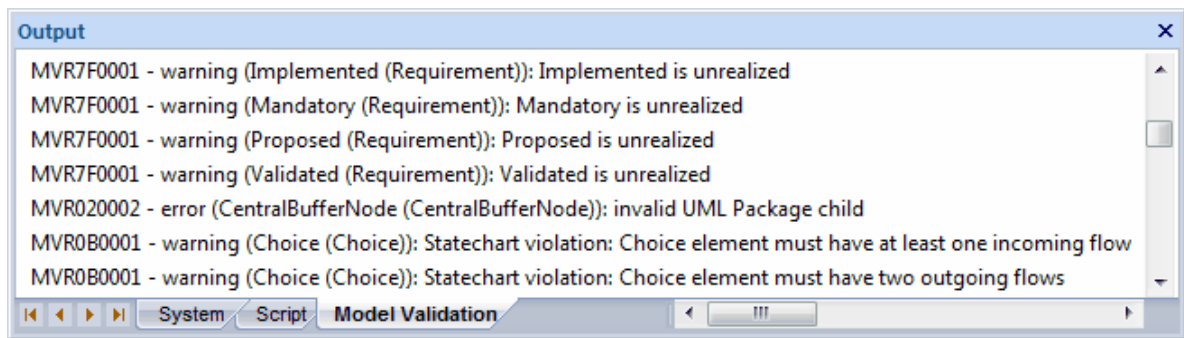

Double-click on model validation errors or parsing errors to display the source of the error.

You can also right-click on an item and select context menu options to:

- Copy the selected item to the clipboard
- Copy all items to the clipboard
- Save the output to an external file
- Clear the output from the window.

The [Output](#) window can also be used by [Add-Ins](#), if they are configured to do so via the [Automation Interface](#).

### 2.4.8.2 The Web Browser

The [Web Browser](#) displays as a tab of the central work area, like the [Start Page](#), [Model Search](#), [Element List](#) and [Diagram View](#). It provides access within Enterprise Architect to internet facilities such as email, websites and search engines.

To access the [Web Browser](#):

- Press **[Ctrl]+[Alt]+[W]**, or
- Select the **View | Other Project Tools | Internal Web Browser** menu option.

The [Web Browser](#) opens at the default home web site; you define the default home website, search engine and email exchange address on the [General](#) page of the [Options](#) dialog.



To access the:

- Email exchange server, click on the 'envelope' icon in the toolbar; the email login window displays
- Web search engine (such as *Google*), click on the 'spyglass' icon in the toolbar; the search engine screen displays
- Home web site, after displaying other web pages, click on the 'house' icon in the toolbar.

To go directly to another website or email server (your internet security permitting), in the **Address** field type or select the website http address and click on the **Go** button.

## 2.4.9 Keyboard Shortcuts

The table below lists the default keyboard shortcut functions within Enterprise Architect. You can also display the key combinations on the **Help Keyboard** dialog (or [Keyboard Accelerator Map](#)<sup>[108]</sup>).

There are some additional shortcuts using the keyboard and mouse in combination; see the [Keyboard-Mouse Shortcuts](#)<sup>[109]</sup> topic.

If necessary, you can change these keyboard shortcuts using the **Keyboard** tab of the **Customize**<sup>[98]</sup> dialog.

Function	Shortcut	Category
Create a new Enterprise Architect project	[Ctrl]+[N]	File
Open an Enterprise Architect project	[Ctrl]+[O]	File
Open Source File	[Ctrl]+[Alt]+[O]	File
<a href="#">Reload the current project</a> <sup>[267]</sup>	[Ctrl]+[Shift]+[F11]	File
Print the active diagram	[Ctrl]+[P]	File

Function	Shortcut	Category
Undo Change	[Ctrl]+[Z]	Edit
Redo Change	[Ctrl]+[Y]	Edit
Add a single element to the clipboard list	[Ctrl]+[Space]	Edit
Paste element as metafile from clipboard	[Ctrl]+[Shift]+[Insert]	Edit
Paste element as new	[Ctrl]+[Shift]+[V]	Edit
Paste element(s) from the clipboard	[Shift]+[Insert]	Edit
Bookmark current element with red marker	[Shift]+[Space]	Edit
Delete selected element(s) in <i>diagram</i>	[Delete] or [Ctrl]+[D]	Edit
Delete selected element(s) from <i>model</i> (through diagram OR <b>Project Browser</b> )	[Ctrl]+[Delete]	Edit
Search for items in the project	[Ctrl]+[F]	Edit
Set focus to current window	[Ctrl]+[Shift]+[0]	Window
Autohide the current window	[Ctrl]+[Shift]+[F4]	Window
Hide the current window	[Ctrl]+[F4]	Window
View <b>Project Browser</b>	[Alt]+[0]	View
View <b>Properties</b> window	[Alt]+[1]	View
View <b>System</b> window	[Alt]+[2]	View
View <b>Testing</b> window	[Alt]+[3]	View
View <b>Maintenance</b> window	[Alt]+[4]	View
Display <b>Toolbox</b>	[Alt]+[5]	View
View <b>Resources</b> window	[Alt]+[6]	View
View <b>Source Code</b> window	[Alt]+[7]	View
View <b>Debug Workbench</b>	[Alt]+[8]	View
View <b>Notes</b> window	[Ctrl]+[Shift]+[1]	View
View Element <b>Relationships</b> window	[Ctrl]+[Shift]+[2]	View
View <b>Rules and Scenarios (Requirements and Constraints)</b> window	[Ctrl]+[Shift]+[3]	View
View <b>Traceability</b> window	[Ctrl]+[Shift]+[4]	View
View <b>Tagged Values</b> window	[Ctrl]+[Shift]+[6]	View
View <b>Project Management</b> window	[Ctrl]+[Shift]+[7]	View
View <b>Output</b> window	[Ctrl]+[Shift]+[8]	View
View <b>Tasks Pane</b>	[Ctrl]+[Shift]+[9]	View
View <b>Pan &amp; Zoom</b> Window	[Ctrl]+[Shift]+[N]	View

Function	Shortcut	Category
View <b>Model Search</b>	[Ctrl]+[Alt]+[A]	View
View <b>Element List</b>	[Ctrl]+[Alt]+[R]	View
Open <b>Team Review</b>	[Ctrl]+[Alt]+[U]	View
Display Web Browser	[Ctrl]+[Alt]+[W]	View
View <b>Element Browser</b>	[Alt]+[9]	View
Add new package to project	[Ctrl]+[W]	Project
Add new diagram to package	[Ctrl]+[Insert]	Project
Add new element to package	[Ctrl]+[M]	Project
Create RTF documentation	[F8]	Project
Generate HTML Report	[Shift]+[F8]	Project
Generate Diagrams-only Report	[Ctrl]+[Shift]+[F8]	Project
Generate package source code	[Ctrl]+[Alt]+[K]	Project
Synchronize package contents	[Ctrl]+[Alt]+[M]	Project
Import source directory	[Ctrl]+[Shift]+[U]	Project
Package Build Scripts	[Shift]+[F12]	Project
Build	[Ctrl]+[Shift]+[F12]	Project
Test	[Ctrl]+[Alt]+[T]	Project
Run	[Ctrl]+[Alt]+[N]	Project
Deploy	[Ctrl]+[Shift]+[Alt]+[F12]	Project
Debug Run	[F6]	Project
Step Into	[Shift]+[F6]	Project
Step Over	[Alt]+[F6]	Project
Step Out	[Ctrl]+[F6]	Project
Debug Stop	[Ctrl]+[Alt]+[F6]	Project
Transform selected elements	[Ctrl]+[H] or [Ctrl]+[Alt]+[F]	Project
Transform current package	[Ctrl]+[Shift]+[H]	Project
Validate Selected	[Ctrl]+[Alt]+[V]	Project
Manage locks applied by current user	[Ctrl]+[Shift]+[L]	Project
Configure package control	[Ctrl]+[Alt]+[P]	Project
Import package from XMI	[Ctrl]+[Alt]+[I]	Project
Export package to XMI	[Ctrl]+[Alt]+[E]	Project
Import and export to CSV files	[Ctrl]+[Alt]+[C]	Project

Function	Shortcut	Category
Manage Baselines	[Ctrl]+[Alt]+[B]	Project
Diagram properties	[F5]	Diagram
Save	[Ctrl]+[S]	Diagram
Save image to file	[Ctrl]+[T]	Diagram
Save image to clipboard	[Ctrl]+[B]	Diagram
Visible Relations	[Ctrl]+[Shift]+[I]	Diagram
Locate in <b>Project Browser</b>	[Shift]+[Alt]+[G]	Diagram
Repeat last element	[Shift]+[F3]	Diagram
Repeat last connector	[F3]	Diagram
Element Properties	[Alt]+[Enter]	Element
Add Tagged Value	[Ctrl]+[Shift]+[T]	Element
Linked Document	[Ctrl]+[Alt]+[D]	Element
Display <b>Attribute Properties</b> dialog	[F9]	Element
Display <b>Operation Properties</b> dialog	[F10]	Element
Space elements evenly horizontally	[Alt]+[-]	Element
Space elements evenly vertically	[Alt]+[=]	Element
Add attribute	[Ctrl]+[Shift]+[F9]	Element
Add operation	[Ctrl]+[Shift]+[F10]	Element
Add other type	[Ctrl]+[F11]	Element
Auto-size selected elements	[Alt]+[Z]	Element
Generate code from element	[Ctrl]+[G] or [F11]	Element
Move element by increments	[Shift]+[↑], [↓], [→] or [←]	Element
Resize selected element	[Ctrl]+[↑], [↓], [←] or [→]	Element
Align bottom edges of selected elements	[Ctrl]+[Alt]+[Down]	Element
Align top edges of selected elements	[Ctrl]+[Alt]+[Up]	Element
Align selected elements on left boundaries	[Ctrl]+[Alt]+[Left]	Element
Align selected elements on right boundaries	[Ctrl]+[Alt]+[Right]	Element
Configure element default appearance	[Ctrl]+[Shift]+[E] or [F4]	Element
Edit selected	[F2]	Element
Manage embedded elements	[Ctrl]+[Shift]+[B]	Element
Insert new feature after current selection	[Insert]	Element
Locate in browser	[Alt]+[G]	Element

Function	Shortcut	Category
New element	[Ctrl]+[M]	Element
<a href="#">View source code</a> <small>1443</small> in default editor	[Ctrl]+[E] or [F12]	Element
Operation	[F10]	Element
Override inherited features	[Ctrl]+[Shift]+[O]	Element
Configure element properties	[Alt]+[ Enter]	Element
Select alternative image	[Ctrl]+[Shift]+[W]	Element
Specify which element features are visible on a diagram	[Ctrl]+[Shift]+[Y]	Element
Set element parent or implement interface(s)	[Ctrl]+[I]	Element
Set references to other elements and diagrams	[Ctrl]+[J]	Element
Create Workbench Instance	[Ctrl]+[Shift]+[J]	Element
Locate diagrams where element is used	[Ctrl]+[U]	Element
View <b>Properties</b> dialog	[Enter]	Element
Check project data integrity	[Shift]+[F9]	Tools
Configure system options	[Ctrl]+[F9]	Tools
Spell check current package	[Ctrl]+[Shift]+[F7]	Tools
Spell check model	[Ctrl]+[F7]	Tools
Edit code generation templates	[Ctrl]+[Shift]+[P]	Settings
Edit transformation templates	[Ctrl]+[Alt]+[H]	Settings
Make text bullet list item	[Ctrl]+[.] (full stop)	Element notes
Make text numbered list item	[Ctrl]+[1]	Element notes
Make text bold	[Ctrl]+[B]	Element notes
Make text italic	[Ctrl]+[I]	Element notes
Make text underlined	[Ctrl]+[U]	Element notes
Copy text	[Ctrl]+[C]	Everywhere
Paste text	[Ctrl]+[V]	Everywhere
Cut text, or element in diagram	[Ctrl]+[X]	Everywhere

### Display Keyboard Accelerator Map

To display the key combinations for the menu functions within Enterprise Architect, select the **Help | Keyboard Accelerator Map** menu option. The **Help Keyboard** dialog displays.



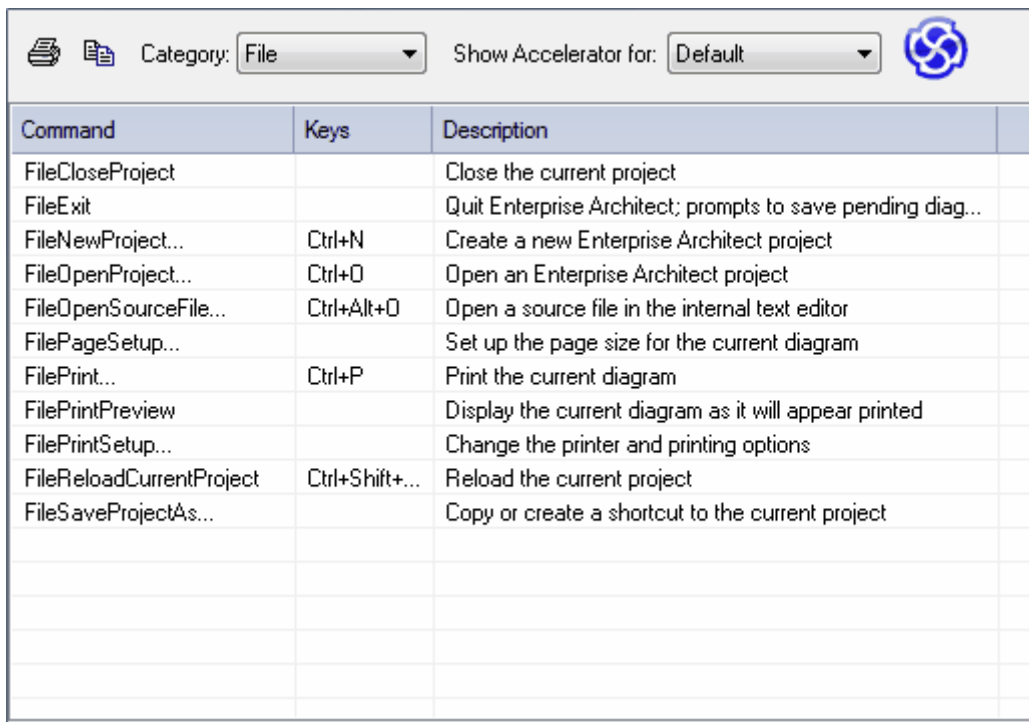

Command	Keys	Description
FileCloseProject		Close the current project
FileExit		Quit Enterprise Architect; prompts to save pending diag...
FileNewProject...	Ctrl+N	Create a new Enterprise Architect project
FileOpenProject...	Ctrl+O	Open an Enterprise Architect project
FileOpenSourceFile...	Ctrl+Alt+O	Open a source file in the internal text editor
FilePageSetup...		Set up the page size for the current diagram
FilePrint...	Ctrl+P	Print the current diagram
FilePrintPreview		Display the current diagram as it will appear printed
FilePrintSetup...		Change the printer and printing options
FileReloadCurrentProject	Ctrl+Shift+...	Reload the current project
FileSaveProjectAs...		Copy or create a shortcut to the current project

To list the shortcuts in a particular category (see the *Command* column in the above table), click on the drop-down arrow in the **Category** field and select the appropriate category.

### 2.4.9.1 Keyboard-Mouse Shortcuts

The following table lists certain operations you can perform quickly using a combination of keyboard keys and the computer mouse.

Function	Shortcut
Create element of same type as last created on diagram	[Ctrl]+click
Display element <b>Properties</b> dialog for element in scenario <b>Context References</b> tab	[Ctrl]+click
Select a number of individual objects for an operation	[Ctrl]+click each object
Select a range of objects for an operation	[Shift]+click the first and last object in the range
Move elements along horizontal axis or vertical axis	[Shift]+hold left mouse button and drag
Create bend in and change direction of connector line	[Shift]+hold left mouse button and drag
Move elements in any direction, including diagonally	[Alt]+hold left mouse button and drag
Zoom in or zoom out of diagram	[Ctrl]+mouse scroll wheel
Pan diagram horizontally or vertically	[Ctrl]+[Shift]+hold left mouse button and drag

**Part**



## 3 Projects and Teams

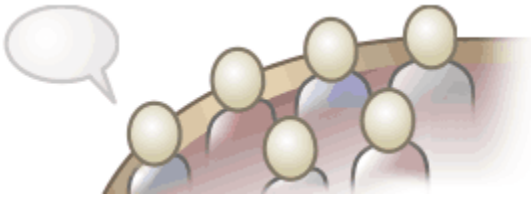

Enterprise Architect helps you to create projects for development under a [range of work conditions](#)<sup>[112]</sup>, from single user/local access through to multiple-role teams working in a distributed environment.

You both protect and manage the model data itself, and communicate information on the data in the form of documentation and reports, using facilities such as:

- Creating the project in a [local, file-based repository](#)<sup>[120]</sup> (a Microsoft JET database)
- Creating the project in one of a range of [DBMS repositories](#)<sup>[122]</sup> (Corporate and extended editions)
- Tools for enabling [team development](#)<sup>[182]</sup> in the project
- [Tools for managing changes](#)<sup>[228]</sup>
- [Tools for managing project activities](#)<sup>[312]</sup>
- [Maintaining the integrity of the project](#)<sup>[344]</sup>
- [Sharing](#)<sup>[223]</sup> the [reference data](#)<sup>[644]</sup> used across the project, and between models and projects
- Enabling each user to [configure](#)<sup>[350]</sup> how project tools display and behave on their workstation.

You can also have recorded discussion and communication of decisions using the [Team Review](#)<sup>[208]</sup>.

### Generating Model Documentation

You can generate documentation from the components of your model, in RTF or HTML format. You can also generate a range of RTF reports on your model.

For more information, see the [Report Generation](#)<sup>[1568]</sup> topic.

## 3.1 Introduction



An Enterprise Architect [project](#)<sup>[113]</sup> is stored in a data repository. In Enterprise Architect Desktop and Professional editions, you work with a single file having a .EAP extension.

In Enterprise Architect Corporate, Business and Software Engineering, Systems Engineering and Ultimate editions you can also use a suitable DBMS database for project files.

### Project Files

#### .EAP Files

In Enterprise Architect Desktop and Professional editions, a single file with a .EAP extension is used to store projects. A .EAP file is a Microsoft JET database, so you can also open it using MS Access 97, 2000 or 2003, or any other reporting tool that can work with JET databases.

#### DBMS Repositories

In Enterprise Architect Corporate Business and Software Engineering, Systems Engineering and Ultimate editions, you can use a suitable DBMS database for project files. DBMS project files have the same logical structure as .EAP files, but must be connected to using ADO/ODBC. See **Connect to a Data Repository**, below.

Whenever you launch Enterprise Architect, the first thing displayed is the [Start Page](#)<sup>[50]</sup>. From here, you can create a new project, open a project and (Corporate, Business and Software Engineering, System Engineering and Ultimate editions) connect to a data repository.

### Create a New Project File

On creating a [new project](#)<sup>[120]</sup>, the [Model Wizard](#)<sup>[372]</sup> enables you to create a model containing various Model Packages.

You can also add Model Packages to a project from the **Project Browser** by:

- Right-clicking on an existing model and selecting the **New Model** or **Add a New Model using Wizard** context menu options
- Right-clicking on a package and selecting the **Add | Add a New Model using Wizard** context menu option
- Clicking on an existing model, pressing **[Insert]** and selecting the **New Model** or **Add a New Model using Wizard** context menu options
- Clicking on a package, pressing **[Insert]** and selecting the **Add a New Model using Wizard** context menu option.

### Open an Existing Project

There are various ways to [open a project](#)<sup>[114]</sup> in Enterprise Architect. New users are advised to explore the [EAExample file](#)<sup>[114]</sup> supplied with Enterprise Architect.

### Connect to a Data Repository

#### Note:

This feature is available in the Corporate, Business and Software Engineering, System Engineering and Ultimate editions.

Enterprise Architect enables you to [connect to](#)<sup>[147]</sup> any of the following data repositories:

- MS Access 97, 2000 and 2003 (in all editions - .EAP files are stored in Microsoft JET databases)
- Access 2007

- SQL Server 2000, 2005 and 2008
- MySQL
- Oracle 9i, 10g or 11g
- PostgreSQL
- MSDE
- Adaptive Server Anywhere
- Progress OpenEdge

To create a new data repository, you must first create a new database with the DBMS management software, then run supplied scripts to create the logical structure. You should then use Enterprise Architect data transfer functions to move a project from a .EAP or DBMS model into the new project.

### 3.1.1 What is a Project?

An Enterprise Architect project is a mechanism for storing and managing the components of one or more UML models.

A project can be a [.EAP file](#)<sup>[112]</sup> in an MS Access database or (in the Enterprise Architect Corporate, Business and Software Engineering, System Engineering and Ultimate editions) a structure of files in a [database management system](#)<sup>[112]</sup> such as MySQL or Oracle.

A project can contain a single model, or a number of models, each of which defines a particular system or process. A model contains the diagrams, elements, relationships and associated metadata that define the structure and function of the system or process. These components are organized into a hierarchy of packages, which help to group and manage related components.

Different aspects of the process or system - or their development - are defined by Model Packages, which you [generate](#)<sup>[372]</sup> from [templates](#)<sup>[373]</sup> specifically structured to support the aspects that the Model Packages represent, such as requirements or deployment. You can generate these templated packages at any level of the hierarchy, but as they are created with their own content they are more useful at the top levels.

The top-level packages in a model can also be [Views](#)<sup>[383]</sup>, which represent partitions of the model that you define yourself. You can start with standard Views such as Class or Component, or create whatever partitions are appropriate to your model.

So a typical project could have a structure something like the following:

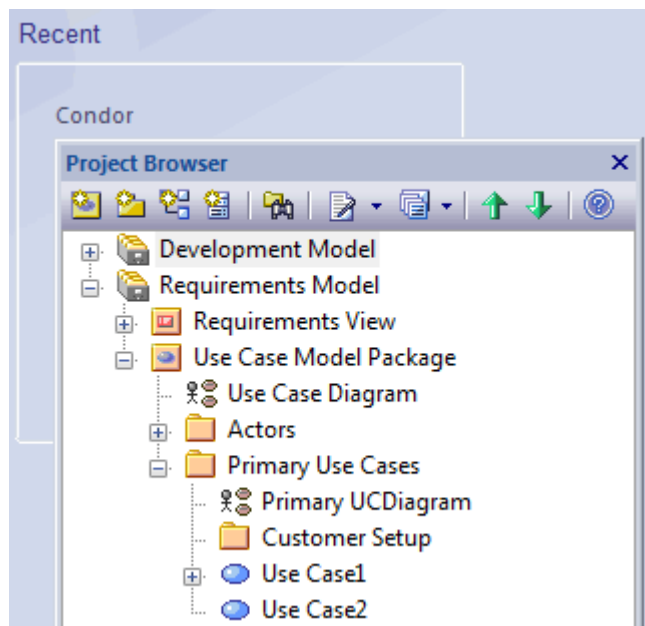

The project *Condor* contains two models:

- *Development Model* and
- *Requirements Model*.

Requirements Model contains:

- *Requirements View* and
- *Use Case Model Package*.

Each View or Model Package contains packages. Use Case Model Package contains:

- *Actors* and
- *Primary Use Cases*.

It also contains the diagram *Use Case Diagram*, which could be an overview of the package structure or function. Each package itself can contain one or more diagrams, one or more packages, and several elements. The Primary Use Cases package contains the:

- *Primary UCDiagram*
- *Customer Setup* package
- *Use Case 1* element
- *Use Case 2* element.

Each subordinate package also contains diagrams, elements and (if necessary) further packages. The elements are related by connectors created in the diagrams, and each element and connector has properties, attributes, operations and extensions defined in the respective **Properties** dialogs.

### 3.1.2 Open a Project

Enterprise Architect supports several different methods of opening an Enterprise Architect project file.

#### From the Main Menu

Select the **File | Open Project** menu option. From the **Open Project** dialog, select the path for the file to open and click on the **Open** button.

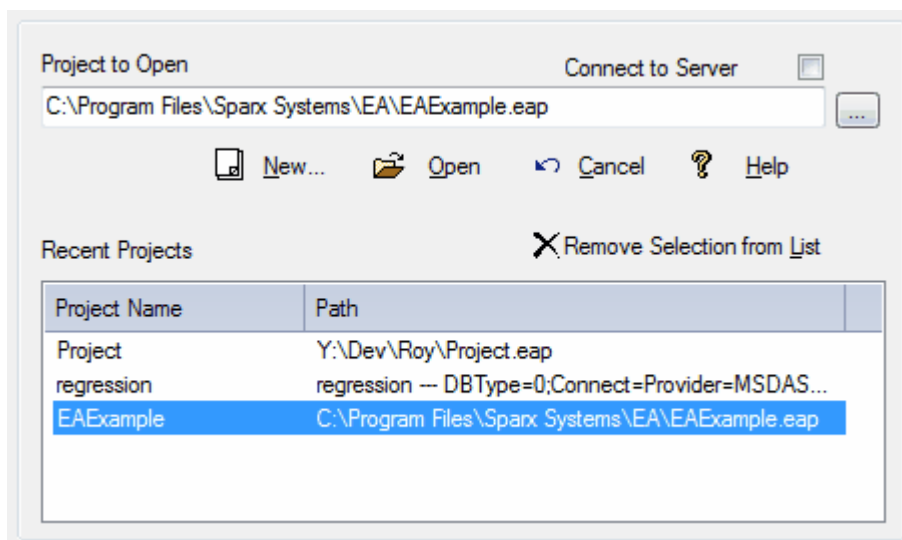

#### From the **Default Tools** **Toolbar**

Click on the folder icon to display the **Open Project** dialog, or the drop-down arrow to display a list of recently-opened projects.

#### From the **Start Page**

1. Click on **Open a Project File**. The **Open Project** dialog displays.
2. Use the file browser (**[ ... ]**) to navigate to the project to open, which has a .EAP file extension (\*.EAP). Select the project and click on the **Open** button.

#### Recently Opened Projects

Enterprise Architect keeps a list of recently opened projects and displays them on the **Start Page** for easy selection. If the project to open is in the **Recent** list, simply click once on the name of the project to open it.

**Note:**

If you already have a project open, Enterprise Architect prompts you to save changes before loading.

### Enterprise Architect Example Project File

New Enterprise Architect users in particular should start by exploring the *EAExample* file supplied with Enterprise Architect. The example model file is stored in your Enterprise Architect installation directory. The default installation directories, depending on which version you have installed, are:

- Registered version: C:\Program Files\Sparx Systems\EA
- Trial version: C:\Program Files\Sparx Systems\EA Trial
- Lite version: C:\Program Files\Sparx Systems\EA Lite

### Connect to a Data Repository <sup>[147]</sup>

**Note:**

This feature is available in the Corporate, Business and Software Engineering, Systems Engineering and Ultimate editions.

You also have the option to connect to [SQL Server](#) <sup>[126]</sup>, [MySQL](#) <sup>[123]</sup>, [Oracle 9i, 10g or 11g](#) <sup>[129]</sup>, [Postgre SQL](#) <sup>[160]</sup>, [ASA](#) <sup>[162]</sup>, [MSDE Server](#) <sup>[165]</sup> and [Progress OpenEdge](#) <sup>[165]</sup> data repositories.

### 3.1.3 Model Shortcuts

Enterprise Architect enables you to create a desktop shortcut (or *Proxy* file) to your model or (for a .EAP file) a direct copy of your model. You cannot create a copy of a DBMS model.

If you are using a database repository other than MS Access 97, 2000 or 2003, you can configure the shortcut to [encrypt the password](#) <sup>[119]</sup> used to set up the connection between Enterprise Architect and the repository. The Enterprise Architect user does not have the real password, thereby preventing them from accessing the repository using other tools such as Query Analyzer or SQLPlus.

Each shortcut is a file containing the connection string for the model. However, the shortcut also defines *views* that Enterprise Architect should open as it opens the model, such as:

- The [Model Search](#) <sup>[123]</sup> with a specific text string and search type

**Notes:**

- For searches operating on the current tree selection, a diagram in the target package must be opened first.
- If you use a custom SQL search, the [SQL must include](#) <sup>[123]</sup> `ea_guid AS CLASSGUID` and the *object type*.

- A specific diagram
- The [Relationship Matrix](#) <sup>[126]</sup> with a saved profile
- The default [Team Review](#) <sup>[208]</sup>.

You can define more than one diagram to open (but not more than one search, **Team Review** or **Relationship Matrix** profile). Enterprise Architect opens the appropriate windows in the sequence in which you list the options, displaying the last view in the list. For example, you might create your shortcut to open, in sequence:

- A Development module
- The **Model Search** for a *simple* search on the term *Issue*
- The module Issues diagram
- The module Changes diagram.

The project would then open with the Enterprise Architect work area showing the two diagram tabs and the **Model Search** tab, and with the Changes diagram displayed in the [Diagram View](#) <sup>[396]</sup>.

**Notes:**

- These options are not valid for a copy of the model.
- If specified, the shortcut views override any [default diagram](#) <sup>[65]</sup> defined for the model or current user.
- A shortcut does not affect the original Enterprise Architect .exe file or icon, or any other shortcut you might have defined. You can use all of these independently.
- When you use a shortcut to access a project that you have recently opened in Enterprise Architect, the **Recent** list on the Enterprise Architect **Start Page** has two entries for the project - one created when you opened the project in Enterprise Architect and one created when you used the desktop shortcut.

To create a copy of your model or a shortcut to your model, you have two options:

- [Define each view](#) <sup>[116]</sup> to open (for example, if you are specifying a working environment in advance, perhaps for other users)
- [Capture the current Enterprise Architect work environment](#) <sup>[117]</sup> to access the model at exactly the same point in exactly the same environment when you resume work.

### 3.1.3.1 Create Copy Or Shortcut

You can specifically define each view that your model shortcut should open; for example, if you are specifying a working environment in advance, perhaps for other users.

You can also [capture the current Enterprise Architect work environment](#) <sup>[117]</sup>, which is useful if you want to access the model at exactly the same point in exactly the same environment when you resume work.

To specifically set up your start-up shortcut or take a copy of the model, follow the steps below:

1. On the **Start Page**, open the required project.
2. Select the **File | Save Project As** menu option. The **Save As** dialog displays.

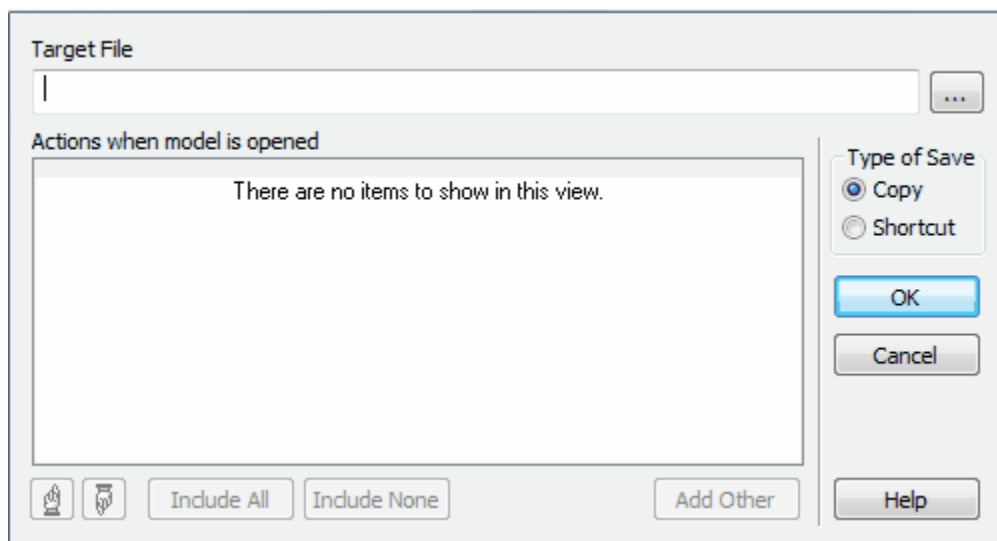

3. Click on the [ ... ] (Browse) button at the end of the **Target File** field. The **Save Project As** dialog displays.
4. Browse for the appropriate file location (such as C:\Documents and Settings\\Desktop) and, in the **File name** field, type an appropriate filename. All shortcuts are .EAP files, regardless of whether the model itself is a .EAP file or a DBMS model.
5. Click on the **Save** button to return to the **Save As** dialog.
6. Click on one of the following:
  - The **Copy** radio button to create a direct copy of the model, and click on the **OK** button to save the copy and end the procedure
  - The **Shortcut** radio button to create a desktop shortcut for the model



**Note:**

These radio buttons display only if the model is a .EAP file. If the model is a DBMS file, the target file can only be a shortcut. See the [Encrypt Repository Password](#)<sup>[119]</sup> topic.

7. Click on the **Add Other** button and select the required option to define:

- A diagram to open
- A **Relationship Matrix** profile to open
- The **Team Review**
- A **Model Search** to perform.

The appropriate browser or dialog displays to define the view to display. Enter the details and click on the **OK** button.

8. Repeat step 7 for as many views as you require. Each entry is automatically selected, with a tick in the checkbox.

To delete an entry, click on the checkbox to remove the tick. The entry is deleted when you save the shortcut.

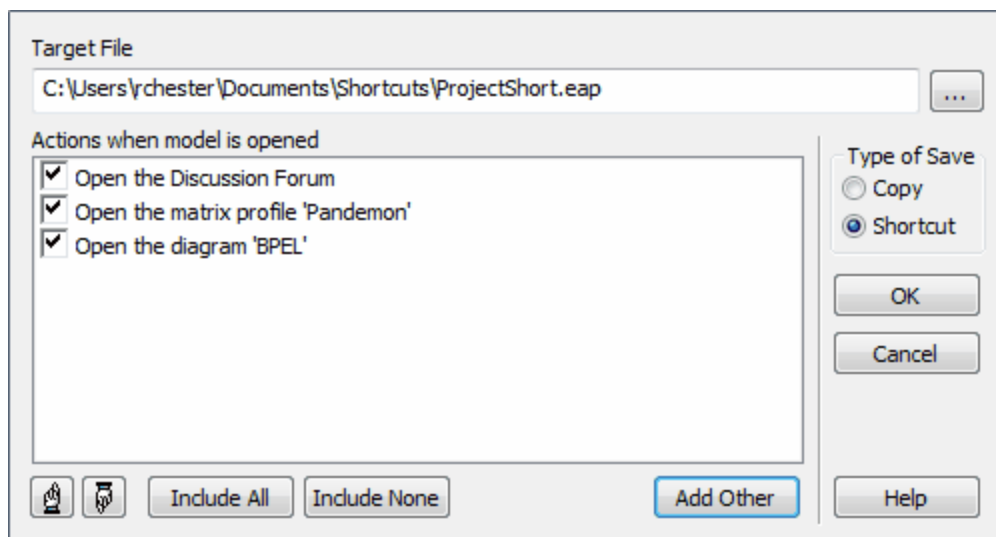

9. To change the sequence and/or make a different view display first in the **Diagram View**, click on the appropriate entry and click on the 'Up Hand' or 'Down Hand' buttons.

10. Click on the **OK** button to save the shortcut.

When you subsequently open the **Save As** dialog, it lists the currently-opened views in the order in which they were opened. You can add further views or remove them from the shortcut.

### 3.1.3.2 Capture Current Work Environment

You can capture the current Enterprise Architect work environment, so that you can access the model at exactly the same point in exactly the same environment when you resume work.

To do this, follow the steps below:

1. Open Enterprise Architect (perhaps by using an existing shortcut).
2. On the **Start Page**, open the required project.
3. Perform the work you need to do.
4. When you decide to capture your work environment in a shortcut, ensure that you have opened all diagrams you require and, if necessary, the **Team Review**, **Model Search** (with appropriate search term and type) and/or **Relationship Matrix** (at the appropriate profile). Ensure that the view you want to resume work on is the last one opened.
5. Select the **File | Save Project As** menu option. The **Save As** dialog displays, showing a list of actions derived from the views you currently have opened.

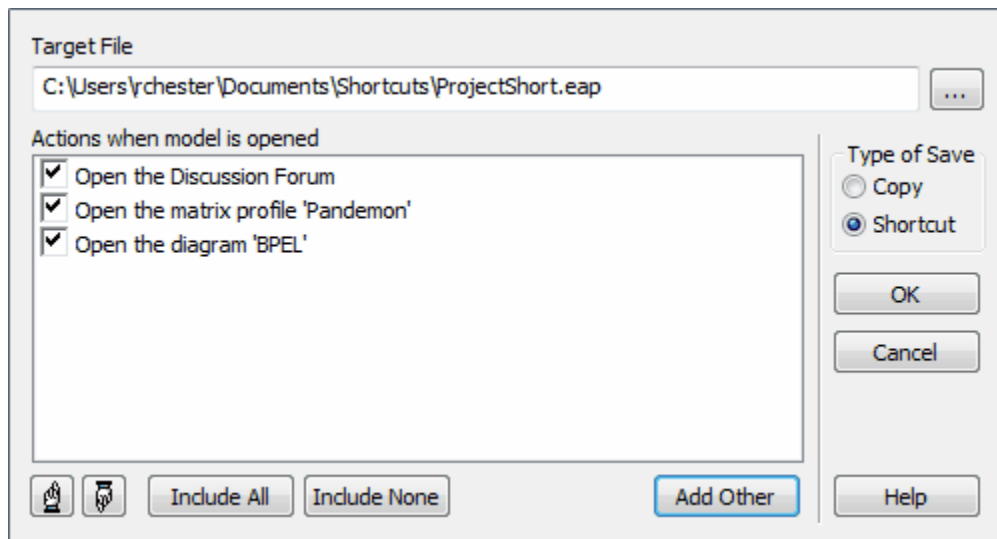

6. If you accessed Enterprise Architect via a shortcut, the **Target File** field displays the file location of that shortcut. If you intend to update the shortcut, go to step 10.
7. Otherwise, click on the [ ... ] (Browse) button at the end of the **Target File** field. The **Save Project As** dialog displays.
8. Browse for the appropriate file location (such as C:\Documents and Settings\\Desktop) and, in the **File name** field, type an appropriate filename. All shortcuts are .EAP files, regardless of whether the model itself is a .EAP file or a DBMS model.
9. Click on the **Save** button to return to the **Save As** dialog.
10. Click on one of the following:
  - The **Copy** radio button to create a direct copy of the model, and click on the **OK** button to save the copy and end the procedure.
  - The **Shortcut** radio button to create a desktop shortcut for the model.

**Note:**

These radio buttons display only if the model is a .EAP file. If the model is a DBMS file, the target file can only be a shortcut. See the [Encrypt Repository Password<sup>\[119\]</sup>](#) topic.

11. If you decide not to have a view in the shortcut, click on the checkbox to remove the tick. The entry is deleted when you save the shortcut.
12. If you decide to change the sequence and/or make a different view display first in the **Diagram View**, click on the appropriate entry and click on the 'Up Hand' or 'Down Hand' buttons.
11. Click on the **OK** button to save the shortcut.

**Note:**

If you open the **Save As** dialog when no views are open, the **Actions when model is opened** field is empty. You can save the shortcut like this to totally clear it. Alternatively, if views are listed that you do not want to use again, click on the **Include None** button and save the shortcut.

### 3.1.3.3 Encrypt Repository Password

If your model is developed on a DBMS repository, the **Save As** dialog has an **Encrypt Connection String** check box instead of the radio buttons, as shown below:

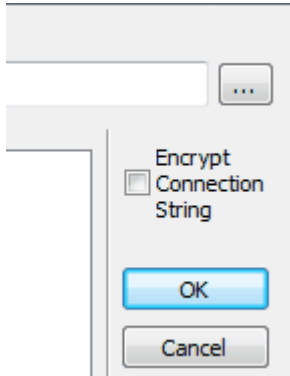

You can create the shortcut actions as described in the [Create Copy or Shortcut](#) topic and, if necessary, select the checkbox to encrypt the database connection string. You distribute the shortcut file to the database users who are to access the model. The users then have an encrypted string such as:

```
EAConnectString: ora10_db --- DBType=3;ConnectEx=+wkIE;B?e  
52+H"e?r-pb_ZyAl3a]Vsfh8p];Co\d/bnX$5<('US'^GxvbbRsK{*%AwL4y1{P<je.%R1  
?AY;y!7pw$X%)_EwLXWpKg7tzLF=T
```

## 3.2 File Based Repositories

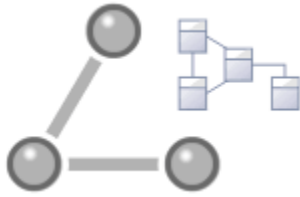

Enterprise Architect projects can be created as .eap files via the **File | New Project** menu option, which displays the **Save New Enterprise Architect Project** dialog.

Select a directory and enter a file name for your project, then click on the **Save** button. Once the project has been saved, the **Select Model(s)** dialog displays, which makes a selection of Model Packages available. Select the Model Packages to include and click on the **OK** button. Enterprise Architect adds a model containing the selected Model Packages to the **Project Browser**.

You can also add Model Packages to the project using the **New Model From Pattern** icon in the **Project Browser toolbar**. Alternatively, new projects can be created from the **Start Page**; select the **Create a New Project** option.

### The Model Wizard

The Model Wizard is used to add a selection of Model Packages to the project, through the **Select Model(s)** dialog.

### The EABase Project File

The default project file (*EABase.EAP*) is supplied when you install Enterprise Architect and is stored in your Enterprise Architect installation directory (or anywhere else you might redirect it to). The default installation directories, depending on which version you have installed, are:

- Registered version: C:\Program Files\Sparx Systems\EA
- Trial version: C:\Program Files\Sparx Systems\EA Trial
- Lite version: C:\Program Files\Sparx Systems\EA Lite

Having copied the base project as a template for your own project, you can **rename** it - or any other project you own.

### Design a Custom Template

You can customize any Enterprise Architect project and use it as the base for the new project. This enables you or your organization to build a default project with company standards, tutorials, frameworks or any other common piece of modeling already in-built. A default project is no different from an ordinary project; Enterprise Architect simply copies and renames it as a starter for your new project. With careful planning you can save yourself many hours of work at project start-up.

### Configure Project

Having created your project, you can set a range of project parameters to define defaults, tailor the project to particular coding languages, and ensure consistent development and use of the project. See the following topics:

- [The Settings Menu](#)
- [Defaults and User Settings](#)

### 3.2.1 Copy a Base Project

To copy an existing project as a base for a new project, from the [Start Page](#)<sup>50</sup> select the **Copy a Base Project** option. The **Create New Enterprise Architect Project** dialog displays.

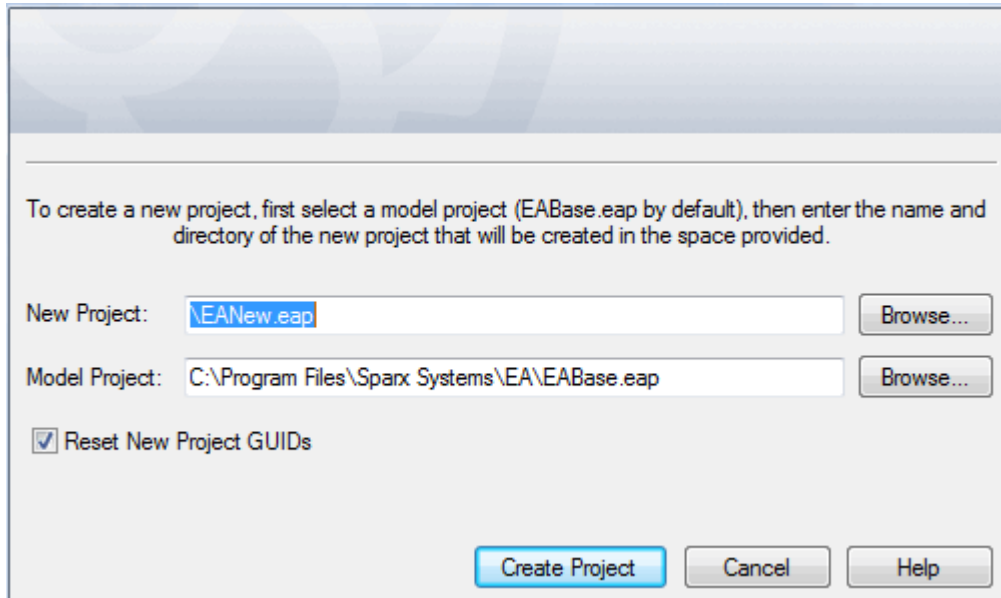

You must first select the project that is to be the base template. When you install Enterprise Architect a default base project is installed called *EABase.eap*.

- The **Model Project** field defaults to *EABase.eap*, as the base file for your project; however you can select any existing project file as [a Custom Template](#)<sup>120</sup> - click on the **Browse** button after the **Model Project** field and locate the custom project file
- To select the file path for saving your project, click on the **Browse** button after the **New Project** field; if this is to be a shared project, store the file on a shared network resource such as a Network Server or Workgroup Server
- To replace all GUIDs in the source model with fresh GUIDs, select the **Reset New Projects GUIDs** checkbox.

**Note:**

If the new project is based on one that is already under version control, it is recommended that the **Reset New Projects GUIDs** checkbox be deselected. This prevents duplication of packages when the **Get Latest** facility is used.

When you have entered the filenames, click on the **Create Project** button to create your project. Click on the **Cancel** button to close the dialog without creating a new project.

**Tip:**

You can also copy any Enterprise Architect project using Windows Explorer, and open the copied project as a new project.

### 3.3 Server Based Repositories



#### Introduction

The Desktop and Professional versions of Enterprise Architect use an MS JET database as the model repository.

If you purchase the Corporate, Business and Software Engineering, Systems Engineering or Ultimate edition, you can also create and use any of the following data repositories:

- [SQL Server](#) <sup>[126]</sup> 2000, 2005 or 2008
- [MySQL](#) <sup>[123]</sup> 4 or 5
- [PostgreSQL](#) <sup>[129]</sup> 7 or 8
- [Adaptive Server Anywhere 8 or 9, or SQL Anywhere 10 or 11](#) <sup>[132]</sup>
- [Access 2007](#) <sup>[123]</sup>
- [Progress OpenEdge](#) <sup>[134]</sup>
- [MSDE](#) <sup>[134]</sup> or
- [Oracle 9i, 10g or 11g](#) <sup>[129]</sup>.

You *upsized* the Enterprise Architect models (either existing or template) to use your selected DBMS. The process of upsizing a model is straightforward and comprises the following steps:

1. Install the DBMS software and create a database. Ensure that the collation is set to the alphabet you use, such as Latin or Cyrillic.
2. Run a script supplied by Sparx Systems ([http://www.sparxsystems.com/resources/corporate/index.html#sql\\_scripts](http://www.sparxsystems.com/resources/corporate/index.html#sql_scripts)) to create the required tables.
3. Open Enterprise Architect and use the [Project Data Transfer](#) <sup>[306]</sup> function (select the **Tools | Data Management | Project Transfer** menu option) to move a model from a .EAP file to the DBMS repository.

#### Note:

You cannot move a model from a source .EAP file of a version earlier than 3.5.0.

Setting up a database repository is a two- or three-stage process: firstly, you set up an ODBC driver for your database; secondly, you create the repository tables using scripts downloaded from the Sparx Systems web site; and finally, you connect to the repository. Full instructions on all three stages are provided below.

#### Set Up an ODBC Driver

Setting up an ODBC driver is only necessary for *MySQL*, *PostgreSQL*, *Progress OpenEdge* and *Adaptive Server Anywhere*. These database management systems require specific set-up in order to operate as a repository. Other database management systems connect through OLE DB and do not require a driver, so this stage can be skipped.

#### Note:

For Oracle, the *Microsoft OLE DB Provider for Oracle* is not appropriate. You use the [Oracle Provider for OLE DB](#) <sup>[153]</sup> instead.

To find out how to set up an ODBC driver, go to:

- [Set Up a MySQL ODBC Driver](#) <sup>[135]</sup>
- [Set Up a PostgreSQL ODBC Driver](#) <sup>[138]</sup>
- [Set Up an Adaptive Server Anywhere ODBC Driver](#) <sup>[141]</sup>
- [Set Up a Progress OpenEdge ODBC Driver](#) <sup>[145]</sup>.

## Create a Repository

To find out how to download the scripts and create the data repository tables, go to:

- [Create a MySQL Data Repository](#) <sup>[123]</sup>
- [Create an Access 2007 Repository](#) <sup>[123]</sup>
- [Create a SQL Server Data Repository](#) <sup>[126]</sup>
- [Create an Oracle Data Repository](#) <sup>[129]</sup>
- [Create a PostgreSQL Data Repository](#) <sup>[129]</sup>
- [Create an Adaptive Server Anywhere Data Repository](#) <sup>[132]</sup>
- [Create an MSDE Server Data Repository](#) <sup>[134]</sup>
- [Create a Progress OpenEdge Data Repository](#) <sup>[134]</sup>

## Connect to a Repository

Once the repository is created, you can connect to it.

### Note:

To connect to a repository, you must have the usual SELECT, UPDATE, INSERT and DELETE permissions.

To find out how to connect to your repository, see one of the following topics:

- [Connect to a MySQL Data Repository](#) <sup>[148]</sup>
- [Connect to a SQL Server Data Repository](#) <sup>[150]</sup>
- [Connect to an Oracle Data Repository](#) <sup>[153]</sup>
- [Connect to a PostgreSQL Data Repository](#) <sup>[160]</sup>
- [Connect to an Adaptive Server Anywhere Data Repository](#) <sup>[162]</sup>
- [Connect to an MSDE Server Data Repository](#) <sup>[165]</sup>
- [Connect to a Progress OpenEdge Data Repository](#) <sup>[165]</sup>

### 3.3.1 Create a Repository

This topic details how to create the following data repositories:

- [Access 2007](#) <sup>[123]</sup>
- [MySQL](#) <sup>[123]</sup>
- [SQL Server](#) <sup>[126]</sup>
- [Oracle 9i, 10g or 11g](#) <sup>[129]</sup>
- [PostgreSQL](#) <sup>[129]</sup>
- [Adaptive Server Anywhere \(ASA\)](#) <sup>[132]</sup>
- [MSDE Server](#) <sup>[134]</sup>

#### 3.3.1.1 Access 2007

### Note:

This feature is available in the Corporate, Business and Software Engineering, System Engineering and Ultimate editions.

Using Access 2007, open a .EAP file and allow Access to convert it to a .ACCDB file. This forms the Access 2007 repository.

#### 3.3.1.2 MySQL Repository

### Note:

This feature is available in the Corporate, Business and Software Engineering, System Engineering and Ultimate editions.

Before creating a MySQL data repository in Enterprise Architect, you must set up the MySQL and MySQL ODBC drivers. For further information on setting these up, see [MySQL ODBC Driver](#) <sup>[135]</sup>.

To create a new MySQL repository, you must first create a database into which to import the table definitions for Enterprise Architect. Sparx Systems provide SQL scripts to create the required tables; how you create the database and execute that script are up to you.

- Registered users can obtain the scripts from the Registered Corporate edition [Resources](#) page of the Sparx Systems website at [http://www.sparxsystems.com/registered/reg\\_ea\\_corp\\_ed.html](http://www.sparxsystems.com/registered/reg_ea_corp_ed.html)
- Trial users can obtain the scripts from the Corporate edition [Resources](#) page of the Sparx Systems website at <http://www.sparxsystems.com/resources/corporate/>.

### Create the Data Repository

Once you have created the database and executed the script, you should have an empty Enterprise Architect project to begin working with. You can transfer data from an existing .EAP file or simply start from scratch.

### Third Party Tools

If you are unfamiliar with MySQL and DBMS systems in general, you might want to consider a suitable front end tool.

MySQL Administrator, available from <http://dev.mysql.com/downloads/gui-tools/5.0.html>, is one such tool. It provides a convenient graphical user interface to enable the creation of databases, execution of scripts, backups and restores.

To get started, follow the steps below:

1. Run MySQL Administrator and create a new database.

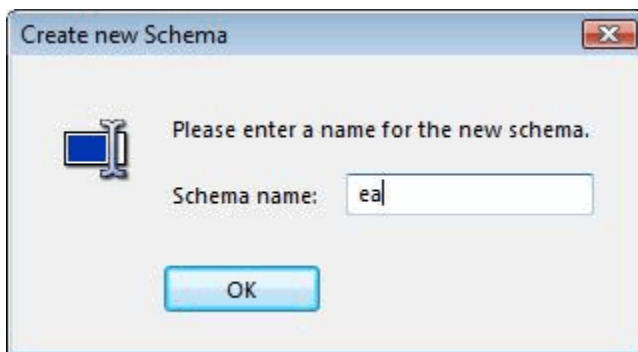

2. Run MySQL Query Browser, and open and execute the MySQL repository script.



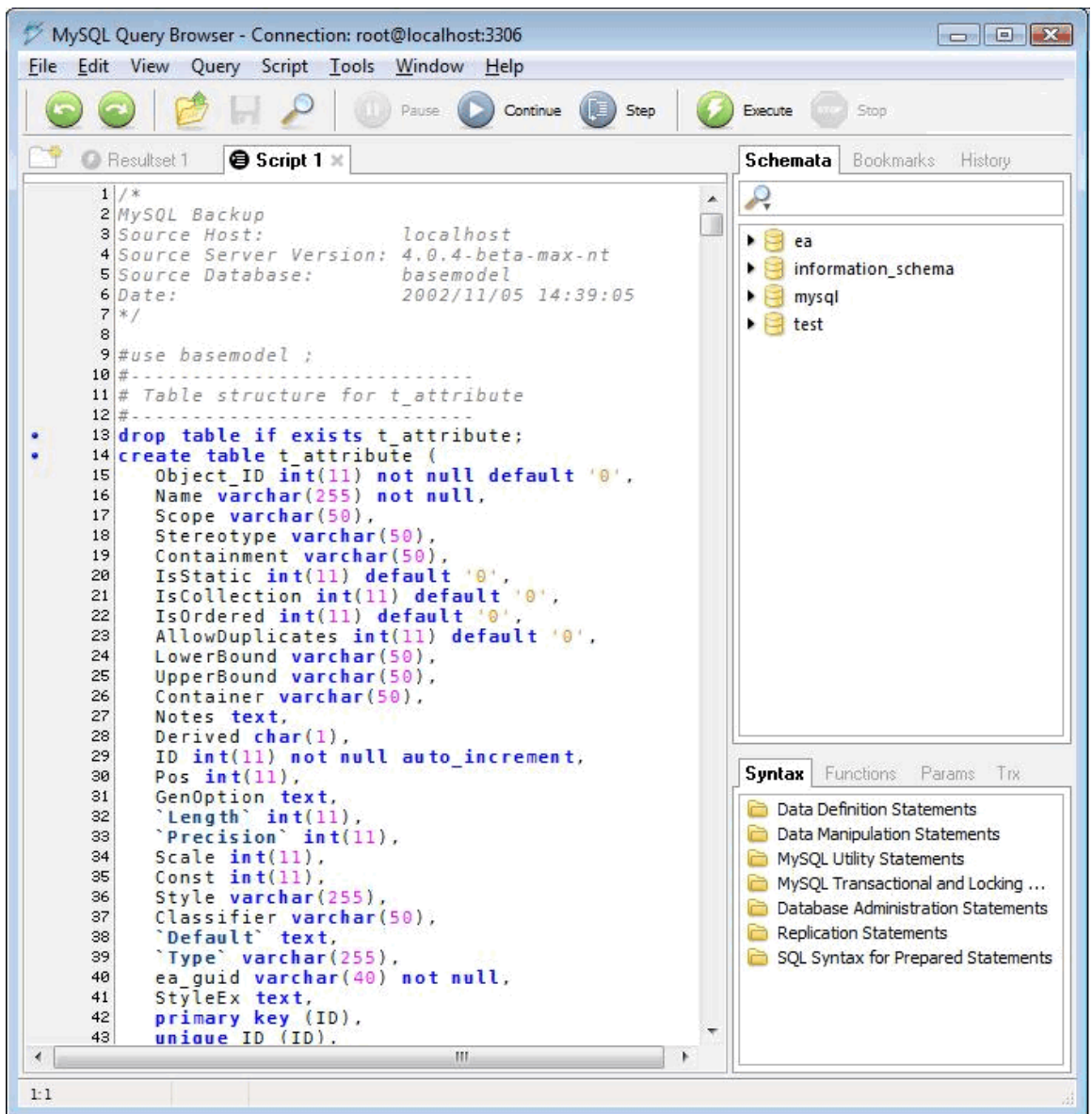

- Below is an example showing the tables created in the MySQL repository after running the script in MySQL Query Browser.

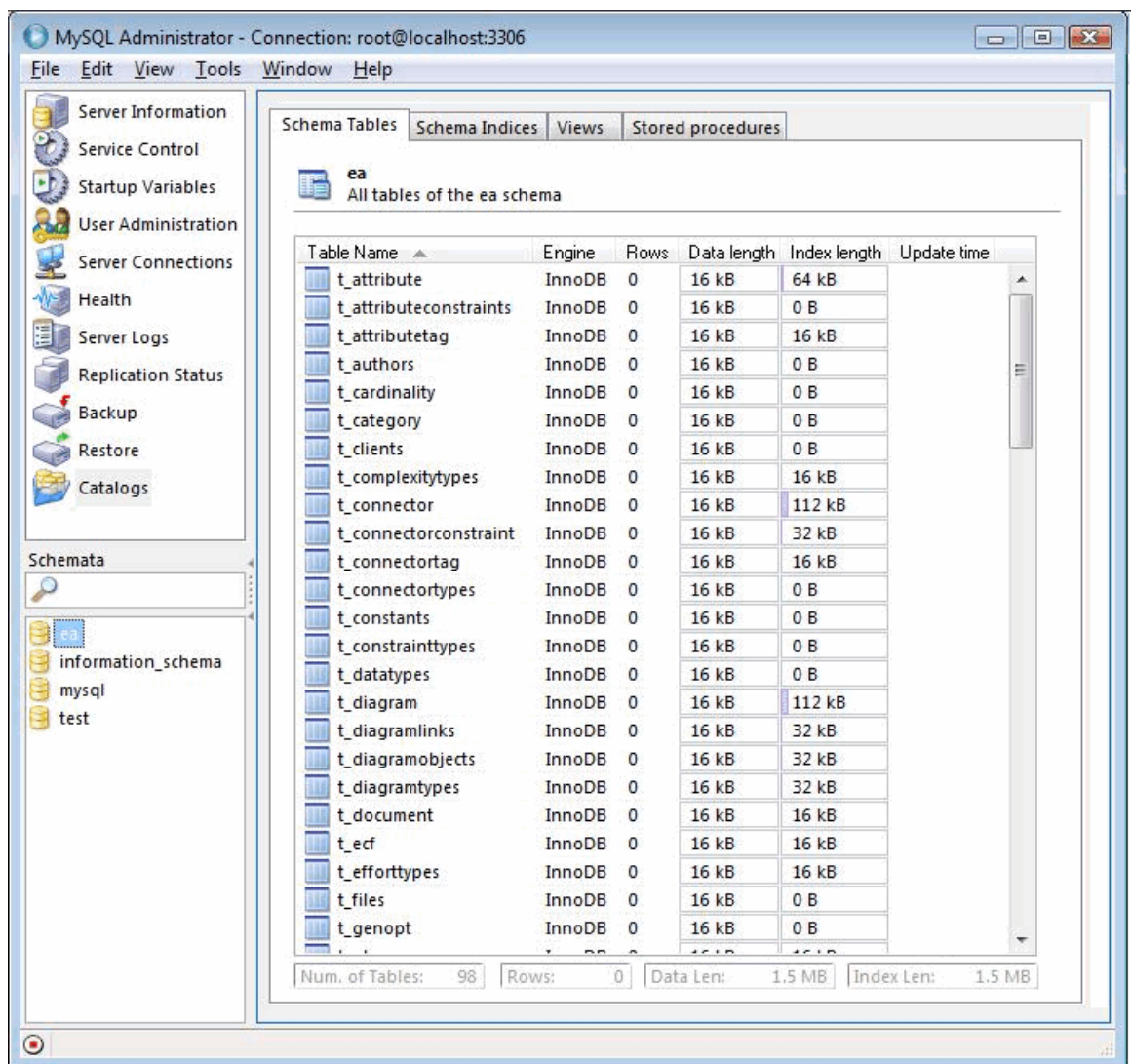

### 3.3.1.3 SQL Server Repository

#### Note:

This feature is available in the Corporate, Business and Software Engineering, System Engineering and Ultimate editions.

Before creating a SQL Server data repository, you must have SQL Server and MDAC 2.6 or higher installed, and access permission to create a new database. Please note that setting up SQL Server and the issues involved are beyond the scope of this user guide. Consult your program's documentation for a guide to this.

Sparx Systems provide SQL scripts to create the required tables; how you create the database and execute that script are up to you.

- Registered users can obtain the scripts from the Registered Corporate edition [Resources](http://www.sparxsystems.com/registered/reg_ea_corp_ed.html) page of the Sparx Systems website at [http://www.sparxsystems.com/registered/reg\\_ea\\_corp\\_ed.html](http://www.sparxsystems.com/registered/reg_ea_corp_ed.html)
- Trial users can obtain the scripts from the Corporate edition [Resources](http://www.sparxsystems.com/resources/corporate/) page of the Sparx Systems website at <http://www.sparxsystems.com/resources/corporate/>.

#### Create a SQL Server Repository

SQL Server repositories are created without any data, so you must perform a [project data transfer](#)<sup>[306]</sup> in Enterprise Architect to copy a suitable starter project. If you are starting from scratch, [EABase.EAP](#)<sup>[120]</sup> is a good starting point. If you are using an existing .EAP model, you can [upsized](#)<sup>[122]</sup> it.

To use SQL Enterprise Manager to create a SQL Server repository, follow the steps below:

1. In SQL Enterprise Manager, locate the server on which to create your new Enterprise Architect model; in the example below this is DBSERVER02\SQLEXPRESS.

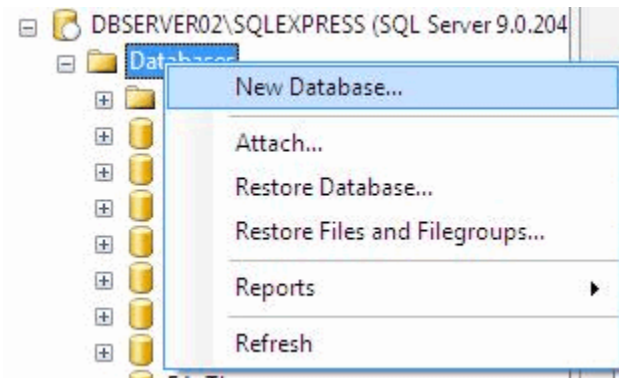

2. Right-click and choose the **New Database** context menu option.
3. Enter a suitable name for the database. Set any file options as required.

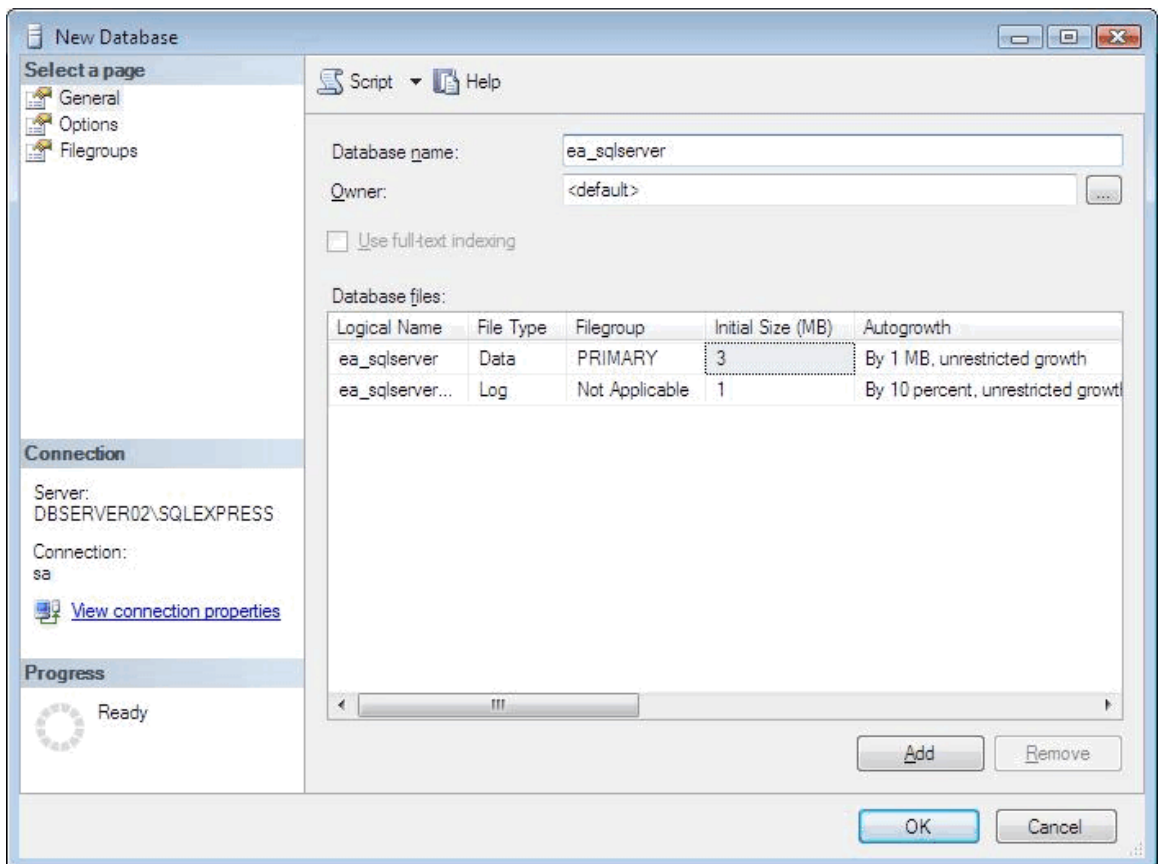
**Note:**

Ensure that the database collation is case-insensitive.

4. Click on the database to select it, then select the **New Query** menu option.

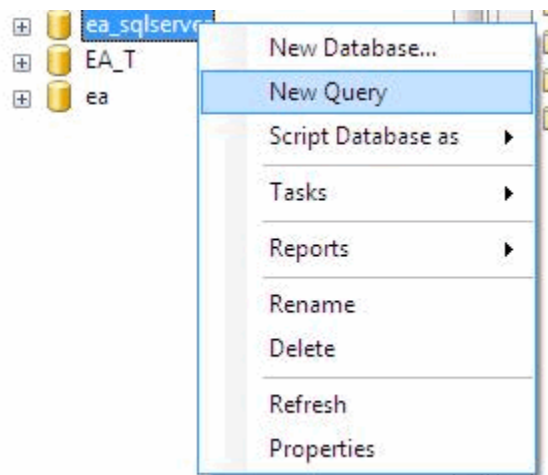

5. In the **Query** window, use the **Open File** dialog to locate the supplied Enterprise Architect SQL Server Model script file.

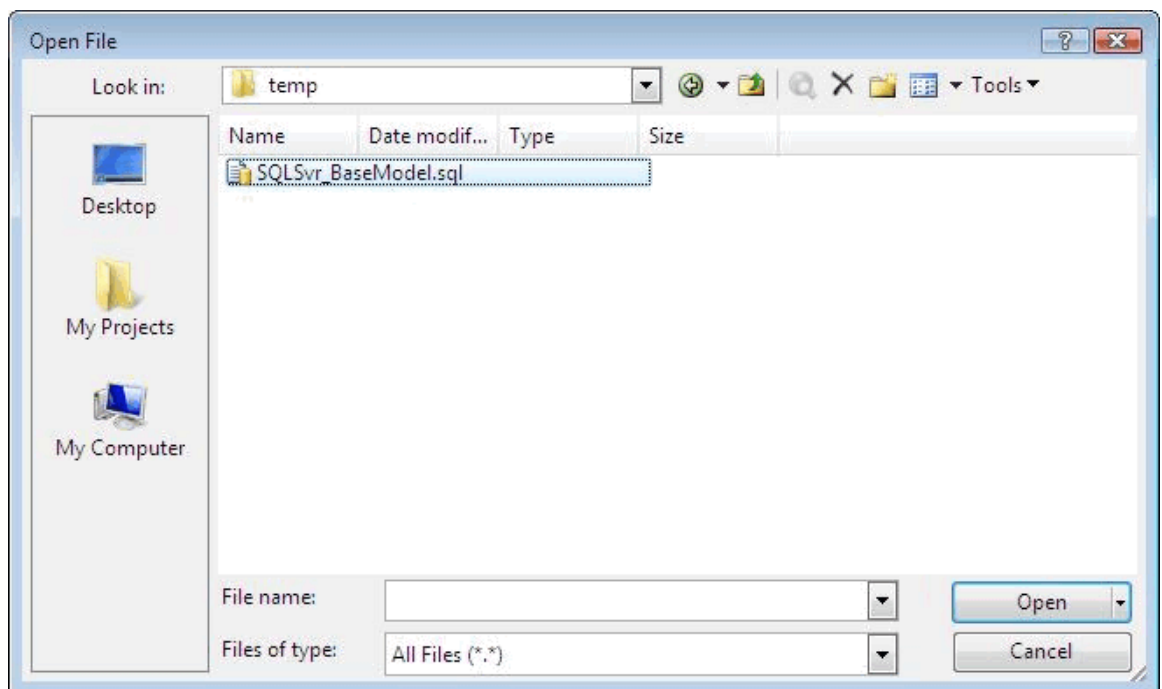

6. Click on the **Open** button. Check that you have selected the correct database to run the script in. In this example the tables are being added to the *ea\_sqlserver* database as shown in the drop-down menu below.

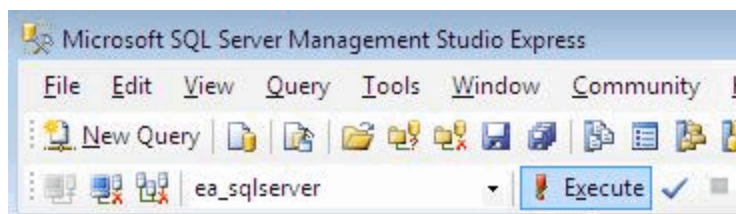

7. Click on the **Execute** button; SQL Server executes the script, which creates the base model for an Enterprise Architect project.

### 3.3.1.4 Oracle Server Repository

**Note:**

This feature is available in the Corporate, Business and Software Engineering, System Engineering and Ultimate editions.

Before creating an Oracle data repository, you must have the appropriate version of Oracle (9i, 10g or 11g) and MDAC 2.6 or higher installed, and access permission to create a new database. Please note that setting up Oracle and the issues involved are beyond the scope of this manual. Consult your program documentation for guidance.

Sparx Systems provide SQL scripts to create the required tables; how you create the database and execute that script are up to you.

- Registered users can obtain the scripts from the Registered Corporate edition **Resources** page of the Sparx Systems website at [http://www.sparxsystems.com/registered/reg\\_ea\\_oracle\\_instructions.html](http://www.sparxsystems.com/registered/reg_ea_oracle_instructions.html)
- Trial users can obtain the scripts from the Corporate edition **Resources** page of the Sparx Systems website at <http://www.sparxsystems.com/resources/corporate/>.

#### Create the Data Repository

Oracle repositories are created without any data, so you must perform a [project data transfer](#)<sup>[306]</sup> in Enterprise Architect to copy a suitable starter project. If you are starting from scratch, [EABase.EAP](#)<sup>[120]</sup> is a good starting point. If you want to use an existing .EAP model, you can [upscale](#)<sup>[175]</sup> it; follow the steps below:

1. Create a new database on the Oracle server.
2. Connect to the newly created database with a program such as Oracle SQL\*Plus or SQL Plus Worksheet.
3. Execute the script *Oracle\_BaseModel.sql*, which creates the base model tables and indexes for an Enterprise Architect Project.

### 3.3.1.5 PostgreSQL Repository

**Note:**

This feature is available in the Corporate, Business and Software Engineering, System Engineering and Ultimate editions.

Before creating a PostgreSQL data repository in Enterprise Architect, you must set up PostgreSQL and PostgreSQL ODBC drivers. For further information on setting these up, see [Set up a PostgreSQL ODBC Driver](#)<sup>[138]</sup>.

To create a new PostgreSQL repository, you must first create a database into which to import the table definitions for Enterprise Architect. Sparx Systems provide SQL scripts to create the required tables; how you create the database and execute that script are up to you.

- Registered users can obtain the scripts from the Registered Corporate edition **Resources** page of the Sparx Systems website at [http://www.sparxsystems.com/registered/reg\\_ea\\_corp\\_ed.html](http://www.sparxsystems.com/registered/reg_ea_corp_ed.html)
- Trial users can obtain the scripts from the Corporate edition **Resources** page of the Sparx Systems website at <http://www.sparxsystems.com/resources/corporate/>.

#### Create the Data Repository

After you create the database and execute the script, the result should be an empty Enterprise Architect project to begin working with. You can transfer data from an existing .EAP file or simply start from scratch.

#### Third Party Tools

If you are unfamiliar with PostgreSQL and DBMS systems in general, you might want to consider a suitable front end tool.

One such tool is *pgAdminIII*, which is available at <http://www.pgadmin.org/download/>. It provides a convenient graphical user interface to enable creation of databases, execution of scripts and restores.

To get started with pgAdminIII, follow the steps below:

1. Create a new database.

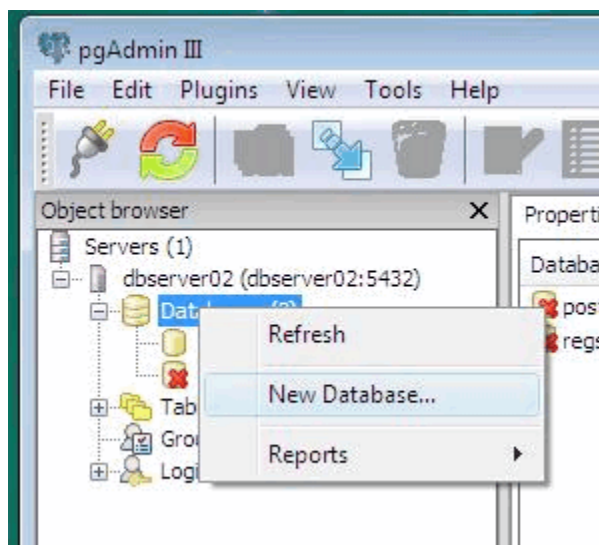

2. Open and execute the PostgreSQL SQL script.

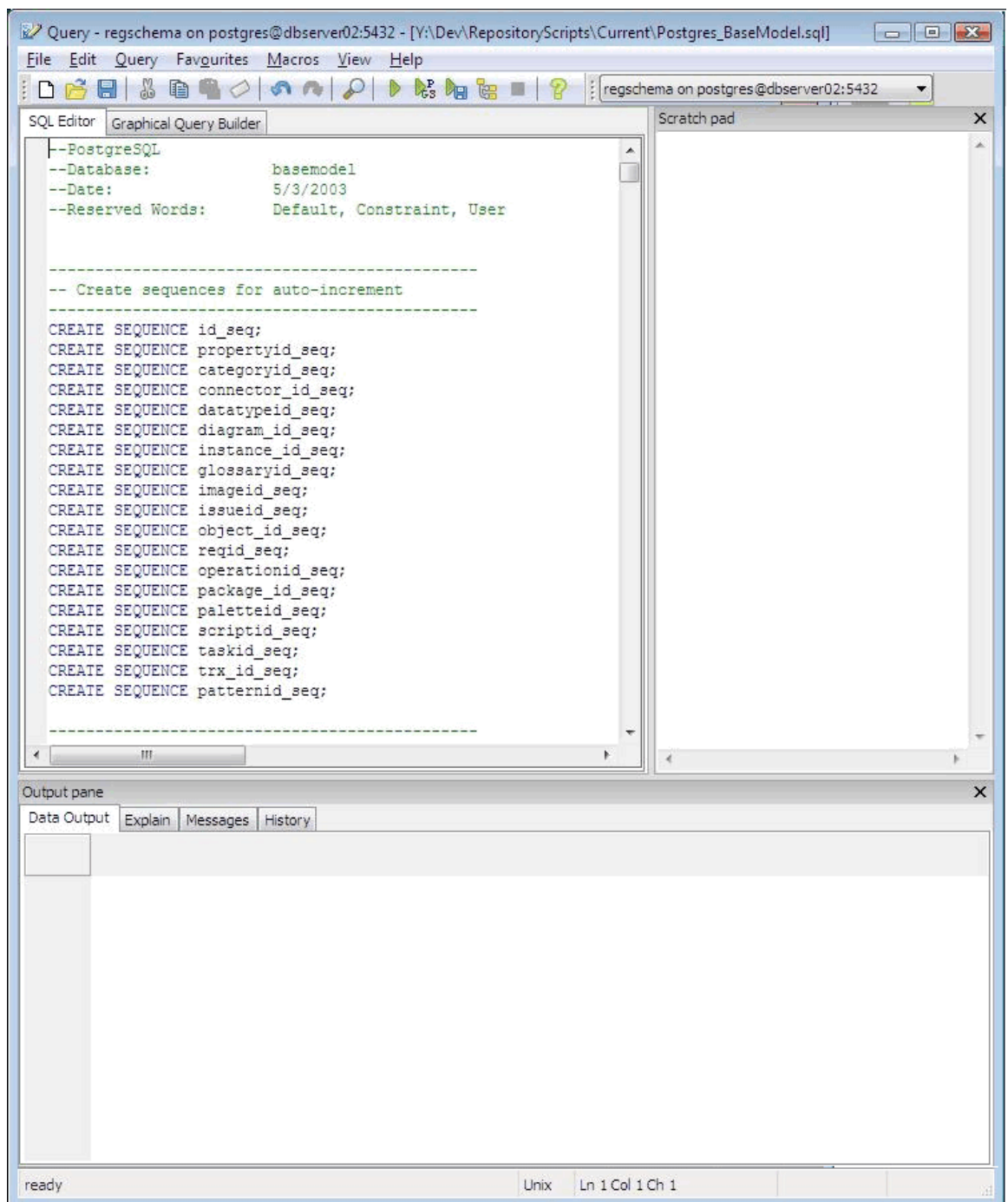

The screenshot shows a PostgreSQL query editor window titled "Query - regschema on postgres@dbserver02:5432 - [Y:\Dev\RepositoryScripts\Current\Postgres\_BaseModel.sql]". The window has a menu bar (File, Edit, Query, Favourites, Macros, View, Help) and a toolbar. The main area is split into two panes: "SQL Editor" and "Scratch pad". The "SQL Editor" pane contains the following SQL script:

```
--PostgreSQL
--Database:          basemodel
--Date:             5/3/2003
--Reserved Words:   Default, Constraint, User

-----
-- Create sequences for auto-increment
-----

CREATE SEQUENCE id_seq;
CREATE SEQUENCE propertyid_seq;
CREATE SEQUENCE categoryid_seq;
CREATE SEQUENCE connector_id_seq;
CREATE SEQUENCE datatypeid_seq;
CREATE SEQUENCE diagram_id_seq;
CREATE SEQUENCE instance_id_seq;
CREATE SEQUENCE glossaryid_seq;
CREATE SEQUENCE imageid_seq;
CREATE SEQUENCE issueid_seq;
CREATE SEQUENCE object_id_seq;
CREATE SEQUENCE reqid_seq;
CREATE SEQUENCE operationid_seq;
CREATE SEQUENCE package_id_seq;
CREATE SEQUENCE paletteid_seq;
CREATE SEQUENCE scriptid_seq;
CREATE SEQUENCE taskid_seq;
CREATE SEQUENCE trx_id_seq;
CREATE SEQUENCE patternid_seq;

-----
```

The "Scratch pad" pane is empty. Below the editor panes is an "Output pane" with tabs for "Data Output", "Explain", "Messages", and "History". The "Data Output" tab is selected, and the pane is currently empty. The status bar at the bottom of the window shows "ready", "Unix", and "Ln 1 Col 1 Ch 1".

3. Below is an example showing the tables created in the PostgreSQL repository after running the script in pgAdminIII.

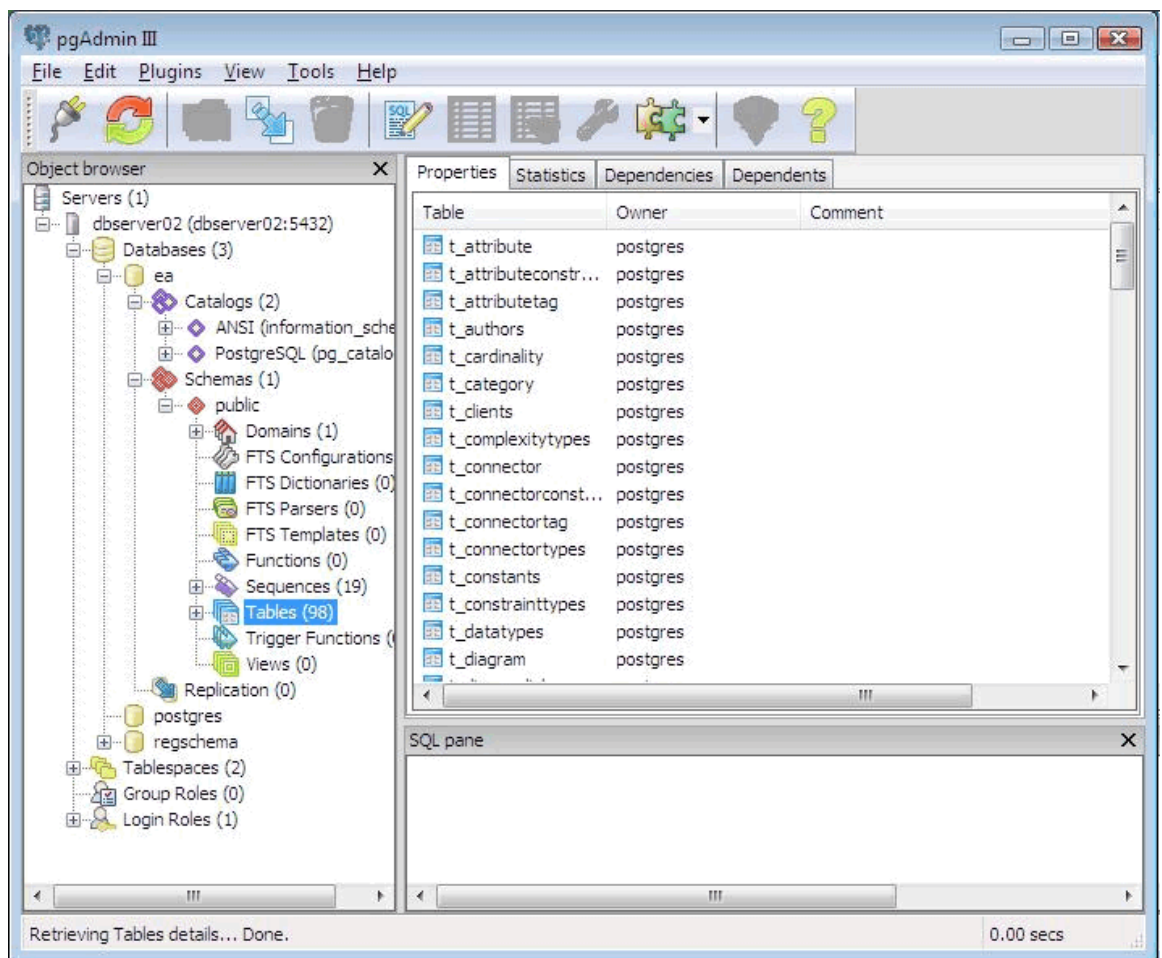

### 3.3.1.6 Adaptive Server Anywhere Repository

#### Note:

This feature is available in the Corporate, Business and Software Engineering, System Engineering and Ultimate editions.

Before creating an ASA data repository in Enterprise Architect, you must set up ASA and ASA ODBC drivers. For further information on setting these up, see [Setup an Adaptive Server Anywhere ODBC Driver](#)<sup>[14]</sup>.

To create a new ASA repository, you must first create a database into which to import the table definitions for Enterprise Architect. Sparx Systems provide SQL scripts to create the required tables - how you create the database and execute that script are up to you.

- Registered users can obtain the scripts from the Registered Corporate edition [Resources](#) page of the Sparx Systems website at [http://www.sparxsystems.com/registered/reg\\_ea\\_corp\\_ed.html](http://www.sparxsystems.com/registered/reg_ea_corp_ed.html)
- Trial users can obtain the scripts from the Corporate edition [Resources](#) page of the Sparx Systems website at <http://www.sparxsystems.com/resources/corporate/>.

### Create the Data Repository

After you create the database and execute the script, the result should be an empty Enterprise Architect project to begin working with. You can transfer data from an existing .EAP file or simply start from scratch.

#### Third Party Tools

If you are unfamiliar with ASA and DBMS systems in general, you might want to consider a suitable front end tool.

Sybase Central is one such tool, that can be installed along with the DBMS. It provides a convenient graphical user interface to enable creation of databases, execution of scripts and restores.

To get started with Sybase Central, follow the steps below:



1. Create a new database.

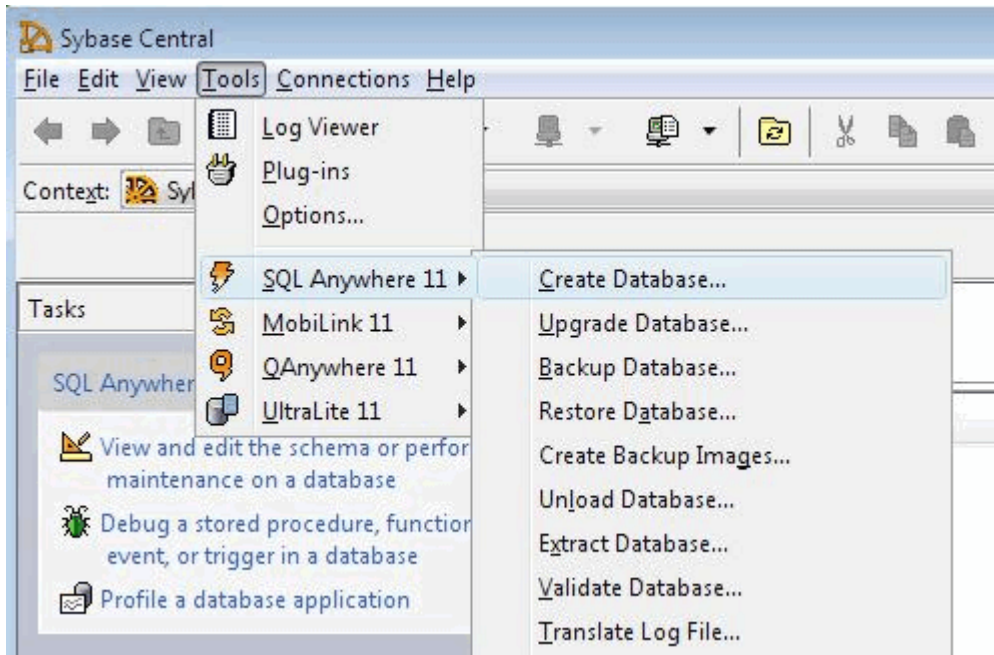

2. Open Interactive SQL and execute the AS SQL script.

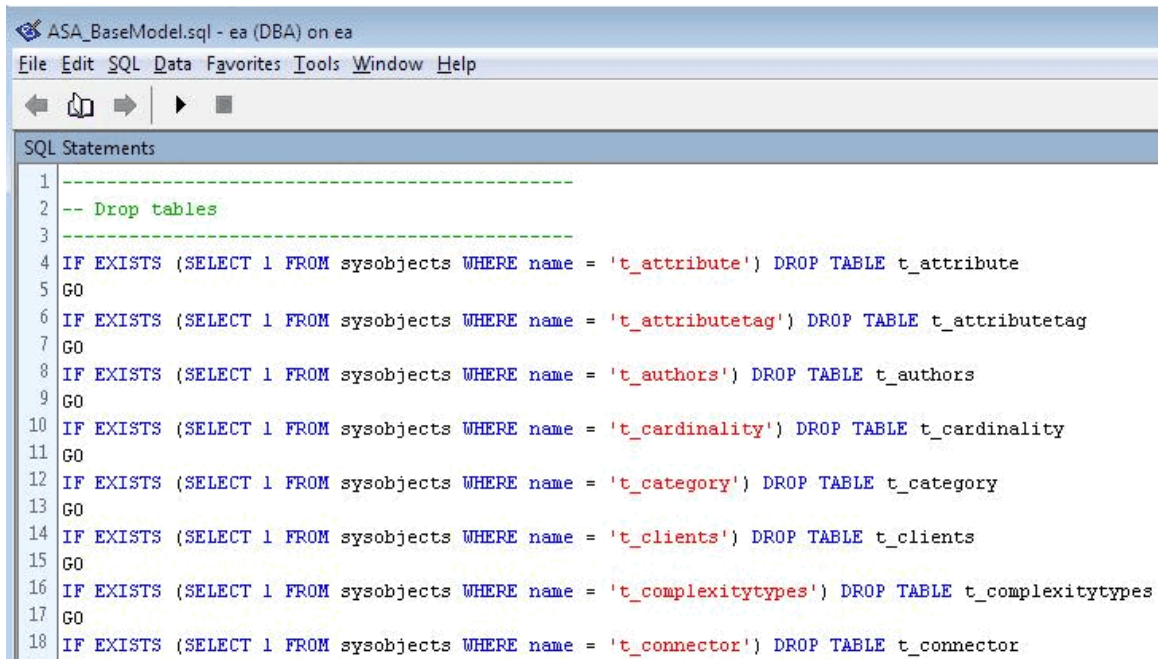

The following example shows the tables created in the ASA repository after running the script in EMS ASA Manager.

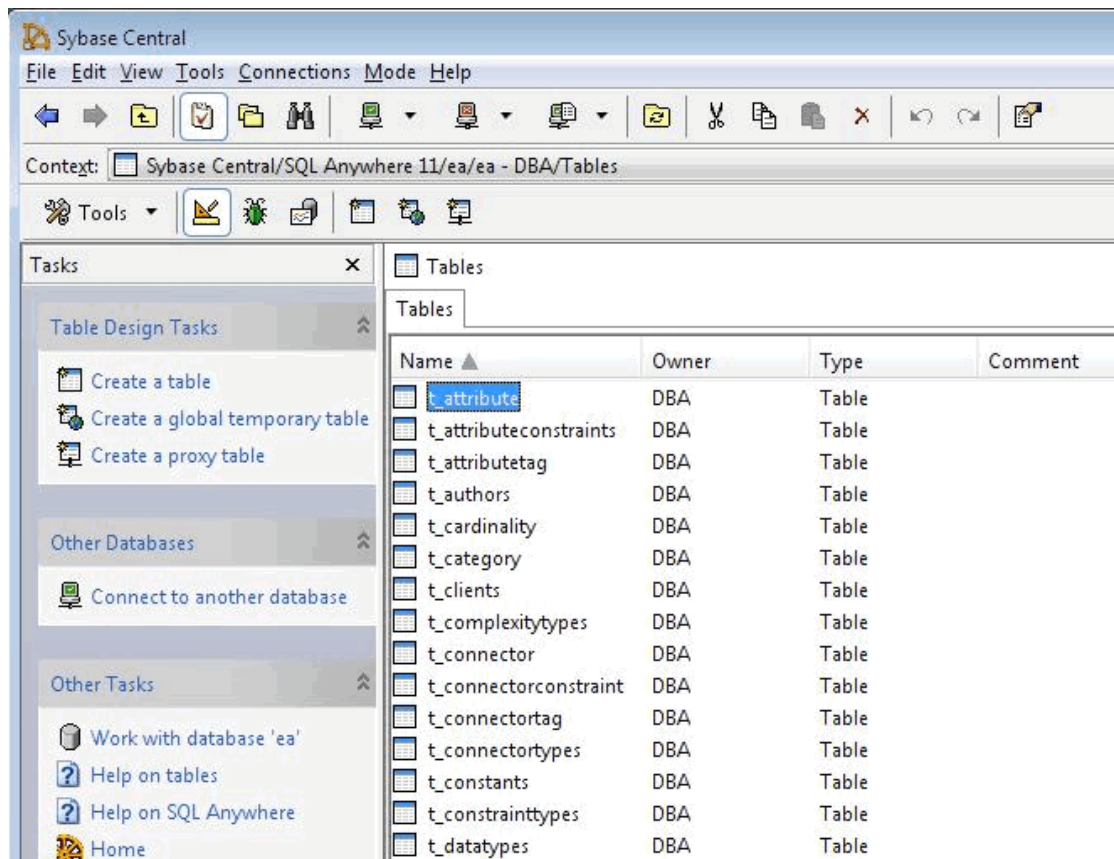

### 3.3.1.7 MSDE Server Repository

#### Note:

This feature is available in the Corporate, Business and Software Engineering, System Engineering and Ultimate editions.

Before creating a SQL Server MSDE data repository, you must have MSDE Server and MDAC 2.6 or higher installed. Please note that setting up MSDE Server and the issues involved are beyond the scope of this user guide. Consult your program documentation for guidance.

Sparx Systems provide SQL scripts to create the required tables; how you create the database and execute that script are up to you.

- Registered users can obtain the scripts from the Registered Corporate edition [Resources](http://www.sparxsystems.com/registered/reg_ea_corp_ed.html) page of the Sparx Systems website at [http://www.sparxsystems.com/registered/reg\\_ea\\_corp\\_ed.html](http://www.sparxsystems.com/registered/reg_ea_corp_ed.html)
- Trial users can obtain the scripts from the Corporate edition [Resources](http://www.sparxsystems.com/resources/corporate/) page of the Sparx Systems website at <http://www.sparxsystems.com/resources/corporate/>.

Use the SQL Server 2000, 2005 or 2008 script for MSDE, and follow the steps to [Create a New SQL Server Data Repository](#) <sup>[126]</sup>.

### 3.3.1.8 Progress OpenEdge Repository

#### Notes:

- This feature is available in the Corporate, Business and Software Engineering, System Engineering and Ultimate editions.
- The OpenEdge database must be either version 10.0B03 or version 10.1B01, or later.

Before creating a Progress OpenEdge data repository, you must have OpenEdge and MDAC 2.6 or higher installed, and access permission to create a new database. Please note that setting up OpenEdge and the issues involved are beyond the scope of this manual. Consult your OpenEdge documentation for guidance.

Sparx Systems provide SQL scripts to create the required tables; how you create the database and execute

that script is up to you.

- Registered users can obtain the scripts from the Registered Corporate edition **Resources** page of the Sparx Systems website at [http://www.sparxsystems.com/registered/reg\\_ea\\_openedge\\_instructions.html](http://www.sparxsystems.com/registered/reg_ea_openedge_instructions.html)
- Trial users can obtain the scripts from the Corporate edition **Resources** page of the Sparx Systems website at <http://www.sparxsystems.com/resources/corporate/>.

## Create the Data Repository

OpenEdge repositories are created without any data, so you must perform a [project data transfer](#)<sup>[306]</sup> in Enterprise Architect to copy a suitable starter project. If you are starting from scratch, [EABase.EAP](#)<sup>[120]</sup> is a good starting point. If you want to use an existing .EAP model, you can [upsized](#)<sup>[171]</sup> it.

1. Run proenv from the **OpenEdge** menu: **Start->Programs->OpenEdge->proenv**.
2. Create database: `prodb <database_name> empty`.
3. Start database server: `proserve <database_name> -S <port_number>`
4. Open Data Administration to add a user:  
`prowin32 -db <database_name> -S <port_number> -p _admin -rx`
5. Open **Admin->Security->Edit User List**.
6. Close Data Administration.
7. Open SQL Explorer Tool, connect as 'sysprogress'.
8. Add user:  
`create user 'user', 'password';`  
`commit;`
9. Grant privileges:  
`grant dba, resource to <user>;`  
`commit;`

### 3.3.2 Set Up an ODBC Driver for a Connection to a Repository

This topic details how to set up the following ODBC drivers, to enable connection to an Enterprise Architect data repository:

- [MySQL ODBC Driver](#)<sup>[135]</sup>
- [PostgreSQL ODBC Driver](#)<sup>[138]</sup>
- [Adaptive Server Anywhere ODBC Driver](#)<sup>[141]</sup>
- [Progress OpenEdge ODBC Driver](#)<sup>[145]</sup>

MySQL, PostgreSQL, Sybase Adaptive Server Anywhere and Progress OpenEdge require specific set-up in order to operate as a repository. Other database management systems connect through OLE DB and do not require a driver.

#### 3.3.2.1 MySQL ODBC Driver

Before you can connect to a MySQL data repository, you must first set up a MySQL ODBC driver for which, in turn, you must first have installed Microsoft MDAC components, a MySQL DBMS system and a MySQL ODBC driver.

##### Note:

The recommended MySQL ODBC driver version is 5.1.5. (Version 3.51.14 creates problems in incorporating tests in elements.)

To set up your MySQL ODBC Driver, follow the steps below:

1. Select the Windows™ **Control Panel | Administrative Tools | Data Sources (ODBC)** option. The **ODBC Data Source Administrator** window displays.

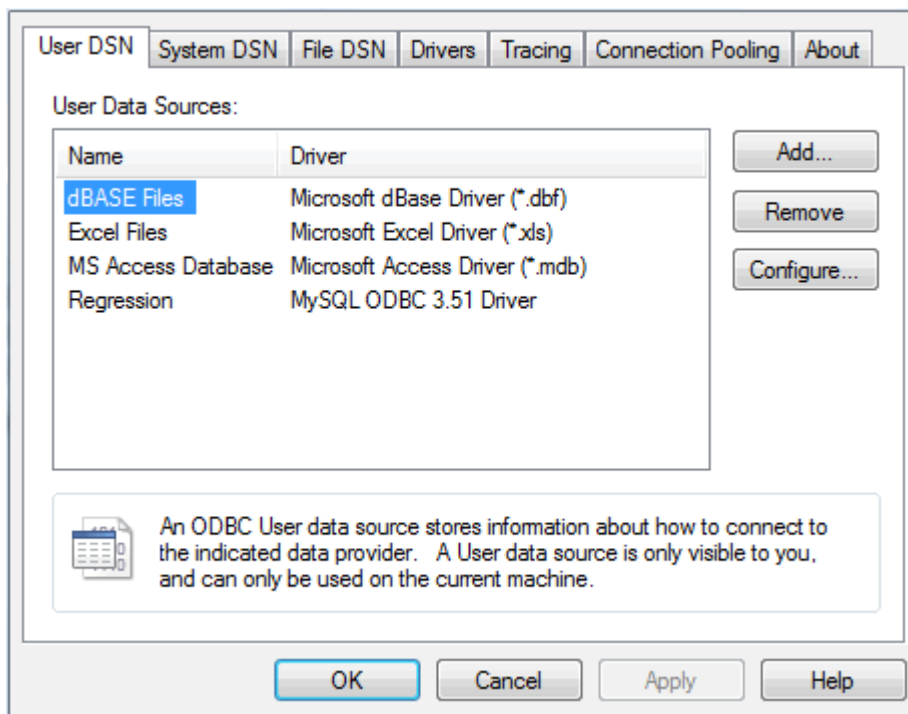

2. Click on the **Add** button. The **Create New Data Source** dialog displays, enabling you to add a new DSN.

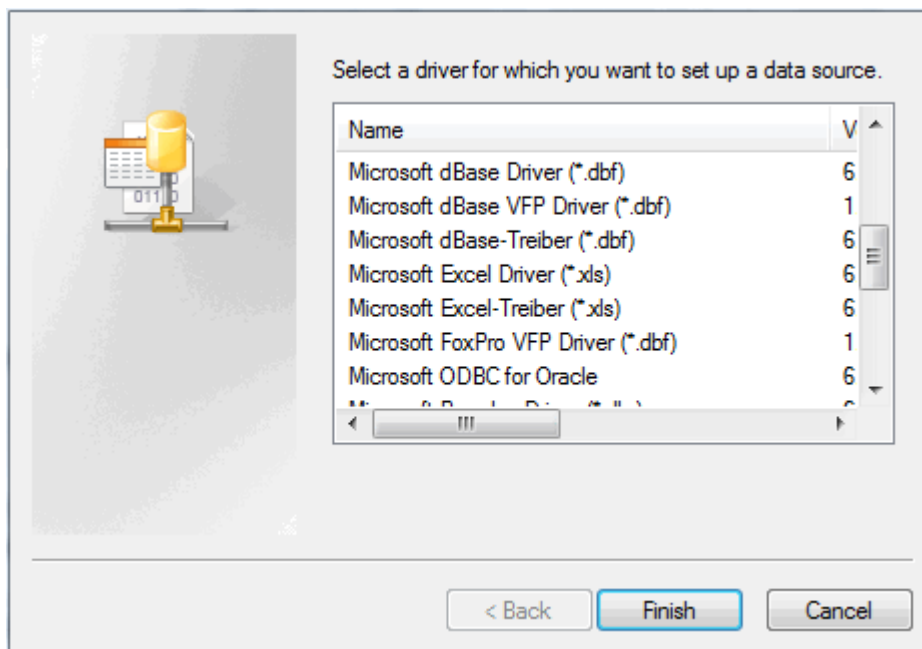

3. Select **MySQL ODBC 5.1 Driver** from the list.
4. Click on the **Finish** button. The **MySQL Connector/ODBC** dialog displays.
5. Enter the following configuration details:
  - A data source name for the connection
  - A description (optional)
  - The host address of the DBMS server
  - User name and password
  - The database name on the selected server.
 See the example below:

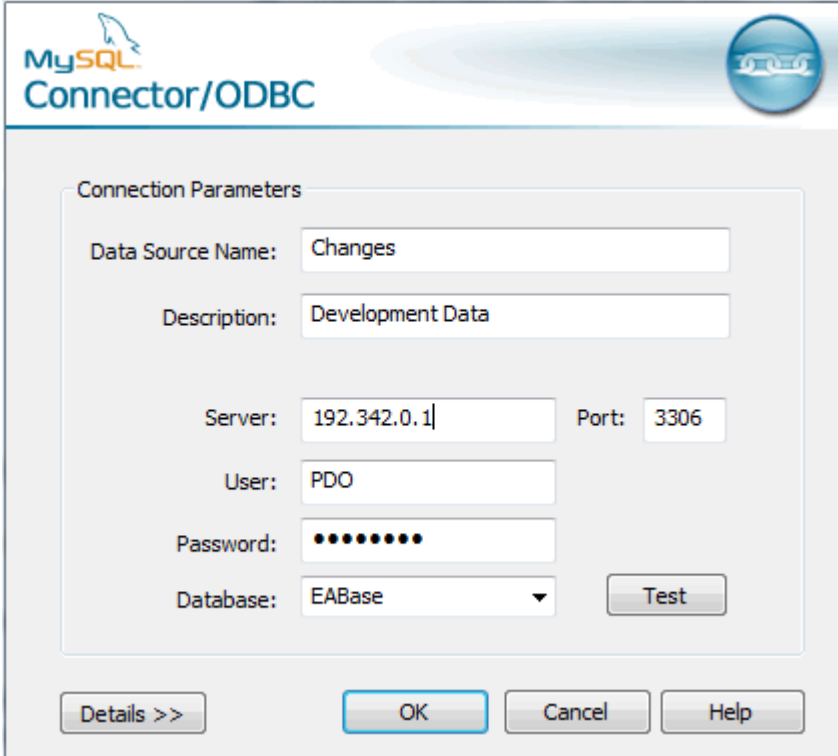

The screenshot shows the 'MySQL Connector/ODBC' dialog box. The 'Connection Parameters' section contains the following fields:

- Data Source Name: Changes
- Description: Development Data
- Server: 192.342.0.1
- Port: 3306
- User: PDO
- Password: (masked with dots)
- Database: EABase (dropdown menu)

Buttons at the bottom include 'Details >>', 'OK', 'Cancel', and 'Help'. A 'Test' button is located next to the Database dropdown.

6. Click on the **Details>>** button and **Flags 1** tab to set the advanced options.

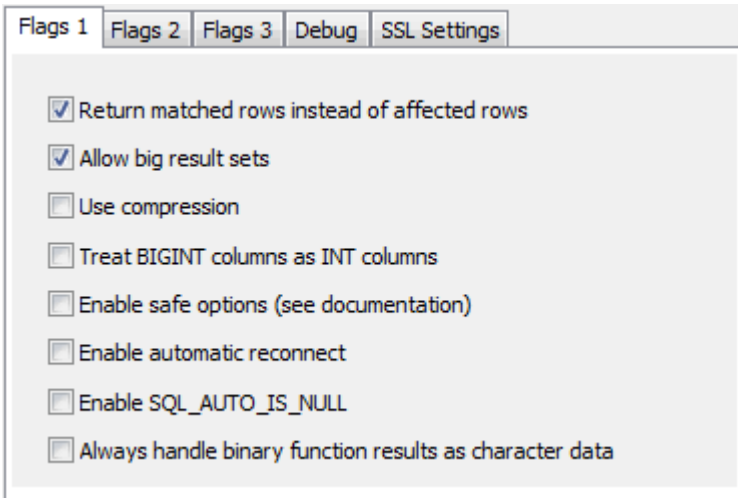

The screenshot shows the 'Flags 1' tab of the MySQL Connector/ODBC dialog box. The following checkboxes are visible:

- Return matched rows instead of affected rows
- Allow big result sets
- Use compression
- Treat BIGINT columns as INT columns
- Enable safe options (see documentation)
- Enable automatic reconnect
- Enable SQL\_AUTO\_IS\_NULL
- Always handle binary function results as character data

7. Select the **Return matched rows instead of affected rows** and **Allow big result sets** checkboxes.
  8. Click on the **Test** button to confirm that the details are correct.
  9. If the test succeeds, click on the **OK** button to complete the configuration.
  10. If the test does not succeed, review your settings.
- Your MySQL connection is now available to use in Enterprise Architect.

### 3.3.2.2 PostgreSQL ODBC Driver

Before you can connect to a PostgreSQL data repository, you must first set up a PostgreSQL ODBC driver. To do this, you must have Microsoft MDAC components, a PostgreSQL DBMS system and a PostgreSQL ODBC driver (version 7.03.01.00 minimum) installed.

**Note:**

Do not use version 8.4.1 of the PostgreSQL ODBC Driver; it presents difficulties in transferring a project to a PostgreSQL repository.

To set up your PostgreSQL ODBC driver, follow the steps below:

1. Select the Windows™ **Control Panel | Administrative Tools | Data Sources (ODBC)** option. The **ODBC Data Sources Administrator** window displays.

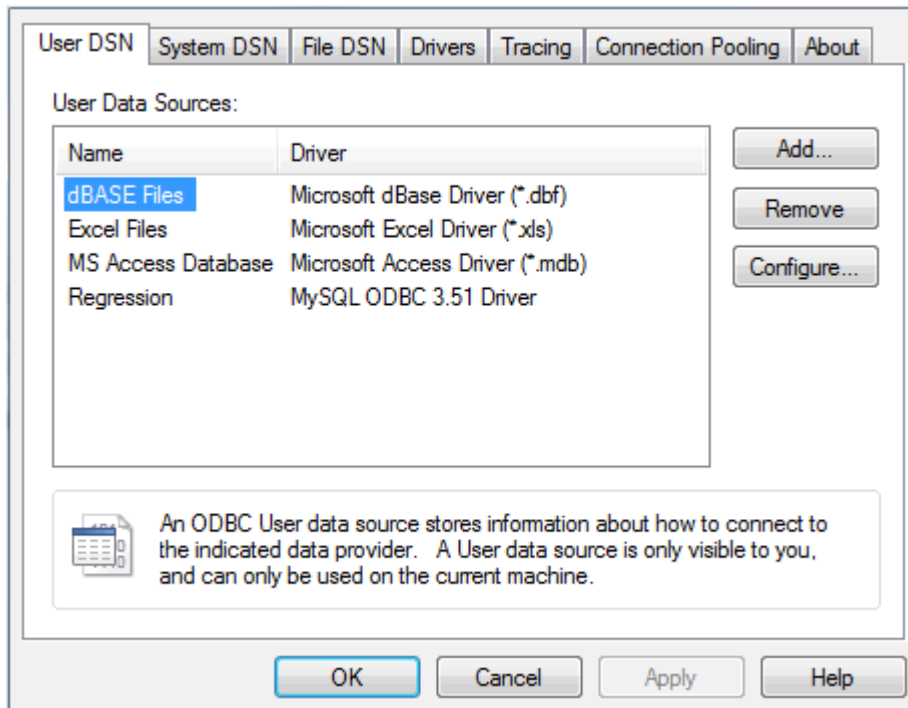

2. Click on the **Add** button. The **Create New Data Source** dialog displays, enabling you to add a new DSN.

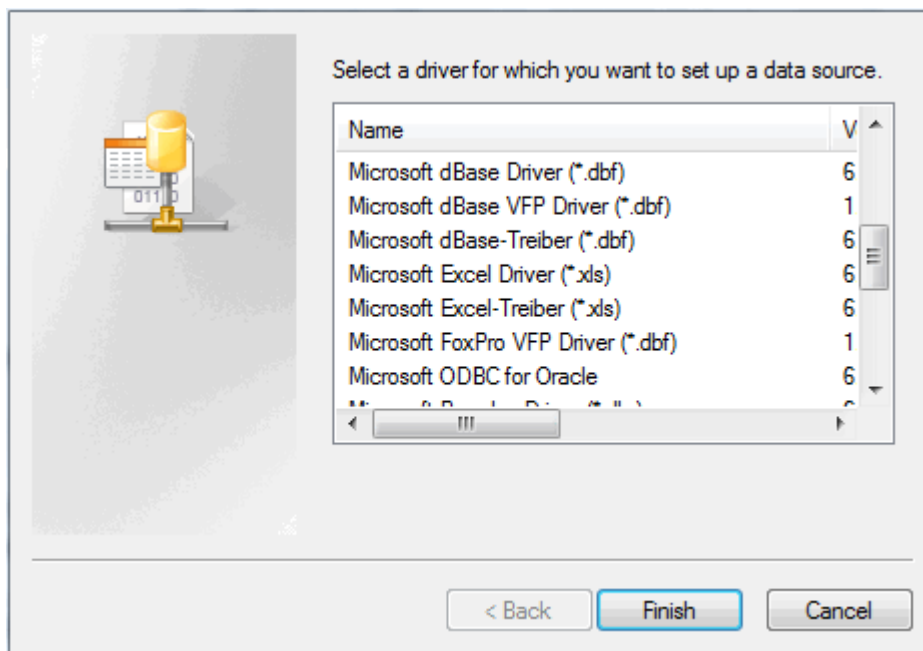

3. Select **PostgreSQL** from the list.
4. Click on the **Finish** button.
5. Enter the following configuration details:
  - A name for the connection
  - The actual name of the database.
  - Description (optional)
  - The host address of the PostgreSQL server.
  - User name and password.

Data Source: psql\_base  
Database: ea\_base  
Server: dbserver  
User Name: postgres  
Description:   
SSL Mode: disable  
Port: 5432  
Password:   
Options: Datasource Global  
Test  
Save Cancel

6. Click on the **Datasource** button and set the options on Page 1 and Page 2 as shown on the examples below:

Page 1 Page 2

Disable Genetic Optimizer
  CommLog (C:\psqlodbc\_xxxx.log)

KSQO(Keyset Query Optimization)
  Parse Statements

Recognize Unique Indexes
  Cancel as FreeStmt (Exp)

Use Declare/Fetch
  MyLog (C:\mylog\_xxxx.log)

Unknown Sizes

Maximum
  Don't Know
  Longest

Data Type Options

Text as LongVarChar
  Unknowns as LongVarChar
  Booleans as Char

Miscellaneous

Max Varchar: 1000000
 Max LongVarChar: 1024

Cache Size: 100
 SysTable Prefixes: dd\_

OK Cancel Apply Defaults

Page 1 Page 2

Read Only
  Row Versioning

Show System Tables
  Disallow Premature

LF <-> CR/LF conversion
  True is -1

Updatable Cursors
  Server side prepare

bytea as LO

Int8 As

default
  bigint
  numeric
  varchar
  double
  int4

Extra Opts  
0x0

Protocol

7.4+
  6.4+
  6.3
  6.2

Level of rollback on errors

Nop
  Transaction
  Statement

OID Options

Show Column
  Fake Index

Connect Settings:

OK Cancel Apply

**Note:**

On Page 2, For PostgreSQL version 8+ select the **Disallow Premature** checkbox and, in the **Protocol** panel, select the **7.4+** radio button.

- Click on the **OK** button to complete the configuration.



Your PostgreSQL connection is now available to use in Enterprise Architect.

### 3.3.2.3 ASA ODBC Driver

Before you can connect to an Adaptive Server Anywhere (ASA) data repository, you must first set up an ASA ODBC driver. To do this, you must have Microsoft MDAC components, the ASA DBMS system and the ASA ODBC driver (installed with the ASA DBMS) installed.

To set up your ASA ODBC Driver, follow the steps below:

1. Select the Windows™ **Control Panel | Administrative Tools | Data Sources (ODBC)** option. The **ODBC Data Sources Administrator** window displays.

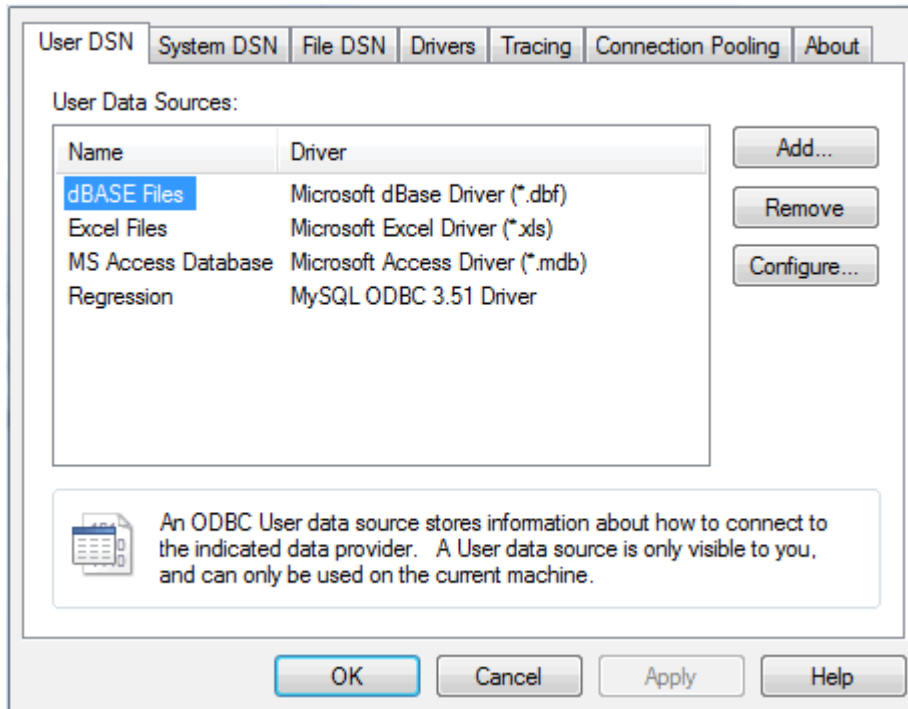

2. Click on the **Add** button. The **Create New Data Source** dialog displays, enabling you to add a new DSN.

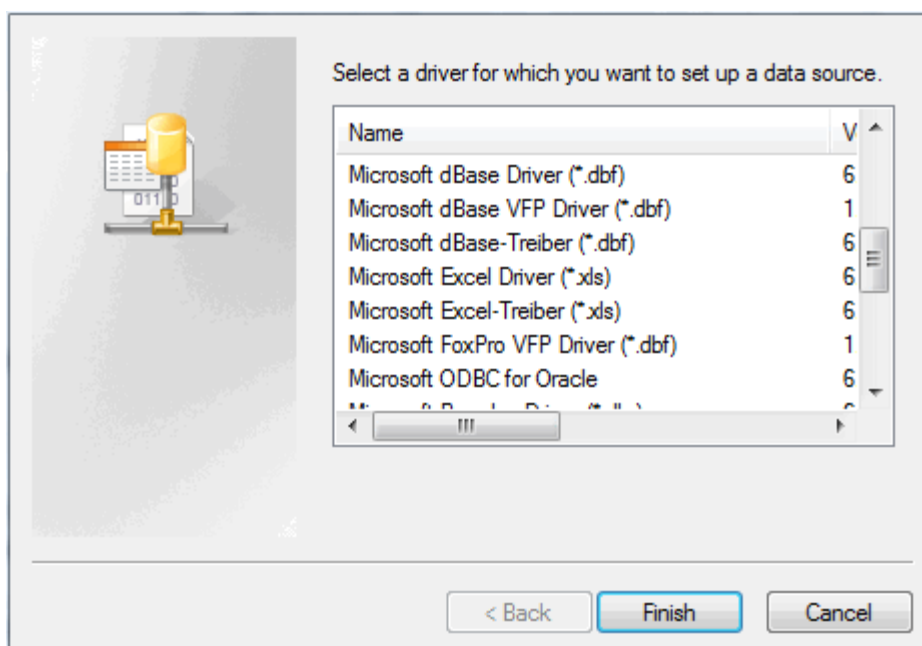

3. Select **Adaptive Server Anywhere** or **SQL Anywhere** from the list.
4. Click on the **Finish** button.
5. Enter the following configuration details:
  - A name for the connection on the **ODBC** tab.

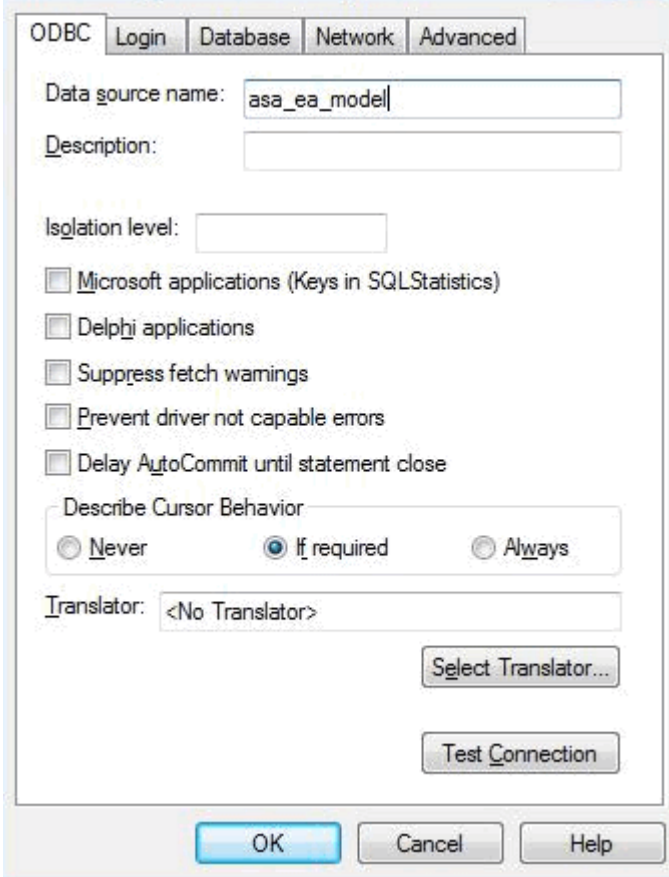

The screenshot shows the ODBC configuration dialog box with the 'Advanced' tab selected. The 'Data source name' field contains 'asa\_ea\_model'. The 'Description' field is empty. The 'Isolation level' field is empty. There are several unchecked checkboxes: 'Microsoft applications (Keys in SQLStatistics)', 'Delphi applications', 'Suppress fetch warnings', 'Prevent driver not capable errors', and 'Delay AutoCommit until statement close'. Under 'Describe Cursor Behavior', the 'If required' radio button is selected. The 'Translator' field contains '<No Translator>'. There are buttons for 'Select Translator...', 'Test Connection', 'OK', 'Cancel', and 'Help'.

- The username and password on the **Login** tab (**dba**, **sql** are the defaults when ASA is installed).

The screenshot shows the ODBC Login dialog box with the following configuration:

- Tab: Login
- Radio buttons:
  - Use integrated login
  - Supply user ID and password
- User ID: dba
- Password: ●●●
- Encrypt password
- Buttons: OK, Cancel, Help

- The server name and the path to the database, on the **Database** tab.

The image shows a screenshot of the ODBC configuration dialog box, specifically the 'Database' tab. The dialog has five tabs: 'ODBC', 'Login', 'Database', 'Network', and 'Advanced'. The 'Database' tab is selected. The fields are as follows:

- Server name:** asa\_server
- Start line:** (empty)
- Database name:** ea
- Database file:** (empty) with a 'Browse...' button to its right.
- Encryption key:** (empty)
- Start database automatically
- Stop database after last disconnect

At the bottom of the dialog are three buttons: 'OK', 'Cancel', and 'Help'.

- The network protocol on the **Network** tab (if the database is on a network location).

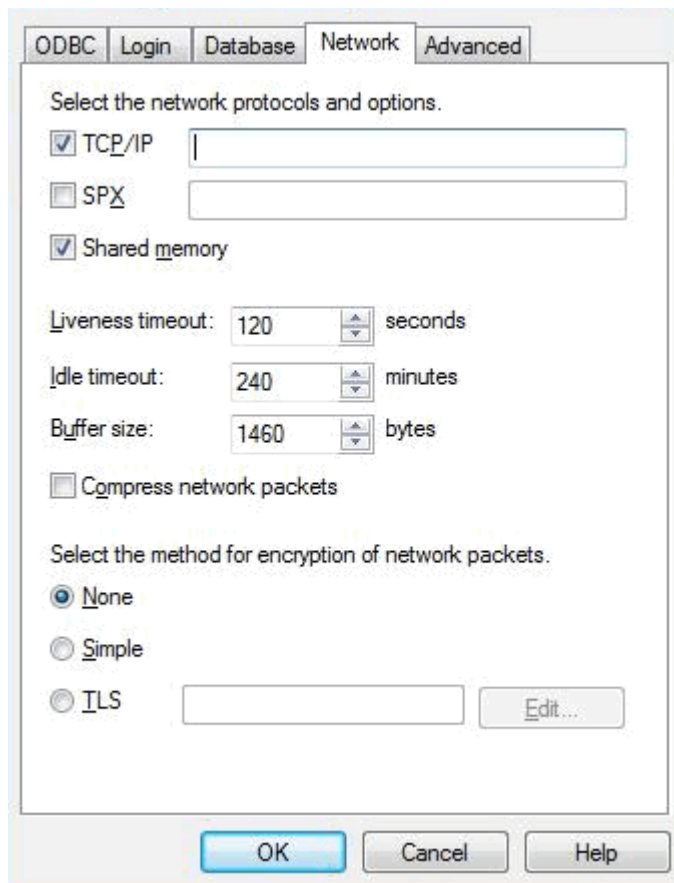

6. You can now return to the **ODBC** tab and test the connection.
  7. Click on the **OK** button to complete the configuration.
- Your Adaptive Server Anywhere connection is now available to use in Enterprise Architect.

### 3.3.2.4 Progress OpenEdge ODBC Driver

Before you can connect to an OpenEdge data repository, you must first set up an OpenEdge ODBC driver. To do this, you must have Microsoft MDAC components, OpenEdge DBMS system and DataDirect ODBC driver for OpenEdge (version 4.20 minimum) installed.

To set up the ODBC Driver, follow the steps below:

1. Select the Windows™ **Control Panel | Administrative Tools | Data Sources (ODBC)** option. The **ODBC Data Sources Administrator** window displays.

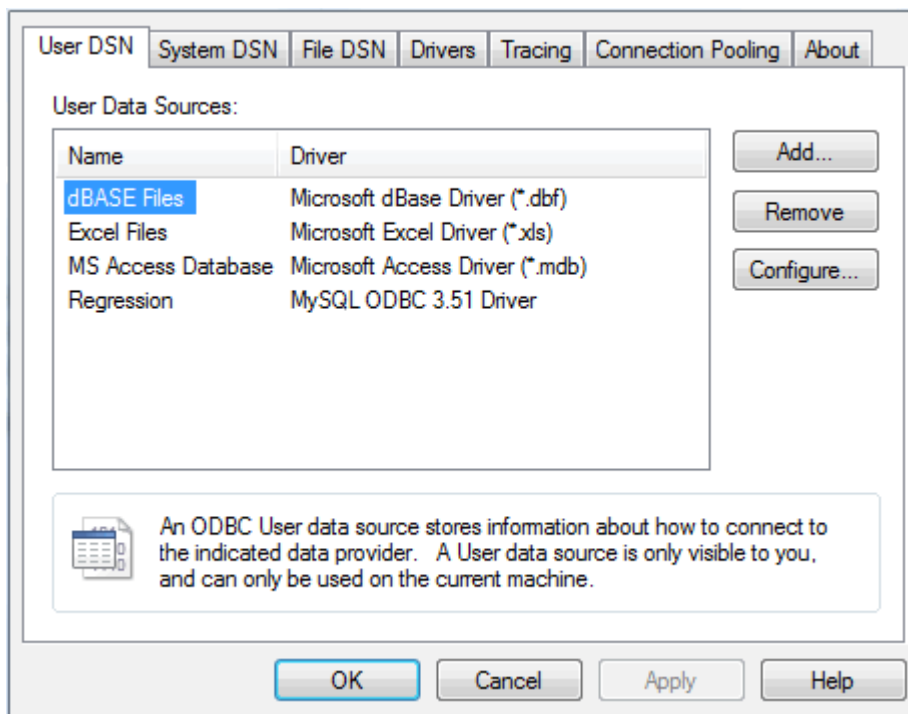

- Click on the **Add** button. The **Create New Data Source** dialog displays, enabling you to add a new DSN.

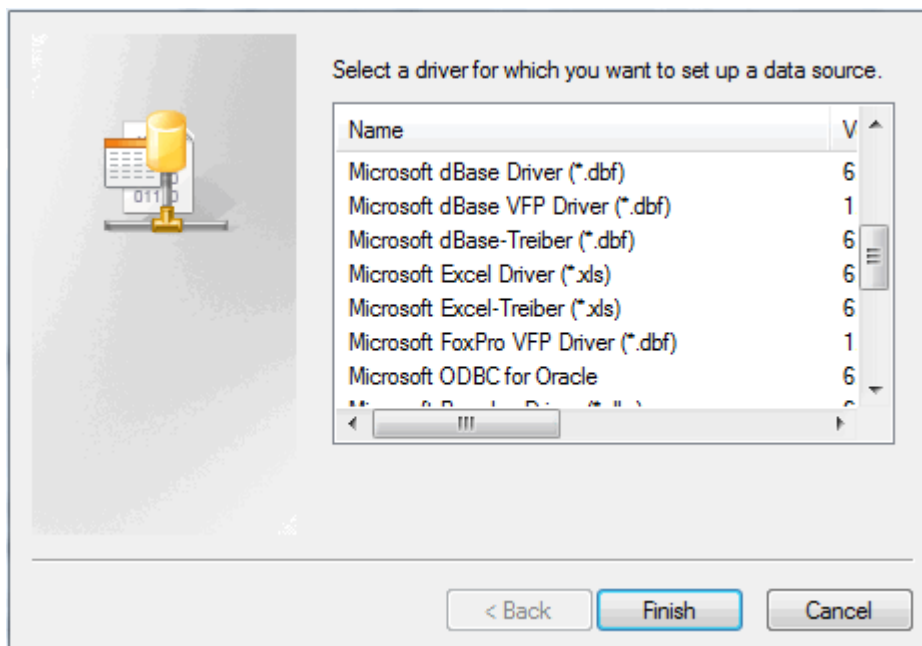

- Select the **DataDirect/OpenEdge SQL** driver from the list.
  - Click on the **Finish** button. The **DSN Configuration** dialog displays.
  - Enter the following configuration details:
    - The **Data Source Name**
    - The **Description** (optional)
    - The **Host Name** and **Port Number** of the DBMS server
    - The **Database Name** on the selected server
    - The **User ID**.
- See the example below:

The image shows a 'General' tab configuration window for a database connection. The fields are as follows:

Field	Value
Data Source Name:	openedge_ea
Description:	
Host Name:	dbserver02
Port Number:	20932
Database Name:	ea1
User ID:	oe_user

Buttons: Test Connect, OK, Cancel, Apply, Help.

6. Click on the **Test Connect** button to confirm that the details are correct.
  7. If the test succeeds, click on the **OK** button to complete the configuration.
  8. If the test does not succeed, review your settings.
- Your OpenEdge connection is now available to use in Enterprise Architect.

### 3.3.3 Connect to a Data Repository

This topic describes how to connect to a range of data repositories, to access an existing Enterprise Architect mode.

In Enterprise Architect you connect to a data repository for one of two reasons:

- To access an existing Enterprise Architect model in the repository
- [To reverse engineer a database schema into a model using ODBC](#) <sup>[1363]</sup>.

#### Note:

To connect to a repository, you must have the usual SELECT, UPDATE, INSERT and DELETE permissions.

For information on how to connect to your database repository, click on the appropriate link below:

- [MySQL Data Repository](#) <sup>[148]</sup>
- [SQL Server Data Repository](#) <sup>[150]</sup>
- [Oracle Data Repository](#) <sup>[153]</sup>
- [PostgreSQL Data Repository](#) <sup>[160]</sup>
- [Adaptive Server Anywhere Data Repository](#) <sup>[162]</sup>
- [MSDE Server Data Repository](#) <sup>[165]</sup>
- [Progress OpenEdge](#) <sup>[165]</sup>.

### 3.3.3.1 MySQL Data Repository

**Note:**

This feature is available in the Corporate, Business and Software Engineering, System Engineering and Ultimate editions.

In order to use a MySQL data repository, you must connect to it in Enterprise Architect first. Before connecting to the repository, you must [set up a MySQL ODBC driver](#)<sup>[135]</sup>.

To connect to a MySQL data repository in Enterprise Architect, follow the steps below:

1. In the [Open Project](#)<sup>[114]</sup> dialog, select the **Connect to Server** checkbox.
2. Click on the [ ... ] (Browse) button, as you normally would to browse for a project. As you have selected the **Connect to Server** checkbox, the **Data Link Properties** dialog displays instead of the **Browse Directories** dialog.

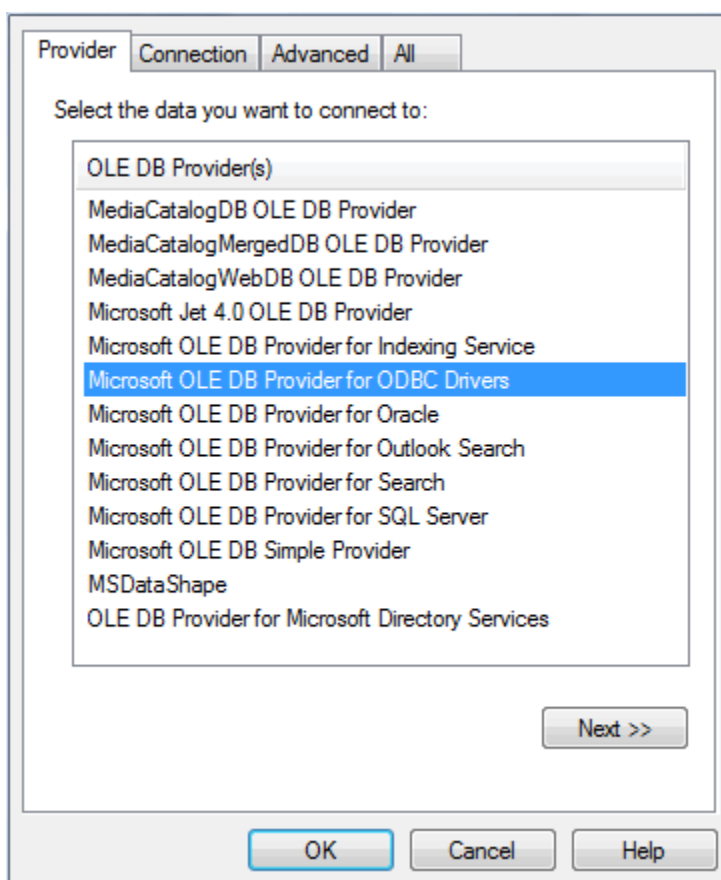

3. Select **Microsoft OLE DB Provider for ODBC Drivers** from the list.
4. Click on the **Next** button. The **Connection** tab displays.



The screenshot shows the 'Connection' tab of the ODBC Data Source Administrator dialog box. The dialog is titled 'Specify the following to connect to ODBC data:' and is divided into three sections:

- 1. Specify the source of data:**
  - Use data source name**: A drop-down menu is empty, and a 'Refresh' button is to its right.
  - Use connection string**: A 'Connection string:' label is above an empty text box, with a 'Build...' button to its right.
- 2. Enter information to log on to the server**
  - 'User name:' label above an empty text box.
  - 'Password:' label above an empty text box.
  - Two checkboxes:  **Blank password** and  **Allow saving password**.
- 3. Enter the initial catalog to use:**
  - An empty drop-down menu.
  - A 'Test Connection' button below the menu.

At the bottom of the dialog are three buttons: 'OK', 'Cancel', and 'Help'.

5. Click on the **Use data source name** radio button and on the drop-down arrow in its field. Select the ODBC driver you have set up to connect to your MySQL repository from the list. In the [setup example](#) <sup>[138]</sup> the driver title is **Changes**.
6. If required, type in a **User name** and **Password**.
7. If required, type in an initial catalog.
8. Click on the **Test Connection** button to confirm that the details are correct.
9. If the test succeeds, click on the **OK** button.
10. If the test does not succeed, revise your settings.
11. After you have clicked on the **OK** button, the **Connection Name & Type** dialog displays.

12. Give the connection a suitable name so that you can recognize it in the **Recent Projects** panel on the **Open Project** dialog.
13. If required, select the **Encrypt Connection String** checkbox. This encrypts and hides the connection details of the database from the users that the connection string is given to.
14. If required, select the **Lazy Load** checkbox to not load the full project view when the model is loaded. Instead, only the parts that are necessary to display the visible portion of the tree are loaded. This means that a model loads faster and users can begin work sooner, but at the expense of later small delays as Enterprise Architect loads specific portions of the model.
15. If required, select the **Use WAN Optimization** <sup>[180]</sup> checkbox. (To improve performance over a Wide Area Network, remote database calls can be routed through a WAN Optimizer that compresses the data returned from the repository, reducing transfer time.)  
  
If you select this checkbox, complete the next three fields (see your administrator for the correct values). Otherwise go to step 19.
16. In the **Server** field, type the network name or address of the optimizer server.
17. In the **Port** field, type the port on which the server is running on the remote machine.
18. In the **DSN** field, type the data source name of the database as it appears on the remote machine.
19. Click on the **OK** button to complete the configuration.

### 3.3.3.2 SQL Server Data Repository

#### Note:

This feature is available in the Corporate, Business and Software Engineering, System Engineering and Ultimate editions.

Before you can use a SQL Server data repository, you must connect to it in Enterprise Architect. To connect to your SQL Server data repository in Enterprise Architect, follow the steps below:

1. In the **Open Project dialog** <sup>[114]</sup>, select the **Connect to Server** checkbox.
2. Click on the [ ... ] (Browse) button, as you normally would to browse for a project. As you have selected the **Connect to Server** checkbox, the **Data Link Properties** dialog displays instead of the **Select Enterprise Architect Project to Open** dialog.

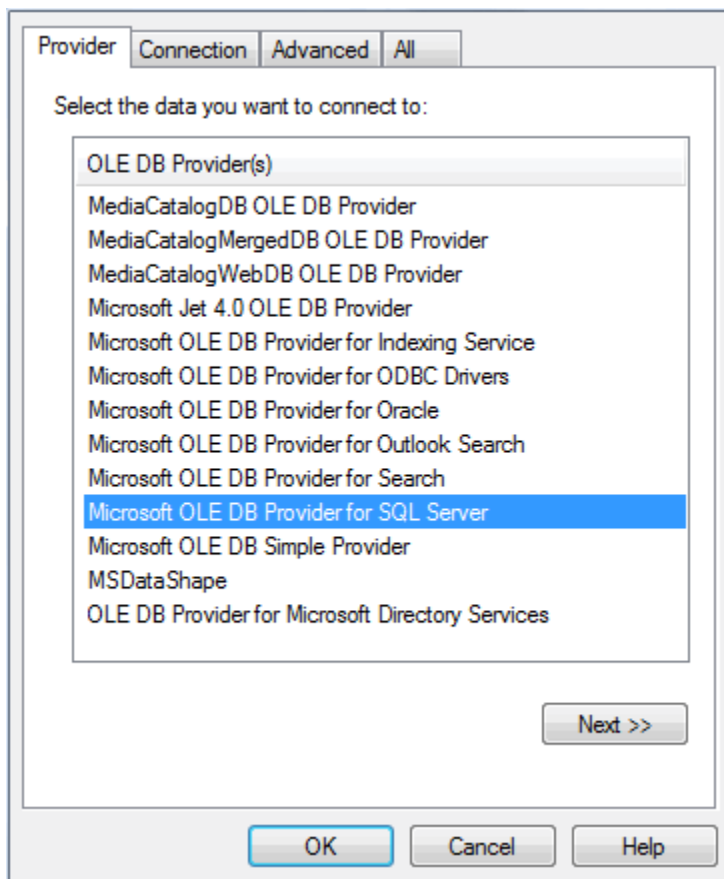

3. Select **Microsoft OLE DB Provider for SQL Server** from the list.
4. Click on the **Next>>** button. The **Connection** tab displays.

Specify the following to connect to SQL Server data:

1. Select or enter a server name:  
sparx Refresh
2. Enter information to log on to the server:  
 Use Windows NT Integrated security  
 Use a specific user name and password:  
User name: sa  
Password:  
 Blank password  Allow saving password
3.  Select the database on the server:  
|  
 Attach a database file as a database name:  
Using the filename: ...  
Test Connection

OK Cancel Help

5. Type in the server details, including **Server Name**, **User Name** and **Password**.
6. Click on the **Select the database on the server** option and on the drop-down arrow. From the list, select the model to connect to.
7. Click on the **Test Connection** button to confirm that the details are correct.
8. If the test succeeds, click on the **OK** button. If the test does not succeed, revise your settings.
9. When you click on the **OK** button, the **Connection Name & Type** dialog displays.

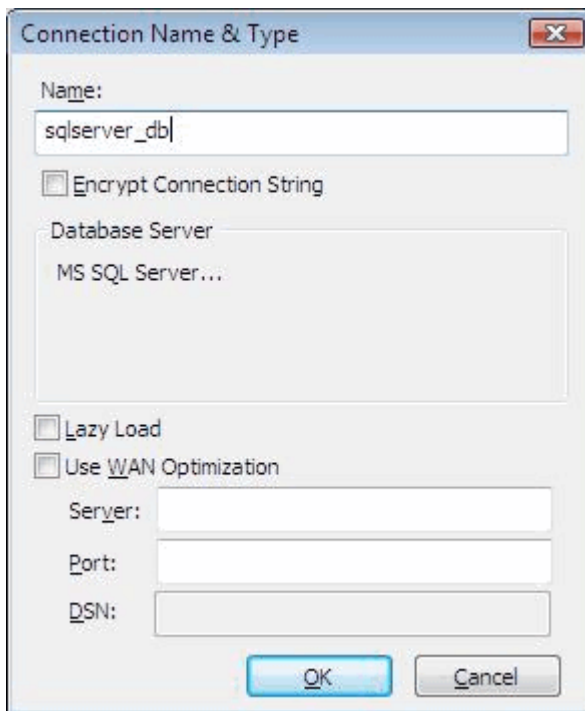

10. In the **Name** field, type a suitable name for the connection so that you can recognize it in the **Recent Projects** panel on the **Open Project** dialog.
11. If required, select the **Encrypt Connection String** checkbox. This encrypts and hides the connection details of the database from the users that the connection string is given to.
12. If required, select the **Lazy Load** checkbox to not load the full project view when the model is loaded. Instead, only the parts that are necessary to display the visible portion of the tree are loaded. This means that a model loads faster and users can begin work sooner, but at the expense of later small delays as Enterprise Architect loads specific portions of the model.
13. If required, select the **Use WAN Optimization** checkbox. (To improve performance over a Wide Area Network, remote database calls can be routed through a WAN Optimizer that compresses the data returned from the repository, reducing transfer time.)

If you select this checkbox, complete the next two fields (see your administrator for the correct values). Otherwise go to step 16.

14. In the **Server** field, type the network name or address of the optimizer server.
15. In the **Port** field, type the port on which the server is running on the remote machine.
16. Click on the **OK** button to complete the configuration.

### 3.3.3.3 Oracle Data Repository

#### Note:

This feature is available in the Corporate, Business and Software Engineering, System Engineering and Ultimate editions.

In order to use an Oracle 9i, 10g or 11g data repository, you must connect to it in Enterprise Architect first. You can connect using either [OLE DB](#) or [ODBC](#).

#### Using Oracle OLE DB Provider

To connect to your Oracle data repository using the Oracle OLE DB Provider, follow the steps below:

1. In the **Open Project dialog**, select the **Connect to Server** checkbox.
2. Click on the [ ... ] (Browse) button, as you normally would to browse for a project. As you have selected the **Connect to Server** checkbox, the **Data Link Properties** dialog displays instead of the **Browse Directories** dialog.

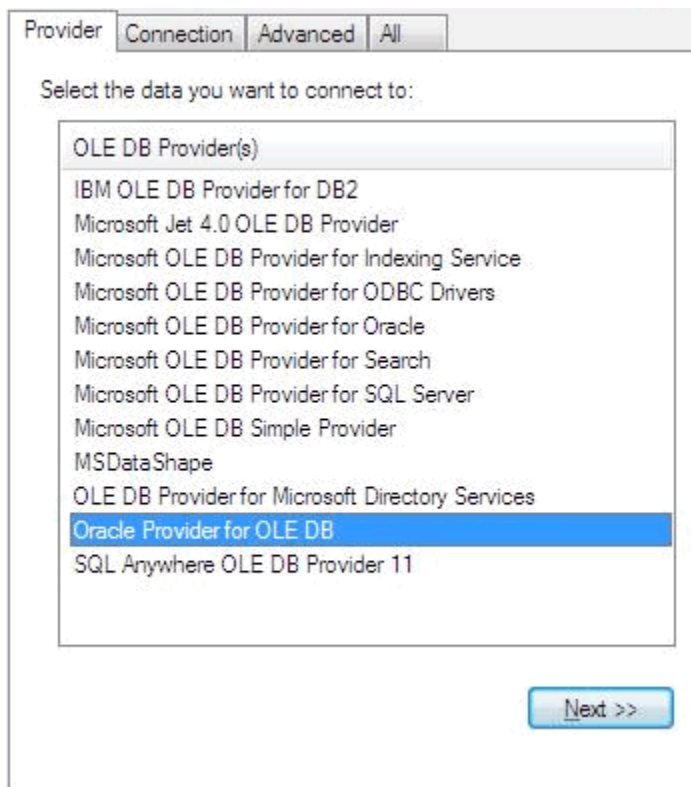

3. Select **Oracle Provider for OLE DB** from the list.

**Note:**

Do *not* select **Microsoft OLE DB Provider for Oracle**; Enterprise Architect might not work as expected.

4. Click on the **Next** button. The **Connection** tab displays.

Specify the following to connect to this data:

1. Enter the data source and/or location of the data:  
Data Source: ORA10  
Location:
2. Enter information to log on to the server:  
 Use Windows NT Integrated security  
 Use a specific user name and password:  
User name: EA\_USER  
Password:   
 Blank password  Allow saving password
3. Enter the initial catalog to use:

Test Connection

OK Cancel Help

5. Enter the **Data Source** name (the service name of the Oracle database), the database **User Name** and the **Password**. The **Location** field is not required.
6. Click on the **Test Connection** button to confirm that the details are correct.
7. If your test succeeded, click on the **OK** button.
8. If your test did not succeed, revise your settings.
9. After you have clicked on the **OK** button, the **Connection Name and Type** dialog displays.

Name: ea user

Encrypt Connection String

Database Server  
Oracle...

Lazy Load  
 Use WAN Optimization

Server:   
Port:   
DSN:

OK Cancel

10. Give the connection a suitable name so that you can recognize it in the **Recent Projects** panel on the **Open Project** dialog.
11. If required, select the **Encrypt Connection String** checkbox. This encrypts and hides the connection details of the database from the users that the connection string is given to.
12. If required, select the **Lazy Load** checkbox to not load the full project view when the model is loaded. Instead, only the parts that are necessary to display the visible portion of the tree are loaded. This means that a model loads faster and users can begin work sooner, but at the expense of later small delays as Enterprise Architect loads specific portions of the model.
13. If required, select the **Use WAN Optimization** <sup>[180]</sup> checkbox. (To improve performance over a Wide Area Network, remote database calls can be routed through a WAN Optimizer that compresses the data returned from the repository, reducing transfer time.)

If you select this checkbox, complete the next two fields (see your administrator for the correct values). Otherwise go to step 16.

14. In the **Server** field, type the network name or address of the optimizer server.
15. In the **Port** field, type the port on which the server is running on the remote machine.
16. Click on the **OK** button to complete the configuration.

### Using Oracle ODBC Driver

This process has two stages:

- Create ODBC Driver connection in Windows
- Connect to Repository in Enterprise Architect.

#### Create ODBC Driver Connection

1. Select the Windows™ **Control Panel | Administrative Tools | Data Sources (ODBC)** option. The **ODBC Data Source Administrator** window displays.

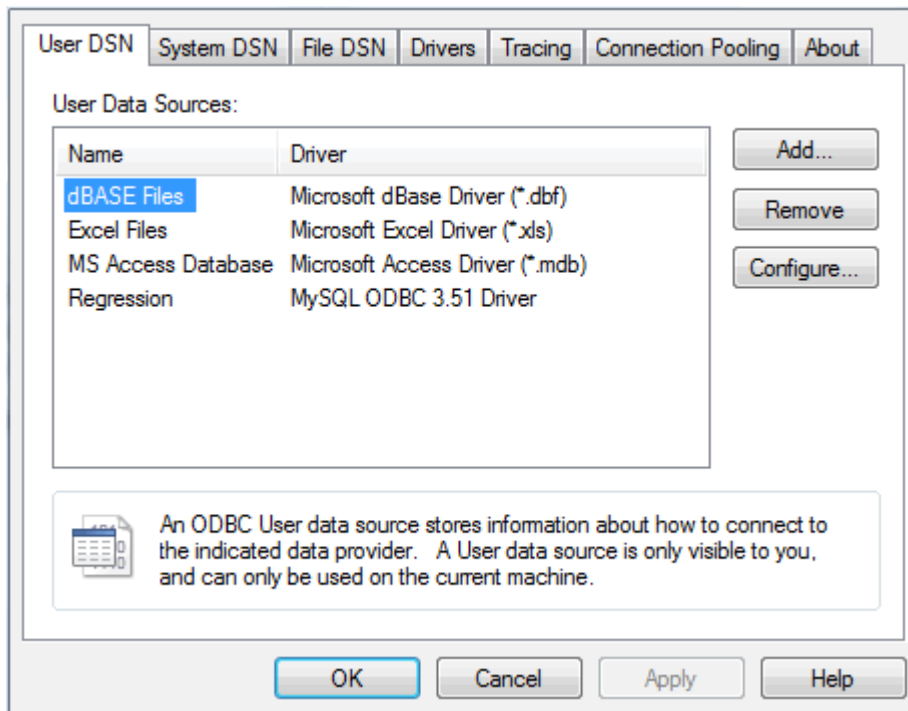

2. Click on the **Add** button. The **Create New Data Source** dialog displays, enabling you to add a new DSN.



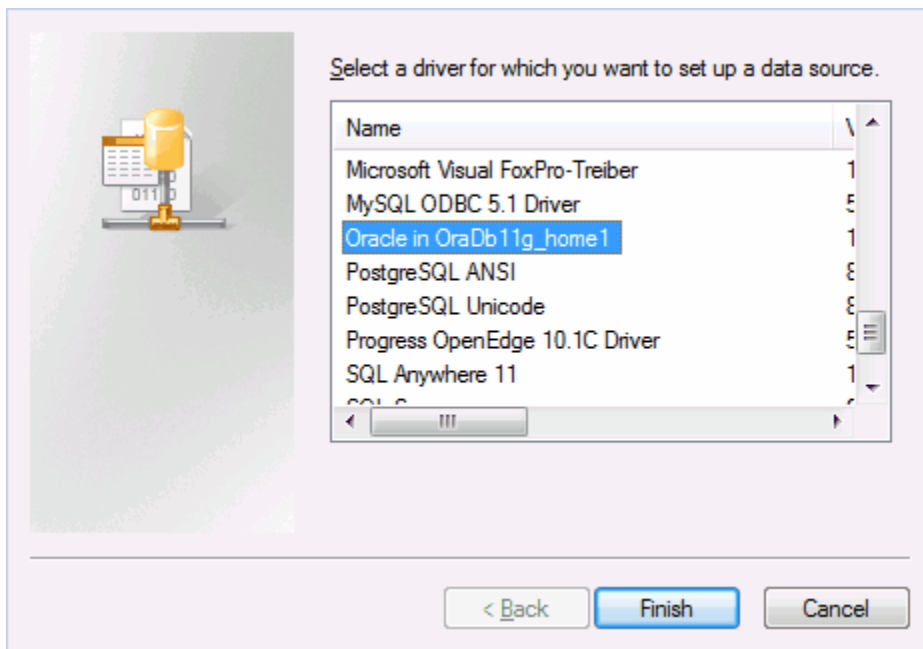

3. Select **Oracle in OraDB11g\_home1** (or similar, depending on the ODBC installation).
4. Click on the **Finish** button. The **Oracle ODBC Driver Configuration** dialog displays.

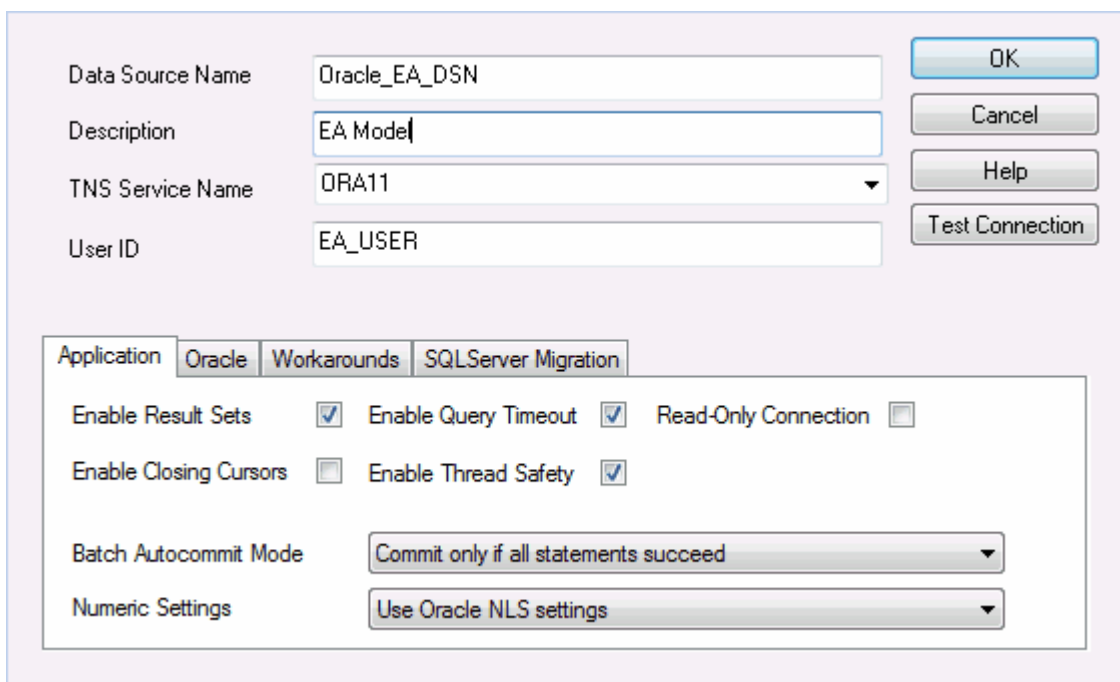

5. Enter the following configuration details:
  - A data source name for the connection
  - A description (optional)
  - The TNS Service Name (click on the drop-down arrow and select from the list)
  - The User ID.
6. Click on the **Test Connection** button and enter the Oracle user password to confirm that the details are correct.
7. Click on the **OK** button to complete the ODBC connection.

### Connect To Repository

1. In Enterprise Architect, select the **File | Open Project** menu option. The **Open Project** dialog displays.

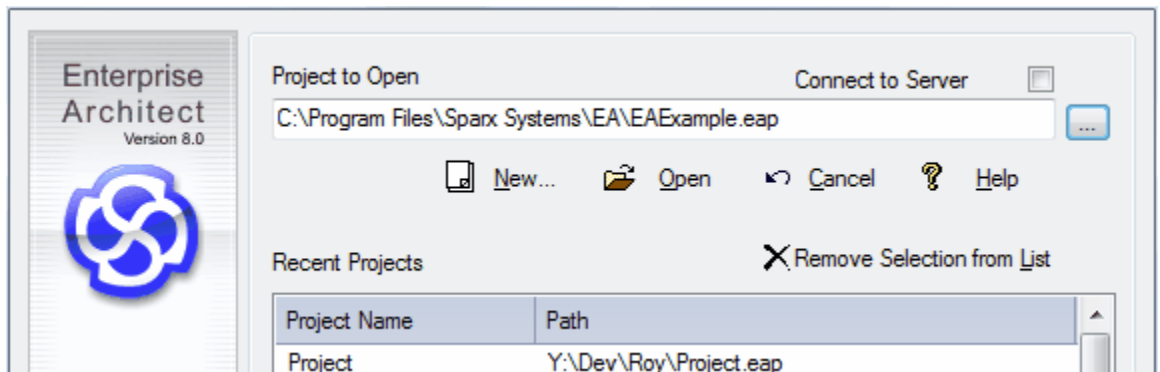

2. Select the **Connect to Server** checkbox.
3. Click on the [ ... ] (Browse) button, as you normally would to browse for a project. As you have selected the **Connect to Server** checkbox, the **Data Link Properties** dialog displays instead of the **Browse Directories** dialog.

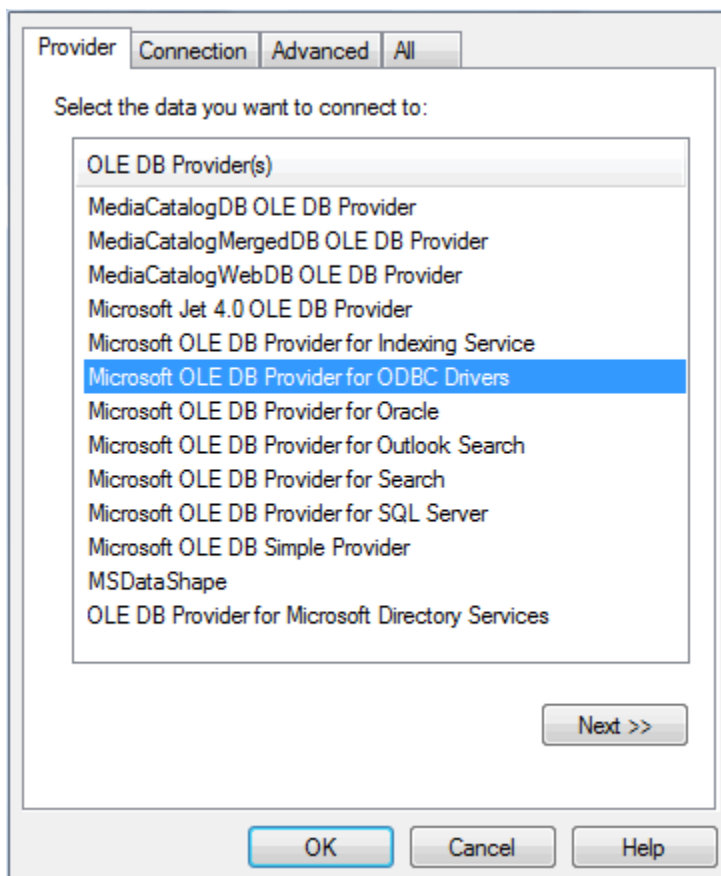

4. Select **Microsoft OLE DB Provider for ODBC Drivers** from the list.
5. Click on the **Next** button. The **Connection** tab displays.

The screenshot shows the 'Connection' tab of the ODBC Data Source Administrator. It contains three sections for configuring the connection:

- 1. Specify the source of data:** The 'Use data source name' radio button is selected. The dropdown menu shows 'Oracle\_EA\_DSN' and a 'Refresh' button is next to it. The 'Use connection string' radio button is unselected, with a 'Connection string:' text box and a 'Build...' button below it.
- 2. Enter information to log on to the server:** The 'User name:' text box contains 'EA\_USER'. The 'Password:' text box contains ten dots. There are two checkboxes: 'Blank password' (unchecked) and 'Allow saving password' (checked).
- 3. Enter the initial catalog to use:** An empty dropdown menu.

A 'Test Connection' button is located at the bottom right of the dialog.

6. Select the **Data Source** name from the drop-down list, and type in the database **User Name** and **Password**.
7. Click on the **Test Connection** button to confirm that the details are correct.
8. If your test succeeded, click on the **OK** button; if your test did not succeed, revise your settings.
9. After you have clicked on the **OK** button, Oracle prompts you for the password. Enter this. The **Connection Name and Type** dialog displays.

The screenshot shows the 'Connection Name and Type' dialog box. It has the following fields and options:

- Name:** A text box containing 'ea user'.
- Encrypt Connection String**
- Database Server:** A list box showing 'Oracle...'. Below it are fields for **Server:**, **Port:**, and **DSN:**, all of which are currently empty.
- Lazy Load**
- Use WAN Optimization**

At the bottom, there are 'OK' and 'Cancel' buttons.

10. Give the connection a suitable name so that you can recognize it in the **Recent Projects** panel on the [Open Project dialog](#)<sup>[114]</sup>.
11. If required, select the **Encrypt Connection String** checkbox. This encrypts and hides the connection

details of the database from the users that the connection string is given to.

12. If required, select the **Lazy Load** checkbox to not load the full project view when the model is loaded. Instead, only the parts that are necessary to display the visible portion of the tree are loaded. This means that a model loads faster and users can begin work sooner, but at the expense of later small delays as Enterprise Architect loads specific portions of the model.
13. If required, select the **Use WAN Optimization** <sup>[180]</sup> checkbox. (To improve performance over a Wide Area Network, remote database calls can be routed through a WAN Optimizer that compresses the data returned from the repository, reducing transfer time.)

If you select this checkbox, complete the next two fields (see your administrator for the correct values). Otherwise go to step 16.

14. In the **Server** field, type the network name or address of the optimizer server.
15. In the **Port** field, type the port on which the server is running on the remote machine.
16. Click on the **OK** button to complete the configuration.

### 3.3.3.4 PostgreSQL Data Repository

#### Note:

This feature is available in the Corporate, Business and Software Engineering, System Engineering and Ultimate editions.

In order to use a PostgreSQL data repository, you must connect to it in Enterprise Architect first. Before connecting to the repository, you must have [set up a PostgreSQL ODBC driver](#) <sup>[138]</sup>. To connect to a PostgreSQL data repository in Enterprise Architect, follow the steps below:

1. In the [Open Project dialog](#) <sup>[114]</sup>, select the **Connect to Server** checkbox, or on the **Start Page**, click on the **Connect to Server** link.
2. Click on the [ ... ] (Browse) button, as you normally would to browse for a project. As you have selected the **Connect to Server** checkbox, the **Data Link Properties** dialog displays instead of the **Browse Directories** dialog.

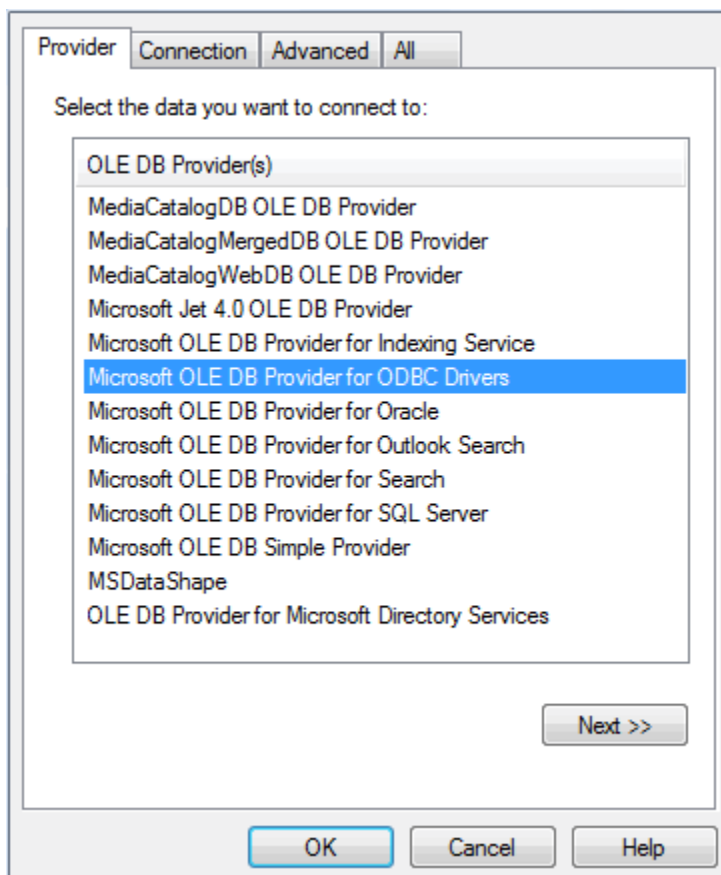

3. Select **Microsoft OLE DB Provider for ODBC Drivers** from the list.
4. Click on the **Next** button. The **Connection** tab displays.

Specify the following to connect to ODBC data:

1. Specify the source of data:
  - Use data source name
    - pg\_base
    - Refresh
  - Use connection string
    - Connection string:
    - Build...
2. Enter information to log on to the server
  - User name:
  - Password:
  - Blank password  Allow saving password
3. Enter the initial catalog to use:

Test Connection

OK Cancel Help

5. Click on the **Use data source name** drop-down arrow and, from the list, select the ODBC driver you have set up to connect to your PostgreSQL repository.
6. Click on the **Test Connection** button to confirm that the details are correct.
7. If your test succeeded, click on the **OK** button.
8. If your test did not succeed, revise your settings.
9. After you have clicked on the **OK** button, the **Connection Name & Type** dialog displays.

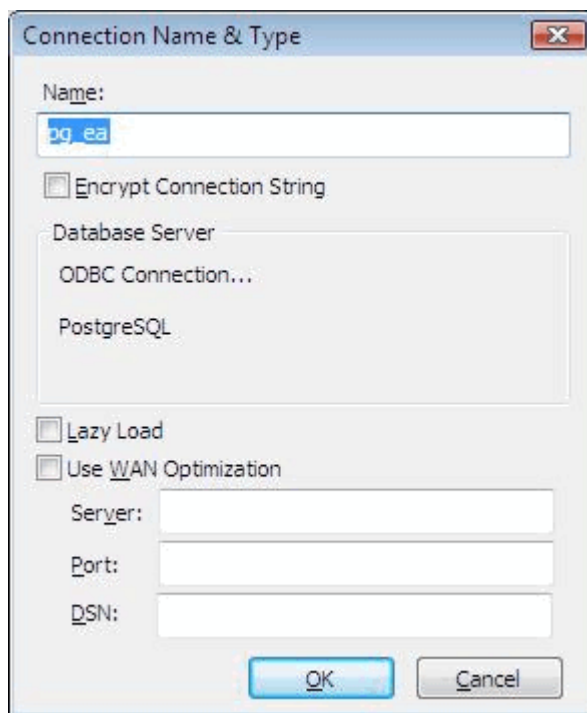

10. Give the connection a suitable name so that you can recognize it in the **Recent Projects** panel on the **Open Project** dialog.
11. If required, select the **Encrypt Connection String** checkbox. This encrypts and hides the connection details of the database from the users that the connection string is given to.
12. If required, select the **Lazy Load** checkbox to not load the full project view when the model is loaded. Instead, only the parts that are necessary to display the visible portion of the tree are loaded. This means that a model loads faster and users can begin work sooner, but at the expense of later small delays as Enterprise Architect loads specific portions of the model.
13. If required, select the **Use WAN Optimization** checkbox. (To improve performance over a Wide Area Network, remote database calls can be routed through a WAN Optimizer that compresses the data returned from the repository, reducing transfer time.)

If you select this checkbox, complete the next three fields (see your administrator for the correct values). Otherwise go to step 17.

14. In the **Server** field, type the network name or address of the optimizer server.
15. In the **Port** field, type the port on which the server is running on the remote machine.
16. In the **DSN** field, type the data source name of the database as it appears on the remote machine.
17. Click on the **OK** button to complete the configuration.

### 3.3.3.5 ASA Data Repository

#### Note:

This feature is available in the Corporate, Business and Software Engineering, System Engineering and Ultimate editions.

In order to use an ASA data repository, you must connect to it in Enterprise Architect first. Before connecting to the repository, you must have [set up an ASA ODBC driver](#). To connect to an ASA data repository in Enterprise Architect, follow the steps below:

1. In the **Open Project** dialog, select the **Connect to Server** checkbox or, on the **Start Page**, click on the **Connect to Server** link.
2. Click on the [ ... ] (Browse) button, as you normally would to browse for a project. As you have selected the **Connect to Server** checkbox, the **Data Link Properties** dialog displays instead of the browse directories dialog.

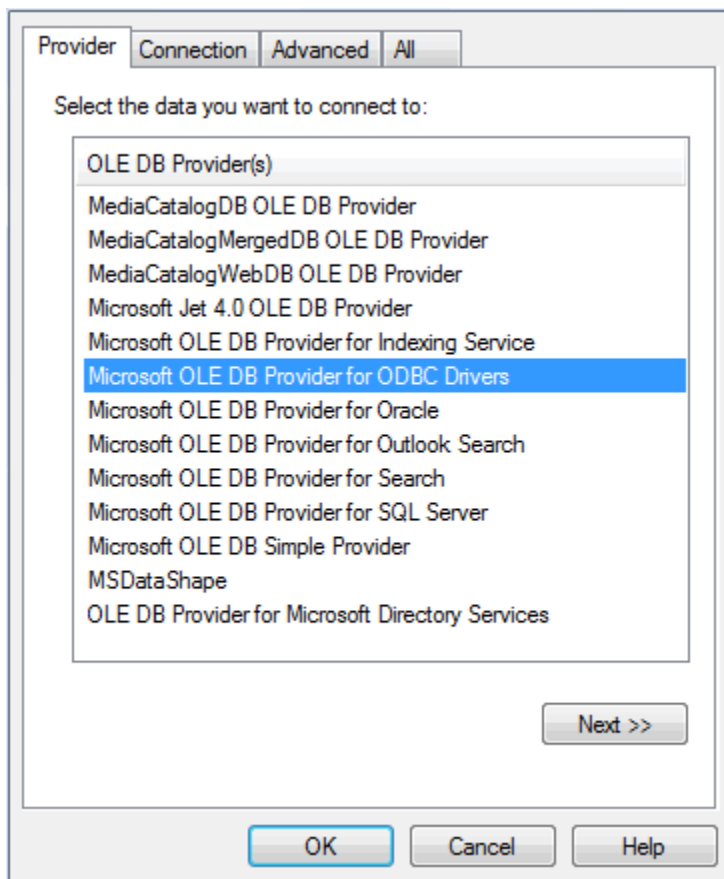

3. Select **Microsoft OLE DB Provider for ODBC Drivers** from the list.
4. Click on the **Next** button. The **Connection** tab displays.

The image shows a dialog box titled "Provider" with tabs for "Connection", "Advanced", and "All". The "Connection" tab is active. The dialog contains the following sections:

- Specify the following to connect to ODBC data:**
  - 1. Specify the source of data:**
    - Use data source name**: A dropdown menu shows "asa\_base" with a "Refresh" button to its right.
    - Use connection string**: A "Connection string:" label above an empty text box and a "Build..." button to its right.
  - 2. Enter information to log on to the server**
    - "User name:" label above an empty text box.
    - "Password:" label above an empty text box.
    - Blank password** and  **Allow saving password** (checkboxes).
  - 3. Enter the initial catalog to use:** An empty dropdown menu.

At the bottom of the dialog are three buttons: "OK", "Cancel", and "Help". A "Test Connection" button is located at the bottom right of the main content area.

5. In the **Use data source name** field, click on the drop-down arrow and select the ODBC driver you set up to connect to your ASA repository.
6. Click on the **Test Connection** button to confirm that the details are correct.
7. If your test succeeded, click on the **OK** button.
8. If your test did not succeed, revise your settings.
9. After you have clicked on the **OK** button, the **Connection Name & Type** dialog displays.



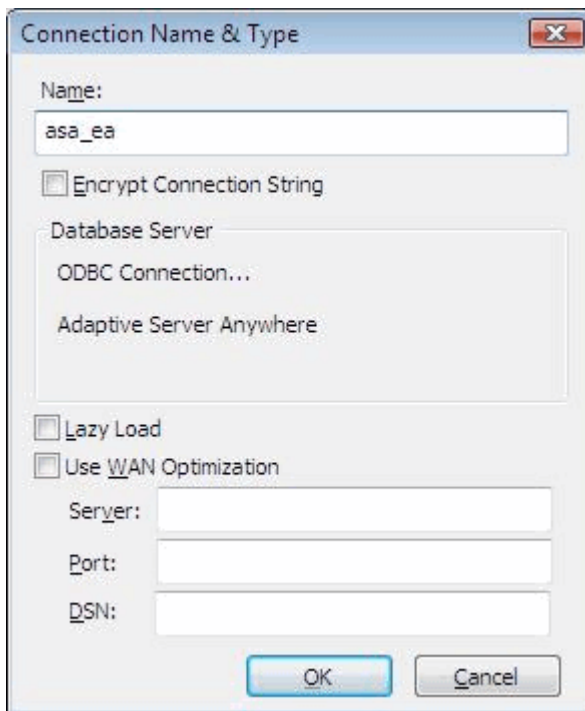

10. Give the connection a suitable name so you can recognize it in the **Recent Projects** panel on the **Open Project** dialog.
11. If required, select the **Encrypt Connection String** checkbox. This encrypts and hides the connection details of the database from the users that the connection string is given to.
12. If required, select the **Lazy Load** checkbox to not load the full project view when the model is loaded. Instead, only the parts that are necessary to display the visible portion of the tree are loaded. This means that a model loads faster and users can begin work sooner, but at the expense of later small delays as Enterprise Architect loads specific portions of the model.
13. If required, select the **Use WAN Optimization** <sup>[180]</sup> checkbox. (To improve performance over a Wide Area Network, remote database calls can be routed through a WAN Optimizer that compresses the data returned from the repository, reducing transfer time.)  
  
If you select this checkbox, complete the next three fields (see your administrator for the correct values). Otherwise go to step 17.
14. In the **Server** field, type the network name or address of the optimizer server.
15. In the **Port** field, type the port on which the server is running on the remote machine.
16. In the **DSN** field, type the data source name of the database as it appears on the remote machine.
17. Click on the **OK** button to complete the configuration.

### 3.3.3.6 MSDE Server Data Repository

Follow the steps in [Connect to an SQL Server Repository](#) <sup>[150]</sup>.

### 3.3.3.7 Progress OpenEdge Repository

#### Note:

This feature is available in the Corporate, Business and Software Engineering, System Engineering and Ultimate editions.

In order to use an OpenEdge data repository, you must connect to it in Enterprise Architect first; follow the steps below:

1. In the [Open Project dialog](#) <sup>[114]</sup>, select the **Connect to Server** checkbox.
2. Click on the [ ... ] (Browse) button, as you normally would to browse for a project. As you have selected **Connect to Server**, the **Data Link Properties** dialog displays instead of the **Browse Directories** dialog.

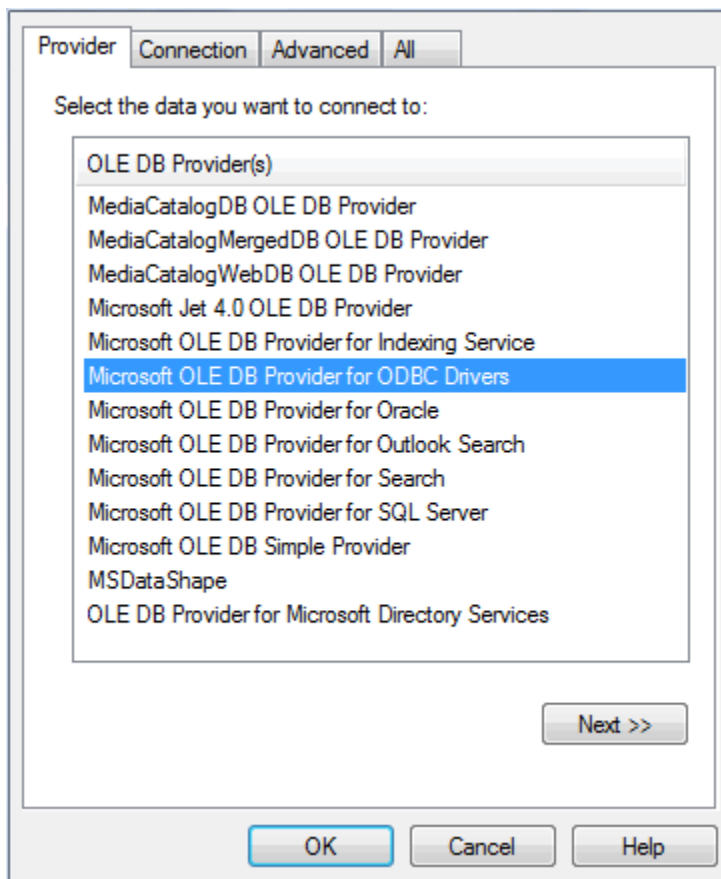

3. Select **Microsoft OLE DB Provider for ODBC Drivers** from the list.
4. Click on the **Next** button. The **Connection** tab displays.

5. In the **Use data source name** field, click on the drop-down arrow and select the ODBC driver you have set up to connect to your OpenEdge repository. In the [setup example](#)<sup>[145]</sup> the driver title is **openedge\_ea**.
6. Enter the **User name** and **Password**.
7. Enter the initial catalog.
8. Click on the **All** tab, and double-click on **Extended Properties**.
9. In the **Property Value** field, edit the value to: **DefaultSchema=PUB**.

10. Click on the **Connection** tab again, and click on the **Test Connection** button to confirm that the details are correct.
11. If the test succeeds, click on the **OK** button. If the test does not succeed, revise your settings.
12. After you have clicked on the **OK** button, the **Logon to Progress** dialog displays.

Host Name: dbserver02

Port Number: 20932

Database Name: ea1

User ID: oe\_user

Password: •••••

OK Cancel Help

13. Check the details, and click on the **OK** button. The **Connection Name & Type** dialog displays.

Name: oe\_ea

Encrypt Connection String

Database Server

ODBC Connection...

Progress OpenEdge

Lazy Load

Use WAN Optimization

Server:

Port:

DSN:

OK Cancel

14. Give the connection a suitable name so you can recognize it in the **Recent Projects** panel on the [Open Project dialog](#) <sup>(114)</sup>.
15. If required, select the **Encrypt Connection String** checkbox. This encrypts and hides the connection details of the database from the users that the connection string is given to.
16. If required, select the **Lazy Load** checkbox to not load the full project view when the model is loaded. Instead, only the parts that are necessary to display the visible portion of the tree are loaded. This means that a model loads faster and users can begin work sooner, but at the expense of later small delays as Enterprise Architect loads specific portions of the model.
17. If required, select the **Use WAN Optimization** <sup>(180)</sup> checkbox. (To improve performance over a Wide Area Network, remote database calls can be routed through a WAN Optimizer that compresses the data returned from the repository, reducing transfer time.)

If you select this checkbox, complete the next three fields (see your administrator for the correct values). Otherwise go to step 21.

18. In the **Server** field, type the network name or address of the optimizer server.
19. In the **Port** field, type the port on which the server is running on the remote machine.
20. In the **DSN** field, type the data source name of the database as it appears on the remote machine.
21. Click on the **OK** button to complete the configuration.

### 3.3.4 Upsize to Access 2007

Before you set up Enterprise Architect for use with Access 2007, it is recommended that you run the [project integrity check tool](#)<sup>[344]</sup> (select the **Tools | Data Management | Project Integrity Check** menu option) on the base project to upsize to Access 2007. This ensures the project data is 'clean' before uploading.

**Note:**

You cannot move a model from a source .EAP file of a version earlier than 3.5.0.

#### Upsizing your Database

You upsize your database in two stages, as follows:

##### Stage One: Create the Repository

Using Access 2007, open a .EAP file and allow Access to convert it to a .ACCDB file. This forms the Access 2007 repository.

**Note:**

If you do not have Access 2007, you can connect by downloading the Access Database Engine from: <http://www.microsoft.com/downloads/details.aspx?FamilyID=7554F536-8C28-4598-9B72-EF94E038C891&displaylang=en>

##### Stage Two: Transfer the Data

1. Open Enterprise Architect. Click on the **Cancel** button on the **Open Project** screen to open with no project loaded.
2. Select the **Tools | Data Management | Project Transfer** menu option. The **Project Transfer** dialog displays:

The screenshot shows the 'Project Transfer' dialog box. It features a 'Transfer Type' section with four radio buttons: '.EAP to .EAP' (selected), 'DBMS to .EAP', '.EAP to DBMS', and 'DBMS to DBMS'. Below this is the 'Source and Target Projects' section with 'Source Project' and 'Target Project' text boxes, each followed by a three-dot browse button. A 'Logfile' section contains a checked checkbox and a text field with a three-dot browse button. A caution message reads: 'Caution: The Target Project will be erased prior to transfer. Please ensure you have backed up target if necessary'. At the bottom, there are 'Transfer', 'Close', and 'Help' buttons, and a 'Progress:' label above a progress bar.

3. In the **Transfer Type** panel, select **.EAP to DBMS**.
4. In the **Source Project** field, type the name of the .EAP file to upsize to Access 2007.

5. At the right of the **Target Project** field, click on the [ ... ] (Browse) button. The **Datalink Properties** dialog displays.
6. Select **Microsoft Office 12.0 Access Database Engine OLE DB Provider** from the list, then click on the **Next** button.
7. On the **Data Source Details** page of the **Connection** dialog, type in the full path to the Access 2007 .ACCDB file.
8. Click on the **OK** button to return to the **Project Transfer** dialog.
9. If required, select the **Logfile** checkbox and type in a path and filename for the data transfer log file.
10. Click on the **Transfer** button to begin the data transfer process.

When the process is complete, you have upsized your model to Access 2007 and can now open it from Enterprise Architect.

### 3.3.5 Upsize to Sybase ASA

Before you set up Enterprise Architect for use with Sybase Adaptive Server Anywhere (ASA), it is recommended that you run the project integrity check tool (select the **Tools | Data Management | Project Integrity Check** <sup>[344]</sup> menu option) on the base project to upsize to ASA. This ensures the data is 'clean' before uploading.

#### Note:

You cannot move a model from a source .EAP file of a version earlier than 3.5.0.

#### Warning:

Before proceeding, ensure MDAC 2.6 or higher is installed on your system.

## Upsizing Your Database

You upsize your database for ASA in three stages, as follows:

### Stage One: Install ASA Components

1. Install Adaptive Server Anywhere - SQL Anywhere Studio 8 or higher. This also installs the ASA ODBC driver.
2. Create a new database for the Enterprise Architect repository using Sybase Central.
3. Create a suitable ODBC Data Source to point to your new database.

#### Note:

See [Set up an Adaptive Server Anywhere ODBC Driver](#) <sup>[141]</sup>.

### Stage Two: Configure the Database

From Sybase Central:

1. Right-click on the newly created database.
2. Open Interactive SQL and load the *ASA\_BaseModel.sql* file. This is available to registered users on the Corporate edition **Resources** page of the Sparx website at [http://www.sparxsystems.com/registered/reg\\_ea\\_corp\\_ed.html](http://www.sparxsystems.com/registered/reg_ea_corp_ed.html).
3. Run the script to create all required data structures.

#### Note:

See [Create a New Adaptive Server Anywhere Repository](#) <sup>[132]</sup>.

You now have an empty database, and can transfer an existing model into the server.

### Stage Three: Transfer the Data

1. Open Enterprise Architect (click on the **Cancel** button on the **Open Project** screen to open with no project loaded).
2. Select the **Tools | Data Management | Project Transfer** menu option. The **Project Transfer** dialog displays.

3. In the **Transfer Type** panel, select **.EAP to DBMS**.
4. In the **Source Project** field, type the name of the .EAP file to upsize to ASA.
5. At the right of the **Target Project** field, click on the [ ... ] (Browse) button. The **Datalink Properties** dialog displays.
6. Select **Microsoft OLE DB Provider for ODBC Drivers** from the list, then click on the **Next** button.
7. In the **Use Data source name** field, click on the drop-down arrow and select the ODBC Data Source you configured to point to your new database.

**Note:**

See [Connect to an Adaptive Server Anywhere Data Repository](#)<sup>[162]</sup> for more information.

8. Click on the **OK** button.
9. If required, select the **Logfile** checkbox and enter a path for the data transfer log file.
10. Click on the **Transfer** button to begin the data transfer process.

When the process is complete, you have upsized your model to Adaptive Server Anywhere and can now open it from Enterprise Architect.

### 3.3.6 Upsize to Progress OpenEdge

Before you set up Enterprise Architect for use with OpenEdge, it is recommended that you run the project integrity check tool (select the **Tools | Data Management | Project Integrity Check**<sup>[344]</sup> menu option) on the base project to upsize to OpenEdge. This ensures the data is clean before uploading.

**Note:**

You cannot move a model from a source .EAP file of a version earlier than 3.5.0.

**Warning:**

Before proceeding, ensure MDAC 2.6 or higher is installed on your system.

### Upsizing Your Database

You upsize your database for OpenEdge in three stages, as follows:

### Stage One: Install OpenEdge Components

1. Install OpenEdge, version 10.0B3 or higher.
2. Install OpenEdge ODBC 10.0B or higher driver.
3. Create a suitable ODBC Data Source to point to your new database.

#### Note:

See [Setup a Progress OpenEdge ODBC Driver](#) <sup>[145]</sup>.

### Stage Two: Configure the Database

1. Create an empty OpenEdge database, using the scripts *OpenEdge\_BaseModel.sql* file. This is available to registered users on the Corporate edition **Resources** page of the Sparx website at [http://www.sparxsystems.com/registered/reg\\_ea\\_corp\\_ed.html](http://www.sparxsystems.com/registered/reg_ea_corp_ed.html).
2. Make sure the new database is selected as the current database.
3. Run the script to create all required data structures.

#### Note:

See [Create a New Progress OpenEdge Repository](#) <sup>[134]</sup>.

### Stage Three: Transfer the Data

1. Open Enterprise Architect (click on the **Cancel** button on the **Open Project** screen to open with no project loaded).
2. Select the **Tools | Data Management | Project Transfer** menu option. The **Project Transfer** dialog displays:

The screenshot shows the 'Project Transfer' dialog box. It is divided into several sections:

- Transfer Type:** Four radio buttons are present. The first, labeled '.EAP to .EAP', is selected. The other three are 'DBMS to .EAP', '.EAP to DBMS', and 'DBMS to DBMS'.
- Source and Target Projects:** Two text input fields are shown. The top one is labeled 'Source Project:' and the bottom one is 'Target Project:'. To the right of each field is a small square button with three dots (...), used for browsing.
- Logfile:** A checkbox labeled 'Logfile' is checked. To its right is a text input field for the logfile path, also with a browse button (...).
- Caution:** A text message reads: 'Caution: The Target Project will be erased prior to transfer. Please ensure you have backed up target if necessary'.
- Buttons:** At the bottom of the dialog are three buttons: 'Transfer', 'Close', and 'Help'.
- Progress:** At the very bottom, there is a label 'Progress:' followed by a horizontal progress bar.

3. In the **Transfer Type** panel, select **.EAP to DBMS**.
4. In the **Source Project** field, type the name of the .EAP file to upsize to OpenEdge.
5. At the right of the **Target Project** field, click on the [ ... ] (Browse) button. The **Datalink Properties** dialog displays.
6. Select **Microsoft OLE DB Provider for ODBC Drivers** from the list, then click on the **Next** button.



7. In the **Use Data source name** field, click on the drop-down arrow and select the ODBC Data Source you configured to point to your new database.

**Note:**

See [Connect to a Progress OpenEdge Data Repository](#)<sup>[165]</sup> for more information.

8. Click on the **OK** button.
9. If required, select the **Logfile** checkbox and enter a path and filename for the data transfer log file.
10. Click on the **Transfer** button to begin the data transfer process.

When the process is complete, you have upsized your model to OpenEdge and can now open it from Enterprise Architect.

### 3.3.7 Upsize to MSDE

Before you set up Enterprise Architect for use with SQL Server Desktop Engine (MSDE), it is recommended that you run the project integrity check tool (select the **Tools | Data Management | Project Integrity Check**<sup>[344]</sup> menu option) on the base project to upsize to MSDE. This ensures the data is 'clean' before uploading.

**Note:**

You cannot move a model from a source .EAP file of a version earlier than 3.5.0.

**Warning:**

Before proceeding, ensure MDAC 2.6 or higher is installed on your system.

### Upsizing Your Database

Follow the steps in [Upsize to SQL Server](#)<sup>[176]</sup> to upsize your model to MSDE.

### 3.3.8 Upsize to PostgreSQL

Before you set up Enterprise Architect for use with PostgreSQL, it is recommended that you run the project integrity check tool (select the **Tools | Data Management | Project Integrity Check**<sup>[344]</sup> menu option) on the base project to upsize to PostgreSQL. This ensures your data is clean before uploading.

**Note:**

You cannot move a model from a source .EAP file of a version earlier than 3.5.0.

**Warning:**

Before proceeding, ensure MDAC 2.6 or higher is installed on your system.

### Upsizing Your Database

You upsize your database for PostgreSQL in three stages, as follows:

#### Stage One: Install PostgreSQL Components

1. Install PostgreSQL, version 7.3.2 or higher.
2. Install psqLODBC, version 7.03.01.00 or higher (but do not use version 8.4.1).
3. Create a suitable ODBC Data Source to point to your new database.

**Note:**

See [Set up a PostgreSQL ODBC Driver](#)<sup>[138]</sup>.

#### Stage Two: Configure the Database

1. From the PSQL command line, or using a tool such as the PostgreSQL command line, pgAdminIII or EMS PostgreSQL Manager, load the *Postgres\_Basemodel.sql* file. This is available to registered users on the Corporate edition **Resources** page of the [Sparx Systems website](#).
2. Run the script to create all required data structures.

**Note:**

See [Create a New PostgreSQL Repository](#) <sup>[129]</sup>.

You now have an empty database and can transfer an existing model into the server.

**Stage Three: Transfer the Data**

1. Open Enterprise Architect (click on the **Cancel** button on the **Open Project** screen to open with no project loaded).
2. Select the **Tools | Data Management | Project Transfer** menu option. The **Project Transfer** dialog displays.

3. In the **Transfer Type** panel, select **.EAP to DBMS**.
4. In the **Source Project** field, type or select the name of the .EAP file to upsize to PostgreSQL.
5. At the right of the **Target Project** field, click on the [ ... ] (Browse) button. The **Datalink Properties** dialog displays.
6. Select **Microsoft OLE DB Provider for ODBC Drivers** from the list, then click on the **Next** button.
7. In the **Use data source name** field, click on the drop-down arrow and select the ODBC Data Source you configured to point to your new database.

**Note:**

See [Connect to a PostgreSQL Data Repository](#) <sup>[160]</sup> for more information.

8. Click on the **OK** button.
9. If required, select the **Logfile** checkbox and type a path and filename for the data transfer log file.
10. Click on the **Transfer** button to begin the data transfer process.

**Note:**

If an error message displays reporting '*...nonstandard use of \\ in a string literal...*', set the server variable in the `postgresql.conf` file to:

```
escape_string_warning = off
```

When the process is complete, you have upsized your model to PostgreSQL and can now open it from Enterprise Architect.

### 3.3.9 Upsize to Oracle 9i, 10g or 11g

Before you set up Enterprise Architect for use with Oracle, it is recommended that you run the project integrity check tool (select the **Tools | Data Management | Project Integrity Check** <sup>[344]</sup> menu option) on the base project to upsize to Oracle. This ensures your data is clean before uploading.

**Note:**

You cannot move a model from a source .EAP file of a version earlier than 3.5.0.

**Warning:**

Before proceeding, ensure MDAC 2.6 or higher is installed on your system.

## Upsizing Your Database

You upsize your database for Oracle in three stages, as follows:

### Stage One: Create an Empty Database

1. Install Oracle.
2. Create an empty database.

**Note:**

See [Create a New Oracle Repository](#) <sup>[129]</sup>.

### Stage Two: Configure the Database

1. Using a tool such as the SQL\*Plus or SQL Plus Worksheet, load the `Oracle_BaseModel.sql` file. This is available to registered users on the Corporate edition **Resources** page of the [Sparx Systems website](#).
2. Make sure the new database is selected as the current database.
3. Run the script to create all required data structures.

**Note:**

See [Create a New Oracle Repository](#) <sup>[129]</sup>.

You now have an empty database and can transfer an existing model into the server.

### Stage Three: Transfer the Data

**Note:**

When transferring a project you must have permission to execute the **CREATE SEQUENCE** command.

1. Open Enterprise Architect (click on the **Cancel** button on the **Open Project** screen to open with no project loaded).
2. Select the **Tools | Data Management | Project Transfer** menu option. The **Project Transfer** dialog displays:

3. In the **Transfer Type** panel, select **.EAP to DBMS**.
4. In the **Source Project** field, type the name of the .EAP file to upsize to Oracle.
5. At the right of the **Target Project** field, click on the [ ... ] (Browse) button. The **Datalink Properties** dialog displays.
6. Select **Oracle Provider for OLE DB** from the list, then click on the **Next** button.
7. On the **Connection** page of the **Data Link Properties** dialog, enter the Oracle service name in the **Data Source** field, and the user name and password as required.

**Note:**

See [Connect to an Oracle Data Repository](#)<sup>[153]</sup> for more information.

8. Click on the **OK** button.
9. If required, on the **Project Transfer** dialog, select the **Logfile** checkbox and type a path and file name for the data transfer log file.
10. Click on the **Transfer** button to begin the data transfer process.

Once the process is complete, you have upsized your model to Oracle and can now open it from Enterprise Architect.

### 3.3.10 Upsize to SQL Server

Before you set up Enterprise Architect for use with SQL Server, it is recommended that you run the project integrity check tool (select the **Tools | Data Management | Project Integrity Check**<sup>[344]</sup> menu option) on the base project to upsize to SQL Server. This ensure the project data is 'clean' before uploading.

**Note:**

You cannot move a model from a source .EAP file of a version earlier than 3.5.0.

**Warning:**

Before proceeding, ensure MDAC 2.6 or higher is installed on your system.

## Upsizing Your Database

You upsize your database for SQL Server in three stages, as follows:

### Stage One: Create an Empty Database

1. Install SQL Server.
2. Create an empty database.

**Note:**

See [Create a New SQL Server Repository](#)<sup>[126]</sup>.

### Stage Two: Configure the Database

1. Using a tool such as the SQL Query Analyser, load the *SQL Server - Base Model.sql* file. This is available to registered users on the Corporate edition **Resources** page of the [Sparx Systems Website](#).
2. Make sure the new database is the currently active database.
3. Run the script to create all required data structures.

**Note:**

See [Create a New SQL Server Repository](#)<sup>[126]</sup>.

You now have an empty database, and can transfer an existing model into the server.

### Stage Three: Transfer the Data

**Note:**

When transferring a project you must have *db\_ddladmin* permission in order to execute the **SET IDENTITY\_INSERT [table] {ON | OFF}** command.

1. Open Enterprise Architect (click on the **Cancel** button on the **Open Project** screen to open with no project loaded).
2. Select the **Tools | Data Management | Project Transfer** menu option. The **Project Transfer** dialog displays.

3. In the **Transfer Type** panel, select **.EAP to DBMS**.
4. In the **Source Project** field, type the name of the .EAP file to upsize to SQL Server.
5. At the right of the **Target Project** field, click on the [ ... ] (Browse) button. The **Datalink Properties** dialog displays.
6. Select **Microsoft OLE DB Provider for SQL Server** from the list, then click on the **Next** button.
7. On the **Data Source Details** page of the Connection dialog, type in the server name, database name and security details as required.

**Note:**

See [Connect to a SQL Server Data Repository](#)<sup>[150]</sup> for more information.

8. Click on the **OK** button.
9. If required, select the **Logfile** checkbox and type in a path and filename for the data transfer log file.
10. Click on the **Transfer** button to begin the data transfer process.

When the process is complete, you have up-sized your model to SQL Server and can now open it from Enterprise Architect.

### 3.3.11 Upsize to MySQL

Before you set up Enterprise Architect for use with MySQL, it is recommended that you run the project integrity check tool (the **Tools | Data Management | Project Integrity Check**<sup>[344]</sup> menu option) on the base project to upsize to MySQL. This ensures data is 'clean' before uploading.

**Note:**

You cannot move a model from a source .EAP file of a version earlier than 3.5.0.

**Warning:**

Before proceeding, ensure MDAC 2.6 or higher is installed on your system.

## Upsizing Your Database

You upsize your database for MySQL in four stages, as follows:

### Stage One: Install MySQL Components

1. Install MySQL version 4.0.3 or higher.
2. Install MySQL ODBC 3.51 or higher.
3. Create a suitable ODBC Data Source to point to your new database.

#### Note:

There are two critical non-default settings required; see [Set up a MySQL ODBC Driver](#)<sup>[135]</sup> and ensure you select the checkboxes in step 7.

### Stage Two: Select Table Type

1. If you are using *InnoDB* tables, set up the *MySQL .ini* file as required and run the *MySQL - InnoDB BaseModel* script.
2. If you are using *MyISAM* tables, set up the *MySQL .ini* file as required and run the *MySQL - MyISAM BaseModel* script.

#### Note:

If MyISAM table types are used (default), transactional support is disabled. To enable transactions you must set up MySQL to use InnoDB tables and create the database tables as InnoDB type. Sparx provide a suitable script to create InnoDB based repository tables, as well as the more common MyISAM. These are available to registered users on the Corporate edition [Resources](#) page of the Sparx website at [www.sparxsystems.com/registered/reg\\_ea\\_corp\\_ed.html](http://www.sparxsystems.com/registered/reg_ea_corp_ed.html).

### Stage Three: Create the Database

1. Create an empty database.

#### Note:

See [Create a New MySQL Repository](#)<sup>[123]</sup>.

You now have an empty database, and can transfer an existing model into the server as described below.

### Stage Four: Transfer the Data

1. Open Enterprise Architect (click on the **Cancel** button on the **Open Project** screen to open with no project loaded).
2. Select the **Tools | Data Management | Project Transfer** menu option. The **Project Transfer** dialog displays:

3. In the **Transfer Type** panel, select **.EAP to DBMS**.
4. In the **Source Project** field, type the name of the .EAP file to upsize to MySQL.
5. At the right of the **Target Project** field, click on the [...] (Browse) button. The **Datalink Properties** dialog displays.
6. Select **Microsoft OLE DB Provider for ODBC Drivers** from the list, then click on the **Next** button.
7. In the **Use Data source name** field, click on the drop-down arrow and select the ODBC Data Source you configured to point to your new database.

**Note:**

See [Connect to a MySQL Data Repository](#)<sup>[148]</sup> for more information.

8. Click on the **OK** button.
9. If required, select the **Logfile** checkbox and type a path and filename for the data transfer log file.
10. Click on the **Transfer** button to begin the data transfer process.

When the process is complete, you have upsized your model to MySQL and can now open it from Enterprise Architect.

### 3.3.12 The WAN Optimizer

The Sparx *Wide Area Network (WAN) Optimizer* is a lightweight server installed on a Local Area Network (LAN) connection to a Database Management System (DBMS) that hosts an Enterprise Architect repository. You can configure the server to listen for client connections on a particular port; it acts as a local proxy to execute queries and return the results in a compressed format to the client.

The WAN Optimizer significantly improves Enterprise Architect's performance in a WAN by reducing the amount of data transmitted and, in turn, the number of network calls made.

In the following diagram, transmission between Enterprise Architect and a DBMS is depicted first without and then with the WAN Optimizer.



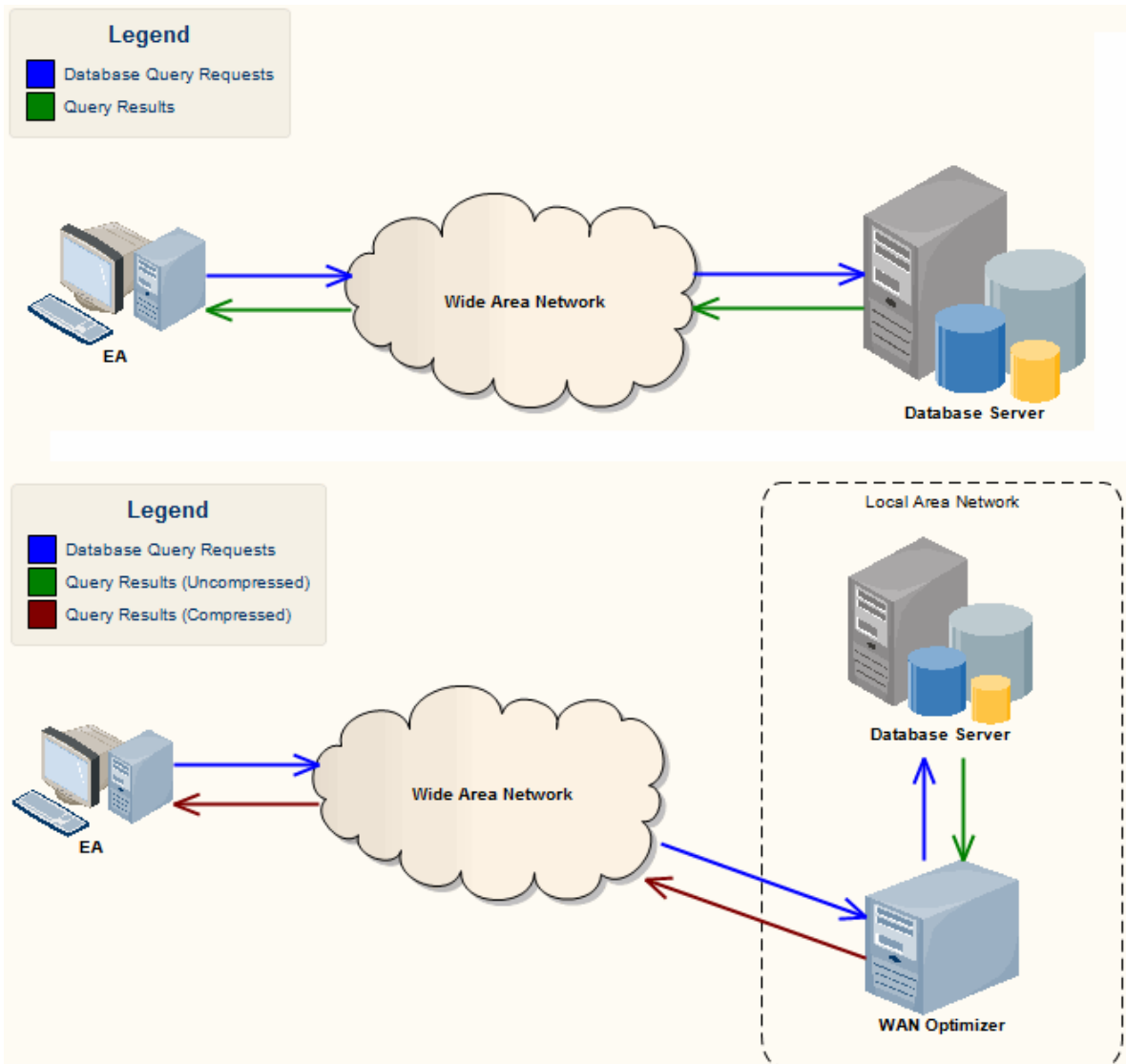

You can download the WAN Optimizer installer from the [Downloads](#) page of the [Registered Users](#) section of the Sparx Systems website. The Wan Optimizer Service installer package provides two installable features for the target machine:

- WAN Optimizer Service - the installer also helps register and start the service on the target machine, and add it to the Windows Startup folder.
- WAN Optimizer Admin Client - to enable an administrator to administer and configure the service from a remote client.

The Optimizer has its own *Sparx WAN Optimizer User Guide*. See that User Guide for more information on:

- WAN Optimizer Components
- Installing and Starting the WAN Optimizer Service
- Configuring the Service
- Troubleshooting.

## 3.4 Team Development

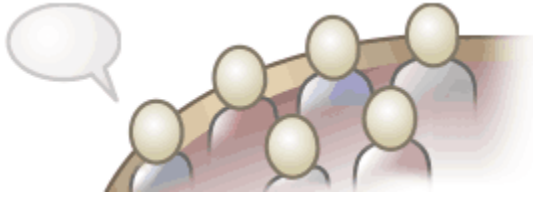

This section describes how Enterprise Architect enables you to develop a project across a team of people, so that each person can access the latest data without the risk of damaging or losing that data.

Topics discussed include:

- [Making project data available in a distributed environment](#)<sup>[182]</sup>
- [User Security](#)<sup>[188]</sup>
- [The Team Review facility](#)<sup>[208]</sup>
- [Workflow scripting](#)<sup>[220]</sup>
- [Sharing reference data](#)<sup>[223]</sup>.

### 3.4.1 Project Sharing

Enterprise Architect offers a diverse set of functionality designed specifically for [sharing projects](#)<sup>[183]</sup> in team-based and [distributed development](#)<sup>[183]</sup> environments.

Project sharing can be achieved through network deployment of model repositories, replication, XMI Import/Export and User Security.

Network deployment is possible under two different schemas:

- .EAP based repositories or
- DBMS server based repositories.

DBMS server based repositories offer better response times than .EAP files on networks due to the inherent structure of the DBMS. DBMS also offers a better solution when networking problems are encountered, as they have the ability to backtrack transactions caused by external breakdowns.

#### Replication

[Replication](#)<sup>[184]</sup> is a simple process that enables data interchange between .EAP based repositories and is suitable for use in situations where many different users work independently in parallel development. Modelers merge their changes into a Design Master only as required. It is recommended that a backup is carried out prior to replication.

Replication cannot be performed on repositories stored on a DBMS server.

#### XMI Import Export

[XMI Import/Export](#)<sup>[288]</sup> can be used to model discrete packages that can be exported and shared between developers. XMI enables the export of packages into XML files which can then be imported into any model.

Package control can be used to set up packages for version control and to enable batch export of packages using XMI. Version Control enables a repository to be maintained by a third-party source code control application that is used to control access and record revisions.

#### Security

[User security](#)<sup>[188]</sup> is used to limit the update access to model elements. It provides control over who in a project can make changes to model elements.

#### Further Information

For more information regarding the use of Enterprise Architect with shared models and team deployment please see the *Deployment of Enterprise Architect* white paper available from:

[www.sparxsystems.com/downloads/whitepapers/EA\\_Deployment.pdf](http://www.sparxsystems.com/downloads/whitepapers/EA_Deployment.pdf).

**Note:**

DBMS Repository support and User Security are available with the Corporate, Business and Software Engineering, System Engineering and Ultimate editions of Enterprise Architect.

### 3.4.1.1 Share Enterprise Architect Projects

**Note:**

Project Sharing and Replication are only enabled in the Professional, Corporate, Business and Software Engineering, System Engineering and Ultimate editions of Enterprise Architect.

The most efficient way of using Enterprise Architect to manage a team development is to *share* a project amongst a team of designers, developers and analysts.

By sharing a project, many people can work on the model at the same time and contribute their particular skill. Team members can always see what the latest changes are, keeping the team informed and up to date with the project status.

You can share an Enterprise Architect project in three ways:

1. Place the project in a [shared network directory](#)<sup>[183]</sup>.
2. Use [replication](#)<sup>[184]</sup>.
3. Use a [shared DBMS-based repository](#)<sup>[122]</sup> (Corporate, Business and Software Engineering, System Engineering and Ultimate editions).

### 3.4.1.2 Share Projects on Network Drive

The easiest way to share a project amongst a work group of developers and analysts is to place the project file on a shared network drive and have people connect from their workstations. Individual developers and analysts can then open and work on the project concurrently.

**Note:**

Enterprise Architect accepts a number of concurrent connections without issue, although there can be occasional 'lock-outs' when one user tries to access or update something another user is in the process of modifying.

## Network Issues

The main issues with shared network access are:

- Changes to the **Project Browser** (and other project views) are not automatically updated; to compensate for this, users must occasionally [reload](#)<sup>[267]</sup> their project to see changes made by other users.
- If two or more people work on the same diagram concurrently, unexpected results can occur; it is best to enable only one analyst to work on a diagram at a time.
- If a user's machine crashes, the network suffers an outage or a machine is turned off unexpectedly, the project file might require repair to compensate for the sudden inconsistency; a [repair](#)<sup>[348]</sup> facility is provided (select the **Tools | Manage .EAP File | Repair .EAP File** menu option) to carry out this task. This only applies to the file-based version of Enterprise Architect; the DBMS-based version does not suffer this problem.

### 3.4.1.3 Distributed Development

Enterprise Architect supports distributed development using two different techniques, as described below.

## Replication

Use the Replication features to enable geographically separated analysts to update and modify parts of the model in replicas, then merge these back together at a central location. For further information see the [Replication](#)<sup>[184]</sup> topic.

## XMI Import/Export

Use the XMI-based [Import/Export](#)<sup>[288]</sup> facility to model discrete packages, export to XML and share among the development team. This approach has several benefits over replication:

1. You can assemble a model from only the parts necessary to get your job done.
2. You can assemble a full model if required.
3. You can assemble a model from different package versions for different purposes (such as customer visible, internal release only).
4. You can roll-back parts of a model as required.
5. There is less chance of 'collisions' between developers if each works on a discrete package.
6. The process is controllable using a [version control](#) <sup>[228]</sup> system.

Use the **Import/Export context menu options** <sup>[65]</sup> (below) to access this feature; they are available through the **Project | Import/Export** submenu.



The [Controlled Package](#) <sup>[293]</sup> feature can also be used to assist in the process.

#### Note:

XMI based import/export is UML1.3 / XMI1.1 compliant. You can also write XML based tools to manipulate and extract information from XML files to enhance the development process.

### 3.4.1.4 Replication

Apart from sharing Enterprise Architect projects in real time over a network, you can also share projects using replication.

Replication is a powerful means of sharing projects between isolated or mobile users. In this scenario a project is converted to a design master, then replicas are made of the master. Users take the replicas away, modify the project, then bring their replicas back to be synchronized with the master file. Replication enables different users to work independently of one another, and to merge their changes at a later time.

#### Note:

To avoid difficulties in this inevitably hazardous process, please read all sections of this topic carefully.

## Enterprise Architect Merge Rules

Enterprise Architect follows these rules in merging:

- Additions are cumulative; that is, two replicas each creating three new Classes result in six new Classes after merging.
- Deletions prevail over modifications; if one replica changes a Class name and other deletes the Class, performing a merge results in both files losing the Class.

Conflicting modifications appear in the **Resolve Replication Conflicts** dialog (**Tools | Manage EAP File | Resolve Replication Conflicts** menu option). See [Resolve Conflicts](#) <sup>[187]</sup> for details on how to deal with conflicting modifications.

## Use Replication

To use replication, follow the steps below:

1. Convert the base project to a [design master](#) <sup>[185]</sup> using the **Tools | Manage .EAP File | Make Design Master** menu option.
2. [Create replicas](#) <sup>[185]</sup> from the design master using the **Tools | Manage .EAP File | Create New Replica** menu option.

3. Take the replica away and work on it as required, then bring it back for synchronization with the design master.
4. [Synchronize the replicas](#)<sup>[186]</sup>. During synchronization, all changes to both the master and the replica are propagated in both directions, so at the end they both contain the same information.

## Upgrades and Replicas

When you upgrade your version of Enterprise Architect, you must not open a replica until you have opened the design master and then synchronized the replicas with the master. You cannot directly [upgrade a replica](#)<sup>[186]</sup>.

## Avoid Change Collisions

If two or more people make changes to the same element - for example, a Class - Enterprise Architect arbitrarily overwrites one person's change with another's. To avoid this, different users should work on different packages.

However, since Enterprise Architect does not enforce this rule, it is possible for users' work to conflict. To minimize the difficulties this causes, please note the following guidelines:

- If users are likely to have worked in the same area of the model, they should both witness the synchronization and confirm that they are happy with the net result.
- If small pieces of information have been lost, they should be typed into one of the merged models after synchronization.
- If a large piece of information has been lost (for example, a large Class note that was overwritten by another user who had made a minor change to the same Class) use the [Resolve Replication Conflicts](#)<sup>[187]</sup> dialog.

## Disable or Remove Replication Features

If you have converted a project to a design master but now want to [disable the replication](#)<sup>[186]</sup> features, use the **Tools | Manage .EAP File | Remove Replication** menu option. Make sure you back up all your files first!

### 3.4.1.4.1 Design Masters

A *design master* is the first converted Enterprise Architect project that supports replication. From the design master you create replicas that can be modified independently of the master project and re-merged later.

## Create a Design Master

To create a design master, follow the steps below:

1. Take a back-up of the required Enterprise Architect project.
2. Select the project in the **Project Browser**.
3. Select the **Tools | Manage .EAP File | Make Design Master** menu option and follow the on-screen instructions.

### 3.4.1.4.2 Create Replicas

#### Note:

In the Corporate, Business and Software Engineering, System Engineering and Ultimate editions of Enterprise Architect, if security is enabled you must have [Manage Replicas](#)<sup>[198]</sup> permission to create a replica.

To create a replica, follow the steps below:

1. First create a [design master](#)<sup>[185]</sup>, then select the **Tools | Manage .EAP File | Create New Replica** menu option and follow the on-screen instructions.
2. This process creates a replica of the current project which can then be modified independently, and afterwards re-merged with the main project.

### 3.4.1.4.3 Synchronize Replicas

To copy changes from one member of the replica set to another, use the **Synchronize Replicas** menu option.

#### Notes:

- In the Corporate, Business and Software Engineering, System Engineering and Ultimate editions of Enterprise Architect, if security is enabled you must have [Manage Replicas](#)<sup>[198]</sup> permission to synchronize a replica.
- Information is copied *both* ways, including deletes, updates and inserts.

### Synchronize a Replica

To synchronize a replica and a design master, follow the steps below:

1. Open the design master project file.
2. Select the **Tools | Manage .EAP File | Synchronize Replicas** menu option.
3. Locate and select the required replica to merge the open project and the replica.

#### Note:

When you synchronize, both projects end up containing identical information.

### Change Collisions

Note that if two or more people work on the same element (or package or diagram) then the replication engine has problems in resolving which change is the master. To avoid this, always work on separate areas in the model when you are using replicas. You can also use the **Tools | Manage .EAP File | Resolve Replication Conflicts**<sup>[187]</sup> menu option.

### 3.4.1.4.4 Remove Replication

Replication makes many changes to the database structure of your model. As a consequence the model file becomes considerably larger with additional information.

If you no longer require a model to be replicable, you can remove all replication features.

### Remove Replication

To remove replication, follow the steps below:

1. If a repository is not open, the menu option for removing replication is not enabled. A temporary repository (not the one having replication removed) must be open at the time. Ensure you have a repository open at the time of creation.
2. Select the **Tools | Manage .EAP File | Remove Replication** menu option, to open the **Remove Replication Wizard**.
3. Enter the full path and file name of the project to have replication removed. Click on the **Next** button.
4. Enter the full path and file name of the base Enterprise Architect model (with no replication) to act as template. Click on the **Next** button.
5. Enter the full path and required file name for the output file. Click on the **Next** button.
6. Select whether to have a log file created, and enter a file name for the log file.
7. Click on the **Run** button to begin removing replication. Enterprise Architect creates a new project containing all the model information.

Your model has now had replication removed, and should be considerably smaller.

### 3.4.1.4.5 Upgrade Replicas

With new releases of Enterprise Architect there could be changes to the underlying project structure, such as more tables or changed queries.

If you are using replicas to share and work with Enterprise Architect projects, it is very important that you open the [design master](#)<sup>[185]</sup> before opening any of the replicas with an updated version of Enterprise Architect.

**Warning:**

Upgrading Replicas takes special care!

Changes to the database design in a replica set can ONLY be done to the design master. Next time the replicas are [synchronized](#)<sup>[186]</sup> with the master, the design changes are propagated through to the replicas. Trying to update a replica first at best does nothing, and at worst causes the update of the master to fail.

One other strategy is to [remove](#)<sup>[186]</sup> replication from a copy of the replica set, upgrade that project and convert it into a new design master from which new replicas are created.

### 3.4.1.4.6 Resolve Conflicts

When two or more people have changed the same element between synchronization points, Enterprise Architect has trouble resolving which change to accept and which to discard.

A choice is made based on rules within the JET replication manager, but the discarded changes are also stored so that you can manually override that choice.

After synchronizing replicas, open the **Resolve Conflicts** dialog and check that there were any conflicts. Select whether to accept each change or use one of the discarded changes instead.

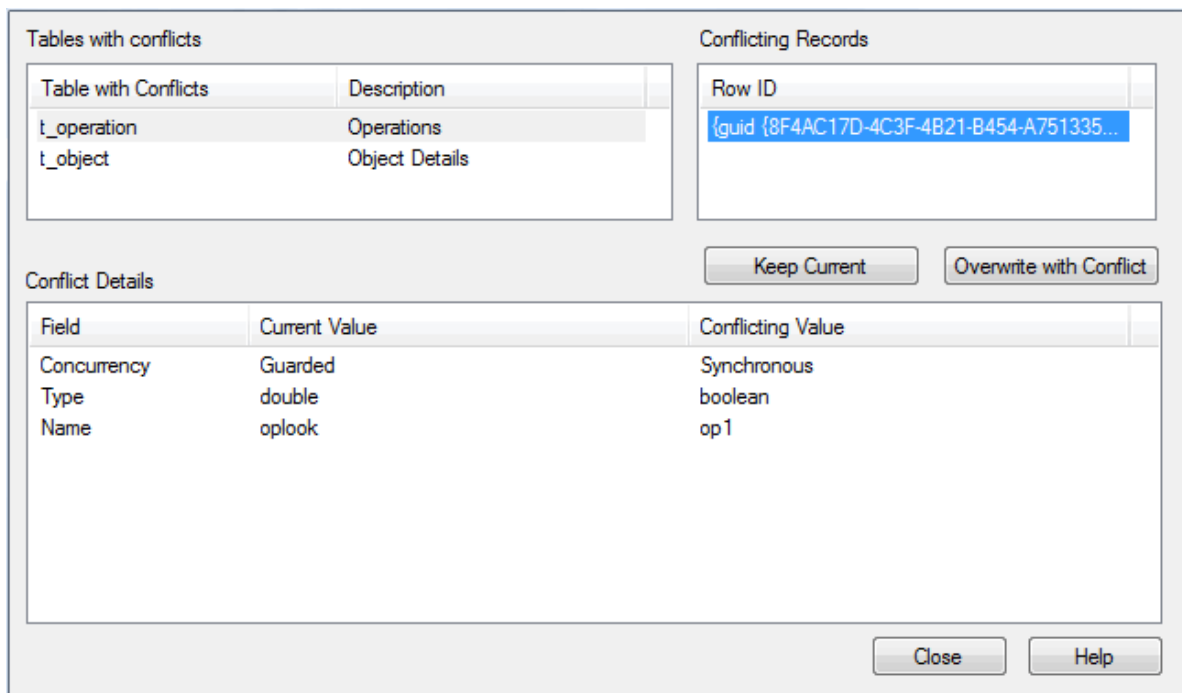

### Recommendations for Resolving Conflicts

Enterprise Architect stores model information in database records. When two records have been modified in different ways by different users, they appear in this dialog.

Normally it is not necessary or desirable to examine conflicts, since they represent relatively inconsequential pieces of information that can very easily be modified through the normal Enterprise Architect interface; for example, by moving a diagram element.

The only case in which this dialog should be used is where a substantial piece of information has been overridden by another user, and you want to retrieve it. Follow the steps below:

1. In the **Table with Conflicts** list, click on the entry that is likely to contain the lost information.
2. Click on each entry in the **Conflicting Records** list.
3. When the lost information appears in the **Conflict Details** list, click on the **Overwrite with Conflict** button.

## 3.4.2 Configure User Security

### What is User Security in Enterprise Architect?

User security in Enterprise Architect can be used to limit the access to update functions within the model.

Security in Enterprise Architect is not designed to prevent unauthorized access; rather it is intended as a means of improving collaborative design and development by preventing concurrent editing and limiting the possibility of inadvertent model changes by users not designated as model authors. Where user security is enabled a password is required to log in to the model. Elements can be locked per user or per group.

With workflow administration [permissions](#)<sup>[196]</sup>, you can also develop [workflow scripts](#)<sup>[220]</sup> (using the [Scripter](#)<sup>[166]</sup> window). Workflow scripts [validate and control](#)<sup>[220]</sup> user input.

### User Security Basics

User security is available in the Corporate, Business and Software Engineering, System Engineering and Ultimate editions of Enterprise Architect. It offers two policies: the standard security mode and the rigorous security mode.

- In the standard security mode all elements are unlocked and, as necessary, a user can set a user or group lock on any element or set of elements in order to make changes and protect those changes.
- Under the rigorous security mode an Enterprise Architect model is read-only and nothing in the model can be edited until explicitly checked out with a user lock.

For more detailed information on the security policies see the [Security Policy](#)<sup>[190]</sup> topic.

### User Security Tasks

A number of security tasks can only be performed by users with Administrative rights to the model. These tasks include:

- [Set Security Policy](#)<sup>[190]</sup>
- [Enable Security](#)<sup>[189]</sup>
- [Maintain Users](#)<sup>[191]</sup>
- [Import User IDs From Active Directory](#)<sup>[192]</sup>
- [Change User Passwords](#)<sup>[202]</sup>
- [Assign User To Groups](#)<sup>[194]</sup>
- [View All User Permissions](#)<sup>[196]</sup>
- [Maintain Groups](#)<sup>[197]</sup>
- [View and Manage Locks](#)<sup>[200]</sup>
- [Password Encryption](#)<sup>[200]</sup> (for the third-party DBMS connection password; only available for Oracle and SQL Server Repositories for Enterprise Architect releases prior to 7.1)
- [Create Workflow Scripts](#)<sup>[220]</sup>

Other Security tasks can be performed by users who do not have Administrative rights. These tasks include:

- [Lock Model Elements](#)<sup>[204]</sup>
- [Lock Packages](#)<sup>[205]</sup>
- [Apply a User Lock](#)<sup>[205]</sup>
- [Identify Who Has Locked An Object](#)<sup>[207]</sup>
- [Locked Element Indicators](#)<sup>[206]</sup>
- [Manage Your Own Locks](#)<sup>[207]</sup>
- [Change Your Own Password](#)<sup>[202]</sup>

#### Notes:

- User security is not enabled by default in Enterprise Architect; you must [enable it](#)<sup>[189]</sup> first.
- For a number of operations in Enterprise Architect, if security is enabled a user must have the appropriate user or group access permission to perform the operation. However, if security is not enabled, the user does not have to have access permissions. See the [List of Available Permissions](#)<sup>[198]</sup> topic.



### 3.4.2.1 Enable Security

User security is not enabled by default in Enterprise Architect. To enable security for a project in Enterprise Architect for the first time, follow the steps below.

1. Access the *Registered Users* section of the Sparx Systems website ([http://www.sparxsystems.com/registered/reg\\_ea\\_corp\\_ed.html](http://www.sparxsystems.com/registered/reg_ea_corp_ed.html)), and obtain the Authorization Key. (You must have the Registered Users login and password to access this web site.)
2. In Enterprise Architect, select the **Project | Security | Enable Security** menu option. The **Enter authorization** dialog displays

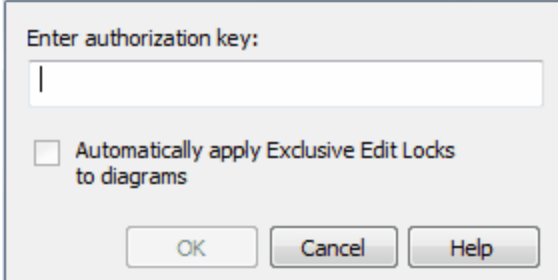

3. In the **Enter authorization key** field, type the authorization key from the Sparx Systems website.
4. If required, select the **Automatically apply Exclusive Edit Locks to diagrams** checkbox.

#### Note:

In standard (*User/Group Locking*) [security mode](#)<sup>[190]</sup>, this option blocks multiple users from simultaneously attempting to modify the same diagram. As a user *modifies* a diagram, Enterprise Architect automatically applies a User Lock to the diagram, preventing any other user from modifying it. It is creating difference between the database and buffer versions of the diagram that triggers the temporary lock, and elimination of difference that releases the lock. Therefore, Enterprise Architect releases the lock when:

- The user saves the changes to the diagram, with the **Save** icon or keyboard keys
- The user undoes the last remaining action in the **Undo** list
- The user saves or discards changes via the system prompt when they close the diagram.

If the diagram already has a User Lock or Group Lock that does not exclude the current user, this lock is set aside and saved when the temporary User Lock is applied. When the temporary User Lock is released, the pre-existing lock is restored.

The option is ignored in *Require User Lock* security mode.

5. Click on the **OK** button. Security is enabled, and an Admin user and user group are created with full permissions (all access rights listed in [List of Available Permissions](#)<sup>[198]</sup>) and a password of **password**.

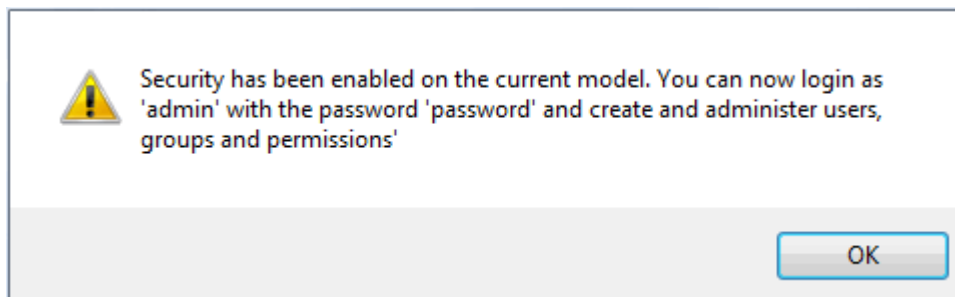

6. Select the **Project | Security | Login as Another User** menu option, and log in as **Admin** with the initial password of **password**.

#### Note:

To change the Admin password, see the [Change Password](#)<sup>[202]</sup> topic.

- Set up users and permissions as required.

**Note:**

Once security has been enabled, you must have the **Security - Enable/Disable** <sup>[198]</sup> access right to turn it off. The initial administrator automatically has this access right.

- To disable security, click on the **Enable Security** menu option, and again type the authorization key in the **Authorization** dialog. Click on the **OK** button. Security is disabled.

**Notes:**

- The system prompts you to log off the project and log on again, but this is not strictly necessary.
- To re-enable security, follow the procedure above, but be aware that any changes you have made to the admin user (password and reduced access rights) are reset to **password** and full access.
- The **Automatically apply Exclusive Edit Locks to diagrams** option is not displayed when disabling security. Therefore, to toggle the setting whilst security is enabled you must disable security and re-enable it. Security settings (users, groups and permissions) and locks on elements, are NOT affected by this action.

### 3.4.2.2 Security Policy

There are two possible security policies in Enterprise Architect:

- In the *User/Group Locking* mode, all elements and diagrams are considered unlocked and anyone can edit any part of the project. However, when you edit a diagram, package or element, you lock the element or set of elements at either the user level or group level. This mode is good for cooperative work groups where there is a solid understanding of who is working on which part of the model, and locking is used mainly to prevent further changes or to limit who has access to a part of the model.
- The *Require User Lock* mode is more rigorous. The Enterprise Architect model is read-only - everything is locked so that nobody can edit anything unless they explicitly check out the object with a user lock. A single 'check out' function operates on a diagram to check out the diagram and all contained elements in one go. There are also functions on the context (right-click) menus of packages, diagrams and elements in the **Project Browser** to apply a user lock when this mode is in use. You would use this mode when there is a strict requirement to ensure only one person can edit a resource at one time. This is suitable for much larger projects where there might be less communication between users.

Toggle between these modes using the **Project | Security | Require User Lock to Edit** menu option - deselected for User/Group Locking mode, and selected for Require User Lock mode.

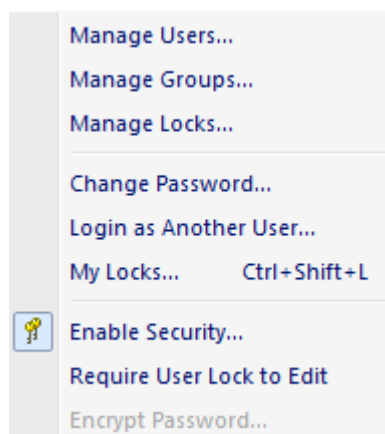

**Notes:**

- When you add new elements in Mode 1 (**Require User Lock to Edit** deselected, elements editable by default), no user lock is created automatically for the newly created element.
- When you add new elements in Mode 2 (**Require User Lock to Edit** selected, elements locked by default), a user lock is created on the new element to enable instant editing.

### 3.4.2.3 Maintain Users

If you enable security you have access to the **Security Users** dialog, which you can use to set up more users for your model.

#### Note:

You must have **Security - Manage Users** <sup>[198]</sup> permission to maintain users, and **Change Password** <sup>[198]</sup> permission to change the password of the current user; the initial **Admin** administrator automatically has these permissions.

### Set Up a User

To set up a user for your model, follow the steps below:

1. Select the **Project | Security | Manage Users** menu option. The **Security Users** dialog displays.

Surname	Firstname	Login
Administrator	The	admin
Walter	Frederick	FWAL
Walter	Frederick	Frederick

2. You can use the **Security Users** dialog to set up new users by providing their name and other details. You can also **import user IDs from a Windows Active Directory** <sup>[192]</sup>, **assign User IDs to groups** <sup>[194]</sup>, set up **Single Permissions** <sup>[195]</sup> or **View All** <sup>[196]</sup> permissions for the currently selected user.
3. To identify a new user on this dialog, click on the **New** button and type in the user's login ID, first name and last name. If required, also provide the user's department name.
4. To set the user's password, click on the **Change Password** button. The **Change Password** dialog displays.

5. In the **New password** field, type the user's password. This must be 12 characters or less in length.
6. In the **Retype new** field, type the user's password again, for confirmation.
7. Click on the **OK** button.
8. A *'Password Changed'* message displays. Click on the **OK** button.
9. When you have entered the details for the user, click on the **Save** button. Either click on the **New** button to add another user, or the **Close** button to exit the **Security Users** dialog.

#### Notes:

- You can transport the user definitions between models, using the [Export Reference Data](#) and [Import Reference Data](#) options on the **Tools** menu.
- If you select the **Accept Windows Authentication** checkbox, when a user opens the model Enterprise Architect checks the users database for their Windows ID and, if it matches, automatically logs the user in without prompting for a password.
- The **Accept Windows Authentication** checkbox enables the **Import** button, which you can select to import user IDs from a Windows Active Directory.
- As a security measure, the **Accept Windows Authentication** checkbox is automatically deselected if the project .eap file is moved to a different location. Once the file has been relocated, you can select the checkbox again to apply Windows authentication from the new database.

#### 3.4.2.4 Import User IDs From Active Directory

You can import your Enterprise Architect security user IDs from Windows Active Directory.

When you import the user IDs, you should [create an appropriate user group](#) and assign the user IDs to that group. You can then assign appropriate permissions to the group. When a user logs in to Enterprise Architect under their Windows login ID, they do not have to enter a password; Enterprise Architect automatically generates a random password. However, you can assign a new password to an imported user ID if required.

To import user IDs from a Windows Active Directory, follow the steps below:

1. On the **Security Users** dialog select the **Accept Windows Authentication** checkbox and click on the **Import** button. The **Import Users** dialog displays.

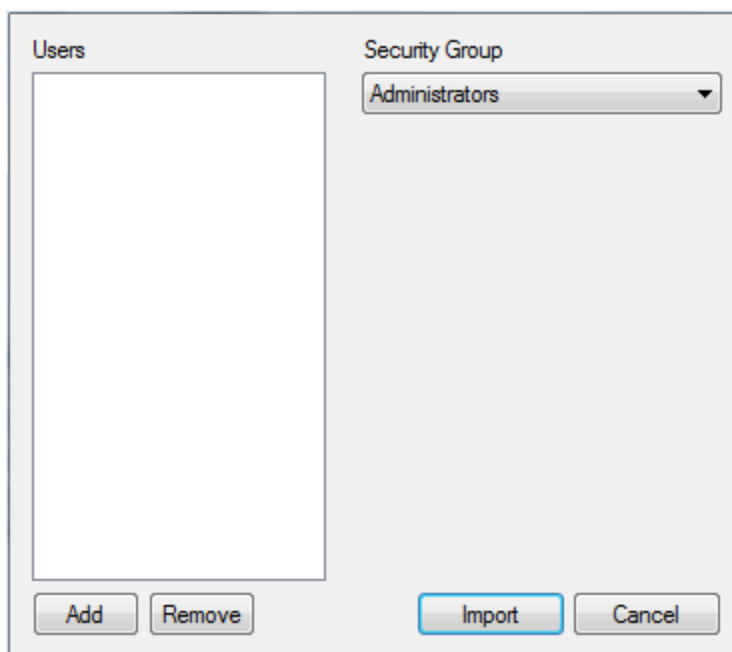

2. On the **Import Users** dialog, click on the down arrow in the **Security Group** field and select the appropriate security group for the imported user IDs.
3. Click on the **Add** button. The **Select Users** screen displays.

Select this object type:  
Users

From this location:  
Entire Directory

Enter the object names to select ([examples](#)):

4. Click on the **Object Types** button, and on the **Object Types** dialog select the checkbox for the type of object to import from the Active Directory. Click on the **OK** button to return to the **Select Users** dialog.
5. Click on the **Locations** button, and on the **Locations** dialog browse for and select the checkbox for the location to import from within the Active Directory. Click on the **OK** button to return to the **Select Users** dialog.
6. In the **Enter the object names to select** field, either:
  - type in the user IDs individually (click on the **examples** link to see examples of the correct formats) or
  - click on the **Advance** button to search for IDs; the **Select Users** dialog redisplay with a **Common Queries** tab.

7. In the **Name** and **Description** fields, type any characters or text that helps identify the IDs you are searching for. Click on the drop-down arrow of the **Starts with** field and select the appropriate qualifier.
8. If required, select the **Disabled accounts** or **Non-expiring password** checkboxes, and/or select a value in the **Days since last logon** field, to further filter the IDs to search for.
9. Click on the **Find Now** button to initiate the search, and to display a list of IDs in the bottom panel of the dialog. You can vary the types of information shown here by clicking on the **Columns** button and selecting the column headings to display.
10. When you have identified the IDs to import, click on a required ID (or press **[Ctrl]** or **[Shift]** while you click to select several) and click on the **OK** button. The **Select Users** dialog redisplay, with the selected ID or IDs listed in the **Enter the object names to select** field.
11. Click on the **OK** button to redisplay the **Import Users** dialog with the selected users' names listed in the **Users** panel.
12. Click on the **Import** button to add the user IDs to the **Security Users** dialog. Click on a user ID to populate the dialog fields with the user ID details, and [set group permissions](#) <sup>[197]</sup> as required.

### 3.4.2.5 Assign User To Groups

To set up user groups follow the steps below:

1. Select the **Project | Security | Manage Users** menu option. The **Security Users** dialog displays.
2. Click on the **Group Membership** button. The **User Groups** dialog displays.
3. Select the checkbox against each group this user belongs to.

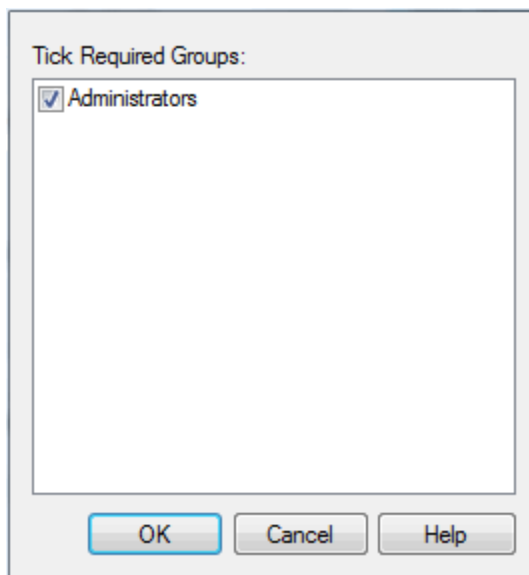

4. Click on the **OK** button to assign the user to each group.

**Notes:**

- You must have [Security - Manage Users](#) <sup>[198]</sup> permission to assign users to groups; the initial **Admin** administrator automatically has this permission.
- To create new user groups, see the [Maintain Groups](#) <sup>[197]</sup> topic.
- You can transport these user groups between models, using the [Export Reference Data](#) <sup>[223]</sup> and [Import Reference Data](#) <sup>[225]</sup> options on the **Tools** menu.

### 3.4.2.6 Set Up Single Permissions

You can set specific user permissions from the **User Permissions** dialog.

Specific user permissions are added to permissions from group membership to provide an overall permission set.

**Note:**

You must have [Security - Manage Users](#) <sup>[198]</sup> permission to assign permissions to users; the initial **Admin** administrator automatically has this permission.

To set up single permissions for a user follow the steps below:

1. Select the **Project | Security | Manage Users** menu option. The **Security Users** dialog displays.
2. Click on the **Single Permissions** button. The **User Permissions** dialog displays.

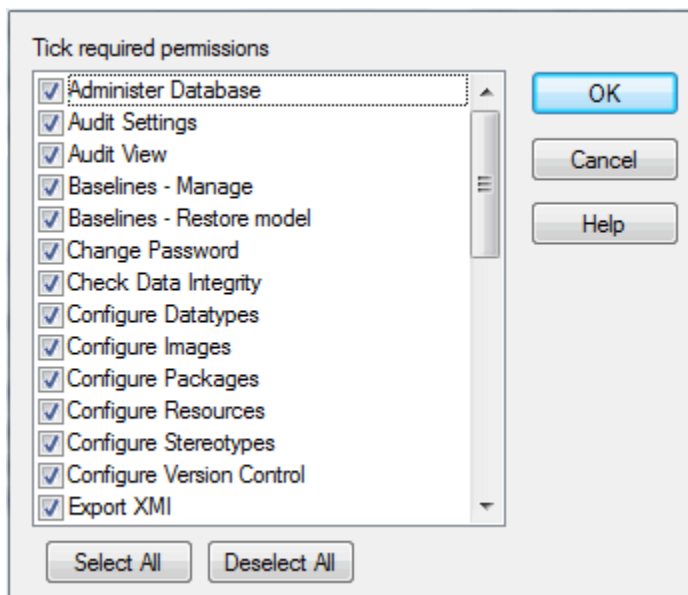

3. Select the checkbox against each specific permission to apply to this user. Click on the **Select All** button to select all permissions for the user, or click on the **Deselect All** button to clear all selected permissions.
4. Click on the **OK** button to assign the selected permissions to the user.

#### Notes:

- A user's total permissions are those granted by Group Membership plus those granted by specific permission assignment.
- You can transport these user permissions between models, using the [Export Reference Data](#) <sup>[223]</sup> and [Import Reference Data](#) <sup>[225]</sup> options on the **Tools** menu.

### 3.4.2.7 View All User Permissions

The **All user permissions** dialog shows a list of all permissions a user has, derived from their individual profile and from their membership of security groups.

To display the dialog, select the **Project | Security | Manage Users** menu option, then select the required user and click on the **View All** button.

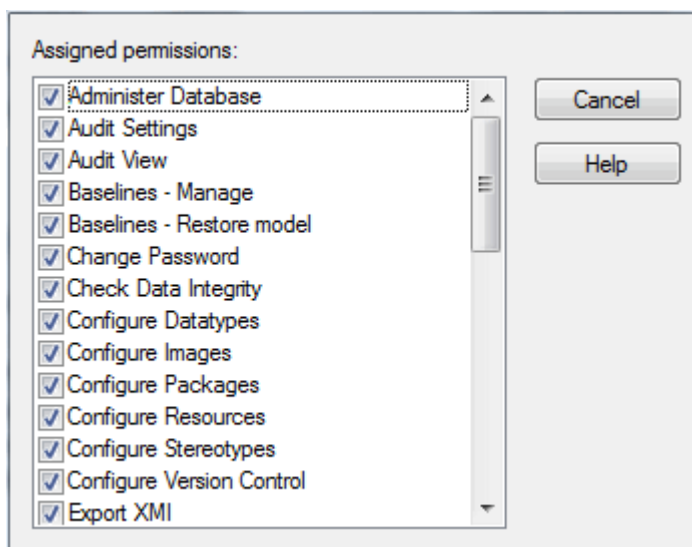



### 3.4.2.8 Maintain Groups

Security groups make it easy to configure sets of permissions and apply them to a number of users in one action.

#### Notes:

- You must have [Security - Manage Users](#) permission to manage user groups; the initial **Admin** administrator automatically has this permission.
- You do not define groups as group logins with passwords. If you intend to use a group login, you can define a [single-user login and password](#) that all group members use (that is, Enterprise Architect allows multiple logins under one user ID).

### Set Up a Security Group

To set up a security group, follow the steps below:

- Select the **Project | Security | Manage Groups** menu option. The **Security Groups** dialog displays.

Group Name	Description
Administrators	System Administrators
Business Proc	Business Processes and Procedures

- In the **Group Name** and **Description** fields, type the security group name and a description of the group.
- Click on the **Save** button.

#### Note:

You can transport these security group definitions between models, using the [Export Reference Data](#) and [Import Reference Data](#) options on the **Tools** menu.

### 3.4.2.9 Set Group Permissions

#### Note:

You must have [Security - Manage Users](#) permission to assign permissions to user groups; the initial **Admin** administrator automatically has this permission.

To set up permissions to apply to a security group, follow the steps below:

- Select the **Project | Security | Manage Groups** menu option. The **Security Groups** dialog displays.
- Click on the **Set Group Permissions** button. The **Group Permissions** dialog displays.

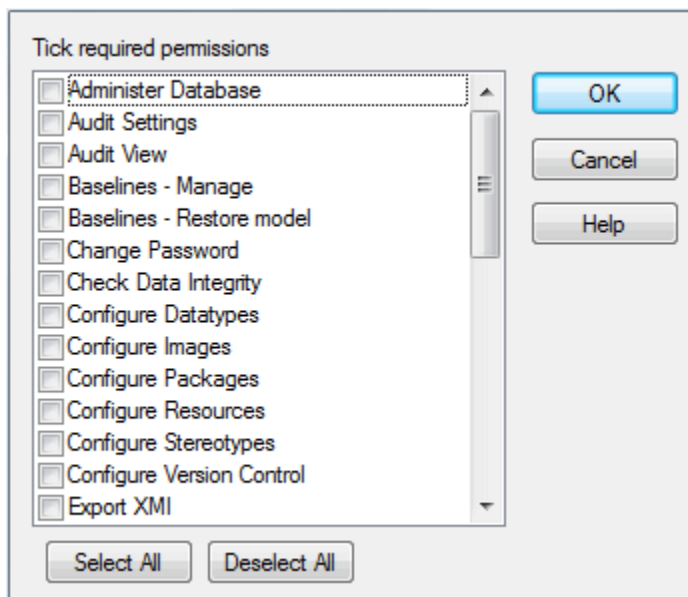

3. Select the checkbox against each required permission. Click on the **Select All** button to select all permissions for the user, or click on the **Deselect All** button to clear all selected permissions.
4. Click on the **OK** button to assign the permissions. All of the users assigned to this group share in this set of permissions.

**Note:**

You can transport these group permission definitions between models, using the [Export Reference Data](#) [223] and [Import Reference Data](#) [225] options on the **Tools** menu.

### 3.4.2.10 List of Available Permissions

The following table lists the available permissions in the Corporate, Business and Software Engineering, System Engineering and Ultimate editions of Enterprise Architect.

These permissions are required for the corresponding operations if security is enabled.

**Note:**

Some permissions take precedence over others. For example, if you set **Use Version Control** permission for a user, that user can modify model elements on import even if they do not have **Update Element** permission.

Permission	Enables the user to
Administer Database	<a href="#">Compact</a> [345] and <a href="#">repair</a> [345] a project database.
Admin Workflow	Develop and manage <a href="#">workflow scripts</a> [220].
Audit Settings	Change the audit settings in the <a href="#">Audit Settings</a> [271] dialog.
Audit View	Enable auditing and display data in the <a href="#">Audit View</a> [276] and <a href="#">Audit History</a> [276] tab.
Baselines - Manage	Create, delete, import and export <a href="#">Baselines</a> [279].
Baselines - Restore	<a href="#">Merge data</a> [279] into the project model from a Baseline or XML file.
Change Password	Change your own <a href="#">password</a> [202] or (Administrator) another user's password.
Check Data Integrity	Check and repair <a href="#">project integrity</a> [344].
Configure Datatypes	Add, modify and delete <a href="#">datatypes</a> [666].

Permission	Enables the user to
Configure Images	Configure <a href="#">alternative element images</a> [447].
Configure Packages	<a href="#">Configure controlled packages</a> [295] and package properties.
Configure Resources	Create and manage <a href="#">Resources</a> [667] window items: RTF templates, patterns, profiles, favorites.
Configure Stereotypes	Add, modify and delete <a href="#">Stereotypes</a> [662].
Configure Version Control	Set up <a href="#">version control options</a> [234] for the current model.
Export XMI	<a href="#">Export</a> [289] a model to XMI.
Generate Documents	Generate <a href="#">RTF</a> [1569] and <a href="#">HTML</a> [1647] documents from model packages.
Generate Source Code and DDL	Generate <a href="#">source code</a> [1308] and <a href="#">DDL</a> [1367] from a model element. <a href="#">Synchronize</a> [1327] code against model elements if it already exists.
Import XMI	<a href="#">Import</a> [290] a model from XMI.
Lock Objects	Lock an <a href="#">element</a> [204] or <a href="#">package</a> [205].
Manage Diagrams	<a href="#">Create</a> [422] new diagrams, <a href="#">copy existing</a> [436] and <a href="#">delete</a> [434] diagrams. Also save a diagram as a <a href="#">UML Pattern</a> [902].
Manage Issues	Update and delete <a href="#">Issues</a> [332].
Manage Project Information	Update and manage <a href="#">resources</a> [313], metrics and risks.
Manage Reference Data - Update	Update and delete <a href="#">reference items</a> [644].
Manage Replicas	<a href="#">Create</a> [185] and <a href="#">synchronize</a> [186] replicas.
Manage Tests	Update and delete <a href="#">Test records</a> [1537].
Reverse Engineer from DDL and Source Code	<a href="#">Reverse engineer</a> [1328] from source code or ODBC, and synchronize model elements against code.
Security - Enable/Disable	<a href="#">Disable</a> [189] user security in Enterprise Architect.
Security - Manage Locks	<a href="#">View and delete</a> [200] element locks.
Security - Manage Users	Maintain <a href="#">users</a> [191], <a href="#">groups</a> [194] and assigned <a href="#">permissions</a> [195].
Spell Check	<a href="#">Spell check</a> [1552] package and set spell check language.
Transfer Data	<a href="#">Transfer model</a> [307] between different repositories.
Transform Package	Perform <a href="#">transformations</a> [1385] of packages and elements.
Update Diagrams	Update <a href="#">diagram appearance, properties</a> [423] and layout, including the <a href="#">Page Setup</a> [455] <a href="#">dialog</a> [455].
Update Element	Save model changes (including delete) for <a href="#">elements</a> [522], <a href="#">packages</a> [387], and <a href="#">relationships</a> [609].
Use Version Control	<a href="#">Check files in and out</a> [261] using version control.

### 3.4.2.11 View and Manage Locks

From time to time it might be necessary to examine or delete locks placed on elements by users. Enterprise Architect provides a function to view and manage active locks.

#### Notes:

- You must have [Security - Manage Locks](#)<sup>[198]</sup> permission to view and delete user locks; the initial **Admin** administrator automatically has this permission.
- If an element is locked, connectors attached to it are also locked. To unlock the connector, you must unlock the element. However, under certain circumstances you can [add new connectors to a locked element](#)<sup>[204]</sup>.

### Delete a Lock

To view locks and, if necessary, delete them, follow the steps below:

- Select the **Project | Security | Manage Locks** menu option. The **Active Locks** dialog displays.

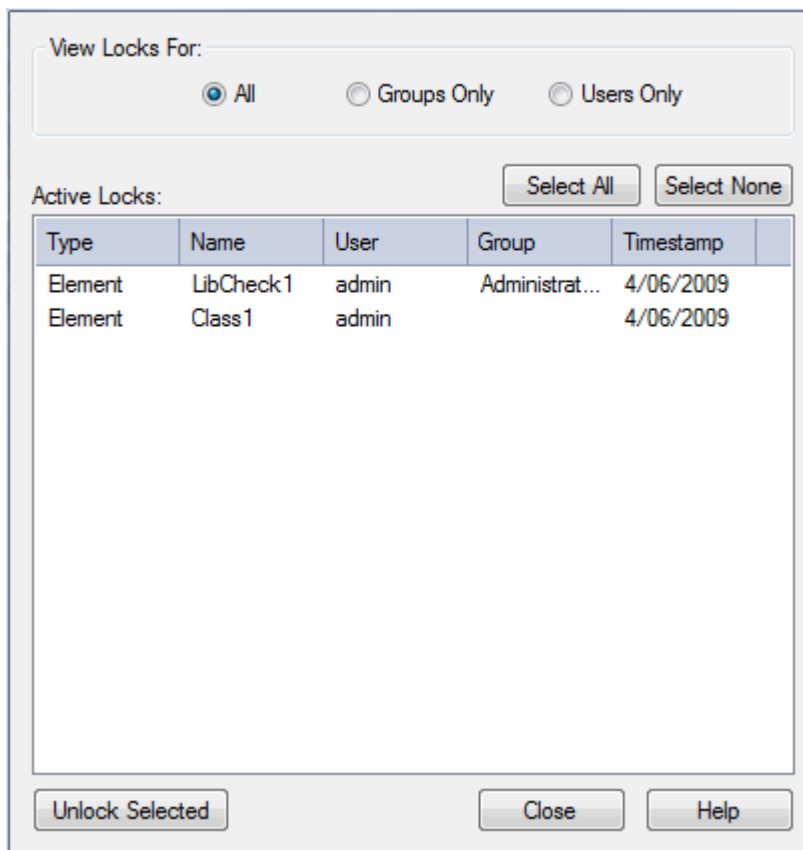

- In the **View Locks For** panel, click on the radio button for the type of lock to view: **All**, **Groups Only** or **Users Only**. Locks of the appropriate type are listed in the **Active Locks** panel. If you want to display the resulting information in a more readable layout, you can resize the dialog and its columns.
- To remove a lock, click on it and click on the **Unlock Selected** button.
- When finished, click on the **Close** button to close the dialog.

### 3.4.2.12 Password Encryption

#### Note:

This topic is retained to support regression to releases of Enterprise Architect prior to version 7.1. For password encryption for all repositories at and beyond release 7.1, see the [Model Shortcuts](#)<sup>[115]</sup> topic.

Users of SQL Server or Oracle repositories have the option of encrypting the password used to set up the connection between Enterprise Architect and the repository.

The Enterprise Architect user does not have the real password, thereby preventing them from accessing the repository using other tools such as Query Analyzer or SQLPlus. Once security is enabled, the administrator must log on to access the dialog to create encrypted passwords.

To encrypt a password, follow the steps below:

1. Select the **Project | Security | Encrypt Password** menu option. The following dialog displays:

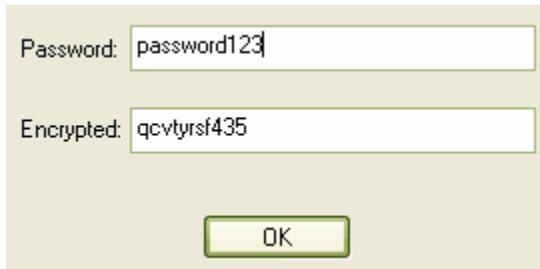

The image shows a dialog box with a light beige background. It contains two text input fields. The first field is labeled 'Password:' and contains the text 'password123'. The second field is labeled 'Encrypted:' and contains the text 'qcvtyrsf435'. Below these fields is a single button labeled 'OK'.

2. In the example above, the password **password123** is used to access the repository.
3. To connect Enterprise Architect to the repository, the user enters the encrypted password prefixed with **\$\$**, so the encrypted password becomes **\$\$qcvtyrsf435**.

For more information relating to connecting to Oracle and SQL Server, see the [Connect to Oracle Data Repository](#)<sup>[153]</sup> and [Connect to SQL Server Data Repository](#)<sup>[150]</sup> topics respectively.

#### Notes:

- Do not use the **Test Connection** button as it can cause an error with encrypted passwords.
- For SQL Server repositories, you must enter the *Initial Catalog* details from the **All** tab of the **Data Link Properties** dialog.

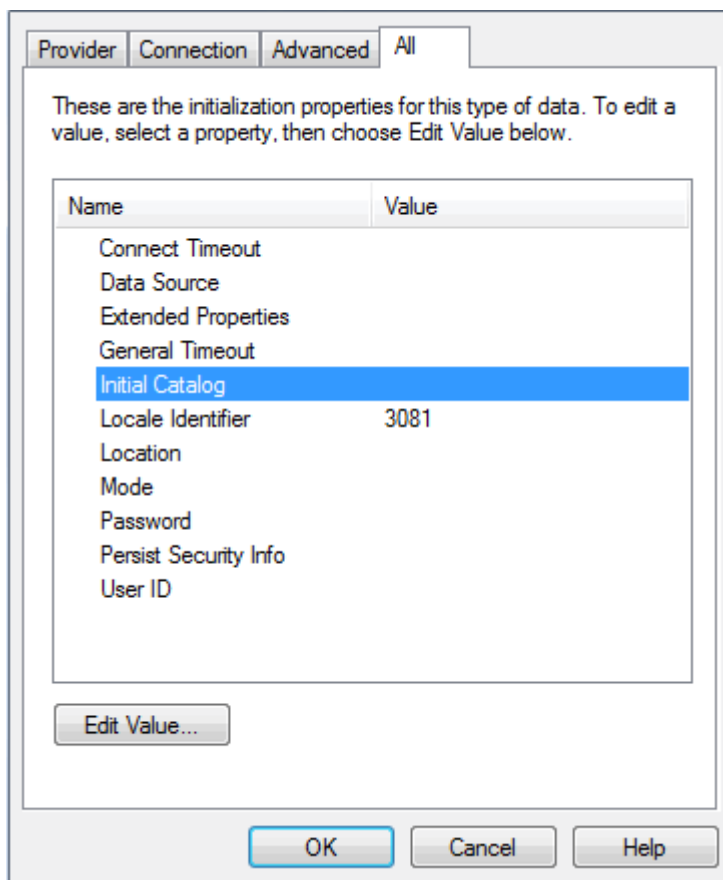

### 3.4.2.13 Change Password

There are two ways in which a user's password can be changed, when security is set:

- A user can select the **Change Password** menu option and change their own password
- The Administrator can set or change any user's password, on the **Maintain Users** dialog.

#### Note:

A user must have [Change Password](#) <sup>(198)</sup> permission to change a password; the initial **Admin** administrator automatically has this permission.

### User Change

If security is set and you want to change your own password, follow the steps below:

1. Select the **Project | Security | Change Password** menu option. The **Change Password** dialog displays.

Enter old password:

New password:

Retype new:

OK Cancel

2. In the **Enter old password** field, type your current password.
3. In the **New password** field, type your new password (this must be 12 characters or less in length).
4. In the **Retype new** field, type your new password again, for confirmation.
5. Click on the **OK** button.

6. A 'Password Changed' message displays. Click on the **OK** button to clear the message. Your new password is effective next time you log in.

## Administrator Change

To set or change any user's password, follow the steps below:

1. Select the **Project | Security | Manage Users** menu option. The **Security Users** dialog displays.

Surname	Firstname	Login
Administrator	The	admin

2. Click on the user name in the **Users:** panel, to display the user details in the dialog fields.
3. Click on the **Change Password** button. The **Change Password** dialog displays.

4. In the **New password** field, type the user's password; this must be 12 characters or less in length.

### Note:

You do not have to enter the user's current password, as they might have forgotten it and therefore it is possible that nobody can provide that value.

5. In the **Retype new** field, type the user's password again, for confirmation.
6. Click on the **OK** button.
7. A 'Password Changed' message displays. Click on the **OK** button.

### 3.4.2.14 Lock Model Elements

**Note:**

When security is enabled, you must have [Lock Objects](#)<sup>[198]</sup> permission to lock an element.

You can lock:

- A package, element or diagram using the corresponding **Lock** context menu option in the **Project Browser**, and
- An element or diagram using the corresponding **Lock** context menu option in the diagram.

Under the standard security policy (**Require User Lock to Edit** deselected), when you select the **Lock** option the **Element Lock** dialog displays:

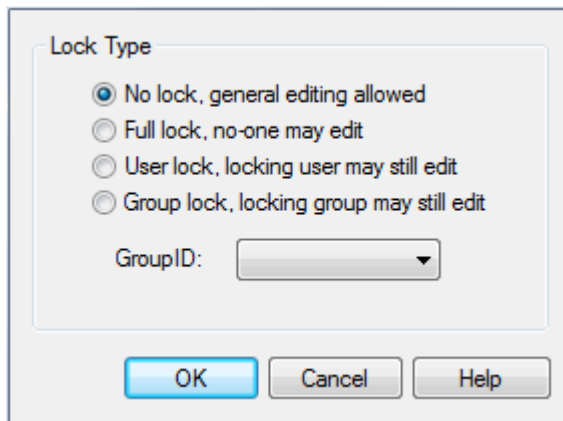

The four lock options available are:

- **No lock** - do not lock this element; clear any existing lock
- **Full lock** - lock this element so that no-one can edit it
- **User lock** - lock this element so that only the locking user can make further edits
- **Group lock** - lock this element so that any member of the specified group (in the **GroupID** field) can update the element, but others are excluded.

Select the appropriate lock and click on the **OK** button.

If the item is already locked, only the appropriate lock option and **No lock** are available. You have to release the lock in order to set a different type of lock.

Under the rigorous security policy, a different dialog displays. See the [Apply a User Lock](#)<sup>[205]</sup> topic.

If a diagram is locked and you select an object on it, the object border displays in red. This indicates that you cannot change the object.

### 3.4.2.15 Add Connectors To Locked Elements

When working with locked elements, the ability to add connectors depends on the locked status of the source and target elements. The rules are:

- **Source unlocked, target unlocked:** any kind of connector can be added
- **Source unlocked, target locked:** allowed, except for composition connectors
- **Source locked, target unlocked:** prohibited, except for composition connectors
- **Source locked, target locked:** prohibited for all connectors.

That is, a connector can be added if its source is unlocked, regardless of the locking state of the destination (think of it as modifying what the source can see). The exception is composition connectors, where the target (that is, parent) must be unlocked (think of it as modifying the parent by adding children).

Connectors with locked source or target elements are also locked. To unlock the connector, you must [unlock](#)<sup>[206]</sup> the source and/or target element.



### 3.4.2.16 Lock Packages

**Note:**

If security is enabled you must have [Lock Objects](#)<sup>[198]</sup> permission to lock a package.

You can lock all the contents of a package (and optionally all contents in child packages) in one step, using the *Lock Package* function.

The locks are automatically applied to elements and to diagrams, as if they had been individually set or cleared. Lock types and details are the same as for [locking a single element](#)<sup>[204]</sup>.

#### Lock a Package

To lock a package, follow the steps below:

1. Deselect the **Project | Security | Require User Lock to Edit** menu option.
2. In the **Project Browser**, right-click on the package to lock. The context menu displays.
3. Select the **Lock Package** menu option. The **Lock/Unlock Package(s)** dialog displays.

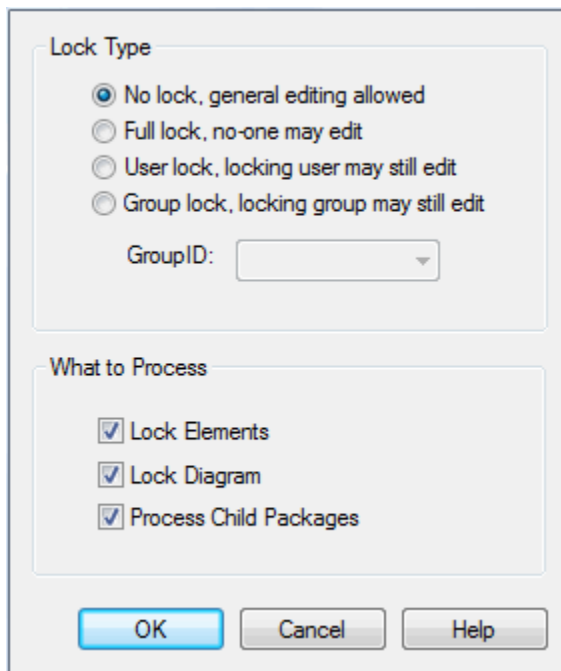

4. In the **Lock Type** panel, select the appropriate radio button for the lock to apply.
5. As required, select the checkboxes to lock elements and/or diagrams, and to process child packages (that is, lock the whole branch).
6. Click on the **OK** button to apply the lock.

### 3.4.2.17 Apply a User Lock

In the [Require User Lock to Edit](#)<sup>[190]</sup> security mode, where a User Lock is required before any edit can occur, you can set or release the lock in either a diagram or the **Project Browser**.

Enterprise Architect adjusts the lock for the element, or for the diagram and any elements contained in the diagram.

In a diagram, you right-click on the element or diagram; in the **Project Browser**, you right-click on the package, diagram or element. In each case, select the **Apply/Release User Lock** context menu option for the selected item. The following dialog displays.

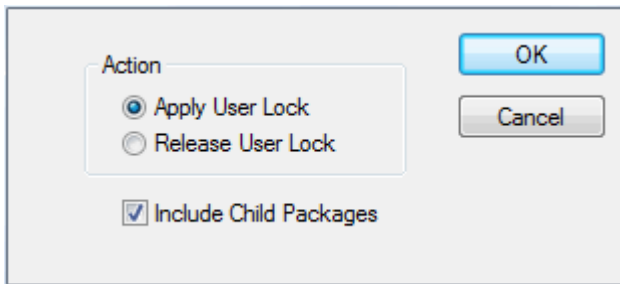

Select the appropriate radio button to apply or release a user lock on the selected item.

**Note:**

For a package, you can elect to also lock all child packages at the same time. If any elements in the package tree are locked by other users, a list of elements that couldn't be locked displays at the end of the process.

### 3.4.2.18 Locked Element Indicators

When an item is locked through Project Security, the lock is indicated in the **Project Browser** by a marker against the item, as shown below.

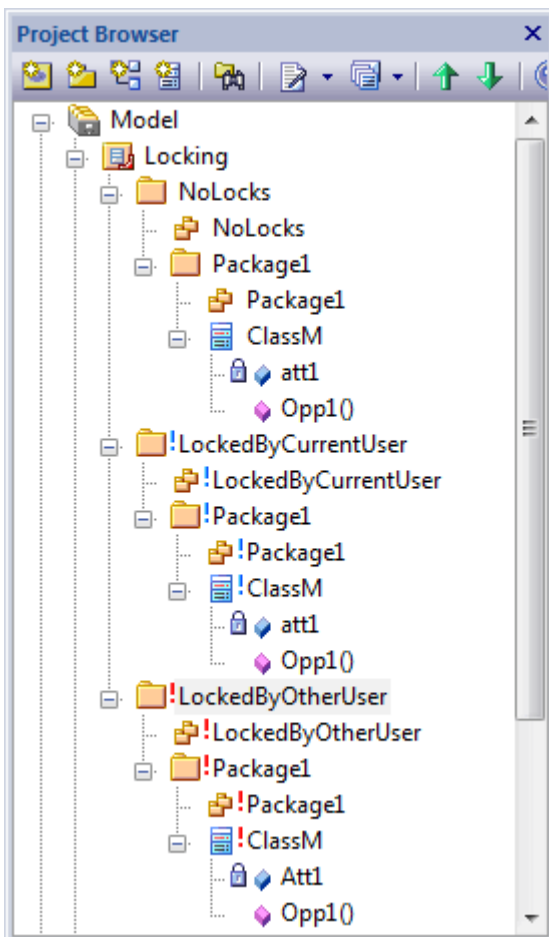

The meaning of the marker depends on the security mode.

If you are using the [Require User Lock to Edit](#)<sup>[190]</sup> security mode:

- **No** marker - there is no lock, the item is *not* editable, but any user can now [apply a user lock](#)<sup>[205]</sup> to edit the item

- **Blue** exclamation mark - the current user has applied a user lock and can edit the item; no other user can edit the item
- **Red** exclamation mark - another user has applied a user lock, and the current user cannot edit the item.

If you are using the [standard](#)<sup>[190]</sup> security mode:

- **No** marker - there is no lock, the item *is* editable, but any user can now [apply a user or group lock](#)<sup>[205]</sup>
- **Blue** exclamation mark - the item has a lock set by the current user or a group having the current user as a member, and the user can edit the item
- **Red** exclamation mark - the item has a lock set by another user, or a group of which the current user is not a member; the current user cannot edit the item.

If another user has locked an item, you can [identify who has locked it](#)<sup>[207]</sup>.

**Note:**

If a diagram is locked and you select an object on it, the object border displays in red. This indicates that you cannot change the object.

### 3.4.2.19 Identify Who Has Locked An Object

If you find that a diagram, package or element is locked, you can find out which group or user currently holds the lock on that item.

To do this, follow the steps below:

1. In the **Project Browser**, right-click on the diagram, package or element that is locked by another user or user group. The context menu displays.
2. Select the **Lock** menu option.

A message box displays showing which group or user currently holds the lock on that item.

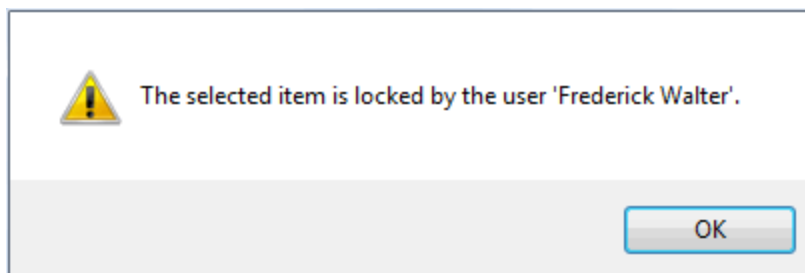

### 3.4.2.20 Manage Your Own Locks

You can view and delete your own user-level locks in Enterprise Architect. This is especially useful when working in [Mode 2 security](#)<sup>[190]</sup> (user locks required to edit).

To manage your locks select the **Project | Security | My Locks** menu option. The **My Locks** dialog displays.

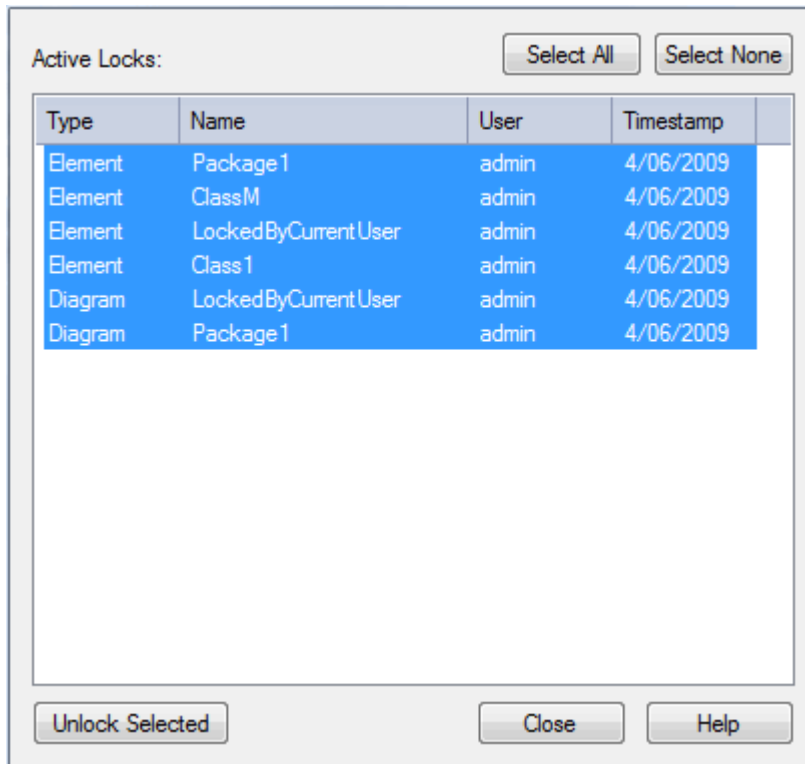

In the **My Locks** dialog you can select one or more locks and delete them (that is, unlock the object) by clicking on the **Unlock Selected** button.

### 3.4.3 Team Review Tools

The Enterprise Architect Project **Team Review** facility can be used to discuss the development and progress of a project.

To access the **Team Review**, either:

- Select the **View | Team Review** menu option, or
- Press **[Ctrl]+[Alt]+[U]**.

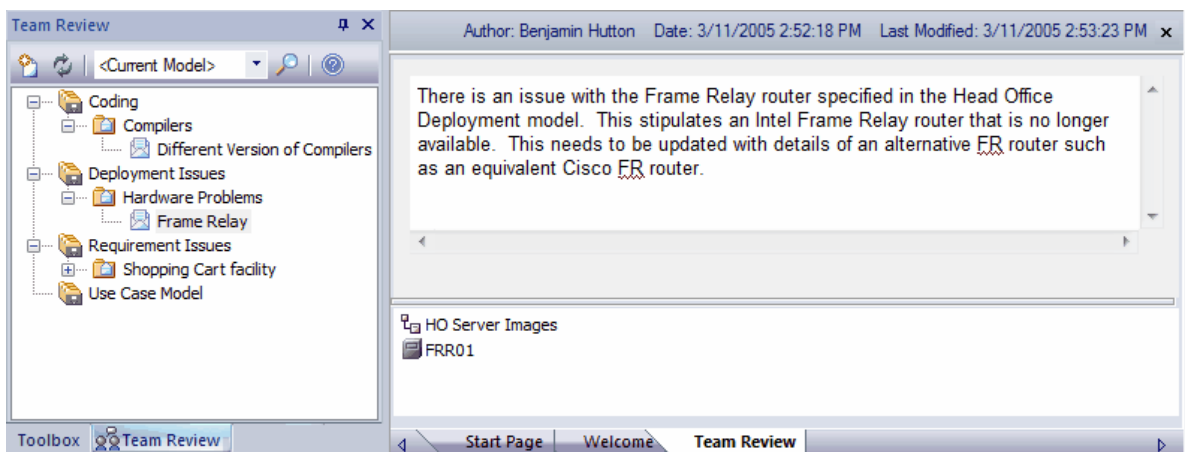

The Team Review facility has three main displays:

- The **Team Review** window is used to create new **Categories** [211] and **Topics** [212] and to **delete** [213] messages, using a **context menu** [209]. This is a **dockable** [75] window. Each item in the hierarchy displays a mouse-over tooltip, showing the item title, the author's name and the date and time the item was created.
- The **Team Review** tab, in the main work area, is used to view, print, **create** [213], **edit** [215], and **reply to** [214]

review Posts. This tab has a status bar that shows the item author's name, the date and time the item was created, and the date and time the item was last modified.











- The linked objects panel, located at the bottom of the **Team Review** tab, is used to [associate model elements](#) [216], diagrams, external files and other postings, with a review posting.

You can create text to explain Categories and Topics, and you can create and respond to Posts and replies. To *display or edit* the text on the **Team Review** tab, click on the item name in the **Team Review** window.

Using the **Search** icon in the **Team Review** toolbar, you can also [search for text strings in the item titles](#) [217], to enable you to locate posts on a specific topic.

As well as *linking* elements and diagrams to a Post, you can also add [resources](#) [217] to a Category, Topic or Post. Such resources, which include diagram images and XMI files of packages, are held in a *Resources* folder under the selected **Team Review** item.

The icons beside the review items have the following meanings:

-  Post read
-  Post unread
-  Reply read
-  Reply unread
-  Category (name in bold indicates category is unread)
-  Topic read
-  Topic unread
-  *Resources* folder for a Category, Topic or Post
-  Diagram or clipboard image within *Resources* folder
-  XMI File of package, within *Resources* folder.

### 3.4.3.1 Context Menu

The **Team Review** context menu enables you to access the following functions.

Option	Use to
<b>New Category</b> <b>New Topic</b> <b>New Post</b>	Add a <a href="#">new Category</a> [217], <a href="#">new Topic</a> [212] or <a href="#">new Post</a> [213] to the <b>Team Review</b> . Alternatively, for a Topic or Post, click on the <b>New</b> icon in the window toolbar.
<b>New Category From Template</b> <b>New Topic from Template</b> <b>New Post from Template</b>	Add a <a href="#">new Category</a> [217], <a href="#">new Topic</a> [212] or <a href="#">new Post</a> [213], based on a defined template.
<b>Post Reply</b>	Create a <a href="#">reply</a> [214] to the selected Post. Alternatively, click on the <b>New</b> icon in the window toolbar.
<b>Rename [F2]</b>	Edit the name, in situ, of the currently-selected item.
<b>Copy Path to Clipboard</b>	<a href="#">Copy the path</a> [218] of the currently-selected item to the clipboard.
<b>Show Contents</b>	Display the description or text of the selected item in the <b>Team Review</b> window, if the <b>Team Review</b> tab is not yet open.
<b>Share Resource</b>	(If anything other than a <a href="#">Resources</a> [217] folder is selected.)

Option	Use to
	Add a package from the current model, or an image of the currently-displayed diagram, or an image from the clipboard, to the <i>Resources</i> folder under the selected Category, Topic or Post. If the <i>Resources</i> folder does not exist, this option creates it.
<b>Add Package From Current Model</b>	(If a <a href="#">Resources</a> folder is selected.) Export a package as an XMI file from the current model as a resource of the selected Category, Topic or Post. You browse for and select the required package using the <a href="#">Select &lt;item&gt;</a> dialog.
<b>Import to Current Model</b>	(If a package XMI file resource is selected.) Import the resource package to the current model. You browse for and select the required target package using the <a href="#">Select &lt;item&gt;</a> dialog. The resource is imported as a child of that package. This is a useful option for transferring relevant packages from the <b>Team Review</b> of one model into another model.
<b>Add Image of Active Diagram</b>	(If a <a href="#">Resources</a> folder is selected.) Add an image of the currently-displayed diagram as a resource of the selected Category, Topic or Post. You are prompted to provide a reference name for this image.
<b>Add Active Profiler Report</b>	(If a <a href="#">Resources</a> folder is selected.) Add an active <a href="#">Profiler Report</a> as a resource of the selected Category, Topic or Post. You are prompted to browse for and select the appropriate active report.
<b>Image From Clipboard</b>	(If a <a href="#">Resources</a> folder is selected.) Add an image held on the clipboard as a resource of the selected Category, Topic or Post.
<b>View Image</b>	(If a diagram image <a href="#">resource</a> is selected.) Open the <b>View Image</b> window, containing an image of the selected diagram. Alternatively, double-click on the image name.
<b>Copy Image To Clipboard</b>	(If an image <a href="#">resource</a> is selected.) Copy the image or diagram image to the clipboard.
<b>Refresh Category 'xyz'</b> <b>Refresh Topic 'xyz'</b> <b>Refresh Post 'xyz'</b>	Refresh the currently-open Category, Topic or Post, getting new replies, Posts and Topics that other users might have created. However, if you open another Category, Topic or Post the Team Review always displays the latest information from the database. Alternatively, click on the <b>Refresh</b> icon in the window toolbar.
<b>Reload Current Connection</b>	Reload the entire <b>Team Review</b> connection, getting new Categories, Posts and Topics.
<b>Review Status</b>	Assign or clear a status marker against the selected Category, Topic or Post. You can mark the item as: <ul style="list-style-type: none"> <li>• <b>Awaiting Approval</b></li> <li>• <b>Approved</b></li> <li>• <b>Rejected</b></li> </ul> Or clear the marker ( <b>None</b> ).

Option	Use to
<b>Mark</b>	See the <b>Mark</b> submenu, below.
<b>Connections...</b>	Access <a href="#">other Team Reviews</a> from other Enterprise Architect models or models located on servers.  Alternatively, click on the drop-down arrow in the <b>Connection Options</b> field in the window toolbar, and select one of the listed models. The <b>&lt;Configure Connections&gt;</b> option enables you to add and connect to additional <b>Team Reviews</b> .
<b>Options...</b>	Change the <a href="#">loading behavior</a> of the <b>Team Review</b> .
<b>Delete Category &lt;xyz&gt;</b> <b>Delete Topic &lt;xyz&gt;</b> <b>Delete Post &lt;xyz&gt;</b> <b>Delete Resource &lt;xyz&gt;</b>	<a href="#">Delete</a> this Category, Topic, Post or reply and all sub-topics and sub-posts, or delete the resource attached to the item.

### The Mark Submenu

<b>All items as Read</b>	Mark the entire contents of the <b>Team Review</b> as <a href="#">read</a> .
<b>All items as Unread</b>	Mark the entire contents of the <b>Team Review</b> as <a href="#">unread</a> .
<b>Branch as Read</b>	Mark this item and all its contents as read.
<b>Branch as Unread</b>	Mark this item and all its contents as unread.
<b>'xyz' as Unread</b>	Mark only this item as unread.

#### 3.4.3.2 Add a New Category

To create a new *Category*, follow the steps below:

1. Right-click on a blank area in the **Team Review** window and select the **New Category context menu** option. A new Category icon displays in the hierarchy.

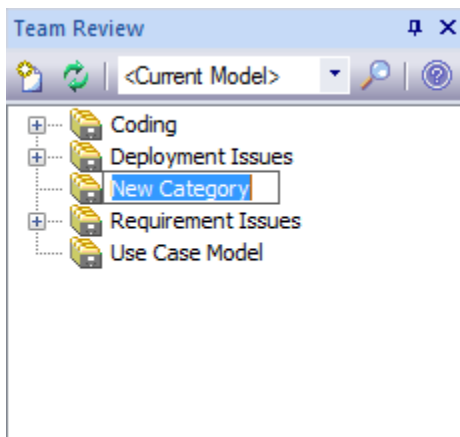

2. Type the name of the Category in the field just after the icon, and click off the name. The Category description is displayed in the **Team Review** tab. Type the appropriate Category description as required.

*Alternatively:*

1. Right-click on a blank area in the **Team Review** window and select the **New Category from template context menu** option. A new Category icon displays in the hierarchy.
2. Type the name of the Category in the field just after the icon, and click off the name. The **Create New Category** dialog displays.

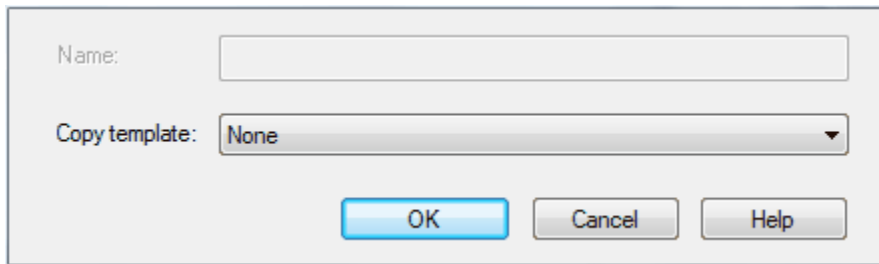

3. Click on the **Copy template** drop-down arrow and select a predefined template for the Category description.
4. Click on the **OK** button.
5. The Category description is displayed in the **Team Review** tab. Amend the Category description within the template, as required.

The Category is now available to [add new topics](#) <sup>[212]</sup>.

### 3.4.3.3 Add a New Topic

To create a new *Topic*, follow the steps below:

1. Either:
  - Right-click on the appropriate Category name in the **Team Review** window and select the **New Topic context menu** <sup>[209]</sup> option, or
  - Click on the Category name and on the **New** icon in the **Team Review** toolbar, or
  - Click on the Category name and press **[Ctrl]+[N]**.

A new Topic icon displays in the hierarchy.

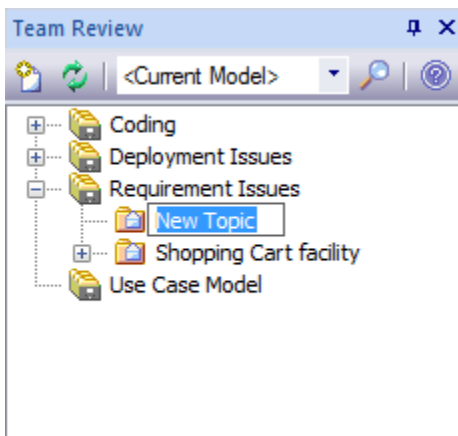

2. Type the name of the Topic in the field just after the icon, and click off the name. The Topic description is displayed in the **Team Review** tab. Type the appropriate Topic description as required.

*Alternatively:*

1. Right-click on the appropriate Category name in the **Team Review** window and select the **New Topic from template context menu** <sup>[209]</sup> option. A new Topic icon displays in the hierarchy.
2. Type the name of the Topic in the field just after the icon, and click off the name. The **Create New Topic** dialog displays.



3. Click on the **Copy template** drop-down arrow and select a predefined template for the Topic description.
4. Click on the **OK** button.
5. The Topic description is displayed in the **Team Review** tab. Amend the Topic description within the template, as required.

The topic is now available for you or any other user to [create Posts](#)<sup>[213]</sup> concerning the Topic, in the **Team Review** window.

### 3.4.3.4 Add a New Post

To create a new Post on a Topic in the **Team Review**, you have three options:

- Create a blank Post
- Create a Post based on a predefined template
- Create a Post from a file link.

When you have created the Post you can create and edit text in it. You can also [create links](#)<sup>[216]</sup> to elements and diagrams from the **Project Browser**, **Model Search**<sup>[1237]</sup> dialog, **Model Views**<sup>[1222]</sup> window and **Element List**<sup>[1255]</sup>, or you can link to related **Team Review** Categories, Topics or Posts. You can also insert links to external files, either in the text of the Post or in the links panel.

When you have saved the Post, other users can then [reply to it](#)<sup>[214]</sup>.

#### Blank Post

To create a blank message into which you can type text exactly as you require, follow the steps below:

1. Either:
  - Right-click on the appropriate Topic name in the **Team Review** window and select the **New Post context menu**<sup>[209]</sup> option, or
  - Click on the Topic name and on the **New** icon in the **Team Review** toolbar, or
  - Click on the Topic name and press **[Ctrl]+[N]**.

A new Post icon displays in the hierarchy.

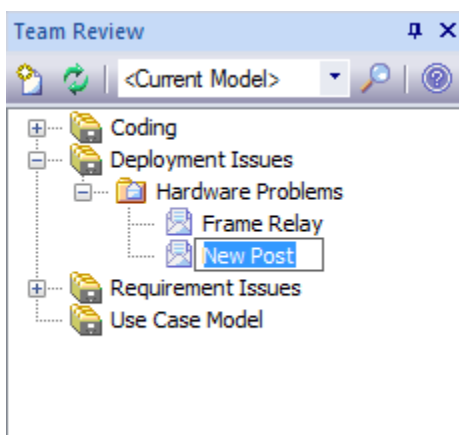

2. Type the name of the Post in the field just after the icon, and click off the name. The Post text is displayed in the **Team Review** tab.

### Post Based On Template

To create a structured Post based on a predefined template, follow the steps below:

1. Right-click on the appropriate Topic name in the **Team Review** window and select the **New Post from template context menu**<sup>[209]</sup> option. A new Post icon displays in the hierarchy.
2. Type the name of the Post in the field just after the icon, and click off the name. The **Create New Post** dialog displays.

3. Click on the **Copy template** drop-down arrow and select a predefined template for the Post contents.
4. Click on the **OK** button.
5. The template structure is displayed in the **Team Review** tab.

### Post From External File Link

To create a Post based on a link to an external file, follow the steps below:

1. Open a file browser (such as Windows Explorer) and locate the file.
2. Click on the file name and drag it onto the appropriate Topic name in the **Team Review** window.

A 'New Post' item is created underneath the selected Topic, and the body of the Post is created in the **Team Review** tab. A link to the source file is created at the start of the message.

You can create and edit text around the file link, and add further links if required. You should also rename the 'New Post' item, by clicking twice on it.

#### 3.4.3.5 Reply to a Post

To reply to a post, follow the steps below:

1. Either:
  - Right-click on the Post name in the **Team Review** window and select the **Post Reply context menu**<sup>[209]</sup> option, or
  - Click on the Post name and on the **New** icon in the **Team Review** toolbar, or
  - Click on the Post name and press **[Ctrl]+[N]**.

A 'Re:<Postname>' entry displays in the **Team Review** hierarchy, underneath the Post you are replying to, and the cursor becomes active in the **Team Review** tab to enable you to create and **edit**<sup>[215]</sup> your response.
2. Type in, format and save the contents of the reply.

*Alternatively:*

1. Open a file browser and locate the required file.
2. Drag the file name onto the Post to which you are replying. A 'Re:<Postnames>' entry displays in the **Team Review** window underneath the Post, and the body of the reply is created in the **Team Review** tab. A link to the source file is created at the start of the message.
3. You can create and edit text around the file link, and add further links if required.

You can also **create links to**<sup>[216]</sup> elements and diagrams in the **Project Browser**, **Model Search**<sup>[1231]</sup> dialog, **Model Views**<sup>[1222]</sup> window and **Element List**<sup>[1253]</sup>, or you can add related **Team Review** Categories, Topics or Posts. You can also insert other links to external files, either in the text of the Post or in the links panel.

Other users can reply to the Post and to your response.

### 3.4.3.6 Edit an Item

To edit a Category, Topic, Post or reply, simply click on the item text in the **Team Review** tab.

The cursor becomes active in the **Team Review** tab to enable you to [edit](#)<sup>[215]</sup> your response. Modify any relevant details.

If it is just the name of the item that requires changing, click on the name and press **[F2]**. You can now retype the name in place.

### Delete Team Review Items

To delete a Category, Topic, Post or reply, right-click on the item in the **Team Review** window and select **Delete <item> <name>** from the [context menu](#)<sup>[209]</sup>.

Alternatively, click on the item and press **[Delete]**.

A confirmation dialog displays. Click on the **Yes** button; the item and any dependent items are removed from the **Team Review**.

### 3.4.3.7 Team Review Editor

The *Team Review Editor* provides the means for creating and editing explanatory text for [Categories](#)<sup>[211]</sup> and [Topics](#)<sup>[212]</sup>, and message text for [Posts](#)<sup>[213]</sup> and [Replies](#)<sup>[214]</sup>.

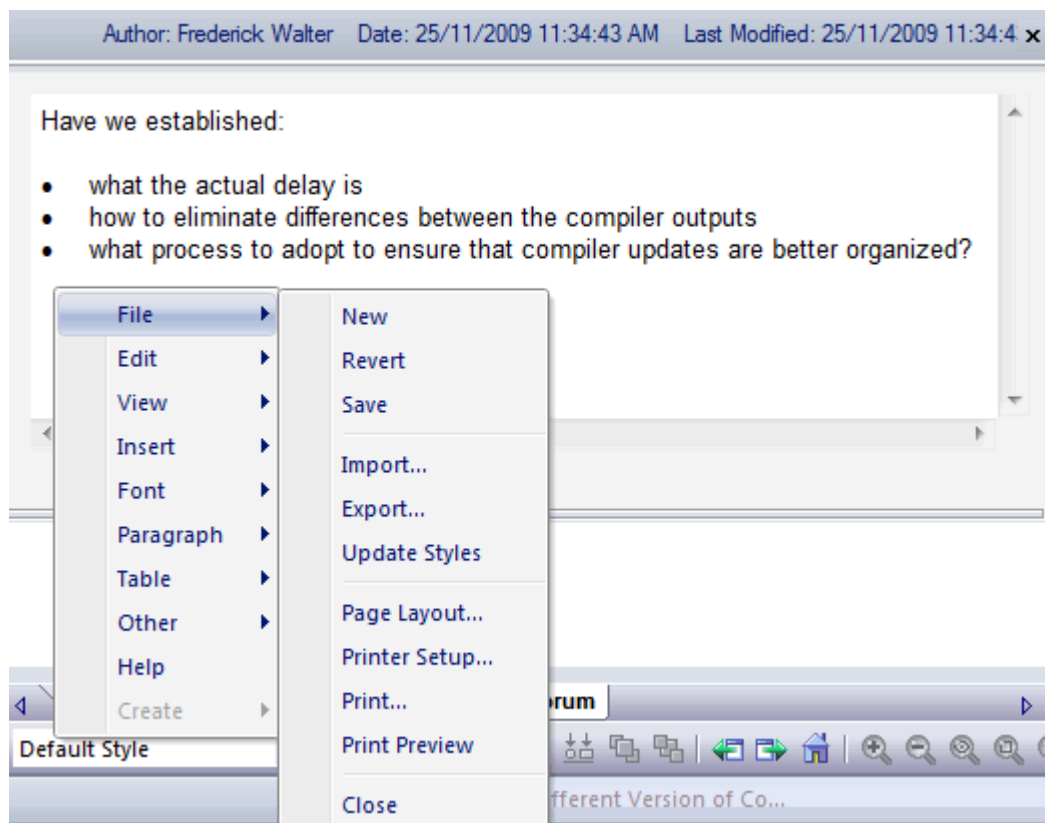

The editor provides a set of standard functions that you access by right-clicking on the text, to display a hierarchy of context menus. The following topics provide assistance on using the **Team Review** Editor.

- [Scroll Through Text](#)<sup>[1588]</sup>
- [File and Print Options](#)<sup>[1588]</sup>
- [Cut and Paste Options](#)<sup>[1589]</sup>
- [Image and Object Imports](#)<sup>[1591]</sup>
- [Character Formatting](#)<sup>[1592]</sup>
- [Paragraph Formatting](#)<sup>[1593]</sup>

- [Tab Support](#) <sup>[1595]</sup>
- [Page Breaks and Repagination](#) <sup>[1595]</sup>
- [Insert Headers and Footers](#) <sup>[1596]</sup>
- [Insert Bookmarks](#) <sup>[1596]</sup>
- [Table Commands](#) <sup>[1597]</sup>
- [Sections and Columns](#) <sup>[1599]</sup>
- [Stylesheets and Table of Contents](#) <sup>[1600]</sup>
- [Text/Picture Frame and Drawing Objects](#) <sup>[1604]</sup>
- [Search/Replace Commands](#) <sup>[1605]</sup>
- [Hyperlink From Linked Document](#) <sup>[601]</sup>
- [Create Elements From Linked Documents](#) <sup>[602]</sup>

When you have completed your editing, select the **File | Save** menu option and then click on another item in the **Team Review** window to exit the message.

The text is saved in the **Team Review** item. To display the text in the **Team Review** tab, click on the item once.

### 3.4.3.8 Add Object Links

In the **Team Review** tab you can create hyperlinks to elements and diagrams that are associated with a Post.

This enables rapid navigation to the objects in the **Project Browser**, access to the element properties and, with diagrams, the ability to open the diagram directly from the **Team Review**. You can also create links to:

- Other Categories, Topics and Posts in the **Team Review** window
- External files from a file browser.

To associate an element, diagram or **Team Review** item with the message, drag the object from the **Project Browser**, **Element List**, **Model Views** window, **Model Search** dialog or **Team Review** window into the linked elements panel at the bottom of the **Team Review** tab.

To associate an external file with the message, click on and drag the file name from any browser into either the linked elements panel or the text of the message itself (although they behave in exactly the same way). The filename becomes a link to the file; click on it to display the contents of the file.

The external file name also becomes a link to the file within the message when you drag the filename onto a Topic to [create a post](#) <sup>[213]</sup>.

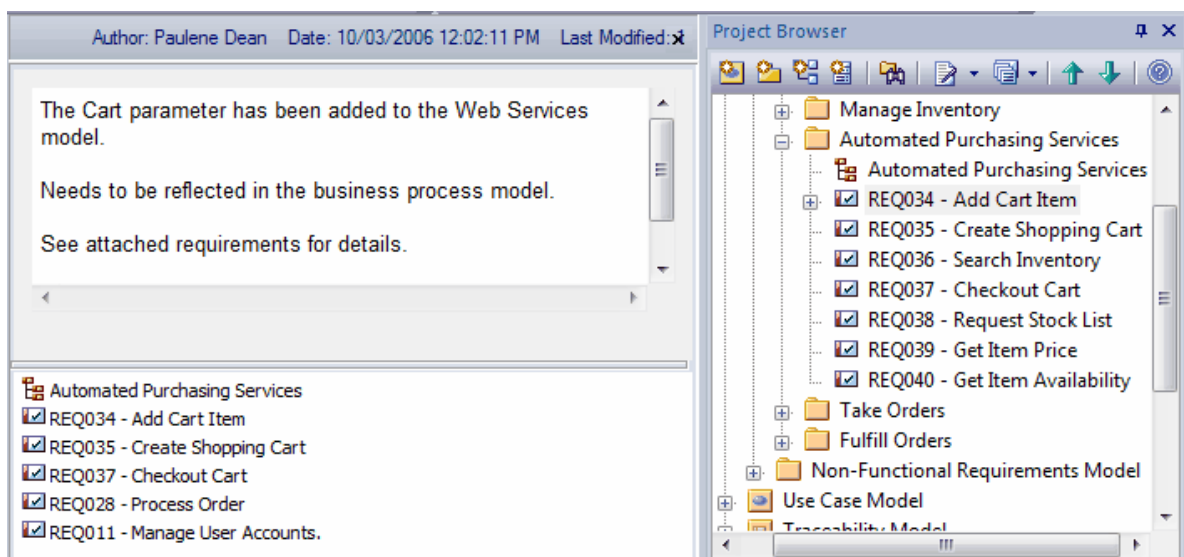

To access the navigation options of each object in the linked elements section, right-click on the object to display the navigation context menu. The options are outlined in the table below.

Option	Use to
Open	Open the diagram or external file.
Properties	Display the element properties for the selected element.
Find in all Diagrams	Open the diagram in which the element is used, or display a list of several diagrams in which the element has been used.
Delete Link	Delete the association between the message and the object.

### 3.4.3.9 Team Review Resources

You can add resources to a Category, Topic or Post within the **Team Review** window. These resources include:

- XMI files of packages within the current project
- Active Profiler reports
- Images of currently-active diagrams.

The resources are created in a *Resources* folder underneath the selected Category, Topic or Post, as illustrated below:

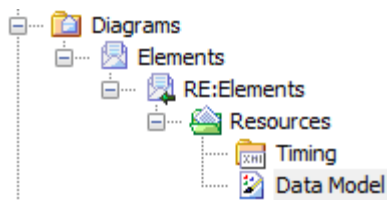

You create the *Resources* folder by creating a resource underneath the selected Category, Topic or Post. Similarly, you delete the *Resources* folder by deleting the last resource within it. Having added a resource, you can reimport the package XMI files to the model or display the diagram images

All Team Review resource management tasks are performed using options on the **Team Review context menu** <sup>[209]</sup>.

### 3.4.3.10 Search Team Review

The **Team Review** provides the facility to search the *titles* of all **Team Review** items, to enable you to locate items referring to a specific subject.

To do this, follow the steps below:

1. In the **Team Review** window toolbar, click on the **Search** icon (  ). The search panel displays underneath the toolbar.

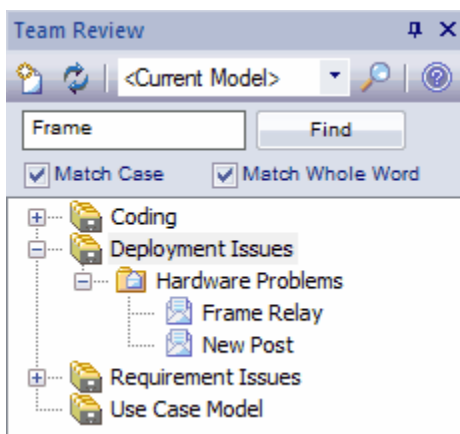

2. In the blank field, type the text string to search for.
3. If required, select the **Match Case** checkbox to locate text with the same case as the search string.
4. If required, select the **Match Whole Word** checkbox to locate only complete words that match the search string.
5. Click on the **Find** button. The search locates the first instance of the search string in the title of a Category, Topic, Post or Reply item, and displays the contents of that item in the **Team Review** tab.
6. To locate further instances of the text string, click on the **Find** button again.
7. To close the search panel, click on the **Search** icon in the toolbar again.

### 3.4.3.11 Copy Path to Clipboard

To copy the current path in the **Team Review** window to the clipboard, right-click on the appropriate item in the window and select the **Copy Path To Clipboard** [context menu](#) <sup>[209]</sup> option. Alternatively, press **[Ctrl]+[C]**.

The clipboard now contains the path to the selected item in the **Team Review**. You can paste the path into a document or file to add the discussion to any text concerning the item.

### 3.4.3.12 Team Review Options

To change the loading behavior of the **Team Review**, right-click on the **Team Review** window and select the **Options** context menu option. The **Team Review Server Options** dialog displays.

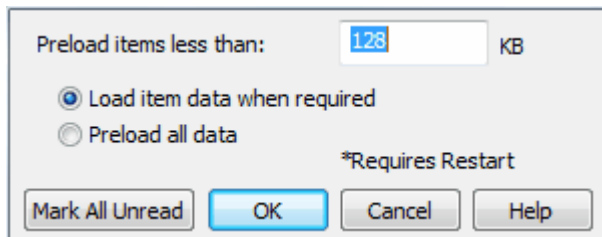

From here you can:

- **Mark All Unread** - Resets all posts you have read to 'unread' (bolds all items in the **Team Review**)
- **Load item data when required** - The fastest loading option; **Team Review** data is only loaded on demand - for example, when you read a post
- **Preload all data** - Caches the entire contents of the **Team Review** on load; this takes longer to load but, once completed, navigating the **Team Review** is faster.

### 3.4.3.13 Team Review Connections

The **Connections** option enables you to access other Team Reviews from other Enterprise Architect models, including models located on servers.

There are two methods of accessing other **Team Reviews**:

- Through the **Team Review** Toolbar
- From the **Team Review** context menu options.

#### Toolbar

To switch to another Team Review via the toolbar, follow the steps below:

1. Click on the drop-down arrow in the **Connection Options** field in the toolbar.
2. Select the appropriate model name from the list to connect to the **Team Review** for that model.
3. If the required model is not listed, click on the **<Configure Connections>** option. The **Team Review Server Connections** dialog displays.
4. Go to step [4](#) <sup>[219]</sup> of the procedure below.

#### Context Menu Option

To switch to another Team Review via the **Team Review** context menu, follow the steps below:

1. Right-click anywhere in the **Team Review** window and select the **Connections** context menu option. The **Team Review Server Connections** dialog displays.

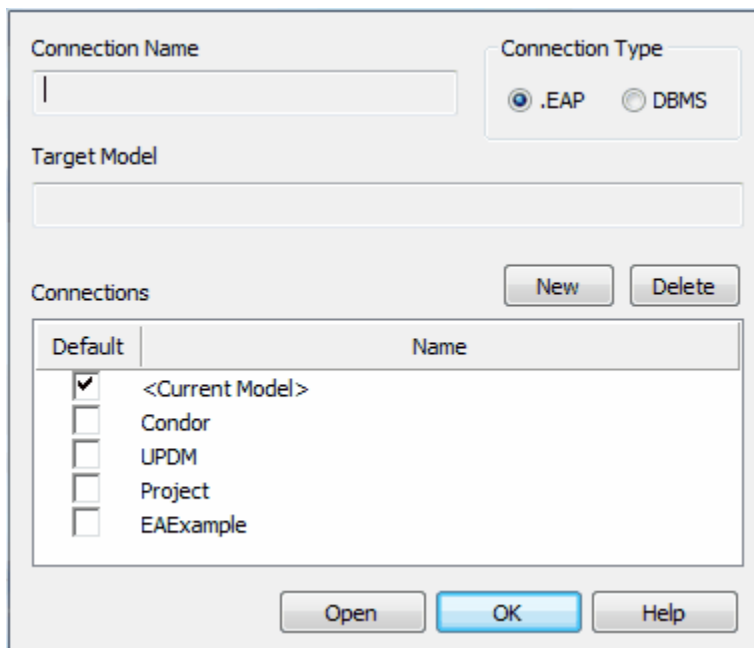

2. In the list in the **Connections** panel, select the check box against the appropriate model name to connect to the **Team Review** for that model.
3. Click on the **Open** button. The connection now switches to the **Team Review** in the selected model.
4. If the required model is not listed, select the appropriate **Connection Type** radio button and click on the **New** button.
  - For a .eap file, a browser dialog displays through which you can search for and select the appropriate model.
  - For a model in a DBMS data repository, the Microsoft **Data Link** dialogs display, which enable you to locate and connect to the repository.
5. When you have selected and opened or connected to the required Enterprise Architect model, and returned to the **Team Review Server Connections** dialog, the model name displays in the **Connection Name** field and in the **Connections** panel.
6. Select the check box against the model name and click on the **Open** button to connect to the **Team Review** for that model.

The **Team Review** now shows the discussion in the selected model.

For further details of the fields and buttons on the **Team Review Server Connections** dialog, refer to the table below.

Option	Use To
<b>Connection Name</b>	Verify the name of the selected model.
<b>Connection Type</b>	Specify the type of Enterprise Architect model: a local .EAP file (as above) or a model on a <a href="#">remote server</a> <sup>[147]</sup> .
<b>Target Model</b>	Verify the path to the selected model.
<b>New</b>	Create a new <b>Team Review</b> connection.
<b>Delete</b>	Delete the currently selected connection from the <b>Connections</b> list.
<b>Connections</b>	List all <b>Team Review</b> connections created. Click on the checkbox against the required connection.
<b>Open</b>	Switch the <b>Team Review</b> to the one selected in the <b>Connections</b> list.

### 3.4.4 Workflow Scripts

Enterprise Architect enables you to create [workflow scripts](#) that provide a robust approach to applying company policy and strengthening project development guidelines, by validating against the policy and procedures within the model itself.

#### Note:

In the Corporate, Business and Software Engineering, System Engineering and Ultimate editions of Enterprise Architect, if security is enabled you must have [Admin Workflow](#) permission to develop and manage workflow scripts.

### Project Governance

Good corporate governance relies on well written and transparent project development guidelines and company policy. A project might be compromised if the appropriate policies and procedures are poorly understood and not followed correctly - effective governance can be hampered by human error and the costs of recovering from the inadequate compliance of developers.

Company policy and procedures can be integrated with the development process to manage work flows, determine access rights, extend role based security permissions and respond to property change events. This approach reduces compliance costs, enhances collaborative development and gives you confidence that projects are being developed correctly the first time around. Development teams can adhere to best practice guidelines that govern model validation, change management, access controls and general development principles.

Project administrators can write scripts to manage the way users interact with a model, such as managing security, staff compliance and model access, and monitoring changes made by users. Administrators can also use workflow scripts to control a user's capacity to change a model element, taking into account factors such as access rights, group membership and even the value of a proposed change.

When a model is launched, the Workflow Engine is initialized with the current user and group memberships. This information determines who can access and modify parts of a given model. When a selected event occurs, the script engine is initialized with values including the author's name and access rights, and the element name and version details. The workflow script implements rules governing change management, access control and model validation. If a user attempts to make changes in violation of company policy, the script denies the update. The user is notified why the validation failed and the activity is logged. These reminders help to reinforce company policy, reduce human error and provide management with valuable project feedback.

#### 3.4.4.1 Workflow Script Functions

Workflow scripts are executed by the Enterprise Architect workflow engine, to manage user input. You write the scripts in the [Scripter](#) window, in VBScript, under the [Workflow group type](#).

#### Note:

If you make changes to a workflow script listed in the [Scripter](#) window, click on the **Refresh Scripts** button in the [Scripter](#) window toolbar to reload the script with the changes.

### Functions Enterprise Architect Calls to Validate and Control User Input

For each of the following functions that Enterprise Architect calls, a set of [objects](#) are filled.

Function	Use to...	Return Value
<b>AllowPhaseUpdate(OldValue, NewValue)</b>	Validate a change a user has made to a phase.	<ul style="list-style-type: none"> <li>• <b>True</b> to allow this user to make this change.</li> <li>• <b>False</b> to disallow the change and revert to the previous value.</li> </ul>
<b>AllowStatusUpdate(OldValue, NewValue)</b>	Validate a change a user has made to a status.	
<b>AllowTagUpdate(TagName, OldValue, NewValue)</b>	Validate a change a user has made to a Tagged Value.	
<b>AllowVersionUpdate(OldValue)</b>	Validate a change a user has	



Function	Use to...	Return Value
, NewValue)	made to a version.	
CanEditPhase()	Enable or disable the control for editing a phase.	<ul style="list-style-type: none"> <li>• <b>True</b> to allow this user to make changes by enabling the control.</li> <li>• <b>False</b> to completely disable edit of this property by disabling the control.</li> </ul>
CanEditStatus()	Enable or disable the control for editing a status.	
CanEditTag(TagName)	Enable or disable the control for editing a Tagged Value.	
CanEditVersion()	Enable or disable the control for editing a version.	
PreAllowPhaseUpdate(OldValue, NewValue)	Determine what information is required to validate this change.	Semi-colon separated list of additional data required in order to validate this change. See the list of <a href="#">supported data types</a> <sup>[22†]</sup> .
PreAllowStatusUpdate(OldValue, NewValue)		
PreAllowTagUpdate(TagName, OldValue, NewValue)		
PreAllowVersionUpdate(OldValue, NewValue)		

### Functions Enterprise Architect Calls to Create a Search With User Tasks

Function	Use to...	Return Value
GetWorkflowTasks	Describe the searches that this user must run.	Ignored

### Supported Data Types

**Tests** - fill the *Tests* array in the *WorkflowContext* object.

### Workflow Data Structures - Objects Enterprise Architect Fills

#### WorkflowUser

This object provides information about the user currently logged in to the model. It is filled by Enterprise Architect before any function is called by Enterprise Architect. It has the following properties:

- **Username** - the username for login to the system (if using Windows Authentication, this matches the Windows username)
- **Firstname** - as found in the [Security Users](#)<sup>[19†]</sup> dialog
- **Surname** - as found in the [Security Users](#) dialog
- **Fullname** - the combination <Firstname> <Surname> (the form Enterprise Architect uses for **Author** fields and similar).

This object also calls the following function:

Function	Use to...	Return Value
IsMemberOf(GroupName)	Check group membership of the current user.	<b>True</b> if the current user is a member of the group with the specified name.

#### WorkflowContext

This object provides information about the object currently in context. It is filled by Enterprise Architect before any searches except [GetWorkflowTasks](#)<sup>[22†]</sup> are run. It has the following properties:

- **MetaType** - the type of the current object, either an Enterprise Architect core type or a profile-specified metatype
- **Name** - as found in the object **Properties** dialog
- **Status** - as found in the object **Properties** dialog
- **Phase** - as found in the object **Properties** dialog
- **Version** - as found in the object **Properties** dialog
- **GUID** - the GUID of the object
- **Stereotypes** - an array of strings for the stereotypes applied to this object
- **Tags** - an array of Tagged Values, providing:
  - **Name** - the Tagged Value name
  - **Value** - the Tagged Value value
- **Tests** - an array of tests; only filled during an *Allow\** call after the *PreAllow\** call has specified that tests are required. Provides the following details, as found in the [Testing](#) [1537] window:
  - **Name**
  - **Status**
  - **RunBy**
  - **CheckedBy**
  - **TestClass**
  - **TestType**

The WorkflowContext object also calls the following function:

Function	Use to...	Return Value
<b>TagValue(TagName)</b>	Get the value from a named tag.	Returns the value of the first Tagged Value with that name, or an empty string if no Tagged Value with that name exists.

## Workflow Data Structures - Objects You Can Fill

### WorkflowStatus

Use this to provide information on the status of the object.

- **LogEntry** - set to **True** or **False**, to indicate whether a log item should be recorded
- **Reason** - indicate what reason should be recorded in the log
- **Action** - indicate how to display the log message; valid values are: **MessageBox**, **StatusBar**, **Output** (default).

### WorkflowSearches

Provides an array of searches. Use **Redim WorkflowSearches(x)** to specify the number of searches being provided. Each search has the following attributes:

- **Name** - the name of this search
- **Group** - the name of the group that this search should appear under in the **Search** combo box
- **ID** - the unique GUID for this search
- **Tasks** - the array of tasks that this search looks for; an entry describes how to find all objects required to meet a particular task:
  - **Name** - the name of the task, as displayed in the **Search** view; workflow searches are grouped by this field by default
  - **Conditions** - an array of conditions, all of which must be matched for an object to be included in this task; a condition is a comparison of a single field to a value:
    - **Column** - the name of the field
    - **Operator** - operator types, either = (provide matching values only) or <> (provide non-matching values only)
    - **Value** - if this contains a comma, the string is treated as a comma separated list of values to compare against; otherwise the string is a single value to compare against.

## Functions Enterprise Architect Provides For You to Call

Enterprise Architect provides the subfunction **SetLastError( message, outputMethod )** for you to call, to log and/or report the provided message to the user.

You can also call the following functions:

Function	Use to...	Return Value
<b>NewSearch(name, group, guid, taskcount)</b>	Create a new search object to be included in WorkflowSearches. Initializes each member.	The created search.
<b>NewTask(name, conditioncount)</b>	Create a new task object to be included in a search. Initializes each member.	The created task.
<b>NewCondition(column, operator, value)</b>	Create a new condition object to be included in a task. Initializes each member.	The created condition.

### 3.4.5 Sharing Reference Data

[Reference data](#) <sup>[644]</sup> (including Glossary and Issue information) can be exported to and imported from .XML files for convenient update of models.

You can [automatically](#) <sup>[226]</sup> or [manually](#) <sup>[225]</sup> import data into the model from a reference data .XML file, [exported](#) <sup>[223]</sup> from another model or an iteration of the current model. The automatic import is conditional on there being changes to the source file since the last import, but you can also configure Enterprise Architect to display a prompt for you to allow or cancel the import.

Examples of where exporting and importing reference data can be useful include:

- Copying glossaries from one model to another
- Adding additional stereotype profiles by merging new stereotypes into the model
- Updating reference data from files supplied by Sparx Systems as a maintenance release
- Copying resources, clients and so on from one model to another.

#### 3.4.5.1 Export Reference Data

When reference and project data is exported, Enterprise Architect writes it out to a custom XML file. This includes table information, filter information, rows and columns.

#### Procedure

To export data, follow the steps below:

1. Select the **Tools | Export Reference Data** menu option. The **Data Exporter** dialog displays.

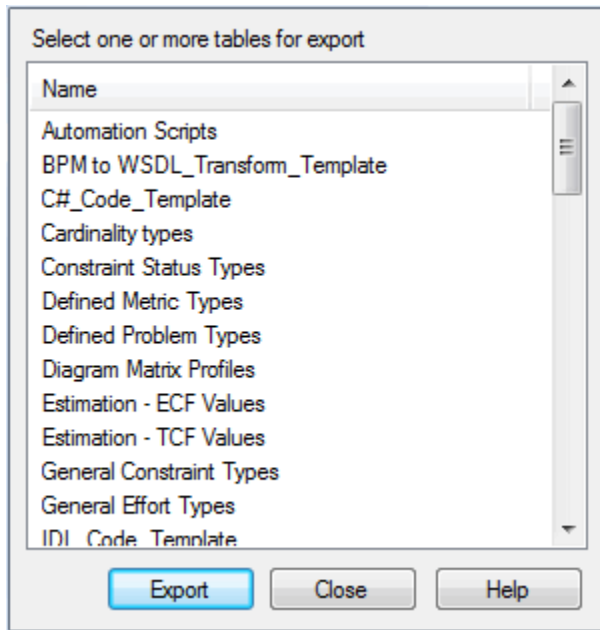

2. From the **Name** list, select the table to export. You can select one or more tables for a single file.
  3. Click on the **Export** button.
  4. When prompted to do so, enter a valid file name with a .XML extension.
- This exports the data to the file. You can use any text or XML viewer to examine this file.

The data exported includes all instances of the data type in the project; for example, all defined cardinality values, or all RTF Style Templates.

**Note:**

If there are no instances of a selected data type in the project, the export does not generate any output for that data type in the XML file.

For information on each category of data you can export, refer to the following topics:

- [ActionScript Code Templates](#)<sup>[1302]</sup>; entries for code templates are listed only if templates for a particular language exist in the model. The list entry has the format <language\_name>\_Code\_Templates.
- [Automation Scripts](#)<sup>[1660]</sup> (JavaScript, JScript and VBScript)
- [Cardinality Types](#)<sup>[665]</sup>
- [Constraint Status Types](#)<sup>[656]</sup>
- [CSV](#)<sup>[300]</sup> Specifications
- [Defined Metric Types](#)<sup>[320]</sup>
- [Defined Problem Types](#)<sup>[660]</sup>
- [Diagram Matrix Profiles](#)<sup>[444]</sup> (Model Profiles)
- [Estimation - Environment Complexity Factor Values](#)<sup>[337]</sup>
- [Estimation - Technical Complexity Factor Values](#)<sup>[336]</sup>
- [General Constraint Types](#)<sup>[655]</sup>
- [General Effort Types](#)<sup>[319]</sup>
- [Import Component Types](#)<sup>[1337]</sup>
- [Linked Document Templates](#)<sup>[603]</sup>
- [Macro List](#)<sup>[1344]</sup> (Preprocessor macros)
- [Maintenance Types](#)<sup>[660]</sup> (both Problem Types and Test Types)
- [Model Authors](#)<sup>[645]</sup>
- Model Data Types - [Code](#)<sup>[666]</sup> and [DDL](#)<sup>[1367]</sup>
- [Model Images](#)<sup>[447]</sup>
- [Project Clients](#)<sup>[651]</sup>
- [Project Glossary](#)<sup>[323]</sup>
- [Project Issues](#)<sup>[331]</sup>

- [Project Resources](#) <sup>[650]</sup>
- [Project Roles](#) <sup>[648]</sup>
- [Project Tasks](#) <sup>[329]</sup>
- [Property Types](#) <sup>[1168]</sup> (Tagged Value Types)
- [Risk Types](#) <sup>[322]</sup>
- [Scenario Types](#) <sup>[658]</sup>
- [Security - Group Permission](#) <sup>[197]</sup>
- [Security - Groups](#) <sup>[197]</sup>
- [Security User Groups](#) <sup>[194]</sup>
- [Security - User Permissions](#) <sup>[195]</sup>
- [Security - Users](#) <sup>[197]</sup>
- Standard Complexity Types - currently, these cannot be directly edited and are therefore effectively standard for all models; they can be listed using the [Predefined Reference Data Tagged Value type](#) <sup>[1169]</sup> *ComplexityTypes*.
- [Status Colors](#) <sup>[653]</sup> (the colors defined for status types)
- [Status Types](#) <sup>[653]</sup>
- [Status - Applies To](#) <sup>[653]</sup> (elements to which the status can be applied)
- [Stereotypes](#) <sup>[1093]</sup> (all those listed on the [Stereotypes](#) page of the [UML Types](#) dialog)
- Templates - HTML Style (exports the [web templates](#) <sup>[1649]</sup> listed in the *Templates* folder of the [Resources](#) window)
- Templates - HTML Style Detail (exports the content of the HTML report templates)
- Templates - RTF Document (exports the [Extended RTF Style templates](#) <sup>[1578]</sup> in the *Templates* folder of the [Resources](#) window)
- Templates - RTF Style (exports [the Legacy RTF Style templates](#) <sup>[1634]</sup> in the *Templates* folder of the [Resources](#) window)
- Templates - RTF Style Detail (exports the content of the RTF templates)
- Templates - RTF Tag and Language Options (exports RTF [word substitution](#) <sup>[1637]</sup> templates)
- [Test Types](#) <sup>[667]</sup>

### 3.4.5.2 Import Reference Data

You can import reference data into your model in Enterprise Architect, from a reference data .xml file exported from another model or from an iteration of the current model, either:

- [Manually](#) <sup>[225]</sup>, as required, whenever you know there is new or changed data to apply, or
- [Automatically](#) <sup>[226]</sup> whenever the model is reloaded into Enterprise Architect (if the file has changed since the previous import).

When you import data into Enterprise Architect, the system merges the incoming data with the existing data. If a record already exists it is updated to the new values. If the record does not exist, Enterprise Architect adds a new record. Enterprise Architect never deletes records.

For a list and explanation of the data types you could import, see the [Export Reference Data](#) <sup>[223]</sup> topic.

### Import Data Manually

To import data manually, follow the steps below:

1. Select the **Tools | Import Reference Data** menu option. The [Import Reference Data](#) dialog displays.

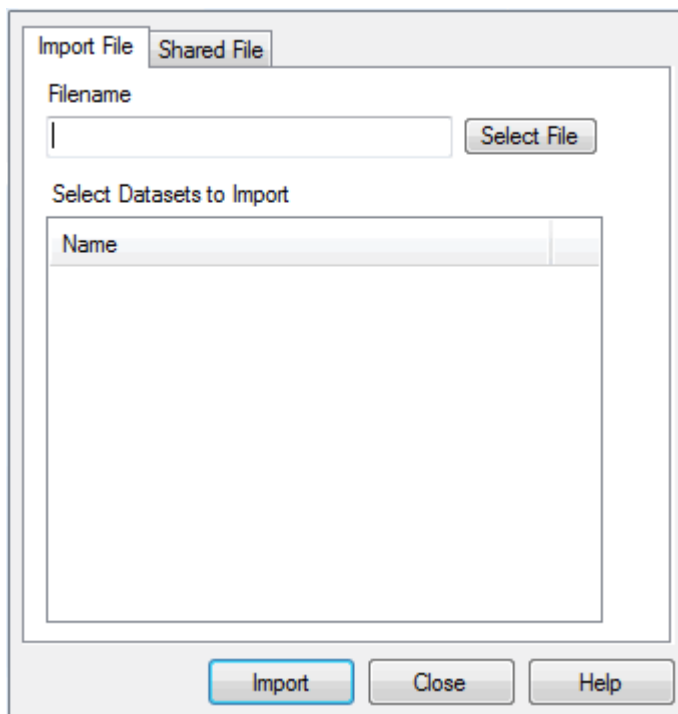

2. Click on the **Import File** tab and on the **Select File** button, then select the filename to import data from. This must be an XML file produced by the Enterprise Architect [Data Exporter](#)<sup>[223]</sup>.
3. If you have entered the name of a valid file, a list of available tables to import displays in the **Select Datasets to Import** panel.
4. Click on one or more of the tables to import (press **[Ctrl]** or **[Shift]** to click on multiple tables).
5. Click on the **Import** button to start the process. A message displays when the import is complete. Generally the process is quite fast.

### Import Data Automatically

The automatic import checks if the source file has changed since the last import; if the file has not changed, the import does not proceed. If the file has changed the changed data is imported; however, you can configure Enterprise Architect to display a prompt for you to allow or cancel the import.

To set up the system to check and import reference data automatically whenever your model is reloaded into Enterprise Architect, follow the steps below:

1. Select the **Tools | Import Reference Data** menu option. The **Import Reference Data** dialog displays. Click on the **Shared File** tab.

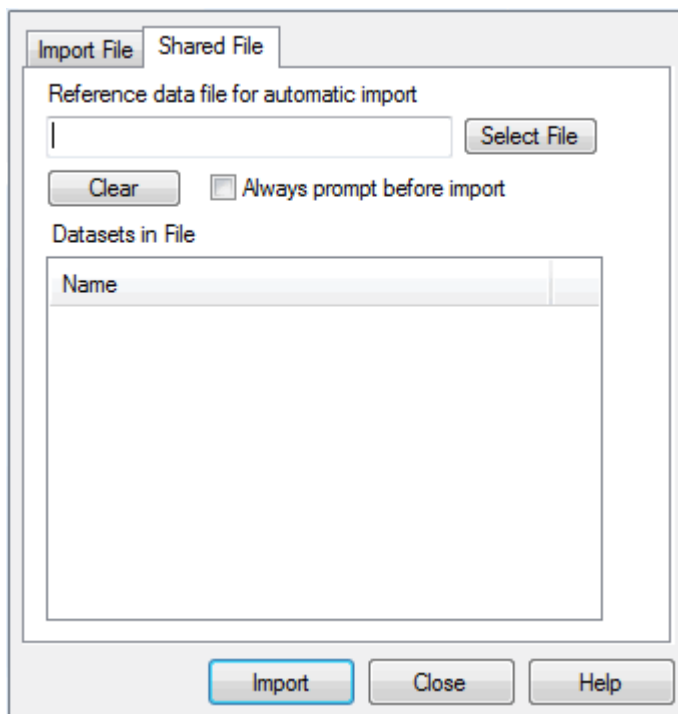

2. If you are changing an existing configuration to import from a different .XML file, click on the **Clear** button to clear the dialog fields.
3. Click on the **Select File** button and browse for the filename to import data from. This must be an XML file produced by the Enterprise Architect [Data Exporter](#)<sup>[223]</sup>.
4. If you have entered the name of a valid file, a list of tables to import displays in the **Datasets in File** panel.
5. If you prefer to control whether or not the automatic import takes place, select the **Always prompt before import** checkbox.
6. Click on the **Import** button to import the reference data now, and to enable the automatic check and import for subsequent reloads.

## 3.5 Change Management

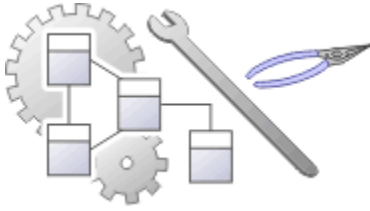

This section describes the tools and facilities for controlling and monitoring changes to the data in a project.

In Change Management, you configure and maintain:

- Version Control of packages
- Tracking changes
- The transfer of data between projects in similar or different databases

### Version Control For Models

Enterprise Architect Model [version control](#)<sup>[228]</sup> enables you to:

- Coordinate sharing of packages between users, with either read-only access or update access, ensuring that work on different areas of the model is coordinated and synchronous rather than conflicting
- Save and retrieve a history of changes to packages.

To use version control in Enterprise Architect, you require a third-party source-code control application such as *Subversion*, *CVS*, or any other version control product that complies with the Microsoft Common Source Code Control standard.

### Tracking Changes

Enterprise Architect provides two separate but complementary facilities for [tracking changes](#)<sup>[269]</sup> to data across the project:

- Auditing of model changes
- Baselining and differencing to capture and roll back changes

### Project Data Transfer

Enterprise Architect enables you to [transfer project data](#)<sup>[306]</sup> between project data repositories, row by row, table by table.

#### Note:

This feature is available in the Corporate, Business and Software Engineering, Systems Engineering and Ultimate editions.

#### See Also

- [Project Data Integrity](#)<sup>[344]</sup>
- [Model Maintenance](#)<sup>[344]</sup>
- [Team Development](#)<sup>[182]</sup>
- [Spell Checking](#)<sup>[1552]</sup>
- [Reference Data](#)<sup>[644]</sup>
- [Upgrading Projects](#)<sup>[346]</sup>

### 3.5.1 Version Control

Enterprise Architect supports version control of packages and their component sub-packages to a central version control repository. You can place any individual packages, View nodes or model root nodes under version control.

To read a discussion on why you would use Version Control in Enterprise Architect, the benefits it brings and how you might apply it, see the [Version Control Best Practices for Enterprise Architect](#) white paper.



## Features

Version Control provides two key facilities:

- Coordinating sharing of packages between users
- Saving a history of changes to Enterprise Architect packages, including the ability to retrieve previous versions.

### See Also

- [Introduction](#) <sup>[229]</sup>
- [Version Control Setup](#) <sup>[233]</sup>
- [Use Version Control](#) <sup>[256]</sup>

### 3.5.1.1 Introduction

This section discusses some factors you should consider when setting up and using version control in your model development, including:

- [System Requirements and Configuration](#) <sup>[229]</sup>
- [Version Control Usage](#) <sup>[230]</sup>
- [Version Control Basics](#) <sup>[230]</sup>
- [Version Control and Reference Data](#) <sup>[231]</sup>
- [Applying Version Control to Models](#) <sup>[231]</sup>
- [Version Control & Team Deployment](#) <sup>[232]</sup>
- [Project Browser Indicators](#) <sup>[233]</sup>

#### 3.5.1.1.1 System Requirements and Configuration

Version controlled packages are packages that have been configured for use with version control software.

To use version control in Enterprise Architect, a third-party source-code control application is required that controls access to and stores revisions of the controlled packages. Enterprise Architect supports the following version control applications:

- Subversion, which is available from <http://www.subversion.tigris.org/>
- CVS, which is available from <http://www.march-hare.com/cvsp/ro/>
- Microsoft Team Foundation Server
- SCC-compatible products; all version control products that provide a client that complies with the Microsoft Common Source Code Control standard, version 1.1 or higher.

The following products are SCC-compatible and are known to successfully integrate with Enterprise Architect:

- Accurev	Tested by Sparx	
- Borland Star Teams		Users report success
- ClearCase		Users report success
- MS Visual Source Safe	Tested by Sparx	
- MS TFS-SCC	Tested by Sparx	
- MKS Source Integrity	Tested by Sparx	
- Perforce	Tested by Sparx	
- Serena Dimensions		Users report success
- Serena Change Manager		Users report success
- Snapshot CM	Tested by Sparx	
- SourceGear Vault	Tested by Sparx	
- Source Offsite	Tested by Sparx	

Products that do not appear in the list should still integrate successfully with Enterprise Architect, if there is a client available for that product that complies with the MS SCC API specification.

## Configuration

Before using Enterprise Architect's version control facility, your version control software must be installed on each machine on which it is intended to be used.

Typically there are:

- A server component that manages a version control repository, and
- Client components on the workstations that Enterprise Architect uses to communicate with the server.

A version control client must be installed on every machine where you run Enterprise Architect and want to access your version control system. Once the version control software has been installed and configured, you must define a Version Control Configuration within Enterprise Architect, to use your installed version control product.

### Note:

Sparx Systems strongly urge you not to manipulate version controlled package files outside of Enterprise Architect. It is possible to leave the package files in a state that Enterprise Architect cannot recognize.

### 3.5.1.1.2 Version Control Usage

There are four basic ways in which the version control facility might be used:

Use	Description
Single Shared model	Users share an Enterprise Architect model, stored in a central .EAP file or DBMS repository. This configuration enables you to view changes to other users' packages without explicitly having to check them out, but by simply refreshing your view of the model. <ul style="list-style-type: none"> <li>• Version control regulates access to packages, and maintains package revision history.</li> </ul>
Multiple Private models	An Enterprise Architect model is created by a single user who configures it for version control. The model file is then distributed to other users, with each user storing their own private copy of the model. <ul style="list-style-type: none"> <li>• Users update their model's packages through version control</li> <li>• Version control regulates access to packages, and maintains package revision history</li> <li>• Other users' new packages are retrieved using the <b>Get Package</b> menu option.</li> </ul>
Shared packages	Individual users create separate Enterprise Architect models but share one or more packages. <ul style="list-style-type: none"> <li>• Users share packages through version control.</li> </ul>
Standard packages	A company might have a standard set of packages which are broadly shared (on a read-only basis). <ul style="list-style-type: none"> <li>• Individual users retrieve packages with the <b>Get Package</b> menu option.</li> </ul>

For a discussion of how each of these arrangements might be used, see the [Version Control Best Practices for Enterprise Architect](#) white paper.

### 3.5.1.1.3 Version Control Basics

#### The Lock-Modify-Unlock Solution

Many version control systems use a lock-modify-unlock model to address the problem of different authors in a shared source overwriting each other's work.

In this model, the version control repository allows only one person to change a file at a time, and access is managed using locks. Harry must lock a file before he can begin making changes to it. If Harry has locked a file, Sally cannot also lock it, and therefore cannot make any changes to that file. All she can do is read the file, and wait for Harry to finish his changes and release the lock. After Harry unlocks the file, Sally can take her turn in locking and editing the file.

## The Copy-Modify-Merge Solution

Subversion, CVS and a number of other version control systems use a copy-modify-merge model as an alternative to locking.

In this model, each user's client contacts the project repository and creates a personal working copy—a local reflection of the repository's files and directories. Users then work simultaneously and independently, modifying their private copies. In due course, the private copies are merged together into a new, final version. The version control system often assists with the merging, but ultimately a person is responsible for making it happen correctly.

## When Locking is Necessary

While the lock-modify-unlock model is generally considered a hindrance to collaboration, there are still times when locking is necessary.

The copy-modify-merge model is based on the assumption that files are contextually merge-able: that is, the files in the repository are line-based text files (such as program source code). But for files with binary formats, such as artwork or sound, it is often impossible to merge conflicting changes. In these situations, it really is necessary for users to take strict turns in changing the file. Without serialized access, somebody ends up wasting time on changes that are ultimately discarded.

### 3.5.1.1.4 Version Control and Reference Data

[Reference data](#)<sup>[644]</sup> is data that is used across a model or project; it is not package-specific.

Version control in Enterprise Architect operates at package level, and therefore does not capture changes in reference data. Where version control is used in a [shared packages](#)<sup>[230]</sup> or [multiple private model](#)<sup>[230]</sup> set up, changes in reference data are not brought into the model when the package is checked in.

To ensure that changes in reference data are shared between users in a version-controlled project, you should periodically [export](#)<sup>[223]</sup> the reference data from the model where the changes were made, and [import](#)<sup>[225]</sup> it into the other models maintained by the team.

#### Note:

Reference data is exported and imported as an XMI file, which contains whatever types of reference data you want to transfer (see the list of data types in the [Export Reference Data](#)<sup>[223]</sup> topic).

It might be useful to include, in your project management processes, version-control of this XMI file through your version control software, *external to* Enterprise Architect.

### 3.5.1.1.5 Apply Version Control To Models

All Enterprise Architect models are stored in databases - even the .EAP file is an MS Jet database.

In simple, version control terms, the model is a single entity of binary data. It is not practical to apply version control to the database as a whole. Being binary data, it would require the use of the [lock-modify-unlock model](#)<sup>[230]</sup> of version control, which would mean that only a single user at a time could work on any given (version controlled) model.

To overcome this limitation, Enterprise Architect exports discreet units of the model - the packages - as XMI package files, and it is these XMI files, not the .EAP file, that are placed under version control. The XMI file format used by Enterprise Architect dictates that they too be treated as binary files (therefore it is not possible to merge the XMI files either); however, by splitting the model into much smaller parts, this approach enables many users to work on separate parts of the model simultaneously.

When a user [checks-out](#)<sup>[261]</sup> a package, Enterprise Architect sends a command to the version control system to check-out the equivalent XMI file. The version control system then puts the latest revision of the file into the user's working copy directory, overwriting any previous revision of the file in that directory. Enterprise Architect then imports the package file into the model, updating the contents of the existing package in the model.

When [checking-in](#)<sup>[261]</sup>, Enterprise Architect exports the package as an XMI file, overwriting the existing local working copy of the file. The new file is then checked-in to the version control system.

## Nested Version Controlled Packages

Nested version controlled packages result in much smaller XMI files being exported for parent packages, as the parent packages' XMI files do not contain any content for the version controlled child packages.

[Version Control of nested packages](#)<sup>[236]</sup> together with a model structure having small individual packages also provides greater scope for multiple users to work concurrently, as individual users are locking much smaller parts of the model.

#### Notes:

- **Do not place your .EAP files under version control**, as this creates problems for you.
- Most version control systems mark their controlled files as read only, unless they are specifically checked-out to you.
- The .EAP file is an MS Jet database, and Enterprise Architect **must** be able to open this file for read/write access when you load your model. (Enterprise Architect displays an error message and fails to load the model if it is read-only.)

### 3.5.1.1.6 Version Control & Team Deployment

Team deployment and the use of version control is discussed in two Sparx Systems white papers, available on the Sparx Systems web site:

- [Version Control Best Practices for Enterprise Architect](#)
- [Deployment of Enterprise Architect](#)

A brief summary of the process is provided below:

1. Install your version control product.
2. Create a version control repository.
3. Create a version control project to be used with your Enterprise Architect project, and check-out a working copy of the project into a local folder. (You must do this for every team member that is accessing the version controlled packages, whether you are using a single shared model or each team member stores his own private copy of the model.)
4. Within Enterprise Architect, [define a version control configuration](#)<sup>[233]</sup> to provide access to the working copy files. Again, each user must do this on their own workstation, as the details are stored within the Windows registry.
5. [Configure packages](#)<sup>[259]</sup> within the Enterprise Architect model for version control. That is, apply version control to individual packages.
6. [Check-out and check-in packages](#)<sup>[261]</sup> as required.

#### Note:

The name of the version control configuration must be the same across all machines. That is, all version control access to a given Enterprise Architect package must be through version control configurations with the same name, across all models and all users. (It is possible to use multiple version control configurations within the same model, so different packages can still use different version control configurations within the same model, as long as any given package is always accessed via the same version control configuration.)

The easiest way to perform step 4, (throughout the team), is to have one user set up version control on the model and then share that model with the rest of the team.

- In Shared Model deployment, all users connect to a single instance of the model database, so the model is shared automatically.
- In Private Model deployment, it is easiest to distribute copies of the original model (after version control has been set up) to all other members of the team.

Whenever you open a model ([Private or Shared](#)<sup>[230]</sup>) that uses a version control configuration that is not yet defined on your workstation, Enterprise Architect prompts you to complete the definition for that configuration. This typically means specifying the local working copy directory and maybe choosing the version control project associated with this Enterprise Architect project.

Once this has been done, the version controlled packages that already exist in the model are ready for use.





## Version Control Branching

Currently, Enterprise Architect does not support Version Control Branching. Work-arounds to achieve similar results might be possible for certain version-control products; contact Sparx Support for advice:

- Registered users - [http://www.sparxsystems.com/registered/reg\\_support.html](http://www.sparxsystems.com/registered/reg_support.html)
- Trial users - [support@sparxsystems.com](mailto:support@sparxsystems.com).

### 3.5.1.1.7 Project Browser Indicators

Packages under version control are identified in the **Project Browser** by icons that indicate the current status of the package.

Icon	Indicates that...
	This package is <a href="#">controlled</a> <sup>[293]</sup> and is represented by an XML file on disk. Version control either is not being used or is not available. You can edit the package.
	This package is version controlled and <a href="#">checked out</a> <sup>[261]</sup> to you, therefore you can edit the package.
	This package is version controlled and not checked out to you, therefore you cannot edit the package (unless you check the package out).
	This package is version controlled, but you checked it out whilst <a href="#">not connected to the version control</a> <sup>[268]</sup> server. You can edit the package but there could be version conflicts when you check the package in again.

For example, below, *CVS00* and *CVSPackage* are configured for version control. *CVS00* is checked out to you, and *CVSPackage* is not.



### 3.5.1.2 Version Control Setup

Before using Enterprise Architect's version control facility, your version control product must be installed on each machine where it is intended to be used.

Version Control products supported by Enterprise Architect include MS Team Foundation Server, Subversion, CVS or any other version control product that provides an MS SCC-compliant interface.

- Subversion is available from <http://www.subversion.tigris.org/>
- CVS is available from <http://www.wincvs.org/>.

**Note:**

If you are using the Corporate, Business and Software Engineering, System Engineering or Ultimate editions of Enterprise Architect with security enabled, you must also set up permissions to configure and use version control. See the [List of Available Permissions](#)<sup>[199]</sup> topic for further information.

Typically there should be:

- A server component that manages a version control repository
- Client components on the workstations that Enterprise Architect uses to communicate with the server.

A version control client must be installed on every machine where you run Enterprise Architect and want to access your version control system. Once the version control software has been installed and configured, to use your installed version control product you must define a Version Control Configuration within Enterprise Architect.

Version control can be assigned to individual packages, view nodes or root nodes in Enterprise Architect. Each package can only be linked to one Version Control Configuration at a time, although it is possible to connect multiple control configurations for each model. You can use the **Version Control Settings** dialog to set up a connection to your version control application.

To set the Version Control Configuration, select the **Project | Version Control | Version Control Settings** menu option, and see the [Version Control Settings Dialog](#)<sup>[234]</sup> topic.

**See Also**

- [Version Control with SCC](#)<sup>[236]</sup>
- [Version Control with CVS](#)<sup>[240]</sup>

- [Version Control with Subversion](#) <sup>[247]</sup>
- [Version Control with TFS](#) <sup>[253]</sup>

### 3.5.1.2.1 Version Control Settings Dialog

The **Version Control Settings** dialog enables you to specify the information required to create a Version Control Configuration, which can then be used to establish a connection to a version control provider.

Enterprise Architect supports version control through MS Team Foundation Server, Subversion, CVS or any SCC-compliant version control product.

It is possible to use multiple version control configurations in the same Enterprise Architect model. It is also possible to use the same version control configuration across different models, to facilitate sharing 'standard' packages between those models, through the version control system.

**Note:**

In the Corporate, Business and Software Engineering, System Engineering and Ultimate editions of Enterprise Architect, if security is enabled you must have **Configure Version Control** <sup>[198]</sup> permission to set up version control options for the current model.

### Setting Up Version Control

When you display the **Version Control Settings** dialog for the first time in any given model, it appears as shown below:

**Model Settings**

This model is private (for Shared models, it is best to disable this check box)

Save nested version controlled packages to stubs only (recommended)

**Configuration Details:**

Unique ID:

Type:  SCC  CVS  Subversion  TFS

New Save Delete

**Defined Configurations:**

Unique ID	Type	Files	Location
-----------	------	-------	----------

Close Help

To begin defining a new version control configuration, follow the steps below:

1. Click on the **New** button.
2. In the **Unique ID** field, type a suitable name.
3. Against the **Type** field, click on the radio button for the version control product to connect to.

At this point, the middle section of the dialog changes to display a collection of fields relating to the type of Version Control Configuration you are defining. Go to the relevant topic below:

- [Version Control with SCC](#) <sup>[236]</sup>
- [Version Control with CVS](#) <sup>[240]</sup>
- [Version Control with Subversion](#) <sup>[247]</sup>
- [Version Control with TFS](#) <sup>[253]</sup>

To import a previously defined configuration for use in the current model, follow the steps below:

1. Click on the **New** button.
2. In the **Unique ID** field, click on the drop-down arrow and select one of the previously defined version control configurations.
3. Click on the **Save** button to save the selected version control configuration in this model.

#### See Also

- [Version Control Nested Packages](#) <sup>[236]</sup>

#### 3.5.1.2.1 Version Control Nested Packages

In releases of Enterprise Architect later than version 4.5, when you save a package to the version control system only stub information is exported for any nested packages. This ensures that information in a nested package is not inadvertently over-written by a top level package.

When checking out a package, Enterprise Architect does not modify or delete nested packages; only the top level package is modified.

As a consequence of this behavior, if you check out or get a version controlled package with nested packages not already in your model, you see stubs in the model for the nested packages only. If you select the **Get All Latest** option from the version control menu, Enterprise Architect populates these new stubs from the version control system.

Using the above technique you can populate a large and complex model from only the root packages, using **Get All Latest** to recursively iterate through the attached and nested packages.

This is a powerful and efficient means of managing your project and simplifies handling very large models, even in a distributed environment.

It is recommended you do not mix versions of Enterprise Architect later than version 4.5 with earlier versions when sharing a version controlled model. If this is necessary it is best to go to the [Version Control Settings](#) <sup>[234]</sup> dialog and deselect the **Save nested version controlled packages to stubs only** checkbox, setting Enterprise Architect to the pre-version 4.5 behavior (for the current model only).

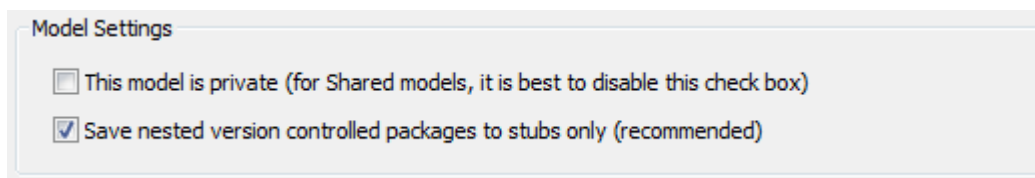

#### 3.5.1.2.2 Version Control with SCC

To set up an SCC version control configuration, you must:

- Set up the source code control provider with SCC, and
- Connect the Enterprise Architect model to version control with SCC.

See also, the topic on version control with SCC when [Upgrading at Enterprise Architect 4.5](#) <sup>[239]</sup>.

### Set Up the Source Code Control Provider with SCC

To set up the third-party source code control provider, see the documentation provided with that application. A repository must be set up using the SCC provider and access to that repository must be available to all intended users.

### Connect an Enterprise Architect Model to Version Control with SCC

To connect an Enterprise Architect model to version control, follow the steps below:

1. Open or create the Enterprise Architect model to place under version control.
2. Select the **Project | Version Control | Version Control Settings** menu option. The **Version Control Settings** dialog displays.



**Model Settings**

This model is private (for Shared models, it is best to disable this check box)

Save nested version controlled packages to stubs only (recommended)

**Configuration Details:**

Unique ID:

Type:  SCC  CVS  Subversion  TFS

New Save Delete

**Defined Configurations:**

Unique ID	Type	Files	Location
-----------	------	-------	----------

Close Help

3. Click on the **New** button.
4. In the **Unique ID** field, type a suitable name. Click on the **SCC** radio button.
5. To the right of the **Local Project** path field, click on the **Select Path...** button. The **Browse for Folder** dialog displays.

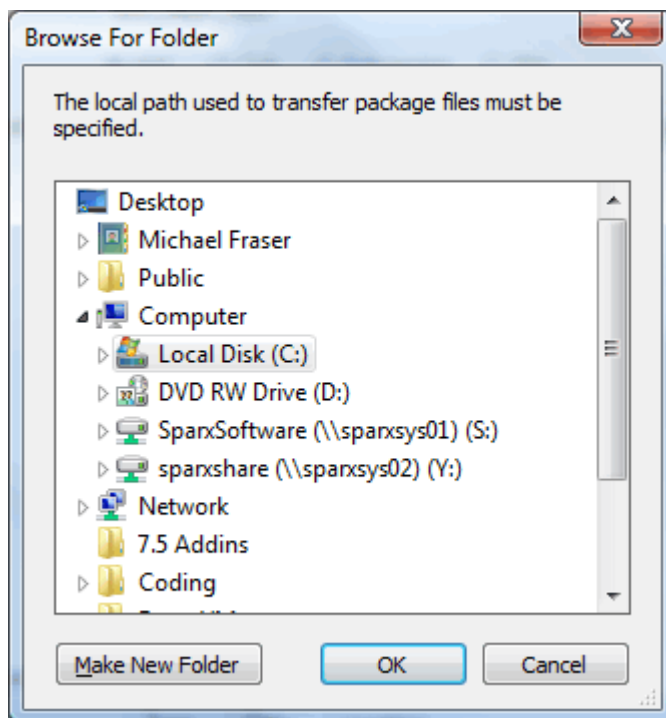

6. Locate and click on the local folder in which to keep local working copies of the XML files to be stored in the Version Control repository.
7. Click on the **OK** button. The **Select SCC Provider** dialog displays.

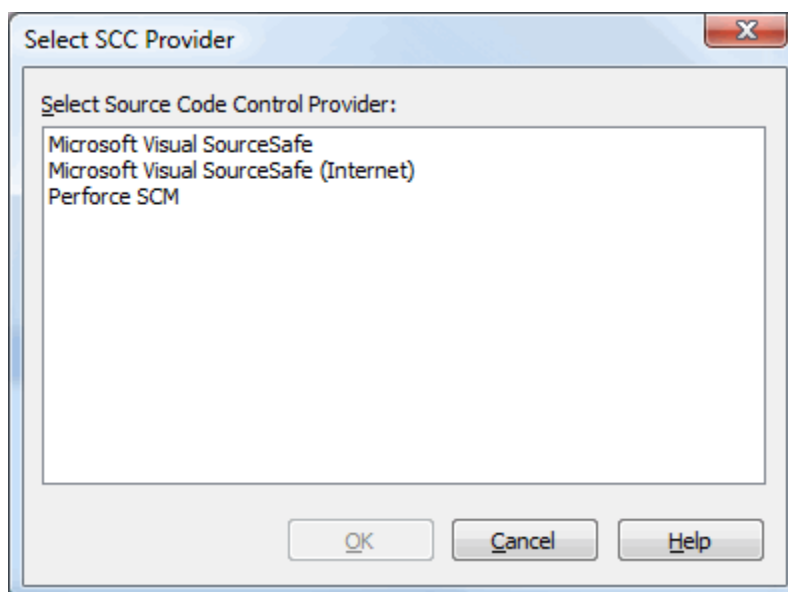
**Note:**

All users of the shared database must specify the same SCC provider.

8. Click on an SCC provider, and click on the **OK** button to return to the **Version Control Settings** dialog.
9. Click on the **Save** button to save the configuration you have defined.

The SCC provider is likely to prompt you for various details including the name of the project to connect to, and perhaps the user name to use when you log in.

10. The new configuration is added to the list in the **Defined Configurations** panel.

**Note:**

A new entry is also created in the [Local Paths](#) <sup>[1343]</sup> list, with the same ID as the new version control configuration. The **Local Path** entry records the Local Project path, for use in subsequent path substitutions.

11. When you have finished defining your version control configurations, click on the **Close** button.

For further information on the fields on the [Version Control Settings](#) dialog, see the following table.

Field	Use to
<b>This model is private</b>	Specify whether all users connect to a single shared copy of the model (for example, a DBMS) or each user connects to their own private copy of the model.  When unselected (for shared models), the option disables the <b>File History - Retrieve</b> functionality when the selected package is checked out by another user. This prevents modifications that might have been made by the other user from being discarded through importing a prior revision from version control.
<b>Save nested version controlled packages to stubs only</b>	Set nested version controlled packages to stubs or fully expanded trees. Defaults to selected.  For a full explanation of this option, see <a href="#">Version Control Nested Packages</a> <sup>[236]</sup> .
<b>Unique ID</b>	Specify a configuration name that readily distinguishes this configuration from other configurations. The unique ID is displayed as a selection in the list of Version Control configurations a package can connect to.  You can also click on the drop-down arrow and select a previous version control configuration, providing the configuration is not in the current model.
<b>Local Project Path</b>	Specify the folder in which the XML files representing the packages are stored. This folder should already exist before it is specified here.  Every PC using version control should have its own local SCC project folder, and this should not be a shared network folder. Particularly bear this in mind if you are creating a .EAP file that is to be shared (such as a SQL database).
<b>Current User</b>	Read only. Shows your user name as the user currently logged into the SCC provider.
<b>SCC Provider</b>	Read only. Shows the name of the provider specified in the database.
<b>SCC Project</b>	Read only. Shows the project selected during the initial setup of the connection to the SCC provider.

**Note:**

Sparx Systems strongly urge you not to manipulate version controlled package files outside of Enterprise Architect. It is possible to leave the package files in a state that Enterprise Architect cannot recognize.

### 3.5.1.2.2.1 Upgrade at Enterprise Architect 4.5

When a version-controlled project created under a release of Enterprise Architect earlier than 4.5 is opened in Enterprise Architect release 4.5 or later, you must identify the SCC connection with a new unique ID. You can assign a name to the existing SCC configuration or associate the project with a configuration that has previously been assigned a unique ID.

By having a unique ID for Version Control Configurations, you can assign a configuration quickly and efficiently using configurations that have been created previously for other version controlled repositories. This enables you to configure the many packages to use an existing version control repository; this can apply to packages created for more than just one model enabling a great deal of flexibility.

To upgrade an existing SCC version control project created before release 4.5, in Enterprise Architect release 4.5 or later, follow the steps below.

1. Open the project that has an SCC Version Control Configuration created in Enterprise Architect earlier than version 4.5.
2. The [Select or Create Unique ID for Version Control](#) dialog prompts you to create an ID for an existing

configuration or to choose a previously created one from the **Unique ID** drop-down list.

- The existing SCC configuration is the initial value, represented by **SCC-XXXXX**; this number is not especially meaningful, therefore it is recommended that the configuration be given a meaningful name.

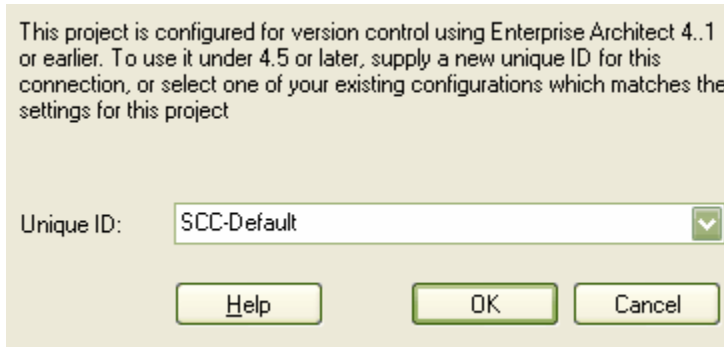

- You can associate the version controlled package with a previously-defined configuration by selecting an existing configuration from the **Unique ID** drop-down list (if one exists).

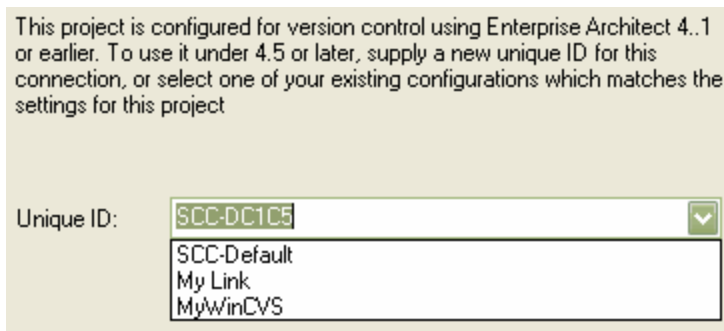

- After you have assigned the unique ID, click on the **OK** button to load the model.

### 3.5.1.2.3 Version Control with CVS

CVS is an open source, version control system, used to manage files and directories.

In order to use CVS version control with Enterprise Architect, you must install version control software on your local machine. Also, you must create a working directory (using your version control software) before you can configure Enterprise Architect. You can have as many working directories as you like on your local machine.

You must also connect to a repository, which can be either a [remote repository](#)<sup>[240]</sup> or [local](#)<sup>[244]</sup> to your machine. If your repository is local, it must be created with your version control software.

Each working folder you create contains information on connection to a repository. This connection information includes the path to the local or remote repository, the user name and password in order to make a connection.

#### Note:

To see a video demonstration of setting up a CVS repository for version control, go to [http://www.sparxsystems.com.au/resources/demos/settingupCVS/CVS\\_Final\\_1.htm](http://www.sparxsystems.com.au/resources/demos/settingupCVS/CVS_Final_1.htm).

#### 3.5.1.2.3.1 CVS with Remote Repositories

Before you can connect to a remote repository, you must:

- Have version control setup on your local machine
- Have version control setup on a remote server
- Have a working directory on your local machine that points to the repository on the server.

To set up CVS version control with a remote repository, follow the steps below:

1. Ask your system administrator to install CVS and create a remote repository with a module that you can use to control your Enterprise Architect package files. Your administrator must create a username and

password for you before you can make a connection.

2. Open a command prompt window and navigate to, or create, a suitable directory to hold your CVS working copy directory; for example:

```
C:\> cd myCVSWorkSpace
```

3. Connect to the remote CVS repository. An example connection command is:

```
C:\myCVSWorkSpace> cvs -d:pserver:myUserID@ServerName:/repositoryFolder login
```

**Note:**

Replace myUserID with your CVS username, replace ServerName with the name of your CVS server and replace repositoryFolder with the path to the repository on the server.

4. Create a local CVS workspace, derived from the remote repository. An example command is:

```
C:\myCVSWorkSpace> cvs -d:pserver:myUserID@ServerName:/cvs checkout moduleName
```

**Note:**

The above command creates a subdirectory in your current working directory, called moduleName. (Replace moduleName with the name of the module created by your system administrator). It creates local copies of all files contained in the CVS module found at ServerName:/cvs.

It also creates a subdirectory beneath moduleName, called CVS. This subdirectory contains a file called Root, that contains your CVS connection information. Enterprise Architect uses this file to obtain your CVS user ID.

5. Verify that your CVS installation is working correctly.
6. Change directory to the one you specified as the working copy, in the cvs checkout command above; that is, C:\myCVSWorkSpace\moduleName
7. Now create a test file, such as **Test.txt**, containing the text *CVS Test*. You can do this with the command:  
echo CVS Test > Test.txt
8. Execute the following CVS commands:
  - cvs add Test.txt
  - cvs commit -m"Commit comment" Test.txt
  - cvs update Test.txt
  - cvs edit Test.txt
  - cvs editors Test.txt
9. The editors command should produce output resembling the following:  
Test1.txt myUserID Tue Aug 9 10:08:43 2009 GMT myComputer C:\myCVSWorkSpace\moduleName
10. Take note of the userID that follows the filename. Enterprise Architect must find and use this user ID when you create your version control configuration. (See the example dialog below.)
11. Launch Enterprise Architect and open or create the model containing the packages to place under version control.
12. Select the **Project | Version Control | Version Control Settings** menu option. The **Version Control Settings** dialog displays.
13. Click on the **New** button, enter a suitable name in the **Unique ID** <sup>[243]</sup> field, then click on the **CVS** radio button in the **Type** field.

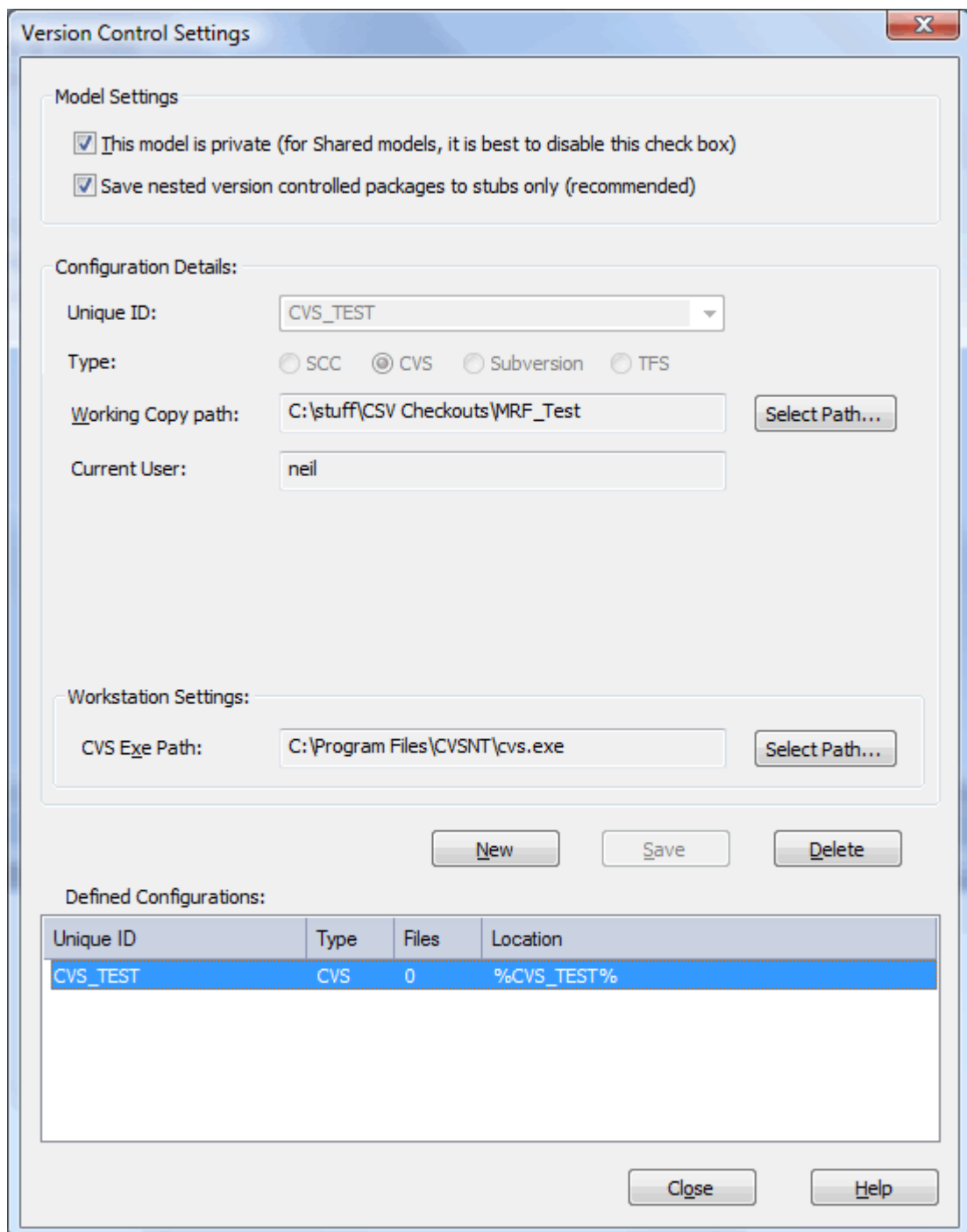

- To specify the [Working Copy path](#) value, click on the **Select Path** button. Select the local folder in which to keep local working copies of the XML files to be stored in the Version Control repository.

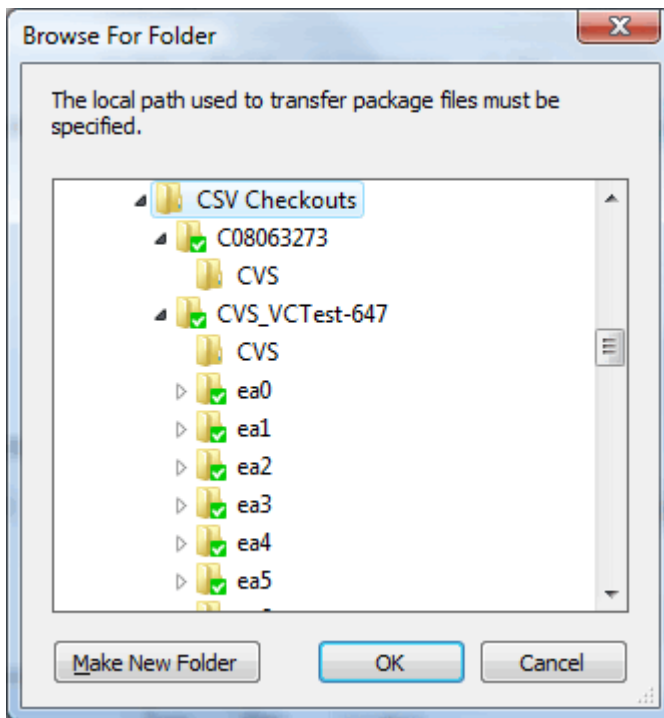

15. Click on the **OK** button to return to the **Version Control Settings** dialog.
16. The **Current User** <sup>[244]</sup> field should display the user name used to log into the remote CVS repository. If this does not happen, it indicates that Enterprise Architect cannot extract the user name from the file `..\WorkingCopyPath\CVS\Root` and the configuration does not work correctly.
17. If necessary, set the **CVS Exe Path** <sup>[244]</sup> by clicking on the **Select Path...** button and browsing to the file path for the file `cvs.exe`, the CVS executable.
18. Click on the **Save** button to save the configuration you have defined. The new configuration is added to the list of **Defined Configurations**.

**Note:**  
 A new entry is also created in the **Local Paths** <sup>[1343]</sup> list, with the same ID as the new version control configuration. The **Local Path** entry records the Local Project path, for use in subsequent path substitutions.

Options	Use to
<b>This model is Private</b>	Specify whether all users connect to a single shared copy of the model (such as a DBMS) or each user connects to their own private copy of the model.  When unselected (for shared models), the option disables the <b>File History - Retrieve</b> functionality when the selected package is checked out by another user. This prevents modifications that might have been made by the other user from being discarded through importing a prior revision from version control.
<b>Save nested version controlled packages to stubs only</b>	Set nested version controlled packages to stubs or fully expanded trees. Defaults to selected.  For a full explanation of this option, see the <a href="#">Version Control Nested Packages</a> <sup>[236]</sup> topic.
<b>Unique ID</b>	Specify a configuration name that readily distinguishes it from other configurations. The unique ID displays as a selection in a list of Version Control configurations a package can connect to. In addition it is possible to select a previous version control configuration from this drop-down menu providing the configuration is not in use in the current model.
<b>Working Copy path</b>	Specify the folder where the XML files representing the packages are stored. This folder should already exist before it is specified here.

Options	Use to
	Every version control configuration you define in Enterprise Architect, should have its own local working copy folder in which to store working copies of the XMI package files; this should not be a shared network folder. Particularly bear this in mind if you are creating an Enterprise Architect project that is to be shared (e.g. a SQL database).
<b>Current User</b>	Specify the CVS user name associated with all CVS commands that are issued. This name is used by Enterprise Architect, to determine who has a package 'checked-out'.
<b>CVS EXE Path</b>	Specify the full path of the CVS client's executable file.

**Note:**

Sparx Systems strongly urge you not to manipulate version controlled package files outside of Enterprise Architect. It is possible to leave the package files in a state that Enterprise Architect cannot recognize.

### 3.5.1.2.3.2 CVS with Local Repositories

Before you can set up Enterprise Architect, you must have a working directory that points to a local repository; that is, one that is installed on your local machine. See your version control software help files for more information.

To set up CVS version control follow the steps below:

1. Launch Enterprise Architect and open or create the Enterprise Architect model for which packages are to be placed under version control.
2. Select the **Project | Version Control | Version Control Settings** menu option. The **Version Control Settings** dialog displays.
3. Click on the **New** button.
4. In the **Unique ID** field, type a suitable name for the configuration.
5. Against the **Type** field, click on the **CVS** radio button.



Version Control Settings

**Model Settings**

- This model is private (for Shared models, it is best to disable this check box)
- Save nested version controlled packages to stubs only (recommended)

**Configuration Details:**

Unique ID:

Type:  SCC  CVS  Subversion  TFS

Working Copy path:

Current User:

**Workstation Settings:**

CVS Exe Path:

**Defined Configurations:**

Unique ID	Type	Files	Location
CVS_TEST	CVS	0	%CVS_TEST%

6. Click on the **Select Path...** button to the right of the **Working Copy path** field and browse for and select the local folder in which to keep local working copies of the XML files to be stored in the Version Control repository.
7. If necessary, click on the **Select Path...** button to the right of the **CVS Exe Path** field and browse to the file path for the file `cvs.exe`, the CVS executable.

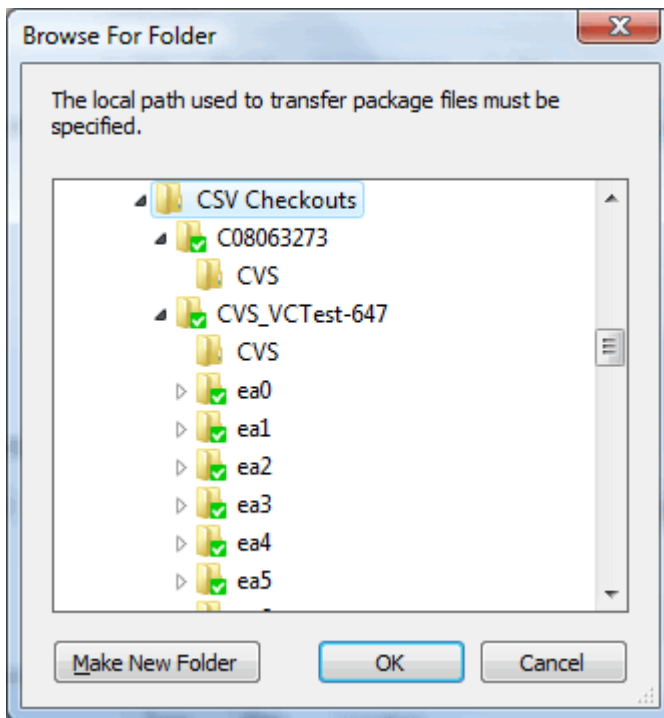

8. Click on the **Save** button to save the configuration you have defined.
9. The new configuration is added to the list in the **Defined Configurations** panel.

**Note:**

A new entry is also created in the [Local Paths](#) <sup>[1345]</sup> list, with the same ID as the new version control configuration. The **Local Path** entry records the Local Project path, for use in subsequent path substitutions.

For further information on the fields in the **Version Control Settings** dialog, see the following table.

Field	Use to
<b>This model is Private</b>	Specify whether all users connect to a single shared copy of the model (e.g. a DBMS) or each user connects to their own private copy of the model.  When unselected (for shared models), the option disables the <b>File History - Retrieve</b> functionality when the selected package is checked out by another user. This prevents modifications that might have been made by the other user from being discarded through importing a prior revision from version control.
<b>Save nested version controlled packages to stubs only</b>	Set nested version controlled packages to stubs or fully expanded trees. Defaults to selected.  For a full explanation of this option, see <a href="#">Version Control Nested Packages</a> <sup>[236]</sup> .
<b>Unique ID</b>	Specify a name that readily distinguishes the configuration from other configurations. The Unique ID is displayed as a selection in the list of Version Control configurations a package can connect to. In addition it is possible to select a previous version control configuration from the drop-down menu providing the configuration is not in use in the current model.
<b>Working Copy path</b>	The folder where the XML files representing the packages are stored. This folder should already exist before it is specified here.  Every version control configuration you define in Enterprise Architect, should have its own local Working Copy Folder in which to store working copies of the XML package files - this should not be a shared network folder. Particularly bear this in mind if you are creating an Enterprise Architect project that is to be shared (for example, a SQL database).

Field	Use to
Current User	The CVS user name associated with all CVS commands that are issued. This name is used by Enterprise Architect, to determine who has a package 'checked-out'.
CVS EXE Path	The full path name of the CVS client's executable file.

**Note:**

Sparx Systems strongly urge you not to manipulate version controlled package files outside of Enterprise Architect. It is possible to leave the package files in a state that Enterprise Architect cannot recognize.

### 3.5.1.2.4 Version Control with Subversion

Subversion is an open source version control system, used to manage files and directories.

To make use of Subversion control you must have Enterprise Architect version 6.0 or greater.

Tasks in setting up version control with Subversion include:

- [Set up Subversion](#) <sup>[247]</sup>
- [Create a new Repository Sub-Tree](#) <sup>[248]</sup>
- [Create a Local Working Copy](#) <sup>[249]</sup>
- [Subversion Under WINE-Crossover](#) <sup>[249]</sup>
- [Version Control Configuration](#) <sup>[250]</sup>
- [TortoiseSVN](#) <sup>[252]</sup>

**Note:**

To see a video demonstration of setting up a Subversion repository for version control, go to [http://www.sparxsystems.com.au/resources/demos/settingupsubversion/svn\\_final.htm](http://www.sparxsystems.com.au/resources/demos/settingupsubversion/svn_final.htm).

#### 3.5.1.2.4.1 Set up Subversion

### Obtain and Install Subversion

**Note:**

Enterprise Architect relies on exclusive file locking when applying version control to its packages. File locking was not introduced into Subversion until version 1.2. Enterprise Architect does not work with Subversion releases earlier than Subversion 1.2.

Before Enterprise Architect can be used with Subversion, the appropriate software must be installed by a Subversion administrator. Ask your system administrator to obtain and install the Subversion server and client applications.

Enterprise Architect must use the Subversion command line client to communicate with the Subversion server; it cannot use other clients such as [TortoiseSVN](#) <sup>[252]</sup>.

**Important:**

Before you attempt to use Subversion through Enterprise Architect, you must first verify that you can use the Subversion command line client to access and operate on files within the working copy folder that Enterprise Architect will use. Your environment must be set up such that you can perform these operations without ever being prompted for user ID or password. For further information, please see the topic *Caching Client Credentials* in the official Subversion documentation.

The official Subversion documentation can be found at: <http://www.svnbook.red-bean.com/en/1.4/index.html>, while executable files for Subversion can be obtained from: [http://www.subversion.tigris.org/project\\_packages.html#binary-packages](http://www.subversion.tigris.org/project_packages.html#binary-packages).

You require the Windows executables for your client machines running Enterprise Architect in the windows environment. If you plan to run your Subversion server on a non-windows platform, you must download a binary suitable for that platform as well.

Chapter 6 in the Subversion documentation provides guidance on how to configure the server for different methods of access by the client. Secure connection methods are also covered in this chapter.

Your administrator should set up user IDs and passwords for every person who is to access the repository. Your administrator should then provide all users with the path to the repository, and ensure that they can all connect.

Before users can make use of Subversion, they must [create local working copies](#)<sup>[249]</sup> from the repository by checking-out a [repository sub-tree](#)<sup>[248]</sup>.

Steps for setting up a repository and creating a local working copy can be found at: <http://www.svnbook.red-bean.com/en/1.4/svn.basic.in-action.html#svn.advanced.reposurls>.

**Note:**

Sparx Systems recommend that each new Enterprise Architect model being added to version control with Subversion should have a separate repository sub-tree created for it, and users should create a new local working copy from the sub-tree to be used with that model.

## Repository URLs

Subversion repositories can be accessed using many different methods, on local disk or through various network protocols. A repository location, however, is always a URL. The table below describes how different URL schemas map to the available access methods.

Schema	Access Method
file:///	Direct repository access (on local disk).
http://	Access via WebDAV protocol to a Subversion-aware Apache server.
https://	Same as http://, but with SSL encryption.
svn://	Access via custom protocol to an svnserve server.
svn+ssh://	Same as svn://, but through an SSH tunnel.

For more information on how Subversion parses URLs, see <http://www.svnbook.red-bean.com/en/1.4/svn.basic.in-action.html#svn.advanced.reposurls>.

**See Also**

- [Configure Version Control with Subversion](#)<sup>[250]</sup>

### 3.5.1.2.4.2 Create a new Repository Sub-tree

If a repository sub-tree has already been created for your Enterprise Architect model, skip this topic and see the [Create a Local Working Copy](#)<sup>[249]</sup> topic. If your Enterprise Architect model has not previously been added to version control, create a sub-tree for it in your SVN repository by following the steps below:

1. Create a temporary directory structure to import into the SVN repository, which initializes the repository sub-tree for this Enterprise Architect model. The directory structure should look like this:

```
tempDir
|
+--<EA_Model_Name>
|
|  +--trunk
|  |
|  +--branches
|  |
|  +--tags
```

2. Open a command prompt, navigate to *tempDir* and issue the command:

```
svn import. <repositoryURL> --message "A Comment of your choice"
```

**Note:**

After the import is finished, the original tree is not converted into a working copy. To start working, you must still **svn checkout** a fresh working copy of the tree.

3. Delete the directory *tempDir* and all its contents.

For further information see <http://www.svnbook.red-bean.com/en/1.4/svn.reposadmin.basics.html>.

### 3.5.1.2.4.3 Create a Local Working Copy

Once you have created a sub-tree in the repository for this model, or if one already exists, you are ready to create the local Working Copy for use with this model.

To create the local Working Copy, follow the steps below:

1. Choose a suitable directory on your system, in which to create your Subversion Working Copy. The directory that contains your model's .EAP file is probably a good choice.
2. Open a command line window, navigate to the directory to hold your Working Copy directory and check-out the model's sub-tree from the repository, with the following command:

```
svn checkout <repositoryURL>/<EA_Model_Name>,
```

where *<EA\_Model\_Name>* is the directory name that you used in setting up the repository sub-tree above.

After you have created your working copy, you should verify everything is working correctly before you attempt to use it from within Enterprise Architect. You must be able to commit files to the repository, without being prompted for ID or passwords.

Enterprise Architect interacts with Subversion using its command line client. Firstly, create a file in your working copy folder then, from a command prompt, add and commit the file to the repository. Use the following commands:

```
svn add <fileName>
svn commit <fileName> -m"A meaningful comment."
```

Now, update the file from the repository, lock the file, edit it and commit once more. Use the following commands:

```
svn update <fileName>
svn lock <fileName>
```

Then edit and save the file using your preferred editor:

```
svn commit <fileName> -m"A meaningful comment."
```

### 3.5.1.2.4.4 Subversion Under WINE-Crossover

When running Enterprise Architect under WINE/CrossOver, you can use either a Windows-based Subversion client or a Linux-based Subversion client.

If you intend to use the HTTP or HTTPS protocols you must use the Unix-like client, as the Windows client cannot access the libraries necessary to create the required network connections. It is also easier to set up your working copy folder using the native Unix-like Subversion client and then continue using that same client from within Enterprise Architect.

However, to make use of the Unix-like client under CrossOver, you must also download and install a bridging utility called *SVN\_gate*, which is available from the CodeWeavers' (CrossOver) web site:

<http://www.codeweavers.com/support/wiki/EAsvn>

When using the Windows Subversion client, you simply install the Win32 Subversion client under CrossOver. Once you have set up your working copy directory, you are ready to use Subversion with Enterprise Architect. However, setting up your working copy is more difficult when using Win32 Subversion under CrossOver. Because you cannot see any output from Subversion commands run under CrossOver, the best way to run the commands is to create a Windows batch file containing the command to run, and to run that batch file as a Windows command under CrossOver. (See the [example batch file](#)<sup>[250]</sup> below.)

If you are running directly under WINE, launch the Windows batch file from a Unix shell script such as follows;

```
/home/user/cxoffice/bin/wine --bottle "ea" --untrusted
```

```
--workdir "/home/user/.cxoffice/ea"/drive_c"
-- "/home/user/.cxoffice/ea/drive_c/batfile.bat"
```

Enterprise Architect uses the Subversion command line client to communicate with your Subversion server. In order for Enterprise Architect to work successfully with Subversion, your Subversion working copy environment must be set up such that you can issue commands to Subversion from the command line, without ever being prompted for user input such as username or password.

By default, whenever the Subversion command-line client successfully responds to a server's authentication challenge, it saves the credentials in the user's private runtime configuration area, which is:

- `~/.subversion/auth/` on Unix-like systems or
- `%APPDATA%/Subversion/auth/` on Windows (which translates to `.../drive_c/windows/profiles/crossover/Application Data/Subversion/auth/` under CrossOver).

For this reason, Sparx Systems recommend that when you checkout a working copy from the Subversion repository, you specify your username and password on the command line, such that your credentials are cached from the outset. Use a Subversion command such as:

- Using a Unix-like client (run the command from the command line):

```
svn checkout --username "UserName" --password "myPassword" "svn://myServerName:3690/myProject"
"/.../drive_c/workingCopyDirectory"
```

- Using a Win32 client (run the command within a batch file run under CrossOver):

```
"C:\Program Files\Subversion\bin\svn.exe" checkout --username "UserName" --password "myPassword"
"svn://myServerName:3690/myProject" "C:\SVN-test\workcopy" >"C:\SVN-test\stdout.txt" &2>"C:\SVN-test\stderr.txt"
```

It is a good idea to checkout your Subversion working copy into a folder within the WINE bottle where Enterprise Architect is to run. In this way, the pathnames used for your version controlled package files are much shorter.

If you intend to use the Win32 Subversion client with Enterprise Architect, you should create the local working copy that Enterprise Architect is to use, by performing a Subversion checkout command using the Win32 client under WINE/CrossOver. Similarly, if you plan to use the Unix-like Subversion client with Enterprise Architect, you should perform the initial checkout using that client. In this way, your user credentials are cached in the correct location for the client that Enterprise Architect is using.

It is important to verify that your command line client for Subversion is working correctly before attempting to connect from Enterprise Architect. For guidance on verifying your set up, see the [Create a Local Working Copy](#)<sup>[249]</sup> topic.

The following is an example of a Windows batch file that can be used under CrossOver to run Subversion commands. Simply uncomment the command to execute. Each command should be a single line - the `\` is intended as a continuation character.

```
rem "C:\Program Files\Subversion\bin\svn.exe" checkout --username "UserName" --password "myPassword" \
"svn://myServerName:3690/myProject" "C:\SVN-test\workcopy"
>"C:\SVN-test\stdout.txt" &2>"C:\SVN-test\stderr.txt"

rem "C:\Program Files\Subversion\bin\svn.exe" add "C:\SVN-test\workcopy\myTestFile.xml" \
>"C:\SVN-test\stdout.txt" &2>"C:\SVN-test\stderr.txt"

rem "C:\Program Files\Subversion\bin\svn.exe" commit -m"a message" "C:\SVN-test\workcopy\myTestFile.xml" \
>"C:\SVN-test\stdout.txt" &2>"C:\SVN-test\stderr.txt"

rem "C:\Program Files\Subversion\bin\svn.exe" lock "C:\SVN-test\workcopy\myTestFile.xml" \
>"C:\SVN-test\stdout.txt" &2>"C:\SVN-test\stderr.txt"
```

### 3.5.1.2.4.5 Version Control Configuration

This topic assumes that you have already installed Subversion (both the server and the client parts), and that you have a [local working copy](#)<sup>[249]</sup>, derived from a [repository sub-tree](#)<sup>[248]</sup>, already set up for use with your Enterprise Architect model.

If this is not the case, please see the [Set up Subversion](#)<sup>[247]</sup> topic.

Once you have set up and tested the Local Working Copy, you are ready to define a Version Control configuration for use with the Enterprise Architect model to place under version control.

To apply version control to your Enterprise Architect model using the Subversion working copy that you have

set up, follow the steps below:

1. Launch Enterprise Architect and open the model for which this Working Copy was created.
2. Select the **Project | Version Control | Version Control Settings** menu option.
3. Click on the **New** button, enter a suitable name in the **Unique ID** field, then click on the **Type: Subversion** radio button.

**Model Settings**

This model is private (for Shared models, it is best to disable this check box)

Save nested version controlled packages to stubs only (recommended)

**Configuration Details:**

Unique ID:

Type:  SCC  CVS  Subversion  TFS

Working Copy path:  

**Workstation Settings:**

Subversion Exe Path:  

**Defined Configurations:**

Unique ID	Type	Files	Location
-----------	------	-------	----------

4. To the right of the **Working Copy path** field, click on the **Select Path** button and select the local folder in which to keep local working copies of the XML files to be stored in the Version Control repository.
5. In the **Workstation Settings** panel, click on the **Select Path** button to specify the path for your Subversion client executable.
6. Click on the **Save** button to save the configuration you have defined; the new configuration is added to the **Defined Configurations** list.

**Note:**

A new entry is also created in the [Local Paths](#)<sup>[1343]</sup> list, with the same ID as the new version control configuration. The **Local Path** entry records the Local Project path, for use in subsequent path substitutions.

7. When you have finished defining your version control configurations, click on the **Close** button.

**Additional Information on the dialog fields:**

Option	Use to
<b>This model is private</b>	Specify whether all users connect to a single shared copy of the model (such as a DBMS) or each user connects to their own private copy of the model.  When unselected (for shared models), the option disables the <b>File History - Retrieve</b> functionality when the selected package is checked out by another user. This prevents modifications that might have been made by the other user from being discarded through importing a prior revision from version control.
<b>Save nested version controlled packages to stubs only</b>	Set nested version controlled packages to stubs or fully expanded trees. Defaults to selected.  For a full explanation of this option, see the <a href="#">Using Nested Version Control Packages</a> <sup>[236]</sup> topic.
<b>Unique ID</b>	Specify a configuration name that readily distinguish this configuration from other configurations. The Unique ID displays as a selection in the list of Version Control configurations a package can connect to. In addition you can select a previous version control configuration from this drop-down menu, providing the configuration is not in the current model.
<b>Working Copy path</b>	Specify the folder where the XML files representing the packages are stored. This folder should already exist before it is specified here.  Every PC using Subversion version control should have its own Subversion working copy folder in which to store working copies of the XML package files; this should not be a shared network folder. Particularly bear this in mind if you are creating a .EAP file that is to be shared (for example, a SQL database).
<b>Subversion Exe Path</b>	Specify the full path name of the Subversion client executable file.

**Note:**

Sparx Systems strongly urge you not to manipulate version controlled package files outside of Enterprise Architect. It is possible to leave the package files in a state that Enterprise Architect cannot recognize.

**3.5.1.2.4.6 TortoiseSVN**

TortoiseSVN is a Windows shell extension for Subversion.

Enterprise Architect cannot use TortoiseSVN to communicate with the Subversion server; it must use the Subversion command line client.

TortoiseSVN provides icon overlays in Windows Explorer that are useful as a tool for observing the status of your Subversion controlled files. It enables you to create your repository sub-trees and check out local working copies from within Windows Explorer using simple menu commands.

**Note:**

- Sparx Systems recommend that you test your local working copies, by adding and committing a dummy file from the command prompt window.
- Manipulating Enterprise Architect's package files, using tools that are external to Enterprise Architect, could leave those files in a state that Enterprise Architect cannot use.

You can download TortoiseSVN from: <http://www.tortoisesvn.tigris.org/>.



### 3.5.1.2.5 Version Control with TFS

In order to use Team Foundation Server (TFS) for version control with Enterprise Architect, all users must have either the TFS command line client (*tf.exe*) or Microsoft's Team Foundation Server MSSCCI installed on their local machine. Each intended user must also have an account that provides read/write access to a workspace on the server.

This topic covers configuring version control using the TFS command line client. To configure version control with the TFS MSSCCI client, please follow the instructions in the [Version Control with SCC](#)<sup>[236]</sup> topic.

The following preliminary steps should be performed within TFS on each PC and for each user, before making any attempt to [define a Version Control Configuration within Enterprise Architect](#)<sup>[253]</sup> that uses TFS.

When initializing the connection to TFS, Enterprise Architect issues the command *tf get*. If the *Local Working Copy* path specified in Enterprise Architect's version control configuration is mapped through a TFS workspace that also maps many *other* working folders to their corresponding Source Control folders, TFS can take a long time as it proceeds to update the files in all of those folders. Enterprise Architect might appear to freeze when it initializes the connection to TFS, whilst it waits for TFS to complete the *tf\_get* command and hand back program control.

Therefore, each user must set up a separate workspace for use in version control in Enterprise Architect, containing a single local working folder on their own machine that is mapped to a Source Control folder on the server. This separate workspace can be in addition to any other workspaces that might already exist.

#### Note:

To see a video demonstration of setting up a TFS project for version control, go to <http://www.sparxsystems.com.au/resources/demos/settinguptfs/TFS%20Project-Workspace%20Setup.htm>.

#### 3.5.1.2.5.1 Connect an Enterprise Architect Model to Version Control using TFS

Having set up TFS and created or otherwise opened your model, you can configure the model for version control under TFS.

To configure the model for version control, follow the steps below:

1. Open or create the Enterprise Architect model to place under version control.
2. Select the **Project | Version Control | Version Control Settings** menu option. The **Version Control Settings** dialog displays.
3. Click on the **New** button, in the **Unique ID** field enter a suitable name, then select the **TFS** radio button.

**Model Settings**

This model is private (for Shared models, it is best to disable this check box)

Save nested version controlled packages to stubs only (recommended)

**Configuration Details:**

Unique ID: TFS-config

Type:  SCC  CVS  Subversion  TFS

Working Copy path: C:\WC Workspaces\TFS\WorkFolder1 Select Path...

Server Name:

Workspace Name:

User Name: SparxSystems\userOne

Password: ●●●●●●●●

**Workstation Settings:**

TFS Exe Path: files\Microsoft Visual Studio 8\Common7\IDE\tf.exe Select Path...

New Save Delete

**Defined Configurations:**

Unique ID	Type	Files	Location

Close Help

- Click on the **Select Path...** button to the right of the **Working Copy path** field, and select the local folder in which to keep local working copies of the XML files to be stored in the Version Control repository.

**Note:**

Enterprise Architect queries TFS to retrieve the Server and Workspace names associated with this folder, when attempting to save the configuration data.

- In the **User Name** and **Password** fields, type values that enable access to the TFS workspace associated with the Working Copy path specified above.

**Note:**

Users who automatically log in to TFS through means external to Enterprise Architect (for example, through MS Integrated Security) can leave the **User Name** and **Password** fields blank. If the **Password** field is blank, Enterprise Architect retrieves the current user's Windows username and uses that value when determining whether a package is checked out to them or to some other user.

6. The **TFS Exe Path** field displays the default installation path; for example:

C:\Program Files\Microsoft Visual Studio 8\Common7\IDE\tf.exe.

Click on the **Select Path...** button if it is necessary to modify this field.

7. Click on the **Save** button to save the configuration you have defined.  
8. The new configuration is added to the list in the **Defined Configurations** panel.

**Note:**

A new entry is also created in the **Local Paths** <sup>[1343]</sup> list, with the same ID as the new version control configuration. The **Local Path** entry records the Local Project path, for use in subsequent path substitutions.

9. When you have finished defining your version control configurations, click on the **Close** button.

### Additional Information on the Dialog Fields

Option	Use to
<b>This model is private</b>	Specify whether all users connect to a single shared copy of the model (such as a DBMS) or each user connects to their own private copy of the model.  When unselected (for shared models), the option disables the <b>File History - Retrieve</b> functionality when the selected package is checked out by another user. This prevents modifications that might have been made by the other user from being discarded through importing a prior revision from version control.
<b>Save nested version controlled packages to stubs only</b>	Set nested version controlled packages to stubs or fully expanded trees. Defaults to selected.  For a full explanation of this option, see <a href="#">Use Nested Version Control Packages</a> <sup>[236]</sup> .
<b>Unique ID</b>	Specify a configuration name that readily distinguishes it from other configurations.  The Unique ID is added to the list of Version Control configurations a package can connect to. In addition it is possible to select a previous version control configuration from this drop-down menu providing the configuration is not in the current model.
<b>Working Copy Path</b>	Specify the folder where the XML files representing the packages are stored. This folder should already exist before it is specified.  Every PC using TFS version control should have its own TFS Local Folder in which to store working copies of the XMI package files - this should not be a shared network folder. Particularly bear this in mind if you are creating a .EAP file which is to be shared (for example, a SQL database).
<b>Server Name</b>	Specify the name of the Team Foundation Server to connect to.
<b>Workspace Name</b>	Specify the name of a pre-defined TFS workspace that you are using.
<b>User Name</b>	Specify the user name that you use to connect to the Team Foundation Server. The user name that you specify should give you read/write permissions in the specified workspace.
<b>Password</b>	Specify the password associated with the user name you specify. Enterprise Architect stores this password, in encrypted form, as part of the version control configuration data.
<b>TFS Exe Path</b>	Browse to and select the full path name of the TFS command line client's executable file.

**Notes:**

- Sparx Systems strongly urge you not to manipulate version controlled package files outside of Enterprise Architect. It is possible to leave the package files in a state that Enterprise Architect cannot recognize.
- Visual Studio Integration (MDG Integration for Visual Studio 2005 or 2008) enhances TFS support by providing access to, for example, work items and bugs within both Enterprise Architect and the MDG Integration product.

**3.5.1.3 Use Version Control**

The following topics describe the most common activities using the version control features of Enterprise Architect, accessed through the [Package Version Control Menu](#) <sup>[257]</sup>:

- [Configure Controlled Package](#) <sup>[259]</sup>
- [Use Existing Configuration](#) <sup>[260]</sup>
- [Validate Package Configurations](#) <sup>[260]</sup> ([Project | Version Control menu](#) <sup>[256]</sup>)
- [Check In and Check out Packages](#) <sup>[261]</sup>
- [Include Other Users' Packages](#) <sup>[263]</sup>
- [Apply Version Control to Branches](#) <sup>[264]</sup>
- [Export Controlled Model Branch](#) <sup>[264]</sup>
- [Import Controlled Model Branch](#) <sup>[265]</sup>
- [Review Package History](#) <sup>[266]</sup>
- [Refresh View of Shared Project](#) <sup>[267]</sup>

**General Notes**

- The export/import facility is not fast and submitting packages containing many sub-nodes to version control should be avoided. It is recommended version control is applied to individual packages. See the [Version Control Nested Packages](#) <sup>[236]</sup> topic for more information.
- [Replication](#) <sup>[184]</sup> should not be combined with version controlled packages.
- Sparx Systems strongly urge you not to manipulate version controlled package files outside of Enterprise Architect. It is possible to leave the package files in a state that Enterprise Architect cannot recognize.

**3.5.1.3.1 Project Version Control Menu**

You access the **Version Control** menu through the **Project | Version Control** menu option. It provides the following options:

Menu Option & Function Keys	Use to
<b>Configure Current Package</b> [Ctrl]+[Alt]+[P]	Display the <a href="#">Package Control Options</a> <sup>[259]</sup> dialog, which enables you to specify whether this package (and its children) is version controlled, and which version control configuration applies.
<b>Version Control Settings</b>	Display the <a href="#">Version Control Settings dialog</a> <sup>[234]</sup> .
<b>Validate Package Configurations</b>	<a href="#">Test the validity</a> <sup>[260]</sup> of the version control settings associated with each version controlled package within your current model.
<b>Re-Synch Statuses of All Packages</b>	<a href="#">Resynchronize the version control status of packages</a> <sup>[267]</sup> as recorded in your Enterprise Architect project when they are out of synchronization with the version control status reported by your version control provider.  The function acts on all version controlled packages within the Enterprise Architect project, updating the values recorded in the project to match the values reported by the version control provider, without performing any XML import or export.
<b>Work Offline</b>	Work <a href="#">independently of the version control server</a> <sup>[268]</sup> , if it is unavailable to you.

### 3.5.1.3.2 Package Version Control Menu

To display the **Version Control** menu, right-click on a version controlled package in the **Project Browser** and select the **Package Control** context menu option.

If the selected package is *not* under version control, this menu displays a number of different options - see the [Controlled Package Menu](#)<sup>[294]</sup> topic.

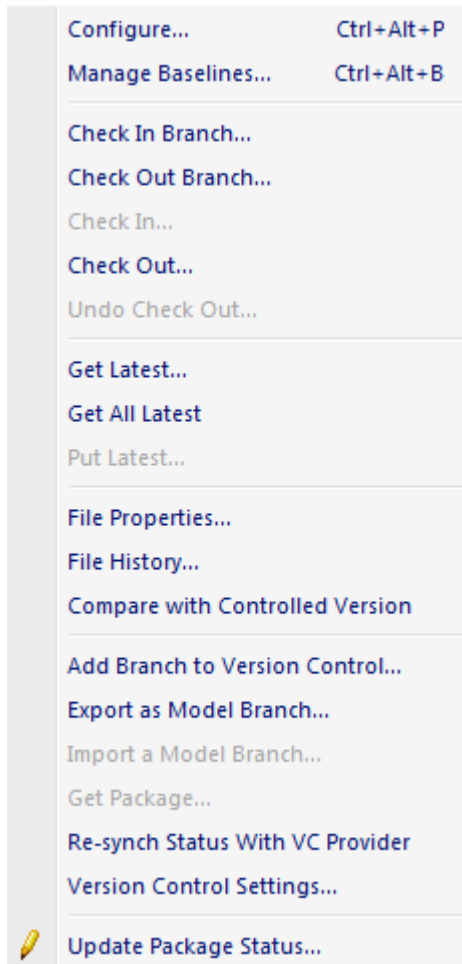

Menu Option & Function Keys	Use to
<b>Configure</b> [Ctrl]+[Alt]+[P]	Display the <a href="#">Package Control Options</a> <sup>[259]</sup> dialog which enables you to specify whether this package (and its children) is controlled, which file it is controlled through, and which version control configuration to use.
<b>Manage Baselines</b> [Ctrl]+[Alt]+[B]	Create a <a href="#">Baseline</a> <sup>[287]</sup> of the current package, or compare the current package with a previous Baseline.
<b>Check In Branch</b>	For the selected branch of the model, (that is, the selected package and all of its child packages) display the <a href="#">Select Packages to Check In</a> <sup>[262]</sup> dialog, listing all version controlled packages within that branch that are checked out to you. You can then select packages in the displayed list, to be submitted for check-in.
<b>Check Out Branch</b>	For the selected package, check out the package and <a href="#">recursively check out all of its contained sub-packages</a> <sup>[263]</sup> . Retrieves the latest version of the packages from the central repository, overwriting the current packages. After check out, the packages are available for editing.
<b>Check In</b>	Submit the currently selected package to the central repository. Enterprise

Menu Option & Function Keys	Use to
	Architect prompts you to enter optional comments describing changes to the packages.
<b>Check Out</b>	Retrieve the latest version of the currently selected package from the central repository, overwriting the current packages. After check out the packages are available for editing.
<b>Undo Check Out</b>	Cancel all changes you have made to the currently selected package. This restores the model to the state it was in before the package was checked out, leaving the select package and sub-packages locked.
<b>Get Latest</b>	Retrieve the latest revision of the package from the repository. Available only for packages that are checked in.
<b>Get All Latest</b>	Retrieve the latest revision of all version controlled packages in the project. Only retrieves packages that are checked in.
<b>Put Latest</b>	Update the central repository with the currently selected package (which you have checked out), while retaining checkout status on the package. This is equivalent to checking a package in and immediately checking it back out again.
<b>File Properties</b>	Ask the version control provider to show the version control properties associated with the XML export file pertaining to the currently selected package. This also identifies who has checked out the package.
<b>File History</b>	Where the controlling package has been configured by an SCC provider, this provider shows a change history for the package. See your provider's documentation for details on how to use the control. Otherwise, if the version control is CVS, the history is shown via Enterprise Architect's internal CVS history menu.
<b>Compare with version on disk</b>	Compare the current package with the XMI version on disk.
<b>Add Branch to Version Control</b>	Apply version control to all packages within a selected <i>model branch</i> , in a single operation. In this context, a model branch is a package that is currently selected in the <b>Project Browser</b> , and all of the packages contained within it.
<b>Export as Model Branch</b>	<a href="#">Export</a> <sup>[264]</sup> a newly created model branch from your own private copy of a model.
<b>Import a Model Branch</b>	<a href="#">Retrieve</a> <sup>[265]</sup> a model branch and import it into either the source model or another model.
<b>Get Package</b>	Access packages in the version control repository that are not currently available in your model.
<b>Re-synch Status With VC Provider</b>	Update the version control status value recorded for the selected package in the Enterprise Architect project to <a href="#">match the value reported by the version control provider</a> <sup>[267]</sup> , without performing an XMI import or export.  Use this function when the package's version control status recorded in your Enterprise Architect project is out of synchrony with the version control status reported by your version control provider.
<b>Version Control Settings</b>	Display the <a href="#">Version Control Settings dialog</a> <sup>[234]</sup> .
<b>Update Package Status</b>	Provide a bulk update on the status of a package, including status options such as <b>Proposed</b> , <b>Validate</b> and <b>Mandatory</b> .  <b>Note:</b>  This option is a generic package option not specific to version control.

### 3.5.1.3.3 Configure Controlled Package

Before working on a package under version control, you must define it as a controlled package and specify the version control configuration to use.

**Note:**

In the Corporate, Business and Software Engineering, System Engineering and Ultimate editions of Enterprise Architect, if security is enabled you must have [Configure Packages](#) <sup>198</sup> permission to configure packages for version control.

### Configure a Version Controlled Package

To configure a version controlled package, follow the steps below:

1. In the **Project Browser**, right-click on the package to place under version control. The context menu displays.
2. Click on the **Package Control | Configure** menu option. The **Package Control Options** dialog displays.

The screenshot shows the 'Package Control Options' dialog box. It contains the following fields and options:

- Control Package:**
- Version Control:** (None) [dropdown arrow]
- XMI Filename:** Resources.xml [text field with browse button]
- UML/XMI Type:** Enterprise Architect XMI/UML 1.3 [dropdown arrow]
- Version ID:** 1.0 [text field]
- Owner:** Nigel Pitt [dropdown arrow]
- Last Load Date:** [empty text field]
- Last Save Date:** [empty text field]
- Other Options:**
  - Use DTD
  - Log Import/Export
  - Batch Import
  - Batch Export
  - Include sub-package

Buttons: OK, Cancel, Help

3. Select the **Control Package** checkbox to indicate that this is a controlled package.
4. Click on the **Version Control** drop-down arrow and select the version control repository; this connects the package to a specific version control configuration.
 

The **XMI Filename** field then displays the version control configuration default path.
5. The **Version ID** field defaults to **1.0**; if necessary, change this to the appropriate reference.
6. The **Owner** field defaults to your user name; if necessary, type or select the name of the user who owns the package.
7. Click on the **OK** button to set the version control options. The **Add Package to Version Control** dialog displays.

The screenshot shows the 'Add Package to Version Control' dialog box. It contains the following text and options:

You are about to add this package to version control.

Keep checked out

Buttons: OK, Cancel

8. If you do not want to check-out the package immediately, clear the **Keep checked out** checkbox.
9. Click on the **OK** button. The **Add Comment** window displays.

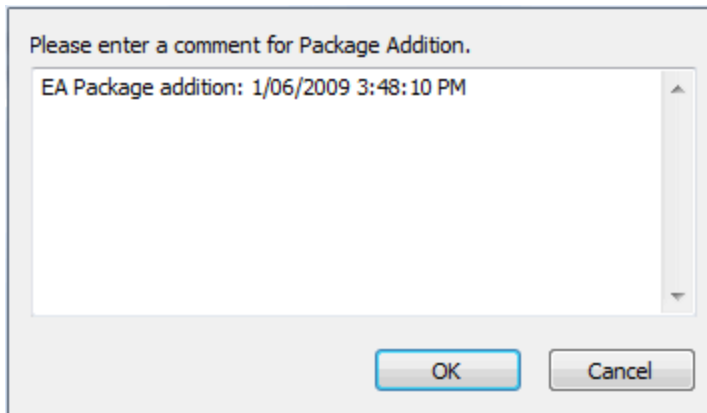

This window displays the date and time at which the package was put under version control.

10. If required, type any further comments in the window. Click on the **OK** button.

Enterprise Architect places the package under the version control configuration you selected, and marks the package in the **Project Browser** with the version controlled [checked out or not checked out](#) <sup>[233]</sup> icons, as appropriate.

#### 3.5.1.3.4 Use Existing Configuration

Once a version control configuration has been defined in one model it is possible to add the configuration to other models.

To use an existing configuration in another model, follow the steps below:

1. Open the model that is to have the predefined version control configuration added to it.
2. Right-click on any package in the **Project Browser** and select the **Package Control | Version Control Settings** context menu option. The [Version Control Settings](#) <sup>[234]</sup> dialog displays.
3. Click on the **New** button.
4. In the **Unique ID** field, click on the drop-down arrow and select one of the previously-defined version control configurations.
5. Click on the **Save** button to confirm the version control configuration.

#### 3.5.1.3.5 Validate Package Configurations

You can test the validity of the version control settings associated with each version controlled package within your current model. To do this, select:

##### **Project | Version Control | Validate Package Configurations**

The validation process scans the model database and verifies that the version control configuration associated with each version controlled package is fully specified in the current model. It also queries the corresponding version control provider to find the status of the package file associated with each version controlled package.

The results of the validation process are sent to the Enterprise Architect **Output** window, as shown below:



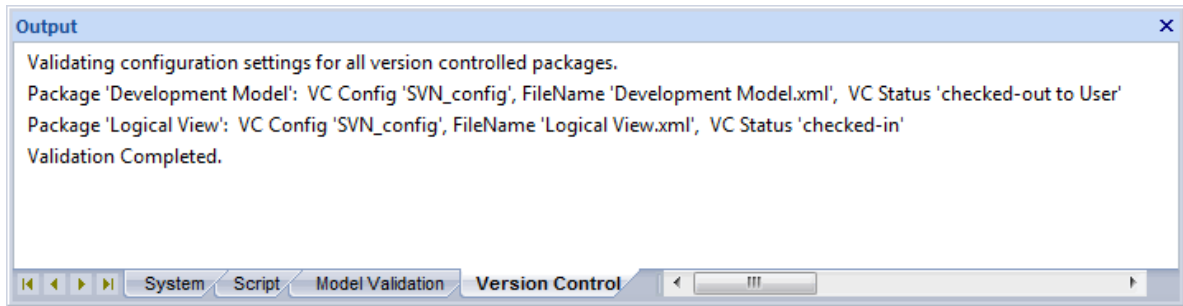

Depending on the results, you can then complete the definition of any invalid or missing version control configurations, or correct problems with individual packages or their associated package files.

Click on an error message to highlight, in the **Project Browser**, the package that is in error.

### 3.5.1.3.6 Check In and Check Out Packages

To work on a version controlled package you must have the package checked out. When a package is checked out to a specific user, a write lock is set on the package and other users cannot make changes to it until it has been checked in again.

#### Note:

In the Corporate, Business and Software Engineering, System Engineering and Ultimate editions of Enterprise Architect, if security is enabled you must have **Use Version Control** <sup>[198]</sup> permission to check files in and out using version control.

### Check In/Check Out

1. In the **Project Browser**, right-click on the package icon.
2. Select the **Package Control | Check In, Check Out** or **Undo Checkout** context menu options, as appropriate.
3. If required, enter a comment when prompted to do so.

If you are working in a **private** <sup>[230]</sup> model and you select the **Check Out** menu option, the **Import Package** dialog displays (in shared models, this dialog only has default values and therefore does not display).

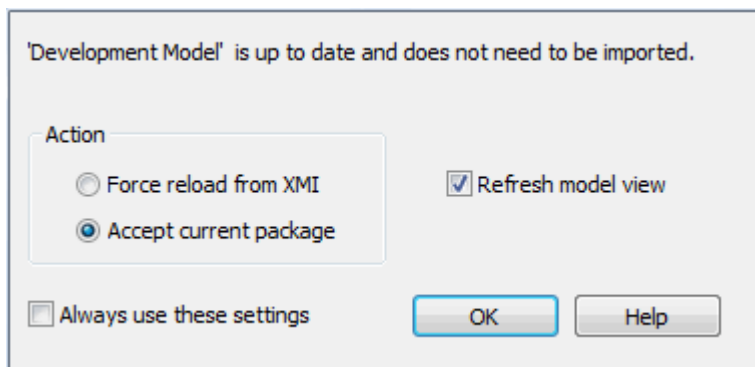

Option	Use to
<b>Force reload from XMI</b>	Reload the package content from the XMI file in the central repository, even though the package and XMI file are synchronized. This ensures that links and dependencies that might not have been refreshed are updated as well.
<b>Accept current package</b>	(The default.) Leave the package content in its current state.
<b>Refresh model view</b>	Refresh the model view to show any changes from other checked out packages.

Option	Use to
<b>Always apply above settings</b>	Apply the settings in the above three fields every time you check out a package that is found to be up to date, and therefore do not display this dialog again.  <b>Note:</b> To display the dialog if, for example, you want to change the settings, press <b>[Ctrl]</b> while you select the <b>Package Control   Check Out</b> menu option.

The package icon in the **Project Browser** should change. When you check out a package this is represented by a figure 8 to the left of the package icon. When you check in a package the package icon is overlaid with a colored rectangle and key. In the example below, the upper package is checked out whilst the lower package is checked in.



#### Notes:

- If you check out a version controlled package whilst offline, the package icon has a red figure 8 in front of it. See [Offline Version Control](#) [268].
- If the packages under version control contain any [alternative images](#) [447] and those images are subject to **frequent change**, you can set the **Export alternate images** option on the [Options](#) [367] dialog to export the images to the version control repository when you check in the packages. If the images are not subject to frequent change, do not select this option and instead use [Export/Import Reference Data](#) [223] to manage alternative images.

### Check In Branch

1. In the **Project Browser**, right-click on the package icon at the root of the model branch that is to be checked in and select the **Package Control | Check In Branch** context menu option. The **Select Packages to Check-in** dialog displays, listing all version controlled packages within the branch that you have checked out.

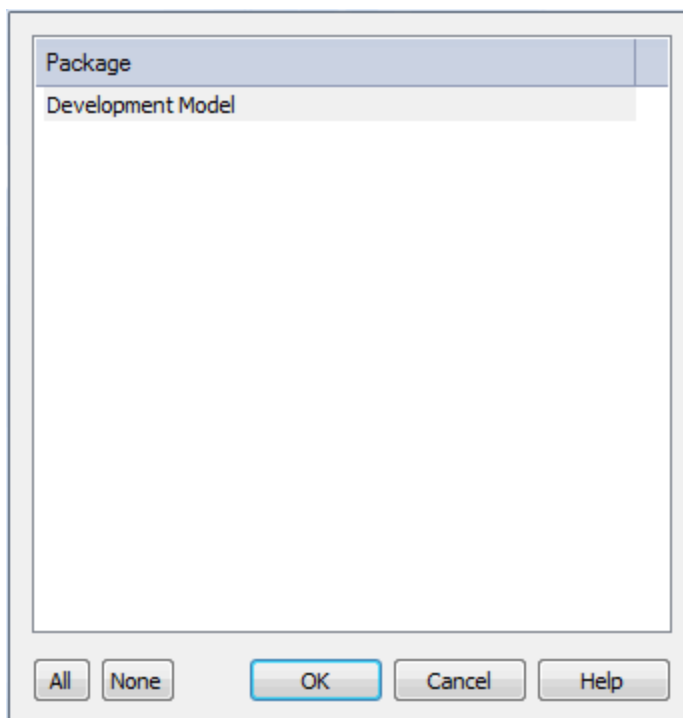

2. Click on the package to check in, or use:
  - **[Ctrl]+click** to add or remove several individual packages
  - **[Shift]+click** to select a range of packages
  - **All** to select all packages listed
  - **None** to clear all selected packages.
3. Click on the **OK** button to check-in the selected packages.
4. If required, enter a comment when prompted to do so. (This comment applies to all packages that you have checked in.)
5. Each package icon changes to indicate that the packages have been checked-in.

### Check Out Branch

1. In the **Project Browser**, right-click on the name of the root package of the model branch to be checked out and select the **Package Control | Check Out Branch** context menu option. The selected package and all of its contained sub-packages are recursively checked out.
2. Any packages that cannot be checked-out are listed in a message box, with a brief description of the problem. For example: *The package is already checked out by user 'Fred'*.
3. When Project Security is enabled in *Lock to Edit* mode, Enterprise Architect prompts you to apply a User Lock throughout the selected model branch before proceeding.

#### 3.5.1.3.7 Include Other Users' Packages

You can retrieve packages that have been created by other users, or by you in another model, from version control and import them into your current model.

Other users might be creating packages to use in your model. If you are not sharing a SQL database or .eap file, those packages do not automatically become part of your model. If the packages have been placed into version control, you can retrieve them and import them into your model as children of an existing package, using the **Get Package** command.

1. You must have access to the package files through the version control system and you must define a Version Control Configuration through which to access those files. The version control configuration must use the same unique ID that was originally used to add the package to version control.
2. In the **Project Browser**, right-click on the package to use as the parent of the incoming package.
3. Select the **Package Control | Get Package** context menu option. The **Get Shared File** dialog displays.

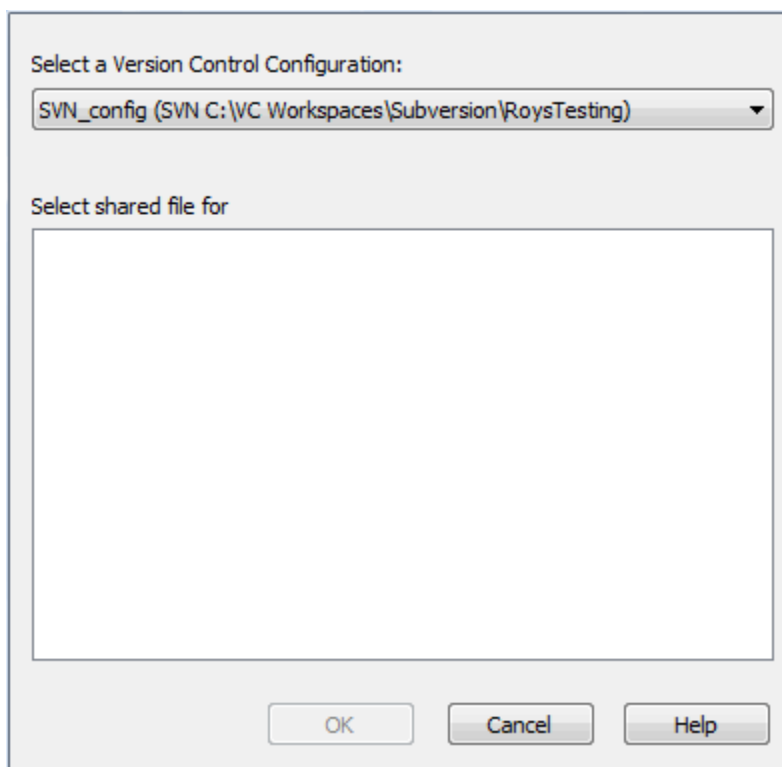

4. In the **Select a Version Control Configuration** field, click on the drop-down arrow and select the version control configuration associated with the package to retrieve. The file list is populated with the names of files available through that configuration, for retrieval and import into your model.
5. Select the package file to import into your model and click on the **OK** button.

### 3.5.1.3.8 Apply Version Control To Branches

Enterprise Architect enables you to apply version control to all packages within a selected *model branch*, in a single operation.

In this context, a model branch is a package that is currently selected in the **Project Browser**, and all of the packages contained within it.

The [Version Control Configuration](#)<sup>[234]</sup> to be used in this operation must be defined within the model before selecting this command.

To apply version control to a model branch, follow the steps below:

1. Right-click on the required package and select the **Add Branch to Version Control**<sup>[257]</sup> context menu option. The **Apply VC to Branch** dialog displays.

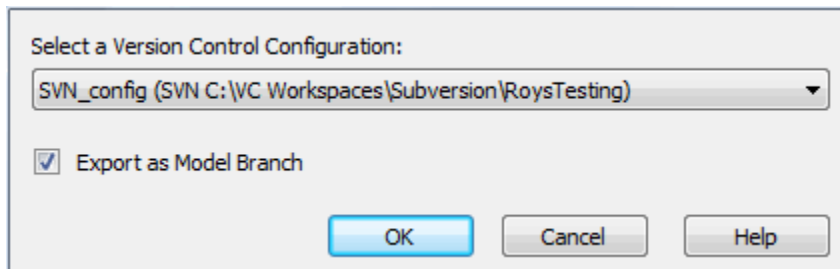

2. In the **Select a Version Control Configuration** field, click on the drop-down arrow and select the Version Control Configuration to use.
3. If required, select the **Export as Model Branch** checkbox to [export the selected package \(and sub-packages\) as a Model Branch](#)<sup>[264]</sup>.
4. Click on the **OK** button. Enterprise Architect creates a number of sub-folders within the version control working copy folder, before exporting all of the packages within the selected model branch. Enterprise Architect generates package filenames using the package GUIDs, before adding the resulting files to version control.

If you have selected the **Export as Model Branch** checkbox, once the version control operation is complete Enterprise Architect also creates a Model Branch file (.EAB file). You can subsequently [import the version-controlled Model Branch](#)<sup>[265]</sup>.

### 3.5.1.3.9 Export Controlled Model Branch

You might want to export a newly created model branch from your own private copy of a model so that, for example:

- Another user can import that branch into their own private copy of the same model, or
- It can be imported for inclusion as a common branch in a number of different models.

Applying version control to an Enterprise Architect model can result in many XML files placed under version control. It could then be hard to locate and import the file corresponding to the root of a particular model branch. Enterprise Architect's Model Branch Files (.EAB files) overcome this problem by simplifying the retrieval of model hierarchies for use in other models.

The facility is only enabled for packages that are already under version control. The exported Model Branch File is also placed under version control, using the same version control configuration that is controlling the selected package.

To export a model branch, follow the steps below:

1. Right-click on the version controlled package to export as a model branch.
2. Select the **Package Control | Export as Model Branch** context menu option. The **Export as Model Branch** dialog displays.

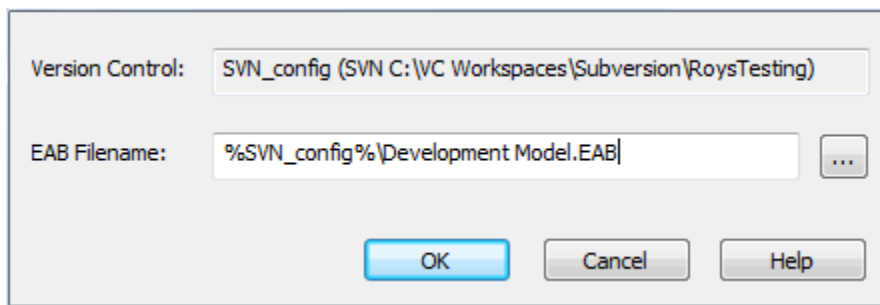

3. In the **EAB Filename** field, type a name for your Model Branch File. Alternatively, click on [ ... ] and browse for the file location.

Note that the package name is supplied as a default.

You can specify any file name, including sub-folder names, as long as the file is contained in or below the working folder of your version control configuration.

### 3.5.1.3.10 Import Controlled Model Branch

It might be necessary to either:

- Retrieve a model branch created by another user in a private copy of a model, to import it into your own private copy of the same model or
- Retrieve a model branch that is common in many models, for inclusion in a new model.

Applying version control to an Enterprise Architect model can result in many XMI files placed under version control. It could then be hard to locate and import the file corresponding to the root of a particular model branch. Enterprise Architect's Model Branch files overcome this problem by simplifying the retrieval of model hierarchies for use in other models.

The **Import a Model Branch** context menu option uses Enterprise Architect's Model Branch Files, of which there are few, to retrieve information about the root package file and import the model branch. The Model Branch File records information such as the name and type of the version control configuration for the selected package, and the relative filename of the version controlled XMI file associated with the package.

Before attempting to import a model branch, you must have access to the version controlled XMI files that represent the model branch to be imported. That is, there must be a working copy folder, accessible from the machine on which Enterprise Architect is running, that is associated with the Version Control repository containing those XMI files.

It is not necessary to have the relevant Version Control Configuration set up within Enterprise Architect before issuing this command - Enterprise Architect prompts you to complete specification of the configuration if necessary.

The **Import a Model Branch** context menu option is only enabled for packages that you (the current user) are able to edit, as the imported model branch is inserted into the model under the selected package.

To import a model branch, follow the steps below:

1. Right-click on the package into which the model branch is to be imported.
2. Select the **Package Control | Import a Model Branch** context menu option. The **Import VC Model Branch** dialog displays.

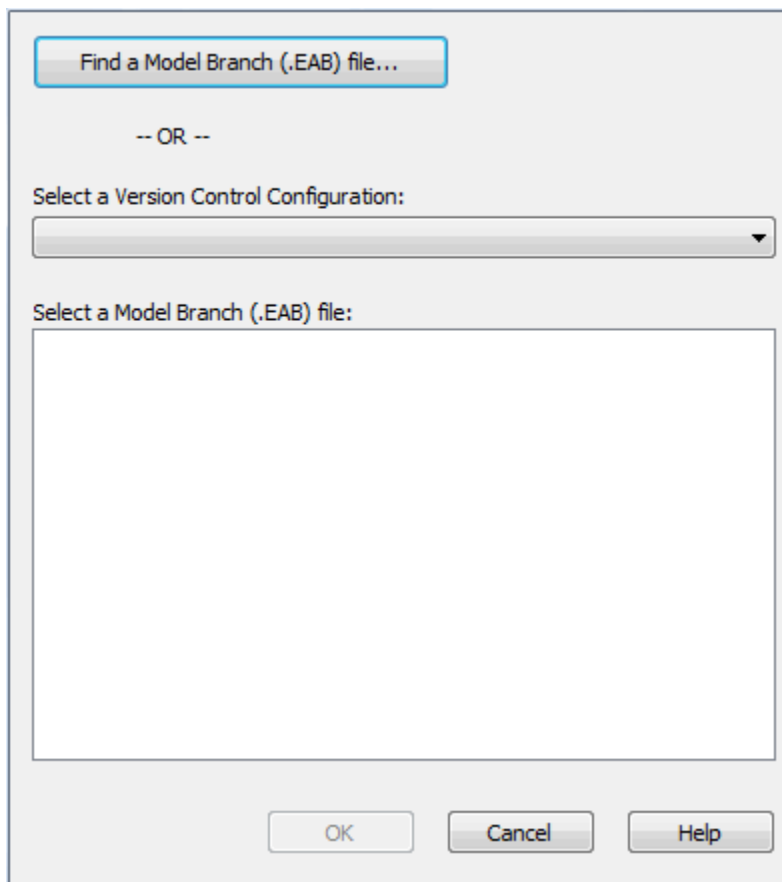

3. Either:

- Click on the **Find a Model Branch (.EAB) file** button and browse for the Model Branch File. If the version control configuration used by the file has not been fully set up, Enterprise Architect prompts you to complete and save the configuration. The model branch import then proceeds. OR
- If the version control configuration used by the file has been fully set up in the current model, click on the drop-down arrow in the **Select a Version Control Configuration** field and select the configuration, then select the Model Branch File from the **Select a Model Branch (.EAB) file** list. Click on the **OK** button to import the model branch.

Enterprise Architect imports the root package specified in the Model Branch File and recursively imports and populates all the sub-packages contained in the root package.

### 3.5.1.3.11 Review Package History

Reviewing package history enables you to view the history of checked in package revisions. It also enables you to import selected prior revisions of the package into your model.

The package revision is retrieved in read-only form, enabling you to view the package contents but not make any changes to the package.

To review package history follow the steps below:

1. In the **Project Browser**, right-click on the package configured for version control. The context menu displays.
2. Select the **Package Control | File History** menu option.
  - If the package has been configured through SCC, you access the history through the mechanism offered by the third party SCC provider.
  - If the package has been configured for CVS, Subversion or TFS, Enterprise Architect's **File Version History** dialog displays and the following steps apply.

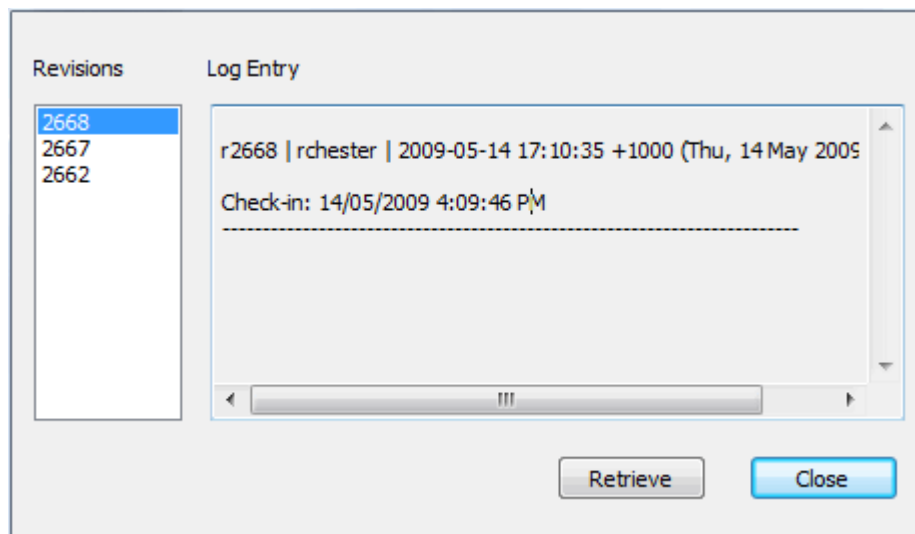

3. In the **Revisions** field, click on a revision number to view the log entries for that revision.
4. To view the package history select a revision and then click on the **Retrieve** button. A warning dialog displays, indicating that the package is being opened in read-only mode.
5. Click on the **Yes** button to continue or the **No** button to cancel the action. The package is retrieved in read only mode, enabling you to view the history of the package at the specified version.
6. To go back to the latest version, in the **Project Browser** right-click on the package and select either the **Package Control | Check Out..** context menu option or the **Package Control | Get Latest** context menu option.

### 3.5.1.3.12 Refresh View of Shared Project

When a user of a shared model checks out a package and makes changes, other users can see those changes by refreshing their view of the package or the changed diagram within the package.

You can refresh your view of the **Project Browser** in the following ways:

- Right-click on the package name in the **Project Browser** and select the **Contents | Reload Current Package** context menu option
- Select the **File | Reload Current Project** menu option (or select the **Reload Project** icon in the toolbar, or press **[Ctrl]+[Shift]+[F11]**)
- Close the project and reopen it.

You can refresh the current diagram in the following ways:

- Select the **Window | Reload Current View** menu option
- Right-click on the opened **diagram tab** in the diagram view, and select the **Reload <diagram name>** context menu option.

### 3.5.1.3.13 Resynchronize the Status of Version Controlled Packages

Enterprise Architect enables you to re-synchronize the version control status of version controlled packages within your project with the status reported by your version control provider. This can be useful when you give a copy of a .EAP file configured for version control to a new team member.

You can resynchronize either a single version controlled package or all version controlled packages within your project:

- For a single package, right-click on the package name in the **Project Browser** and select the **Package Control | Re-synch Status With VC Provider** menu option.
- For all version controlled packages within the project, click on the **Project | Version Control | Re-synch Statuses of All Packages** menu option.

For a given package, the re-synchronization process queries the corresponding version control provider to find the status of the package file associated with the version-controlled package. If necessary, the process then updates the package flags within the model database, to synchronize the package status recorded in the model with the value reported by the version control provider.

The results of the re-synchronization process are sent to the Enterprise Architect **Output** window, as shown below:

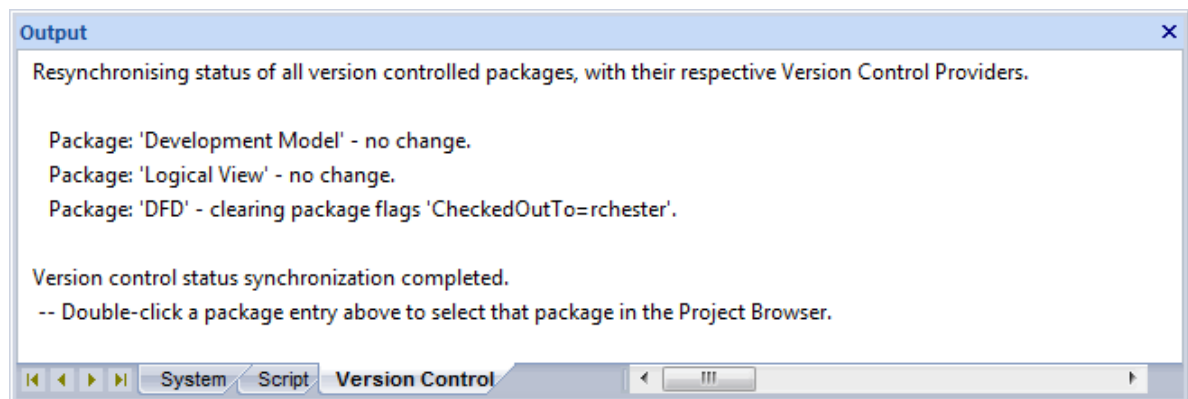

Double-click on any result message to select, in the **Project Browser**, the corresponding package.

#### Note:

This process does not cause any package data to be:

- exported from your model to the associated package file, or
- imported from a package file into your model's package data.

If a package has been checked-out and modified with Enterprise Architect, but your version control provider reports the package file as checked-in, running this process marks the package within Enterprise Architect as being checked-in, without exporting and committing the pending changes. Subsequently checking-out the package imports the latest revision of the package file from version control, effectively discarding the uncommitted modifications from the model.

Similarly, if a package file is checked-out in the version control system, but not in the Enterprise Architect model, running this process marks the package within the model as checked-out, but it does not import the associated package file from the version control system. Consequently, it is possible to check-in a package from Enterprise Architect that is potentially out of date, compared to the latest revision of the package file within the version control system.

#### 3.5.1.3.14 Offline Version Control

When loading a model that uses version control, Enterprise Architect normally initializes a connection to the version control system for each Version Control Configuration defined in the model.

If Enterprise Architect is unable to connect a Version Control Configuration for any reason, it displays warning messages to notify you and provides 'offline' version control functionality for all packages associated with the failed connection.

You can prevent Enterprise Architect from attempting to make any version control connections by selecting the **Project | Version Control | Work Offline** menu option before loading a model. This is useful if you know that Enterprise Architect cannot connect to your version control system. For example, if you are working on a laptop computer that is disconnected from your network and you have an Enterprise Architect model that uses a large number of Version Control Configurations, choosing to work offline before you load the model enables you to avoid all the error messages that Enterprise Architect would normally display as each version control connection attempt fails.

You can switch between working offline and working online at any time, either before or after a model is loaded. Toggle the **Project | Version Control | Work Offline** menu option. Enterprise Architect disconnects or reconnects version control (depending on connection availability) according to your selection.

#### Use Version Control Whilst Disconnected From Your Version Control Server

Enterprise Architect 'remembers' the status of a model's version controlled packages. Packages that were [checked out](#)<sup>[267]</sup> to you prior to disconnecting from the server are still shown as checked out to you, even though you are no longer connected to the server. You can still edit these packages as you normally would.

Packages that were not checked out to you prior to disconnecting from the server are shown as version



controlled and locked. You cannot edit these packages until you check them out.

### Offline Check Out

In releases of Enterprise Architect from release 6.0 onwards, you can 'check-out' and edit a version controlled package even when your machine is disconnected from the version control server. In the example below, the [colored 'figure 8' icon](#)<sup>[233]</sup> for *DFD* indicates that you have checked it out whilst offline (the gray 'figure 8' icon shown against *Logical View* indicates that you have checked out a version-controlled package online).

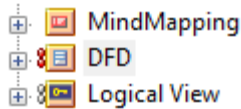

#### Important:

You should be aware that the version control system - and therefore other users - have no way of knowing that you have 'checked-out' a package whilst offline. It is not possible to merge changes to an XML file that result from two users editing the same package at the same time. If an offline checkout leads to two people editing the same package at the same time, when the changes are brought back online the first-saved set of changes is lost.

### Check in a Package That Was Checked Out Offline

Once you reconnect your machine to the version control server, if the package you checked out offline is not currently checked out by another user, you can check in that package. However, before Enterprise Architect checks in such a package, it compares the local working copy of the package file with the latest revision in the repository. (These package files remain unchanged in your work area until Enterprise Architect exports the package again before checking in.) If the repository version remains unchanged from when you last updated your local copy, Enterprise Architect exports and checks in your package without further prompting.

On the other hand, if the repository now contains a file that has changed since you last updated your local copy, checking in your package overwrites whatever those changes might be. Enterprise Architect displays a message warning you of the pending data loss and giving you the opportunity to abort the check in. At this point, you must decide whether to discard your own changes, using the **Undo Check Out** command, or continue with your check in and overwrite the changes that have been committed to the repository since you last updated your local copy from the repository.

You can use the **File Properties** command to determine who checked in the last changes to this package. This might help you to discover what changes have been uploaded and decide whose changes take precedence.

### Update Before You Disconnect

Whenever you are connected to the version control server, you are always working with the latest version of a package. This is because you cannot modify a package until you check it out from version control, and checking it out loads the latest revision from the repository into your model.

These rules do not apply when you are disconnected from the version control server. You are working on whatever versions you have on your machine, dating back to the last time you updated your local copy of each version controlled package. So, if you are planning to work on a model whilst disconnected from version control, it is a very good idea to make sure that you have the latest versions of all packages before you disconnect. The [Get All Latest](#)<sup>[257]</sup> option makes this a simple task.

## 3.5.2 Tracking Changes

Enterprise Architect provides two separate but complementary facilities for tracking changes to data across the project:

- Auditing of model changes
- Baselining and differencing to capture and roll back changes

### Audit Models

[Auditing](#)<sup>[270]</sup> is a project-level feature, available in the Corporate, Business and Software Engineering, System Engineering and Ultimate editions, that enables you to record model changes in Enterprise Architect.

By enabling this option, model administrators can view a range of information regarding changes, such as:

- *Who* changed an element
- *How many* elements they changed
- *When* they changed the data
- *What* the previous values were, and
- *What type* of elements they changed.

### Baselines and Differences

The Enterprise Architect Corporate, Business and Software Engineering, System Engineering and Ultimate editions provide a facility to [Baseline](#)<sup>[279]</sup> or snapshot a model branch in XMI format at a particular point in time, and store it within the model in compressed format.

More than one baseline can be stored against a single Enterprise Architect package. Using Baselines, you can compare packages at the current and earlier stages of development, using the [Compare \(Diff\)](#)<sup>[283]</sup> utility. The Compare utility is available in the Professional, Corporate, Business and Software Engineering, System Engineering and Ultimate editions of Enterprise Architect. It enables you to compare the current model with either an exported or a version-controlled Enterprise Architect XMI file on disk, as well as with a Baseline.

#### 3.5.2.1 Auditing

Auditing is a project-level feature that enables model administrators to record model changes in Enterprise Architect.

By enabling this option, you can view information on changes such as:

- *Who* changed an element
- *How many* elements they changed
- *When* they changed the data
- *What* the previous values were, and
- *What type* of elements they changed.

Auditing does not record changes to RTF Templates, Model Documents, Baselines or Profiles.

The Auditing facility is available in the Corporate, Business and Software Engineering, System Engineering and Ultimate editions.

#### Warning:

If your site runs separate editions of Enterprise Architect, when Auditing is turned on in a project any Desktop or Professional edition users are locked out of the project. To restore access, turn Auditing off in the project from a Corporate, Business and Software Engineering, Systems Engineering or Ultimate edition instance of Enterprise Architect.

### Auditing Quickstart

To quickly enable auditing and see it in action, see [Auditing Quickstart](#)<sup>[274]</sup>.

### Audit Settings

Once auditing is enabled within a project, you have a variety of options available for customizing what is recorded by the audit. See [Audit Settings](#)<sup>[274]</sup> for more information on the different settings available.

### The Audit View

To view what has been recorded by the audit, use the [Audit View](#)<sup>[274]</sup>, which provides an interface to everything recorded by auditing.

#### Note:

If security is enabled, you must have [Audit View](#)<sup>[198]</sup> permission to display data in the [Audit View](#).

You can also obtain a snapshot of selected items in the model, using the [Model View](#)<sup>[122]</sup> facility. In the Corporate, Business and Software Engineering, Systems Engineering or Ultimate editions of Enterprise Architect, this facility enables you to automatically generate this snapshot at intervals and, if there are changes in the items collected by the defined search, to trigger a notification to you of such changes. This enables you

to [monitor work flow](#)<sup>[342]</sup> and other events of concern to you.

## RTF Report

You can generate an RTF report that includes the audit history information for the selected element or package, by choosing the *basic + audit* [RTF template](#)<sup>[1573]</sup>.

## Audit History

Using Auditing, you can track changes to an element or connector over time. However, enabling Auditing also enables an [Audit History](#)<sup>[278]</sup> tab in the system **Output** window, which summarizes all changes made to the selected element or connector.

## Performance Issues

By enabling auditing on a project, you increase the time taken for most actions. For most modeling tasks, this increase is insignificant. However, there are some instances where the difference is more substantial. See [Performance Issues](#)<sup>[279]</sup> for more information.

### 3.5.2.1.1 Auditing Quickstart

To quickly enable auditing and see it in action, follow the instructions below.

#### Enable Auditing

To enable Auditing:

1. Select the **View | Other Project Tools | Audit View** menu option to open the [Audit View](#)<sup>[274]</sup>.
2. Click on the **Audit Settings** button. The [Audit Settings](#)<sup>[274]</sup> dialog displays.
3. Select the **Enable Auditing** checkbox.
4. Click on the **OK** button to close the **Audit Settings** dialog.
5. Close the **Audit View** dialog.

#### Make Changes

Change and save your project; for example:

- Add a new package
- Add a new Class
- Add a new connector
- Change the name of an element
- Delete an element.

#### View Changes in the Audit View

Open the **Audit View** again (**View | Other Project Tools | Audit View**), and click on the **Refresh** (or **Load**) button to display a record of the changes you made.

### 3.5.2.1.2 Auditing Settings

The **Audit Settings** dialog enables you to change what is recorded by the Auditing facility.

#### Note:

If security is enabled, you must have **Audit View** permission to turn Auditing on, and [Audit Settings](#)<sup>[198]</sup> permission to change Audit settings.

To open the **Audit Settings** dialog:

1. Select the **View | Other Project Tools | Audit View** menu option to open the **Audit View**.
2. Click on the **Audit Settings** button. The **Audit Settings** dialog displays.

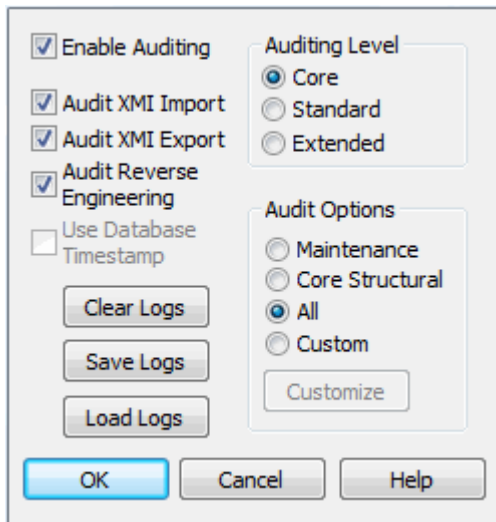

The settings on this dialog are described in the following topics:

- [Audit Scope](#)<sup>[272]</sup>
- [Audit Logs](#)<sup>[272]</sup>
- [Auditing Level](#)<sup>[273]</sup>
- [Audit Options](#)<sup>[273]</sup>

### 3.5.2.1.2.1 Audit Scope

The **Audit Settings** dialog provides checkbox options for turning Auditing on, and for including or excluding areas of processing in Enterprise Architecture.

- **Enable Auditing** - select this checkbox to turn the Auditing facility on
- **Audit XMI Import** - select this checkbox to include XMI importing in the audit
- **Audit XMI Export** - select this checkbox to include XMI exporting in the audit

#### Note:

As version control uses XMI, these options must be selected to record changes from checking out packages.

- **Audit Reverse Engineering** - select this checkbox to include reverse engineering in the audit
- **Use Database Timestamp** - select this checkbox to use the database server's timestamp instead of each user's local timestamp; this improves security.

#### Note:

The **Use Database Timestamp** option is not available for projects stored in .EAP Files.

### 3.5.2.1.2.2 Audit Logs

The **Audit Settings** dialog enables you to administer your audit records.

As the number of records increases, the performance of the [Audit View](#)<sup>[274]</sup> reduces. It is recommended that audit records that are not regularly required are saved to file, then cleared from the project. This helps ensure high performance.

- **Clear Logs** - removes all log data from the current project; all data is permanently deleted. To keep the audit records outside the project, click on the **Save Logs** button to save the records before clearing them from the project
- **Save Logs** - saves a copy of the log items currently held in the database; these items remain in the database. To remove the items after saving the copy, click on the **Clear Logs** button
- **Load Logs** - enables you to load a previously saved set of logs back into the project. The file is not deleted by this operation. If duplicate logs exist in both the project and the file, these are skipped.

**Note:**

Some of these functions can be accessed through the Automation Interface. For more information, see the [Repository](#) topic.

If you save or clear the log items, Enterprise Architect prompts you to specify whether to save or clear the items covering a specific period of time.

- If you click on the **No** button, you save or clear all log items currently held in the database.
- If you click on the **Yes** button, the **Time Filter** dialog displays, on which you select a standard time period or define your own.

### 3.5.2.1.2.3 Auditing Level

The **Auditing Level** panel provides three options that determine what kind of model changes are recorded:

- **Core** - select this radio button to record changes to elements (including attributes and operations), packages, connectors and some model-level information
- **Standard** - select this radio button to record the same changes as the **Core** option, plus changes to diagrams
- **Extended** - select this radio button to record the same changes as the **Standard** option, plus changes to security.

### 3.5.2.1.2.4 Audit Options

The following elements are always audited:

- Packages
- Notes
- Boundary
- Text
- Diagrams (if on [Standard](#) level)
- Security (if on [Extended](#) level)

The audit options enable you to configure auditing to record changes to only certain types of elements.

- **Maintenance** - select this radio button to audit maintenance elements; that is:
  - Package
  - Requirement
  - Feature
  - Use Case
  - Actor
  - Note
  - Issue
  - Change

- **Core Structural** - select this radio button to audit maintenance elements plus some structural elements; that is:
  - Package
  - Class
  - Interface
  - Signal
  - Node
  - Component
  - Artifact
  - Part
  - Port
  - Device
- **All** - select this radio button to audit all elements
- **Custom** - select this radio button to audit element types that you specify.

If you select the **Custom** option, the **Customize** button is made available. Click on this button to display a list of element types, and select the checkbox against each element type to include in the audit (or click on the **Select All** button to select every element type). Click on the **OK** button to save the selection.

**Note:**

Connectors are audited when they are connected to an element that is included in the Audit Options.

### 3.5.2.1.3 The Audit View

The **Audit View** provides an interface to the information that has been recorded by auditing. Open the **Audit View** by clicking on the:

- **View | Other Project Tools | Audit View** menu option.

**Note:**

If security is enabled, you must have **Audit View**<sup>[198]</sup> permission to display data in the **Audit View**.

The **Audit View** is divided into three main areas:

- View controls
- Audit tree
- Record display.

The data in the Audit tree and Record display is determined by the view controls and **mode**<sup>[277]</sup> and, if **synchronizing**<sup>[277]</sup> with the **Project Browser**, by the package, diagram or element you have selected.

## View Controls

The view controls provide a variety of settings for controlling auditing and the display of audit records.

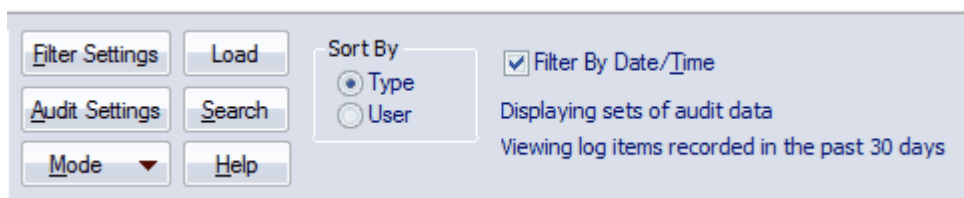

For information on these controls, see **Audit View Controls**<sup>[276]</sup>.

## Audit Tree

The audit tree displays the logs that have been recorded by auditing. What is displayed in the tree is affected by the settings of the View Controls section, such as:

- Sorting
- Filter (by time)

- Mode
- [Auditing settings](#) (what was actually recorded).

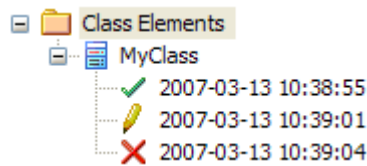

In the audit tree:

- The green tick indicates a creation
- The yellow pencil indicates an edit
- The red cross indicates a deletion.

If you right-click on an element in the audit tree (such as *MyClass*) a context menu displays. This menu enables you to locate the selected element in:

- The **Project Browser**
- Any diagrams in which it exists.

### Record Display

The record display is in two parts: the identity of the selected change, and the actual change made.

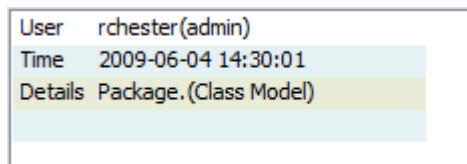

Property	Original	Change
version	1.0	1.1
stereotype		agent
status	Proposed	Validated
phase	1.0	1.1
scope	Public	Protected

### Identity

The identity of a change consists of:

- The Windows username of the user that made the change

**Note:**

If security is enabled, the name is of the format: *WindowsUsername(SecurityUser)*.

- When the change was made
- The *path* of the change (for example, Class *Class1* - Attribute *Att1* - Attribute Constraint *Constraint*).

### Changes

The changes are displayed in a table format, showing the Property (or data item) name, its original value before the change and its value after the change.

If you double-click on an item in the list of changes (or right-click and select the **Show Differences** context menu option) the **Difference** dialog displays. This shows the specific changes that have been made, highlighting the edited, created or deleted characters.



### 3.5.2.1.3.1 Audit View Controls

The **Audit View** controls provide a variety of settings for controlling auditing and the display of audit records.

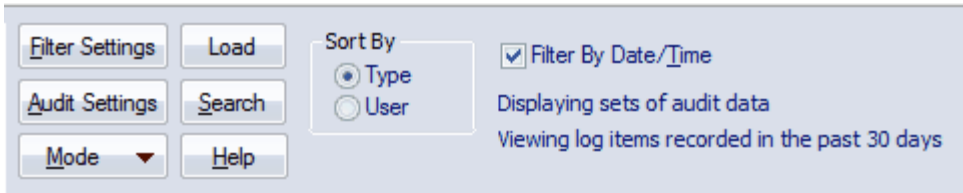

- The **Load** ([Advanced](#), [Deleted](#) or [Raw](#)<sup>[277]</sup> modes) or **Refresh** ([Standard](#)<sup>[277]</sup> mode) button reloads the Audit Tree, updated with any new audit results.
- The **Search** button enables you to search through log items for a particular area. Log Items can be searched by Name, Type or GUID. The items are loaded and filtered with the current **Sort By**, **Time Filter** and **Mode** settings. If you refresh the **Audit View**, you must run the search again.
- The **Audit Settings** button opens the [Audit Settings](#)<sup>[277]</sup> dialog.

#### Sort-by Panel

The **Sort By** panel enables you to select one of three display settings:

- **Type** - changes are grouped under element type (such as Class or Requirement), and then grouped under the changed element.

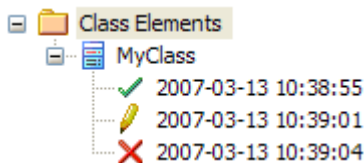

- **User** - changes are grouped under user name. The number of changes for each user is also displayed. Under each user name, changes are grouped as for the **Type** sort.

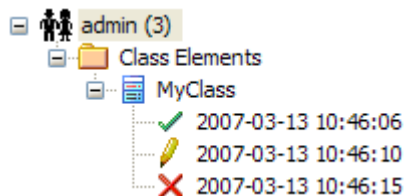

- **Deletions** - displays only deletions, shown in chronological order. If used with the **Search** button, this can be useful for recovering information on missing elements.





## Filter by

The **Filter By Date/Time** checkbox enables filtering by time periods, which you set using the **Time Filter** dialog; click on the **Filter Settings** button to display this dialog.

Select:

- **Today** - to display changes occurring today
- **Previous Hour** - to display changes occurring in the last 60 minutes
- **Previous 24 Hours** - to display changes occurring in the last 24 hours
- **Previous Week** - to display changes occurring in the last 7 days
- **Previous 30 Days** - to display changes occurring in the last 30 days
- **Previous Year** - to display changes occurring in the last 365 days
- **Custom** - to define your own time period, using the **From** and **To** fields.

### Note:

The six pre-configured time periods automatically update when you click on the **Refresh** button. Custom periods are static and do not automatically update.

Changes that occur *outside* the filter period you select are not shown in the **Audit View**. Once you have set a filter period, it remains set if you deselect the **Filter By Date/Time** checkbox. The Custom time period, too, is retained so that you can re-use it or modify it later if required.

## Status Text

Beneath the **Filter By Date/Time** checkbox, status text displays to show which mode has been selected (see below), and which [time filter](#)<sup>[277]</sup> is being applied to the data.

## Mode Button

The **Mode** button enables you to change the mode of the **Audit View**. The button displays a drop-down menu from which you can select:

- **Standard** - to interact with the **Project Browser**
- **Advanced** - to load large sets of log items

### Note:

When in **Advanced** mode, a special Audit Settings group can be displayed in the **Audit Tree**<sup>[274]</sup>. This records when Auditing has been enabled and disabled, along with who made the change, and the date and time of the change.

- **Raw** - to display all audit records without sorting (although any search and filtering you define still apply). Additional database information is displayed; this additional information might be unimportant.

## Standard Mode

In **Standard** mode, Auditing is automatically synchronized with the **Project Browser**.

When synchronized, and where changes have been made, the **Audit View** reflects your selection from the **Project Browser**. If you click on:

- An element, the **Audit View** displays the history for that element
- A package, the **Audit View** displays the history for that package and its immediate children (but not the contents of nested packages)
- A diagram, the **Audit View** displays the history for that diagram and its contents (which could be drawn from a wide area of the **Project Browser**).

### Advanced Mode

In **Advanced** mode, you can load sets of audit data independent of the **Project Browser**. These sets of data display all significant changes, but you can reduce the selection by filtering by time or by running a search. **Advanced** mode also displays:

- Changes to the Audit Settings
- When Audit Operations are executed
- Security changes (which can be browsed in the same way as other changes).

### Raw Mode

In **Raw** mode, all data recorded by auditing is displayed in chronological order. This enables you to see a progression of changes, which can be especially useful in determining date-time inconsistencies. Search and filters can still be applied, enabling you to view all of today's changes in order, or all changes for a particular element in order, or both.

#### Note:

Some information displayed in **Raw** mode might be insignificant or only in machine-readable format.

#### 3.5.2.1.4 Audit History Tab

When Auditing is turned on, an **Auditing History** tab is enabled in the **Output** window. To see this tab, you must have the **Auditing** View open (however, the tab continues to display if you subsequently close the **Auditing** View).

#### Note:

If security is enabled, you must have **Audit View** permission to display data on the **Audit History** tab.

User	Timestamp	Property	Original	Change
rchester(Frederick)	2009-06-04 16:23:58	version	1.0	1.1
		stereotype		agent
		status	Proposed	Validated
		phase	1.0	1.1
		scope	Public	Protected

The information in the **Audit History** tab provides a history of changes to whichever element or connector you have selected in the:

- current diagram
- **Project Browser**
- **Audit View**, or
- **Element List**.

As you select different elements or connectors, the **Audit History** automatically updates to reflect your current selection. The information shows, for each change made to the element or connector:

- Who made the change
- When the change was made

- Where the change was made
- The value of the characteristic before the change
- The value of the characteristic after the change.

### 3.5.2.1.5 Auditing Performance Issues

#### Impact of Auditing on Other Facilities

Enabling auditing on a project increases the time taken for most actions. For most modeling tasks, this increase is insignificant; however, there are some situations where the difference is more substantial.

##### Large Deletions

Deleting large packages or package structures, or large numbers of elements, takes significantly longer with auditing on. You might [disable auditing](#)<sup>[27†]</sup> before performing such a deletion.

##### XMI Imports

[Importing XMI](#)<sup>[290†]</sup> takes longer with auditing enabled. A [project-level option](#)<sup>[27†]</sup> is provided for disabling auditing of XMI Imports.

##### Reverse Engineering

[Reverse engineering](#)<sup>[1328†]</sup> code takes longer with auditing enabled. A [project-level option](#)<sup>[27†]</sup> is provided for disabling auditing of reverse engineering.

### 3.5.2.1.6 Audit View Performance Issues

Most operations in the **Audit View** are affected by the volume of use of the database - both by other facilities and by auditing itself. Some potential problems and their solutions are outlined below.

#### Navigating the Project Browser Within Auditing is Slow

- Try setting the [time filter](#)<sup>[277†]</sup> to a period in the immediate past, such as **Today**, **Previous 24 Hours** or **Previous Week**. This time period updates each time you open or refresh the **Audit View**.
- [Save log items](#)<sup>[272†]</sup> outside the project with the **Save Logs** button. If you then clear the logs you have just saved, the load time of the **Audit View** is reduced. You can reload logs into the project at any time, using the **Load Logs** button.

#### Navigating the Audit Tree is Slow

- Close the [Audit History](#)<sup>[278†]</sup> tab in the **Output** window.

#### The Audit View is Slow in Loading and Changing Modes

- Try setting the [time filter](#)<sup>[277†]</sup> to a period in the immediate past, such as **Today**, **Previous 24 Hours** or **Previous Week**. This time period updates each time you open or refresh the **Audit View**.
- [Save log items](#)<sup>[272†]</sup> outside the project with the **Save Logs** button. If you then clear the logs you have just saved, the load time of the **Audit View** is reduced. You can reload logs into the project at any time, using the **Load Logs** button.

## 3.5.2.2 Package Baselines

Enterprise Architect includes tools to help you manage and review changes to your models over time. These tools apply the concepts of *Baselines*, *Differencing* and *Merges*.

You can also obtain a snapshot of selected items in the model, using the [Model Views](#)<sup>[1222†]</sup> facility. This facility enables you to automatically generate the snapshot at intervals and, if there are changes in the items collected by the defined search, to trigger a notification to you of such changes. This enables you to [monitor work flow](#)<sup>[342†]</sup> and other events of concern to you.

Both of these facilities are available in the Corporate, Business and Software Engineering, Systems Engineering and Ultimate editions of Enterprise Architect.

## Baselines

Enterprise Architect (Corporate, Business and Software Engineering, System Engineering and Ultimate editions) provides a facility to create a [Baseline](#)<sup>[280†]</sup> or snapshot of the contents of a selected package and its child packages at a particular point in time. This enables you to later compare that branch of the model at that time with the current state of the branch.

Baselines are stored in the same XML format as is used for version control, but are stored *within* the project in compressed format. You can also have parallel copies of parts of your model for team development, and create Baselines within each copy to merge changes into the project master.

## Differencing

Differencing (*Diff*, or [Compare](#)<sup>[283]</sup>) enables you to explore the differences between the current state of a specific part of your project, and previous or parallel versions captured in a Baseline or an XML 1.1 file on disk.

## Merges

Once Differencing is complete, you can merge information from the Baseline into the current project; it is not possible to go the other way.

You can merge information manually, change by change, or automatically by electing to merge in all changes in one batch procedure. You can also revert completely to the original Baseline by importing the stored XML directly, and merge in information and elements from a Baseline in a different project, making it possible to keep multiple versions of a single model in synch.

The [merge options](#)<sup>[285]</sup> are available on the **Compare Utility** tab, which shows the results of a comparison. The options are available through the toolbar, context menus and the keyboard.

### Notes:

- You use Baselines, Differencing and Merges essentially to compare two snapshots of a specific part of your project, to capture the differences between them and either roll back or incorporate selected changes or all changes. Enterprise Architect Corporate, Business and Software Engineering, System Engineering and Ultimate editions have another facility, [Auditing](#)<sup>[270]</sup>, which you can switch on to perform continuous monitoring of changes across the project. You can dovetail your use of each facility to meet the range of your change management requirements.
- If a package under version control forms part of a Baseline, and that package is checked in to the model, you cannot merge the original data from the Baseline into that package.
- If security is enabled you must have [Baselines - Manage](#)<sup>[198]</sup> permission to create, import and delete Baselines, and **Baselines - Restore** permission to merge data from a Baseline. Security permissions are not required to select an existing Baseline and perform a comparison with the model.

### 3.5.2.2.1 Baselines

Enterprise Architect provides a facility to 'Baseline' (snapshot) a model branch at a particular point in time for later comparison with the current package state.

#### Note:

This facility is available in the Corporate, Business and Software Engineering, System Engineering and Ultimate editions of Enterprise Architect.

Baseline comparison is most useful for determining changes made to the model during development compared to some Baseline saved at a crucial point - for example the completion of a phase or version iteration. More than one Baseline can be stored against a single Enterprise Architect package. Baselines are particularly useful during requirements management to check for changes, additions and deletions that have occurred since the start of the current work phase. Knowing how a model has changed is an important part of managing change and the overall development process.

Baselines are stored within the model in compressed XML format. You can save a Baseline to an external XML file for storage or archive, or for distributing to other users working on models derived from a master project.

Baselines are generally used in conjunction with the [Compare utility \(diff\)](#)<sup>[283]</sup>, which is built into the Professional, Corporate, Business and Software Engineering, System Engineering and Ultimate editions of Enterprise Architect.

A typical scenario for [using Baselines](#)<sup>[281]</sup> would be to:

1. [Create](#)<sup>[282]</sup> the base model branch to a sufficient point to create a Baseline (checkpoint). Create and store the Baseline as Version 0.1a.
2. As work continues on development, managers and developers can check the current model branch against the Baseline for important modifications, additions and deletions. The Compare (diff) tool can be

invoked from the **Baseline** dialog to check the current model branch against the stored version.

3. As required, minor Baselines can be created to check recent progress. These 'temporary Baselines' are useful for managing change when a lot of work is being done and it is important to only see what has changed in, for example, the last 24 hours.
4. At sign-off or the move to a new version/phase, a major Baseline can be created to capture the new state of the model. Minor Baselines created earlier can be deleted if required to save space.

### Important Considerations

- Baselines are based on the GUID or unique ID of a particular package. Enterprise Architect checks for that ID as the root element within the XML document being used as a Baseline. When you export a package to XML, the package you export is the root element. Likewise when you create a Baseline, the current package is the root package of the XML Baseline. When you save information in a version control system, the current version controlled package is again the root package of the document.
- It is not useful to create a Baseline by importing an XML package file created by version controlling a package that itself contains version-controlled child packages. That type of XML package file contains stubs for the child packages, not full information on the child packages and elements.
- XML files must be in the same format used by the Baseline engine - currently the **UML 1.3 XMI 1.1 format** (plus Enterprise Architect extensions), which contains all the information necessary to reconstruct a UML model, even a UML 2.x model.

#### 3.5.2.2.1.1 Manage Baselines

Enterprise Architect provides a range of facilities for working with and managing Baselines, through the **Manage Baselines** dialog.

To open this dialog, right-click on the package at the head of the appropriate model branch and select the **Package Control | Manage Baselines** context menu option.

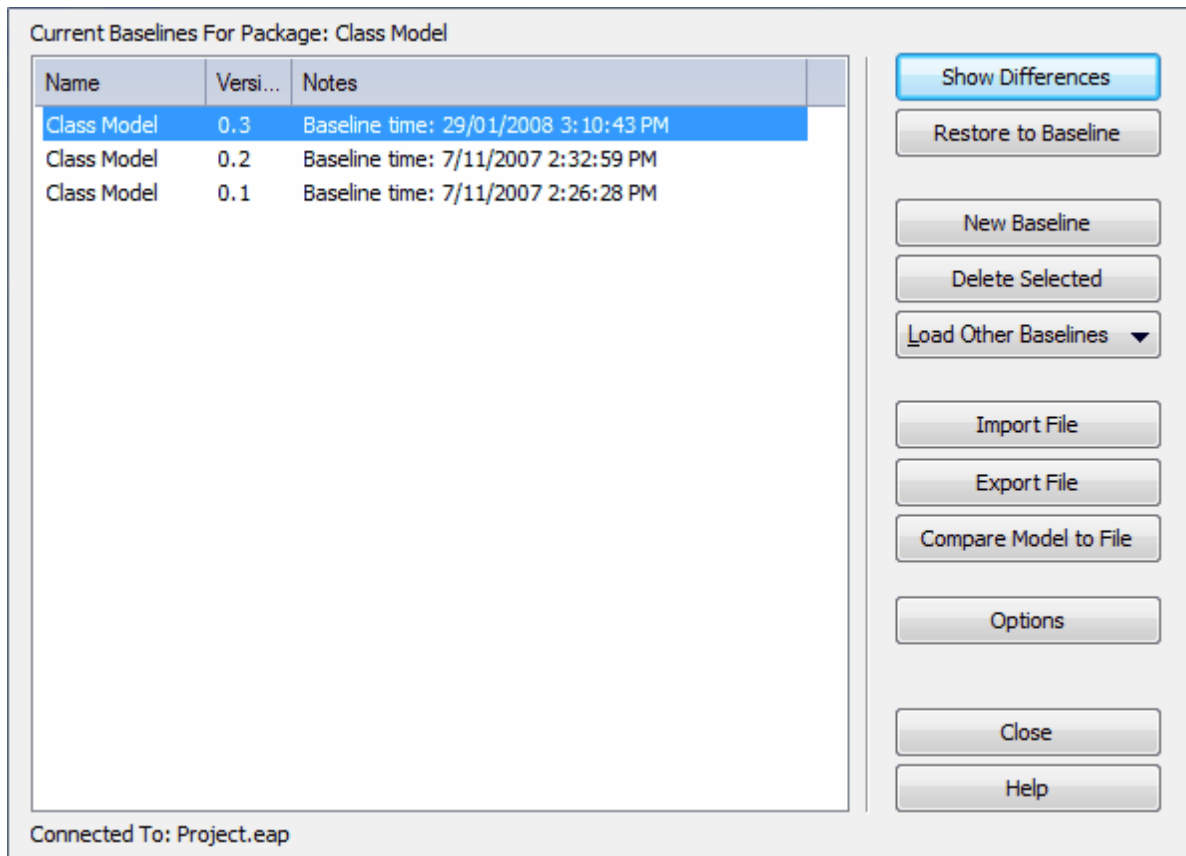

Option	Use to
Current Baselines	Review the baselines for the current model branch, listed by <a href="#">version reference</a> with

Option	Use to
For Package: <Name>	the highest alphabetical/numerical value at the top. If an entry is longer than the display area, a horizontal scroll bar displays at the bottom of the panel. Use this to scroll to the text that is not shown.
Show Differences	Run the <a href="#">Compare</a> [283] utility on the selected Baseline and the current model branch, and to <a href="#">display the differences</a> [284] between the two.
Restore to Baseline	Completely restore the model branch from the selected Baseline.
New Baseline	<a href="#">Create a new Baseline</a> [282].
Delete Selected	Delete the selected Baseline.
Load Other Baselines	Display a drop-down menu that enables you to load Baselines from another model, in either a .EAP file or a DBMS file. <ul style="list-style-type: none"> <li>For .EAP files, a browser displays; locate the required project file</li> <li>For DBMS files, the Windows <b>Data Link Properties</b> dialog displays; select the data provider and click on the <b>OK</b> button to display the <b>Select Data Source</b> dialog, from which you select the required project.</li> </ul> In either case, the <i>Connected To:</i> message at the bottom of the <b>Manage Baselines</b> dialog changes to the name of the alternative model. To return the dialog to the original project, select the third option on the drop down list: <b>Load From Selected Package</b> .
Import File	Import an XML 1.1 file from the file system as a new Baseline for this current model branch.
Export File	Export the selected Baseline to an XML file on disk.
Compare Model to File	Compare the selected model branch with an XML 1.1 file on disk. A browser displays, which you use to locate the file.
Options	<a href="#">Set filters</a> [284] to make the comparison more specific.

### 3.5.2.2.1.2 Create Baselines

Open the **New Baseline** dialog by clicking on the **New Baseline** button on the [Manage Baselines](#) [281] dialog.

The screenshot shows a dialog box with the following fields and controls:

- Name:** Resources
- Version:** 1.2.1
- Include sub-packages
- Note:** Baseline time: 30/11/2009 9:30:26 AM
- Buttons:** OK, Cancel

Option	Use to
Name	Display the package name of the currently selected model branch.
Version	Type a unique version reference for this Baseline. This can consist of any alphanumeric characters. The <b>Manage Baselines</b> dialog sorts the Baselines according to the value of this field.

Option	Use to
<b>Include sub-packages</b>	Include the entire sub-package hierarchy of this branch in the Baseline. Defaults to selected. If you deselect the checkbox, only the immediate contents (XMI stubs) of the package are included in the Baseline.
<b>Note</b>	Edit the default current time and date to any other value. The field is a single-line entry, for display on the <b>Manage Baselines</b> dialog (a one-line-per-entry list).

Click on the **OK** button to create a new Baseline and return to the **Manage Baselines** dialog.

### 3.5.2.2.1.3 The Compare Utility (Diff)

#### Notes:

- This utility is available in the Professional, Corporate, Business and Software Engineering, System Engineering and Ultimate editions of Enterprise Architect.
- You cannot compare the current model with an XMI 2.1 file; the utility can only compare with an XMI 1.1 file.

Enterprise Architect has a comprehensive and powerful differencing utility built in. This utility enables you to compare a model branch in Enterprise Architect with:

- A Baseline created using the Baseline functionality (Corporate, Business and Software Engineering, System Engineering and Ultimate editions)
- A Baseline stored in a *different* model
- An XML 1.1 file on disk created previously using the Enterprise Architect XML export facility (user selects file), or
- The current version-controlled XMI 1.1 file on disk as created when using Version Control in Enterprise Architect (file automatically selected).

*Compare (diff)* lets you explore what has changed within a model over time and how previous versions of a model branch differ from what is currently in the model. It is even possible to do a full model comparison by exporting all of Model A to XMI, then using **Compare Model to File** from within the current model (Model B).

Comparing and checking model development at various points in the process is an important aspect of managing change and development, keeping track of what is being modified and ensuring the development and design process is on track.

Access to the *Compare* utility is available from:

1. The **Baseline** dialog, from the **Project Browser** context menu, select the **Package Control | Manage Baselines** option.
2. The **Project Browser** context menu; select **Package Control | Compare with XMI File** (for a package not under version control).
3. The **Project Browser** context menu; select **Package Control | Compare with Controlled Version** (for a package under version control).

## Differencing With Baselines

As a Baseline is stored within a model and contains all the information, elements and connections for a package at a point in time, it can be used within Enterprise Architect to track changes to model elements over time. The Differencing engine first builds a representation of the current package in memory, based on what is currently in the model. It then compares this with the stored Baseline, highlighting changes, new elements, missing elements and elements that have been moved to other packages. It is possible to [filter the resultant output](#) to display only one particular kind of change: for example, additions to the model.

If a Baseline has been created to [ignore child package content](#), a comparison between that Baseline and the model does not include any child package content in the model.

See [Example Comparison](#) for an example of a model comparison.

### 3.5.2.2.1.4 Compare Options

The **Compare Options** dialog enables you to refine the output of the Compare utility when it compares the current model with a Baseline. To display the dialog, either:

- Click on the **Options** button on the **Manage Baselines** dialog, or
- Click on the **Compare Options icon**  on the **Compare Utility** tab toolbar.

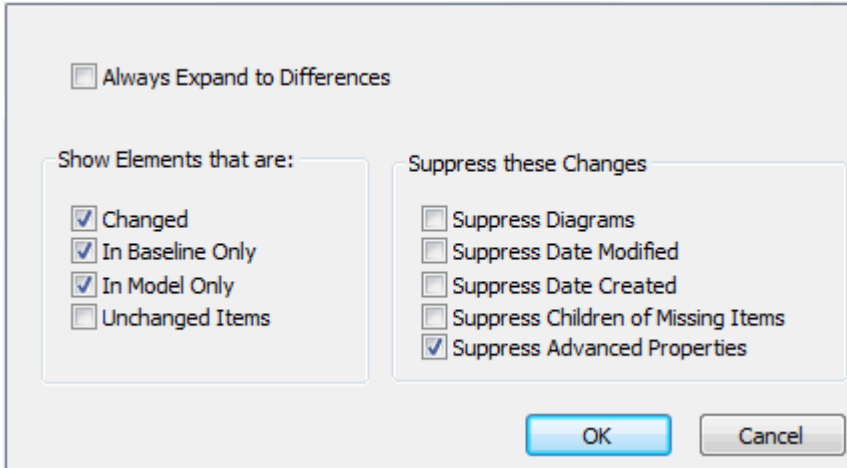

Option	Use to
<b>Always Expand to Differences</b>	Always display the list of elements fully expanded to show changes. If you deselect the checkbox, when the <b>Compare Utility</b> tab is first opened it lists the package contents to element level, and you expand each element as required to show the changed items. For large branches of the model, it is better to leave the checkbox unselected.
<b>Show Elements that are</b>	List elements that: <ul style="list-style-type: none"> <li>• Have been changed since the Baseline was created</li> <li>• Are in the Baseline only (that is, have been deleted from the model since the Baseline was created)</li> <li>• Are in the model only (that is, have been created since the Baseline was created)</li> <li>• Have not changed since the Baseline was created (you might generally leave this checkbox unselected).</li> </ul>
<b>Suppress these Changes</b>	Exclude: <ul style="list-style-type: none"> <li>• Changes to diagrams</li> <li>• Changes to the <b>Date Modified</b> field for an item</li> <li>• Changes to the <b>Date Created</b> field for an item</li> <li>• Child items of a deleted item</li> <li>• Changes to advanced properties (defaults to selected).</li> </ul>

If the **Compare Utility** tab shows the results of a Baseline comparison, when you click on the **OK** button the display refreshes to refine the information according to the options you have selected.

### 3.5.2.2.2 Example Comparison

The diagram below shows the result of a comparison between a package (*Business Process Model*) in the current project and that package in a Baseline (*version 0.1*) captured at an earlier date. Notice that:

- The results are displayed on the **Compare Utility** tab.
- A hierarchy of model elements is displayed in the left-hand pane. It is clearly visible, from the **Status** column and from the triangular icons, which items in the hierarchy have been changed (*Status Changed*), deleted from the model (*Baseline only*), added to the model (*Model only*) and switched to different packages (*Moved*) since the Baseline was captured.



- If you click on an item with a **Status** entry in the left hand pane, the right-hand pane displays a table of properties showing the values of those properties in the current model and in the Baseline. For each property where there is a difference between the model and the Baseline, the row is highlighted. This example shows that the Class element named *Application* was moved from the *Business Process Model* package (as shown in the Baseline) to the *Business Rules Model* package on 5 June 2009 (as shown in the Model).

Property	Model	Baseline
Abstract	false	false
Alias		
Author	Suzanne Pearson	Suzanne Pearson
Date Created	16/01/2009 12:07:15 PM	16/01/2009 12:07:15 PM
Date Modified	5/06/2009 10:15:00 AM	16/01/2009 12:07:30 PM
Complexity	1	1
Filename	C:\Documents and Settings\...	C:\Documents and Settings\...
Language	C#	C#
IsLeaf	false	false
IsSpec	false	false
IsRoot	false	false
Keywords		
Multiplicity		
Name	Application	Application
Notes		
Parent Package	Business Rules Model	Business Process Model
Persistence		
Phase	1.0	1.0
Scope	Public	Public
Status	Proposed	Proposed
Stereotype		
Type	Class	Class
Version	1.0	1.0
Classifier		
Visibility		
Concurrency		
Cardinality		
Style	Locked=false;	Locked=false;
Advanced Properties	\$XREFPROP=\$XID={475E54...}	\$XREFPROP=\$XID={475E54...}

The **Compare Utility** tab enables you to perform operations (such as merging or rolling back changes) on the reported information, using the [toolbar, context menu and keyboard](#) [285].

### Higher Level of Detail

The right panel of the **Compare Utility** tab might, for some fields, display only part of the value (such as **Advanced Properties**, above). It might also not be immediately obvious what a change is. In either case, you can double-click on the property to display full details and to highlight the exact differences. The following example shows the highlighted changes to **Parent Package**.

#### 3.5.2.2.1 Compare Utility Tab Options

The **Compare Utility** tab enables you to perform operations on the reported information, using the toolbar, context menu and certain keyboard keys.

**Note:**

If a package under version control forms part of a Baseline, and that package is checked in to the model, you cannot merge the original data from the Baseline into that package.

### Toolbar

The toolbar is at the top of the left-hand panel. The icons operate either on the comparison as a whole or on

the currently-selected item in the left hand panel.



The toolbar icon names and functions are, from left to right:

Option	Use to
<b>Refresh</b>	Re-run the comparison to refresh the current display.
<b>Merge To Model</b>	Merge the values of the currently-selected item in the Baseline back into the model.
<b>Next Change</b>	Highlight the next changed item (skips <i>Moved</i> items).
<b>Previous Change</b>	Highlight the previously-changed item.
<b>Expand All</b>	Fully expand the selected item.
<b>Collapse All</b>	Collapse the changed items in the selected item.
<b>Expand To Changed Items</b>	Expand the selected item to show changed items only (in the event that you have <a href="#">selected to also show</a> <sup>[284]</sup> unchanged items in the comparison).
<b>Find in Project Browser</b>	Highlight the item in the <b>Project Browser</b> .
<b>Log To XML</b>	Log the changes to an XML file. A browser displays, on which you specify the file name and location.
<b>Compare Options</b>	Display the <a href="#">Compare Options</a> <sup>[284]</sup> dialog.
<b>Manage Baselines</b>	Display the <a href="#">Manage Baselines</a> <sup>[281]</sup> dialog.
<b>Help</b>	Display the Help topic <a href="#">Baselines, Differencing and Merges</a> <sup>[279]</sup> .

## Context Menu

Each item in the hierarchy has a context menu, which you display by right-clicking on the item. The options displayed depend on the level of the item in the hierarchy, but include some or all of the following:

Option	Use to
<b>Merge from Baseline</b> <b>Add from Baseline</b>	Restore the item in the model to the Baseline state, or restore a deleted item from the Baseline.
<b>Delete from Model</b>	Remove a recently-created item from the model.
<b>Merge From Baseline (with Options)</b>	(For the root node of the hierarchy on the <b>Compare Utility</b> tab.) Display the <b>Merge</b> dialog (see below) which enables you to specify options for rolling back the whole model branch to the Baseline state.
<b>Refresh</b>	(Object-level items). Re-run the comparison to refresh the current display.
<b>Find in Project Browser</b>	Locate and highlight the item in the <b>Project Browser</b> .
<b>Expand All</b>	Fully expand the selected item.
<b>Expand To Changed Items</b>	Expand the selected item to show changed items only.

Option	Use to
<b>Collapse All</b>	Collapse the changed items in the selected item.
<b>Log To XML</b>	Log the changes to an XML file. A browser displays, on which you specify the file name and location.
<b>Compare Options</b>	Display the <a href="#">Compare Options</a> <sup>[284]</sup> dialog.

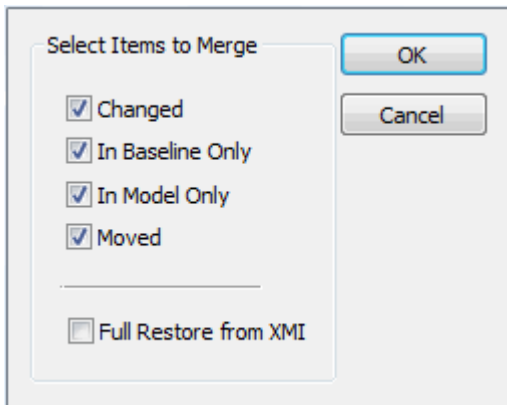

Select the appropriate checkbox against each type of difference to roll back in the model from the Baseline.

Option	Use to
<b>Changed</b>	Restore all changed items in the model branch to the Baseline state.
<b>In Baseline Only</b>	Restore all deleted items to the model branch from the Baseline.
<b>In Model Only</b>	Remove all recently-created items from the model branch.
<b>Moved</b>	Restore all moved items to their original locations, as identified in the Baseline.
<b>Full Restore from XMI</b>	Completely restore the model branch to the version held in the Baseline XMI 1.1 file, (using the XMI Import function). (Automatically selects all the other options.)

### Keyboard

You can also use the following keyboard keys to move up and down the hierarchy, or to roll back changes:

- **[Ctrl]+[↓]** - expand and highlight the next changed item
- **[Ctrl]+[↑]** - expand and highlight the previous changed item
- **[Ctrl]+[←]** - undo the changes for a selected item (roll back to the Baseline values).

### 3.5.3 Model Transfer

Enterprise Architect enables you to transfer data between projects.

The mechanisms available include:

- [XMI Import and Export](#) <sup>[288]</sup> of sections of the model
- [CSV Import and Export](#) <sup>[300]</sup> of sections of the model
- [Data Transfer](#) <sup>[306]</sup> of the whole model between files, and between files and repositories.

### 3.5.3.1 XMI Import and Export

#### What is XMI?

XML Metadata Interchange (XMI) is an open standard file format that enables the interchange of model information between models and tools.

XMI is based on XML, and is defined by the OMG. Enterprise Architect uses XMI as a method of importing and exporting model specifications between different UML packages, Enterprise Architect projects and other tools that support XMI.

Enterprise Architect supports the XMI 1.1, 1.2 and 2.1 specifications, but does not fully support the older 1.0 specification. When importing or exporting to XMI 1.0, some loss of data occurs due to the limitations of XMI 1.0. XMI 1.1 has support for UML 1.3, whereas XMI 2.1 has support for UML 2.0 and UML 2.1.

With XMI, model details can be exchanged between different UML tools and other tools that are capable of using XMI. Limited support for export to Rational Rose is provided using the Rose version of the XMI 1.1 specification, as implemented by Unisys for Rational products.

Packages can be exported from and imported into Enterprise Architect models. This greatly improves the flexibility and robustness of Enterprise Architect models by enabling Analysts and Modelers to externalize model elements in XMI for version control, distributed development, post processing and transferring packages between models. When performing Enterprise Architect-to-Enterprise Architect transfers, ensure that the XMI version selected is 1.1 or 2.1.

#### XMI Tasks

Tasks you might perform in importing and exporting XMI include:

- [Setting XML Options](#)<sup>[367]</sup>: XMI import, export and package control all rely on saving and loading XML files; you can set a number of options to streamline this process
- [Exporting a package](#)<sup>[289]</sup> to XMI in XMI 2.1 (and earlier)
- [Importing from XMI](#)<sup>[290]</sup> with support for XMI 2.1 (and earlier)
- [Setting up controlled packages](#)<sup>[293]</sup>
- [Manually controlling a package](#)<sup>[299]</sup> by linking it to an XMI file
- [Batch exporting](#)<sup>[298]</sup> controlled packages
- [Batch importing](#)<sup>[298]</sup> controlled packages
- [Factoring in the limitations of XMI](#)<sup>[293]</sup>
- [Applying a UML Data Type Definition](#)<sup>[293]</sup> (DTD)

For further information on XMI, including specifications, see the OMG [XML/XMI Technology](#) topic.

#### Important:

When you import an XML file over an existing package, ALL information in the current package is deleted first. Before you import the XML file, please make sure you do not have important changes that you do not want to lose.

#### Notes:

- XMI 2.1 exported by Enterprise Architect 7.0 (or later) might not be correctly imported into earlier versions of Enterprise Architect.
- When you select to apply a DTD during an XMI 1.1 export, the UML\_EA.DTD file is written to the output directory into which the XML files are written (unless the UML\_EA.DTD file is already present in the directory). No error is generated if the UML\_EA.DTD file is not present in this directory during the XMI export.

However, an error does occur if you are importing an XMI 1.1 file that has been exported with the UML\_EA.DTD file, and the UML\_EA.DTD file is not present in the same directory as the XMI file.

### 3.5.3.1.1 Export to XMI

You can export a package to an XMI (XML-based) file.

This enables you to move Enterprise Architect model elements between models, for [distributed development](#) <sup>[183]</sup>, [manual version control](#) <sup>[299]</sup> and other benefits. It also enables limited export of Enterprise Architect model elements to Rational Rose and other tools that implement the:

- UML 2.1 XMI 2.1 standard
- UML1.4 XMI 1.2 standard, or
- UML 1.3 XMI 1.1 / XMI 1.0 standard.

For more information regarding the limitations of XMI exporting, read the [Limitations of XMI](#) <sup>[293]</sup> topic.

#### Notes:

- In the Corporate, Business and Software Engineering, System Engineering and Ultimate editions of Enterprise Architect, if security is enabled you must have [Export XMI](#) <sup>[198]</sup> permission to export to XMI.
- You can post-process the XMI content before saving the package to file, using a style sheet to convert the output to HTML, XSL, code, or other versions of XMI. If you want to do this, you must import the required style sheet into the project through the [Resources](#) <sup>[667]</sup> window.

## Export a Package to XMI

To export a package to XMI, follow the steps below:

1. In the **Project Browser** window, select the package to export.
2. Either:
  - Right-click and select the **Import/Export | Export Package to XMI** context menu option, or
  - Select the **Project | Import/Export | Export Package to XMI** menu option.

The **Export Package to XMI** dialog displays.

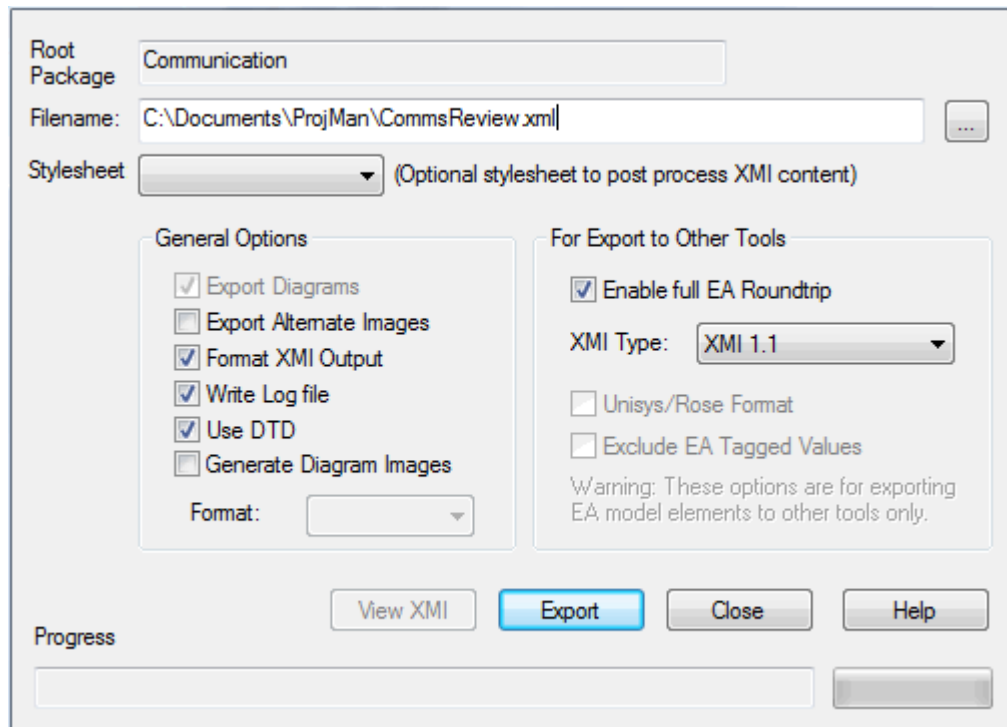

3. In the **Filename** field, type the directory path and filename into which to output the XMI file.
4. If required, in the **Stylesheet** field click on the drop-down arrow and select a stylesheet to post-process XMI content before saving to the file.
5. Select the **Export Diagrams** checkbox to export diagrams in the file.

6. Select the **Export Alternate Images** checkbox to export the alternative images used in the diagrams.
7. Select the **Format XMI Output** checkbox to format output into readable XML (this takes a few more seconds at the end of the run).
8. Select the **Write Log file** checkbox to write a log of export activity (recommended); the log file is saved to the directory into which you export the XMI file.
9. If using XMI 1.1, select the **Use DTD** checkbox to use the UML1.3 DTD (recommended). Setting this option validates the correctness of the model and checks that no syntactical errors have occurred. For more information regarding the use of DTDs, see the [UML DTD](#)<sup>[293]</sup> topic.
10. Leave the **Enable full EA Roundtrip** checkbox selected to keep data specific to Enterprise Architect in the XMI file.
11. In the **XMI Type:** field, click on the drop-down arrow and select the appropriate XMI format:
  - **XMI 1.1**, to generate output in XMI 1.1 format (necessary if you intend to use this file in a [comparison with the model](#)<sup>[283]</sup> at a later time)
  - **XMI 2.1**, to generate output in XMI 2.1 format.
10. Select the **Unisys/Rose Format** checkbox to export in Rose UML 1.3, XMI 1.1 format.
11. Select the **Exclude EA Tagged Values** checkbox to exclude Enterprise Architect-specific information from the export to other tools.
12. Click on the **Export** button.

**Important:**

When exporting and importing with XMI 1.0 with Enterprise Architect, some loss of data occurs due to the limitations of XMI 1.0.

**Notes:**

- XMI 2.1 exported by Enterprise Architect 7.0 (or later) might not be correctly imported into earlier versions of Enterprise Architect.
- When you select to apply a Data Type Definition (DTD) during an XMI 1.1 export, the UML\_EA.DTD file is written to the output directory into which the XML files are written (unless the UML\_EA.DTD file is already present in the directory). No error is generated if the UML\_EA.DTD file is not present in this directory during the XMI export.

**3.5.3.1.2 Import from XMI**

You can import a package from an XMI (XML-based) file. This enables you to move Enterprise Architect Model elements between models, for distributed development, [manual version control](#)<sup>[299]</sup> and other benefits.

**Important:**

- When you import an XML file over an existing package, ALL information in the current package is deleted first. Before you import the XML file, please make sure you do not have important changes that you do not want to lose.
- If you are *importing* an XMI 1.1 file that was previously *exported* with a UML\_EA.DTD file, the UML\_EA.DTD file must be present in the directory into which the XMI file is being written. An error occurs if the UML\_EA.DTD file is absent.

**Note:**

In the Corporate, Business and Software Engineering, System Engineering and Ultimate editions of Enterprise Architect, if security is enabled you must have [Import XMI](#)<sup>[198]</sup> permission to import packages from XMI.

You can import the following formats:

- UML 1.3 (XMI 1.0)
- UML 1.3 (XMI 1.1)
- UML 1.4 (XMI 1.2)
- UML 2.0 (XMI 2.1)
- UML 2.1 (XMI 2.1)

- MOF 1.3 (XMI 1.1)
- MOF 1.4 (XMI 1.2)

Enterprise Architect can also [import the \\*.emx and \\*.uml2 files](#)<sup>[291]</sup> generated by tools such as Rational Software Architect (RSA) and Rational Software Modeler (RSM).

## Import From XMI

To import a package from XMI, follow the steps below:

1. In the **Project Browser** window, select the package into which to import the file.
  2. Either:
    - Right-click and select the **Import/Export | Import Package from XMI** context menu option, or
    - Select the **Project | Import/Export | Import Package from XMI** menu option.
- The **Import Package from XMI** dialog displays.

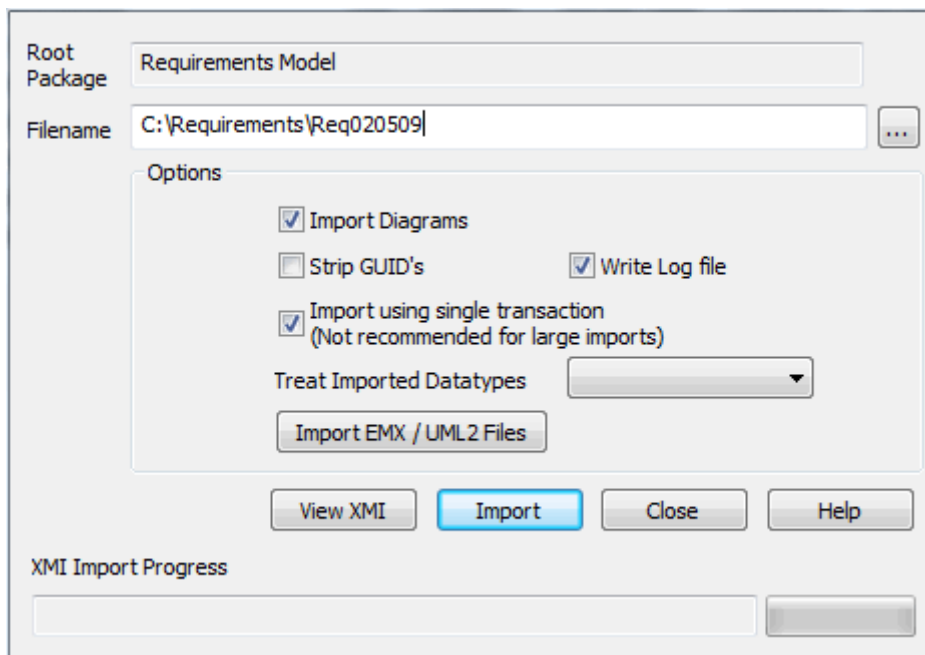

3. In the **Filename** field, type the directory path and filename from which to import the XMI file.
4. Select the **Import diagrams** checkbox to import diagrams.
5. Select the **Strip GUIDs** checkbox to remove Universal Identifier information from the file on import. This enables the import of a package twice into the same model; the second import requires new GUIDs to avoid element collisions.
6. Select the **Write log file** checkbox to write a log of import activity (recommended); the log file is saved in the directory from which the file is being imported.
7. **Import using single transaction** defaults to selected; if the import encounters locking issues, or if you are importing a large XMI file, deselect the checkbox to import the data items separately and identify problem items without blocking the whole import.
8. If you are importing from Rose XMI 1.1, click on the **Treat Imported Datatypes** drop-down arrow and select the datatypes to add to the model.
9. Click on the **Import** button.

### 3.5.3.1.3 Import EMX/UML2 Files

Rational Software Architect (RSA) enables you to add many UML models under a single root.

These models can have cross references between them. However, RSA cannot save the entire root as one file; it saves each UML model as a separate EMX file. This means that an EMX file with cross-references is not self-contained as it references elements in another EMX file.

In releases earlier than release 7.0, Enterprise Architect treats each EMX file as a separate model and hence does not allow for cross-references between them. From release 7.0, Enterprise Architect enables these

cross-references. You therefore have the option of importing a single EMX/UML2 file or a group of EMX/UML2 files. This option enables you to select a group of related files and import them together, thereby retaining the cross-references between the different files.

To import single or multiple \*.emx /\*.uml2 files into Enterprise Architect, follow the steps below:

1. In the **Project Browser** window, select the package into which to import the file.
2. Either:
  - Right-click and select the **Import/Export | Import Package from XMI** context menu option, or
  - Select the **Project | Import/Export | Import Package from XMI** menu option.

The **Import Package from XMI** dialog displays.

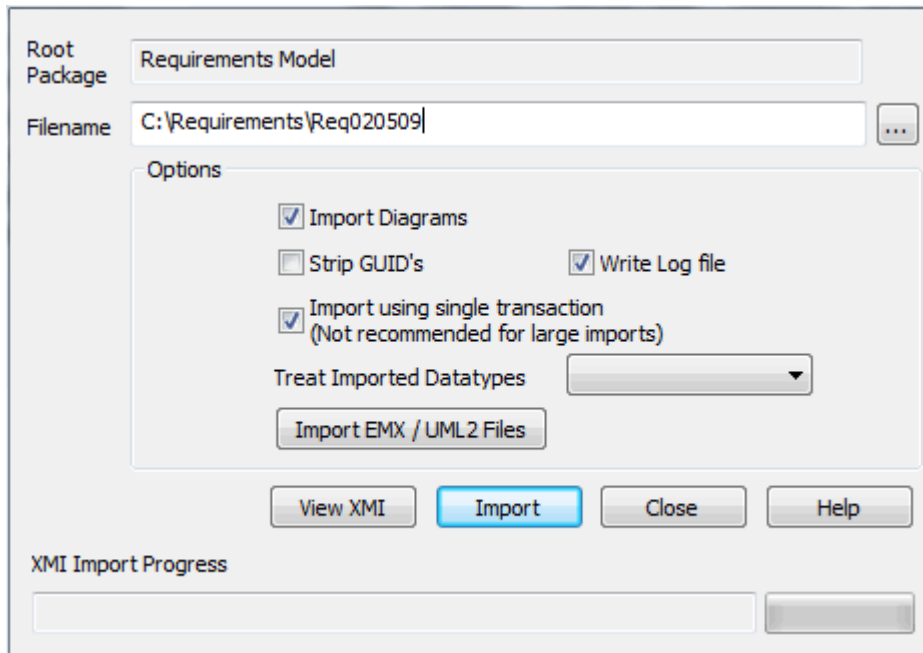

3. Click on the **Import EMX / UML2 Files** button. The **Import Package from XMI** dialog redisplay, formatted for .EMX/.UML2 file imports.

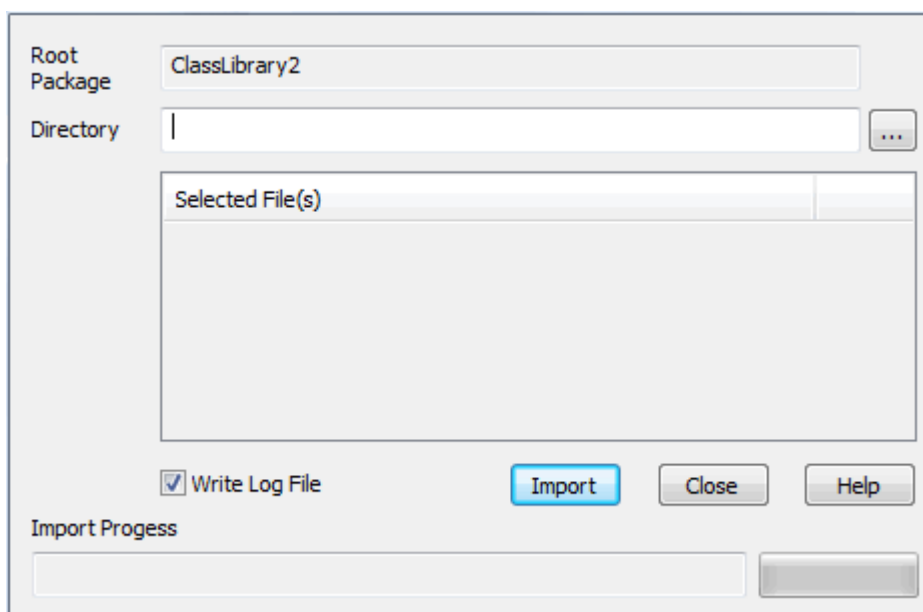

4. Click on the [ ... ] (Browse) button next to the **Directory** field. The **Select Import EMX / UML2 File(s)** dialog displays, which enables you to select multiple files.



5. Select the file or files (use **[Ctrl]+click** or **[Shift]+click** to select several files) and click on the **Open** button. The **Import Package from XMI** dialog redisplay; the **Selected File(s)** panel lists the selected files.
6. Select the **Write Log File** checkbox to write a log of import activity (recommended); the log file is saved in the directory from which the file is being imported, with the name *import.log*.
7. Click on the **Import** button. Enterprise Architect indicates the progress of the import in the **Import Progress** field.

#### 3.5.3.1.4 Limitations of XMI

Whilst XMI is a valuable means of specifying a UML model in a common format, it is relatively limited in the amount of additional information it can tolerate using the standard syntax. A lot of information from an Enterprise Architect Model must be converted to Tagged Values, which import into other modeling systems as additional information or are ignored completely.

Enterprise Architect can both generate and read XMI 1.0 and 1.1 using UML 1.3 format, XMI 1.2 using UML 1.4 format, and XMI 2.1 using UML 2.0 and UML 2.1 format. Note that round-tripping model elements using XMI (for example, to version control or for controlled package) is only possible using *XMI 1.1/UML 1.3 - Enterprise Architect* format, which uses the additional Tagged Values to store the UML 2.0 information.

#### Notes for Exporting to Rose and Other Tools

- There are also discrepancies in the Unisys/Rose implementation with regard to spelling mistakes and slightly different syntax to the official XMI 1.1 specification, so problems might occur.
- The way packages are arranged in different models can impact successful import into other systems. Experimentation is the only work around for this problem.
- Some parts of the XMI import/export process do not work as expected in products like Rational Rose; for example, Note Links are not supported, and State Operations import but do not appear in diagrams. In addition, Rational Rose only supports import of a full project, not a single package.
- For best results, it is recommended that you keep the model elements to export to Rose simple and conforming as closely as possible to the UML 1.3 specification.

#### 3.5.3.1.5 The UML DTD

When you import or export Enterprise Architect packages to XMI, the import or export process can be validated using a Data Type Definition (DTD).

The XML parser uses the DTD to validate the correctness of the model and to check that no syntactical errors have occurred. It is always best to use a DTD when moving packages between Enterprise Architect models as it ensures correctness of the XMI output, and prevents attempted imports of incorrect XML.

Several DTDs for XMI/UML exist. The OMG defines a standard UML1.3 DTD for use in XMI 1.1. Enterprise Architect uses an extension of this with some additional element extensions for non-standard UML types, such as testing details.

Whenever you read an XML file, the XML parser looks in the current directory for the DTD - if specified - using the DOCTYPE element in the XML file. If the parser cannot find the DTD, it records an error and aborts processing. You must ensure the UML\_EA.DTD file is in the current XML output path (generated by default).

#### 3.5.3.1.6 Controlled Packages

Controlled packages are a powerful means of 'externalizing' parts of an Enterprise Architect model. Using controlled packages you can:

- Support widely distributed development by having team members submit packages in the form of XML for import into a central Enterprise Architect repository.
- Support [version control](#)<sup>[228]</sup>, by writing model elements in XML text files suitable for version control using standard version control software. Using XMI this way enables you to manually connect to third-party version control software outside the Enterprise Architect environment. Enterprise Architect internally supports the configuration of version control through SCC and CVS.
- Support import and export of model elements between different models; for example, a Class library can be re-used in many models and kept up to date in target models using controlled packages, reloading packages as required when new versions of the Class model become available.

Package XML is standard XMI-compliant output that can be loaded into any XML viewer, or used by any XML-based tool to perform manipulations and extracts, such as document or code generators.

Controlled packages appear in the **Project Browser** with a small colored rectangle to the left of the package

icon, as shown below for the CIM package:



A controlled package is a package configured to save and load in XML format to a named file. The XML output is UML1.3 compliant XMI, with Enterprise Architect extensions to support diagrams and additional model elements.

#### Important

If you are importing an XMI 1.1 file that was previously exported with a UML\_EA.DTD (Data Type Definition) file, the UML\_EA.DTD file must be present in the directory into which the XMI file is being written. An error occurs if the UML\_EA.DTD file is absent.

#### Note:

When you select to apply a DTD during an XMI 1.1 export, the UML\_EA.DTD file is written to the output directory into which the XML files are written (unless the UML\_EA.DTD file is already present in the directory). No error is generated if the UML\_EA.DTD file is not present in this directory during the XMI export.

### 3.5.3.1.6.1 Controlled Package Menu

The **Package Control** sub-menu is available from the **Project Browser Package** context menu.

This menu is for a package that itself is not under version control (but that might contain child packages that are under version control). For a package that is directly under version control, see the [Package Version Control Menu](#)<sup>[257]</sup> topic.

Menu Option & Function Keys	Use to
<b>Configure (various settings for the package)</b> [Ctrl]+[Alt]+[P]	Display the <a href="#">Package Control Options</a> <sup>[295]</sup> dialog, which enables you to specify whether this package (and its child packages) is controlled and which file it is controlled through.
<b>Manage Baselines</b> [Ctrl]+[Alt]+[B]	Create a <a href="#">Baseline</a> <sup>[287]</sup> of the current package, or compare the current package with a previous Baseline.
<b>Check In Branch</b>	For the selected branch of the model, (that is, the selected package and all of its child packages) display the <a href="#">Select Packages to Check In</a> <sup>[262]</sup> dialog, listing all version controlled packages <i>within</i> that branch that are checked out to you. You can then select packages in the displayed list, to be submitted for check-in.
<b>Check Out Branch</b>	For the selected package, check out the package and <a href="#">recursively check out all of its contained sub-packages</a> <sup>[263]</sup> . Retrieves the latest version of the packages from the central repository, overwriting the current packages. After check out, the packages are available for editing.
<b>Save package to file</b> [Ctrl]+[Alt]+[S]	<a href="#">Save a controlled package</a> <sup>[297]</sup> to an XMI file.
<b>Load package from file</b> [Ctrl]+[Alt]+[L]	<a href="#">Load</a> <sup>[297]</sup> a previously-saved XMI file.
<b>View package XMI</b> [Ctrl]+[Alt]+[X]	Display the package XMI after the package has been exported to XMI.
<b>Compare with XMI file</b>	(Package not under version control.) <a href="#">Compare</a> <sup>[283]</sup> the current package with a previously-saved XMI file of the package.
<b>Add Branch to Version Control</b>	<a href="#">Apply version control to all packages within a selected model branch</a> <sup>[264]</sup> , in a single operation.

Menu Option & Function Keys	Use to
<b>Export as Model Branch</b>	<a href="#">Export</a> [264] a newly created model branch from your own private copy of a model.
<b>Import a Model Branch</b>	<a href="#">Retrieve</a> [265] a model branch and import it into either the source model or another model.
<b>Get package (for version control)</b>	Enables you to gain access from packages in the <a href="#">version-controlled</a> [228] repository that is currently available in your model.
<b>Get All Latest (for version control)</b>	Retrieve the latest <a href="#">version</a> [228] of the package from the repository. Available only for packages that are checked in.  The alternative option <b>Get Latest</b> - if displayed - is not intended for sharing .EAP files and should only be used when users have their own individual databases.
<b>Re-synch Status With VC Provider</b>	(Version controlled package.) Update the version control status value recorded for the selected package in the Enterprise Architect project to <a href="#">match the value reported by the version control provider</a> [267], without performing an XMI import or export.
<b>Version Control Settings</b>	Display the <a href="#">Version Control Settings</a> [234] dialog.
<b>Update Package Status</b>	Provide a bulk <a href="#">update on the status of a package</a> [340]. This includes status options such as <b>Proposed</b> , <b>Validate</b> and <b>Mandatory</b> .

### 3.5.3.1.6.2 Configure Packages

Before you can use a controlled package, you must configure it with options such as the filename to save to/load from, the type of export and the version number.

Once a package is configured and marked as controlled, it is displayed in the **Project Browser** with a small colored rectangle next to the package icon, indicating it is a controlled package. In the example below, the *RQ01: Formal Requirements* package is a controlled package.

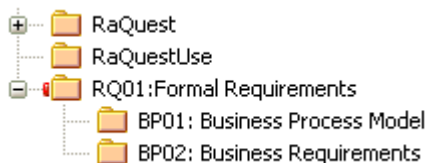

**Note:**

In the Corporate, Business and Software Engineering, System Engineering and Ultimate editions of Enterprise Architect, if security is enabled you must have [Configure Packages](#) [198] permission to configure controlled packages and package properties.

### Configure a Controlled Package

To configure a controlled package, follow the steps below:

1. In the **Project Browser**, right-click on the package to control or configure. The context menu displays.
2. Click on the **Package Control | Configure** menu option. The **Package Control Options** dialog displays.

3. Set the required options, as follows:

- Select the **Control Package** checkbox to indicate that this is a controlled package
- Click on the **Version Control** drop-down arrow and select the version control repositories; this connects the package to a specific version control configuration
- In the **XMI Filename** field, type or browse for the path and XMI file for importing and exporting XMI files. The field accepts Local Path Substitution strings; for example, use an XMI local path definition where:

```
myLocalPath="C:\Documents and Settings\John\Desktop\EA Models"
```

Then %myLocalPath%\CIM.xml is equivalent to C:\Documents and Settings\John\Desktop\EA Models\CIM.xml

- In the **UML/XMI Type** field, click on the drop-down arrow and select the type of XMI generated; options include Enterprise Architect XMI/UML 1.3, Rational Rose/Unisys UML 1.3 and Generic XMI 1.0/UML 1.3 - currently only Enterprise Architect UML 1.3 is supported for complete import/export round tripping of packages
- In the **Version ID** field, type the version ID number
- In the **Owner** field, type or select the name of the package owner
- If required, click on the **Use DTD** checkbox to use a Data Type Definition (DTD)
- If required, click on the **Log Import/Export** checkbox to log import and export activity to a log file
- If required, click on the **Batch Import** checkbox to mark the package as a Batch Import package
- If required, click on the **Batch Export** checkbox to mark the package as a Batch Export package
- If required, click on the **Include sub-package** checkbox to *deselect* it, to include only the immediate contents of the package in an XMI export (XMI stubs); this is available only for an XMI 1.1/UML 1.3 export. If you leave the checkbox selected, the entire sub-package hierarchy of this branch is included in the export.

4. Click on the **OK** button to set the Package Control options.

**Note:**

For batch import, the file date of the XMI file is stored. You can bypass the batch import if the file date of the last import matches that of the current file (that is, there is no change).

### 3.5.3.1.6.3 Remove Package from Control

If required, you can remove the control from a package. Before removing the package control, you must [check in](#) <sup>[26]</sup> the package if it is being used for version control.

To remove control from a package:

1. In the **Project Browser** window, right-click on the controlled package. The context menu displays.

2. Select the **Package Control | Configure** menu option, or press **[Ctrl]+[Alt]+[P]**. The **Package Control Options** dialog displays.
3. Deselect the **Control Package** checkbox. If the package is under version control, this sets the **Version Control** field to **(None)**.

4. Click on the **OK** button to remove package control.

Package control for the selected package has now been removed.

#### Note:

When disconnecting a package from version control, the association between the package and the exported XML file is removed from your model. However, the XML file itself is not removed from version control, nor is it deleted from your local version control working copy folder. This is because it is possible for another model to be using the version controlled package and still referencing the associated version controlled XML file.

#### 3.5.3.1.6.4 Save a Package

You can save a controlled package to an XMI file. Once you have correctly [configured](#)<sup>295</sup> the package, follow the steps below:

1. In the **Project Browser** window, right-click on the package to save. The context menu displays.
2. Select the **Package Control | Save Package to File** menu option.
3. The export process executes automatically according to your configured preferences, overwriting any existing file.

#### Note:

If you are using a version control package in conjunction with the exported package files, you must check out the XMI file first to enable Enterprise Architect to overwrite the existing version.

#### 3.5.3.1.6.5 Load a Package

Using the *Controlled Packages* facility, you can save and load packages to a named file.

If a package has been marked for control it is displayed in the **Project Browser** with a red rectangle to the left of the package icon. If you have previously saved a controlled package, you can reload it using the **Load package from file** menu option.

To load a controlled package, follow the steps below:

1. In the **Project Browser** window, right-click on the package to load. The context menu displays.
2. Select the **Package Control | Load package from file** menu option.

3. If you have configured the package control details, Enterprise Architect prompts you to confirm the import.

**Warning:**

Importing deletes the current package entirely from the model, and the action cannot be undone. You must be careful not to lose any current changes or information.

4. Click on the **Yes** button to confirm the import. The current package is deleted and the saved package is imported.

### 3.5.3.1.6.6 Batch XMI Export

You can export a group of controlled packages in one step, using the *Batch XMI Export* facility.

To export a group of controlled packages, follow the steps below:

1. Select the **Project | Import/Export | Batch XMI Export** menu option. The **Batch XMI Export** dialog displays.

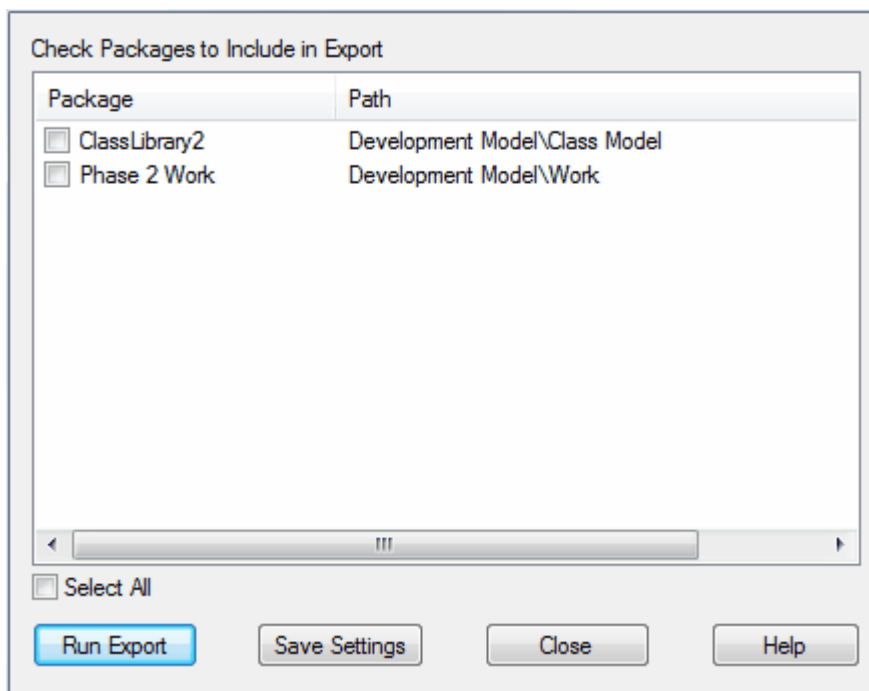

2. Select the checkbox against each package to include in this export run. Select the **Select All** checkbox to select all packages in the list.
3. To save this configuration as the default, click on the **Save Settings** button.
4. Click on the **Run Export** button.

Enterprise Architect cycles through each checked package and exports it using the options specified in the [Package Control Options](#) <sup>(295)</sup> dialog. As long as a valid filename exists, Enterprise Architect exports the package to XML and proceeds to the next package.

### 3.5.3.1.6.7 Batch XMI Import

You can import a group of controlled packages in one step, using the *Batch XMI Import* facility.

To import a group of controlled packages, follow the steps below:

1. Select the **Project | Import/Export | Batch XMI Import** menu option. The **Batch XMI Import** dialog displays.

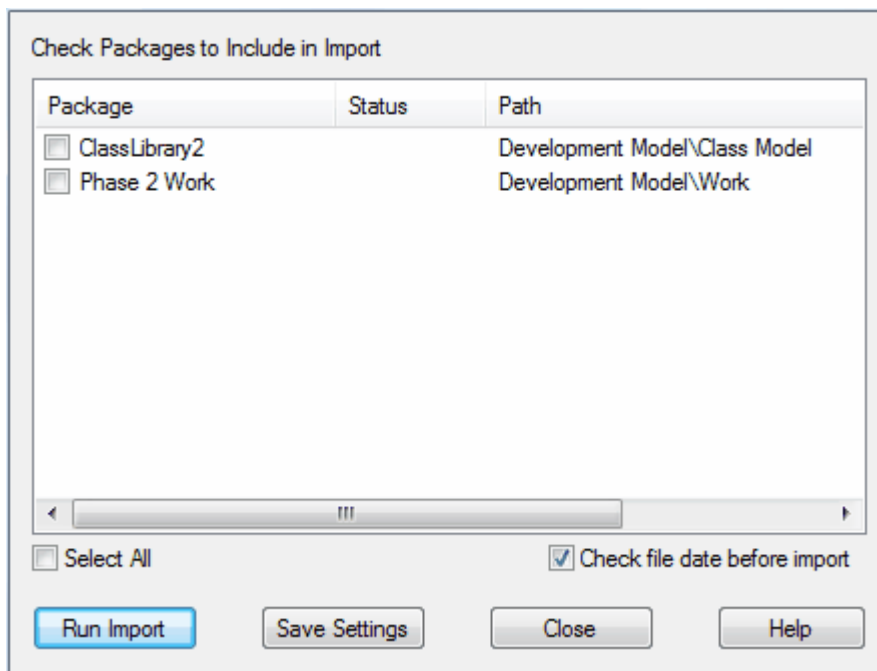

2. Select the checkbox against each package to include in the import. Select the **Select All** checkbox to select all packages in the list.

**Tip:**

To avoid re-importing the same module multiple times, select the **Check file date before import** checkbox. Enterprise Architect then does not import a file if the last import file date matches that of the one currently on disk.

3. To save this configuration as the default, click on the **Save Settings** button.
4. Click on the **Run Import** button. Enterprise Architect cycles through the packages and imports each selected package.

As Enterprise Architect processes each package, it updates the **Status** column against each package name on the **Batch XMI Import** dialog.

- If the import is successful, Enterprise Architect updates the package status to **Imported**.
- If the import is unsuccessful, Enterprise Architect updates the package status to **Not Imported**.

Common reasons for an import to fail include:

- The package not being correctly configured
- The last import file date matches the import date of the file currently on disk.

### 3.5.3.1.6.8 Manual Version Control with XMI

You can use XMI to support version control by writing model elements in XML text files suitable for use with standard version control software.

Using XMI in this manner enables you to manually connect to third-party version control software outside the Enterprise Architect environment. Enterprise Architect internally supports the configuration of version control through SCC and CVS configurations.

To use XMI for version control, you must first:

1. Select suitable packages in the **Project Browser** window, to be marked as controlled packages.
2. Configure these with filenames that are visible to a version control system of your choice.
3. Save the controlled packages to establish a model base and check these into the version control system.

## When Versioning is Required

Continue working on a package until versioning is required then follow the steps below:

1. Check out the package XMI file from the version control system.
2. Save the relevant package using the controlled package support.
3. Check the package back into the version control system.

### Recover an Earlier Version

To recover an earlier version, follow the steps below:

1. Save the current version first (this is **important**, because the package is completely deleted during the import process) and manually update the version control system if necessary.
2. Get the required package version from the version control system.
3. Select the package to reload.
4. Select the **Package Control | Load package from file** menu option to import the previous version. Enterprise Architect deletes the controlled package and restores the previous version.

### 3.5.3.2 CSV Import and Export

You can [import](#) and [export](#) information about Enterprise Architect elements in CSV format.

You must define [CSV specifications](#) to do this, because the specification defines what types of value from the spreadsheet are to be imported, and how the information is translated between the spreadsheet and Enterprise Architect.

#### 3.5.3.2.1 CSV Specifications

To [import](#) and [export](#) element data from Enterprise Architect using CSV files, you must first set up one or more file specifications.

A file specification lists the fields from the spreadsheet in the order they are imported or exported, the filename (optional) and the delimiter between columns. Once you have defined one or more specifications, one can be selected in the **CSV Import/Export** dialog as the current specification to apply during an import or export action.

CSV only imports and exports elements (within packages) and their properties; items such as Class attributes cannot be imported or exported through this mechanism. [XMI](#) import/export provides a solution to this limitation, as does use of the [Automation Interface](#) (Object Model).

To define a specification, select the **Project | Import/Export | CSV Import/Export Specifications** menu option. The **CSV Import/Export Specification** dialog displays.



The **CSV Import/Export File Specification** dialog provides the following functionality:

Option	Use to
<b>Specification Name</b>	Select the unique name for this specification.
<b>Delimiter</b>	Specify the character delimiter to use between record fields.  <b>Note:</b> If a field contains an instance of the delimiter, the field is exported wrapped in " (quotation marks) and all instances of " in the field are doubled (that is, " becomes "").
<b>Notes</b>	Record a brief description of the specification.
<b>Default Filename</b>	Select the default filename.
<b>Default Direction</b>	Set the default action - <b>Import</b> or <b>Export</b> . A specification can be used in either direction, but this enables you to set the default type.
<b>Default Types</b>	Limit the element types being exported, by entering a comma-separated list: for example, <i>class,requirement,component,node,object</i> .

Option	Use to
	<p><b>Note:</b></p> <p>If you specify element types, ONLY elements of those types are exported or imported. Therefore, in order to enable the <b>Preserve Hierarchy</b> option to operate (if selected) you must include Package as an element type. Otherwise there are no packages in which to preserve the hierarchy.</p> <p>If you do not specify any default element types, all elements including Packages are exported or imported and the hierarchy can be preserved.</p>
<b>Preserve Hierarchy</b>	Include fields generated by Enterprise Architect to embed/reconstruct the package hierarchy. See the <a href="#">Using Preserve Hierarchy</a> <sup>[302]</sup> section for more details.
<b>Available Fields</b>	Select from a list of possible record fields, not yet allocated.
<b>File Specification</b>	List the record fields (in the order they are plotted across the spreadsheet) already assigned.
<b>Add Field</b>	Move all selected fields in the top list to the bottom list.
<b>Remove Field</b>	Move all selected fields in the bottom list back to the available list.
<b>New</b>	Create a new specification.
<b>Save</b>	Save changes to the currently selected specification.
<b>Save As</b>	Save the current specification with a new name.
<b>Delete</b>	Delete the current specification.
<b>Close</b>	Close this dialog.

**Note:**

In **Available Fields** and **File Specification**, the record fields **Created Date** and **Modified Date** are not set when imported from CSV.

### Using Preserve Hierarchy

When selected, the **Preserve Hierarchy** option inserts two fields into the CSV specification that are:

- automatically populated by Enterprise Architect on export and
- used to reconstruct the exported package's hierarchy upon import.

Field	Description
<b>CSV_KEY</b>	<p>A unique identifier for the current element.</p> <p><b>Note:</b></p> <p>This key is unique per export; subsequent exports produce different keys for the same set of elements.</p>
<b>CSV_PARENT_KEY</b>	The corresponding CSV_KEY of the current element's parent. If the field is left blank or references a non-existent CSV_KEY, the element is added to the top level of the package.

However, if you intend to import hierarchical information from a spreadsheet that was not populated by exporting data from Enterprise Architect, you must add these two fields to your spreadsheet as the last two columns, and populate the columns yourself. For example:

NAME	TYPE	NOTES	PRIORITY	STATUS	CSV_KEY	CSV_PARENT_KEY
Requirement Package	Package	Notes Package1			Package1	
REQ1	Requirement	Notes on REQ1	High	Approved	REQ1	Package1
REQ2	Requirement	Notes on REQ2	High	Approved	REQ2	Package1
REQ2.1	Requirement	Notes on REQ2.1	High	Approved	REQ2.1	REQ2
REQ2.2	Requirement	Notes on REQ2.2	Med	Approved	REQ2.2	REQ2
REQ2.3	Requirement	Notes on REQ2.3	High	Approved	REQ2.3	REQ2
REQ3	Requirement	Notes on REQ3	High	Approved	REQ3	Package1
REQ3.1	Requirement	Notes on REQ3.1	High	Approved	REQ3.1	REQ3
REQ3.2	Requirement	Notes on REQ3.2	High	Approved	REQ3.2	REQ3
REQ4	Requirement	Notes on REQ4	High	Approved	REQ4	Package1
REQ4.1	Requirement	Notes on REQ4.1	High	Approved	REQ4.1	REQ4
REQ4.2	Requirement	Notes on REQ4.2	High	Approved	REQ4.2	REQ4
REQ4.3	Requirement	Notes on REQ4.3	High	Approved	REQ4.3	REQ4

**Note:**

It is highly recommended that you do not change these fields by hand if they **have** been automatically generated by Enterprise Architect's CSV exporter.

**3.5.3.2.2 CSV Export**

It is possible to export information about Enterprise Architect elements in CSV format. Once you have defined a CSV [export specification](#)<sup>[300]</sup> it is possible to write out major element characteristics to a CSV text file.

**Note:**

In the Corporate, Business and Software Engineering, System Engineering and Ultimate editions of Enterprise Architect, if security is enabled you must have *both* [Export XMI](#)<sup>[198]</sup> and [Import XMI](#)<sup>[198]</sup> permissions to use the **CSV Import/Export** option.

**Export Data in CSV Format**

To export data in CSV format, follow the steps below:

1. In the **Project Browser**, right-click on the package containing the elements to export.
2. Select the **Import/Export | CSV Import/Export** context menu option. The **CSV Import/Export** dialog displays.

Package: System Model

Specification: Generate Edit/New...

File: C:\EA\Generate\Packagew\GenfileCSV.csv ...

Types: Genfile:GUID

Action

Import  Export

Progress: Results

Print Results View File Run Close Help

3. Set the required options, as outlined below:

Option	Use to
<b>Package</b>	Confirm the name of the current selected package.
<b>Specification</b>	Specify the name of the <a href="#">export specification</a> <sup>[300]</sup> to use.
<b>Edit/New</b>	Edit the export specification or create a new one.
<b>File</b>	Specify the filename to export to.
<b>Types</b>	List the element types to export: leave blank for all, or enter a comma-separated list of types.  <b>Note:</b> If you specify element types, <b>ONLY</b> elements of those types are exported. Therefore, in order to enable the <b>Preserve Hierarchy</b> option in the specification to operate (if selected) you must include Package as an element type. Otherwise no Packages are exported in which to preserve the hierarchy.  If you do not specify any element types, all elements including Packages are exported and the hierarchy can be preserved.
<b>Action</b>	Select the <b>Export</b> radio button to export to file.
<b>Print Results</b>	Print out the result list.
<b>View File</b>	View the resultant CSV file with the default Windows application for CSV files.
<b>Run</b>	Perform the export.
<b>Close</b>	Exit this dialog.

### 3.5.3.2.3 CSV Import

It is possible to import information about Enterprise Architect elements in CSV format. Once you have defined a CSV [import specification](#) <sup>[300]</sup> you can read in major element characteristics from a CSV text file.

#### Notes:

- In the Corporate, Business and Software Engineering, System Engineering and Ultimate editions of Enterprise Architect, if security is enabled you must have *both* [Export XMI](#) <sup>[198]</sup> and [Import XMI](#) <sup>[198]</sup> permissions to use the **CSV Import/Export** option.
- You import the CSV file into a selected package; if this package or any element within the package has a lock on it, you cannot import the CSV file into it. The **Import** option on the dialog is grayed out.

When importing, Enterprise Architect checks the specification to see if there is an **EAGUID** field included. If there is, Enterprise Architect attempts to locate the element identified by the EAGUID and, if successful, updates the current element rather than creating a new one. If no **EAGUID** field is defined, or Enterprise Architect cannot locate the identified element, a new element is created and placed in the current package. Note that during import, **Type** is a mandatory field in the source file and must match one or more of the legal [Enterprise Architect element types](#) <sup>[1715]</sup>. For example: *requirement*, or *class*.

The format and content of the source data file should resemble the following:

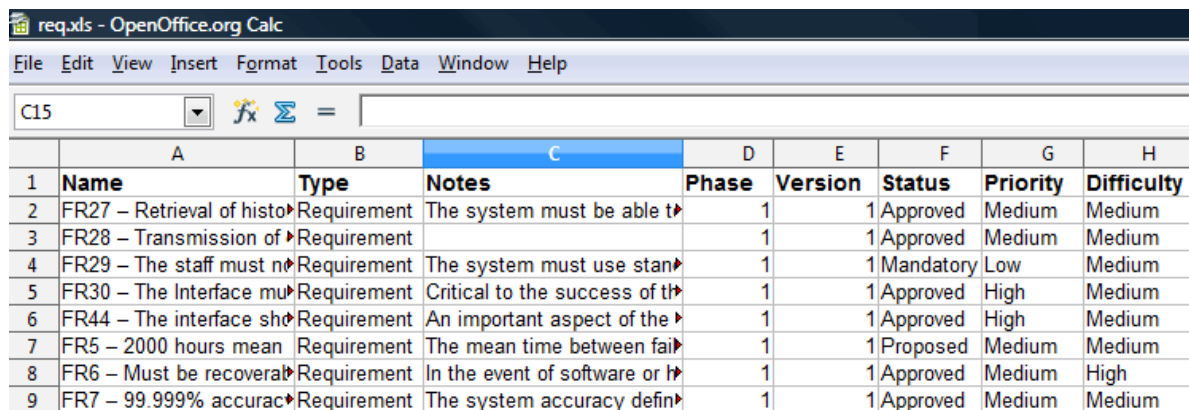

	A	B	C	D	E	F	G	H
1	Name	Type	Notes	Phase	Version	Status	Priority	Difficulty
2	FR27 – Retrieval of histo	Requirement	The system must be able to	1	1	Approved	Medium	Medium
3	FR28 – Transmission of	Requirement		1	1	Approved	Medium	Medium
4	FR29 – The staff must n	Requirement	The system must use stan	1	1	Mandatory	Low	Medium
5	FR30 – The Interface mu	Requirement	Critical to the success of th	1	1	Approved	High	Medium
6	FR44 – The interface sho	Requirement	An important aspect of the	1	1	Approved	High	Medium
7	FR5 – 2000 hours mean	Requirement	The mean time between fai	1	1	Proposed	Medium	Medium
8	FR6 – Must be recoverab	Requirement	In the event of software or h	1	1	Approved	Medium	High
9	FR7 – 99.999% accurac	Requirement	The system accuracy defin	1	1	Approved	Medium	Medium

### Import Data in CSV Format

To import data in CSV format, follow the steps below:

1. In the **Project Browser**, right-click on the package to import into.
2. Select the **Import/Export | CSV Import/Export** context menu option. The **CSV Import/Export** dialog displays.

Package: System Model

Specification: Generate Edit/New...

File: C:\EA\quicklinkMap.csv ...

Types: |

Action

Import  Export

Progress:

Results

Print Results View File Run Close Help

3. Set the required options; as outlined below:

Option	Use to
<b>Package</b>	Confirm the name of the current selected package.
<b>Specification</b>	Specify the name of the <a href="#">import specification</a> <sup>[300]</sup> to use.
<b>Edit/New</b>	Edit the import specification or create a new one.
<b>File</b>	Specify the spreadsheet filename to import from.
<b>Types</b>	Not used for import.
<b>Action</b>	Select the <b>Import</b> radio button to import from the file. (Grayed-out if the package or a child item in the package is locked.)
<b>Print Results</b>	Print out the result list.
<b>View File</b>	View the source CSV file with the default Windows application for CSV files.
<b>Run</b>	Perform the import.
<b>Close</b>	Exit this dialog.

### 3.5.3.3 Project Data Transfer

The Corporate, Business and Software Engineering, System Engineering and Ultimate editions of Enterprise Architect support [SQL Server](#)<sup>[126]</sup>, [MySQL](#)<sup>[123]</sup> and [Oracle 9i, 10g and 11g](#)<sup>[129]</sup> data repositories. At some point, it might become necessary to move a complete model from one repository to another, row by row, table by table.

The project data transfer function enables you to perform the following tasks:

- Upload an existing .EAP file to a SQL Server or MySQL repository
- Download a repository in MySQL or SQL Server to a .EAP file

- Move a repository from SQL Server to MySQL or from one server to another
- Move all records from a .EAP file with replication to a model with none (Remove Replication)
- Copy all records from a .EAP file to another (recommended after serious network crash or repeated database corruption)
- Copy all records from a JET 3.5 to JET 4 (Access 2000 or XP) repository - or back the other way.

See the [Perform a Project Data Transfer](#)<sup>[307]</sup> topic for instructions.

**Warning:**

All records in the target repository are overwritten.

**Note:**

You cannot move a model from a source .EAP file of a version earlier than 3.5.0.

### 3.5.3.3.1 Perform a Project Data Transfer

**Warning:**

During a project data transfer, all records in the target project are overwritten. Before performing the transfer, take a backup of the target project to ensure that you can recover any important information it contains.

**Notes:**

- In the Corporate, Business and Software Engineering, System Engineering and Ultimate editions of Enterprise Architect, if security is enabled you must have [Transfer Data](#)<sup>[198]</sup> permission to transfer project data between repositories.
- You cannot move a model from a source .EAP file of a version earlier than 3.5.0.
- You must transfer data into a *repository* (where scripts have been run to set up tables), not just a database. If necessary, follow the steps below:
  - Install the DBMS software and create a database. Ensure that the collation is set to the alphabet you use, such as Latin or Cyrillic.
  - Run a script supplied by Sparx Systems ([http://www.sparxsystems.com/resources/corporate/index.html#sql\\_scripts](http://www.sparxsystems.com/resources/corporate/index.html#sql_scripts)) to create the required tables.

To perform a project data transfer, follow the steps below:

1. Select the **Tools | Data Management | Project Transfer** menu option. The **Project Transfer** dialog displays.

2. Click on the option for the required transfer type. You can choose from:
  - **.EAP to .EAP**
  - **DBMS to .EAP**
  - **.EAP to DBMS**
  - **DBMS to DBMS**
3. In the **Source Project** and **Target Project** fields, type or select the name or connection string for the Source and Target projects.
4. If you want to capture the transfer in a log file, select the **Logfile** checkbox and browse for the appropriate log file location.
5. Click on the **Transfer** button.

It is good practise to do a [Project Compare](#) <sup>[308]</sup> after this process to verify that all records are written.

### 3.5.3.3.2 Why Compare Projects?

It is sometimes useful to compare the size and row counts of two projects; for example, after a database crash, after import from XMI or after performing a deletion of model elements.

You can compare .EAP files to other .EAP files or to DBMS based repositories, or compare two DBMS repositories. Enterprise Architect examines the number of rows in each database and produces a report indicating the total records in each and the difference between the two. No examination is made of the data in the table, just the record count.

Comparing projects this way is a convenient 'sanity check' after restoring a backup or doing a project data transfer. If discrepancies are found, you must investigate further manually.

See the [Compare Projects](#) <sup>[308]</sup> topic for instructions.

### 3.5.3.3.3 Compare Projects

To compare projects, follow the steps below:

1. Select the **Tools | Data Management | Project Compare** menu option. The **Project Compare** dialog displays:



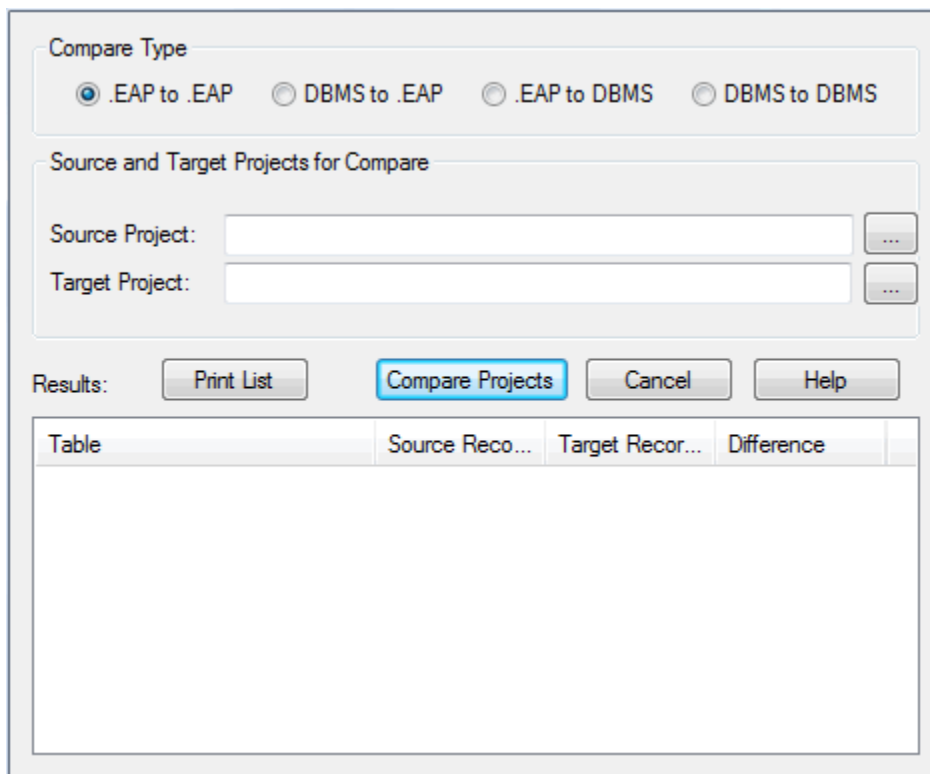

2. Select the option for the required comparison type. You can choose from:
  - **.EAP to .EAP**
  - **DBMS to .EAP**
  - **.EAP to DBMS**
  - **DBMS to DBMS**
3. In the **Source Project** and **Target Project** fields, type the name or connection string for the Source and Target projects.
4. Click on the **Compare Projects** button. The results of the comparison display in the panel at the bottom of the dialog.
5. If required, click on the **Print List** button to print the results.

#### 3.5.3.3.4 Copy Packages Between Projects

Using the XML import/export capabilities of Enterprise Architect, you can copy and move packages between Enterprise Architect projects. This gives you a high level of flexibility in building a project from re-usable parts and from elements produced in widely-dispersed geographic regions.

This procedure, with the **Strip GUID's** checkbox selected (see step 8, below) is effectively the same as [copying packages](#)<sup>[388]</sup> within or between models. You would tend to use this export/import procedure for duplicating larger structures, such as complete models or projects, although exporting and importing individual child packages within the same model is just as feasible. You cannot export and import specific elements using this procedure, but the process of [copying elements](#)<sup>[537]</sup> within or between packages, models and projects is derived from it.

#### Procedure

To copy a package from one Enterprise Architect project to another, follow the steps below:

1. Open the Enterprise Architect project to copy from.
2. In the **Project Browser**, right-click on the package to copy. The context menu displays.
3. Select the **Import/Export | Export package to XMI file** menu option. The **Export Package to XMI** dialog displays.

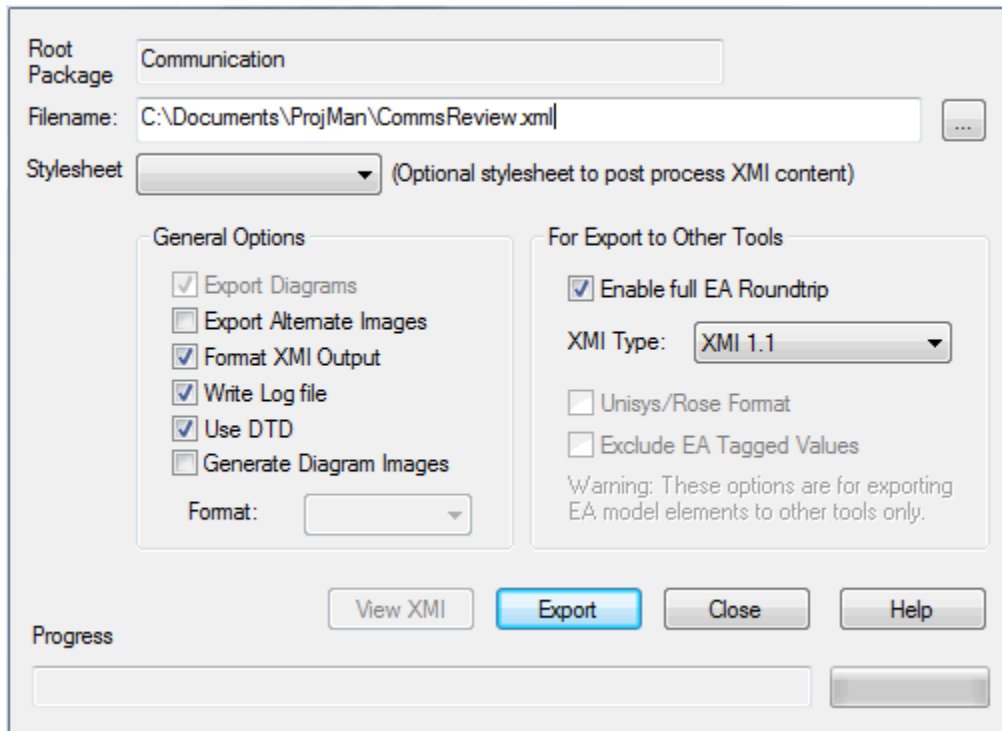

4. Select the appropriate options and filename (see the [Export to XMI](#)<sup>[289]</sup> topic for further information).
5. Click on the **Export** button to begin the export process.
6. When the export is complete, open the recipient Enterprise Architect project. In the **Project Browser**, navigate to the location to import the package into.
7. Right-click to display the context menu, and select the **Import/Export | Import package from XMI file** menu option. The **Import Package from XMI** dialog displays.

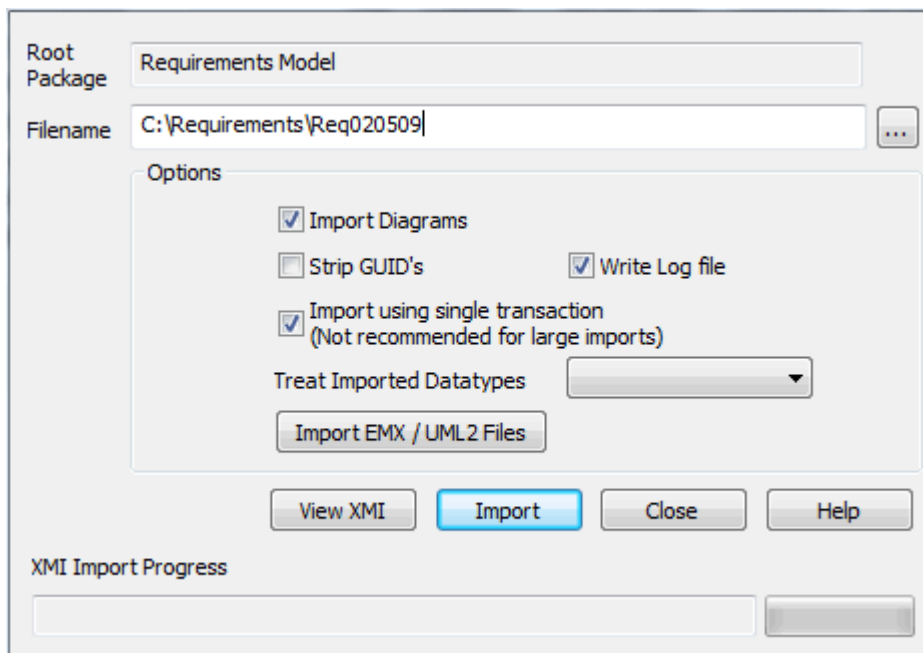

8. Select the appropriate options and filename (see the [Import from XMI](#)<sup>[290]</sup> topic for further information).
9. Click on the **Import** button. The package is copied from the source project to the destination project.

**Note:**

If the package you are importing already exists in the target project (that is, it has been imported previously), you must either import over the existing package or select the **Strip GUIDs** option, in which case Enterprise Architect creates a replica of the original package.

## 3.6 Project Management



Enterprise Architect provides strong support for Project Management, in estimating project size, measuring risk and effort, and assigning resources to elements. Enterprise Architect also provides support for change control and maintenance.

### Metrics and Estimation

Project [estimation](#)<sup>[335]</sup> is working out how much time and effort is required to build and deploy a solution. Enterprise Architect provides the *Use Case metrics* facility as a means of measuring the complexity of a system and getting an indication of the effort required to implement the model, and the project timescale. You base these estimates on carefully-calibrated metrics.

### Resource Management

[Resources](#)<sup>[313]</sup> are the people who work on a project. You can assign roles to them and allocate tasks on specific model elements, which enables tracking of effort and estimation of time to complete.

### Project Maintenance

During a project you monitor and manage the development and progress of individual model elements. You can record [problems, changes, issues and tasks](#)<sup>[1568]</sup> that affect these individual elements as they arise, and document the solution and associated details.

Similarly, Enterprise Architect helps you to manage [changes and issues](#)<sup>[1563]</sup> that apply to the whole system.

### Project Tasks and Issues

In the course of a project, there are various non-technical [tasks](#)<sup>[329]</sup> that are vital to the successful management and completion of the project, such as meetings. Enterprise Architect helps you to record and monitor these, and to manage non-technical [project issues](#)<sup>[331]</sup> as they arise.

#### See Also

- [The Project Management Window](#)<sup>[312]</sup>
- [The System Window](#)<sup>[323]</sup>
- [Project Glossary](#)<sup>[323]</sup>
- [Update Package Status](#)<sup>[340]</sup>
- [Manage Bookmarks](#)<sup>[341]</sup>
- [Monitor Events](#)<sup>[342]</sup>

### 3.6.1 The Project Management Window

Access: **View** | **Other Element Tools** | **Project Management**.

The **Project Management** window enables you to input the [resources](#)<sup>[314]</sup>, [effort](#)<sup>[315]</sup>, [risks](#)<sup>[316]</sup> and [metrics](#)<sup>[317]</sup> that can be added to elements contained in the model.

Resource	Role	Allocated Time	% Completed	Start	End	Description
Frederick Walter	C++ Programmer	10.000000	20	25/02/2009	11/03/2009	Code Quality Validation module
John Redfern	Developer	15.000000	45	25/02/2009	17/03/2009	Model validation process

Click on an element in the [Project Browser](#) <sup>[1209]</sup> to display project management information for that element in the **Project Management** window.

Right-click on the list to view the context menu, which enables you to [add and delete list items](#) <sup>[330]</sup>.

## Toolbar



These buttons have the following functions (in order as shown on the toolbar):

- **New:** Create new item
- **Save:** Save changes to an item
- **Save As New:** Enables you to duplicate an existing entry. You must change an item's Role for this to become enabled
- **Delete:** Delete an item from the list
- **Sort:** Sort Items in the list into alphabetical order
- **Print:** Print item data from the list
- **Browse Element:** Display the [Element Browser](#) <sup>[510]</sup> window for the selected element, to list and select the project management items for the element
- **Show/Hide Details:** Swap between detailed and summary new window styles
- **Help:** Show help contents for this window.

## 3.6.2 Project Resources

### What is a Resource?

Resources are the people who work on a project. They can be assigned roles and allocated tasks, which enables tracking of effort and estimation of time to complete.

#### Note:

In the Corporate, Business and Software Engineering, System Engineering and Ultimate editions of Enterprise Architect, if security is enabled you must have [Manage Project Information](#) <sup>[198]</sup> permission to update and manage project resources, effort, metrics and risks.

### Project Management Window

Resources are added, modified and deleted from the **Project Management** window. To access this window, select the **View | Other Element Tools | Project Management** menu option, or press **[Ctrl]+[Shift]+[7]**.

The window has two formats, as illustrated below - *Item* mode and *List* mode respectively.

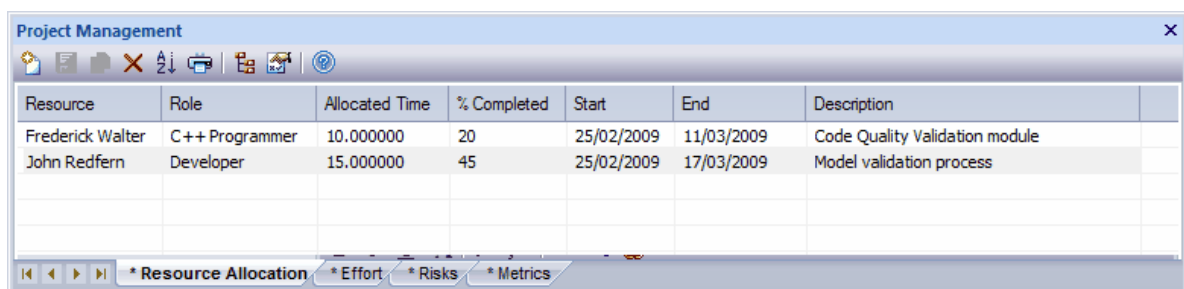
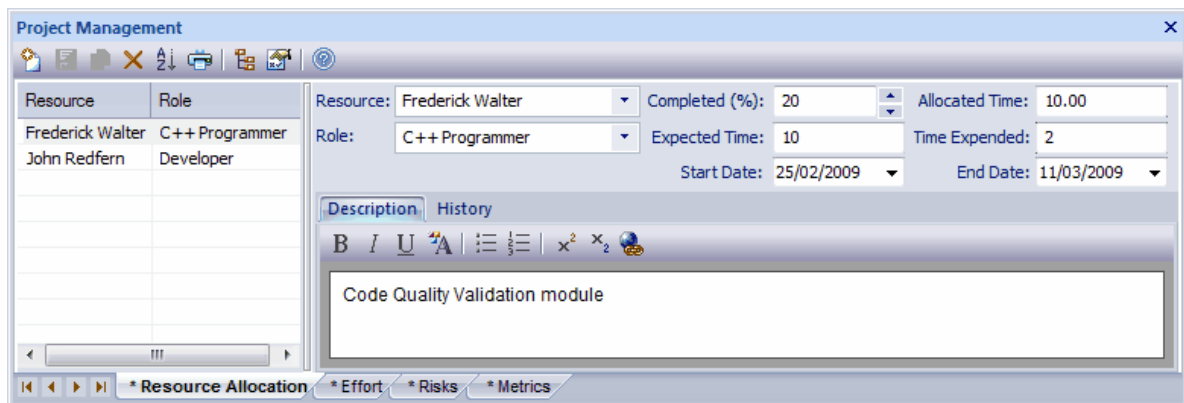

Toggle between these modes using the **Show/Hide Properties** button in the window toolbar. The tabs toggle between Item mode and List mode independently.

The asterisk on a tab indicates that the tab contains saved information. If there is no information for a category of item, or the information has not yet been saved, its tab has no asterisk.

## What to Do?

To find out more information about Project Resource Management tasks, use the following guide:

- To allocate a resource to an element, see the [Resource Allocation](#) <sup>[314]</sup> topic
- To record additional project management information for an element, see:
  - the [Effort Management](#) <sup>[315]</sup> topic (record effort expended on the element)
  - the [Risk Management](#) <sup>[316]</sup> topic (record risk associated with the element)
  - the [Metrics](#) <sup>[317]</sup> topic (record metrics measured for an element)
- To obtain a report of resource allocation details, see the [Resource Report](#) <sup>[318]</sup> topic
- To configure Project Management data and populate the drop-down lists used on the **Project Management** dialog tabs, see the following topics:
  - [Roles](#) <sup>[648]</sup>
  - [Clients](#) <sup>[651]</sup>
  - [Effort Types](#) <sup>[319]</sup>
  - [Metric Types](#) <sup>[320]</sup>
  - [Risk Types](#) <sup>[322]</sup>
- To find out about the functions of the **Project Management** toolbar, see the [Project Management Window](#) <sup>[312]</sup> topic.

### 3.6.2.1 Resource Allocation

Enterprise Architect enables you to connect a named resource in a named role to a given model element. This enables the Project Manager to track how far development of required components and Classes has progressed (provided the team members keep their figures up to date).

To enter *resource allocation* details for an element, follow the steps below:

1. Select the element in the **Project Browser**.

2. Select the **View | Other Element Tools | Project Management** menu option. The **Project Management** window displays, showing the **Resource Allocation** tab.
3. Click on the **New** icon on the **Project Management** window toolbar.

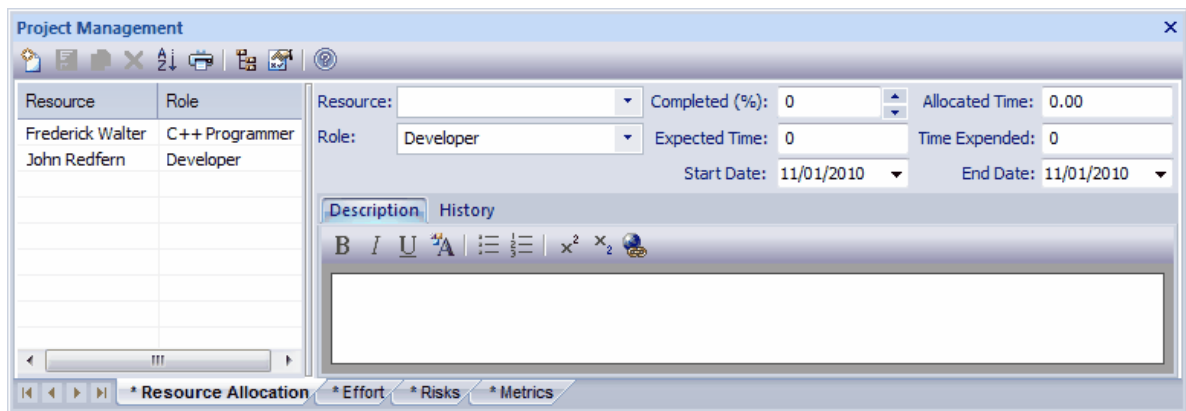

The **Resource Allocation** tab enables you to enter the following data:

- The name of the resource (click on the drop-down arrow and select, or type the name in)
- The role of the resource (click on the drop-down arrow and select, or type the name in)
- The start and end date for the availability of the resource
- The time allocated to the resource
- The percentage of the task the resource has completed
- The expected time allocated to the resource
- The actual time expended by the resource
- A description of the work being done by the resource (this text is also displayed in the [Notes window](#); it cannot be edited in that window)
- Notes on the activity history of the resource (this text is also displayed in the [Notes window](#); it cannot be edited in that window).

To edit existing Resource Allocation items for this element, click on the required item in the:

- list panel to the left of the window, in Item mode
- list, in List mode, or
- **Project Management** folder in the [Element Browser](#) window; if this window is not displayed, click on the  icon in the **Project Management** window toolbar. Resource Allocation item icons have an **R** in the bottom right corner.

To change the element to which to allocate resources, select the required element in the **Project Browser**.

### 3.6.2.2 Effort Management

To enter *effort* details for an element, follow the steps below:

1. Select the element in the **Project Browser**.
2. Select the **View | Other Element Tools | Project Management** menu option. The **Project Management** window displays, showing the **Resource Allocation** tab.
3. Click on the **Effort** tab.
4. Click on the **New** icon on the **Project Management** window toolbar.

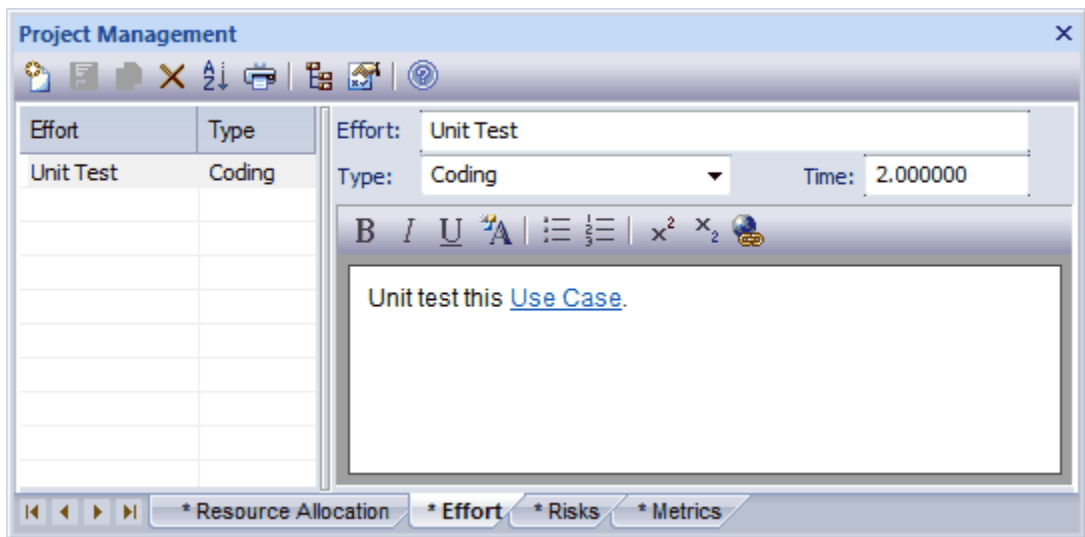

The **Effort** tab enables you to enter the following data:

- A name for the effort (short description)
- The type of effort (click on the drop-down arrow and select, or type the name in; typed names are not added to the [global effort type](#) <sup>[319]</sup> list)
- The time the effort will expend
- Some notes on the effort (this text is also displayed in the [Notes](#) <sup>[64†]</sup> [window](#) <sup>[64†]</sup>; it cannot be edited in that window).

To edit existing Effort items for this element, click on the required item in the:

- list panel to the left of the window, in Item mode
- list, in List mode, or
- *Project Management* folder in the [Element Browser](#) <sup>[510]</sup> window; if this window is not displayed, click on the  icon in the **Project Management** window toolbar. Effort item icons have an **E** in the bottom right corner.

To change the element to which to assign effort, select the required element in the **Project Browser**.

#### Notes:

- The drop-down arrow on the **Type** field displays a list of effort types as defined on the **Effort** tab of the **Metric and Estimation Types** dialog. If required, you can type in alternative effort types, but these are not added to the drop-down list of defined types.
- Although Enterprise Architect does not currently provide detailed reports on effort within a model, you can use the [Automation Interface](#) <sup>[1666]</sup> or similar tools to create your own custom reports based on effort information you enter.

### 3.6.2.3 Risk Management

To enter *risk* details for an element, follow the steps below:

1. Select the element in the **Project Browser**.
2. Select the **View | Other Element Tools | Project Management** menu option. The **Project Management** window displays, showing the **Resource Allocation** tab.
3. Click on the **Risks** tab.
4. Click on the **New** icon on the **Project Management** window toolbar.



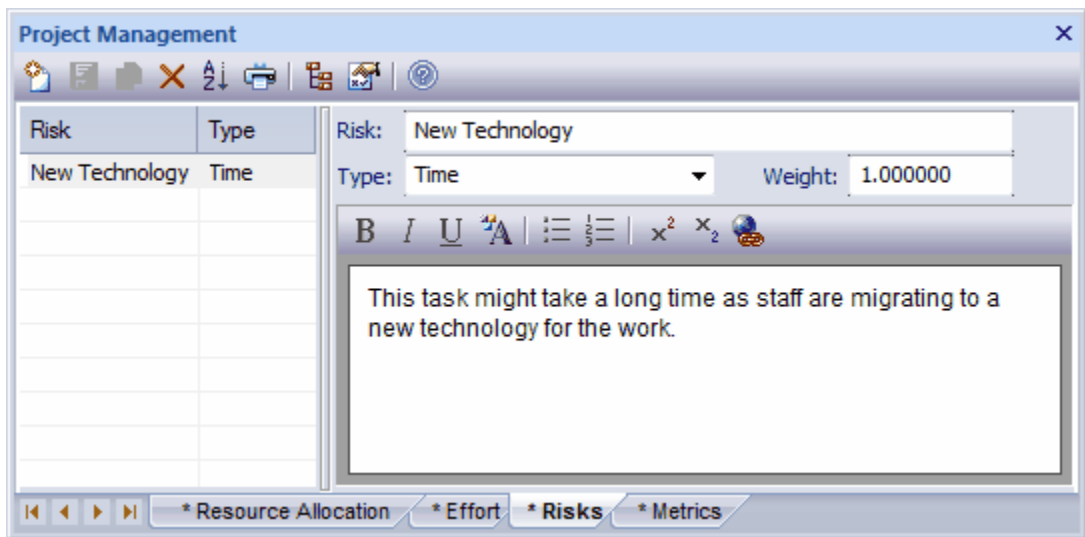

The **Risks** tab enables you to enter the following data:

- A name for the risk (short description)
- The type of risk (click on the drop-down arrow and select, or type the name in; typed names are not added to the [global risk type](#) <sup>[322]</sup> list)
- A weighting for the risk
- Some notes on the risk (this text is also displayed in the [Notes](#) <sup>[64†]</sup> [window](#) <sup>[64†]</sup>; it cannot be edited in that window).

To edit existing risk items for this element, click on the required item in the:

- list panel to the left of the window, in Item mode
- list, in List mode, or
- *Project Management* folder in the [Element Browser](#) <sup>[510]</sup> window; if this window is not displayed, click on the  icon in the **Project Management** window toolbar. Risk item icons have an **Ri** in the bottom right corner.

To change the element to which to allocate resources, select the required element in the **Project Browser**.

#### Note:

Although Enterprise Architect does not currently provide detailed reports on risks within a model, you can use the [Automation Interface](#) <sup>[1665]</sup> or similar tools to create your own custom reports based on risk information you enter.

### 3.6.2.4 Metrics

To enter *metrics* for an element, follow the steps below:

1. Select the element from the **Project Browser**.
2. Select the **View | Other Element Tools | Project Management** menu option. The **Project Management** window displays, showing the **Resource Allocation** tab.
3. Click on the **Metrics** tab.
4. Click on the **New** icon on the **Project Management** window toolbar.

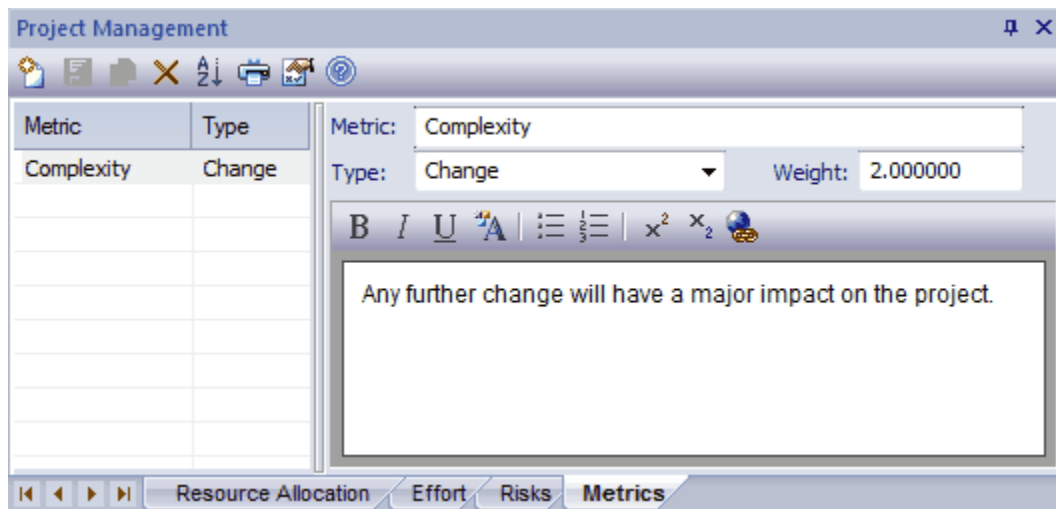

The **Metrics** tab enables you to enter the following data:

- A name for the metric (short description)
- The type of metric (click on the drop-down arrow and select, or type the name in; type names are not added to the [global metric type](#) <sup>[320]</sup> list)
- A weighting for the metric
- Some notes on the metric (this text is also displayed in the [Notes](#) <sup>[64]</sup> [window](#) <sup>[64]</sup>; it cannot be edited in that window).

To edit existing Metrics items for this element, click on the required item in the:

- list panel to the left of the window, in Item mode
- list, in List mode, or
- **Project Management** folder in the [Element Browser](#) <sup>[510]</sup> window; if this window is not displayed, click on the  icon in the **Project Management** window toolbar. Metric item icons have an **M** in the bottom right corner.

To change the element to which to allocate resources, select the required element in the **Project Browser**.

To edit existing metric items for this element, click on the required item in the:

- list panel to the left of the window, in Item mode
- list, in List mode, or
- **Project Management** folder in the [Element Browser](#) <sup>[510]</sup> window (Metric item icons have an **M** in the bottom right corner). If this window is not displayed, click on the  icon in the **Project Management** window toolbar.

To change the element to which to assign metrics, select the required element in the **Project Browser**.

#### Note:

Although Enterprise Architect does not currently provide detailed reports on metrics within a model, you can use the [Automation Interface](#) <sup>[1665]</sup> or similar tools to create your own custom reports based on metric information you enter.

### 3.6.2.5 Resource Report

To generate a resource report on a package, either:

- In the **Project Browser**, right-click on the package to create a report for and, from the context menu, select the **Documentation | Resource Allocation** option, or
- If the diagram currently active belongs to the package to create a report for, select the **Project | Documentation | Resource and Tasking Details** menu option.

The **Resource and Tasking Details** dialog displays a list of all elements that have resources allocated to them. The result list includes the resource allocated, the start and end dates, the percentage complete and other

relevant information. You can print out the results if required.

Resource	Role	Object	Type	Time	%Done	Start Date	End Date
Benjamin Hutton	Business An...	Create Account	UseCase	10.0	20	5/06/2009	19/06/2009

Option	Use to
<b>Root Package</b>	Confirm the name of the root package for which resourcing is being determined.
<b>Resource</b>	Change the (optional) name of a specific resource assigned to the project.
<b>As At Date</b>	Select the date to run the resource report for.
<b>Cut Off</b>	Set the percentage complete limit to include or exclude resource details; see <b>Show Where</b> .
<b>Show Where</b>	Show resourcing where percentage complete is <b>Complete</b> , <b>Above the cut-off</b> , <b>Below the cut-off</b> , or any of these three.
<b>Refresh</b>	Refresh the form.
<b>Locate Object</b>	(Click on an entry in the report.) Find the selected element from the results list in the <b>Project Browser</b> .
<b>Print</b>	Print the report.
<b>Resourcing Details</b>	Review the list of resources that meet the search criteria.

### 3.6.2.6 Effort Types

To specify the *effort types* used when assigning effort to an element, use the **Effort** tab of the **Project Indicators** dialog.

Creating an effort type using this dialog adds to a global list of effort types that can be added to any element in the model. This list of types displays in the **Type** field drop-down list on the **Effort** tab of the **Project Management** window.

To open the **Project Indicators** dialog, select the **Settings | Project Indicators** menu option. Click on the **Effort** tab.

Risk Metric **Effort**

Effort: Construction Description: Design and build system components Weight: 1

The construction phase is concerned with designing and building the components necessary to implement the system as specified.

New Save Delete

Defined Effort Types

Name	Description	Weight
Analysis	Analyzing System	1.0
Coding	Developing code	1.0
Construction	Design and build system components	1.0
Design	Designing specifications	1.0
Elaboration	Refine specification. Set up project	1.0
Transition	Implementation, acceptance testing	1.0

Close Help

To create a new effort type, click on the **New** button, or to edit an existing effort type, click on the effort type name in the **Defined Effort Types** list. Complete the fields as follows:

- In the **Effort** field type the name of the effort type
- In the **Description** field type a short description of the effort type
- In the **Weight** field type the weighting to apply to the effort type
- In the Note field, type any additional information on the effort type
- Click on the **Save** button.

#### Notes:

- Although Enterprise Architect does not currently provide detailed reports on effort within a model, you can use the [Automation Interface](#)<sup>[1666]</sup> or similar tools to create your own custom reports based on effort information you enter.
- You can transport effort types between models, using the [Export Reference Data](#)<sup>[223]</sup> and [Import Reference Data](#)<sup>[225]</sup> options on the **Tools** menu.

### 3.6.2.7 Metric Types

To specify the *metric types* used when assigning metrics to an element, use the **Metric** tab of the **Project Indicators** dialog.

Creating a metric using this dialog creates a global list of metrics that can be added to any element in the model. You can define a metric on other screens, such as the [Metrics](#)<sup>[317]</sup> tab of the **Project Management** window, but such metrics are not added to the global list.

Select the **Settings | Project Indicators** menu option. On the **Project Indicators** dialog, click on the **Metric** tab.

The screenshot shows the 'Metric' tab of the 'Project Indicators' dialog. It features three tabs: 'Risk', 'Metric' (selected), and 'Effort'. The main area contains a form with three input fields: 'Metric Type' (containing 'Change'), 'Description' (containing 'Change control, stability'), and 'Weight' (containing '1'). Below these fields is a text area for notes containing 'Change requests,'. To the right of the text area is a vertical scrollbar. Below the form are three buttons: 'New', 'Save', and 'Delete'. Below the buttons is a table titled 'Defined Metrics' with the following data:

Name	Description	Weight
Breakage	Convergence, rework, software scrap	1.0
Change	Change control, stability	1.0
Cost	Budget, cost, expenditure	1.0
Progress	Iteration, planning, actuals	1.0
Team	Staffing, team dynamics	1.0

At the bottom of the dialog are two buttons: 'Close' and 'Help'.

To create a new metric type, click on the **New** button, or to edit an existing metric type, click on the metric type name in the **Defined Metrics** list. Complete the fields as follows:

- In the **Metric Type** field type the name of the metric type
- In the **Description** field type a short description of the metric type
- In the **Weight** field type the weighting to apply to the metric type
- In the Note field, type any additional information on the metric type
- Click on the **Save** button.

#### Notes:

- Although Enterprise Architect does not currently provide detailed reports on metrics within a model, you can use the [Automation Interface](#)<sup>[1666]</sup> or similar tools to create your own custom reports based on metrics information you enter.
- You can transport metric types between models, using the [Export Reference Data](#)<sup>[223]</sup> and [Import Reference Data](#)<sup>[225]</sup> options on the **Tools** menu.

### 3.6.2.8 Risk Types

To specify the *risk types* used when assigning risk to an element, use the **Risk** tab of the **Project Indicators** dialog.

Creating a risk type using this dialog creates a global list of risk types that can be added to any element in the model. You can define a risk type on other screens, such as the **Risks** <sup>[316]</sup> tab of the **Project Management** window, but such risks are not added to the global list.

Select the **Settings | Project Indicators** menu option. On the **Project Indicators** dialog, click on the **Risk** tab.

The screenshot shows the 'Risk' tab of the 'Project Indicators' dialog. At the top, there are three tabs: 'Risk', 'Metric', and 'Effort'. Below the tabs, there are three input fields: 'Risk Type' (containing 'Delivery Fle'), 'Description' (containing 'Maintenance schedules'), and 'Weight' (containing '1'). Below these fields is a text area containing the text: 'Maintenance schedules for delivery vehicles have sometimes overlapped, restricting capacity for moving product on from the warehouse.' Below the text area are three buttons: 'New', 'Save', and 'Delete'. Below these buttons is a table titled 'Defined Risks' with the following data:

Name	Description	Weight
Delivery Fle	Maintenance schedules	1.0
Suppliers	Provision of raw materials	4.0

At the bottom of the dialog are two buttons: 'Close' and 'Help'.

To create a new risk type, click on the **New** button, or to edit an existing risk type, click on the risk type name in the **Defined Risks** list. Complete the fields as follows:

- In the **Risk Type** field type the name of the risk type
- In the **Description** field type a short description of the risk type
- In the **Weight** field type the weighting to apply to the risk type
- In the Note field, type any additional information on the risk type
- Click on the **Save** button.

**Notes:**

- Although Enterprise Architect does not currently provide detailed reports on risks within a model, you can use the [Automation Interface](#) [1666] or similar tools to create your own custom reports based on risk information you enter.
- You can transport risk types between models, using the [Export Reference Data](#) [223] and [Import Reference Data](#) [225] options on the **Tools** menu.

### 3.6.3 The System Window

Access: **View | Other Project Tools | System.**

The **System** window documents tasks and issues that relate directly to the current project. It has three tabs:

- [Project Tasks](#) [329] - a list of major project tasks that require attention; you can filter tasks based on their current status - right-click for a popup menu, or double-click on a line item to modify details
- [Project Issues](#) [332] - a list of events, occurrences and situations that impact on project development and delivery; you can review Issues using the right-click context menu or by double-clicking on selected issues
- [Project Glossary](#) [325] - a list of all the technical and business terms already defined for a model; you can add to the list, delete or change items and filter the list to exclude by type.

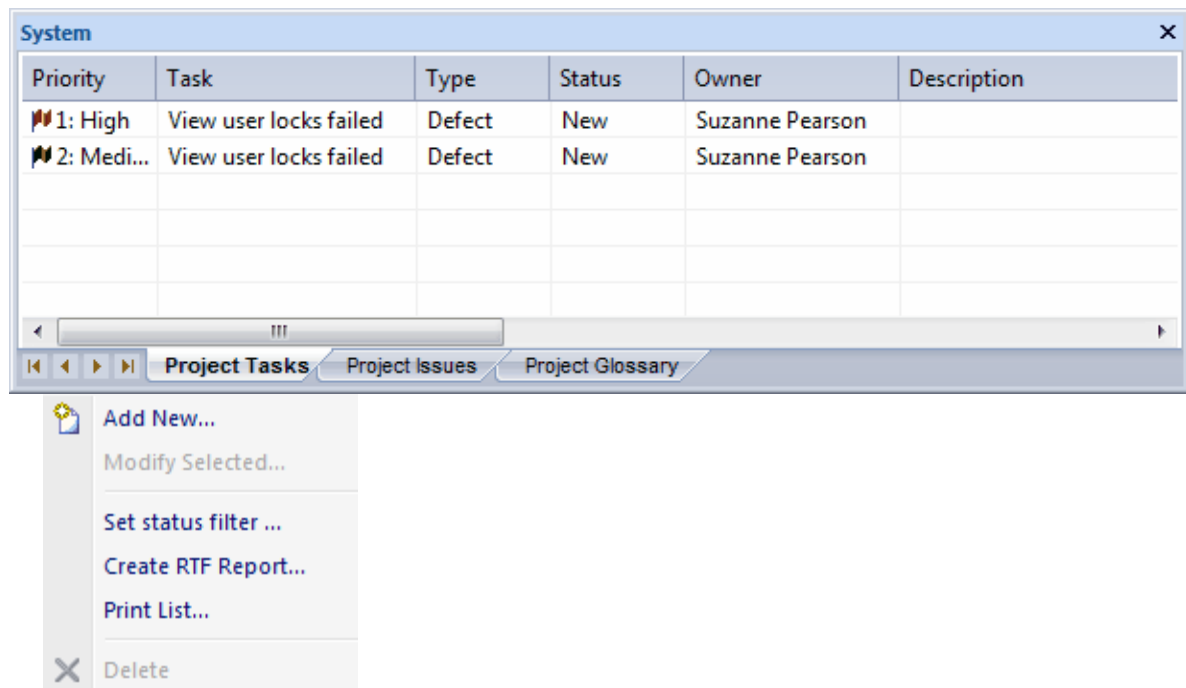
**Note:**

Right-clicking in the **System** window displays a context menu that has options for filtering tasks/issues by status, and glossary by term. You can also rearrange the sort-order by clicking in the title bar of the column that the items are to be indexed on.

### 3.6.4 Project Glossary

The glossary enables you to set up a list of defined terms for your project.

You can divide the glossary items by category; for example, Business terms and Technical terms. The glossary can be saved in Rich Text format for inclusion as part of a larger project document.

You can add, delete and modify the project glossary entries through the [Glossary](#) [324] dialog or through the [Project Glossary](#) [325] tab on the **System** window. You can also create glossary terms and definitions from text in the [Notes](#) [641] window or from any **Notes** or **Description** fields that have the **Notes** toolbar. Once these terms exist, you can insert them into any of those same fields by pressing **[Ctrl]+[Space]** and selecting them

from an [autocomplete](#) box.

**Tip:**

Include a [Glossary Report](#) in your project requirements or functional specifications documents.

**Note:**

You can transport these glossary definitions between models, using the [Export Reference Data](#) and [Import Reference Data](#) options on the **Tools** menu.

### 3.6.4.1 The Glossary Dialog

To open the **Glossary** dialog, select the **Project | Documentation | Glossary** menu option. Use this dialog to [add](#), [modify](#) and [delete](#) glossary entries.

You can also [limit the display](#) to list entries of a specific type for editing or deletion.

Option	Use to
<b>Glossary Term</b>	Type the term to include in the glossary.
<b>Glossary Type</b>	<p>Select either <b>Technical</b> or <b>Business</b>.</p> <p>If you require a different glossary type, click on the [ ... ] (browse) button and specify the name of the new type.</p> <p>This field applies the type only to the selected term. You can rename a type for <a href="#">all terms of that type</a>, using the <b>Project Glossary</b> tab of the <b>System</b> window.</p>



Option	Use to
Description	Type the definition or description of the term. You can format the text of this description using the <a href="#">Notes</a> <sup>[642]</sup> toolbar at the top of the field.
Limit Display To	Select the appropriate type to filter the <b>Type   Term</b> list to show entries of a specific type for editing or deletion.
Type   Term	Review the list of defined glossary terms.
Report	<a href="#">Print a glossary report</a> <sup>[328]</sup> .

### Add a Glossary Entry

To add an entry to the glossary, follow the steps below:

1. Enter the details for the glossary item: the **Glossary Term**, the **Glossary Type** and the **Description**.

#### Note:

A glossary term must have a defined type and description. You cannot save a new term without both of these values.

2. Click on the **Save** button.
3. To enter another item, click on the **New** button.

### Modify a Glossary Entry

To modify a glossary entry, follow the steps below:

1. Select the entry to modify from the bottom panel of the dialog. The details of the entry display in the fields in the top half of the window.

#### Note:

A glossary term must have a defined type and description. You cannot save an edited term without both of these values.

2. Change the details as required.
3. Click on the **Save** button.

### Delete a Glossary Entry

To delete a glossary entry, follow the steps below:

1. Select the entry to delete from the bottom panel of the dialog. The details of the entry display in the fields in the top half of the window.
2. Click on the **Delete** button.

### Limit the Display

You can select which entry categories are displayed in the list. To:

- View all glossary entries, select the **All** value in the **Limit Display To** field.
- View entries of a specific type only, select the appropriate value in the **Limit Display To** field.

#### 3.6.4.2 Project Glossary Tab

The **Project Glossary** tab in the **System** window shows all of the glossary terms already defined for your model. You can add to the list, delete or change items, change a definition type for all terms of that type, and filter the list to exclude by type.

Access this tab by opening the **System** window; select the **View | Other Project Tools | System** menu option or press **[Alt]+[2]**. Select the **Project Glossary** tab.

**Tip:**

To print out all of the currently listed items, right-click on the list and select the **Print List** context menu option.

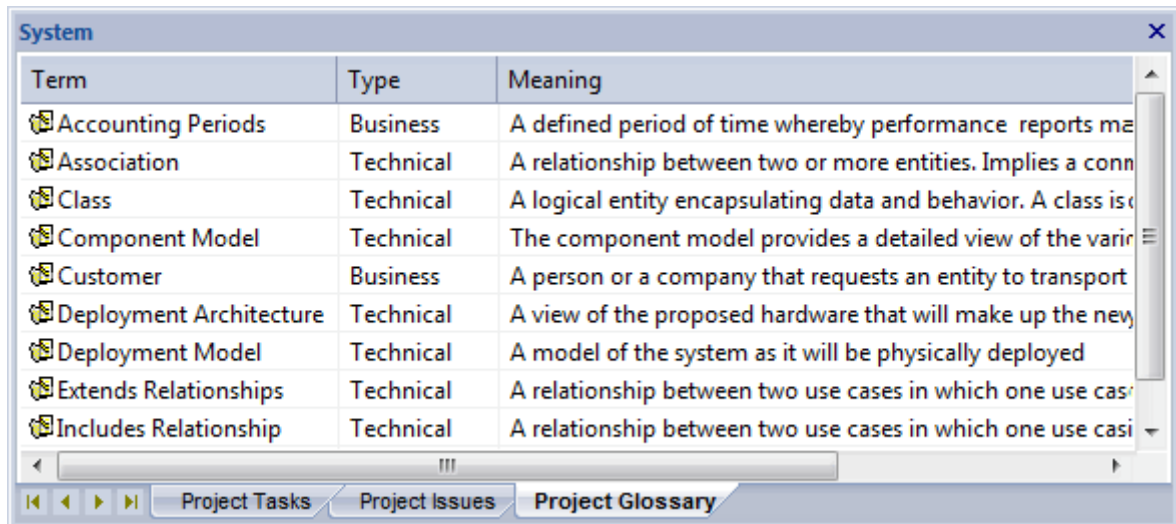

Term	Type	Meaning
Accounting Periods	Business	A defined period of time whereby performance reports ma
Association	Technical	A relationship between two or more entities. Implies a conn
Class	Technical	A logical entity encapsulating data and behavior. A class is c
Component Model	Technical	The component model provides a detailed view of the vari
Customer	Business	A person or a company that requests an entity to transport
Deployment Architecture	Technical	A view of the proposed hardware that will make up the new
Deployment Model	Technical	A model of the system as it will be physically deployed
Extends Relationships	Technical	A relationship between two use cases in which one use cas
Includes Relationship	Technical	A relationship between two use cases in which one use cas

Right-click on an entry and use the context menu to [add](#)<sup>[326]</sup>, [modify](#)<sup>[327]</sup>, [reclassify](#)<sup>[327]</sup>, [filter](#)<sup>[327]</sup> and [delete](#)<sup>[327]</sup> glossary entries (as below). Alternatively, select the **Project | Documentation | Glossary** menu option and use the [Glossary](#)<sup>[324]</sup> dialog.

**Tip:**

Include a [Glossary Report](#)<sup>[328]</sup> in your project requirements or functional specifications documents.

## Add a Glossary Entry

To add an entry to the glossary, follow the steps below:

1. Double-click on the **Project Glossary** tab, or right-click on the tab and select the **Add New** context menu option. The **Glossary Detail** dialog displays.

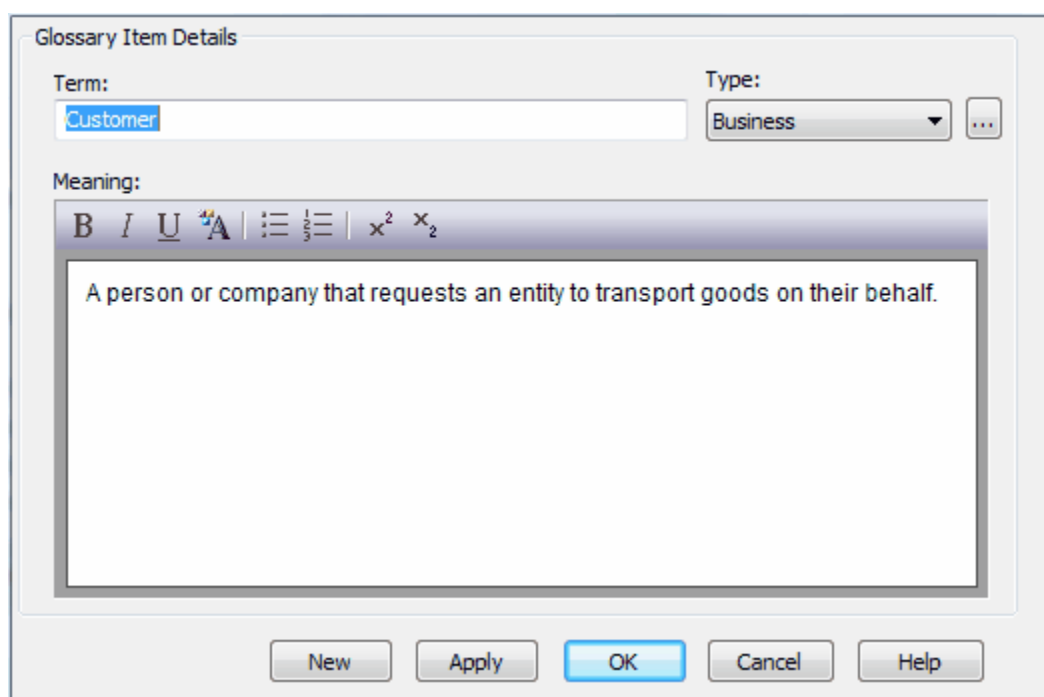

**Glossary Item Details**

Term:  Type:

Meaning:

**B I U A** |  $x^2$   $x_2$

A person or company that requests an entity to transport goods on their behalf.

2. Enter the details for the glossary item: the **Term**, **Type** and **Meaning**. You can, if necessary, format the **Meaning** text using the [Notes](#)<sup>[642]</sup> toolbar at the top of the field.

If the **Type** values are not appropriate for the term, click on the [ ... ] button and enter another type name.

**Note:**

A glossary term must have a defined type and description. You cannot apply a new term without both of these values.

3. Click on the **Apply** button.
4. To create another entry, click on the **New** button.
5. To close, click on the **OK** button.

### Modify a Glossary Entry

To modify a glossary entry, either:

1. Double-click on the entry to modify in the list on the **Project Glossary** tab, or
2. Right-click on the entry to modify in the list on the **Project Glossary** tab and select the **Modify Selected** context menu option.

The **Glossary Detail** dialog displays; edit the fields as required.

### Delete a Glossary Entry

To delete a glossary entry, follow the steps below:

1. Right-click on the entry to modify in the list on the **Project Glossary** tab. The context menu displays.
2. Select the **Delete** menu option.

### Redefine Type

If a glossary term type is no longer appropriate for all terms of that type, you can redefine the type for all terms at once. To do this, follow the steps below:

1. On the **Project Glossary** tab, right-click on a term of the type to be changed and select the **Rename Type** context menu option. The **Rename Glossary Type** dialog displays.
2. In the **New Type Name** field type a different type name, either an existing type or a new type.
3. Click on the **OK** button. On the **Project Glossary** tab, all entries of the original type are now redefined as being of the new type.

**Note:**

To reclassify [a single term](#)<sup>[324]</sup>, use the **Glossary Type** field on the **Glossary** dialog.

### Filter List

To filter the **Project Glossary** tab display so that only terms of a specific type are listed, follow the steps below:

1. Right-click on the list and select the **Set term filter** context menu option. The **Term Type Filter** dialog displays.
2. In the **Term** field, click on the drop-down arrow and select the term type for which to list Glossary terms.
3. Click on the **OK** button. The list of Glossary terms is filtered to the selected type.

To remove the filter, either:

- Follow the steps above and select the value **<All>** in the **Term** field, or
- Right-click on the list and select the **Remove term filter** context menu option.

### 3.6.4.3 Generate a Report

To generate a report of your model's glossary, follow the steps below:

1. Select the **Project | Documentation | Glossary** menu option. The **Glossary** dialog displays.
2. Click on the **Report** button. The **Glossary Report** dialog displays.

The screenshot shows the 'Glossary Report' dialog box. It has a 'Filename' field with a browse button (three dots) to its right. Below it is a 'Heading' field containing the text 'Glossary'. The main area is divided into two panels. The left panel, titled 'Include Glossary Items', contains a sub-panel 'Glossary Types' with two checkboxes: 'Technical' and 'Business'. Below this panel are 'Select All' and 'Deselect All' buttons. The right panel, titled 'Document options', contains three buttons: 'Page Setup', 'Language', and 'Page break between sections'. At the bottom of the dialog are three buttons: 'Generate' (highlighted in blue), 'View', and 'Close'.

3. In the **Filename** field, type or select a filename for the glossary.
4. In the **Heading** field, type a suitable heading for the glossary.
5. In the **Include Glossary Items** panel, select the checkbox for each type of glossary entry to include. Click on the **Select All** button to select all types of entry.
6. If necessary, click on the **Page Setup** and/or **Language** buttons to define the page setup and language for the report.
7. To include page breaks, select the **Page break between sections** checkbox.
8. Click on the **Generate** button to generate the report.
9. Click on the **View** button to open the report.

**Note:**

You can view sample report output in the [Glossary Report Output Sample](#) <sup>328</sup> topic.

### 3.6.4.4 Glossary Report Output Sample

An example of the output from a Glossary report is shown below:

## Glossary

### ***Business Terms***

#### ***Accounting Periods***

A defined period of time whereby performance reports can be extracted. (normally 4 week periods).

#### ***Customer***

A person or a company that requests An entity to transport goods on their behalf.

## Technical Terms

### Association

A relationship between two or more entities. Implies a connection of some type - for example one entity uses the services of another, or one entity is connected to another over a network link.

### Component Model

The component model provides a detailed view of the various hardware and software components that make up the proposed system. It shows both where these components reside and how they inter-relate with other components. Component requirements detail what responsibilities a component has to supply functionality or behavior within the system.

### Deployment Model

A model of the system as it is physically deployed.

### Extends Relationship

A relationship between two Use Cases in which one Use Case 'extends' the behavior of another. Typically this represents optional behavior in a Use Case scenario - for example a user might optionally request a list or report at some point in a performing a business Use Case.

## 3.6.5 Project Tasks

The *Project Tasks List* is a convenient 'To Do' list of major project work items that are not recorded elsewhere. It can also be used to track things like requests or meetings.

The Project Tasks List is available as a tab on the **System** window. To open the **System** window, select the **View | Other Project Tools | System** menu option, or press **[Alt]+[2]**. Select the **Project Tasks** tab.

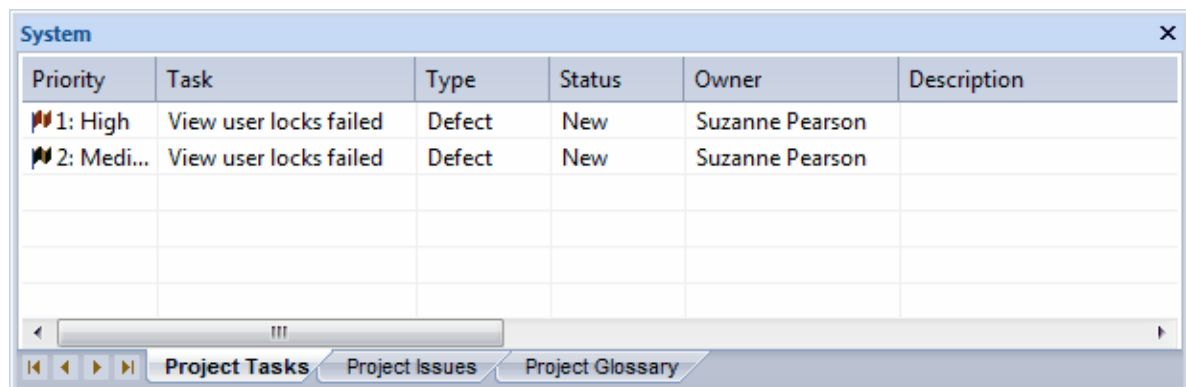

Priority	Task	Type	Status	Owner	Description
1: High	View user locks failed	Defect	New	Suzanne Pearson	
2: Medi...	View user locks failed	Defect	New	Suzanne Pearson	

Right-click on the list to view the context menu, and select to add, modify or delete list items, or to set a status filter. To set the sort order, click the title-bar of the column on which to index the tasks.

For more information see the [Add, Modify and Delete Tasks](#)<sup>[330]</sup> topic.

### Tip:

Select the **Print List** menu option to print out the currently displayed items.

### Note:

You can transport these task definitions between models, using the [Export Reference Data](#)<sup>[223]</sup> and [Import Reference Data](#)<sup>[225]</sup> options on the **Tools** menu.

### 3.6.5.1 Add, Modify and Delete Tasks

From the **Project Tasks** tab on the **System** window, display the **Task Detail** dialog to [Add](#)<sup>[330]</sup>, [Modify](#)<sup>[331]</sup> and [Delete](#)<sup>[331]</sup> tasks.

#### Add a Task

To add a task, follow the steps below:

1. Double-click in a blank area of the **Project Tasks** tab, or right-click and select the **Add New** context menu option. The **Task Detail** dialog displays.

The screenshot shows the 'Task Detail' dialog box with the following fields and values:

- Task:** 'View user locks' failed (with an 'Auto' button)
- Type:** Defect
- Owner:** Suzanne Pearson
- Start:** 25/02/2009
- Status:** New
- Assigned:** John Redfern
- End:** 25/02/2009
- Priority:** High
- Total Time:** (empty)
- Actual Time:** (empty)
- Percent:** 0

Below the details section are two rich text editors for 'Description' and 'History', both currently empty. At the bottom are buttons for 'New', 'Apply', 'OK', 'Cancel', and 'Help'.

2. Enter the details for the task. You can define the following:
  - The task name
  - [Auto counters](#)<sup>[525]</sup> - if you have configured these, click on the **Auto** button
  - The task type
  - The task owner
  - The expected start and end date for the task
  - The current status of the task
  - The person this task has been assigned to

- The task priority: high, medium or low
  - The expected total time for the task and the actual time expended
  - The percent complete
  - The phase associated with this task.
3. Click on the **Apply** button.
  4. To create another entry, click on the **New** button, or to close, click on the **OK** button.

### Modify a Task

To modify a task, on the **Project Tasks** tab, either:

- Double-click on the task to modify, or
- Right-click on the task to modify and, from the context menu, select the **Modify Selected** menu option.

The **Task Detail** dialog displays, and you can edit the task data.

### Delete a Task

To delete a task, follow the steps below:

1. On the **Project Tasks** tab, right-click on the task to delete. The context menu displays.
2. Select the **Delete** menu option.

## 3.6.6 Project Issues

Any identified issues can be recorded against the current project. Issues are raised with a description, date, owner and status.

#### Notes:

- You can transport these issue definitions between models, using the **Export Reference Data** <sup>[223]</sup> and **Import Reference Data** <sup>[225]</sup> options on the **Tools** menu.
- In the Corporate, Business and Software Engineering, System Engineering and Ultimate editions of Enterprise Architect, if security is enabled you must have **Manage Issues** <sup>[198]</sup> permission to update and delete Issues records.

You can **add, delete and modify** <sup>[334]</sup> Issues using either the **Project Issues** <sup>[331]</sup> dialog, or the **Issue Detail** <sup>[333]</sup> dialog from the **Project Issues** tab of the **System** window. You can also generate and view an RTF report of your issue list, using either the **Project Issues** <sup>[334]</sup> dialog or the **Project Issues** <sup>[334]</sup> tab.

#### Tip:

You can view sample report output in the **Report Output Sample** <sup>[335]</sup> topic.

### 3.6.6.1 Project Issues Dialog

The **Project Issues** dialog is accessed from the **Project | Documentation | Issues** menu option. This dialog enables you to record a description, date, owner and status of any identified issues against the current project.

You can **add, modify and delete issues** <sup>[334]</sup>, and **generate a report** <sup>[334]</sup> of your project issues in Rich Text Format.

#### Note:

In the Corporate, Business and Software Engineering, System Engineering and Ultimate editions of Enterprise Architect, if security is enabled you must have **Manage Issues** <sup>[198]</sup> permission to update and delete Issues records.

**Details**

Issue:  Auto

Priority: Low Date: 19/11/2009

Status: Open Owner:

Desc:

**Resolution**

Resolver:  Date: 19/11/2009 Close Issue

Comments:

New Save Delete

**Project Issues & Discussion**

Issue	Date	Owner	Status
Public Holidays	24/06/2009	Shirley Anne	Under Review
Missing training material	24/06/2009	John Redfem	Open
Pre-production Environment Model...	24/06/2009	Frederick Walter	Open
The test servers will be delayed	24/06/2009	Suzanne Pearson	Under Review

Show Closed Issues

View RTF Report Close Help

### 3.6.6.2 Project Issues Tab

The **Project Issues** tab in the **System** window enables any identified issues to be recorded against the current project. Issues are raised with a description, date, owner and status.

#### Note:

In the Corporate, Business and Software Engineering, System Engineering and Ultimate editions of Enterprise Architect, if security is enabled you must have **Manage Issues** <sup>(198)</sup> permission to update and delete Issues records.

To access this tab, select the **View | Other Project Tools | System** menu option or press **[Alt]+[2]** to display the **System** window, and click on the **Project Issues** tab.

#### Tip:

You can right-click on the list and select the **Print List** context menu option to print out the currently displayed items.



Priority	Issue	Date	Status	Owner	Description
1: High	Pre-production Envir...	24/06/2009	Open	Frederick Walter	
3: Low	Public Holidays	24/06/2009	Under Review	Shirley Anne	
3: Low	Missing training mat...	24/06/2009	Open	John Redfern	
3: Low	The test servers will b...	24/06/2009	Under Review	Suzanne Pears...	

To [add](#) a new issue, double-click on an empty row of the **Project Issues** tab. To [modify](#) an issue, double-click on the required item in the list. In each case, the **Issue Detail** dialog displays.

**Details**

Issue:  Auto

Priority: High Date: 24/06/2009

Status: Open Owner: Frederick Walte

Description:   
B I U A | ☰ 1/3 ☰ | x<sup>2</sup> x<sub>2</sub> 🌐  

Environment Model not signed off by DTG - FW ironing out final points.

---

**Resolution:**

Date: 19/11/2009 Resolved By:  Close Issue

Comments:   
B I U A | ☰ 1/3 ☰ | x<sup>2</sup> x<sub>2</sub> 🌐  

(Empty)

New Apply OK Cancel Help

You can also [delete](#) an issue and [generate a report](#) of your issues in Rich Text Format.

### 3.6.6.3 Add, Delete and Modify Issues

Issues can be added, deleted and modified using either the [Project Issues](#) <sup>[331]</sup> dialog, or the [Issue Detail](#) <sup>[333]</sup> dialog from the **Project Issues** tab of the **System** window.

To *add* an issue, click on the **New** button and complete the following fields:

Component	Description
<b>Issue</b>	The name of the issue.
<b>Auto</b>	Click on the <b>Auto</b> button if you have <a href="#">auto counters</a> <sup>[525]</sup> configured.
<b>Priority</b>	The priority of this issue: low, medium or high.
<b>Date</b>	The date the issue arose.
<b>Status</b>	The issue's current status.
<b>Owner</b>	The person owning the issue.
<b>Description</b>	Description of the issue.
<b>Resolution</b>	Notes on the resolution of the issue.
<b>Date</b>	The date the issue was resolved.
<b>Resolved By</b>	Person who resolved the issue.
<b>Comments</b>	Any comments regarding the resolution of the issue.
<b>Close Issue</b>	Click on this button to close the issue.
<b>Apply</b>	Save and apply the issue.

To *modify* an issue, double-click on it in the **Project Issues** tab or **Project Issues & Discussion** list, then edit the fields as indicated in the above table.

To *delete* an issue, click on it in the **Project Issues** tab or **Project Issues & Discussion** list, then:

- Click on the **Delete** button (**Project Issues** dialog) or
- Right-click on the issue and select the **Delete** option from the context menu.

### 3.6.6.4 Report From Project Issues Dialog

To generate an RTF document of your issue log using the **Project Issues** dialog, follow the steps below:

1. Select the **Project | Documentation | Issues** menu option. The **Project issues** dialog displays.
2. Click on the **Report** button. The **Save As** dialog displays.
3. Browse for the appropriate file location and, in the **File name** field, type the file name for the report.
4. Click on the **Save** button.
5. To view the report, click on the **View RTF** button.

#### Tip:

For information on viewing sample report output, see the [Report Output Sample](#) <sup>[335]</sup> topic.

### 3.6.6.5 Report From Project Issues Tab

To generate an RTF document of your issue log using the **Project Issues** tab of the **System** window, follow the steps below:

1. Select the **View | Other Project Tools | System** menu option, or press **[Alt]+[2]**. The **System** window displays.
2. Click on the **Project Issues** tab.

3. Right-click on a blank line of the **Project Issues** tab and select the **Create RTF Report** context menu option. The **Save As** dialog displays.
4. Enter the directory location and file name to save your report to and click on the **Save** button. Enterprise Architect generates the report. This should only take a few moments to complete.

**Tip:**

For information on viewing sample report output, see the [Report Output Sample](#)<sup>335</sup> topic.

### 3.6.6.6 Report Output Sample

An example of the output from an Issues report is shown below:

## List of Project Issues: 24-Jul-2007 9:47:00 AM

Issue	Date/Owner	Description	Resolution
Test servers will be delayed	24/07/2007 Eloise Norman	The test server builds have been delayed because the particular (unusual) memory requirements to match the customer's site are not available on shore. They are being sourced from Singapore but it will delay the builds and delivery of the machines.	Closed: 24/07/2007 Geoffrey Sparks The machines will be built and delivered using standard memory and the proprietary memory will be added later. All performance tests will be delayed until the memory is available.
Public Holidays	24/07/2007 Joanna Stoa	The schedule includes staff working on public holidays. A number of staff have indicated that contrary to what they stated earlier they are not available.	Open: 24/07/2007
Compiler Version disparity	24/07/2007 Eloise Norman	A number of the developers have downloaded different versions of a number of the compilers. This has lead to unpredictable builds impacting on testing.	Under Review: 24/07/2007

### 3.6.7 Use Case Estimation

#### Metrics and Estimation

Project estimation is the task of working out how much time and effort is required to build and deploy a solution.

The Use Case metrics facility in Enterprise Architect provides a starting point for estimating project effort. Using this facility you can get a rough measure of the complexity of a system and some indication of the effort required to implement the model. Like all estimation techniques, this one requires some experience with previous projects to 'calibrate' the process.

There is additional information available on Use Case metrics at [www.sparxsystems.com/UCMetrics.htm](http://www.sparxsystems.com/UCMetrics.htm).

#### Calibrating

The following values must be carefully calibrated in order to gain the best possible estimates:

- [Technical Complexity Factors](#)<sup>[336]</sup>, which are values that attempt to quantify the difficulty and complexity of the work in hand
- [Environment Complexity Factors](#)<sup>[337]</sup>, which are values that attempt to quantify non-technical complexities such as team experience and knowledge
- [Default Hour Rate](#)<sup>[340]</sup>, which sets the number of hours per Use Case point.

## Estimating

Once you have entered all the calibration values, you can estimate the project timescale through the [Use Case Metrics dialog](#)<sup>[338]</sup>.

### 3.6.7.1 Technical Complexity Factors

*Technical Complexity Factors* are used in the *Use Case Metrics* estimation technique. You can add or modify these factors using the [Estimation Factors](#) dialog.

To open this dialog, select the **Settings | Estimation Factors** menu option. Click on the [Technical Complexity Factors](#) tab.

Technical Complexity Factors | Environment Complexity Factors | Default Hour Rate

Factor Number: Description: Weight: Assigned Value:

TCF04	Complex internal processing	1.00	4.00
-------	-----------------------------	------	------

New Delete Save

Defined Technical Types

Type	Description	Weight	Value
TCF01	Distributed System	2.00	5.00
TCF02	Response or throughput performan...	1.00	4.00
TCF03	End user efficiency (online)	1.00	2.00
TCF04	Complex internal processing	1.00	4.00
TCF05	Code must be re-usable	1.00	2.00
TCF06	Easy to install	0.50	5.00
TCF07	Easy to use	0.50	3.00
TCF08	Portable	2.00	3.00
TCF09	Easy to change	1.00	3.00
TCF10	Concurrent	1.00	2.00

Unadjusted TCF: 47.00

Close Help

## Defined Technical Types

This editable list should contain all factors that could affect the technical complexity of the project environment.

These configured factors, whose summed **Ex Values** yield the **Unadjusted TCF** value, work together with the [Environment Complexity Factors](#)<sup>[337]</sup> to skew the overall complexity up or down, depending on the level of technical complexity and the corresponding level of environmental support.

**Note:**

You can transport the Technical Complexity Factors between models, using the [Export Reference Data](#) and [Import Reference Data](#) options on the **Tools** menu.

**Weight**

The TCF **Weight** indicates how much technical complexity you assign to a factor. For example, 'the system is to be developed in ADA' might warrant a higher weight than 'the system is to be a shell script'. A weight evaluates its respective factor, but is irrelevant to a project; the **Value** field assesses each factor's role within a project. The supplied factors and their associated weights are defined by the *Use Case Points Method*, although they can be adjusted to suit a project's specific requirements.

**Value**

For most purposes, the only table column requiring adjustment is **Value**, which indicates the degree of influence a particular factor has on the project. As a suggested gauge, a value of **0** indicates no influence, **3** indicates average influence and **5** indicates strong influence.

**3.6.7.2 Environment Complexity Factors**

*Environment Complexity Factors* are used in the *Use Case Metrics* estimation technique. You can add or modify these using the **Estimation Factors** dialog.

To open this dialog, select the **Settings | Estimation Factors** menu option. Click on the **Environment Complexity Factors** tab.

The dialog box has three tabs: 'Technical Complexity Factors', 'Environment Complexity Factors' (selected), and 'Default Hour Rate'. It features a table for 'Defined Environment Types' with the following data:

Type	Description	Weight	Value
ECF01	Familiar with Rational Unified Process	1.50	4.00
ECF02	Application experience	0.50	3.00
ECF03	Object-oriented experience	1.00	4.00
ECF04	Lead analyst capability	0.50	4.00
ECF05	Motivation	1.00	3.00
ECF06	Stable requirements	2.00	4.00
ECF07	Part-time workers	-1.00	0.00
ECF08	Difficult programming language	-1.00	3.00

At the bottom of the dialog, the 'Unadjusted ECF' is displayed as 21.50. Buttons for 'New', 'Delete', 'Save', 'Close', and 'Help' are located at the bottom of the window.

## Defined Environment Types

This editable list should contain all factors affecting the general design and development environment, including team experience and knowledge, team size, expertise and other non-functional environmental factors.

These configured factors, whose summed **Ex Values** yield the **Unadjusted ECF** value, work together with the [Technical Complexity Factors](#)<sup>[336]</sup> (TCFs) to skew the overall complexity up or down, depending on the level of technical complexity and the corresponding level of environmental support.

### Note:

You can transport the Environment Complexity Factors between models, using the [Export Reference Data](#)<sup>[223]</sup> and [Import Reference Data](#)<sup>[225]</sup> options on the **Tools** menu.

## Weight

A **Weight** evaluates its respective factor's complexity in comparison to other factors, but is irrelevant to a project; the **Value** field assesses each factor's role within a project. The supplied factors and their associated weights are defined by the *Use Case Points Method*, although they can be adjusted to suit a project's specific requirements.

## Value

For most purposes, the only table column requiring adjustment is **Value**, which indicates the degree of influence a particular factor has over the project. As a suggested gauge, a value of **0** indicates no influence, **3** indicates average influence and **5** indicates strong influence.

### 3.6.7.3 Estimating Project Size

Enterprise Architect uses a simple estimation technique based on the number of Use Cases to be built, the difficulty level of those Use Cases, some project environment factors and some build parameters.

### Note:

This technique is of value only once you have developed a couple of known projects to use as a baseline. Please **DO NOT** use the provided 'guesstimates' as a real world measure until you have some real world base lines to measure against.

Once the parameters are set up and the Use Cases defined, open the [Use Case Metrics](#) dialog by:

- Navigating to the package of interest and selecting the **Project | Use Case Metrics** menu option, or
- Right-clicking on the package of interest in the [Project Browser](#) and selecting the **Documentation | Package Metrics** context menu option.

**Use Cases**

Root Package:

Phase like:  Bookmarked:

Keyword like:  Use Cases:   Include Actors

Package	Name	Type	Complexity	Phase
III				

**Technical Complexity Factor**

Unadjusted TCF Value (UTV):

TCF Weight Factor (TWF):

TCF Constant (TC):

TCF = TC + (TWF x UTV):

**Environment Complexity Factor**

Unadjusted ECF Value (UEV):

ECF Weight Factor (EWF):

ECF Constant (EC):

ECF = EC + (EWF x UEV):

Unadjusted Use Case Points (UUCP) = Sum of Complexity  Ave Hours per Use Case

Easy: -2147483648 Med: -2147483648

**Total Estimate**

Use Case Points (UCP) = UUCP \* TCF \* ECF =  \*  \*  =  UCP

Estimated Work Effort (hours) =  \*  =  Hours

Estimated Cost = EWE \* Default hourly Rate =  \*  =  Cost

Option	Use to
<b>Root Package</b>	Confirm the root package in the hierarchy. All Use Cases under here could potentially be included in the report.
<b>Reload</b>	Re-run the search, usually after you change the filter criteria.
<b>Phase like</b>	Include Use Cases with a phase that matches the wildcard value in the field (use * to match any characters, for example 1.* for 1.1 and 1.2).
<b>Keyword like</b>	Include Use Cases with a keyword that matches the wildcard value in the field (use * to match any characters).
<b>Use Cases</b>	Check the total count of Use Cases in estimate.
<b>Technical Complexity Factor</b>	Review the parameters that describe the degree of technical complexity of the project. While the unadjusted TCF value comes from the <a href="#">Technical Complexity Factor</a> <sup>[336]</sup> tab of the <b>Metrics and Estimation Types</b> dialog, the other values compose the Use Case Points Method formula. Modify these fields with caution. The final project estimate is directly proportional to the TCF.
<b>Environment Complexity Factor</b>	Review the parameters that calculate the degree of environmental complexity of the project, from factors such as programmer motivation or experience. The listed parameters compose the formula calculating the ECF, defined by the Use Case Points Method; the only parameter affected by the project is the unadjusted ECF value, derived from the <a href="#">Environment Complexity Factors</a> <sup>[337]</sup> tab of the <b>Metrics and Estimation Types</b> dialog. The final project estimate is directly proportional to the ECF.
<b>Unadjusted Use Case Points (UUCP)</b>	Check the sum of the Use Case complexity numbers.
<b>Ave Hours per Use Case</b>	Check the average of the number of hours assigned to easy, medium and difficult Use Cases; for information purposes only.
<b>Total Estimate</b>	Review the detailed breakdown of the final figure. Note that you must tailor the hours

Option	Use to
	per Use Case point figure to the level that matches your type of project and capability based on known previous project outcomes.
<b>Default Rate</b>	Set the <a href="#">default hours</a> fed into the final calculation.
<b>Re-Calculate</b>	Re-run the estimate, usually after you change the hours or Use Case point number.
<b>Report</b>	Produce a rich text formatted report from the current estimate.

### 3.6.7.4 Default Hours

To set the default hour rate per adjusted Use Case point, use the **Default Hour Rate** tab of the **Estimation Factors** dialog.

To access this tab:

- Click on the **Default Rate** button on the [Use Case Metrics](#) dialog (displays the tab as the only tab of the **Settings** dialog), or
- Select the **Settings | Estimation Factors** menu option and click on the **Default Hour Rate** tab.

Type values in the **Duration** and **Hourly Rate** fields; click on the **OK** button to save the current values.

#### Notes:

- The values you enter are stored as local settings on your computer only.
- This option is also active in the 'Lite', read-only version of Enterprise Architect.

Setting an hourly rate is the most difficult factor in an accurate estimation. Typical ranges can vary from 10 to 30 hours per Use Case point. Studying the *Use Case Points Method*, from which this variable is defined, can help you to understand its role in the estimation and facilitate selection of a suitable initial value. The best way to estimate this value is through analysis of previous completed projects. By calculating the project estimation on a completed project for which the Use Cases and environment are configured within Enterprise Architect, you can adjust the hour rate to render an appropriate value for your unique work environment.

### 3.6.8 Update Package Status

Elements in Enterprise Architect can be assigned a current status, such as *Proposed*, *Validated* or *Mandatory*.

Often a complete package structure is updated from one status to another (or released) at the same time. To help facilitate this, Enterprise Architect supports a 'bulk' update of element status at the same time.

#### Update Element Status for a Complete Package Structure

To update element status for a complete package structure, follow the steps below:

1. In the **Project Browser**, right-click on the package to update. The context menu displays.
2. Select the **Package Control | Update Package Status** menu option. The **Status Update** dialog displays.



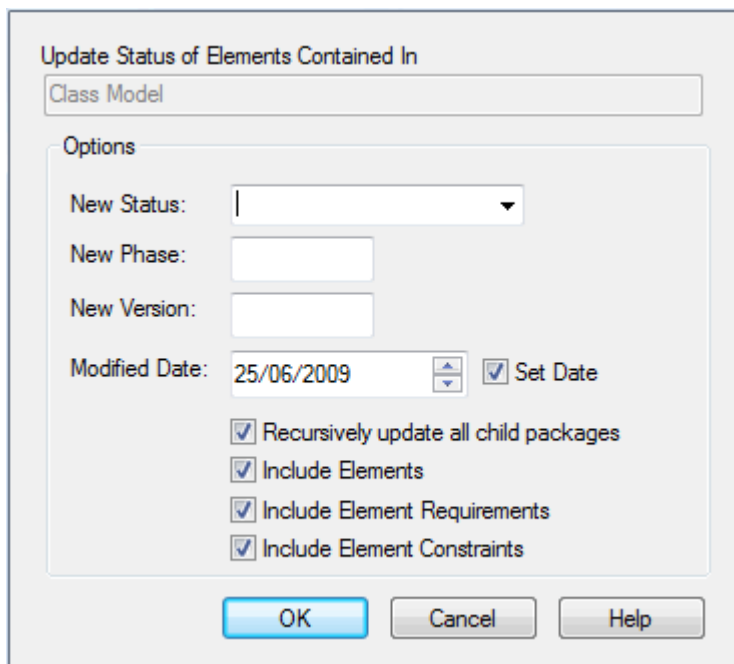

3. Select:
  - The new status
  - Whether to recursively descend the package tree
  - Whether to include elements
  - Whether to include element requirements
  - Whether to include element constraints
4. Click on the **OK** button. Enterprise Architect updates all required elements to the new status.

### 3.6.9 Manage Bookmarks

A bookmark is a visual clue that something is different about an element; you can assign whatever meaning to the bookmark as is appropriate to your model.

You bookmark a selected element in a diagram by pressing **[Shift]+[Spacebar]**, or by selecting the **Edit | Bookmark Selected** menu option. The bookmark is represented by a small red triangle that displays above the element in the diagram.

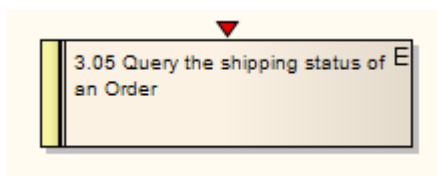

You clear the bookmark by clicking on the element and pressing **[Shift]+[Spacebar]** again, or by selecting the **Edit | Bookmark Selected** menu option again.

#### Tip:

The [Model Search window](#) <sup>1235</sup> also enables searching based on bookmarked elements.

### Bookmark Multiple Elements

You can also bookmark all elements in a folder (and their children) using the **Manage Bookmarks** dialog. Right-click on the parent package in the **Project Browser** and select the **Bookmarks** context menu option.

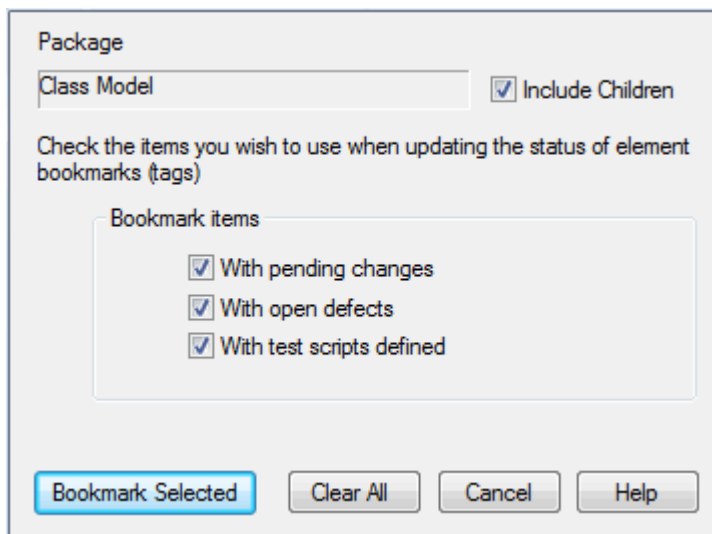

This dialog enables you to automatically bookmark elements that have new changes or defects defined in the [Maintenance](#) <sup>[1558]</sup> window, or test scripts defined in the [Testing](#) <sup>[1537]</sup> window. This is useful to highlight elements that have additional project information.

To clear all elements of bookmarks:

- In the current package tree, click on the **Clear All** button on the **Manage Bookmarks** dialog
- In the current diagram, select the **Edit | Clear All Bookmarks** menu option.

You should [reload the project](#) <sup>[267]</sup> to show the new or cleared bookmarks (**[Ctrl]+[Shift]+[F11]**).

### 3.6.10 Monitor Events

In the Enterprise Architect Corporate, Business and Software Engineering, Systems Engineering and Ultimate editions, the [Model Views](#) <sup>[1228]</sup> facility enables you to:

- automatically refresh the search in a View at an interval that you define
- notify you if the results of the search change between two consecutive searches.

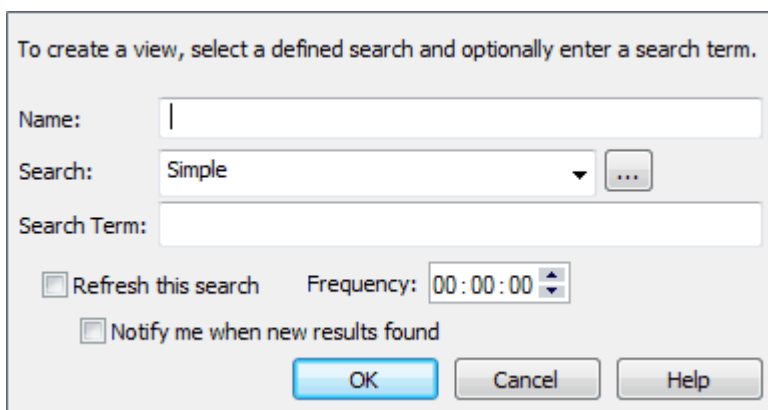

You can therefore use the **Model Views** facility to monitor various events in the development project, depending on how you set up the search in a View. You could, for example, set up a search to detect:

- Change items, or Issue items, so that Enterprise Architect would notify you as new items were created
- Element Status, Type, Phase, Version, Priority and/or date of last update, so that Enterprise Architect would notify you as items were progressed to fall in to the level of work represented by the search categories, and to move out of the categories into the next level of work.
- Tagged Values, so that - again - as items were changed to satisfy the criteria of a sequence of searches, the progression of items through a set of stages could be checked and managed.

People responsible for different stages in a process could have their own Model View searches so that as a

development, validation or authorization task falls due the responsible person is automatically notified, and when the work is complete both the next person in line and the overseeing manager are notified.

## 3.7 Maintenance

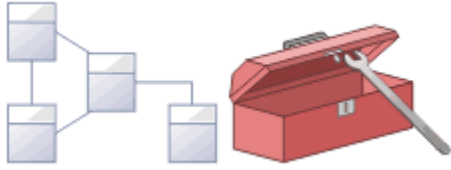

This topic highlights some administrative functions you might have to carry out to maintain your model:

- [Check Project Data Integrity](#)<sup>[344]</sup>
- [Upgrade Projects](#)<sup>[346]</sup>
- [Rename a Project](#)<sup>[348]</sup>
- [Compact a Project](#)<sup>[348]</sup>
- [Repair a Project](#)<sup>[348]</sup>

Note that you only rename, compact and repair models created as .EAP files. These processes are not required for models stored in a DBMS.

### 3.7.1 Project Data Integrity

If you have a failed XMI import, network crash or other unforeseen event that could disrupt the integrity of information in the model, it is recommended to run the [Project Integrity Check function](#)<sup>[344]</sup>.

The integrity check examines all database records and ensures there are no 'orphaned' records or inaccurate or unset identifiers. You can run the integrity checker first in report mode to discover if anything should be corrected, and then run it again in repair mode.

When Enterprise Architect checks the model, it attempts to recover lost packages and elements, and generates a new package at the model root level called `_recovered_`. Check through any elements that are found and, if required, drag them into the model proper. If they are not required, delete them.

#### Note:

This function does NOT check UML conformance, only the data relationships and repository structure.

You can select a variety of items to check, and select either to just report on the state of your model, or to try and repair any inconsistencies. The recovery process tries to restore elements where possible, but in some cases simply deletes the lost records.

#### See Also

- [Run SQL Patches](#)<sup>[346]</sup>

#### 3.7.1.1 Check Project Data Integrity

#### Note:

In the Corporate, Business and Software Engineering, System Engineering and Ultimate editions of Enterprise Architect, if security is enabled you must have [Check Data Integrity](#)<sup>[198]</sup> permission to perform a data integrity check.

To check the data integrity of your project, follow the steps below:

1. Select the **Tools | Data Management | Project Integrity Check** menu option. The **Project Integrity Check** dialog displays.

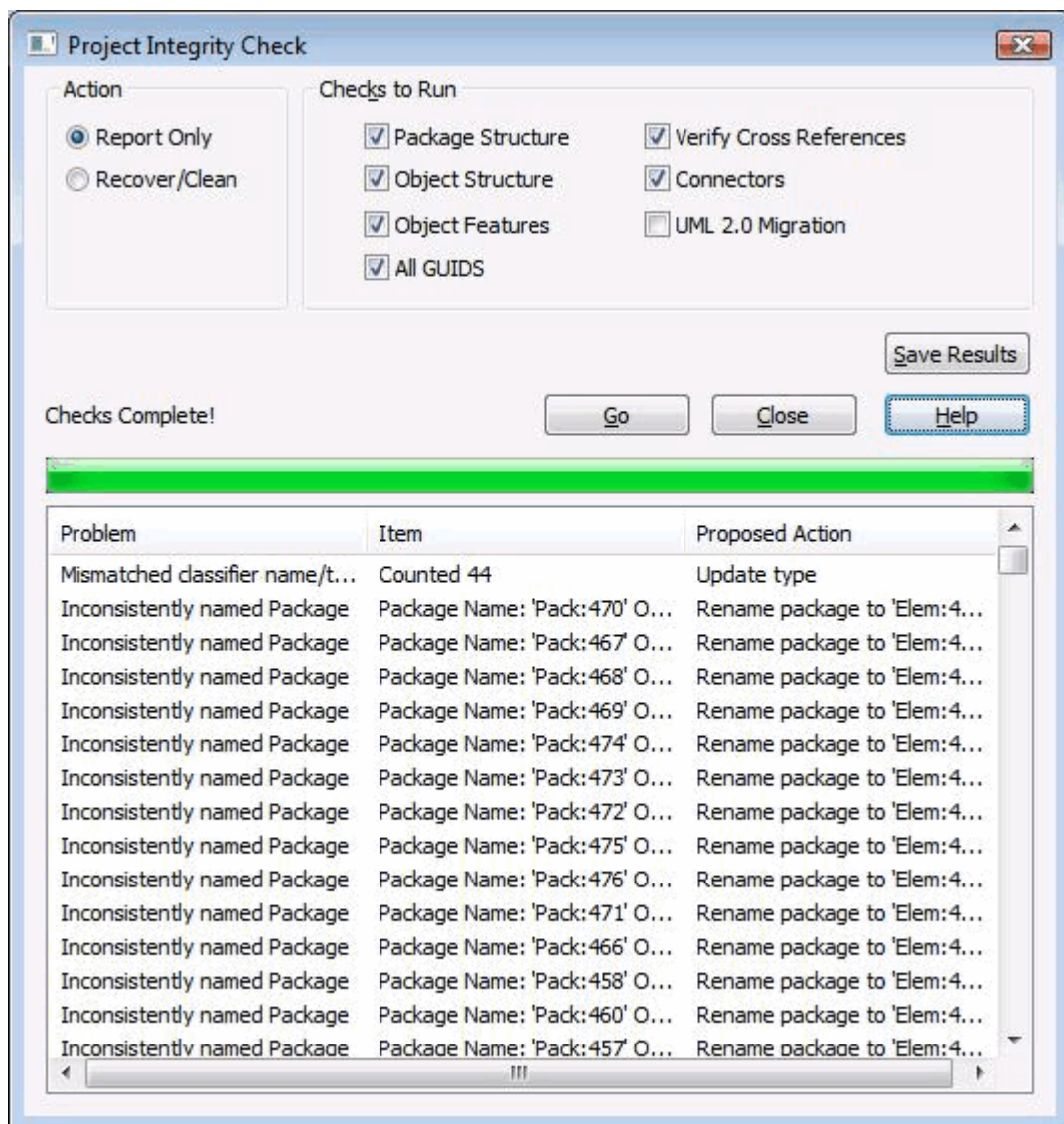

2. Select the checks to run; the basic checks available are:
  - Package Structure
  - Object Structure
  - Object Features
  - All GUIDs
  - Cross References
  - Connectors
  - UML 2.0 Migration.
3. Select either:
  - the **Report Only** option to just view a report on the state of your model, or
  - the **Recover/Clean** option to attempt to recover and clean your project.

**Warning:**

If you intend to select the **Recover/Clean** option, you should back up your project file first.

4. To write a log of the integrity check, click on the **Save Results** button and select a log file.
5. Click on the **Go** button to run the check. If you want to display the resulting information in a more readable layout, you can resize the dialog and its columns.

## UML 2.0 Migration

The UML 2.0 Migration check enables you to migrate the project from UML 1.3 semantics to UML 2.0 semantics. The migration process currently converts activities that are invocations of operations into called operation actions as per the UML 2.0 specification. The UML 2.0 Migration option is an exclusive process that does not enable any of the other checks to be selected. To perform the UML 2.0 migration follow the steps below:

1. Select the **Tools | Data Management | Project Integrity Check** menu option. The **Project Integrity Check** dialog displays.
2. Select the **UML 2.0 Migration** checkbox and click on the **Go** button. The following message box displays:

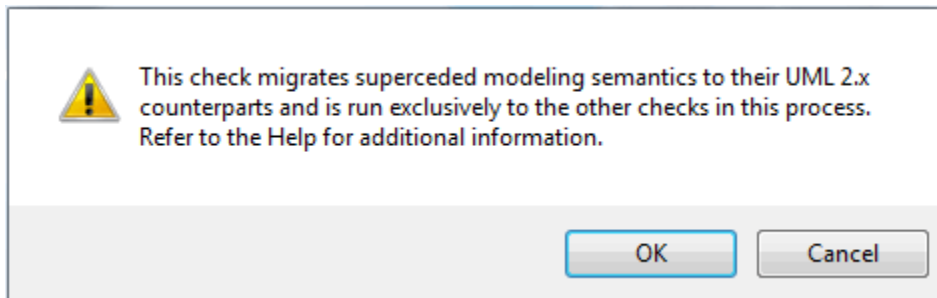

3. To proceed, click on the **OK** button, or to cancel the migration click on the **Cancel** button.
4. If you are proceeding, click on the **Go** button on the **Project Integrity Check** dialog to perform the migration.

### 3.7.1.2 Run SQL Patches

Occasionally, Sparx Systems might release a patch to correct a model fault.

To load such patches and run them, select the **Tools | Run Patch** menu option. The patch generally checks how many records are to be updated, and reports on what is to be done.

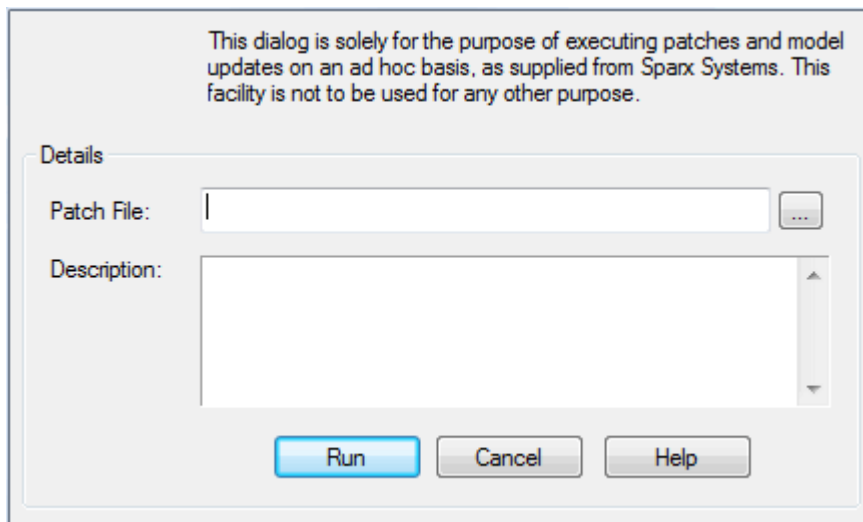

### 3.7.2 Project Upgrade

The structure of Enterprise Architect project files is occasionally changed to support more features. When this happens, existing project files must be upgraded to the new format to ensure correct operation and to take advantage of all the new features.

When you try to load a project that was created in an early release of Enterprise Architect (for example, an archived project) using a recent release of Enterprise Architect, the system determines whether the project should be upgraded and, if the upgrade is necessary, displays the [Upgrade Wizard](#)<sup>[347]</sup>, which takes you

through the upgrade process.

Upgrading is a simple and quick process that brings your project to the current level to support all the latest Enterprise Architect features.

### 3.7.2.1 The Upgrade Wizard

When you first try to load an old project in a new version of Enterprise Architect, the system determines whether the project should be upgraded and, if the upgrade is necessary, displays the **Upgrade Project Wizard**.



The **Upgrade Project Wizard**:

- Advises you of the necessity to upgrade
- Advises you to back up the current project; it is essential to back up before any changes are made
- Checks which upgrade path is required
- Guides you through the steps to perform the upgrade
- Opens the newly converted project.

#### Notes:

- For replicated models: If the wizard detects the project you are opening is a replica and not a Design Master, [a different upgrade path](#)<sup>[347]</sup> is required.
- Once upgraded, the project cannot be opened with the version of Enterprise Architect in which it was created.

### 3.7.2.2 Upgrade Replicas

Models that have replication features added might have to be upgraded differently from regular projects.

If the model is a **Design Master**<sup>[185]</sup> (the root model of all other replicas) then you can upgrade the model to suit the current version of Enterprise Architect. After upgrading a Design Master you should re-create the replicas, rather than synchronizing.

If the model is not a Design Master, Enterprise Architect must first remove the replication features, then upgrade the project in the normal manner. The **Upgrade Wizard**<sup>[347]</sup> guides you through the steps.

### 3.7.3 Rename a Project

**Important:**

The only way to rename an Enterprise Architect project is at the Windows file system level.

To rename an Enterprise Architect project .EAP file, follow these steps.

1. If you have the project open, shut it down.
2. Ensure no other users have the file open.
3. Open Windows Explorer and navigate to the project.
4. Rename the project file using Windows Explorer.
5. You should keep the .EAP extension the same to preserve compatibility with the default project type, as installed in the registry at installation time.

### 3.7.4 Compact a Project

After some time, a project .EAP file might benefit from compacting to conserve space.

**Notes:**

- Compacting shuffles the contents of the model around, eliminating unused space and generally reducing the size of your model file.
- In the Corporate, Business and Software Engineering, System Engineering and Ultimate editions of Enterprise Architect, if security is enabled you must have [Administer Database](#) <sup>(198)</sup> permission to compact a project.

**Warning:**

Always compact and repair projects on a local drive, never on a network drive.

To compact a project, follow the steps below:

1. Ensure that no users have the target project open.
2. Select the **Tools | Manage .EAP File | Compact .EAP File** menu option.
3. Follow the on-screen instructions to complete the process.

### 3.7.5 Repair a Project

If a project has not been closed properly, such as during system or network outages, on rare occasions the .EAP file does not open correctly. In this case a message displays informing you the project is of an unknown database format or is not a database file.

**Warning:**

Never attempt to repair a project over a network connection; copy it to a local drive first.

**Notes:**

- Poor network connections can also cause this symptom.
- In the Corporate, Business and Software Engineering, System Engineering and Ultimate editions of Enterprise Architect, if security is enabled you must have [Administer Database](#) <sup>(198)</sup> permission to repair a project.

#### Repair a Project That Has Not Closed Correctly

To repair a project that was not closed properly, follow the steps below:

**Note:**

All users must be logged off the project you are attempting to repair.

1. Copy the project file to a local drive on your PC.



2. In Enterprise Architect, select the **Tools | Options** menu option and on the **General** page deselect the **Use Jet 4.0 - requires restart** checkbox.
3. Close and restart Enterprise Architect and open a place holder project to enable access to the **Repair .EAP File** facility.

**Note:**

This is NOT the project you intend to repair, it is a copy of it.

4. Select the **Tools | Manage .EAP File | Repair .EAP File** menu option.
5. Follow the on-screen instructions.

### Ensure Integrity of the Repaired Project

An additional step you can use to ensure the integrity of your project is to use the **Remove Replication** feature.

1. Open Enterprise Architect, but when you are prompted to open a project, click on the **Cancel** button.
2. Select the **Tools | Manage .EAP File | Remove Replication** menu option.
3. Follow the prompts. When you are prompted for the **Replica Project Browser** window for your problem project, you might be given a warning about the project not being the *Design Master*; accept this warning. Click on the **Next** button.
4. Browse for the clean project (for example, *EABase.eap*). Click on the **Next** button.
5. Enter the path and name of the new project to be created, then click on the **Next** button.
6. Click on the **Run** button to run the removal process.
7. Once the removal process has been completed, open the project and do a check of the project contents. If the data is intact, backup the old project and replace it with the new version.

## 3.8 Local Options



There are several options to customize how Enterprise Architect displays and works with models and model elements. This topic describes those settings that are local to a particular user and machine.

Select the **Tools | Options** menu option to display the **Options** dialog.

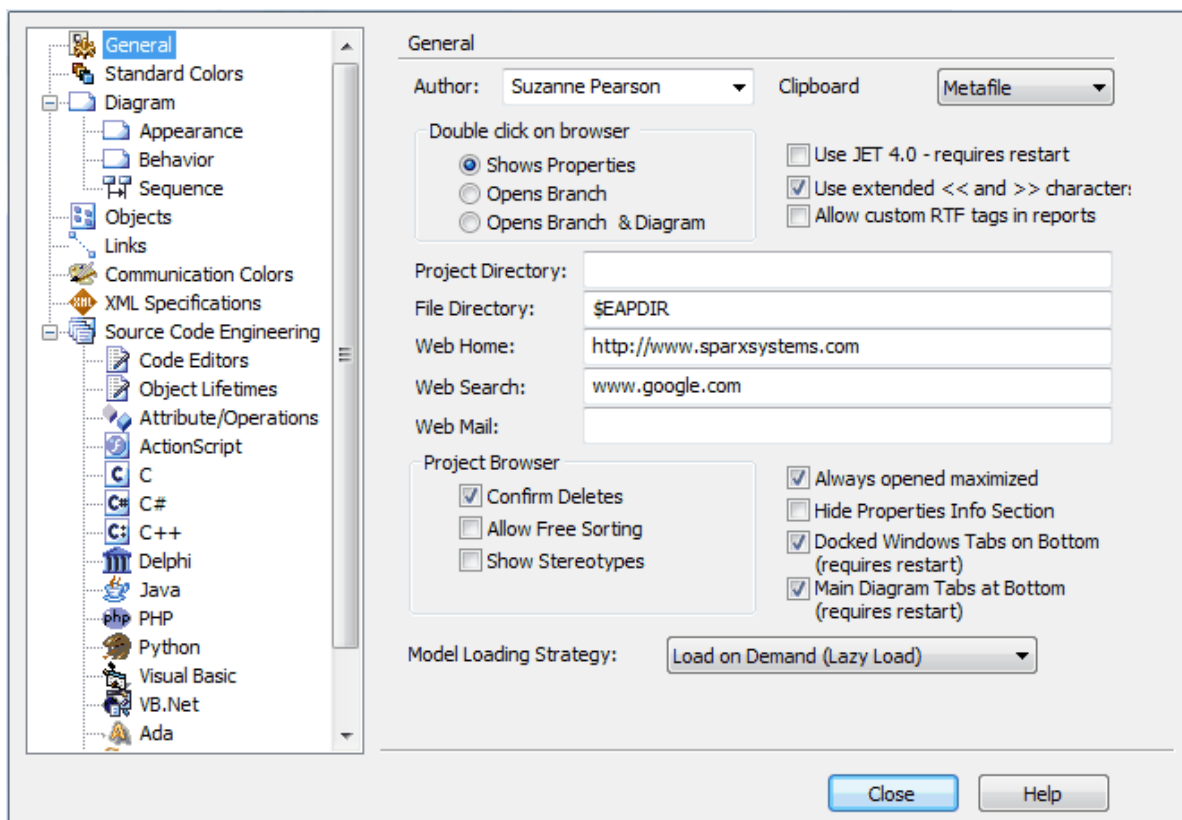

Most of these settings are stored in your registry so they are set for your use only. For a networked workplace, registry settings can be copied down to any network workstation you log in to. Otherwise, the settings are valid for the current machine only.

You select the required page of options by clicking on the appropriate category name in the left hand list on the dialog. For information on the options on a specific page, select the appropriate page title below.

- [General](#) <sup>[351]</sup>
- [Standard Colors](#) <sup>[353]</sup>
- [Diagram](#) <sup>[355]</sup>
- [Diagram Appearance](#) <sup>[356]</sup>
- [Diagram Behavior](#) <sup>[359]</sup>
- [Diagram Sequence](#) <sup>[360]</sup>
- [Objects](#) <sup>[362]</sup>
- [Links](#) <sup>[364]</sup>
- [Communication Message Colors](#) <sup>[366]</sup>
- [Source Code Engineering](#) <sup>[1336]</sup>
- [Code Editors](#) <sup>[1337]</sup>
- [Object Lifetimes](#) <sup>[1340]</sup>
- [Attribute/Operations](#) <sup>[1341]</sup>
- [ActionScript](#) <sup>[1348]</sup>
- [C](#) <sup>[1349]</sup>
- [C#](#) <sup>[1350]</sup>
- [C++](#) <sup>[1351]</sup>
- [Delphi](#) <sup>[1352]</sup>
- [Python](#) <sup>[1356]</sup>
- [Visual Basic](#) <sup>[1360]</sup>
- [VB.Net](#) <sup>[1358]</sup>

- [XML Specifications](#)<sup>[367]</sup>
- [Java](#)<sup>[1355]</sup>
- [PHP](#)<sup>[1358]</sup>

**Note:**

The options in the second and third columns above, and additional defaults and settings, are discussed under the various code generation and import/export topics in this User Guide.

### 3.8.1 General

The **General** page of the **Options** dialog is shown below:

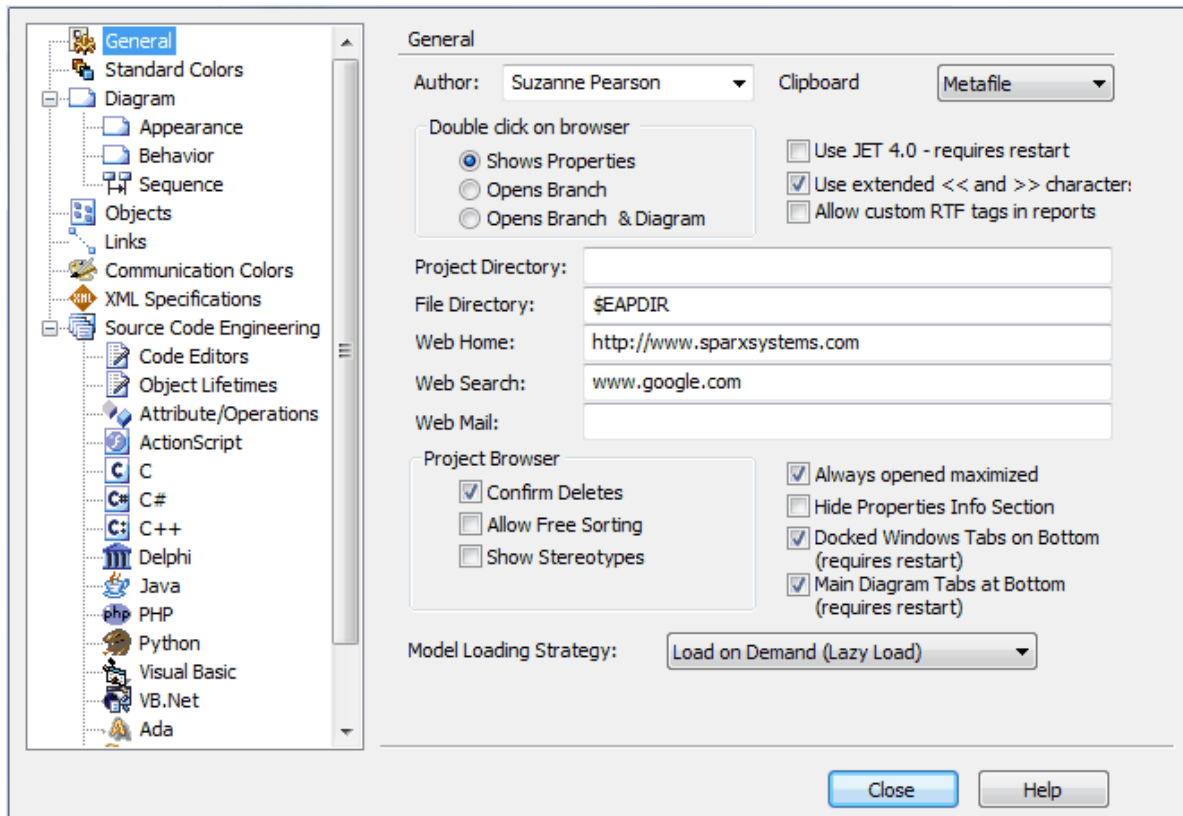

Option	Use to
<b>Author</b>	Set the default author when new elements are created and modifications made.
<b>Clipboard Format</b>	Set the graphic format in which to save image to the clipboard; <b>Metafile</b> has the best detail.
<b>Double-click on Browser</b>	Configure the <a href="#">Project Browser behavior</a> <sup>[1210]</sup> .
<b>Use Jet 4.0 - requires restart</b>	Set JET 4.0 as the database engine; this ensures compatibility with .EAP files that are in turn compatible with versions of MS Access later than Access 97, and that support unicode character sets.  If your project is not in a Jet 4.0 database, you should also download a copy of the Jet 4.0 EABase Model from the <a href="#">Sparx Systems website</a> , and do an EAP to EAP <a href="#">transfer</a> <sup>[307]</sup> of your model into the Jet 4.0 file.
<b>Use extended « and » characters</b>	Apply the guillemet characters to stereotypes. For some double byte character sets, it is best to select this checkbox.

Option	Use to
<b>Allow custom RTF tags in reports</b>	Enable you to use customized rich text format code in report templates when generating reports with the <a href="#">Legacy RTF Report Generator</a> <sup>[1628]</sup> . From release 7.0 of Enterprise Architect, with the <a href="#">Notes</a> <sup>[642]</sup> formatting facility, this option is not really necessary.
<b>Project Directory</b>	Specify the default location of Enterprise Architect projects.
<b>File Directory</b>	Specify the default location for files.
<b>Web Home</b>	Specify the default home page to open when you click on the <b>Home</b> button in the internal <a href="#">web browser</a> <sup>[103]</sup> .
<b>Web Search</b>	Specify the default web page to open when clicking on the <b>Web Search</b> button in the internal <a href="#">web browser</a> <sup>[103]</sup> .
<b>Web Mail</b>	Specify the email server address (http://xxxxx/exchange/) for accessing email through the <a href="#">web browser</a> <sup>[103]</sup> within Enterprise Architect.
<b>Confirm Deletes</b>	Use or bypass the <b>Confirm Delete</b> dialog; only clear this checkbox if you are an experienced user!
<b>Allow Free Sorting</b>	Enable you to re-order elements within a package regardless of element type, in the <b>Project Browser</b> .
<b>Show Stereotypes</b>	Show element and feature stereotypes in the <b>Project Browser</b> .
<b>Always open maximized</b>	Ensure that Enterprise Architect always starts up in a maximized window.
<b>Hide Properties Info Section</b>	Hide or show the properties information status bar on the <b>Properties</b> window.
<b>Docked Windows Tabs on Bottom (requires restart)</b>	Display the docked window tabs at the bottom of the window (default). Clear the checkbox to show the tabs at the top of the windows.
<b>Main Diagram Tabs at Bottom (requires restart)</b>	Display the diagram tabs at the bottom of the main view (default). Clear the checkbox to show the tabs at the top of the main view.
<b>Model Loading Strategy</b>	Select the Enterprise Architect model loading behavior; choose either: <ul style="list-style-type: none"> <li>• <b>Load on Demand (Lazy Load)</b></li> <li>• <b>Preload Entire Model</b></li> </ul> <p><b>Load on Demand</b> does not load the full project view when the model is loaded. Instead, only the parts that are necessary to display the visible portion of the tree are loaded. This means that a model loads faster and users can begin work sooner, but at the expense of later small delays as Enterprise Architect loads specific portions of the model.</p>

### 3.8.2 Standard Colors

The **Standard Colors** page of the **Options** dialog enables you to set the display color of a range of objects and their backgrounds. On first use, the page displays the system default colors, as shown below:

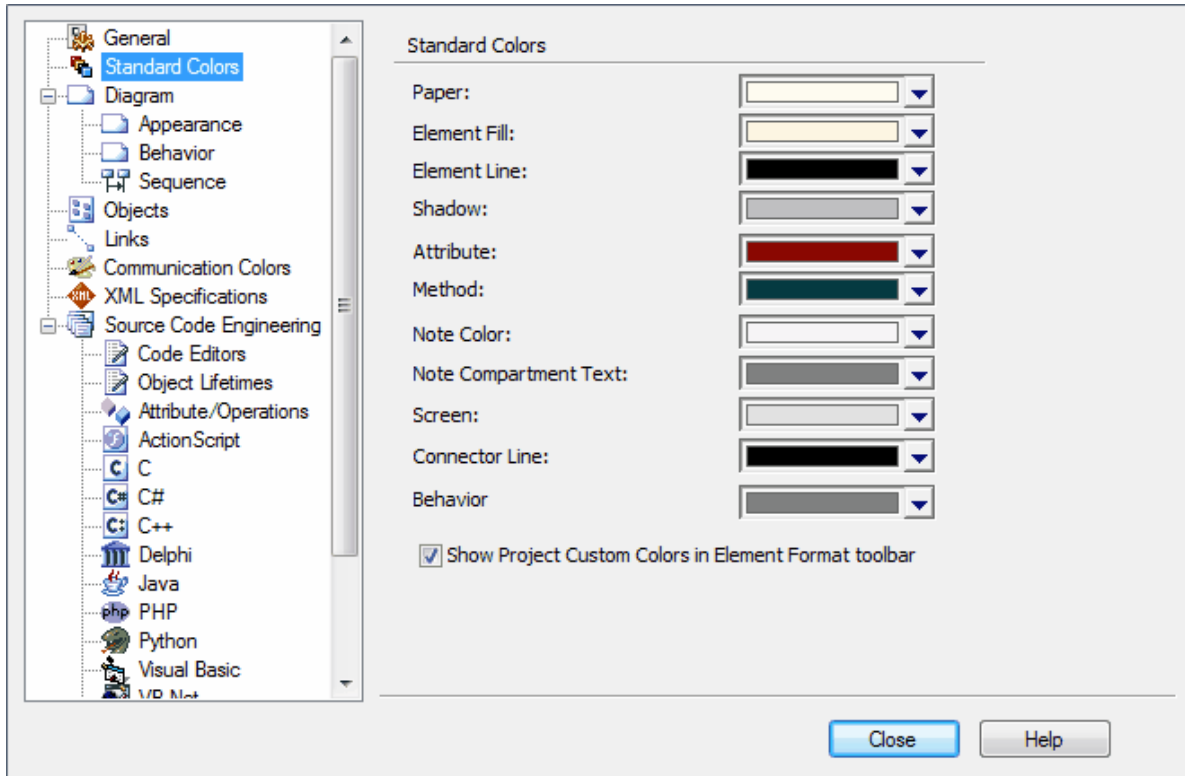

To display the range of colors available for an item, or define a new color, click on the down arrow at the end of the appropriate field. The selection pallet displays.

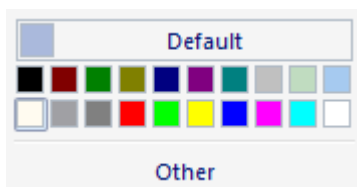

Click on the required color. This sets the field on the **Standard Colors** page to the selected color.

If you require a wider selection of colors, click on the **Other** button and select from the color chart, or customize a color using RGB/HSL codes.

If you decide to reset the color to the system default, click on the **Default** button.

Option	Use to
<b>Paper</b>	Define the paper (background) color in diagrams.
<b>Element Fill</b>	Define the fill color of elements.
<b>Element Line</b>	Define the line color of elements.
<b>Shadow</b>	Define the color of element outline shadows.
<b>Attribute</b>	Define the color of attribute text.

Option	Use to
Method	Define the color of method (operation) text.
Note Color	Define the note background color.
Note Compartment Text	Define the color of text in the element Note compartment.
Screen	Define the screen (element) color.
Connector Line	Define the connector line color.
Behavior	Define the color for behaviors in Activity diagrams.
Show Project Custom Colors in Element Format toolbar	Enable use of project custom colors; for more information on setting and getting the custom colors see the <a href="#">Get and Set Project Custom Colors</a> <sup>[54b]</sup> topic.

#### Notes:

- Using this page of the **Options** dialog, you can set the background of all diagrams to be a specific color. You can also use the [Diagram Appearance](#)<sup>[35b]</sup> page to set all diagram backgrounds to be either a uniform color or to have a fade gradient from top to bottom. Alternatively, you can create a background image for the diagram; see the [Create Custom Diagram Background](#)<sup>[44b]</sup> topic.
- To override the default appearance of a specific element on all diagrams on which it is found, right-click on the element and select the **Appearance | Default Appearance** context menu option. The [Default Appearance](#)<sup>[53b]</sup> dialog displays.
- To change the appearance of a specific element on the current diagram only, use the [Format](#)<sup>[85]</sup> toolbar<sup>[85]</sup>. If the **Format** toolbar is not displayed, select the **View | Toolbars | Format Tool** menu option.

### 3.8.3 Diagram

The **New Diagram Defaults** page of the **Options** dialog enables you to configure overall options for new diagrams and general diagram behavior.

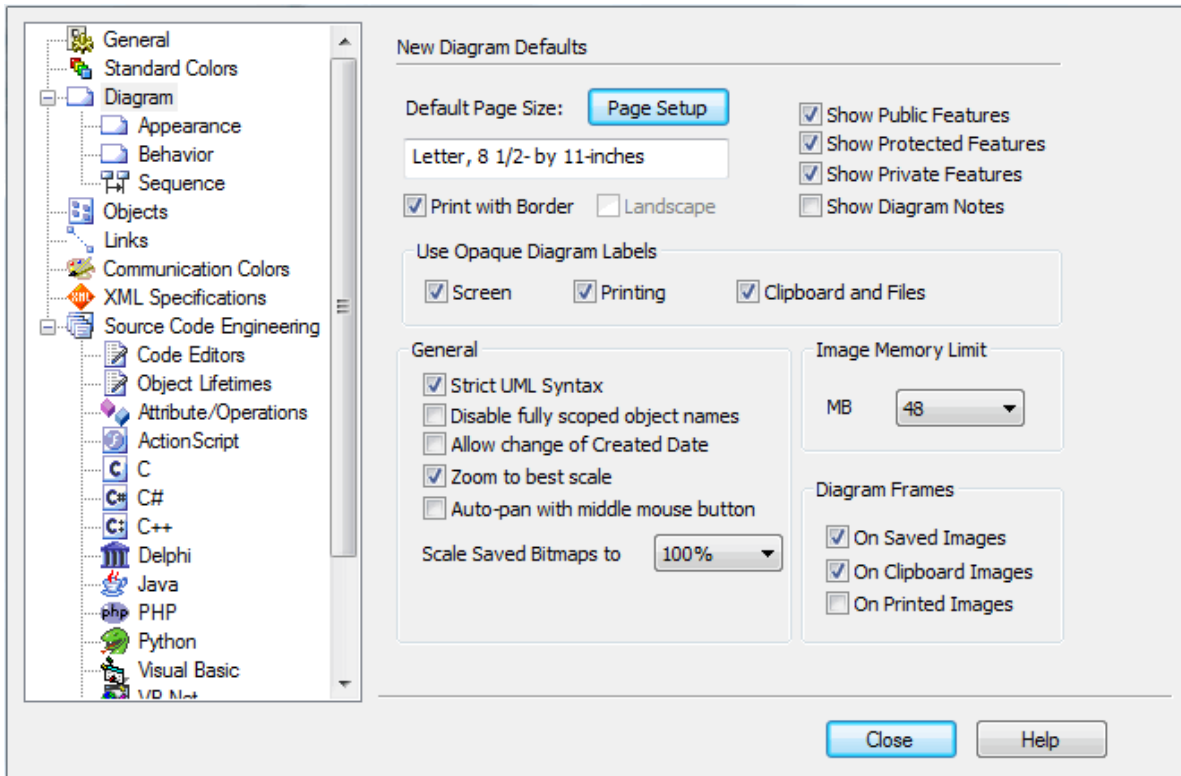

Option	Use to
<b>Default Page Size</b>	Show the default page size for new diagrams, which you set by clicking on the <b>Page Setup</b> button to display the <b>Page Setup</b> dialog.
<b>Print with Border</b>	Print pages with a border.
<b>Landscape</b>	Print pages in landscape orientation. This checkbox is controlled from the <b>Page Setup</b> dialog.
<b>Show Public Features</b> <b>Show Protected Features</b> <b>Show Private Features</b>	Set the default visibility of Class features.
<b>Show Diagram Notes</b>	Display the diagram details in the top left corner of all diagrams in the model. Details include diagram name, package, version and author.
<b>Use Opaque Diagram Labels</b>	Specify where opaque diagram labels should display. <b>Screen</b> and <b>Printing</b> are best, <b>Clipboard and Files</b> might not be desirable.
<b>Strict UML Syntax</b>	Enforce compliance with UML syntax when adding new connectors and other structures.
<b>Disable fully scoped object names</b>	Disable fully scoped object names, when an element is in a diagram; don't use when the element is in its home package. A scoped name is of the format <i>MyClasses::foo</i> , the <i>::</i> character indicating that the Class is within another namespace.
<b>Allow change of Created Date</b>	Enable the creation date on the <b>Diagram Properties</b> dialog to be altered.

Option	Use to
<b>Zoom to best scale</b>	Resize diagrams to neatly fit the screen.
<b>Auto-pan with middle mouse button</b>	Turn on auto-panning using the middle mouse button. With this option off, the middle mouse button causes a different type of panning.
<b>Scale Saved Bitmaps to</b>	Enable Enterprise Architect to save bitmaps at a higher <i>resolution</i> , suitable for using in published works.
<b>Image Memory Limit</b>	Set an image memory limit when generating images for RTF or HTML and when saving images to file. It is important when you have very large diagrams, as it affects the point at which Enterprise Architect starts to scale down the image; a low memory setting means it scales the image sooner.
<b>Diagram Frames</b>	Select whether diagram frames are to be automatically added to images of diagrams in files saved to disk, print-outs, and the default Enterprise Architect clipboard.  A <a href="#">diagram frame</a> <sup>[766]</sup> is a labeled outline around the diagram image, providing both a border and a reference.

### 3.8.3.1 Appearance

The Diagram **Appearance** page of the **Options** dialog enables you to define how diagrams and their contents appear on display.

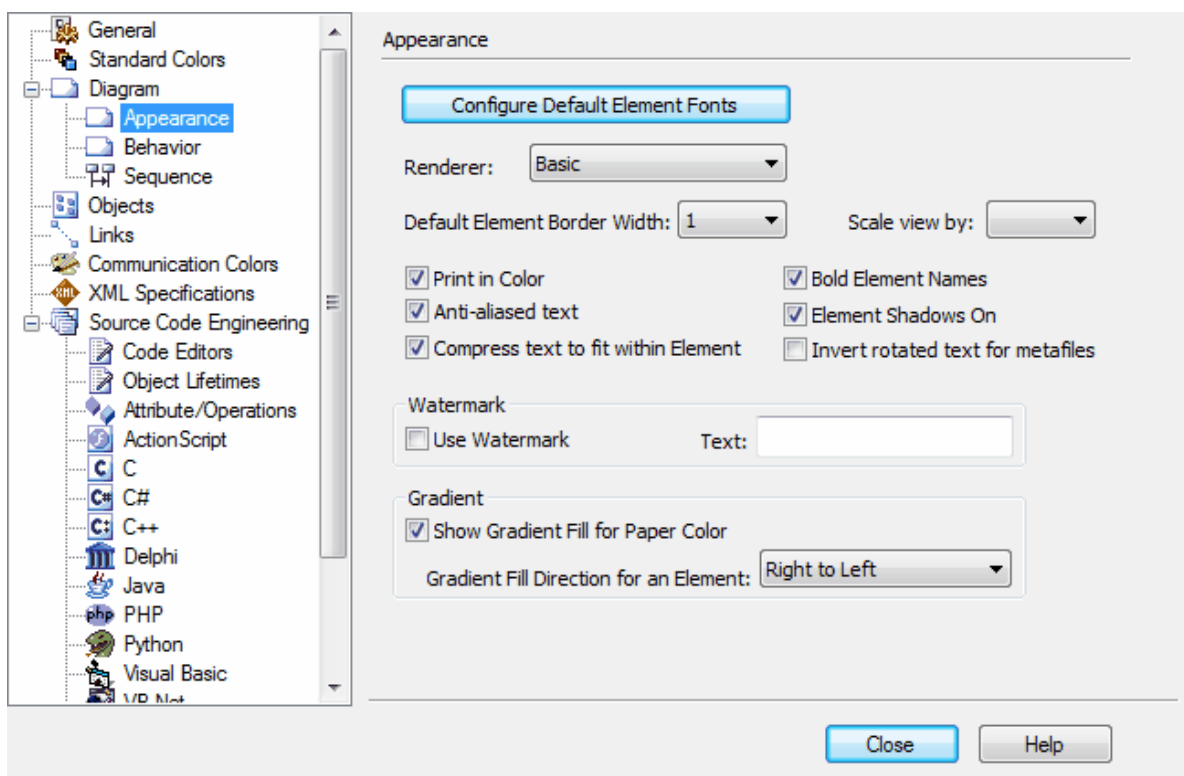

Option	Use to
<b>Configure Default Element Fonts</b>	<a href="#">Set the default model and user text fonts</a> <sup>[357]</sup> .
<b>Renderer</b>	Render smooth curves and diagonal lines in diagrams, so that staggered vertical or horizontal pixels are less obvious. Select the type of renderer you prefer to use:



Option	Use to
	<ul style="list-style-type: none"> <li>• <b>Basic</b> is GDI32; it does not provide anti-aliasing and gradient fills</li> <li>• <b>Enhanced-1</b> is parallel to Windows GDI+ but internal to Enterprise Architect; it provides anti-aliasing and gradient fills, and operates well across different platforms</li> <li>• <b>Enhanced-2</b> is Windows GDI+; this can vary across different platforms, performing better than <b>Enhanced-1</b> in some environments, and less well in others.</li> </ul> <p>Experiment with these options and see which works best for your system and requirements.</p>
<b>Default Element Border Width</b>	Set the default element border width (in pixels).
<b>Scale view by</b>	<p>Automatically increase the size of all objects on a diagram by up to 50%, without affecting other users reading that diagram.</p> <p>You can perform the same function with the Zoom Slider on the <a href="#">Status</a> <sup>89</sup> bar; changes in the 'zoomed' display scale of a diagram update this field and affect any other diagrams that you open.</p> <p>This has no impact any other diagram Zoom facility in Enterprise Architect.</p>
<b>Print in Color</b>	Print your diagrams in color. Deselect the checkbox to print the diagrams in black and white.
<b>Anti-aliased text</b>	<p>Force text anti-aliasing in diagrams.</p> <p>If you deselect the checkbox, Enterprise Architect applies the MS Windows default setting. Therefore, if you do not want to use anti-aliasing, ensure that the Windows anti-aliasing default is also set to OFF.</p>
<b>Compress text to fit within Element</b>	Determine the behavior of Enterprise Architect when text at <i>zoom</i> levels other than 100% would not fit inside the boundary of an element. Enterprise Architect either compresses the text to fit within the boundary, or expands the element.
<b>Bold Element Names</b>	Display element names in bold text.
<b>Element Shadows On</b>	Display a shadow around the bottom and right edges of each element in a diagram.
<b>Invert rotated text for metafiles</b>	Use different text format when external metafile readers are causing issues.
<b>Use Watermark</b>	Add a watermark to any diagrams you print.
<b>Text</b>	Define the watermark text, if a watermark is to be used.
<b>Show Gradient Fill for Paper Color</b>	Switch between having a color gradient in the diagram background, or having a solid, uniform background color.
<b>Gradient Fill Direction For an Element</b>	Select the direction for the color gradient within element boxes, or <b>&lt;none&gt;</b> for no color gradient.

### 3.8.3.1.1 Set Default Fonts

Enterprise Architect enables you to define a standard font to apply across the model, or a font to apply to any diagrams you create personally.

You can define both, but the model font overrides any user font, to ensure that all members of a project team have a consistent and coherent view of the model. This avoids the problem of one user creating a diagram in a small font, and another user trying to view it in a larger font, which distorts the diagram.

It is recommended that a project authority sets the model default, and all project members abide by it and do

not change it without project approval.

To set the default fonts, follow the steps below:

1. On the **Appearance** page of the **Options** dialog, click on the **Configure Default Element Fonts** button. The **Configure Default Fonts** dialog displays.

2. To set a model font, in the **Font Face** field of the **Model Font** panel, click on the drop-down arrow and select the appropriate typeface.
3. In the **Font Size** field, click on the drop-down arrow and select the required font size.
4. To clear a model font so that the user font takes effect, click on the **Clear** button. (Ensure that this is acceptable to all other team members.)
5. To set a user font, in the **Font Face** field of the **User Font** panel, click on the drop-down arrow and select the appropriate typeface.
6. In the **Font Size** field, click on the drop-down arrow and select the required font size.
7. To return the user font to the Enterprise Architect default (Arial 8), click on the **Restore Defaults** button.
8. To save the changes, click on the **OK** button.

Both model and user fonts are overridden by specifically-defined element fonts, so that the element is viewed as designed regardless of the model or user defaults. To define the font for a specific element, right-click on the element in a diagram and select the **Appearance | Set Font** <sup>[556]</sup> context menu option.

If you cannot read the diagrams because the default font makes the objects and text too small, you can scale up all objects (that is, all diagram displays) to a more readable size for you only; the objects are not scaled up for other users. Everything on the diagram is enlarged to the same extent, so it remains in proportion and readable. To do this, return to the **Diagram Appearance** page of the **Options** dialog and enter a suitable percentage value in the **Scale view by** <sup>[357]</sup> field.

### 3.8.3.2 Behavior

The **Diagram Behavior** page of the **Options** dialog enables you to define how a diagram responds to actions taken on it.

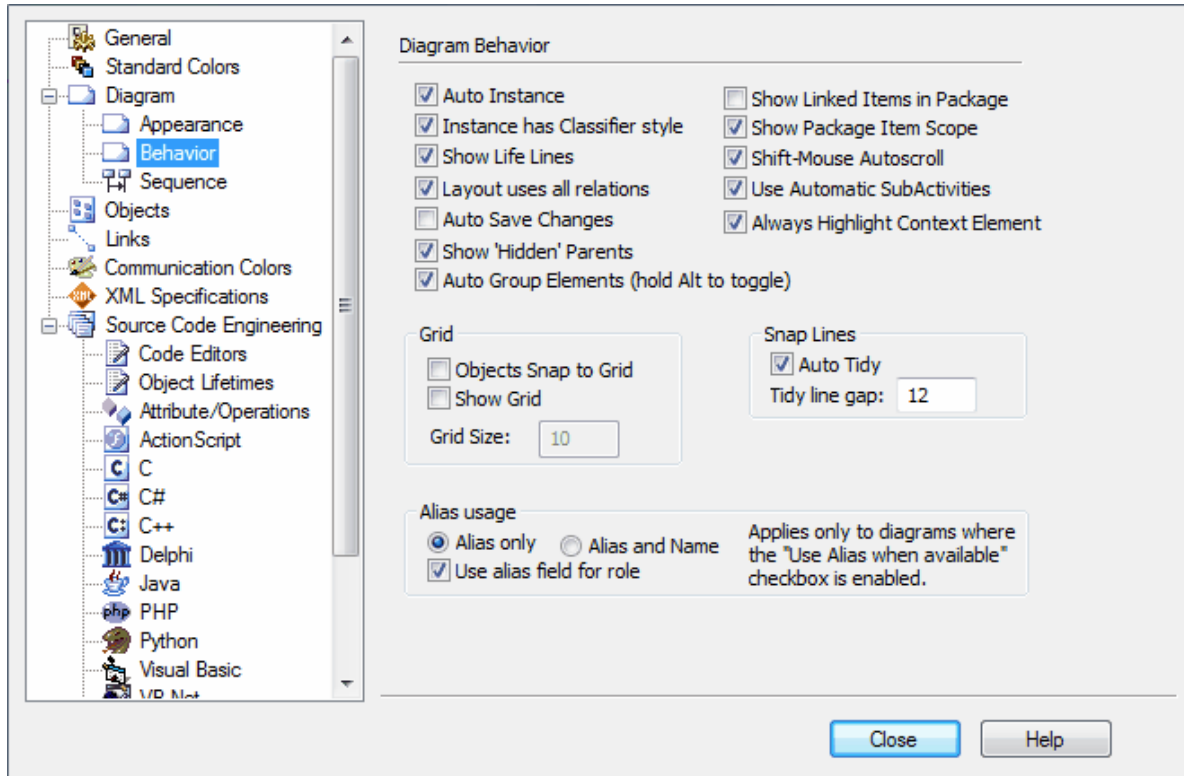

Option	Use to
<b>Auto Instance</b>	Automatically create object instances when dragging certain element types - such as Class and Component - from the <b>Project Browser</b> , with the dragged element as the classifier.
<b>Instance has Classifier style</b>	Automatically apply the classifier style of the element an instance is instantiated from when the instance is created.
<b>Show Life Lines</b>	Show life lines for Sequence elements in non-Sequence diagrams.
<b>Layout uses all relations</b>	Show all relationships in a diagram layout; deselect the checkbox to show only Generalizations and Associations.
<b>Auto Save Changes</b>	Automatically save your changes as you work, without having to confirm prompts to do so.
<b>Show 'Hidden' Parents</b>	Display any parents of elements in the diagram that are not part of the diagram.
<b>Auto Group Elements</b>	Also move visually composed elements when moving diagram nodes. A node is considered composed if it is contained by the moved element and has a higher z-order. Press and hold <b>[Alt]</b> whilst moving an element to toggle this option.
<b>Show Linked Items in Package</b>	Display connected items on packages.
<b>Show Package Item Scope</b>	Display the + and - indicators representing the scope of the items.

Option	Use to
<b>Shift-Mouse Autoscroll</b>	Enable you to press and hold <b>[Shift]</b> and use the mouse to autoscroll around diagrams.
<b>Use Automatic SubActivities</b>	Generate a new Structured Activity linked to the diagram from a Structured Activity diagram dragged from the <b>Project Browser</b> .
<b>Always Highlight Context Element</b>	Show a <a href="#">hatch border</a> around a selected element.
<b>Objects Snap to Grid</b>	Snap all elements to the grid lines.
<b>Show Grid</b>	Display the grid.
<b>Grid Size</b>	Specify the grid size, if you have selected <b>Objects Snap to Grid</b> .
<b>Auto Tidy</b>	Automatically <a href="#">tidy line angles</a> for custom connectors. This 'nudges' the custom line into horizontal and vertical increments.
<b>Tidy line gap</b>	Specify the amount Enterprise Architect should enable you to move a line away from horizontal and vertical when you are <a href="#">tidying lines</a> for custom connectors. (See <b>Auto Tidy</b> above).
<b>Alias only</b>	Display the alias instead of the element name on elements with aliases.
<b>Alias and Name</b>	Display both the element name and the Alias in the format ( <i>Alias</i> ) <i>name</i> .
<b>Use alias field for role</b>	Replace the Alias property of instances with a Role property.

### 3.8.3.3 Sequence

The **Sequence** page of the **Options** dialog enables you to configure various font settings and the focus of the control indicator for Sequence diagrams.

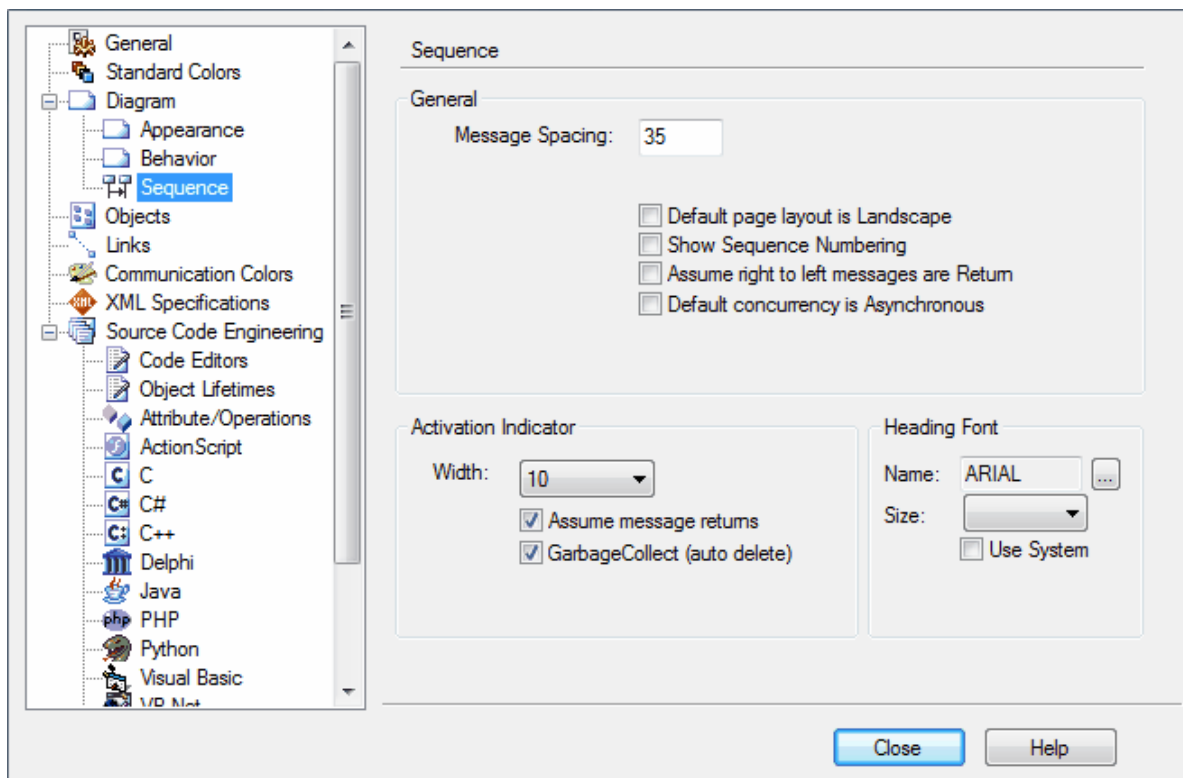

Option	Use to
<b>Message Spacing</b>	Specify the vertical gap (in points) between Sequence messages (can be overridden manually by dragging a message up or down).
<b>Default page layout is Landscape</b>	Set the default orientation of Sequence diagrams to landscape.
<b>Show Sequence Numbering</b>	Show sequence numbers on Sequence messages.
<b>Assume right to left messages are Return</b>	Automatically generate return messages.
<b>Default concurrency is Asynchronous</b>	Set the default concurrency for <a href="#">Sequence Messages</a> to <b>Asynchronous</b> ; deselect to set the default concurrency to <b>Synchronous</b> .
<b>Width</b>	Select the line width (in points) of the 'focus of control' rectangle (thick part of lifeline).
<b>Assume message returns</b>	Assume implicit returns when none are explicitly drawn (recommended).
<b>GarbageCollect</b>	Automatically truncate lifelines for created elements after the last message (that is, assume garbage collect rather than explicit delete).
<b>Name</b>	Display the MS Windows <b>Font</b> dialog (click on [ ... ]) and define the font of the caption bar heading (above your diagram); this is particularly useful for non-English character sets.
<b>Size</b>	Specify the size of the heading font (this overrides the font size in the <b>Font</b> dialog, above).
<b>Use System</b>	Apply the Enterprise Architect system default heading font.

### 3.8.4 Objects

The **Objects** page of the **Options** dialog enables you to configure how elements look and respond in diagrams.

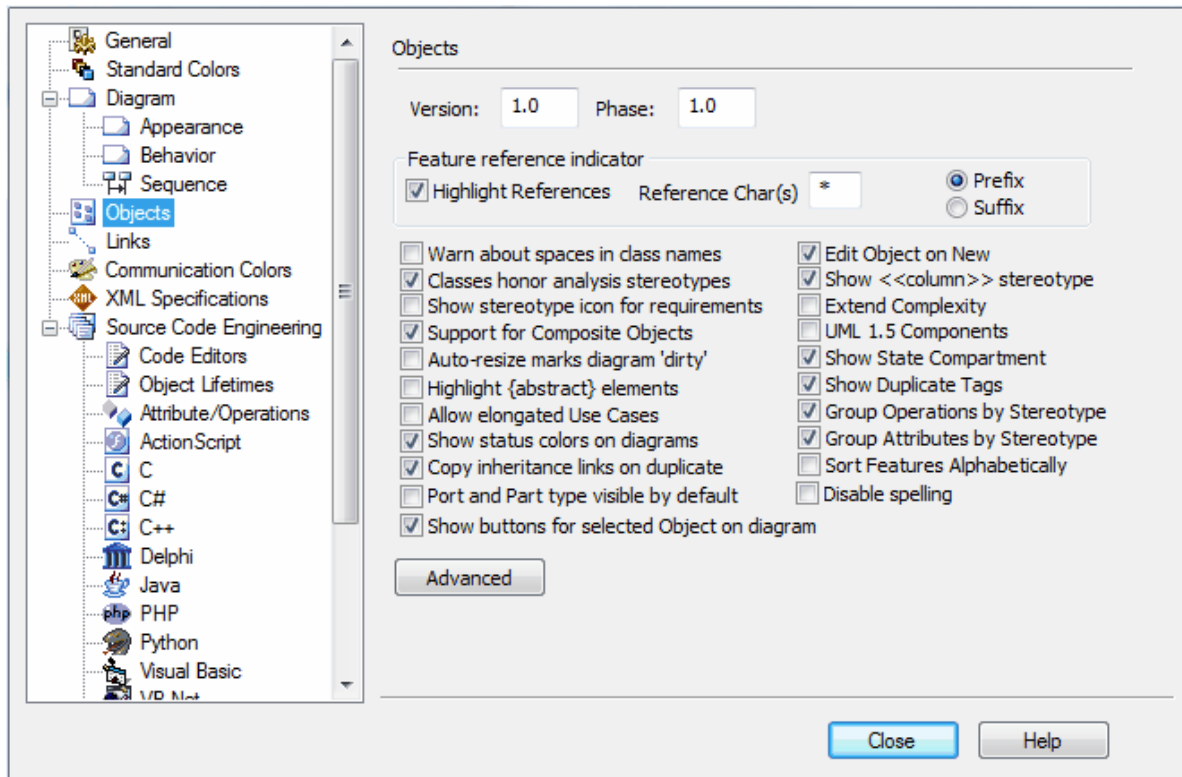

Option	Use to
<b>Version</b>	Set the default version for new elements.
<b>Phase</b>	Set the default phase for new elements.
<b>Highlight References</b>	Highlight parameters in operations that are passed by reference rather than value.
<b>Reference Char(s)</b>	Specify a character to use for the reference.
<b>Prefix/Suffix</b>	Indicate whether to use the <b>Reference Char(s)</b> value as a prefix (before) or a suffix (after).
<b>Warn about spaces in class names</b>	Enable or hide the warning message that a Class, operation or attribute name has embedded spaces (which can cause coding problems).
<b>Classes honor analysis stereotypes</b>	Show Classes as their stereotype; for example, if a Class is stereotyped as a Boundary, it appears as a Boundary rather than a Class.
<b>Show stereotype icon for requirements</b>	Show or hide a code letter in the top right corner of Requirement ( <b>E</b> , for external), Change ( <b>C</b> ) and Issue ( <b>I</b> ) elements.
<b>Support for Composite Objects</b>	Enable you to <a href="#">drag child elements onto parent elements in a diagram</a> <sup>[529]</sup> , and automatically embed them (and drag embedded child elements out of parent elements, breaking the child-parent relationship).
<b>Auto-resize marks diagram 'dirty'</b>	Ensure that auto-resizing of elements (such as Classes) marks the current diagram as changed (asterisk on the diagram name tab), so it should be saved.

Option	Use to
<b>Highlight {abstract} elements</b>	Highlight abstract elements with a suitable tag <i>{abstract}</i> in the top right of the Class.
<b>Allow elongated Use Cases</b>	Stretch Use Cases or Use Case extension points with long names to enable space for the name. If you deselect the checkbox, Use Case re-sizing is proportional.
<b>Show status colors on diagrams</b>	Enable <a href="#">color coding</a> <sup>[653]</sup> for Requirements and similar elements.
<b>Copy inheritance links on duplicate</b>	Duplicate Inheritance and Realization connectors when an edit/copy is performed.
<b>Port and Part type visible by default</b>	Enable Port and Part types to be shown by default.
<b>Show buttons for selected Object on diagram</b>	Display the floating toolbar buttons to the left of the selected object. For example: 
<b>Edit Object on New</b>	Automatically show the element <b>Properties</b> dialog when a new element is added.
<b>Show «column» stereotype</b>	Hide or show the « <i>column</i> » stereotype used when data modeling.
<b>Extend Complexity</b>	Extend levels of complexity to five levels in the <b>Complexity</b> option in the <b>Properties</b> window. Otherwise only three levels are available.
<b>UML 1.5 Components</b>	Use UML 1.5 components (Enterprise Architect versions 4.0 and later support UML 2.x).
<b>Show State Compartment</b>	Show or hide the State Compartment divider under the state name.
<b>Show Duplicate Tags</b>	Enable duplicate tags to be shown.
<b>Group Operations by Stereotype</b>	Group an element's operations by their stereotype on the diagram.
<b>Group Attributes by Stereotype</b>	Group an element's attributes by their stereotype on the diagram.
<b>Sort Features Alphabetically</b>	Sort element features alphabetically. Features include Attributes, Operations, Tags, Constraints and Test Cases.
<b>Disable spelling</b>	Turn off automatic spell checking. Deselect to resume automatic spell checking.
<b>Advanced</b>	Set the <a href="#">visibility</a> <sup>[363]</sup> of certain elements in reports and in diagram packages.

### 3.8.4.1 Element Visibility

Some elements do not appear in packages and in RTF output by default. Click on the **Advanced** button on the [Objects](#) <sup>[362]</sup> page of the **Options** dialog to specify which elements should be visible.

See the topic on [customizing element visibility](#) <sup>[535]</sup> for more details.

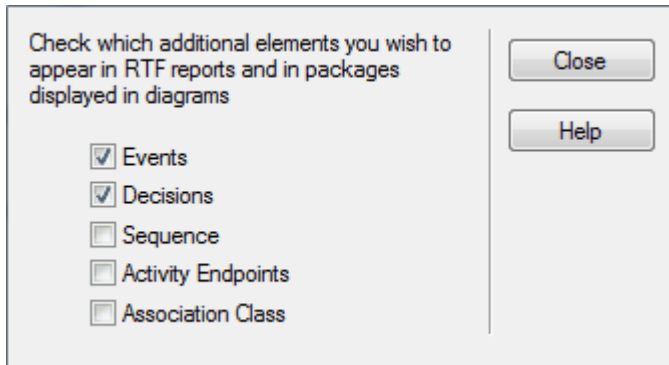

### 3.8.5 Links

The **Links** page of the **Options** dialog shown below provides options for the creation, behavior and notation for connectors.

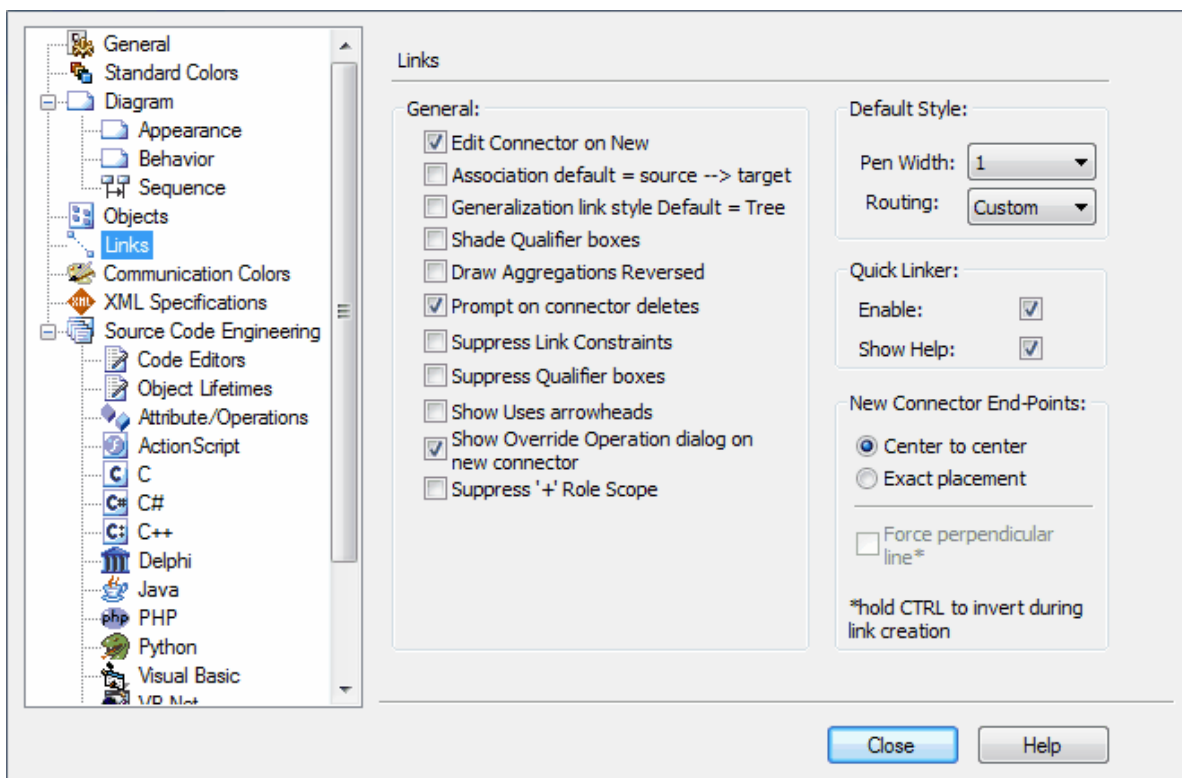

Option	Use to
<b>General</b>	
<b>Edit Connector on New</b>	Automatically show the connector <b>Properties</b> dialog when a new connector is added.
<b>Association default = source --&gt; target</b>	Set the direction of new Associations to source->target (that is, with an arrow head at the target).
<b>Generalization link style Default = Tree</b>	Show Generalizations as tree style hierarchies.
<b>Shade Qualifier boxes</b>	Lightly shade all Qualifier boxes.



Option	Use to
<b>Draw Aggregations Reversed</b>	<p>Draw Aggregate and Composite connectors from target element to source element. When deselected (the default), these connectors are drawn from source to target.</p> <p><b>Note:</b></p> <p>All tools have the parent as the target and the child as the source of the connector, that is a requirement of UML; only the direction in which you drag the mouse to draw the connector is changed.</p>
<b>Prompt on connector deletes</b>	<p>Display a prompt before <a href="#">deleting connectors</a><sup>[619]</sup>, offering the choice of hiding the connector on the diagram or deleting it completely.</p> <p>If you deselect this option, the delete operation defaults to the last setting on the dialog.</p>
<b>Suppress Link Constraints</b>	Suppress connector constraints in diagrams.
<b>Suppress Qualifier boxes</b>	Suppress boxes when displaying qualifiers.
<b>Show Uses arrowheads</b>	Show an arrowhead on Actor->Use Case Associations.
<b>Show Override Operation dialog on new connector</b>	Show the <b>Override Operation</b> dialog automatically when adding generalizations and realizations between Classes and Interfaces, if the target element has features that can be overridden.
<b>Suppress ' + ' Role Scope</b>	Ensure that the role and scope are not displayed on the diagram.
<b>Default Style</b>	
<b>Pen Width</b>	Set the default connector width.
<b>Routing</b>	Set the default connector style for new connectors.
<b>Quick Linker</b>	
<b>Enable</b>	Enable the <a href="#">Quick Linker</a> <sup>[474]</sup> .
<b>Show Help</b>	Add a 'help' menu option to the end of the Quick Linker menu.
<b>New Connector End-Points</b>	
<b>Center to center</b>	Change the position of the dashed guide line for new connectors.
<b>Exact placement</b>	
<b>Force perpendicular line</b>	

### 3.8.6 Communication Message Colors

The **Communication Message Coloring** page in the **Options** dialog enables you to configure the colors used in Communication diagrams.

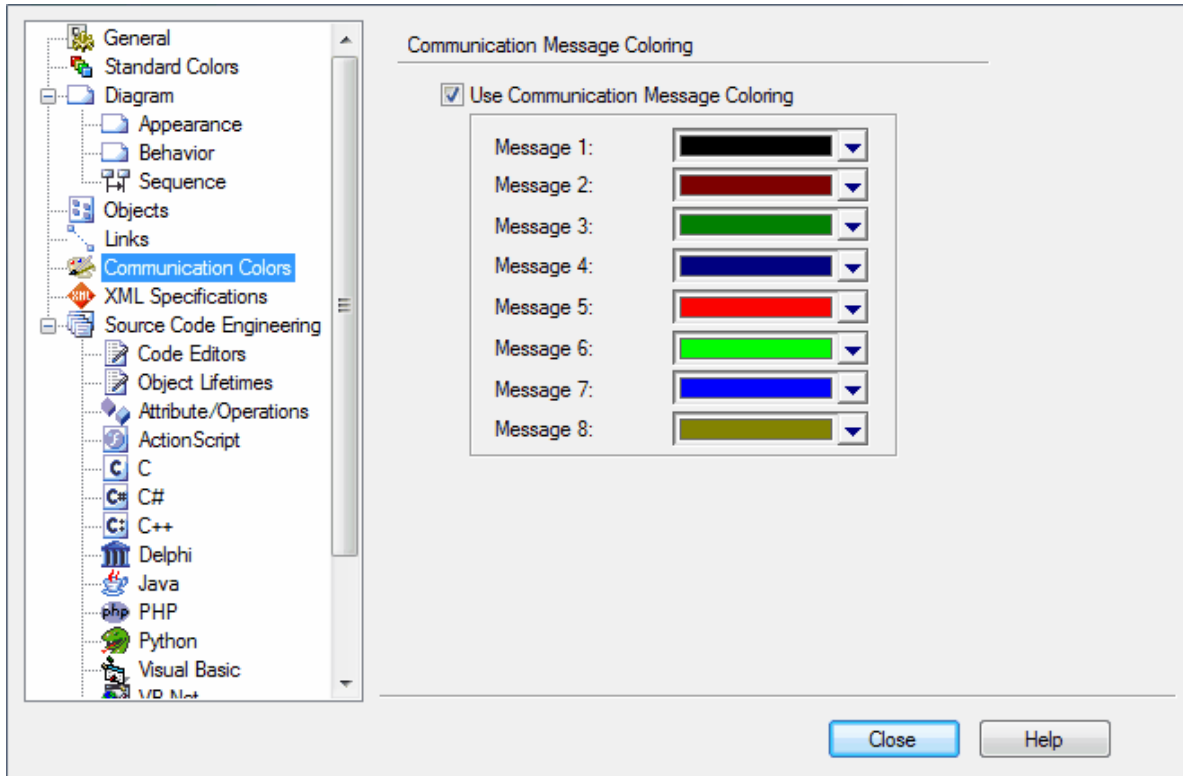

Select the **Use Communication Message Coloring** checkbox to turn on colored messages. When you enable this option, Communication messages appear in different colors depending on the sequence group they belong to on a diagram; for example, 1.n are black, 2.n are red, 3.n are green.

Click on the down arrow in each color field, and click on the appropriate color for the message group. Set the color sequence as required; the pattern repeats after 8 sequence groups.

### 3.8.7 XML Specifications

The **XML Specifications** page of the **Options** dialog enables you to configure various settings for working with XML.

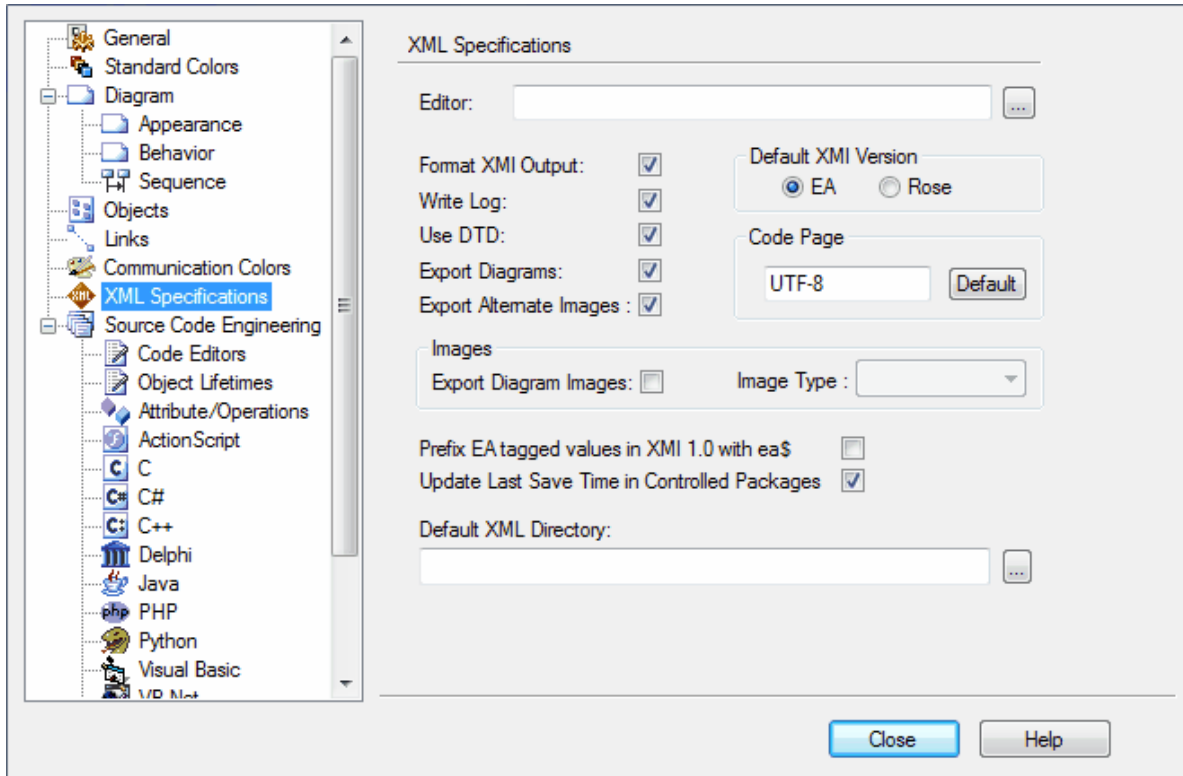

Option	Use to
<b>Editor</b>	Set the default editor for any XML documents you open within Enterprise Architect.
<b>Format XML Output</b>	Set whether or not formatting is applied to your XML output.
<b>Write Log</b>	Set whether or not to write to a log file when you import or export XML.
<b>Use DTD</b>	Set whether or not to use a Data Type Definition.
<b>Export Diagrams</b>	Set whether or not to export diagrams when you export XML.
<b>Export Alternate Images</b>	<p>Set whether or not to export the <a href="#">alternative images</a> <sup>[447]</sup> used in the model when you export to XML.</p> <p><b>Note:</b></p> <p>If this option is set, and you have packages in your model under version control, then any alternative images used in those packages are also exported to the version control repository when you <a href="#">check in</a> <sup>[261]</sup> the packages.</p> <p>In this case, you would <b>only</b> select the checkbox if the alternative images are subject to <b>frequent change</b>. Otherwise, do not select this option and instead use <a href="#">Export/Import Reference Data</a> <sup>[223]</sup> to manage alternative images.</p>
<b>Default XMI Version</b>	Set the XMI version to use: Enterprise Architect or Rose.
<b>Code Page</b>	Set the Code Page to use; setting a NULL encoding string results in the encoding tag being entirely omitted from the XML output. Click on the <b>Default</b> button to restore the setting to the default Code Page.

Option	Use to
<b>Export Diagram Images</b>	Set whether or not to export diagrams as images when you export XML.
<b>Image Type</b>	Define the format of the image to export to if <b>Export Diagram Images</b> is selected.
<b>Prefix EA Tagged Values in XMI 1.0 with ea\$</b>	Set whether or not to prefix any Enterprise Architect Tagged Values within any XMI 1.0 you create, with <b>ea\$</b> .
<b>Update Last Save Time in Controlled Packages</b>	Set whether to update the timestamp of the last time controlled packages were saved.
<b>Default XML Directory</b>	Define the default XML directory to use when importing and exporting XML.

**Part**



## 4 Modeling Fundamentals



Modeling can be described as graphically representing a business process or software system. The resulting model can be used to emphasize a certain aspect of the system being represented, and to record, document and communicate its detail. A study of such a model can enable insight or understanding of the system.

### The Enterprise Architect Modeling Platform

Enterprise Architect's modeling platform is based on the Unified Modeling Language (UML), a standard that defines rules and notations for specifying business and software systems.

For information on UML, see the [Standard UML Models](#)<sup>[672]</sup> topic.

For examples of the UML models that Enterprise Architect can help you build, see the [Model Templates](#)<sup>[373]</sup> topic.

### Building a Model

Using Enterprise Architect, you can quickly build a model using a hierarchy of *packages* to represent the structure and organization of the model. Each package can contain:

- Other packages
- *Diagrams* that represent various aspects of the equipment, environment and business processes of the system
- *Elements* that represent the objects and actions within the system or process, arranged in an organization defined by relationships represented by *UML connectors*.

The [Quick Start Tutorial](#)<sup>[28]</sup> topic briefly shows you how to create a diagram within a package, containing elements and connectors. Sparx Systems also provide a [demonstration of quickly developing a Use Case model](#).

For specific details of configuring and combining the components of a model, see:

- [Packages](#)<sup>[387]</sup>
- [Diagrams](#)<sup>[391]</sup>
- [Elements](#)<sup>[478]</sup>
- [Connectors](#)<sup>[606]</sup>.

### Relationship Matrix

The Relationship Matrix enables you to display and manage the relationships between the elements within selected packages. You can refine the display to show specific types of relationship between specific types of element. The [Relationship Matrix](#)<sup>[1261]</sup> is an effective and convenient method of visualizing relationships quickly and definitively.

## 4.1 Modeling

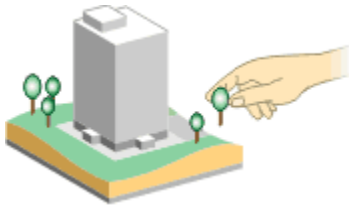

Enterprise Architect is a comprehensive UML analysis and design tool. It provides a library of UML data structures that you can use and extend to develop your models.

For an explanation of how Enterprise Architect interprets the UML standards and specifications, see the [Standard UML Models](#)<sup>[672]</sup> topic.

- You **create your projects and models** using the [Start Page](#)<sup>[50]</sup> or [File Menu](#)<sup>[56]</sup>, which provide [templates](#)<sup>[373]</sup> on which to base your models
- You initially create your **packages and diagrams** using the [Toolbars](#)<sup>[79]</sup> and [Menus](#)<sup>[54]</sup>, and the **elements and connectors** using the Diagram [Toolbox](#)<sup>[399]</sup>
- You can also create new structures through the [Project Browser](#)<sup>[1209]</sup>, and **re-use existing structures** using the [Project Browser](#), [Model Views](#)<sup>[1222]</sup>, [Element List](#)<sup>[1255]</sup> and [Model Search](#)<sup>[1231]</sup>.

Building models requires the use of various UML data structures and Enterprise Architect tools, as above, to graphically represent a business process or software system. The resulting model can be used to emphasize a certain aspect of the system being represented and to record and communicate its detail.

A further extremely useful tool is the:

- **Relationship Matrix**, which enables you to visualize and amend the relationships and hence organization of structures within the model.

Enterprise Architect also provides particular support for:

- **Requirements Management** and
- **Modeling the business process**, an essential part of any software development process.

You can extend the scope of your models by using:

- **UML Stereotypes, Profiles and Patterns**, and
- **MDG Technologies**.

For more information, see the [Modeling Fundamentals](#)<sup>[370]</sup>, [Build Your Own Modeling Language](#)<sup>[1092]</sup> and [Requirements](#)<sup>[917]</sup> topics.

## 4.2 Models



In Enterprise Architect a *model* is a special type of package, being the top level entry point to an Enterprise Architect project file.

You can develop a project with one model, or with several. Each model is a root node of a hierarchy of Model Packages and Views and, below them, packages. A model contains the diagrams, elements, relationships and associated metadata that define the structure and function of a system or process. These components are organized through the package hierarchy, which helps to group and manage related components. By iterating through all models, you can access all the elements within the project.

You can create the model or models when you first create the project, or you can add and develop new models later. You can also delete a model, but be aware that everything contained in the model is deleted as well.

### 4.2.1 Model Wizard

The Model Wizard is available on creating a new project. Once you have created a project, you can also access the Model Wizard from the [Project Browser](#).

Right-click on a root node, View or other top-level package and select the **Add a New Model using Wizard** context menu option. The [Select Model\(s\)](#) dialog displays.

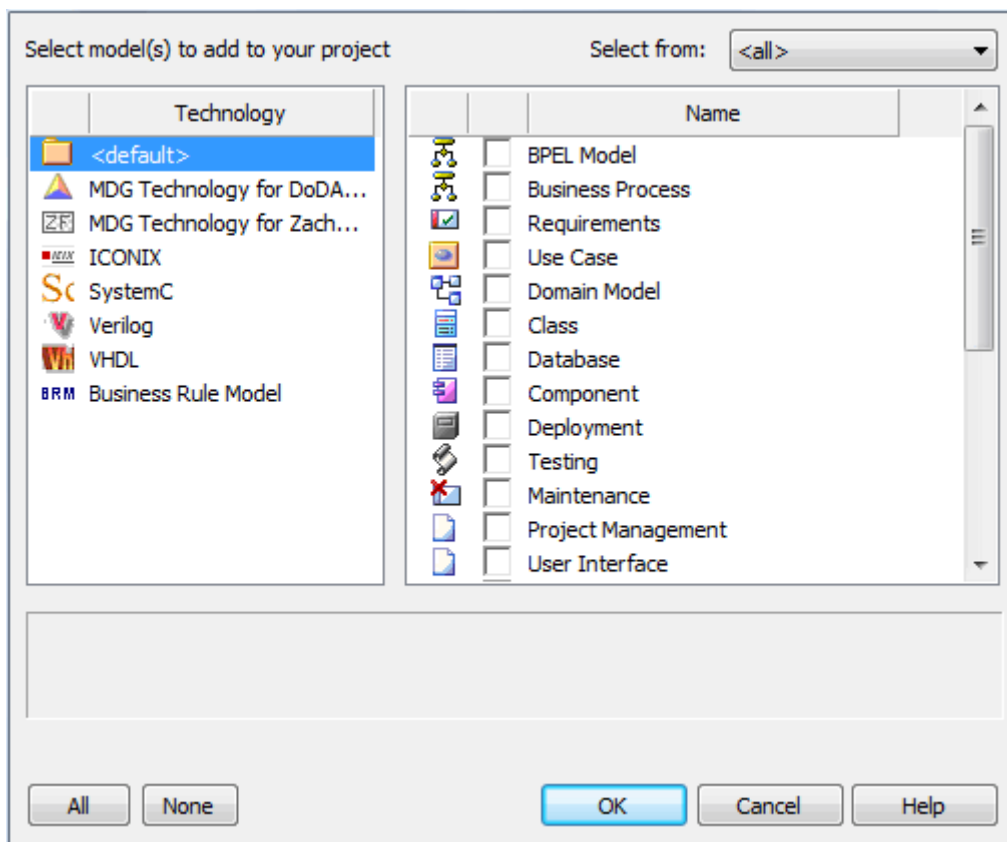



Option	Use to
Select From	Select the category containing the types of Model Package to create.
Technology	(If you have advanced Add-Ins and MDG Technologies, this panel lists them). Select the appropriate technology to list the associated templates in the Name panel. To list the standard Enterprise Architect <a href="#">model templates</a> <sup>[373]</sup> , select <default>.
All	Select all of the models.
None	Clear all models selected.
OK	Create the Model Packages for your project.
Cancel	Abort the creation of model packages.
Help	Display this Help topic.

If you are a Technology Developer, you can also create and distribute [custom templates](#)<sup>[1146]</sup> as part of your own [MDG Technology](#)<sup>[1118]</sup>. The name of your technology displays in the **Technology** panel and, when you select the technology, the model template names display in the **Name** panel. If you have defined a filter in your Model Technology File, you can select that from the **Select from:** drop-down list.

### 4.2.2 Model Templates

The model templates contained in Enterprise Architect are designed to assist in the creation of projects and models for both new and experienced users.

Each template provides a framework on which you can create a model appropriate to your purpose, using the [Model Wizard](#)<sup>[372]</sup>.

#### Template Format

All the model templates provided with Enterprise Architect follow the format described below.

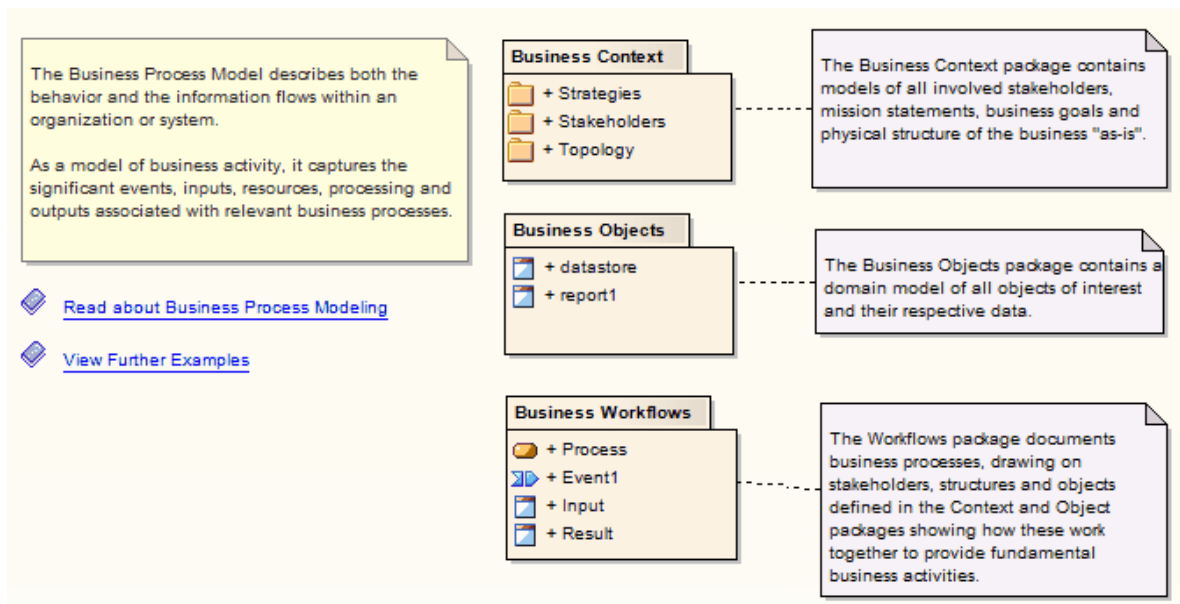

#### Note

The note introduces you to the model template and outlines its purpose.

#### Help Links

Help hyperlinks provide further information on how to use the model. Depending on the model template, links to examples and other useful information are also provided.

#### Template

The Template section in the model template provides a framework for creating your own model.

The topics listed below provide an introduction to the terminology and icons used in the model templates, and give you a quick guide to the UML concepts important to the templates and how they are applied in Enterprise Architect.

- [Business Process Model Template](#)<sup>[374]</sup>
- [Requirements Model Template](#)<sup>[374]</sup>
- [Use Case Model Template](#)<sup>[375]</sup>
- [Domain Model Template](#)<sup>[376]</sup>
- [Class Model Template](#)<sup>[376]</sup>
- [Database Model Template](#)<sup>[377]</sup>
- [Component Model Template](#)<sup>[378]</sup>
- [Deployment Model Template](#)<sup>[378]</sup>
- [Testing Model Template](#)<sup>[380]</sup>.

If you are a Technology Developer, you can also create and distribute [custom templates](#)<sup>[1146]</sup> as part of your own MDG Technology.

#### 4.2.2.1 Business Process Model Template

The *Business Process model* describes both the behavior and the information flows within an organization or system. As a model of business activity, it captures the significant events, inputs, resources, processing and outputs associated with relevant business processes.

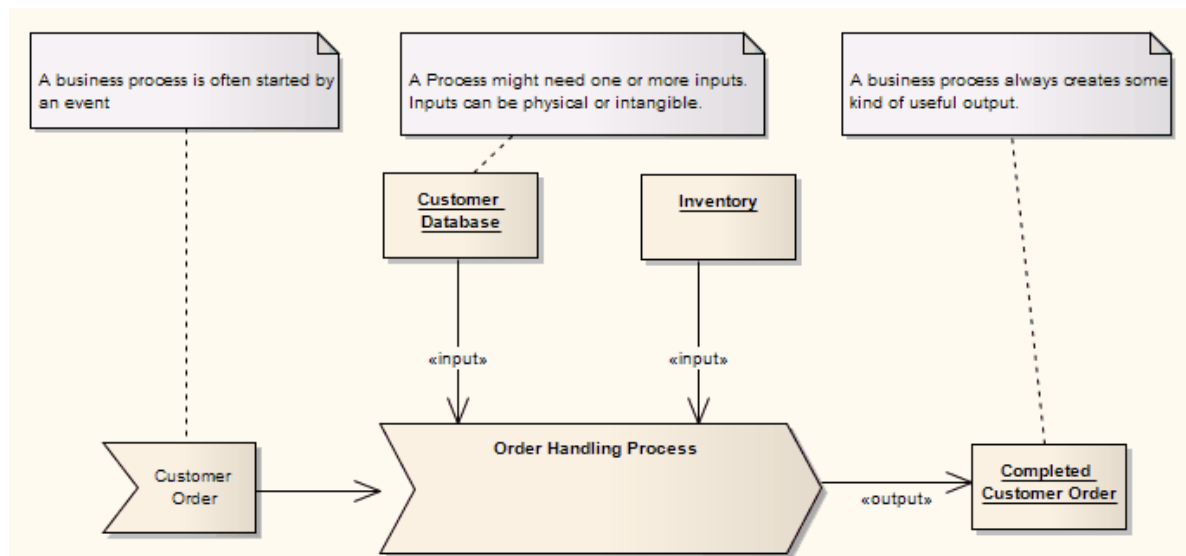

##### Online Resources

- [The Business Process Model](#)

##### See Also

- [Business Models](#)<sup>[930]</sup>
- [Analysis Diagram](#)<sup>[733]</sup>
- [Business Modeling/Interaction](#)<sup>[739]</sup> Diagrams

#### 4.2.2.2 Requirements Model Template

The *Requirements model* is a structured catalogue of end-user requirements and the relationships between them.

The [Requirements Management](#)<sup>[917]</sup> facilities built into Enterprise Architect can be used to define Requirement elements, connect Requirements to other model elements, connect Requirements into a hierarchy and report on Requirements.

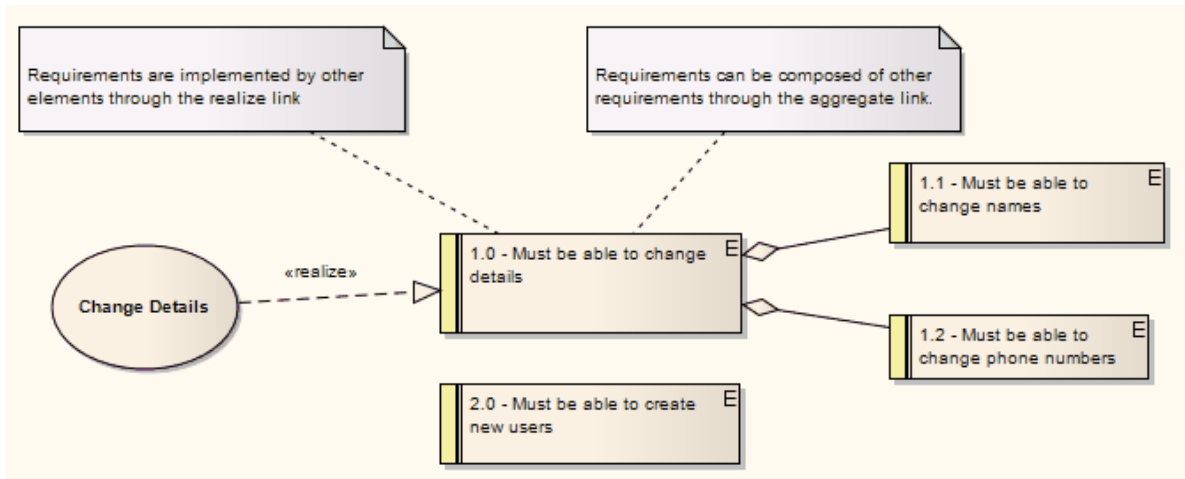

**Online Resources**

- [Requirements Management in Enterprise Architect](#)

**See Also**

- [Packages](#) <sup>[387]</sup>

**4.2.2.3 Use Case Model Template**

The *Use Case model* describes a system's functionality in terms of Use Cases.

Each Use Case represents a single repeatable interaction that a user or 'actor' experiences when using the system, emphasizing the user's perspective of the system and interactions. See the [Use Case](#) <sup>[806]</sup> and [Use Case Diagram](#) <sup>[676]</sup> topics for more information.

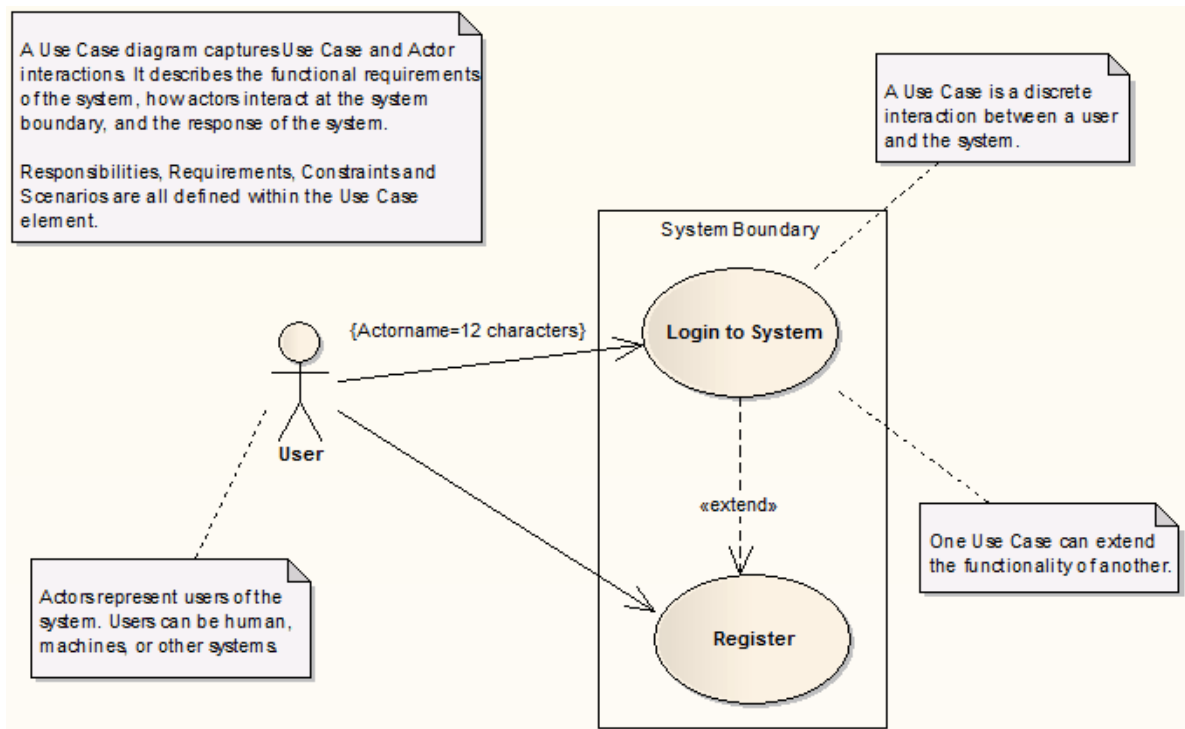

**Online Resources**

- [The Use Case Model](#)

#### 4.2.2.4 Domain Model Template

A *Domain model* is a high-level conceptual model, defining physical and abstract objects in an area of interest to the Project.

The Domain model can be used to document relationships between and responsibilities of conceptual classes (that is, classes that represent the concept of a group of things rather than Classes that define a programming object). It is also useful for defining the terms of a domain.

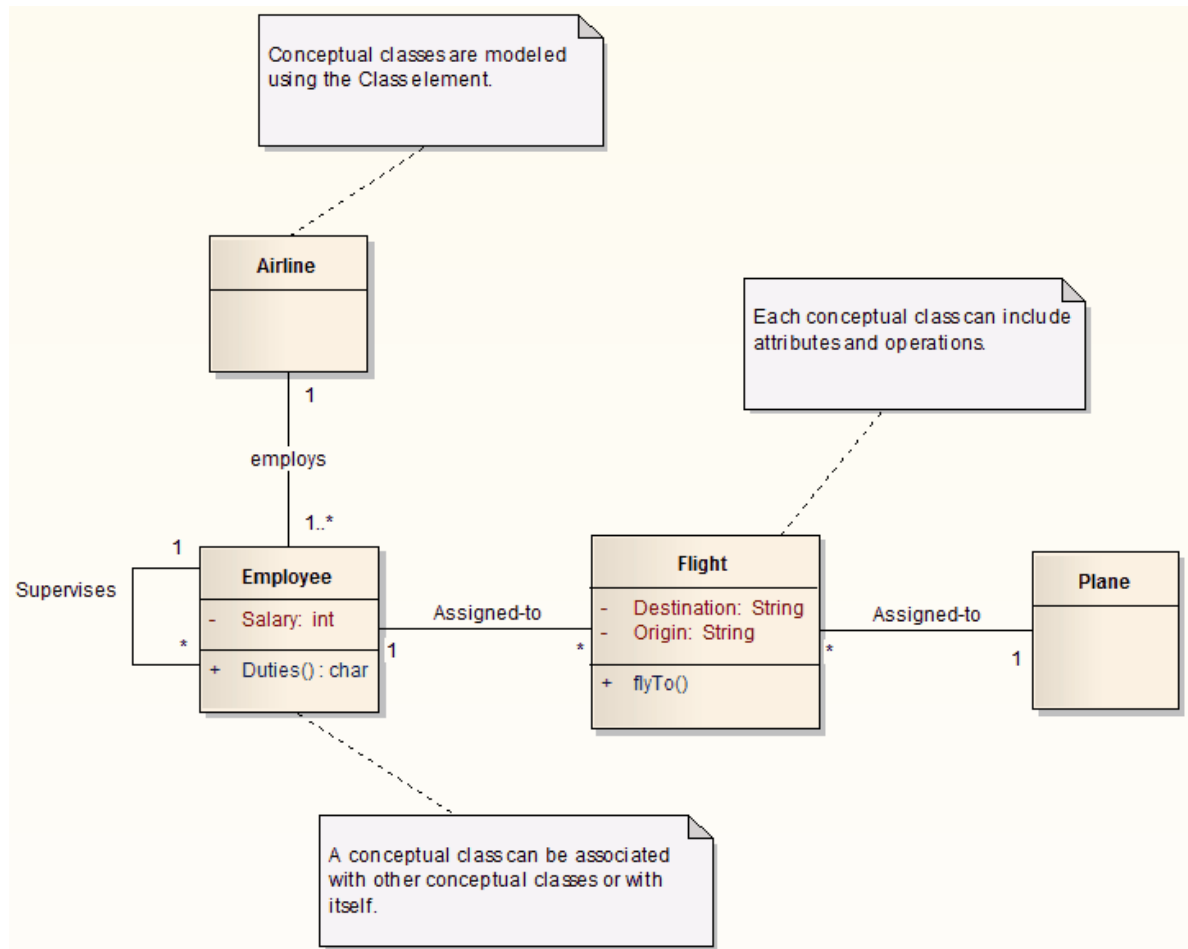

A Domain model shows:

- The physical and organizational units of the domain; for example, *Employee* and *Flight*
- The relationships between these units; for example, *Employee* is *assigned to* *Flight*
- The [multiplicity](#)<sup>[630]</sup> of those relationships; for example, *one* employee can be assigned to *no* flights, *one* flight or *many* flights (represented by the 1 and the \* at the ends of that relationship).

#### 4.2.2.5 Class Model Template

The *Class model* is a rigorous, logical model of the software system under construction.

[Classes](#)<sup>[817]</sup> generally have a direct relationship to source code or other software artifacts that can be grouped together into executable components.

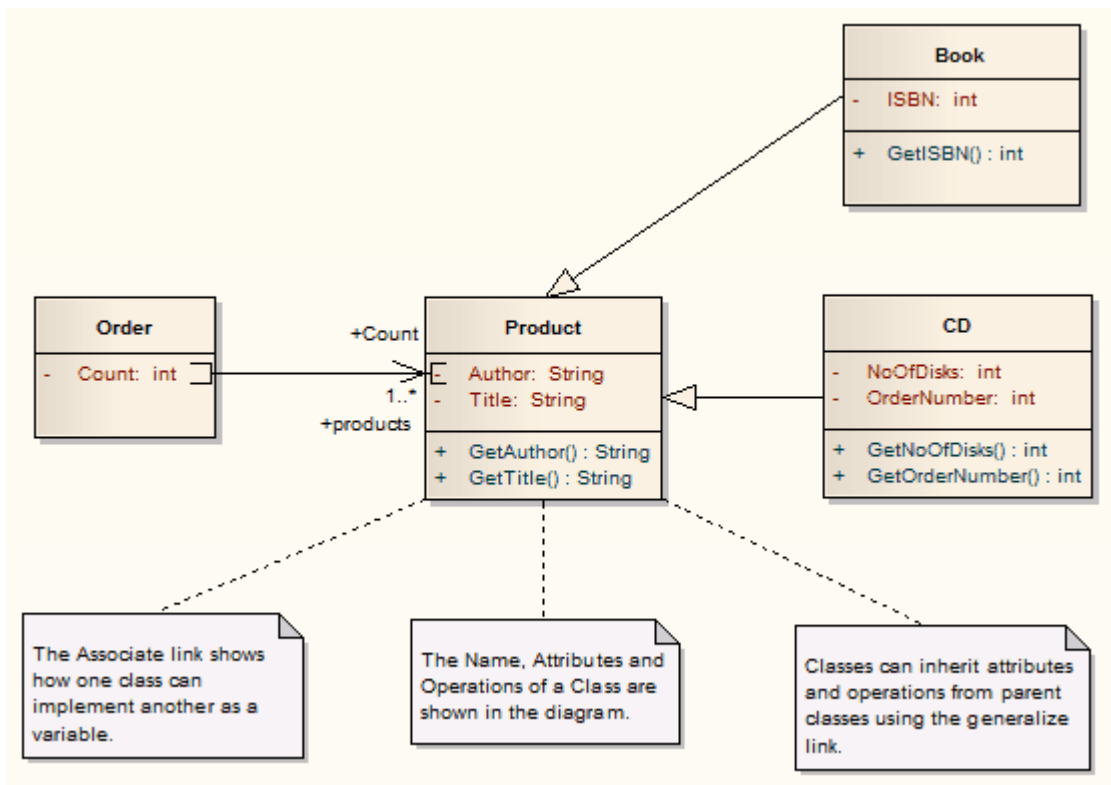

**Online Resources**

- [The Logical Model](#)

**See Also**

- [Class Diagram](#)

**4.2.2.6 Database Model Template**

The *Database model* describes the data that must be stored and retrieved as part of the overall system design. Typically this means relational database models that describe the tables and data in detail and enable generation of DDL scripts to create and set up databases.

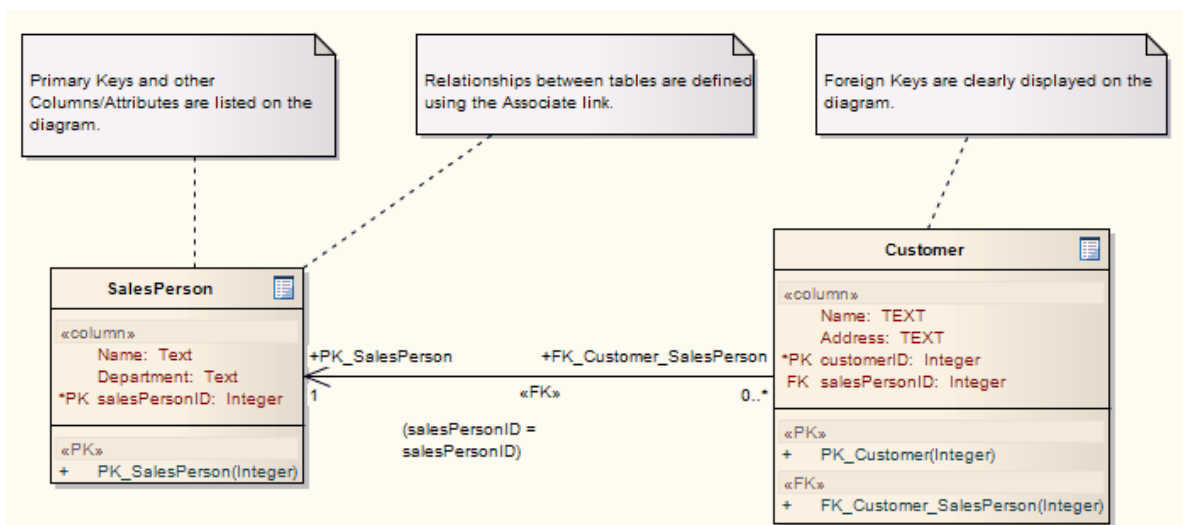

### Online Resources

- [UML Database Modeling](#)

### See Also

- [Data Models](#) <sup>[101]</sup>

#### 4.2.2.7 Component Model Template

The *Component model* defines how Classes, Artifacts and other low level elements are collected into high level [components](#) <sup>[816]</sup>, and describes the interfaces and connections between them.

Components are compiled software artifacts that work together to provide the required behavior within the operating constraints defined in the [Requirements model](#) <sup>[374]</sup>.

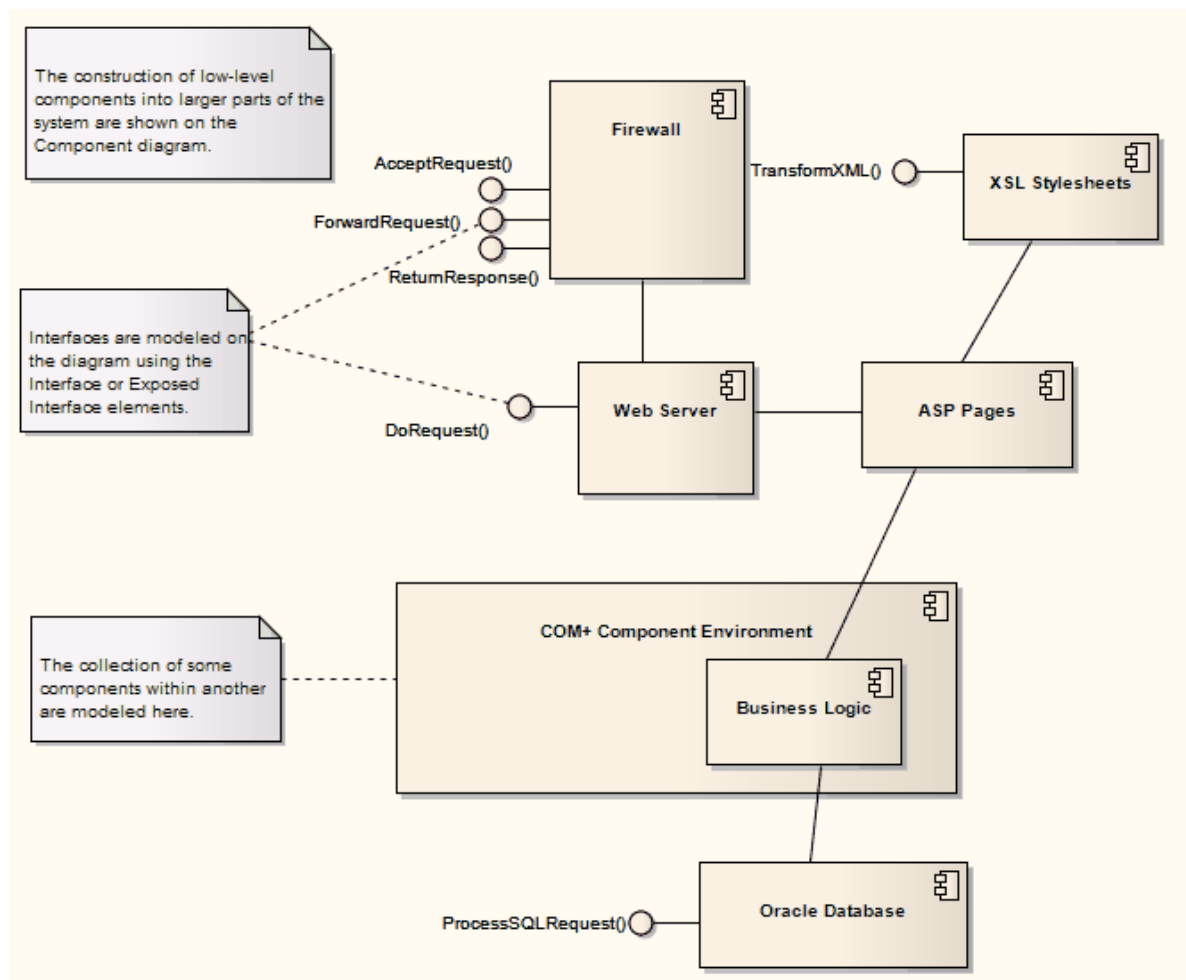

### Online Resources

- [The Component Model](#)

### See Also

- [Component Diagram](#) <sup>[730]</sup>

#### 4.2.2.8 Deployment Model Template

The *Deployment model* describes how and where a system is to be deployed.

Physical machines and processors are represented by [Nodes](#) <sup>[822]</sup>, and the internal construction can be depicted by embedding Nodes or [Artifacts](#) <sup>[810]</sup>. As Artifacts are allocated to Nodes to model the system's [deployment and roll out](#) <sup>[45]</sup>, the allocation is guided by the use of deployment specifications.

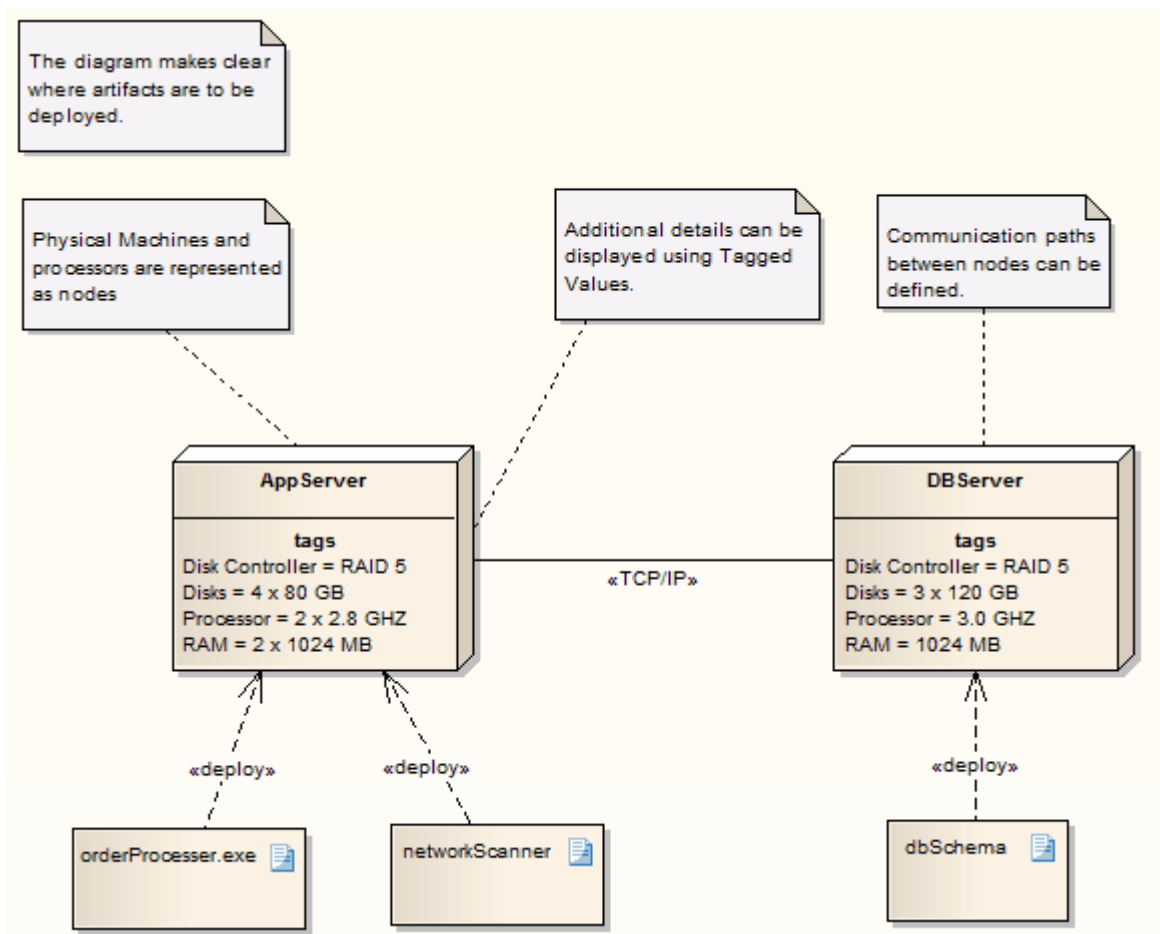

### Online Resources

- [The Physical Model](#)

### See Also

- [Deployment Diagram](#)<sup>[72]</sup>
- [Compartments - Tagged Values](#)<sup>[52]</sup>

### 4.2.2.9 Testing Model Template

The *Test model* describes and maintains a catalogue of tests, test plans and results that are executed against the current model.

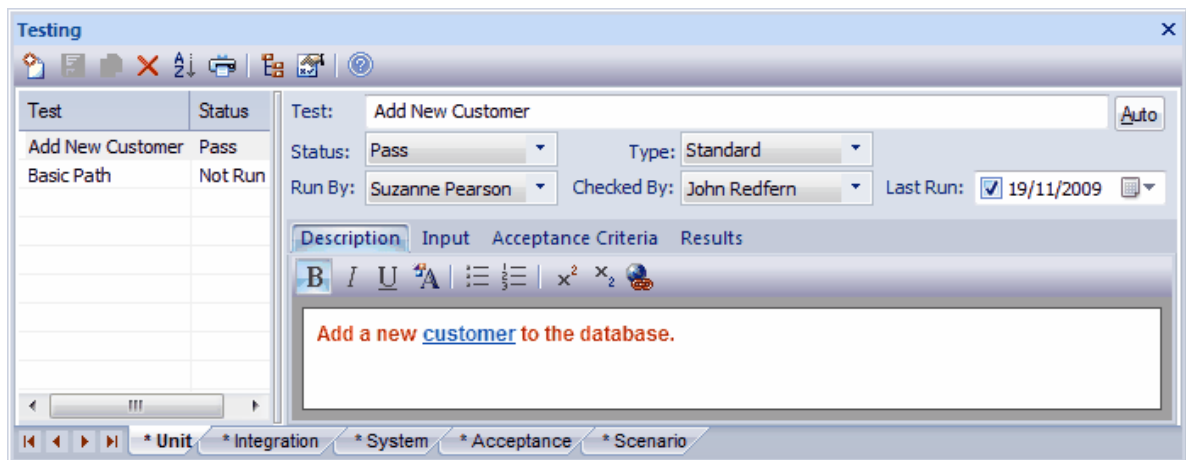
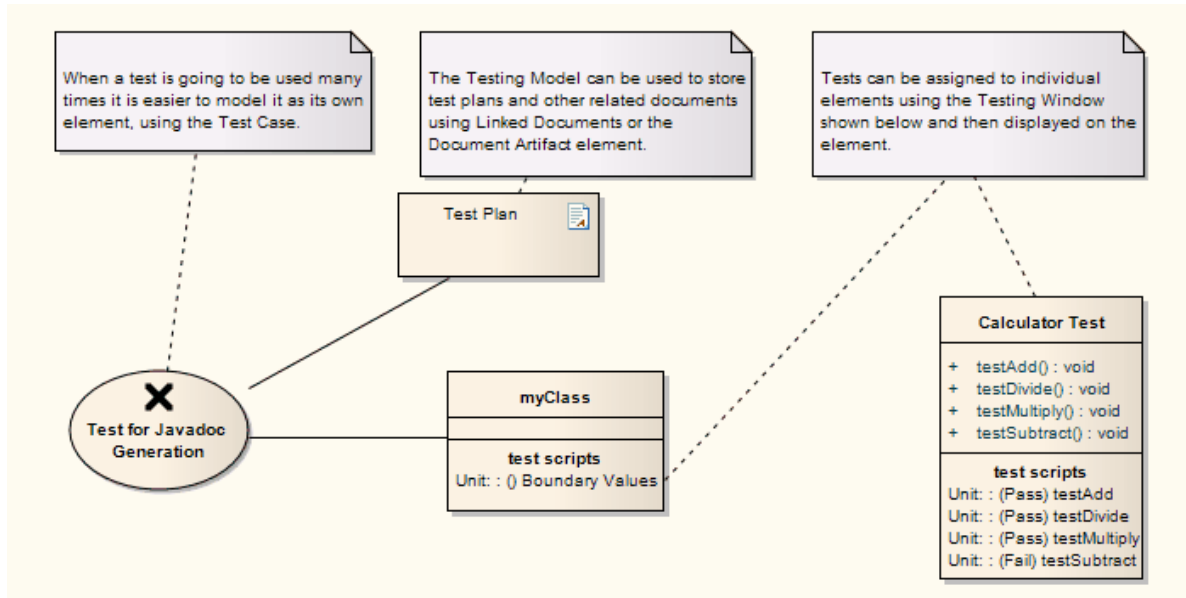

#### Online Resources

- [Testing Support in Enterprise Architect](#)

#### See Also

- [Testing](#) <sup>1536</sup>
- [Test Case](#) <sup>848</sup> element
- [Show Test Script Compartments](#) <sup>1549</sup>



### 4.2.2.10 Maintenance Model Template

The *Maintenance model* enables visual representation of issues arising during and after [development](#)<sup>[1558]</sup> of a software product. The model can be enhanced with the integration of change elements and testing.

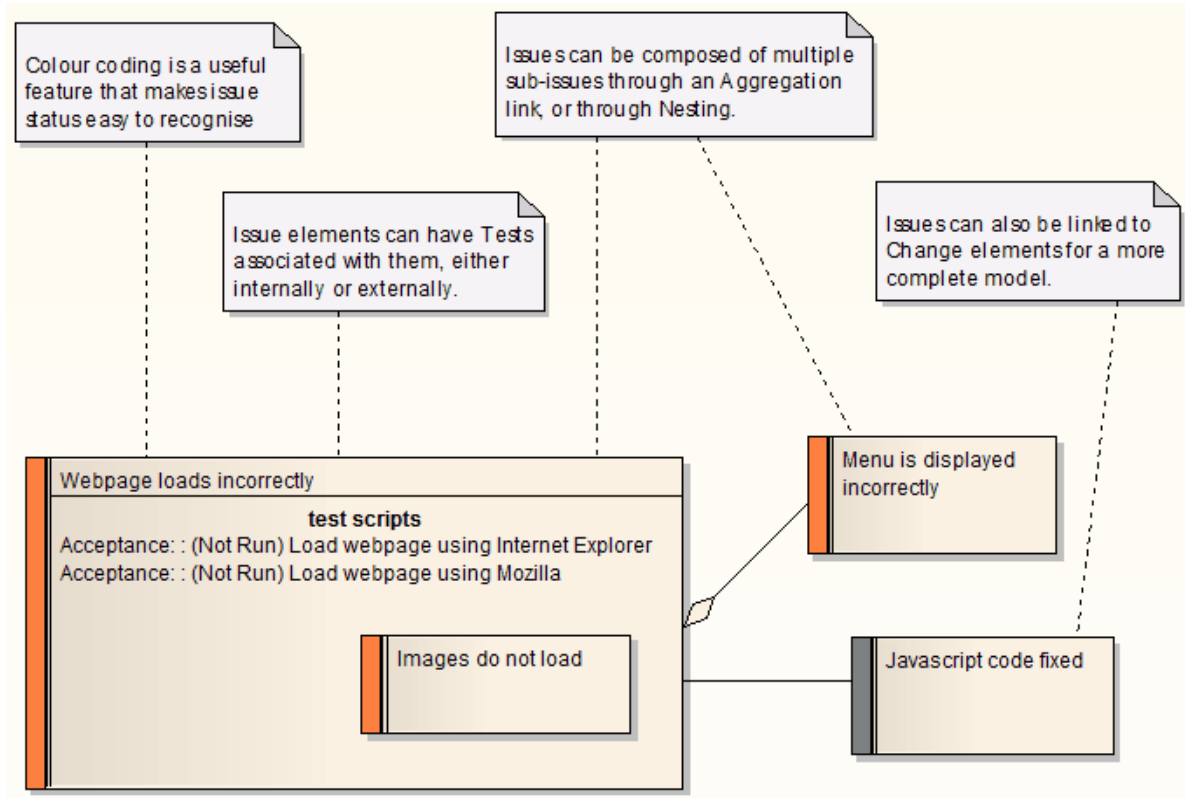

**See Also**

- [Color Code External Requirements](#)<sup>[920]</sup>

### 4.2.2.11 Project Model Template

The *Project model* details the overall project plan, phases, milestones and resourcing requirements for the current project.

Project Managers can use Enterprise Architect to assign resources to elements, measure risk and effort and to estimate project size. Change control and maintenance are also supported.



**Online Resources**

- [Project Manager](#)

**See Also**

- [Project Management](#)<sup>[312]</sup>

## 4.3 Views

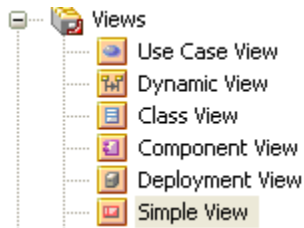

The top level packages in a model (below the project root nodes) can be created as *Views*.

Views are used simply to subdivide the model into partitions such as Business Process, Logical View or Dynamic View. Unlike Model Packages, they do not have automatically-generated components and can be created only under a root node. They are a good way to extend the model depending on specific requirements and modeling techniques.

There are six main types of View, each with their own package icon:

- Use Case View - containing, for example, [Use Case diagrams](#)<sup>[676]</sup>, [Analysis diagrams](#)<sup>[733]</sup>
- Dynamic View - containing, for example, [Activity diagrams](#)<sup>[674]</sup>, [Communication diagrams](#)<sup>[715]</sup>, [Sequence diagrams](#)<sup>[706]</sup>, [State Machine diagrams](#)<sup>[676]</sup>
- Class View - containing, for example, [Class diagrams](#)<sup>[721]</sup>, [Code Engineering](#)<sup>[1281]</sup>, [Data Models](#)<sup>[739]</sup>
- Component View - containing, for example, [Component diagrams](#)<sup>[730]</sup>
- Deployment View - containing, for example, [Deployment diagrams](#)<sup>[727]</sup>
- Simple View - to customize your own type of view.

You can use the first five categories, or devise your own based on the Simple View. You can [create](#)<sup>[383]</sup> Views, [rename](#)<sup>[384]</sup> them, move them into a different order, or [delete](#)<sup>[385]</sup> them. Do this by right-clicking the mouse on the selected View to open the context menu, and choose the appropriate option.

### 4.3.1 Add Views

The example below shows a customized view called *Java Code View*, which has been appended to the end of the Views list.

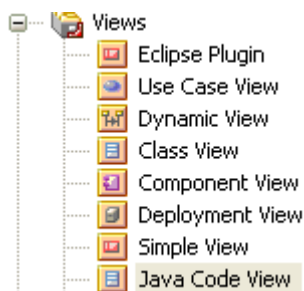

### Create a View

To create a View, follow the steps below:

1. Right-click on the model root node in the **Project Browser**. The context menu displays.
2. Select the **New View** menu option. The **Create New View** dialog displays.

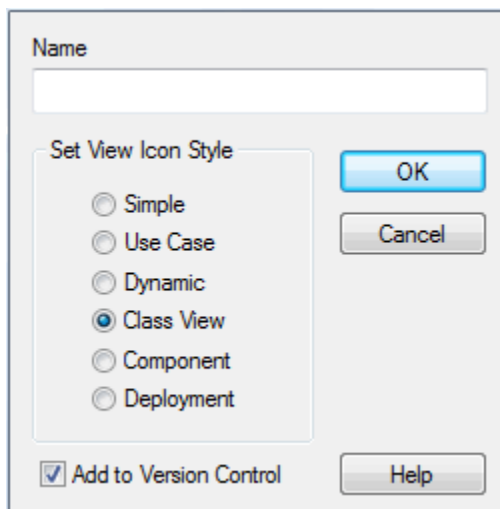

3. In the **Name** field, type the name of the View.
4. In the **Set View Icon Style** panel, click on the radio button for the required View icon.
5. If the model root node is under [version control](#)<sup>[228]</sup>, the **Add to Version Control** checkbox displays, defaulted to selected. If you do not want the new View to also be under version control, deselect the checkbox.
6. Click on the **OK** button.

### 4.3.2 Rename Views

If required, you can rename a view.

#### Procedure

To rename a view, follow the steps below:

1. Right-click on the View in the **Project Browser**. The context menu displays.
2. Select the **Properties** menu option. The **Package Properties** dialog displays.

The screenshot shows a dialog box with the following fields and controls:

- General** (selected tab): Requirements, Constraints, Links, Scenarios, Files, Tagged Values
- Name:** Locking
- Stereotype:** [Dropdown menu]
- Author:** Suzanne Pearson
- Scope:** Public
- Alias:** [Text field]
- Phase:** 1.0
- Version:** [Text field]
- Status:** Proposed
- Complexity:** Easy
- Language:** Java
- Keywords:** [Text field]
- Abstract:**
- Notes:** [Rich text editor with toolbar: Bold, Italic, Underline, Bulleted List, Numbered List, Indent, Outdent, Undo, Redo, Help]
- Buttons:** OK, Cancel, Apply, Help

3. In the **Name** field, type the new name and click on the **OK** button.

### 4.3.3 Delete Views

If necessary, you can delete a view.

**Warning:**

If you delete a view, all its contents are deleted at the same time. It CANNOT be restored.

#### Procedure

To delete a view, follow the steps below:

1. In the **Project Browser**, right-click on the view to delete. The context menu displays.
2. Select the **Delete <viewname>** option. The following warning displays:

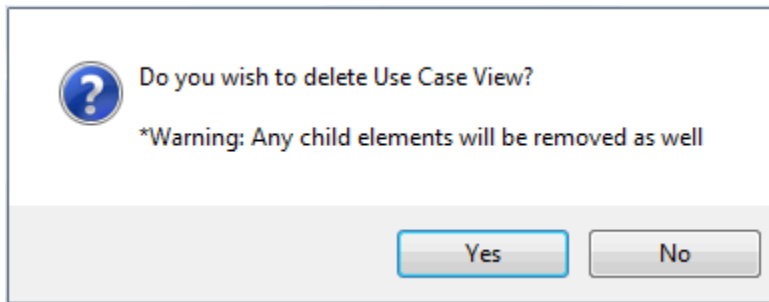

3. To delete the view and its contents, click on the **Yes** button. To cancel the deletion, click on the **No** button.

## 4.4 Packages



A *package* is a container of model elements. It is represented in the **Project Browser** by the 'folder' icon familiar to Windows users.

This topic explores the tasks you can perform with packages, including:

- [Open a package](#) <sup>[438]</sup>
- [Add a package](#) <sup>[387]</sup>
- [Rename a package](#) <sup>[388]</sup>
- [Copy a package](#) <sup>[388]</sup>
- [Drag a package onto a diagram](#) <sup>[389]</sup>
- [Show or hide a package](#) <sup>[389]</sup>
- [Delete a package](#) <sup>[390]</sup>

### Note:

In the Corporate, Business and Software Engineering, Systems Engineering and Ultimate editions of Enterprise Architect, if security is enabled you must have [Update Element](#) <sup>[198]</sup> permission to update or delete a package.

### 4.4.1 Open Package in the Project Browser

To open a package from the **Project Browser**, follow the steps below:

1. Double-click on a package; the contents display in the **Project Browser**.
2. Click on the + and - symbols next to the folder icon to open or close the package respectively.

### Tip:

Package contents are arranged alphabetically and elements can be dragged from one package to another using the mouse.

### 4.4.2 Add a Package

To create a new package:

1. In the **Project Browser**, select the package or view under which to add a new package.
2. Right-click on the folder icon within the **Project Browser**. The context menu displays.
3. Select the **Add | Add Package** menu option. The **New Model Package** dialog displays.

 A screenshot of the 'New Model Package' dialog box. It features a 'Name:' label followed by a text input field. Below the input field are two checkboxes: 'Automatically add new diagram' (checked) and 'Add to Version Control' (unchecked). At the bottom of the dialog are three buttons: 'OK', 'Cancel', and 'Help'.

4. In the **Package Name** field type the name of the new package.
5. To immediately create a diagram for the package, leave the **Automatically add new diagram** checkbox selected. To avoid creating a diagram, deselect the checkbox.

6. If you are adding a package to a parent package that is under [version control](#)<sup>[228]</sup>, the **Add to Version Control** option displays, with the checkbox selected. Deselect the checkbox to exclude the new package from version control, otherwise leave it selected.
7. Click on the **OK** button. The new package is inserted into the tree at the current location and, if you left the **Automatically add new diagram** checkbox selected, the [New Diagram dialog](#)<sup>[422]</sup> displays.
8. If you have selected to put the package under version control, the **Package Control Options** dialog displays. [Complete this dialog](#)<sup>[295]</sup> as required.

**Tip:**

You can also add a new package element by dragging the Package icon from the **Toolbox** into a diagram. In this case the package is created under the diagram's owning package, and is created with a default diagram of the same type as that in which the package is created.

**Note:**

In a multi-user environment, other users do not see the change until they [reload their project](#)<sup>[267]</sup>.

### 4.4.3 Rename a Package

To rename a package, follow the steps below:

1. Select the package to rename in the **Project Browser**.
2. Right-click to display the context menu.
3. Click on the **Package Properties** option.
4. In the **Name** field, type the new name.
5. Click on the **OK** button.

Alternatively, highlight the package to rename, and press **[F2]**.

**Note:**

In a multi-user environment, other users do not see the change until they [reload their project](#)<sup>[267]</sup>.

### 4.4.4 Copy a Package

Enterprise Architect enables you to quickly duplicate a complete package, including its child packages, elements and diagrams.

You can insert the copy of a package:

- Under the same parent
- Under one or more other packages in the same model or project, or
- Under one or more other packages in any other model or project.

This procedure is effectively the same as exporting and importing the [package XMI file](#)<sup>[309]</sup>, with the **Strip GUIDs** checkbox selected. You would tend to use this procedure for copying sections of a model within the project rather than reproducing an entire model or project, although copying these larger structures is equally feasible.

**Notes:**

- A copy of a package does not have the external cross references of the source package; that is, the following connectors are discarded:
  - Connectors coming *from* packages and elements outside the package being copied, *into* the package being copied
  - Connectors going *to* packages and elements outside the package being copied, *from* the package being copied.
- You cannot paste a package into a parent package that is [locked](#)<sup>[205]</sup> by another user or that is [checked in](#)<sup>[267]</sup>. The **Paste...** option is grayed out in the context menu.

To copy a package, follow the step below:

1. In the **Project Browser**, right-click on the required package and select the **Copy Package to Clipboard**



context menu option (or click on the package and press **[Ctrl]+[C]**). The **Copy Package to Clipboard** dialog briefly displays until the copy operation completes.

To paste a package, follow the step below:

1. In the **Project Browser**, right-click on the package into which to paste the copied package, and select the **Paste Package from Clipboard** context menu option (or click on the package and press **[Ctrl]+[V]**). The **Paste Package from Clipboard** dialog briefly displays until the paste operation completes.

The target package is expanded to expose the pasted package in the **Project Browser**. If you are pasting the package within the same model as the copied source, the source parent package is also collapsed.

If the target package already contains:

- a package with the same name as the pasted package, the pasted package name has the suffix - *Copy*
- a package with the same name as the pasted package *including* the - *Copy* suffix, the suffix becomes - *Copy1* (or - *Copy 2*, - *Copy3* and so on, as copies of the package accumulate in the target parent package).

You can keep the same package name as the source, or you can rename the package either by clicking twice on it and editing the name in the **Project Browser**, or by double-clicking on it and editing the name in the **Properties** dialog.

#### 4.4.5 Drag a Package Onto a Diagram

You can drag a package element from the **Project Browser** onto the current diagram, as an icon of the package listing its contents. This is a useful feature to help organize the display and documentation of models.

The following illustration shows how a package is displayed in a diagram; note the child Actor and Use Case icons.

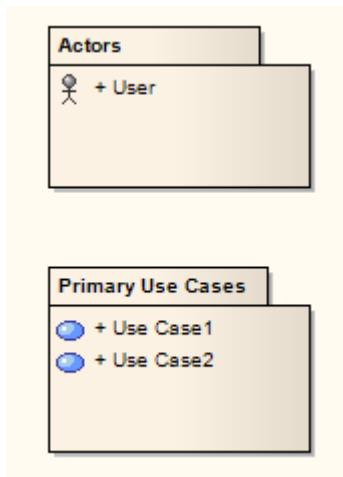

#### See Also

- [Show or Hide Package Contents](#)<sup>[389]</sup>

#### 4.4.6 Show or Hide Package Contents

To show or hide the contents of packages in a diagram, follow the steps below:

1. Load a diagram.
2. Double-click in the background area to open the **Diagram Properties** dialog.
3. Click on the **Elements** tab.

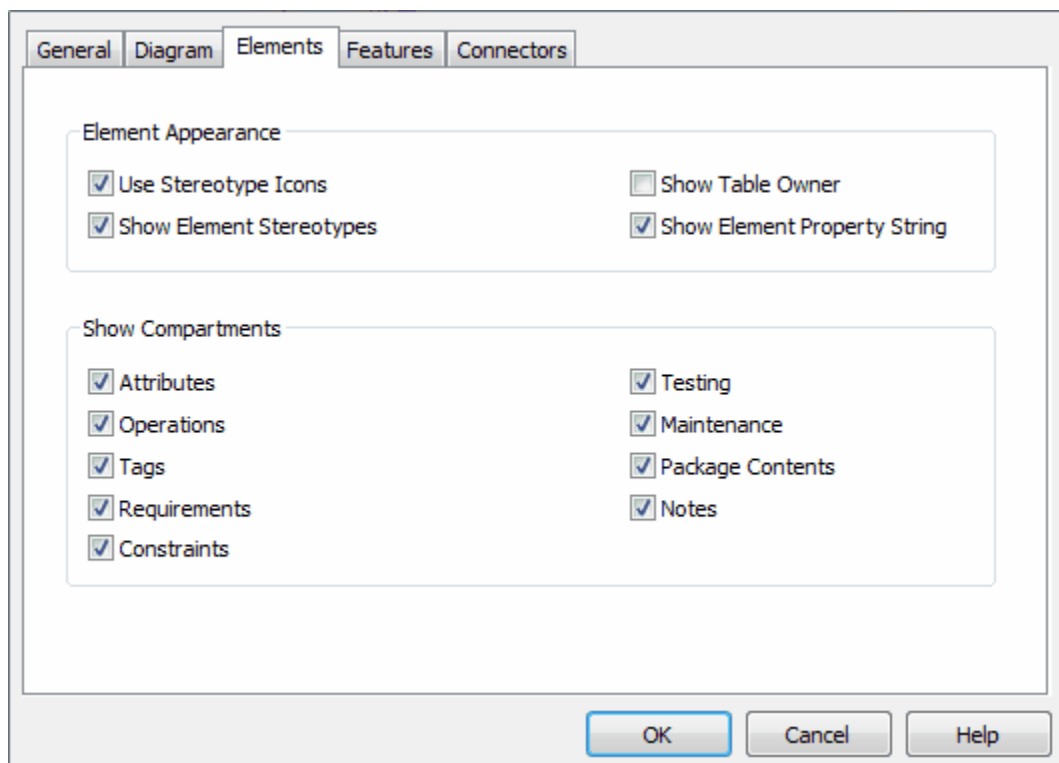

4. Select or clear the **Package Contents** checkbox as required.
5. Click on the **OK** button.

#### 4.4.7 Delete a Package

To delete a package, follow the steps below:

1. Highlight the package in the **Project Browser**.
2. Right-click to open the context menu.
3. Click on the **Delete** option. A confirmation prompt displays.
4. Click on the **OK** button.

#### **Warning:**

Deleting a package also deletes all contents of the package, including sub-packages and elements. Make very sure that you really want to do this before proceeding.

#### **Note:**

In a multi-user environment, other users do not see the change until they [reload their project](#) <sup>[267]</sup>.

## 4.5 Diagrams

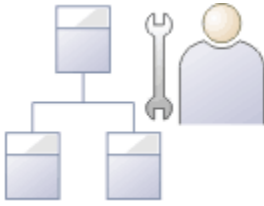

*Diagrams* are collections of project elements laid out and inter-connected as required.

Enterprise Architect supports all of the UML diagrams, as well as several custom extensions. Together with the Enterprise Architect elements and connectors, these form the basis of the model. Diagrams are stored in packages and can have a parent object (optional). Diagrams can be moved from package to package.

The basic elements used in each type of diagram are shown below. After you have reviewed these illustrations, go to the following topics:

- [Diagram Context Menu](#)<sup>[394]</sup>
- [Diagram Tasks](#)<sup>[421]</sup>

### Tip:

If the diagram display is too small to read comfortably, click on the diagram, press and hold **[Ctrl]** and use the mouse wheel to temporarily expand or reduce the display magnification.

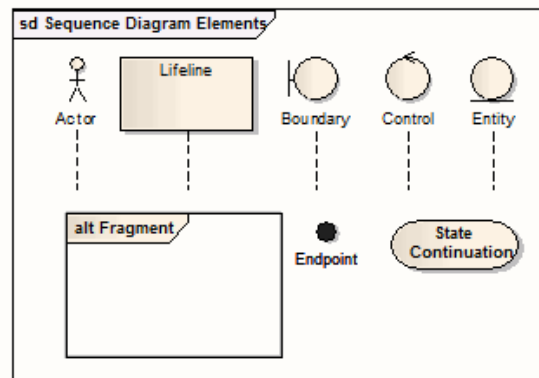
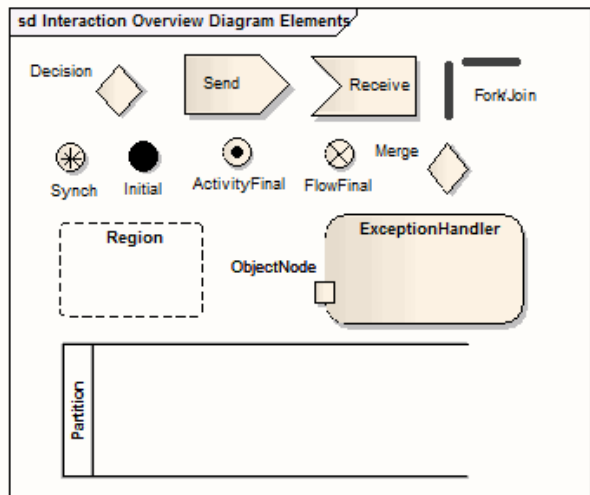
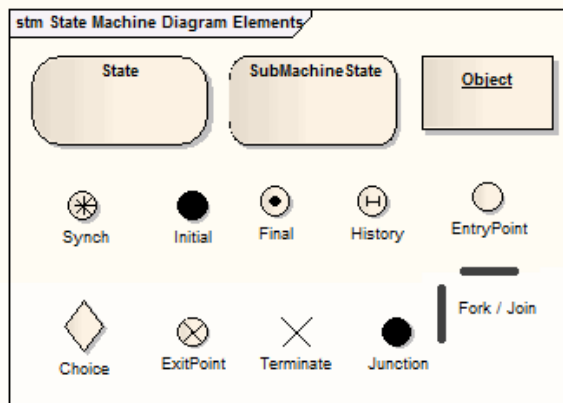
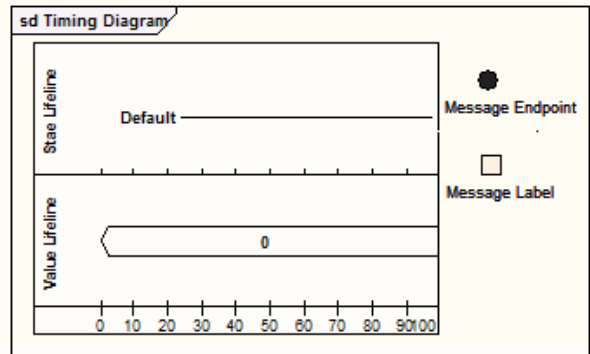
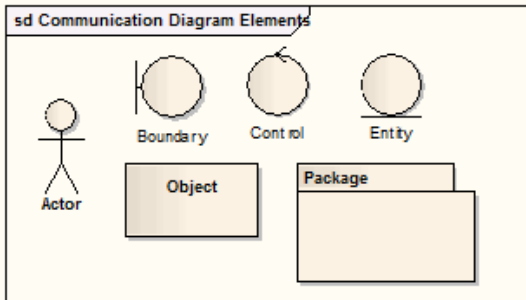
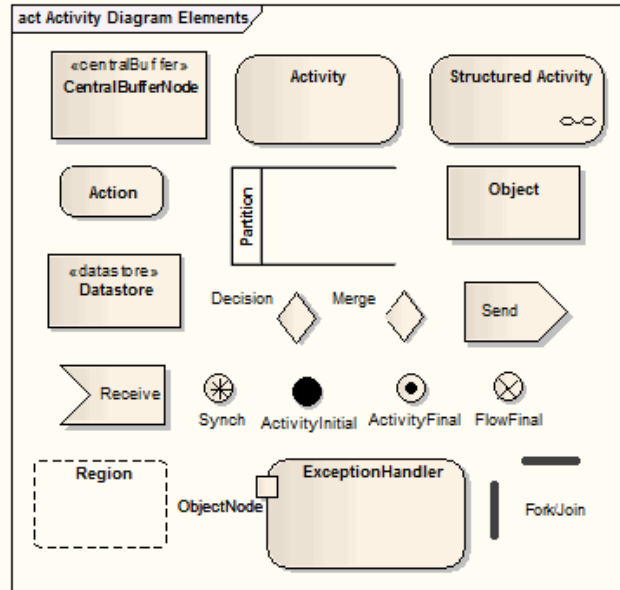
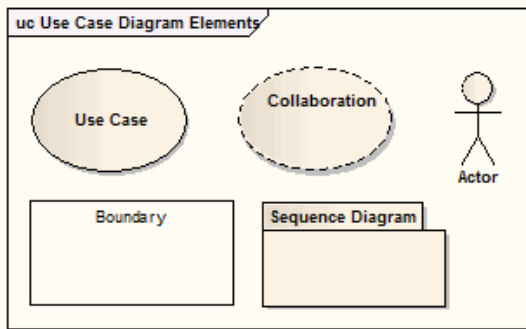

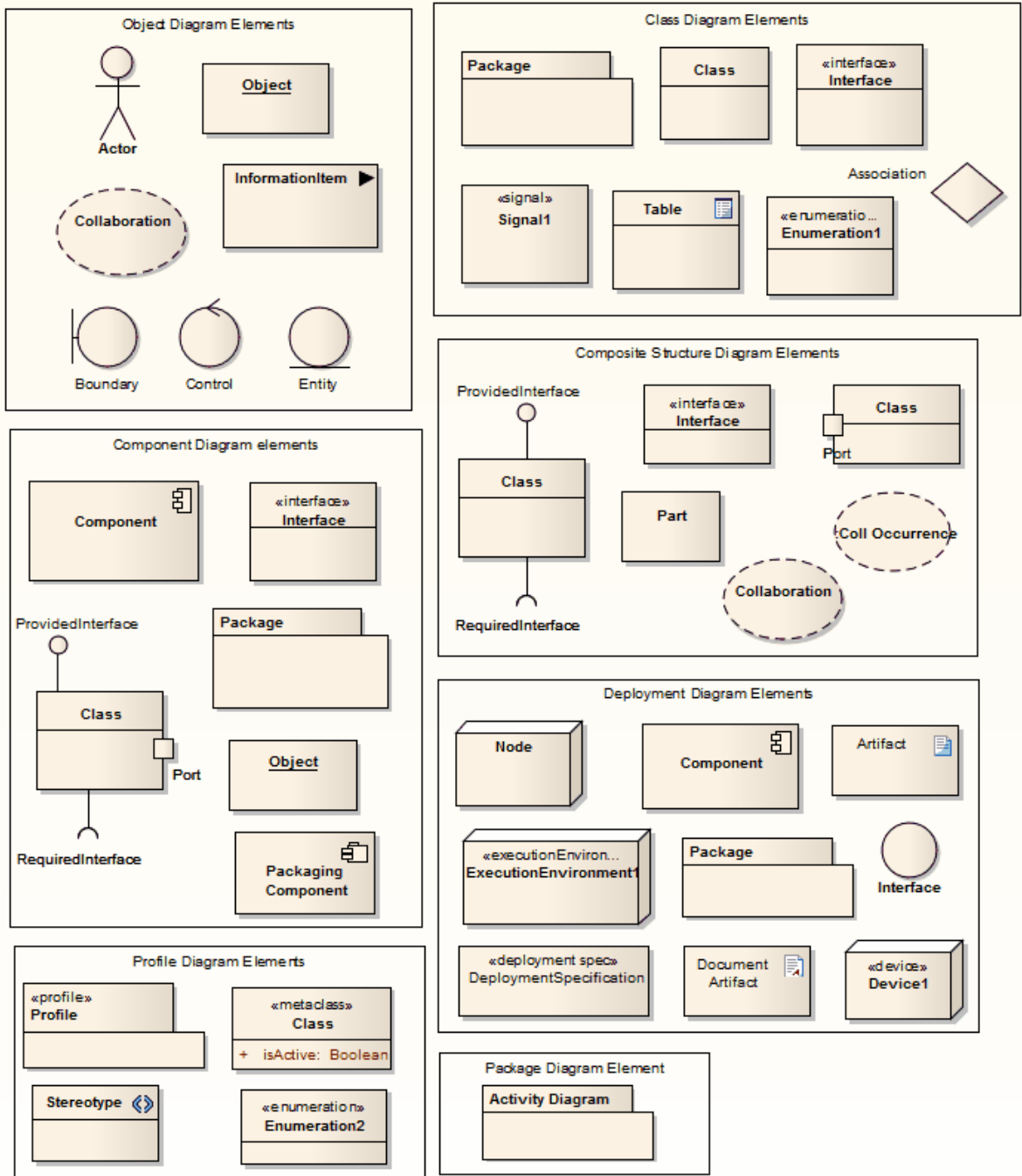

### 4.5.1 Diagram Context Menu

To open the diagram context menu, open the required diagram and right-click on the diagram background.

Not all the menu options shown below appear on all diagram context menus.

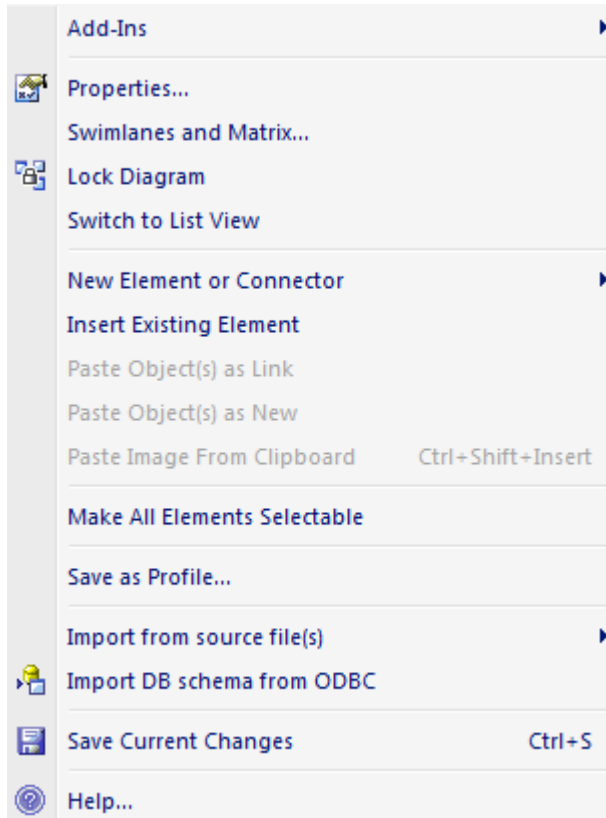

The diagram context menu enables you to:

- View the [Diagram Properties](#) <sup>[423]</sup> dialog
- Add [Swimlanes](#) <sup>[450]</sup> or a [Swimlanes Matrix](#) <sup>[444]</sup> to the diagram
- Protect a diagram from inadvertent changes ([Lock Diagram](#) <sup>[457]</sup>)

#### Note:

This does not apply if security is enabled in the Corporate, Business and Software Engineering, Systems Engineering and Ultimate editions. In that case, see the [Lock Model Elements](#) <sup>[204]</sup> topic.

- Display the diagram contents as an [Element List](#) <sup>[1255]</sup> instead of as a diagram
- [Insert](#) <sup>[395]</sup> various elements and connectors into a diagram
- [Paste copied element](#) <sup>[435]</sup>(s) as a link or as new elements
- [Paste an image](#) <sup>[58]</sup> held on the clipboard into the diagram
- Make all the elements on the diagram selectable. If an element is selectable, you can move it around the diagram and perform right-click context-menu operations. If an element is unselectable, you cannot move it around the diagram and the only right-click operation available is to make the element selectable. This option has no effect on double-click operations on the element, such as displaying child diagrams.
- Save the current diagram [as a Profile](#) <sup>[1106]</sup>
- [Import, or reverse engineer, source code](#) <sup>[1325]</sup> (not available in the Desktop edition)
- [Import database tables from an ODBC data source](#) <sup>[1363]</sup> (not available in the Desktop edition)
- Save any changes to the current diagram
- View the Enterprise Architect Help on the type of diagram currently displayed.

### 4.5.1.1 Insert Elements and Connectors

When you click on the **New Element or Connector** option on the **Diagram** context menu, a list of elements and connectors displays, as shown below for a Class diagram:

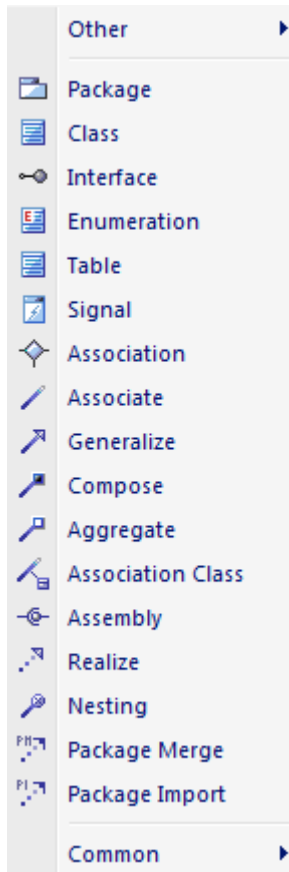

The structure of this list is as follows:

- **Other** - expands to offer options to select elements and connectors from diagram types other than either the current diagram type or pinned **Toolbox** pages
- The expanded list of elements and connectors for the current diagram type
- Collapsed lists of elements and connectors for pages that have been pinned in the **Toolbox**; if an MDG Technology:
  - is active
  - automatically pins **Toolbox** pages, and
  - has pages that redefine UML or Extended pagesthe MDG Technology pages override the UML or Extended pages, which are not shown
- (At the end) **Common** - expands to display a list of the common elements and connectors.

### 4.5.2 Print Preview

When you select the **File | Print Preview** menu option, the display initially shows the first two pages on one screen, with no scroll bar. To toggle between this two-page display and a single-page display, click on the  icon in the preview screen toolbar. In either mode, you can use the forward and back arrows to scroll through the pages of the diagram.

To display more than two pages on one screen, up to a maximum of ten pages, click on the **Zoom Out** button in the preview screen toolbar. The screen now includes the vertical scroll bar, which you can also use to scroll through the pages of the diagram.

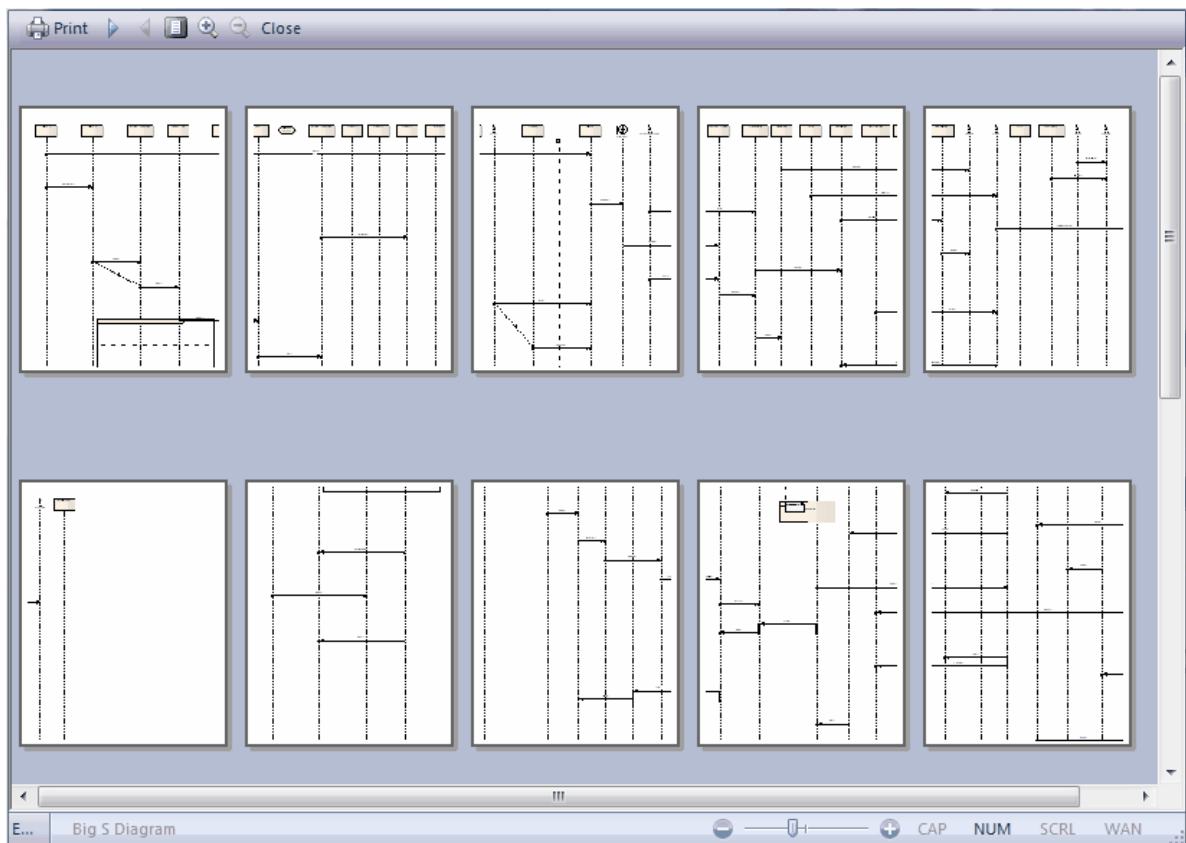

### 4.5.3 Diagram View

The **Diagram View** is the main workspace window that enables you to create and display diagrams.

You open a diagram by double-clicking on the diagram name in the **Project Browser**. You can then open further diagrams in the same way, or from within an open diagram by clicking on hyperlinks or elements that contain other diagrams. You can open many diagrams, but you can view only one at a time.



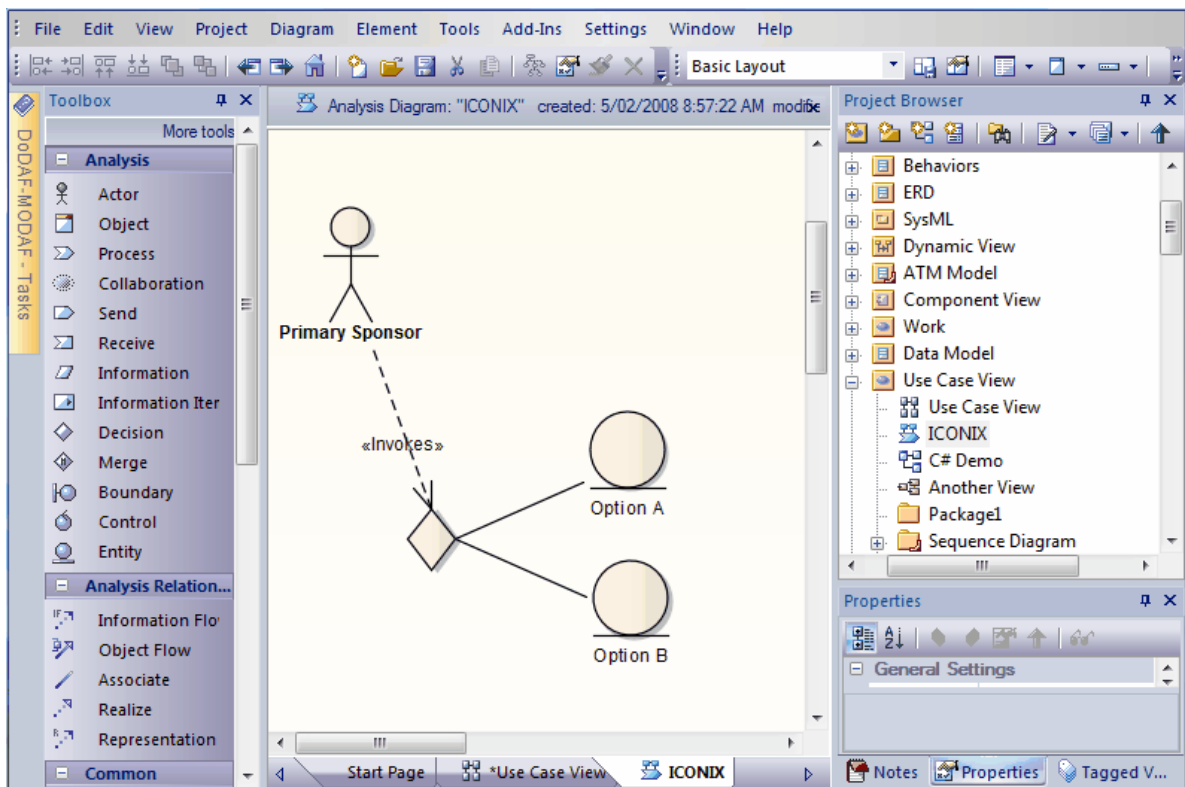

Across the top of a diagram is the diagram caption bar, containing the diagram statistics.

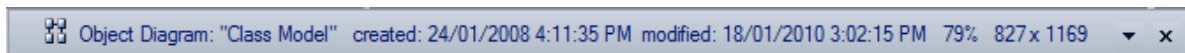

This caption bar also enables you to switch or close the diagram. The caption bar provides the:

- Icon and text label for the diagram type
- Diagram name
- Date and time the diagram was created
- Date and time the diagram was last modified
- The current magnification (zoom) of the diagram
- The diagram page size, in pixels
- A drop-down arrow that lists the currently-open diagrams; click on a diagram name to switch to that diagram
- The Window 'close cross'; click on this to close the displayed diagram.

Use the **Diagram View** to build model relationships and elements. Within the diagram, you can create new elements, drag in existing elements and generally organize the elements and relationships. Most work is carried out on elements in the **Diagram View**, so understanding how it works and how to manipulate elements is essential. Use the example project supplied with Enterprise Architect to explore the capabilities and behavior of the **Diagram View**.

#### Tip:

You can also use the [Element List](#)<sup>[125]</sup> to manipulate elements.

### 4.5.4 Diagram Tabs

**Diagram Tabs** are located, by default, at the bottom of the **Diagram View**. (You can also move them to the top of the **Diagram View**, above the **Status Bar**; see the [Configure Local Options | General](#)<sup>[35]</sup> topic.)

Each time you open a diagram, the diagram name and diagram type symbol are shown in the tab for easy identification and access.



#### Notes:

- The **Component View** tab is white with bold text; this means that the Component View diagram is the diagram currently displayed in the **Diagram View**.
- The **Use Case View** tab has an asterisk. This means that there are unsaved changes in the Use Case View diagram. To save the changes see [below](#) <sup>[398]</sup>.
- There are also tabs for other types of view, such as the **Start Page** (as shown), RTF reports, code editors, the **Model Search** and the **Relationship Matrix**.

### The Diagram Tabs Menu

To access the **Diagram Tabs** context menu, right-click on an appropriate tab. In the example below, the **\*Use Case View** tab was right-clicked.

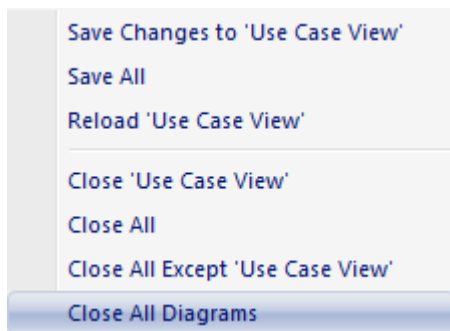

The table below explains each menu option.

Menu Option	Use to
Save Changes to '<tab name>'	Save the changes made to the diagram.
Save All	Save the model.
Reload '<tab name>'	<ol style="list-style-type: none"> <li>1. Reopen the diagram without the unsaved changes; that is, revert to the state before any changes were made.</li> <li>2. <a href="#">Refresh the diagram</a> <sup>[267]</sup> from the repository, to show any changes made by other users in a shared model.</li> </ol>
Close '<tab name>'	Close the diagram; Enterprise Architect prompts you to save changes to the diagram.
Close All	Close all open diagrams; Enterprise Architect prompts you to save any diagrams with unsaved changes.
Close All Except '<tab name>'	Close all diagrams except for '<tab name>'; Enterprise Architect prompts you to save any diagrams with unsaved changes.
Close All <view type>	<p>(Where several views of the same type can be opened at the same time, such as diagrams, RTF documents, or text editors.)</p> <p>Close all views of the same type as the selected tab, leaving views of other types still open.</p>

## 4.5.5 Diagram Toolbox

### What is the Toolbox?

The Enterprise Architect **Toolbox** is a panel of icons that you use to create elements and connectors on a diagram.

Within the **Toolbox**, related elements and connectors are organized into *pages*, each page containing the elements or connectors used for a particular *type* of diagram. The diagrams include standard UML diagrams, Enterprise Architect Extended diagrams, and any MDG Technologies and Profiles that you have added to Enterprise Architect. When you open a diagram, the **Toolbox** automatically provides the element and relationship pages corresponding to the diagram type. This does not prevent you using elements and connectors from other pages in a given diagram, though some combinations might not represent valid UML.

### Display the Toolbox

To display the **Toolbox**, select the **View | Diagram Toolbox** menu option, or press **[Alt]+[5]**.

The **Toolbox** can be docked on either side of the diagram, or free floated on top of the diagram to expose more surface for editing.

#### Tip:

You can also hide and show the whole **Toolbox** using the  **Show Element Toolbox** button on the **Workspace Views** toolbar.

To display specific pages in the **Toolbox**, select the **More Tools** option at the top of the **Toolbox** and select the appropriate UML, Extended or customized diagram type from the menu.

In most cases, three pages display: **<type> elements**, **<type> Relationships** and **Common**. If you select the **<default>** option, you display only the **Common** page.

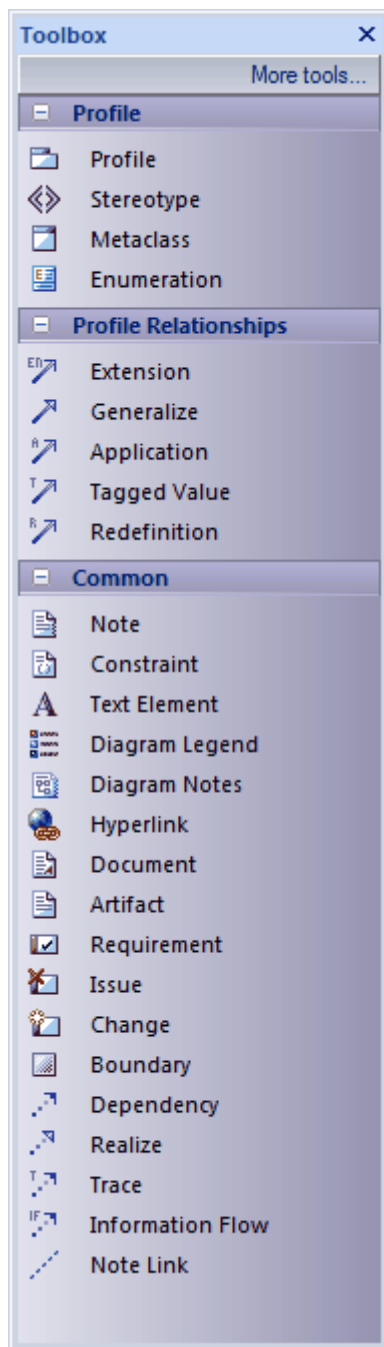

### Create Elements and Connectors:

1. In the **Project Browser**, double-click on the icon against the required diagram. The diagram opens with the appropriate **Toolbox** pages for that diagram type. (If you want a different set of elements and connectors, click on **More tools** and select the appropriate diagram type as explained above).
2. Click on the required item; for example, the *Class* element or *Associate* relationship.
3. For element items, click anywhere on the diagram to place the new element.
4. For connector items, drag the cursor between the source and target elements on the diagram. The solid border of the elements changes to a hatched border as you pass the cursor over them, indicating the source and potential target elements. To add bends to the connector, press **[Shift]** as you change the drag direction of the cursor.

Alternatively, drag from the source element to an empty area of the diagram; the **Quick-linker**<sup>[475]</sup> enables you to create the target element.

5. Edit the **element properties**<sup>[481]</sup> or **connector properties**<sup>[626]</sup>, as required.

#### Note:

Dropping a Package element from the **Toolbox** into a diagram creates a new package in the **Project Browser**, and a default diagram of the same type as the current diagram.

#### Tips:

- If you are creating several elements of one type, after creating the first just press **[Shift]+[F3]** or **[Ctrl]+click** to create the next element of that type. For connectors, click on the source element and press **[F3]** to create another connector of the same type.
- You can change an unstereotyped element to one of its **stereotyped**<sup>[895]</sup> elements by dragging the stereotyped element from the **Toolbox** onto the unstereotyped element in the diagram. For example, you can stereotype a Class by dragging a Table element or a Profiled Class element onto it.
- If the diagram element already has the stereotype, you can also drag the **Toolbox** element onto it to **synchronize the element's stereotype Tagged Values**<sup>[910]</sup>.

### Customize The Toolbox

You can customize the **Toolbox** pages by **pinning them**<sup>[401]</sup> within the **Toolbox**, or by adding **MDG Technologies**<sup>[1069]</sup> and **UML Profiles**<sup>[906]</sup> to the **Toolbox**.

#### Note:

Enterprise Architect provides **Toolbox** pages for a wide range of MDG Technologies, such as **Archimate**<sup>[1073]</sup>, **BPEL**<sup>[958]</sup>, **BPMN**<sup>[952]</sup>, **Data Flow Diagrams**<sup>[1076]</sup>, **ICONIX**<sup>[1084]</sup> and **Mind Mapping**<sup>[1087]</sup>, as part of the initial install.

You can also change other features of the **Toolbox** appearance - see **Toolbox Appearance Options**<sup>[401]</sup>.

### 4.5.5.1 Toolbox Appearance Options

You can modify the appearance of the **Toolbox** pages in several ways, through the context menu.

To display the context menu, right-click on the **Toolbox** page.

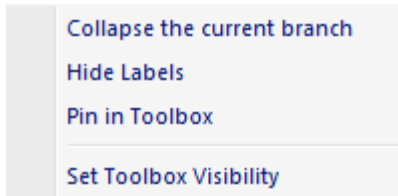

#### Note:

On a **Toolbox** page for an MDG Technology or UML Profile, if you right-click directly on a profile element an additional option - **Synchronize Stereotype** - is available at the end of the context menu. This enables you to [synchronize](#)<sup>[910]</sup> the Tagged Values and constraints for all elements created from the selected profile element.

- To hide the element or relationship labels (and subsequently redisplay them), select the **Hide Labels** (or **Show Labels**) context menu option. The icons in the page then 'wrap' within the page, without text labels.

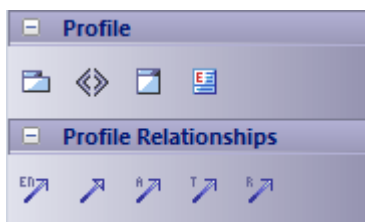

When you hide the labels, you can display the label of an individual element or relationship by moving the cursor over the icon.

- To 'pin' the page so that it displays for any group in the **Toolbox**, select the **Pin in Toolbox** menu option. (This is not available on the **Common** page, which displays in all groups anyway.)

For example, if you 'pinned' the **Class** elements page, and switched to the **Communication** pages, the **Toolbox** would include a collapsed **Class** elements page underneath the **Communication** pages.

- To unpin the page so that it displays only in its own **Toolbox** group, right-click on it and select the **Unpin from Toolbox** context menu option.
- To collapse a page to just show the heading (<type> elements, <type> Relationships or Common), click on the 'minus' box at the left of the page heading. To expand the page again, click on the heading. Alternatively, collapse the page by right-clicking on the page and selecting the **Collapse** context menu option.

### Set Toolbox Visibility

To tailor the **Toolbox** to list all pages you require at the same time, follow the steps below:

- Click on the **Set Toolbox Visibility** context menu option. The **Visible Toolbox Pages** dialog displays.

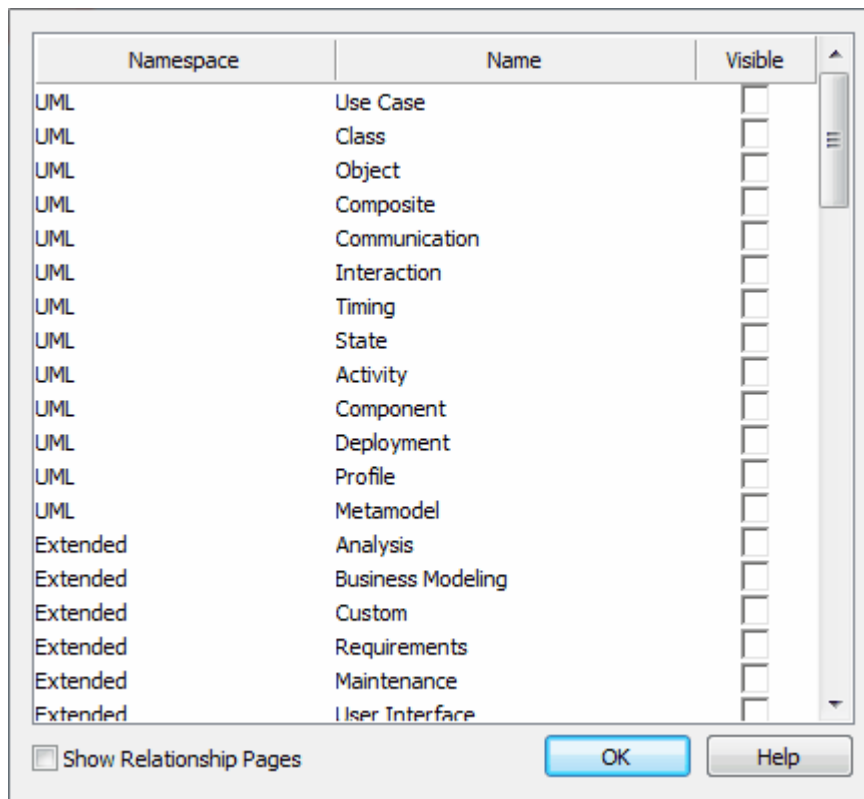

- By default, the dialog lists the *element* pages only, in the order: UML pages, Extended pages, MDG Technology pages. To include the corresponding *relationship* pages, select the **Show Relationship Pages** checkbox at the bottom of the dialog.
- For each page to display on the **Toolbox**, select the **Visible** checkbox. Deselect the checkbox if you no longer require a page to be displayed.
- When you have defined the list of pages to display, click on the **OK** button. The pages you have selected are pinned to the **Toolbox** in a collapsed state, underneath the current diagram-type pages.

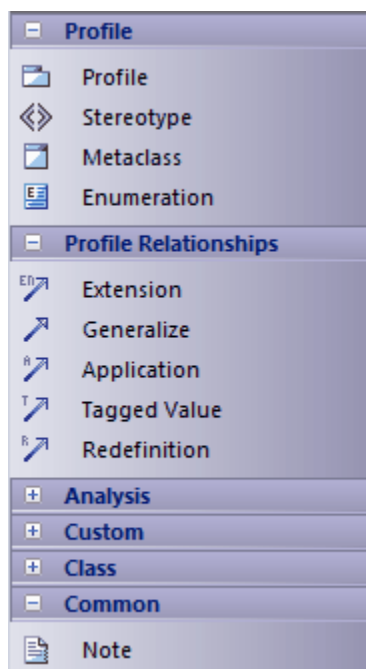

- To expand a page, click on the heading. You can remove a page individually by expanding it, right-clicking on it and selecting the **Unpin from Toolbox** context menu option.

**Note:**

MDG Technologies can impose their own **Toolbox** page visibility. For example, if ICONIX is the active technology, all six ICONIX pages are automatically exposed in the **Toolbox**.

If the active Technology pages duplicate UML or Extended pages (as the ICONIX pages do) then the pinned Technology pages override and replace the pinned UML and Extended pages.

For example, if ICONIX is active and you have pinned the Extended **Analysis** page, the **Analysis** page in the list is the ICONIX-defined page, not the Extended **Analysis** page.

#### 4.5.5.2 **Toolbox Shortcut Menu**

To add elements and connectors into a diagram, you can access the **Toolbox** shortcut menu instead of employing the full graphical **Toolbox**.

The menu provides options to select:

- **Elements** specific to the current diagram type (*Use Case* in the example shown below)
- **Relationships** specific to the current diagram type
- Elements and relationships from any pages pinned in the **Toolbox**
- **Common** elements and relationships
- Elements and connectors for **other** diagram types.

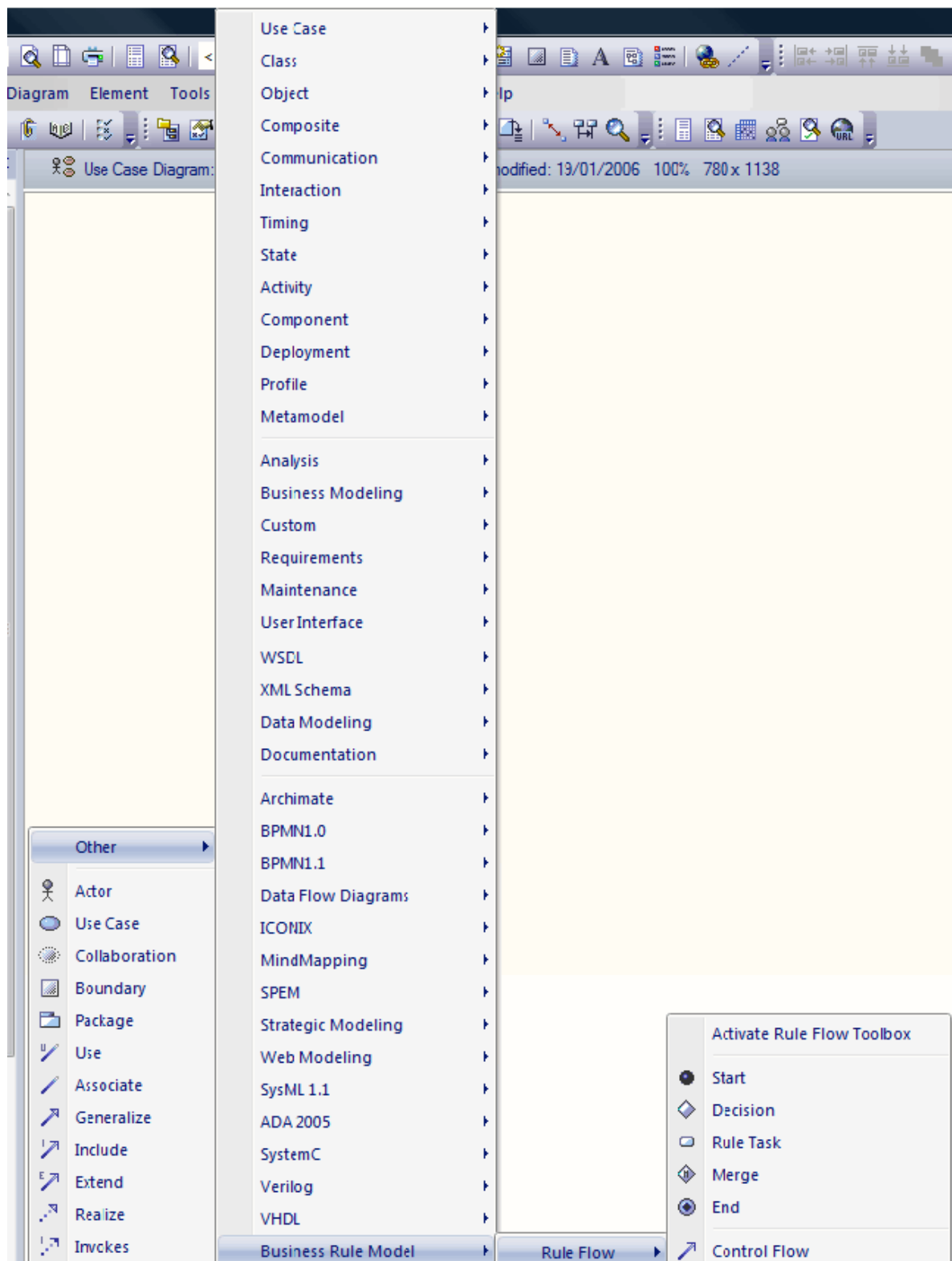

The advantage of using the **Toolbox** shortcut menu is that it provides an increased amount of the workspace to be used for diagramming rather than to display fixed (instead of pop-up) menus.

To use the **Toolbox** shortcut menu, follow the steps below:

1. Open a diagram.
2. Either:



- Click on the diagram background and press **[Insert]** or **[Spacebar]**
  - Press and hold **[Ctrl]** and right-click on the diagram background.  
The shortcut menu displays, listing the current diagram-type elements and connectors.
3. If necessary, select the **Other** option or a pinned **Toolbox** page option to list elements and connectors for a different diagram type.
  4. Select the element or connector to include in the diagram. The object is added to the diagram.

If you select the **Other** context menu option, the final menu in the sequence offers the **Activate <Type> Toolbox** option. This opens and activates the corresponding page in the **Toolbox**, if the **Toolbox** is visible.

**Note:**

As with the **Toolbox** itself, if an MDG Technology:

- is active
- automatically pins **Toolbox** pages and
- duplicates UML or Extended pages

the pinned Technology pages override and replace the pinned UML or Extended pages in the initial **Toolbox** shortcut menu.

### 4.5.5.3 Common Group



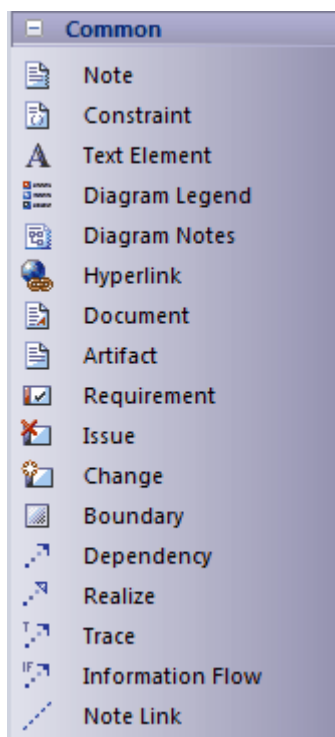













The **Common** page of elements and relationships is displayed at the bottom of every other set of pages. It contains the elements and relationships that can be used on any diagram.



### Toolbox Elements and Connectors

**Note:**

Click on the elements and connectors below for information.

Common Elements	Common Connectors
 Note	 Dependency
 Constraint	 Realize
 Text Element	 Trace
 Diagram Legend	 Information Flow
 Diagram Notes	 Note Link
 Hyperlink	
 Document	
 Artifact	
 Requirement	
 Issue	
 Change	
 Boundary	

#### 4.5.5.4 Use Case Group

Use Case elements are used to build [Use Case models](#)<sup>[676]</sup>. These describe the functionality of the system to be built, the requirements, the constraints and how the user interacts with the system.

Often, Sequence diagrams are associated with Use Cases to capture work flow and system behavior.

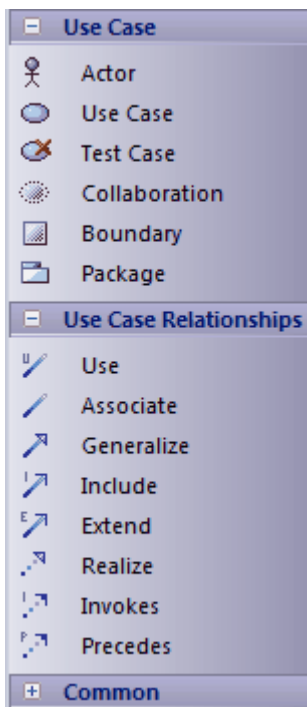

The **Use Case** group is used to model the system functionality from the perspective of a system user. The user is called an *Actor* and is drawn as a stick figure, although the user could be another computer system or similar. A *Use Case* is a discrete piece of functionality the system provides that enables the user to perform some piece of work or something of value using the system.

Examples of Use Cases are: *login*, *open account*, *transfer funds*, *check balance* and *logout*; each of these implies some purposeful and discrete functionality the system is to provide to a user.

A **Test Case** describes what must be set up in order to test a particular feature.

The connectors available include: *associate* (an actor uses a Use Case), *extend* (one Use Case can extend another), *include* (one Use Case can include another) and *realize* (this Use Case might realize some business requirement).

To add an element to the current diagram, click on the required icon and drag it into position on the diagram. Set an element name and other properties as prompted.

To add a relationship, click on the required icon, then click on the start element in the diagram and drag to the end element.

**Note:**

*Invokes* and *Precedes* relationships are defined by the Open Modeling Language (OML). They are stereotyped *Dependency* relationships; *Invokes* indicates that Use Case A, at some point, causes Use Case B to happen, whilst *Precedes* indicates that Use Case C must complete before Use Case D can begin.

#### 4.5.5.5 Class Group

The **Class** group can be used for [Package diagrams](#), [Class diagrams](#) and [Object diagrams](#); those that usually display elements concerned with the logical structure of the system, such as Objects, Classes and Interfaces.

Logical models can include domain models (high level business driven object model) through to strict development Class models (define inheritance, attributes, operations).

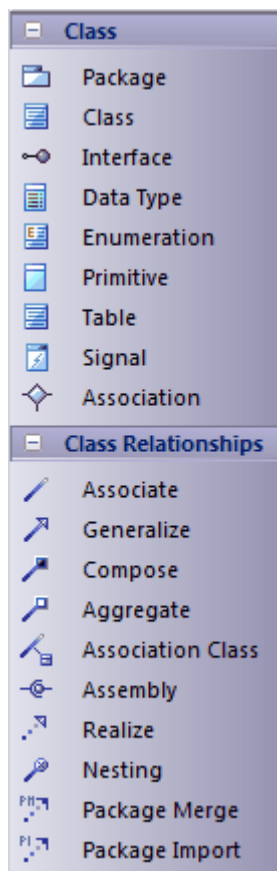

The **Class** group is used for creating Class models and database models. Class modeling is done using the *Class* and *Interface* elements, as well as occasional use of the *Object* element to model Class instances. You can add Association or Aggregation relationships. See the [Class](#)<sup>[376]</sup> model template for an example of this.

Use the *Table* element to insert a stereotyped Class for use in database modeling. See the [Data Modeling](#)<sup>[1011]</sup> topic for more details.

To add an element to the current diagram, click on the required icon and drag it into position on the diagram. Set an element name and other properties as prompted.

To add a relationship, click on the required icon, click on the start element in the diagram and drag to the end element.

#### 4.5.5.6 Object Group

The **Object** group is used to create [Object diagrams](#)<sup>[723]</sup>.

Object diagrams reflect multiplicity and the roles instantiated Classes could serve. They are useful in creating different cases in which relationships and Classes are applied.

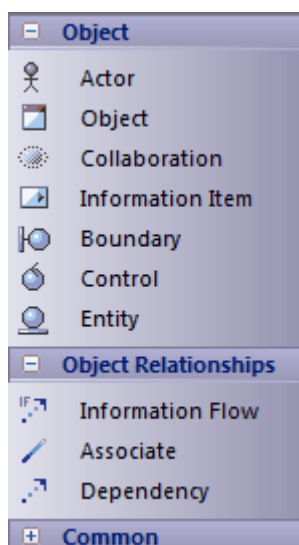

The user is called an [Actor](#)<sup>[757]</sup> and is drawn as a stick figure, although the user could be another computer system or similar.

An [Object](#)<sup>[823]</sup> is an instance of a Class.

To add an element to the current diagram, click on the required icon, and drag it into position on the diagram. Set an element name and other properties as prompted.

To add a relationship, click on the required icon, then click on the start element in the diagram and drag to the end element.

### 4.5.5.7 Composite Group

The **Composite** group is used for [Composite Structure diagrams](#)<sup>[724]</sup>.

These reflect the internal collaboration of Classes, Interfaces or Components to describe a functionality or to express run-time architectures, usage patterns and the participating elements' relationships, which static diagrams might not show.

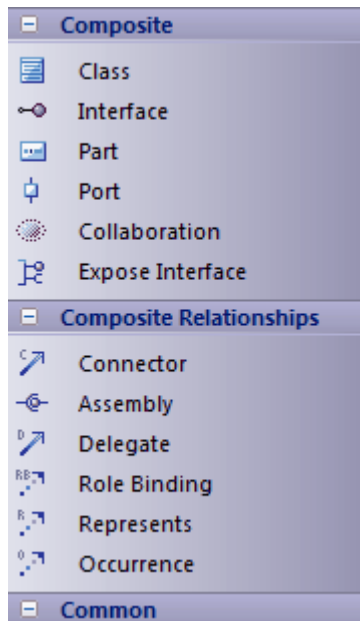

To add an element to the current diagram, click on the required icon, and drag it into position on the diagram. Set an element name and other properties as prompted.

To add a relationship, click on the required icon, then click on the start element in the diagram and drag to the end element.

### 4.5.5.8 Communication Group

The **Communication** group is used to model dynamic interactions between elements at run-time.

The Actor element models a user of the system, while the other elements model things within the system, including standard elements (rectangular element), user interface component (circle with left positioned vertical bar), controller (circle with arrow head in top most position) and entity (circle with bar at bottom).

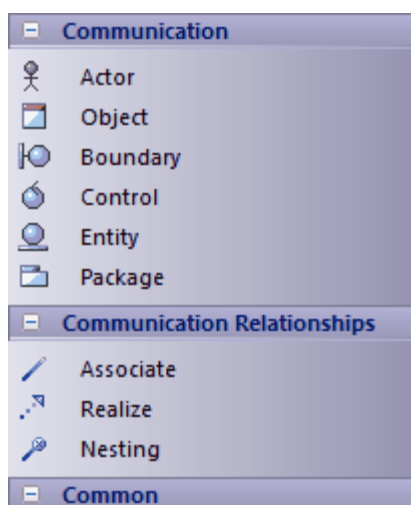

[Communication diagrams](#)<sup>[715]</sup> are used to model work flow and sequential passing of messages between elements in real time. They are often placed beneath Use Case elements to further expand on Use Case behavior over time.

To add an element to the current diagram, click on the required icon, and drag it into position on the diagram. Set an element name and other properties as prompted.

To add a relationship, click on the required icon, then click on the start element in the diagram and drag to the end element.

**Note:**

Communication diagrams were known as Collaboration diagrams in UML 1.4.

### 4.5.5.9 Interaction Group

The **Interaction** group is used for Interaction diagrams ([Sequence](#)<sup>[706]</sup>, [Timing](#)<sup>[690]</sup>, [Communication](#)<sup>[715]</sup> or [Interaction Overview](#)<sup>[717]</sup>), which are used to model work flow and sequential passing of messages between elements in real time.

Interaction diagrams are often placed beneath Use Case elements to further expand on Use Case behavior over time.

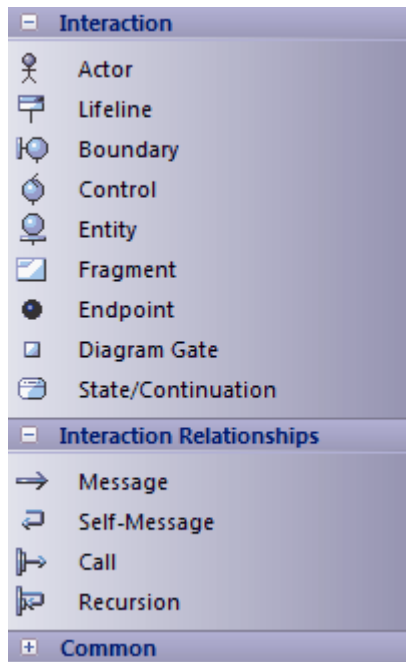

The **Interaction** group is used to model dynamic interactions between elements at run-time. The *Actor* element models a user of the system, while the other elements model things within the system, including standard elements (Lifeline), user interface component (Boundary), controller and Entity. The meaning of the element symbols is discussed further in the [Sequence diagram](#)<sup>[706]</sup> topic. The *Message* (sequence) relationship is used to model the flow of information and processing between elements.

#### Note:

Messages can be simple or recursive calls.

To add an element to the current diagram, click on the required icon, and drag it into position on the diagram. Set an element name and other properties as prompted.

To add a relationship, click on the required icon, then click on the start element in the diagram and drag to the end element.

### 4.5.5.10 Timing Group

The **Timing** group is used solely for [Timing diagrams](#)<sup>[690]</sup>, which use a time-scale to define the behavior of objects. The time-scale visualizes how the objects change state and interact over time.

Timing diagrams can be used for defining hardware-driven or embedded software components, and time-driven business processes.

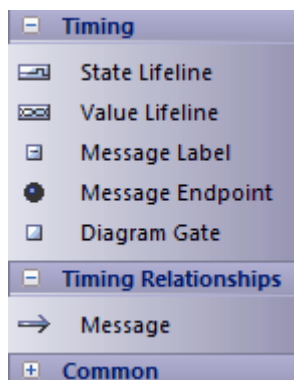

A *Lifeline* is the path an object takes across a measure of time, indicated by the x-axis.

A [State Lifeline](#)<sup>[794]</sup> follows discrete transitions between states, which are defined along the y-axis of the timeline. Any transition has optional attributes of timing constraints, duration constraints and observations.

A [Value Lifeline](#)<sup>[808]</sup> shows the lifeline's state across the diagram, within parallel lines indicating a steady state. A cross between the lines indicates a transition or change in state.

To add an element to the current diagram, click on the required icon, and drag it into position on the diagram. Set an element name and other properties as prompted.

To add a relationship, click on the required icon, then click on the start element in the diagram and drag to the end element.

### 4.5.5.11 State Group

The **State** group is used by [State Machine diagrams](#) to show the enableable states a Class or element might be in and the transitions from one state to another. These diagrams are often placed under a Class element in the **Project Browser** to illustrate how a particular element changes over time.

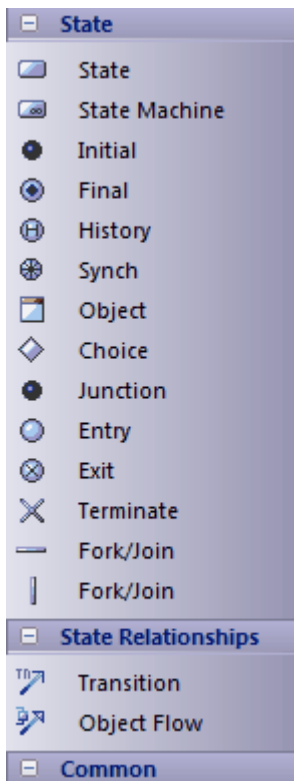

The **State** group provides elements common to State Machine diagrams; basically the *State*, start and end nodes and the *Object Flow* relation. State Machine diagrams are used to model the states or conditions that elements might be in at runtime, such as *active*, *inactive*, *idle*, *accelerating* or *braking*. States can have substates; for example, *accelerate* or *brake* might be substates of *active*.

To add an element to the current diagram, click on the required icon and drag it into position on the diagram. Set an element name and other properties as prompted.

To add a relationship, click on the required icon, then click on the start element in the diagram and drag to the end element.

### 4.5.5.12 Activity Group

The **Activity** group is used to model system dynamics from a number of viewpoints in [Activity diagrams](#)<sup>[674]</sup> and [Interaction Overview diagrams](#)<sup>[717]</sup>.

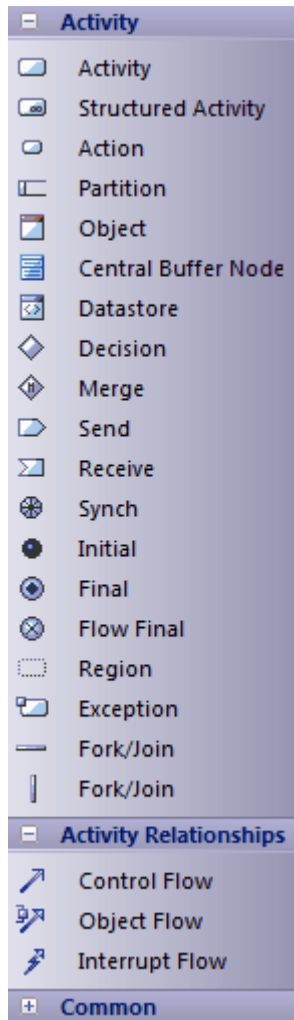

*Activity* elements enable you to describe the dynamics of the system from the point of view of activities and flows between them. Activities can be stereotyped as a *process* to display a business process icon. An Activity is some work that is carried out; it might overlap several Use Cases or form only a part of one Use Case.

*Send* and *Receive* events are included as triggers.

A *Decision* element marks a point where processing might split based on some outcome or value.

The *Flow* relation models an active transition and synch points are used to split and rejoin periods of parallel processing.

To add an element to the current diagram, click on the required icon, and drag it into position on the diagram. Set an element name and other properties as prompted.

To add a relationship, click on the required icon, then click on the start element in the diagram and drag to the end element.

### 4.5.5.13 Component Group

The **Component** group enables you to model the physical components of your system in a [Component diagram](#)<sup>[730]</sup>.

A component is a piece of hardware or software that makes up the system; for example, a DLL or Web Server are Components that might be deployed on a Windows 2000 Server (Node). See the [Deployment Diagram](#)<sup>[727]</sup> topic for an example of this.



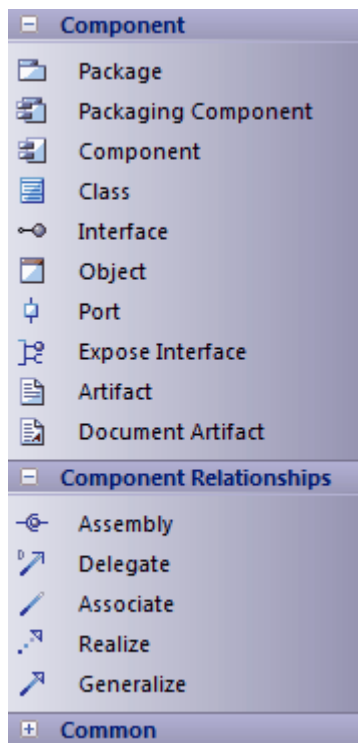

The **Component** group contains elements related to the actual building of the system: the components that make up the system (such as ActiveX DLL's or Java beans), the Interfaces they expose and the dependencies between those elements.

To add an element to the current diagram, click on the required icon and drag it into position on the diagram. Set an element name and other properties as prompted.

To add a relationship, click on the required icon, then click on the start element in the diagram and drag to the end element.

#### 4.5.5.14 Deployment Group

The **Deployment** group enables you to model the physical components and deployment structure of your system in a Deployment diagram.

A *Component* is a piece of hardware or software that makes up the system, and a *Node* is a physical platform on which the component is to exist. For example, DLLs or Web Servers are Components that could be deployed on a Windows 2000 Server (Node). See the [Deployment Diagram](#)<sup>[72]</sup> topic for an example of this.

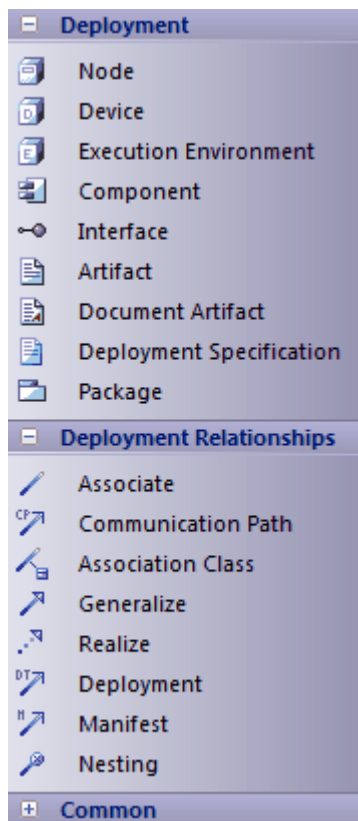

The **Deployment** group contains elements related to the actual building of the system; the components that make up the system (such as ActiveX DLLs or Java beans) and the nodes those components run on, including the physical connections between nodes.

To add an element to the current diagram, click on the required icon, and drag it into position on the diagram. Set an element name and other properties as prompted.

To add a relationship, click on the required icon, then click on the start element in the diagram and drag to the end element.

#### 4.5.5.15 Profile Group

The **Profile** group contains extended UML elements and connectors that can be used to [create and modify Profiles](#)<sup>[906]</sup>, for rapidly creating stereotypes and Tagged Values that can be applied to structures such as elements, attributes, methods and connectors.

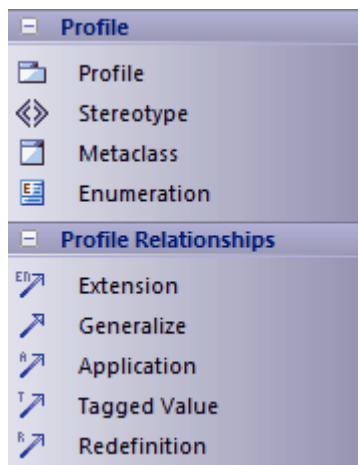

A *Profile* is used to provide a generic extension mechanism for building UML models in particular domains. They are based on additional Stereotypes and Tagged Values that are applied to structures such as elements, attributes, methods, connectors and connector ends.

A *Stereotype* provides a mechanism for varying the behavior and type of a model element.

A *Metaclass* is used to create a Class whose instances are Classes; a metaclass is typically used to construct metamodels.

An *Enumeration* creates a Class stereotyped as enumeration, which is used to provide a list of named values as the range of a particular type.

An *Extension* relationship shows that a stereotype extends one or more metaclasses. All stereotypes must extend either one or more Metaclasses, or another stereotype that extends a stereotype (that itself extends a stereotype, and so on).

A *Generalize* relationship shows that one stereotype specializes a more general stereotype. The more general stereotype must still extend a metaclass.

A *Tagged Value* relationship defines a reference-type (that is, RefGUID) Tagged Value owned by the source stereotype. The Tagged Value is named for the target role of this association, and is limited to referencing elements with the stereotype by the association target element.

The *Application* and *Redefinition* relationships are **deprecated**.

To add an element to the current diagram, click on the required icon, and drag it into position on the diagram. Set an element name and other properties as prompted.

To add a relationship, click on the required icon, then click on the start element in the diagram and drag to the end element.

#### 4.5.5.16 Metamodel Group

The **Metamodel** group enables you to create metamodel diagrams with support for [MOF](#) diagrams.

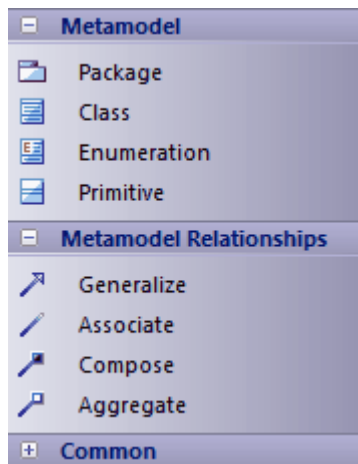

A [Package](#) is a namespace as well as an element that can be contained in other package's namespaces.

A [Class](#) is a representation of objects, that reflects their structure and behavior within the system.

An [Enumeration](#) is a Class with an enumeration stereotype.

A *Primitive* supports the MOF specification (**deprecated** - use the UML Primitive in the [Class](#) group).

To add an element to the current diagram, click on the required icon and drag it into position on the diagram. Set an element name and other properties as prompted.

To add a relationship, click on the required icon, then click on the start element in the diagram and drag to the end element.

### 4.5.5.17 Analysis Group

Analysis-type elements are used early in modeling to capture business processes, activities and general domain information. They are generally used in [Analysis diagrams](#) <sup>[733]</sup>.

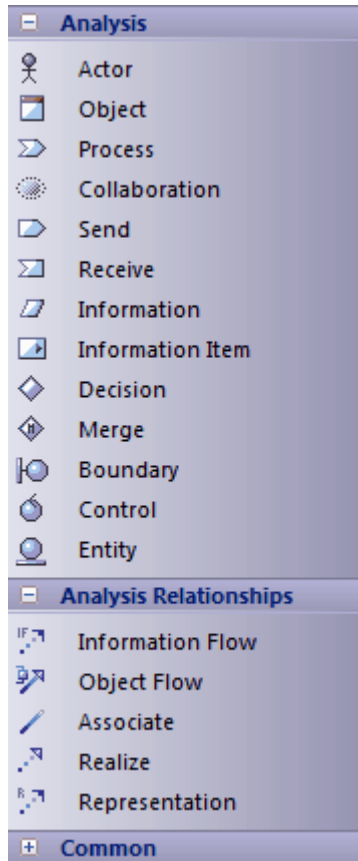

The elements and relationships in the **Analysis** group are used for early modeling of business processes, activities and collaborations. You can use stereotyped activities to model business processes, or stereotyped elements to capture standard UML business process modeling extensions such as worker, case worker, entity, and controller.

To add an element to the current diagram, click on the required icon and drag it into position on the diagram. Set an element name and other properties as prompted.

To add a relationship, click on the required icon, click on the start element in the diagram and drag to the end element.

### 4.5.5.18 Custom Group

The **Custom** group contains a few extended UML elements that might be of use in modeling or designing your system in a [Custom diagram](#)<sup>[734]</sup>.

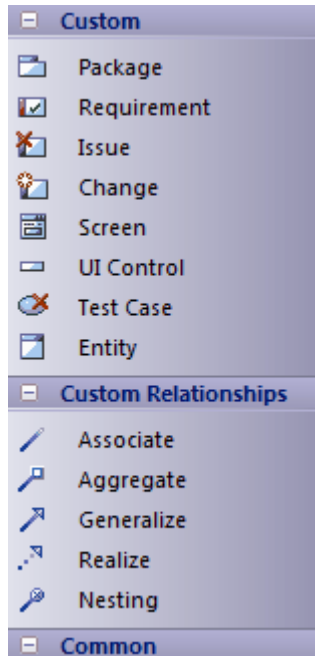

A [Package](#)<sup>[825]</sup> is a namespace as well as an element that can be contained in other package's namespaces.

A [Requirement](#)<sup>[846]</sup> is a custom element used to capture requirements outside of standard UML elements. A Requirement expresses required system behavior that can cross several Use Cases. You can connect Requirements to other elements using the *Realize* connector to express the implementation of a requirement and hence the [traceability](#)<sup>[1245]</sup> from user requirements to what is being built.

An *Issue* element is a structured comment that contains information about defects and issues relating to the system/model (see the [Defects \(Issues\)](#)<sup>[1563]</sup> topic). Affected elements are connected by [Trace](#)<sup>[892]</sup> connectors.

A *Change* element is a structured comment that contains information about changes requested to the system/model (see the [Changes and Defects](#)<sup>[1563]</sup> topic). Affected elements are connected by [Trace](#)<sup>[892]</sup> connectors.

A [Screen](#)<sup>[847]</sup> provides a stereotyped Class element that displays a GUI type screen; this can be used to express application GUI elements and flows between them.

A [UI control](#)<sup>[849]</sup> likewise can be used to express GUI controls.

A [Test Case](#)<sup>[848]</sup> element defines what must be set up in order to test a particular feature (see the [Testing Workspace](#)<sup>[1537]</sup> topic). It enables you to define a set of tests once for a number of elements, and provides greater visibility for tests.

An *Entity* is a stereotyped element that represents any general thing not captured by the element or Class type elements (for example a trading partner). Use of this element is **deprecated**: it was originally intended to take the role now occupied by a [Table](#)<sup>[849]</sup> element.

To add an element to the current diagram, click on the required icon and drag it into position on the diagram. Set an element name and other properties as prompted.

To add a relationship, click on the required icon, then click on the start element in the diagram and drag to the end element.

### 4.5.5.19 Requirement Group

As an analysis step, often it is desirable to capture simple system *requirements*. These are eventually realized by Use Cases.

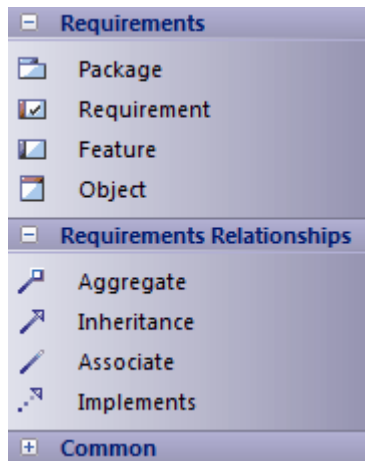

A [Package](#)<sup>[825]</sup> is a namespace as well as an element that can be contained in other package's namespaces.

Specify the [Requirement](#)<sup>[846]</sup> of a system. Note that there are a few different requirement types, such as.

- Display
- Functional
- Performance
- Printing
- Report
- Testing
- Validate.

A [Feature](#)<sup>[840]</sup> is a small client-valued function expressed as a requirement. Features are the primary requirements-gathering artifact of the *Feature-Driven Design* (FDD) methodology.

An [Object](#)<sup>[823]</sup> is an instance of a Class.

To add an element to the current diagram, click on the required icon, and drag it into position on the diagram. Set an element name and other properties as prompted.

To add a relationship, click on the required icon, then click on the start element in the diagram and drag to the end element.

### 4.5.5.20 Maintenance Group

The [Maintenance](#)<sup>[1568]</sup> elements are defects, changes, issues and tasks.

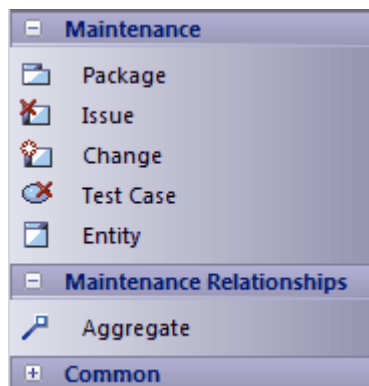

A [Package](#)<sup>[825]</sup> is a namespace as well as an element that can be contained in other package's namespaces.

An *Issue* element is a structured comment that contains information about [defects and issues](#)<sup>[1563]</sup> relating to the system/model. Affected elements are connected by [Trace](#)<sup>[892]</sup> connectors.

A [Change](#)<sup>[1563]</sup> element is a structured comment that contains information about changes requested to the system/model. Affected elements are connected by [Trace](#)<sup>[892]</sup> connectors.

A [Test Case](#)<sup>[848]</sup> describes what must be set up in order to test a particular feature.

An *Entity* is a stereotyped element that represents any general thing not captured by the element or Class type elements (for example a trading partner). Use of this element is **deprecated**: it was originally intended to take the role now occupied by a [Table](#)<sup>[849]</sup> element.

To add an element to the current diagram, click on the required icon, and drag it into position on the diagram. Set an element name and other properties as prompted.

To add a relationship, click on the required icon, then click on the start element in the diagram and drag to the end element.

### 4.5.5.21 User Interface Group

The **User Interface** group enables you to create graphical user interface diagrams.

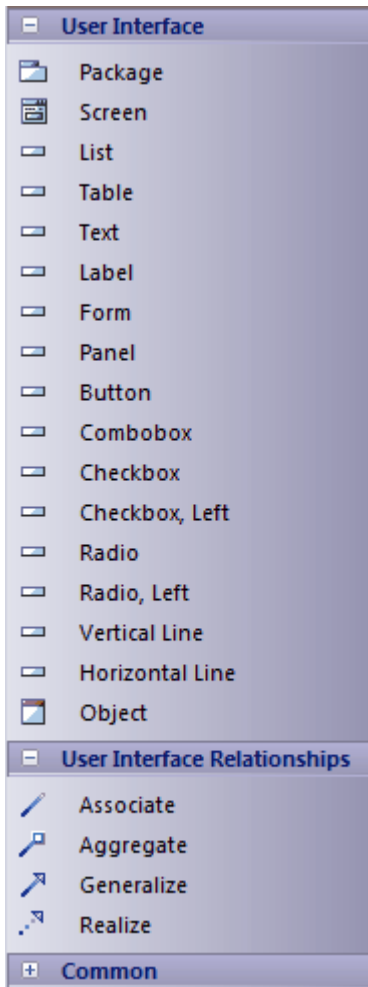

A [Package](#)<sup>[825]</sup> is a namespace as well as an element that can be contained in other packages' namespaces.

A [Screen](#)<sup>[847]</sup> element represents a graphical user interface. You can place GUI elements onto the screen element.

[UI Control](#)<sup>[849]</sup> elements are placed onto the screen element to build up a graphical user interface diagram. There are different stereotyped elements such as buttons and combo boxes.

An [Object](#)<sup>[823]</sup> is an instance of a Class.

To add an element to the current diagram, click on the required icon, and drag it into position on the diagram. Set an element name and other properties as prompted.

To add a relationship, click on the required icon, then click on the start element in the diagram and drag to the end element.

The following diagram illustrates the GUI elements from the **Toolbox**, within a Screen element.

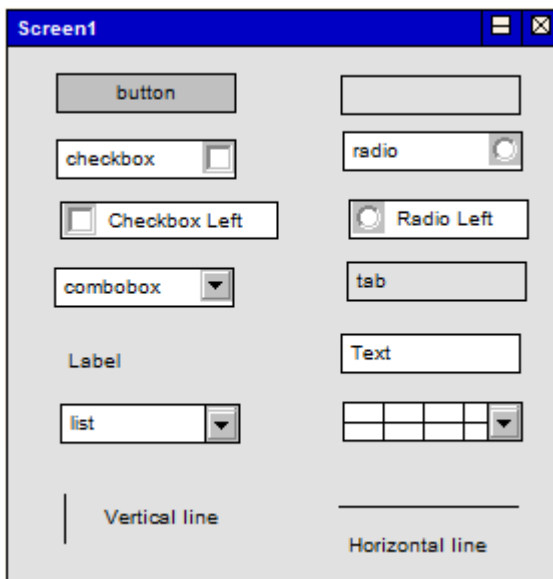

### 4.5.5.22 WSDL Group

The **WSDL** group gives you the ability to rapidly [model](#) and automatically [generate](#) W3C Web Service Definition Language (WSDL) documents.

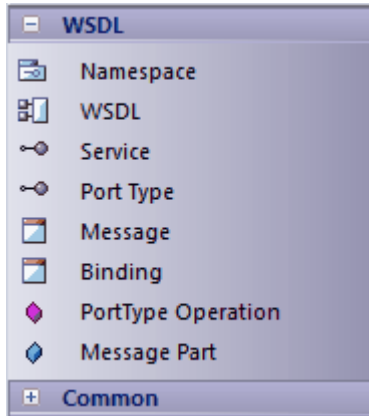

A [Namespace](#) represents the top-level container for the WSDL model. Drag this element onto an open diagram to create the necessary model structure for WSDL documents.

A physical [WSDL document](#) is represented as a UML component. Its interfaces represent the [WSDL services](#).

A WSDL [Port Type](#) is modeled as a UML interface. Its [Port Type Operations](#) are realized by [Binding](#) elements. Each of the operation parameters is derived from the Message elements defined in the [Messages](#) package.

To add an element to the current diagram, click on the required icon and drag it into position on the diagram. Set an element name and other properties as prompted.

To add a relationship, click on the required icon, click on the start element in the diagram and drag to the end element.

### 4.5.5.23 XML Schema Group

The **XML Schema** group provides the ability to [model](#) and automatically [generate](#) W3C XSD schema files. This group implements the constructs provided by the [UML profile for XML Schema](#).

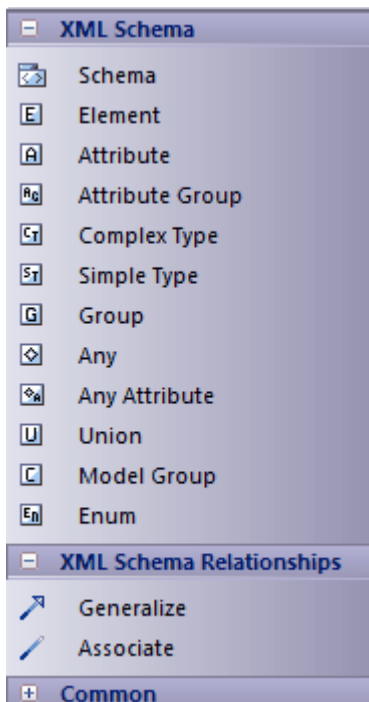

A *Schema* corresponds to a UML package, which contains the type and element definitions for a particular *targetNamespace*. Drag this item onto an open diagram to create the package to contain your schema model elements. The package is stereotyped as *XSDschema*.

Open the logical diagram created under the XSDschema package and add additional schema elements as required.

To add an element to the current diagram, click on the required icon and drag it into position on the diagram. Set the name and other properties as prompted.

To add a relationship, click on the required icon, then click on the start element in the diagram and drag to the end element.



#### 4.5.5.24 Data Modeling Group

This group is used for [database modeling](#) <sup>[1011]</sup> and database design, in conjunction with the *UML Data Modeling Profile*.

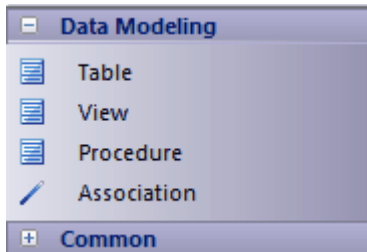

The [Table](#) <sup>[849]</sup> element defines a table on the data model.

The *View* element represents [database views](#) <sup>[1032]</sup> in the data model.

The *Procedure* element represents [stored procedures](#) <sup>[1030]</sup> in the data model.

To add an element to the current diagram, click on the required icon and drag it into position on the diagram. Set an element name and other properties as prompted.

To add a relationship, click on the required icon, click on the start element in the diagram and drag to the end element.

#### 4.5.6 Diagram Tasks

This topic describes many of the common tasks associated with managing diagrams.

##### Note:

In the Corporate, Business and Software Engineering, Systems Engineering and Ultimate editions of Enterprise Architect, if security is enabled you must have [Update Element](#) <sup>[198]</sup> permission to update or delete items on a diagram, and [Manage Diagram](#) permission to create, copy or delete diagrams.

- [Add New Diagrams](#) <sup>[422]</sup>
- [Set Diagram Properties](#) <sup>[423]</sup>
- [Add Elements and Connectors From Toolbox](#) <sup>[399]</sup>
- [Paste from the Project Browser](#) <sup>[430]</sup>
- [Copy And Paste Diagram Element](#) <sup>[433]</sup>
- [Place Related Elements on Current Diagram](#) <sup>[433]</sup>
- [Delete a Diagram](#) <sup>[434]</sup>
- [Rename a Diagram](#) <sup>[434]</sup>
- [Change Diagram Type](#) <sup>[434]</sup>
- [Diagram Navigation Hotkeys](#) <sup>[435]</sup>
- [Copy Image to Disk](#) <sup>[435]</sup>
- [Copy Image to Clipboard](#) <sup>[436]</sup>
- [Duplicate a Diagram](#) <sup>[436]</sup>
- [Z Order Elements](#) <sup>[437]</sup>
- [Set Default Diagram](#) <sup>[437]</sup>
- [Open a Package](#) <sup>[438]</sup>
- [Feature Visibility](#) <sup>[438]</sup>
- [Insert Diagram Properties Note](#) <sup>[440]</sup>
- [Manage Legend Elements](#) <sup>[441]</sup>
- [Autosize Elements](#) <sup>[444]</sup>
- [Swimlanes](#) <sup>[450]</sup>
- [Swimlanes Matrix](#) <sup>[444]</sup>
- [Using the Image Manager](#) <sup>[447]</sup>
- [Show Realized Interfaces for a Class](#) <sup>[452]</sup>
- [Label Menu Section](#) <sup>[452]</sup>
- [Pan and Zoom a Diagram](#) <sup>[453]</sup>
- [Move Diagram Sections](#) <sup>[454]</sup>
- [View Last and Next Diagram](#) <sup>[455]</sup>
- [Set Diagram Page Size](#) <sup>[455]</sup>
- [Scale Image to Page Size](#) <sup>[456]</sup>

- [Lock Diagram](#)<sup>[457]</sup>
- [Lay Out a Diagram](#)<sup>[467]</sup>
- [Undo Last Action](#)<sup>[458]</sup>
- [Redo Last Action](#)<sup>[458]</sup>
- [Present Diagrams in a Model Views Slideshow](#)<sup>[1228]</sup>

#### 4.5.6.1 Add New Diagrams

This topic explains how to add a UML diagram, Extended diagram or MDG Technology diagram to a model in Enterprise Architect.

##### Note:

In the Corporate, Business and Software Engineering, Systems Engineering and Ultimate editions of Enterprise Architect, if security is enabled you must have [Manage Diagrams](#)<sup>[198]</sup> permission to create new diagrams.

To add a new diagram to an existing package or element, follow the steps below:

1. In the **Project Browser**, select the appropriate package or element under which to place the diagram.
2. Do one of the following:
  - In the **Project Browser** toolbar click on the **New Diagram** icon
  - Right-click to open the context menu and select the **Add | Add Diagram** or **Add | Add <type> Diagram** menu option
  - Press **[Insert]** and select the **Add | Add Diagram** or **Add | Add <type> Diagram** menu option, or
  - Select the **Project | Add Diagram** menu option.

The **New Diagram** dialog displays.

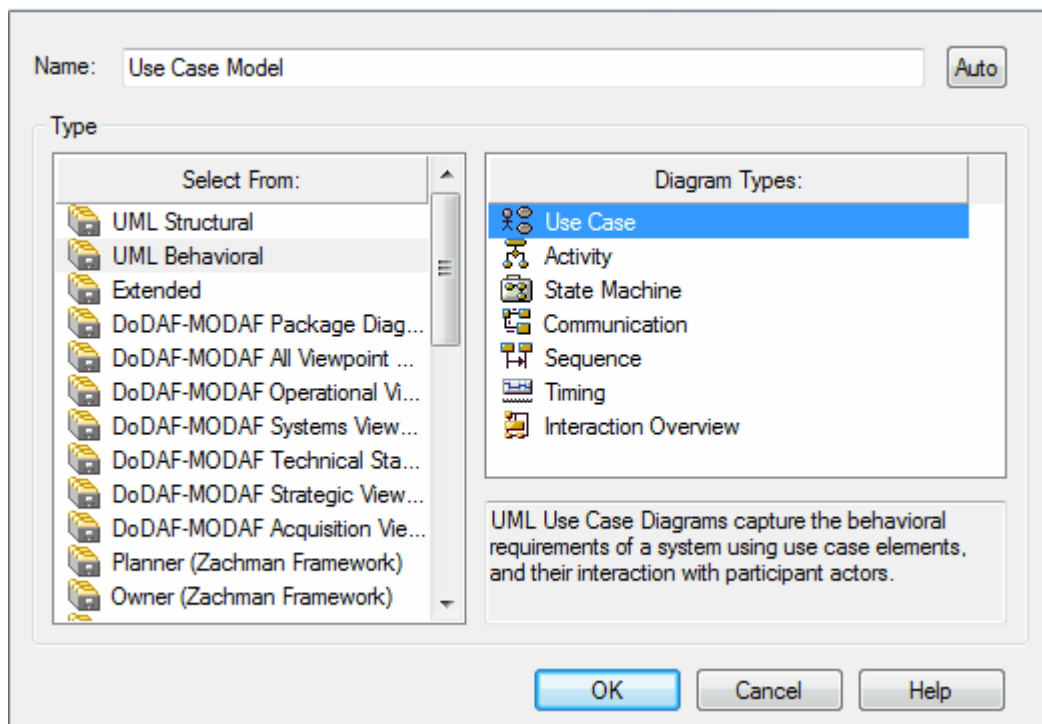

3. The **Name** field defaults to the name of the selected package or element; if necessary, type a different name for the new diagram.
4. In the **Select From** panel, click on the appropriate [diagram category](#)<sup>[673]</sup> for the diagram. The **Diagram Types** panel displays a list of the diagram types within the selected category.
5. In the **Diagram Types** panel, click on the type of diagram to create.
6. Click on the **OK** button to create your new diagram.

**Note:**

The diagram type determines the default toolbar associated with the diagram and whether it can be set as a child of another element in the **Project Browser** (for example, a Sequence diagram under a Use Case).

**4.5.6.2 Diagram Properties**

You can set several properties of a diagram using the diagram **Properties** dialog. Some properties influence the display and some are logical attributes that appear in the documentation.

**Note:**

- In the Corporate, Business and Software Engineering, Systems Engineering and Ultimate editions of Enterprise Architect, if security is enabled you must have [Update Diagrams](#)<sup>[198]</sup> permission to change diagram properties.
- You can also set the default diagram background color and the element fill color on the [Standard Colors](#)<sup>[353]</sup> page of the **Options** dialog. You can set color gradients for both diagram background and element fill color on the [Diagram Appearance](#)<sup>[356]</sup> page of the dialog..

There are several options for opening the diagram **Properties** dialog for a given diagram:

- Select the **Diagram | Properties** menu option to open the **Properties** dialog for the currently active diagram
- Right-click on the required diagram in the **Project Browser** and select the **Properties** context menu option
- Right-click on the background of the open diagram and select the **Properties** context menu option
- Double-click in the background of the open diagram.

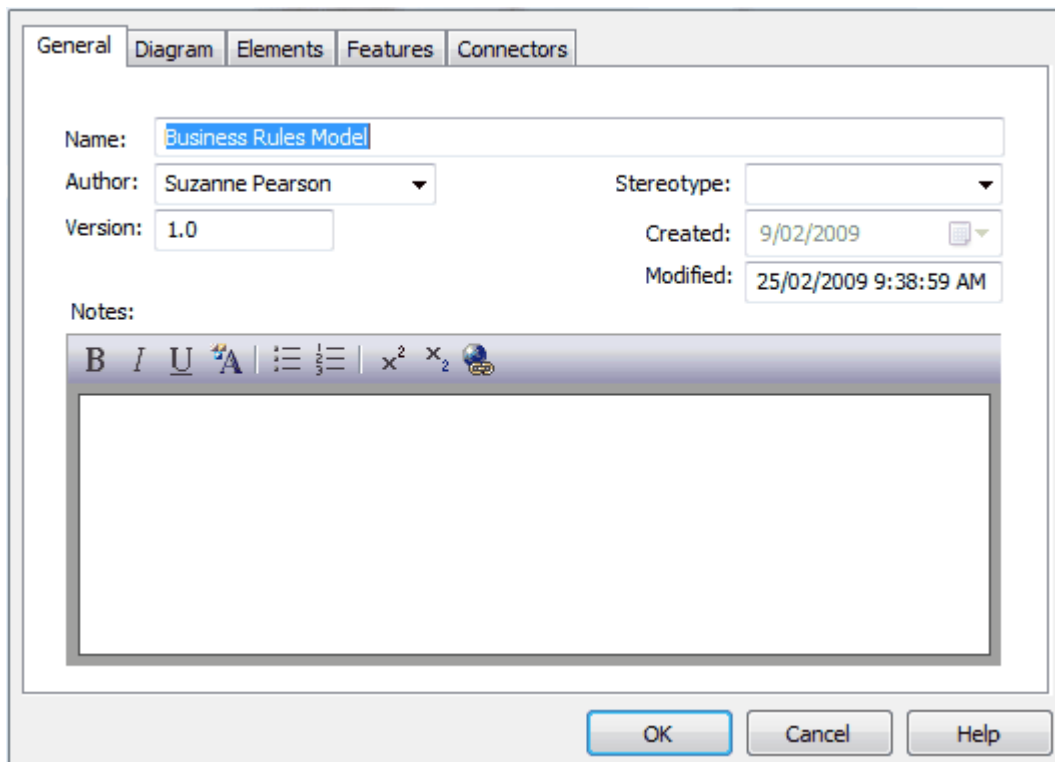

In the **Diagram Properties** dialog you can set properties including name, author and version information, zoom factor, paper size and layout, diagram notes and various appearance attributes. Once you have made any necessary changes, click on the **OK** button to save and exit.

See the following topics:

- [General Tab](#)<sup>[424]</sup>
- [Diagram Tab](#)<sup>[425]</sup>
- [Elements Tab](#)<sup>[426]</sup>

- [Features Tab](#)<sup>[427]</sup>
- [Connectors Tab](#)<sup>[428]</sup>

#### 4.5.6.2.1 General Tab

The **General** tab of the diagram **Properties** dialog enables you to define characteristics of the overall diagram, such as its title, version and modification date.

##### Note:

In the Corporate, Business and Software Engineering, Systems Engineering and Ultimate editions of Enterprise Architect, if security is enabled you must have [Update Diagrams](#)<sup>[198]</sup> permission to update diagram properties.

The screenshot shows the 'General' tab of the 'Properties' dialog for a diagram. The 'Name' field contains 'Business Rules Model'. The 'Author' dropdown is set to 'Suzanne Pearson'. The 'Version' field contains '1.0'. The 'Stereotype' dropdown is empty. The 'Created' field shows '9/02/2009' and the 'Modified' field shows '25/02/2009 9:38:59 AM'. Below these fields is a 'Notes' section with a rich text editor toolbar containing icons for Bold (B), Italic (I), Underline (U), Text Color (A), Bulleted List, Numbered List, Indent, Outdent, Text Color, and a globe icon. The dialog has 'OK', 'Cancel', and 'Help' buttons at the bottom.

Field	Use to
<b>Name</b>	Type the name of the diagram (defaults to the name of the parent package).
<b>Author</b>	Type or select the name of the person who owns the diagram (defaults to the name of the person who created the diagram).
<b>Version</b>	Type the version number of the diagram (defaults to 1.0).
<b>Stereotype</b>	Type or select the name of the stereotype for the diagram. You can define stereotypes to select here using the <b>Settings   UML</b> menu option, selecting the <a href="#">Stereotypes</a> <sup>[1093]</sup> tab and creating stereotypes with a <b>Base Class</b> of <b>Diagram</b> .
<b>Created</b>	Automatically display the date the diagram was created.
<b>Modified</b>	Type the date and time on which the diagram was last modified (defaults to the current date and time).
<b>Notes</b>	Type any additional notes about the diagram. You can format the notes using the <a href="#">Notes</a> <sup>[642]</sup> toolbar at the top of the field.

4.5.6.2.2 Diagram Tab

The **Diagram** tab of the diagram **Properties** dialog enables you to define the representation of the diagram.

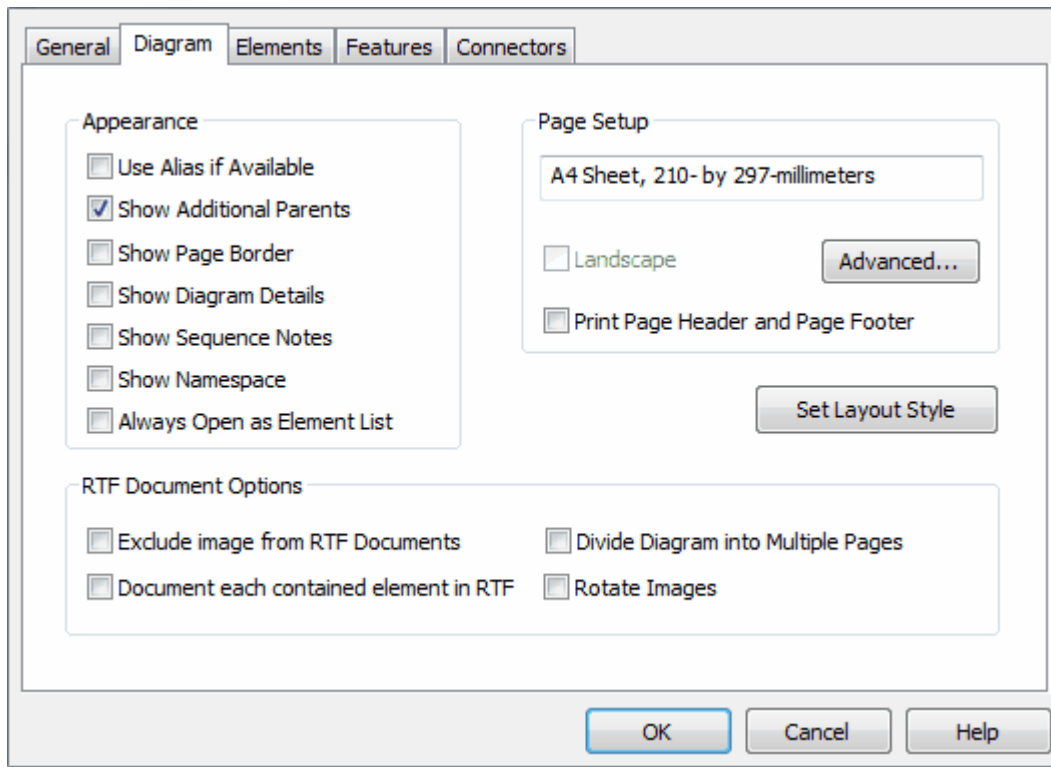

Field	Use to
<b>Use Alias if Available</b>	Display the element alias as the name if the alias is specified.
<b>Show Additional Parents</b>	Show the name of all parents not in the current diagram for all Classes and interfaces.
<b>Show Page Border</b>	Show a page border to align elements with.
<b>Show Diagram Details</b>	Show diagram details in a note in the top left corner of the diagram. (Deselect to hide the diagram details.)
<b>Show Sequence Notes</b>	Show the Sequence Notes on the current diagram.
<b>Show Namespace</b>	Show the namespace of each element on the diagram, under the element; that is, <i>PackageName::ElementName</i> .
<b>Always Open as Element List</b>	Always display the diagram contents as an <a href="#">Element List</a> <sup>[125b]</sup> rather than as a diagram.
<b>Page Setup</b>	See <a href="#">Scale Image to Page Size</a> <sup>[456]</sup> .
<b>Print Page Header and Page Footer</b>	Add page headers and footers to a print-out of the diagram. The headers and footers are generated from the diagram characteristics, such as the name of the creator and the date of modification.
<b>RTF Document Options</b>	<a href="#">Options</a> <sup>[157]</sup> for generating RTF reports for a particular diagram.
<b>Exclude image from RTF documents</b>	Exclude this diagram image from any RTF document generated on the parent package or element.
<b>Document each contained</b>	Include documentation on each element in the diagram, in any RTF

Field	Use to
element in RTF	document generated on the parent package or element. See also the <a href="#">Generate RTF Documentation</a> <sup>[157]</sup> dialog.
Divide Diagram into Multiple Pages	Divide each large diagram into separate pages in the RTF document. <b>Note:</b> This option is only effective when the <a href="#">Scaled Printing option</a> <sup>[456]</sup> is set to <b>None</b> on the <a href="#">Print Advanced</a> dialog.
Rotate Images	Rotate each diagram image by 90 degrees in the RTF document. <b>Note:</b> Only valid for bitmap (.bmp) images.

#### 4.5.6.2.3 Elements Tab

The **Elements** tab of the diagram **Properties** dialog enables you to define what components of the elements should be displayed on the diagram.

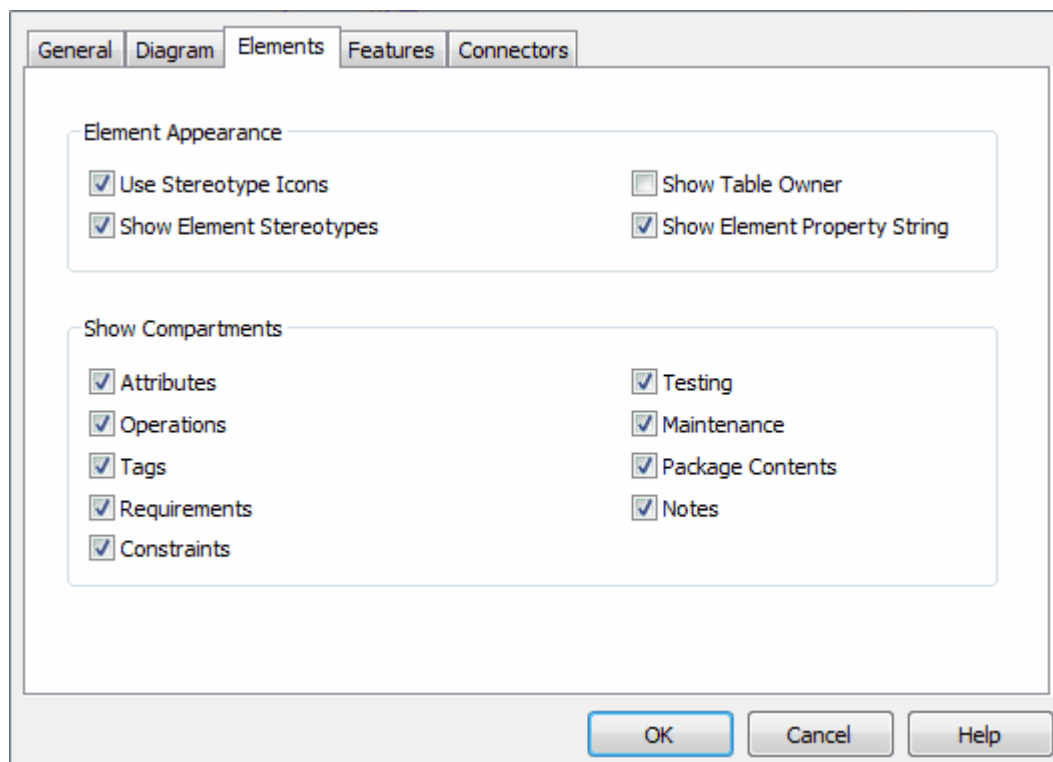

Field	Use to
Use Stereotype Icons	For elements that have whole shapes drawn by Enterprise Architect (such as <a href="#">Analysis stereotypes</a> <sup>[835]</sup> ), draw the alternative shape (if defined). For elements that have an icon displayed in the top right corner, (such as an <a href="#">Artifact</a> <sup>[810]</sup> element) if <b>Show Element Stereotypes</b> is selected, display the stereotype icon instead of the stereotype text.
Show Element Stereotypes	For elements that have whole shapes drawn by Enterprise Architect, if <b>Use Stereotype Icons</b> is deselected, display any stereotype on the element.

Field	Use to
	For elements that have an icon displayed in the top right corner, indicate that a stereotype is present (icon if <b>Use Stereotype Icons</b> is selected, text if not).
<b>Show Table Owner</b>	Display the Table Owner. For more information, see the <a href="#">Set Table Owner</a> <sup>[1016]</sup> topic.
<b>Show Element Property String</b>	Show the advanced property string for all elements; for example, {leaf}.
<b>Show Compartments</b>	Enable the following compartments to be shown or hidden for any element using rectangle notation: <ul style="list-style-type: none"> <li>• Attributes</li> <li>• Operations</li> <li>• Tags (Tagged Values)</li> <li>• Requirements</li> <li>• Constraints</li> <li>• Testing (<a href="#">Testing Scripts</a> <sup>[1549]</sup>)</li> <li>• Maintenance (<a href="#">Maintenance Scripts</a> <sup>[1561]</sup>)</li> <li>• Package Contents</li> <li>• Notes.</li> </ul>

#### 4.5.6.2.4 Features Tab

The **Features** tab of the diagram **Properties** dialog enables you to define how features (attributes and operations) are displayed on the diagram.

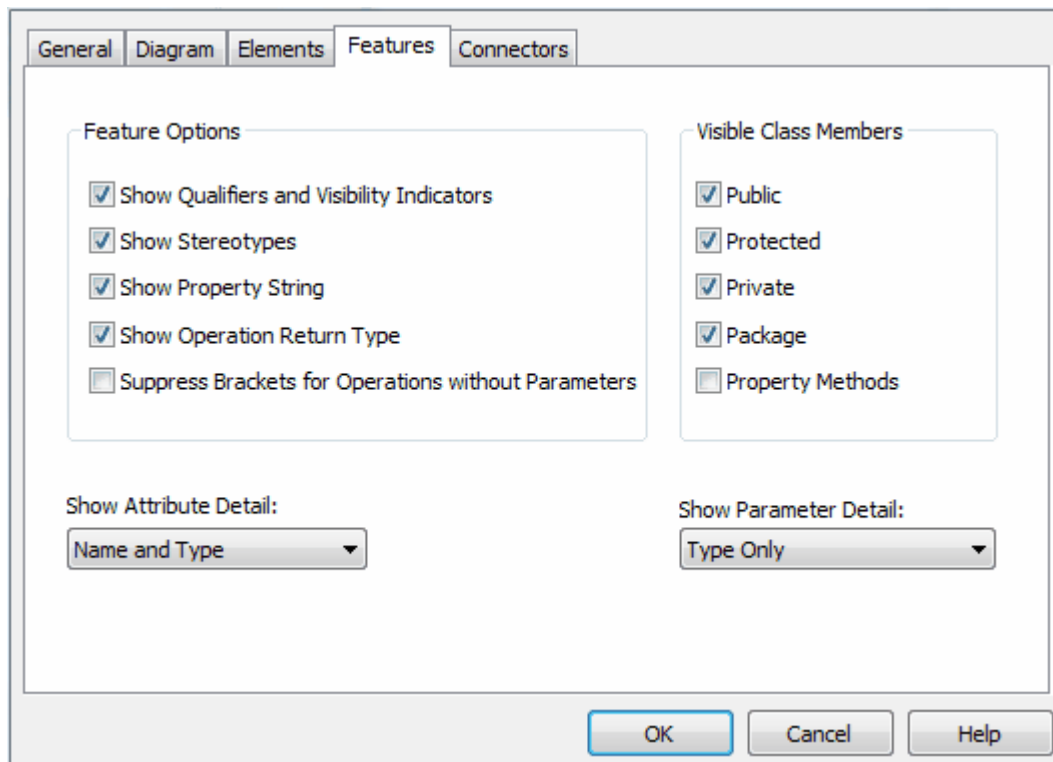

Field	Use to
<b>Show Qualifiers and Visibility</b>	Show or hide the qualifiers and visibility indicators on the diagram.

Field	Use to
<b>Indicators</b>	<i>Qualifiers</i> include such things as the 'derived' symbol ( <i>/</i> ) and the public key symbol ( <b>PK</b> ). <a href="#">Visibility indicators</a> <sup>[1282]</sup> include such things as +, -, # and ~, which indicate the scope of access of the item (such as an attribute, operation or role).
<b>Show Stereotypes</b>	Show the stereotypes on all features.
<b>Show Property String</b>	Show the advanced property string for all element features, for example, {readOnly}.
<b>Show Operation Return Type</b>	Display the return data type of operations.
<b>Suppress Brackets for Operations Without Parameters</b>	Suppress brackets on operations that have no parameters; that is, <b>Opn</b> ; rather than <b>Opn()</b> ;
<b>Visible Class Members</b>	Hide Class members according to their scope and methods that specify properties. See the <a href="#">Visible Class Members</a> <sup>[429]</sup> topic.
<b>Show Attribute Detail</b>	Select whether to show both the attribute name and type or the attribute name only.
<b>Show Parameter Detail</b>	Control the display of method parameters. See the <a href="#">Visible Class Members</a> <sup>[429]</sup> topic.

#### 4.5.6.2.5 Connectors Tab

The **Connectors** tab of the diagram **Properties** dialog enables you to define the appearance of the connectors on the diagram.

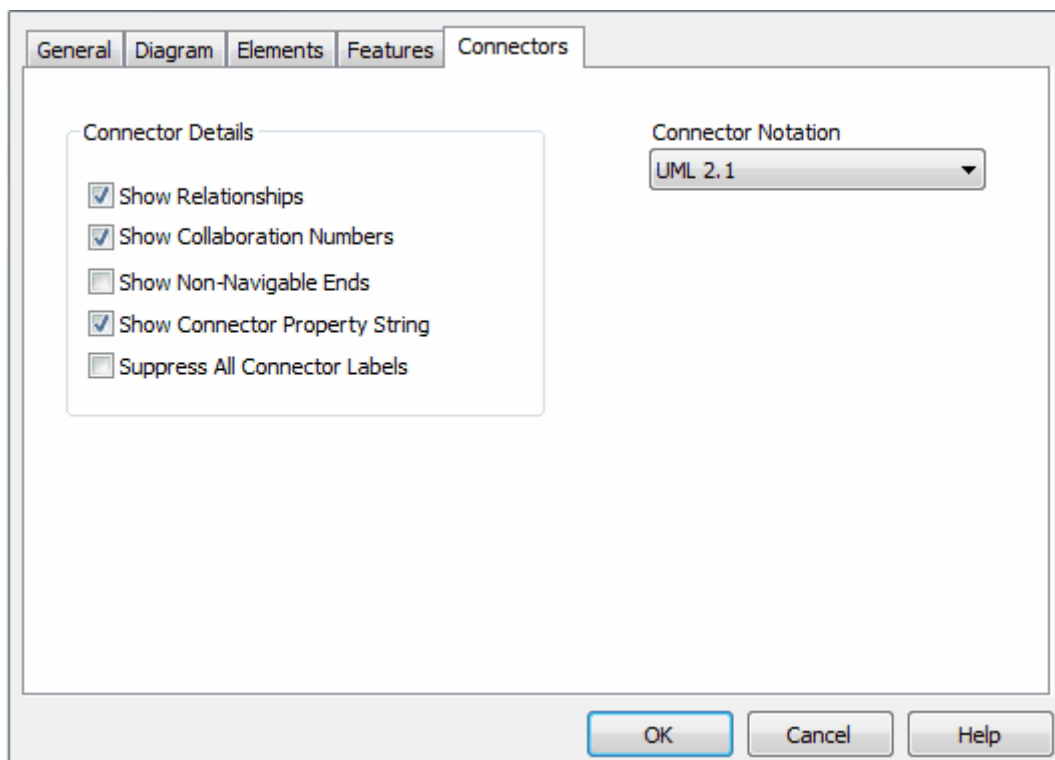



Field	Use to
Show Relationships	Show relationships in the current diagram.
Show Collaboration Numbers	Show numbering in Communication diagrams.
Show Non-Navigable Ends	Indicate when an Association end is not navigable; a cross is presented at the Association connector.
Show Connector Property String	Show the property string for connectors.
Suppress All Connector Labels	Hide all connector labels.
Connector Notation	Display the required connector notation: <ul style="list-style-type: none"> <li>• <b>UML 2.1</b> - use the standard UML 2.1 notation for connectors</li> <li>• <b>Information Engineering</b> - use the Information Engineering (IE) connection style; for more information see the <a href="http://www.agiledata.org/essays/dataModeling101">http://www.agiledata.org/essays/dataModeling101</a> page</li> <li>• <b>IDEFX1</b> - use the Integrated Definition Methods IDEFX1 connection style; for more information see the <a href="http://www.idef.com/IDEF1X.html">http://www.idef.com/IDEF1X.html</a> page.</li> </ul>

#### 4.5.6.2.6 Visible Class Members

On the **Features** tab of the diagram **Properties** dialog, the **Visible Class Members** panel enables you to hide Class members by their scope and methods that specify properties. Use the checkboxes to define the visibility of Class members.

Visible Class Members

Public

Protected

Private

Package

Property Methods

Show Parameter Detail:

Type Only ▾

#### Show Parameter Detail

The **Show Parameter Detail** field enables you to control the display of method parameters with the following options:

Option	Effect
None	No details shown.
Type Only	Shows the type of parameter only.
Full Details	Shows all of the details for parameters.
Name Only	Shows the name of the parameter only.

### 4.5.6.3 Paste from Project Browser

As well as creating new elements in a diagram, you can drag existing elements from the **Project Browser** into the current diagram.

When you drag an existing element into the diagram, the **Paste Element** dialog displays to prompt you to select the type of paste action to carry out. (If the dialog does not display, press and hold **[Ctrl]** while dragging the element onto the diagram.)

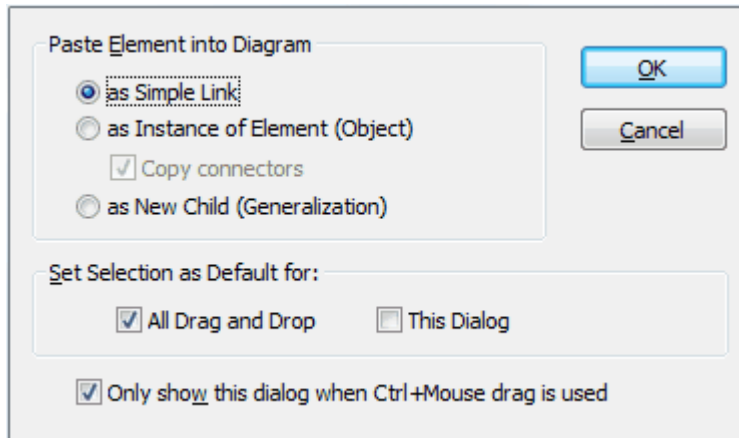

Three paste options are available:

1. Paste the element as a simple link. In this case the original element exists both in the current diagram and in the original source diagram. Changes to the element are reflected in all diagrams in which it is shown.
2. Paste as an [instance](#)<sup>[519]</sup> of the element. If the element can have instances such as an Object, Sequence instance or Node instance, you can drop the element in as an instance of the source element, with the classifier pre-set to the original source. This is useful when creating multiple instances of a Class in a Sequence diagram or Communication diagram.

If you select this option, the **Copy connectors** checkbox is enabled. If you select this checkbox, any connectors between the original element and any other elements that have also been pasted to this diagram are reproduced as connectors between the instances.

3. Create as a child of the source element. This automatically creates a new Class - which you are prompted to name - with a Generalization connector back to the source. This is very useful when you have a Class library or framework from which you inherit new forms; for example, you can paste a Hashtable as "MyHashtable" which automatically becomes a child of the original Hashtable. Used with the [Override parent operations](#)<sup>[578]</sup> feature, this is a quick way to create new structures based on frameworks such as the Java SDK and the .NET SDK.

You can make your selection on this dialog the default for:

- all drag and drop operations, or
- only those where you display this **Paste Element** dialog.

If you select the **This Dialog** checkbox, you should then select the **Only show this dialog when [Ctrl]+Mouse drag is used** checkbox and, on the [Diagram Behavior](#)<sup>[359]</sup> page of the **Options** dialog, the **Auto Instance** checkbox.

The effect of these selections is to give you two default paste options:

- Just drag the element onto the diagram and automatically create an instance
- Press **[Ctrl]** while you drag the element from the **Project Browser**, displaying the **Paste Element** dialog, and click on the **OK** button to automatically paste the element according to whatever option you last selected from the dialog.

If you select the **All Drag and Drop** checkbox on the **Paste Element** dialog, this deselects the **Auto Instance** checkbox on the **Options** dialog and enables you to add existing elements to the diagram according to the paste option you selected, without pressing **[Ctrl]** and without displaying a dialog. (If you want to change the default paste option, press **[Ctrl]** as you drag to display the dialog again and make your changes.)

**See Also**

- [Connect Requirements](#)<sup>[921]</sup>
- [Create Object From Attribute](#)<sup>[568]</sup>
- [Make Linked Element A Local Copy](#)<sup>[544]</sup>

**4.5.6.3.1 Paste Multiple Items**

You can paste multiple elements from the **Project Browser** into the current diagram.

To select multiple elements, click on the selected items from the **Project Browser** while pressing and holding:

- **[Ctrl]** to add single items to the selection of multiple elements, or
- **[Shift]** to select all the elements between the first and last selected items in the **Project Browser**.

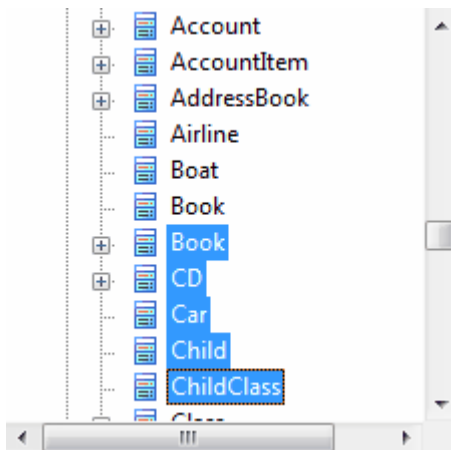

You can then drag the selected elements from the **Project Browser** onto the current diagram, pressing and holding **[Ctrl]**; for each element you have selected, the **Paste Element** dialog displays, prompting you to [select the type of paste action](#)<sup>[430]</sup> to carry out.

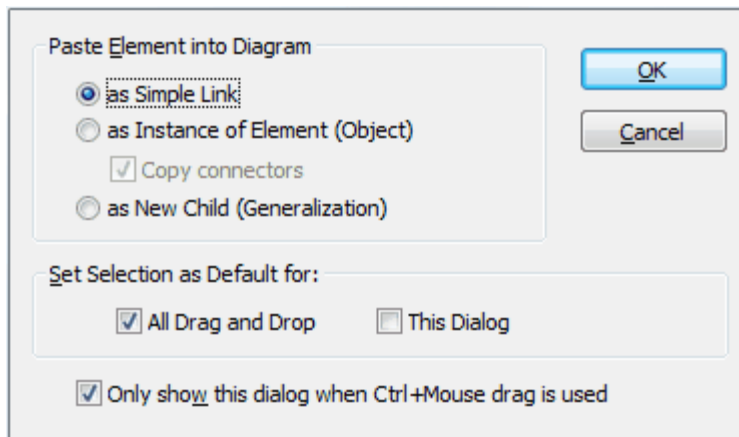
**4.5.6.3.2 Paste Composite Elements**

When you drag a Composite element from the **Project Browser** onto the current diagram, Enterprise Architect prompts you to select the type of paste action to carry out with the Composite element.

(If the dialog does not display, press and hold **[Ctrl]** while dragging the element onto the diagram.)

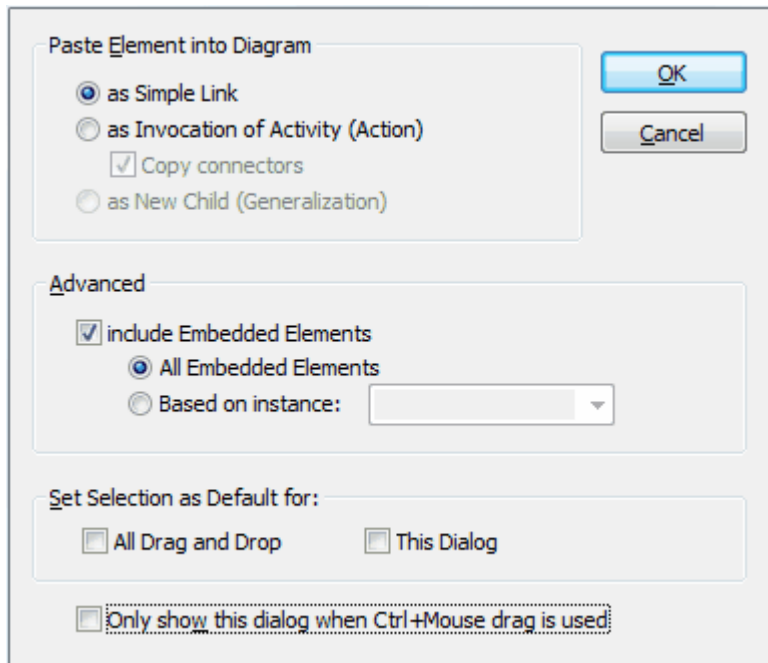

Two advanced options are available for pasting Composite elements; these require the **include Embedded Elements** checkbox to be selected:

1. The **All Embedded Elements** option, which pastes all of the Composite element's embedded elements.
2. The **Based on instance** option, which pastes only the elements contained in a specific instance of the Composite element, maintaining the layout of the embedded elements.

Click on the drop-down arrow and select the appropriate instance.

For details of the other options on this dialog, see the [Paste from Project Browser](#)<sup>[430]</sup> topic.

#### 4.5.6.3.3 Paste Activities

You can paste an [Activity](#)<sup>[753]</sup> from the **Project Browser** into the current diagram.

When you drag an Activity from the **Project Browser** onto the current diagram, The **Paste Element** dialog displays, prompting you to select the type of paste action to carry out. (If the dialog does not display, press and hold **[Ctrl]** while dragging the element onto the diagram.)

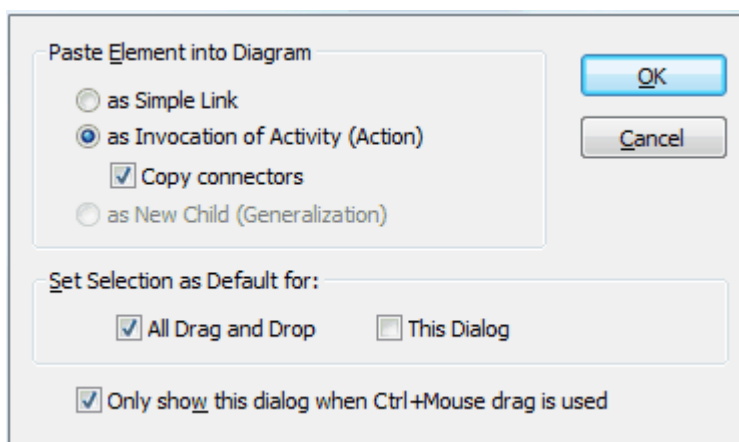

Two options are available:

- Paste the Activity as a link: in this case the Activity appears in the current diagram as a simple reference to the original source Activity. Changes to the Activity in the diagram affect all other links to this Activity.
- Paste as an invocation of the Activity; if you select this option, the **Copy connectors** checkbox is enabled.

If you select this checkbox, any connectors between the original Activity and any other elements that have also been pasted to this diagram are reproduced as connectors between the instances.

For details of the other options on this dialog, see the [Paste from Project Browser](#)<sup>430</sup> topic.

#### 4.5.6.4 Copy And Paste Diagram Element

To copy a diagram element, follow the steps below:

1. Select the element(s) to copy.
2. For multiple elements, right-click to open the context menu and select the **Copy** menu option. Alternatively, press **[Ctrl]+[C]**.
3. For single elements, select the **Edit | Copy** menu option or alternatively press **[Ctrl]+[C]**.

#### Paste Diagram Elements

To paste diagram elements, follow the steps below:

1. Open the diagram to paste into.
2. Right-click on the diagram background to open the diagram context menu.
3. Select either the **Paste Object(s) as New** menu option (completely new element) or the **Paste Object(s) as Link** menu option (reference to the existing element).

#### Note:

The *Date Created* and *Time Created* parameters of a pasted-as-new element are set to the current date and time; the parameters for a linked element remain the same as the copied element.

#### 4.5.6.5 Place Related Elements on Diagram

To find and place related elements on the current diagram, use the **Relationships** window (**View | Other Element Tools | Relationships**).

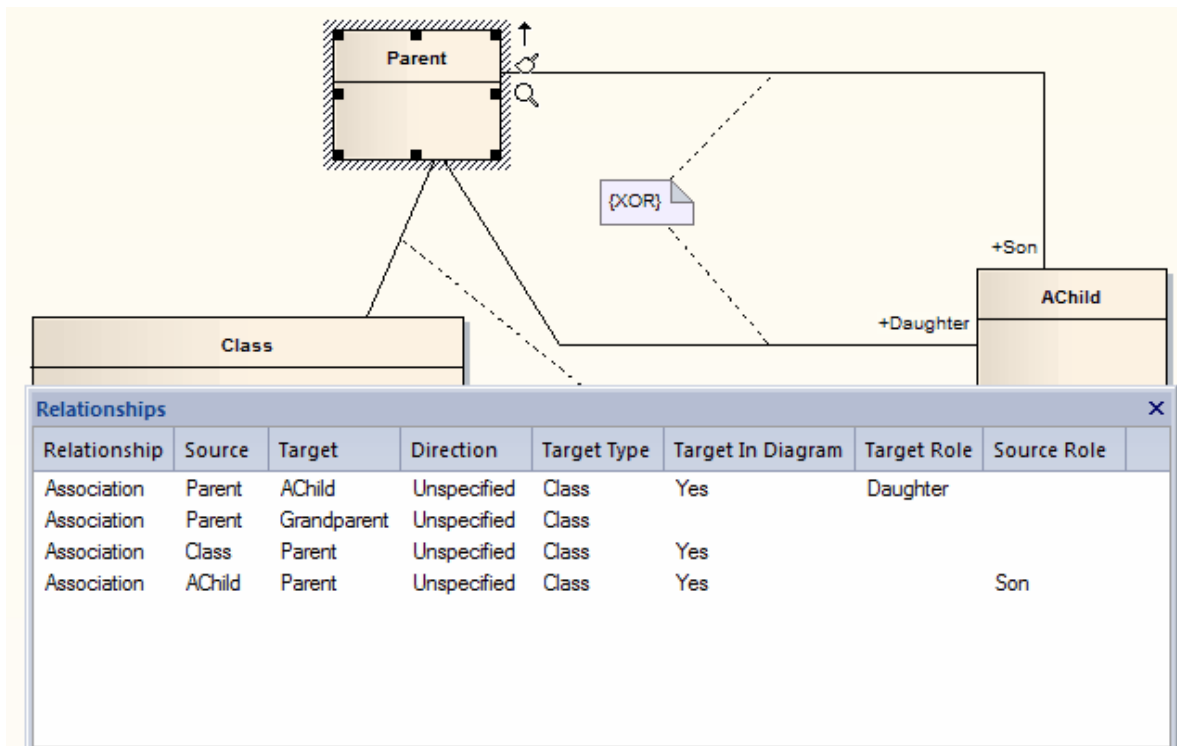

Right-click on any connector in the list to open the context menu.



If an element is not present in the current diagram, the context menu contains the **Place Target Element in Diagram** option. This is useful when you are building up a picture of what an element interacts with, especially when reverse engineering an existing code base.

Select the **Place Target Element in Diagram** option. Move the cursor to the required position in the diagram and click to place the element. Alternatively, press **[Esc]** to cancel the action.

#### 4.5.6.6 Delete Diagram

##### Warning:

In Enterprise Architect there is no *Undo* feature for deleting diagrams, so be certain that you want to delete a diagram before you do so.

##### Notes:

- When you delete a diagram, you do not delete the elements in the diagram from the *model*.
- In the Corporate, Business and Software Engineering, Systems Engineering and Ultimate editions of Enterprise Architect, if security is enabled you must have [Manage Diagrams](#) permission to create new diagrams.

To delete a diagram from your model, follow the steps below:

1. In the **Project Browser**, right-click on the diagram to delete. The context menu displays.
2. Select the **Delete '<diagram name>'** menu option. A confirmation prompt displays.
3. Click on the **OK** button to confirm the delete.

You can also delete multiple diagrams from the **Project Browser**, by holding **[Ctrl]** or **[Shift]** while you select them, then right-clicking on one of them and selecting the **Delete selected items** context menu option.

#### 4.5.6.7 Rename Diagram

To rename a diagram, follow the steps below:

1. Open the **Diagram Properties** dialog by double-clicking on the diagram background, or by selecting the **Diagram | Properties** menu option.
2. In the **Name** field on the **General** tab, type the new name for your diagram.
3. Click on the **OK** button to save changes.

#### 4.5.6.8 Change Diagram Type

If necessary, you can change one type of diagram to another type.

This is useful if you have either made a mistake in selecting the diagram type to begin with, or if the purpose and nature of a diagram changes during analysis.

##### Note:

Some diagram types do not transfer to others; for example you cannot change a Class diagram into a Sequence diagram.

To change a diagram type, follow the steps below:

1. Open the diagram to change.

2. Select the **Diagram | Change Type** menu option. The **Change Diagram Type** dialog displays.

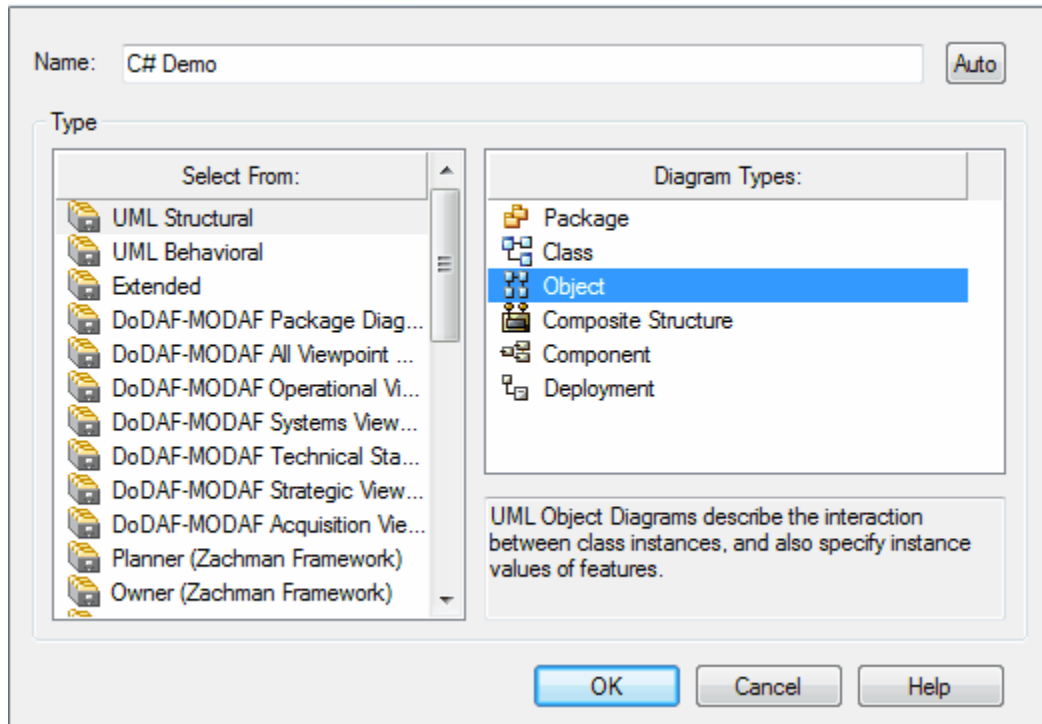

3. Select the required diagram type.
4. Click on the **OK** button to save changes.

#### 4.5.6.9 Diagram Navigation Hotkeys

The diagram hotkeys enable you to quickly navigate to and select elements within a diagram.

The following table details the key combinations and their functionality.

Hotkey Command	Use To
[Shift]+[Arrow], Element(s) selected	Move the selected element(s) by increments.
[Arrow], No element selected	Scroll around the diagram.
[Esc]	Clear the current selection.
[Tab]	Select the first element in the diagram if none currently selected.
[Shift]+click	Add the clicked element to the current selection.
[Ctrl]+click	Add the clicked element to the current selection.
[Ctrl]+[Shift]+drag	Pan the diagram.
[Alt]+[G]	Select the item in the <b>Project Browser</b> and give it focus.

#### 4.5.6.10 Copy Image to Disk

You can copy a diagram image to a disk file in the following formats:

- Windows bitmap (256 color bitmap)
- GIF image
- Windows Enhanced Metafile (standard metafile)
- Windows Placeable Metafile (older style metafile)

- PNG format
- JPG
- TGA.

To copy a diagram image to file, follow the steps below:

1. Open the diagram to save.
2. Select the **Diagram | Save Image** menu option, or press **[Ctrl]+[T]**.
3. When prompted, enter a name for the file and select an image format.
4. Click on the **OK** button.

**Note:**

Enterprise Architect clips the image size to the smallest bounding rectangle that encompasses all diagram elements.

#### 4.5.6.11 Copy Image to Clipboard

You can copy diagram images onto the MS Windows clipboard and paste them directly into MS Word or other applications.

To copy an image to the clipboard, follow the steps below:

1. Open the diagram to copy.
2. Select the **Diagram | Copy Image** menu option, or press **[Ctrl]+[B]**.
3. Click on the **OK** button.

The diagram has been copied to the clipboard and can now be pasted into compatible applications or into another diagram. You can set the clipboard format on the [Options](#)<sup>[35]</sup> dialog (**Tools | Options** menu option, **General** page). Enterprise Architect supports bitmap or metafile format.

#### 4.5.6.12 Copy (Duplicate) Diagram

Enterprise Architect makes it easy to duplicate a complete diagram, either with:

- Links back to the original diagram elements (*shallow mode*), or
- Complete copies of all elements in the diagram (*deep mode*).

**Note:**

In the Corporate, Business and Software Engineering, Systems Engineering and Ultimate editions of Enterprise Architect, if security is enabled you must have [Manage Diagrams](#)<sup>[198]</sup> permission to copy diagrams.

When you copy a diagram in shallow mode, the elements in the new diagram are linked to the originals, so if you change the properties of one, the other reflects those changes. If you copy the diagram in deep mode, then all elements are duplicated completely, so that changing an element on one does not affect the other.

Element position and size should be independent in both copy modes.

You can also paste a copied diagram as a child of a [composite](#)<sup>[837]</sup> element.

### Procedure

To duplicate a diagram, follow the steps below:

1. In the **Project Browser**, select the diagram to copy.
2. Right-click to display the context menu and select the **Copy Diagram** menu option.
3. Navigate to the package to host the new diagram, and right-click to open the context menu.
4. Select the **Paste Diagram** menu option. The **Copy Diagram** dialog displays.



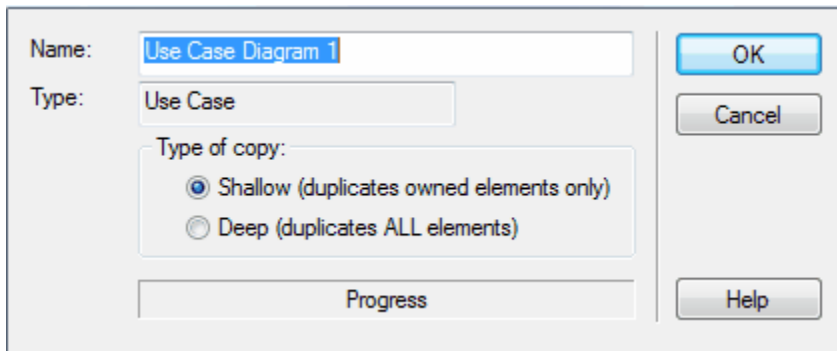

5. In the **Name** field, type the name for the new diagram.
6. In the **Type of copy** panel, click on the radio button for the type of copy you require; either linked elements (shallow copy) or complete copies of the originals (deep copy).
7. Click on the **OK** button.

Enterprise Architect automatically creates the new diagram, links or creates new elements and arranges them as in the original diagram. All links are also copied between diagram elements where appropriate.

#### 4.5.6.13 Z Order Elements

Z Order refers to an element's depth in the diagram perspective, and thus influences which elements appear in front of others and which appear behind.

To set the Z Order of an element, follow the steps below:

1. Right-click on the element in the **Diagram View**.
2. Select the **Z order** menu option. The following submenu displays:

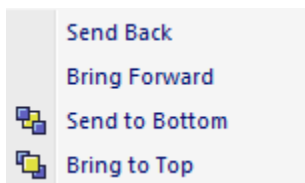

3. Select the operation to perform. The element is moved to the new position in the diagram perspective.

#### 4.5.6.14 Set the Default Diagram

A project might have a default diagram. If set, this diagram loads when Enterprise Architect first opens the model.

It is often convenient to place hyperlinks to other diagrams and resources on the default diagram, thus creating a Home Page for your model.

To set the currently active diagram as the model default, select the **Diagram | Make Model Default** <sup>65</sup> menu option. (Also use this option to cancel the default setting.)

##### Tip:

Once you have specified a default diagram, the **Home** icon on the **Diagram** toolbar takes you back to that diagram from your current location in the model.



#### 4.5.6.15 Open Package From Diagram

To open a package from within a diagram follow the steps below:

1. Open a diagram that shows the package to open.
2. Right-click on the package element to open the context menu.
3. Select the **Open Package** option. Alternatively, press **[Ctrl]+[K]**.

##### Note:

Enterprise Architect finds the package default diagram and opens it for you. This is the first available diagram in the package, selected in alphabetical order; for example, a diagram called *Alpha* in a child package or element several levels down opens before a diagram called *Beta* immediately under the selected package.

#### 4.5.6.16 Feature Visibility

Enterprise Architect enables you to set the visibility of attributes and operations - where shown - for selected elements on a specific diagram only.

You can hide or show attributes and operations by scope, or you can hide attributes and operations individually. The visibility you set applies only to the current diagram, so a Class can appear in one diagram with all features displayed, and in another with features hidden. For example, you can hide all protected attributes, all private operations or any other combination of attributes and operations.

It is possible to show inherited attributes, operations, requirements, constraints and Tagged Values for elements that support those features. When Enterprise Architect displays inherited features, it creates a merged list from all generalized parents and from all realized interfaces. If a child Class redefines something found in a parent, the parent feature is omitted from the Merge List.

##### Tip:

To show features for element types that do not have visible compartments, such as Use Cases and Actors, right-click on the diagram object to display the context menu and select the **Advanced Settings | Use Rectangle Notation** option.

### Customize Feature Visibility

To customize feature visibility, follow the steps below:

1. Either:
  - Click on the element in the diagram and either click on the **Element | Feature Visibility** menu option or press **[Ctrl]+[Shift]+[Y]**, or
  - Right-click on the element in the diagram to display the context menu and click on the **Feature Visibility** option.

The **Feature Visibility** dialog displays.

- To filter display of attributes or operations by scope, select the checkbox against each scope that should be visible and clear the checkbox against each scope that should not.

**Note:**

The **Show** checkbox, if selected, overrides these selections to display all attributes or operations in the element, except those specifically *deselected* in the [Show Features in Diagram](#) <sup>[44b]</sup> dialog (below).

- In the **Show Element Compartments** panel, select the compartments to display for the element on the diagram.

The **Fully Qualified Tags** checkbox enables you to display the full provenance of a Tagged Value, where the same Tagged Value can be used several times in different contexts with different values. The description in the Tagged Value compartment reads:

`<Profile>::<Stereotype>::<Tagged Value name>=<Value>` for example: `BPMN::Activity::Activity Type = Task`.

(Only for Tagged Values created in Enterprise Architect release 7.1 or later.)

If you select the **Notes** checkbox, the Notes compartment on the element in the diagram displays the text that has been typed into the **Notes** field of the **Element Properties** dialog. This checkbox also enables the **maximum chars** field, which defaults to 1000 as the number of characters of notes text displayed. Overtyping this value to display less text or more text.

The change only applies to the selected elements on the diagram, so you can display full notes for a selected element whilst the other elements on the diagram have no notes text.

**Note:**

If you have selected the **Notes** checkbox, you can select the **Render Formatted Notes** checkbox to display the text on the diagram, formatted using the [Notes](#) <sup>[642]</sup> toolbar.

- In the **When Resizing Elements** panel, select the appropriate option for resizing the Class, object or table to prevent very wide diagram objects.

The selected option defaults to **Resize to longest Feature**, so that the minimum width for a diagram object is determined by its longest displayed attribute, method or other compartment value. If necessary, you can change the option to **Wrap Features** (so that any longer features are wrapped onto multiple lines) or **Truncate Features** (so that longer features are not displayed in full).

5. If required, in the **Inherited Features** panel, select one or both checkboxes to set whether Enterprise Architect should display inherited features as well as directly owned ones.
6. Click on the **OK** button to save changes. Enterprise Architect redraws the diagram with the appropriate level of feature visibility.

### Suppress or Show Specific Features

The **Custom** button in the **Attribute Visibility** and **Operation Visibility** panels enables you to show or hide specific operations and attributes. If you select the **Show** checkbox, the **Custom** button displays the **Show Features in Diagram** dialog; if you deselect the checkbox, the button displays the **Suppress Features in Diagram** dialog.

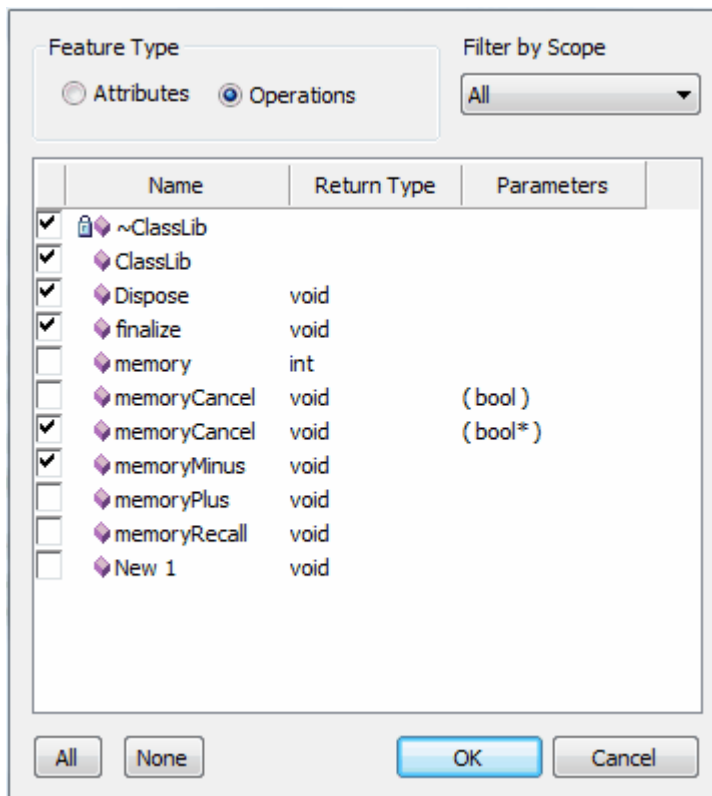

The two dialogs are identical, but in the first you select the checkboxes of specific features to show, and in the second you select the checkboxes of specific features to hide.

You can also use the **Filter by Scope** button in this dialog to, for example, list only operations that are Protected and select, say, two of them to hide, so that on the diagram the element displays all but two of the Protected operations and all operations of other scopes.

#### 4.5.6.17 Insert Diagram Properties Note

Properties of a diagram can be displayed on screen within a custom text box.

```
Name: UseCaseDiagram
Author: Frederick Walter
Version: 1.0
Created: 25/05/2007 12:00:00 AM
Updated: 1/05/2009 2:02:33 PM
```

You can move this text box around and change its [appearance](#)<sup>538</sup>. You cannot change what the text box

says.

To create the note, drag the *Diagram Notes* element from the **Common** page of the **Toolbox** onto the diagram.

Alternatively, select the **Diagram | Property Note** menu option, or click on the **Diagram Properties Note** button on the **UML Elements** toolbar and click on the diagram.



#### Note:

This is not the same as the diagram details note, which displays in the top left corner of the diagram if the **Show Diagram Details** checkbox is selected on the [Diagram Properties](#) dialog. You cannot move the diagram details, nor change the appearance. To hide the diagram details, deselect the checkbox.

### 4.5.6.18 Create Legends

A *Legend* shape identifies colors and styles you have used to group other elements on the diagram.

You can use the Legend to assist in distinguishing different elements, connectors or systems on the diagram. For example, the Legend could show that all elements concerned with the management system are shaded in blue, and all outcomes connectors are shown in red. The Legend displays as a key to the diagram, with the filled shape styles first and the lines and connector styles underneath.

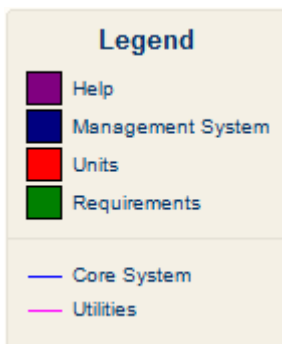

You add a Legend to the diagram, then edit it to add Legend elements, which define the colors and styles used in the diagram.

### Add a Legend

To add a Legend to a diagram, drag the *Diagram Legend* element from the **Common** page of the **Toolbox** onto the diagram (or click on the **New Diagram Legend** icon () on the **UML Elements** toolbar, and click on the diagram).

The **Legend** dialog displays.

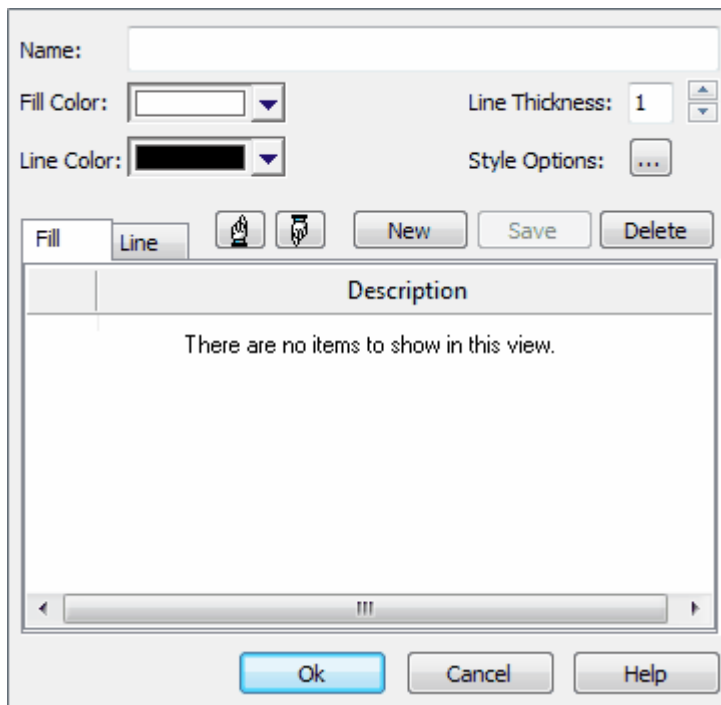

Click on the **OK** button. The Legend displays on the diagram as a simple rectangle.

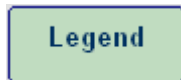

### Edit a Legend

To edit the Legend follow the steps below:

1. Either:
  - Double-click on the Legend, or
  - Right-click on the Legend and select the **Properties** context menu option.The **Legend** dialog displays.

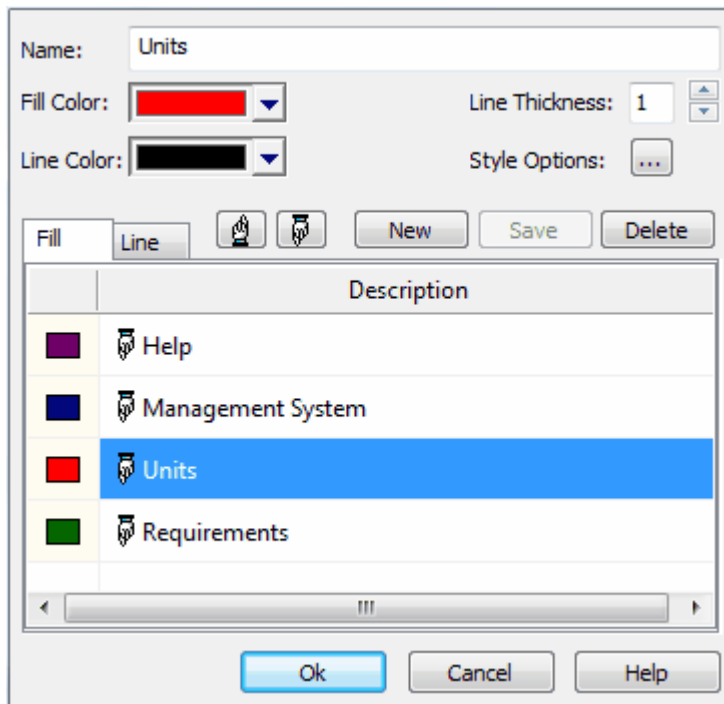
**Note:**

The **Legend** dialog enables you to add, delete, modify or re-sequence Legend elements. Use the **Fill** tab to define the Legend elements for shapes, then click on the **Line** tab to define Legend elements for lines and connectors.

2. In the **Name** field, type the name of the Legend element; for example, **Management System** or **Help**.
3. Use the drop-down arrows to select the fill color, line color and line thickness for the Legend element.
4. Click on the **Save** button to save the Legend element. The element displays in the **Fill** or **Line** tab, as appropriate.
5. Click on the **New** button to add another Legend element.

## Style Options

Click on the **Style Options** button [ ... ] to display the **Style Options** dialog, on which you can modify a Legend title, font size, background color and border color. If you choose default options for the colors, the Legend automatically assumes colors based on the diagram background color.

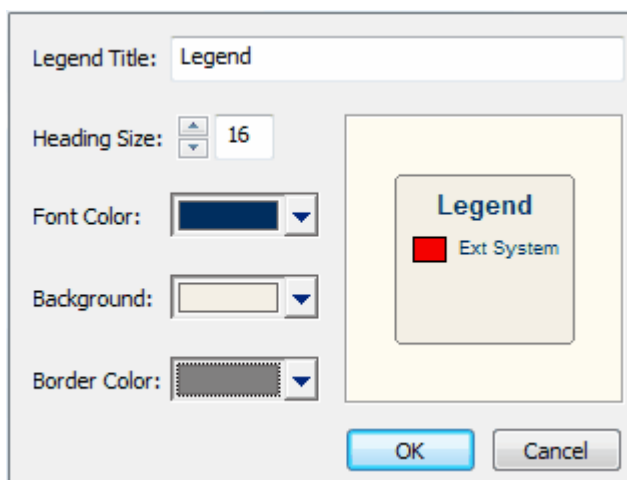

Click on the **OK** button on the **Style Options** dialog and again on the **Legend** dialog. The Legend displays on

the diagram.

#### 4.5.6.19 Autosize Elements

You can autosize an element or group of elements in a diagram to the default size for the element type.

As an example, the default size for a Class is 90 x 70 pixels at 100% zoom. However, if the element contains more information than the default size can show (such as a long name, long attributes or additional compartments) the autosize option resizes the element to the minimum size for revealing the information.

The size change effectively operates around the mid point of each element, so the layout and size of the diagram do not change. To automatically change the layout of a diagram, see the [Lay Out a Diagram Automatically](#)<sup>[47]</sup> topic.

To autosize elements, follow the steps below:

1. Select the elements to resize (press **[Ctrl]+[A]** to select all).
2. Either:
  - Right-click on any of the elements and, on the context menu, select the **Autosize** menu option, or
  - Press **[Alt]+[Z]**.

#### Notes:

- Not all elements resize: elements such as Events remain the same; Timing and Sequence diagrams (where position is crucial) are unchanged; and elements added from a profile or Shape Script maintain any size definitions imposed by the profile.
- With an element image created with a Shape Script that contains a [defSize command](#)<sup>[115]</sup>, **Autosize** returns the element to the *defSize* value and *not* the element default size.

#### 4.5.6.20 Swimlanes Matrix

Enterprise Architect diagrams support a *Swimlanes Matrix* for all diagram types, based on the Zachman Framework.

<b>The Zachman Framework</b>	<b>DATA</b> <small>What (Things)</small>	<b>FUNCTION</b> <small>How (Process)</small>	<b>NETWORK</b> <small>Where (Location)</small>	<b>PEOPLE</b> <small>Who (People)</small>	<b>TIME</b> <small>When (Time)</small>	<b>MOTIVATION</b> <small>Why (Motivation)</small>
<b>SCOPE</b> <small>(Contextual) Planner</small>						
<b>BUSINESS MODEL</b> <small>(Conceptual) Owner</small>						
<b>SYSTEM MODEL</b> <small>(Logical) Designer</small>						
<b>TECHNOLOGY MODEL</b> <small>(Physical) Builder</small>						
<b>DETAILED REPRESENTATIONS</b> <small>(Out-of-Context) Sub-Contractor</small>						
<b>FUNCTIONING ENTERPRISE</b>						

The Swimlanes Matrix divides the diagram into cells of vertical columns and horizontal rows. The cell in the top left corner of the Swimlanes Matrix contains the heading of the matrix. The first cell at the top of each column contains the column title text. The first cell at the left of each row contains the row title text.

#### Set up Swimlanes Matrix

To set up and manage the *Swimlanes Matrix*, select the **Diagram | Swimlanes and Matrix** menu option to display the **Swimlanes and Matrix** dialog. Click on the **Matrix** tab.



### Activate the Matrix

To activate the Swimlanes Matrix, select the **Active** check box.

At the same time, you can define the line width for all lines on the matrix; in the **Line Widths** field, click on the drop-down arrow and select the appropriate width.

### Create the Heading of the Swimlanes Matrix

To define the heading for the matrix, follow the steps below.

1. Click on the **New** button.
2. In the **Type** field in the **Details of New Column** panel, click on the drop-down arrow and select **Heading**.
3. In one or more of the **Title** fields, type the heading name. You can enter up to three text strings as heading text.
4. If necessary, click on the **Color**, **Font** and **Back** options and select the heading text font, color and background color.
5. Click on the **Save** button in the **Operations** panel. The *Heading* cell displays on the diagram.

#### Note:

The heading is the first item in the list; you create only one heading.

### Create Columns and Rows:

To define the column and row headings for the matrix, follow the steps below.

1. Click on the **New** button.
2. In the **Type** field, in the **Details of New Column** panel, click on the drop-down arrow and select either **Column** or **Row** as appropriate.
3. In one or more of the **Title** fields, type the column or row name. You can enter up to three text strings as title text.
4. If necessary, click on the **Color**, **Font** and **Back** options and select the title text font, color and background color.
5. Click on the **Save** button in the **Operations** panel. The column or row heading cell and column or row

lines display on the diagram.

**Note:**

When you define columns and rows, you define the header or title cells. The properties of these cells do not reflect on the matrix cells themselves. For example, the intersection cell of a column and row has a transparent background and therefore takes the color and shading effect of the diagram background.

**Lock the Matrix**

To lock the matrix so that it cannot be edited on the diagram, on the **Swimlanes and Matrix** dialog select the **Lock** checkbox.

**Edit items in the list:**

As you create the heading, column and row title cells, they are added to the list in the bottom of the dialog. To edit an item, follow the steps below.

1. Click on the required item in the list.
2. Make the relevant changes in the **Edit Selected ...** panel.
3. Click on the **Save** button in the **Operations** panel.

**Delete items from the list:**

To delete the heading or a column or row from the matrix, follow the steps below.

1. Click on an item in the list.
2. Click on the **Delete** button in the **Operations** panel.

**Model Profiles:**

After creating a Swimlane Matrix, you can save it into a *Model Profile* and apply it to other diagrams. Model Profiles are available on any diagram in your model.

**Save a Model Profile:**

To save a Model Profile, follow the steps below.

1. In the **Model Profiles** panel, click on the **Save** button. The **Save Model Profile** dialog displays.
2. In the **Name** field, type the name of your profile.
3. Click on the **OK** button.

The profile is now visible in the profile name drop-down list here and on other diagrams.

**Note:**

You can also transport all the matrix profiles between models (as Diagram Matrix Profiles), using the [Export Reference Data](#)<sup>[223]</sup> and [Import Reference Data](#)<sup>[223]</sup> options on the **Tools** menu.

**Apply a Model Profile:****Note:**

By applying a Model Profile, you replace the current profile. Save the current profile to avoid losing it.

To apply a Model Profile to a diagram, follow the steps below.

1. In the **Model Profiles** panel, click on the drop-down arrow of the profile name field, and select the required profile from the list.  
The list contains a predefined Zachman profile, as well as an empty profile should you want to replace the current profile with one that you create on the spot.
2. A confirmatory prompt displays. Click on the **OK** button to display the profile details on the **Swimlanes and Matrix** dialog.
3. Click on the **OK** button at the bottom of the **Swimlanes and Matrix** dialog to apply the profile to the matrix on the diagram.

## Size the Matrix

To size the rows and columns, drag the row and column borders on the diagram.

Elements placed inside each cell are shifted when sizing. To prevent the elements shifting, press and hold **[Ctrl]** while sizing.

### See Also

- [Swimlanes](#) <sup>[450]</sup>

### 4.5.6.21 Using the Image Manager

The **Image Manager** dialog enables you to insert alternative images in diagrams, rather than inserting standard UML elements. For example, you might want to place a [custom background image](#) <sup>[448]</sup> on a diagram, or display a custom image such as a Router or PC on a UML element.

#### Notes:

- For elements with lifelines, such as those used on Sequence diagrams, the Lifeline must remain intact to enable messages to be created between the elements. Therefore such elements cannot have alternative images.
- In the Corporate, Business and Software Engineering, Systems Engineering and Ultimate editions of Enterprise Architect, if security is enabled you must have [Configure Images](#) <sup>[198]</sup> permission to configure alternative element images.

To display the **Image Manager** dialog, either:

- Right-click on the element within the diagram and, from the context menu, select the **Appearance | Select Alternate Image** option, or
- Select the element in the diagram and press **[Ctrl]+[Shift]+[W]**.

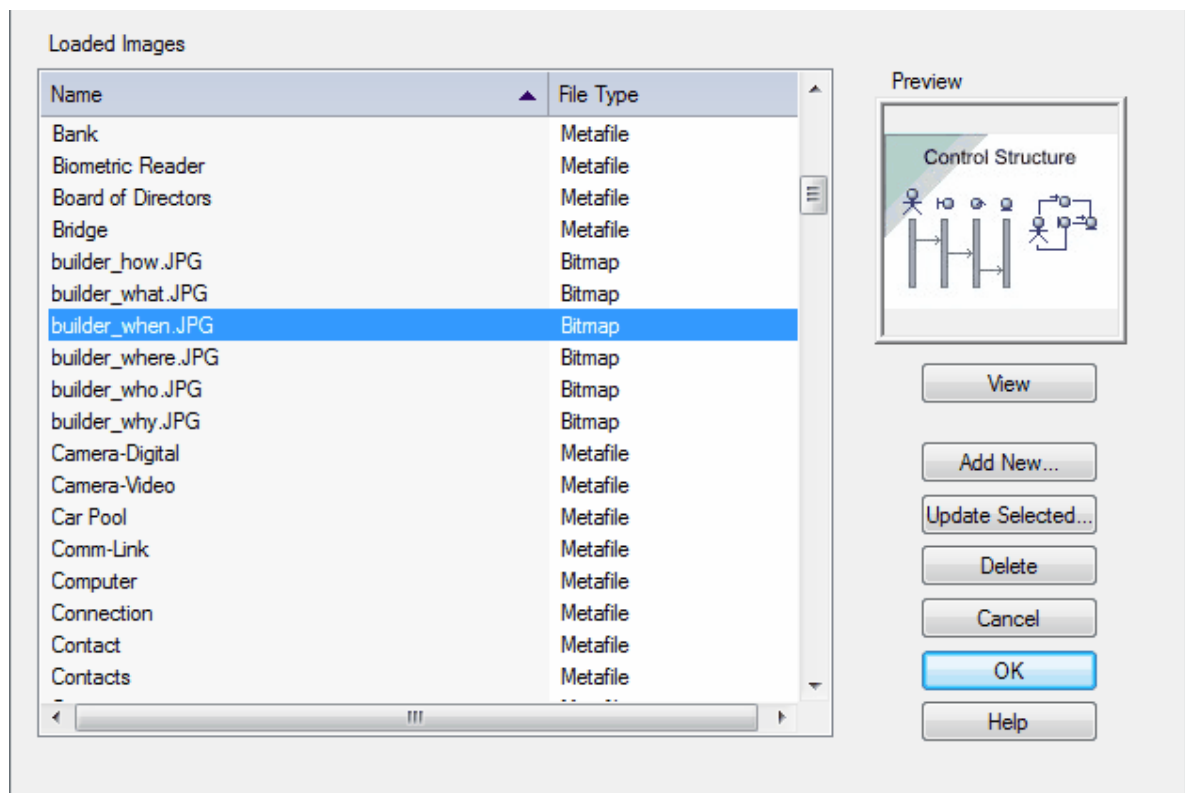

To locate and display an image, click on individual image filenames, or press **[↑]** and **[↓]** to scroll through the list of images. As you highlight each image filename, the **Preview** panel changes to reflect the image. Double-click on the required image filename to display the image in full size.

On the **Image Manager** dialog, the following buttons are available:

Option & Function Keys	Use to
<b>View</b> [Alt]+[V]	Display the selected image in full size.
<b>Add New</b> [Alt]+[A]	Browse appropriate directories to search for and import new images. You can import images in .BMP, .PNG, .EMF, .WMF, .TGA, .PCX or .JPG format. Internally, Enterprise Architect stores the images in .PNG or metafile format to conserve space.
<b>Update Selected</b> [Alt]+[U]	Refresh the selected image; for example, after it has been modified.
<b>Delete</b> [Alt]+[D]	Delete the selected image. A message displays to indicate how many elements use the image. Click on the <b>Continue</b> button to delete information about the image from those elements, which then revert to their previous appearance.
<b>Close</b>	Close the <b>Image Manager</b> dialog.
<b>OK</b> [Alt]+[O]	Confirm selection of the alternative image for the element selected in the diagram.

#### Notes:

- If you are creating many elements of the same type that have a particular image, you should use a [custom stereotype](#) <sup>[895]</sup> with an associated metafile.
- You can transport image files between models, using the [Export Reference Data](#) <sup>[223]</sup> and [Import Reference Data](#) <sup>[225]</sup> options on the **Tools** menu.

#### 4.5.6.21.1 Create Custom Diagram Background

Enterprise Architect diagrams have a single-color 'wash' background that you can set to a solid color or a fade gradient down the screen.

You set the color on the [Standard Colors](#) <sup>[353]</sup> page of the **Options** dialog, and whether to have a fade gradient on the [Diagram Appearance](#) <sup>[356]</sup> page. Alternatively, using the **Image Manager** dialog, you can create a non-tiled background for diagrams.

To set a background using the Image Manager, follow the steps below:

1. [Create a Boundary object](#) <sup>[802]</sup> from the **Use Case Elements** page of the [Toolbox](#) <sup>[399]</sup>. Do not use the *Boundary* element from any other section of the **Toolbox**.
2. Stretch the Boundary to a size that can contain all of the elements you intend to place on the diagram, and drag it to the edges of the diagram workspace.
3. Right-click on the Boundary element. The context menu displays.
4. Select the **Z-Order | Send to Bottom** menu option. This ensures that the Boundary is not displayed in front of any other element in the diagram.
5. Either:
  - Press **[Ctrl]+[Shift]+[W]**, or
  - Right-click on the Boundary to display the context menu, and select the **Appearance | Alternate Image** menu option.
6. On the [Image Manager](#) <sup>[447]</sup> dialog, select an appropriate image as the diagram background and ensure that the image size is large enough to span the required size of the diagram background.
7. When you have selected the required image, click on the **OK** button.

Alternatively, you can copy an image from another source onto the Windows clipboard, right-click on the Boundary element in the Enterprise Architect diagram, and select the **Appearance | Apply Image From Clipboard** context menu option.

#### 4.5.6.21.2 Import Image Library

The Image Library enables you to create attractive diagrams with custom images.

A bundled clip art collection of UML-based images is available as an Imported Image Library, from [www.sparxsystems.com/resources/image\\_library.html](http://www.sparxsystems.com/resources/image_library.html). Image libraries enable you to import a collection of images into the Image Manager in one process.

##### Note:

Images contained within the Image Library are copyright of Sparx Systems, are only available for use in conjunction with Enterprise Architect, and are supplied on the understanding that they are not used under any other circumstance.

### Import an Image Library

To import an Image Library you must have a suitable Image Library file. To import the Image Library, follow the steps below:

1. Download the Image Library from [www.sparxsystems.com/resources/image\\_library.html](http://www.sparxsystems.com/resources/image_library.html).
2. Select the **Tools | Import Reference Data** menu option. The **Import Reference Data** dialog displays.
3. Locate the XML Image Library file to import using the **Select File** button. The file name is *ImageLibrary.xml* in the directory in which you saved the file.
4. Select the data set containing the Image Library. Then click on the **Import** button.

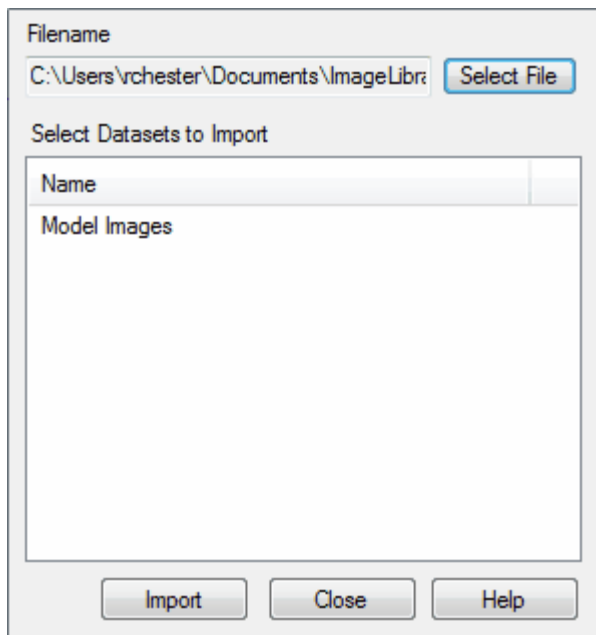

### Use the Image Library

To use the images contained within the Image Library, follow the steps below:

1. Create a diagram to associate with the images contained in the Image Library.
2. Select the element to change from the default appearance to one of the images contained within the library.
3. Press **[Ctrl]+[Shift]+[W]**, or right-click on the selected element to display its context menu and then select the **Appearance | Select Alternate Image** option.
4. On the **Image Manager** dialog, in the **Name** field highlight the appropriate image name and then click on the **OK** button.

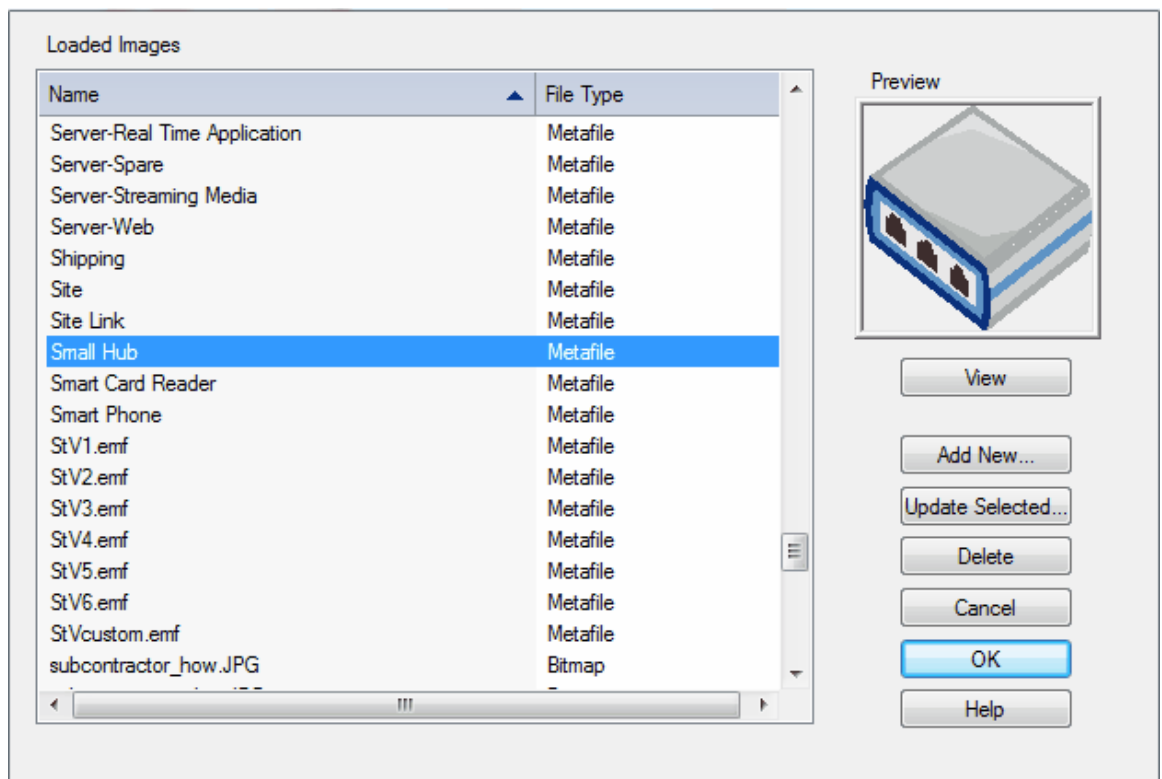

#### 4.5.6.21.3 Swimlanes

Enterprise Architect diagrams support *Swimlanes* for all diagram types.

Swimlanes are vertical or horizontal bands in a diagram that divide the diagram into logical areas or partitions. In the example below the activities relating to particular entities within the model (such as the User, or the back end Repository) are placed within a containing swim lane to indicate their association.

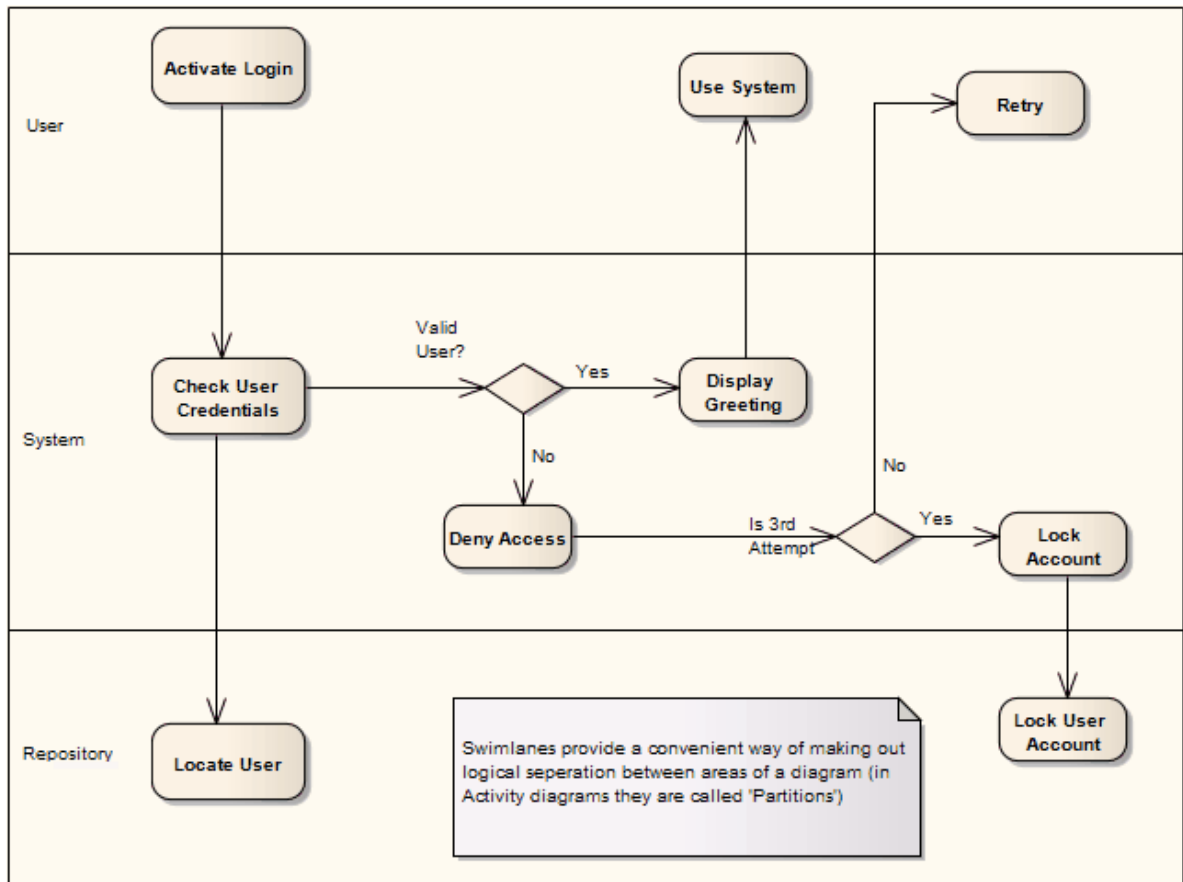

To manage swimlanes, select the **Diagram | Swimlanes and Matrix** menu option to display the **Swimlanes and Matrix** dialog. The dialog defaults to the **Swimlanes** tab.

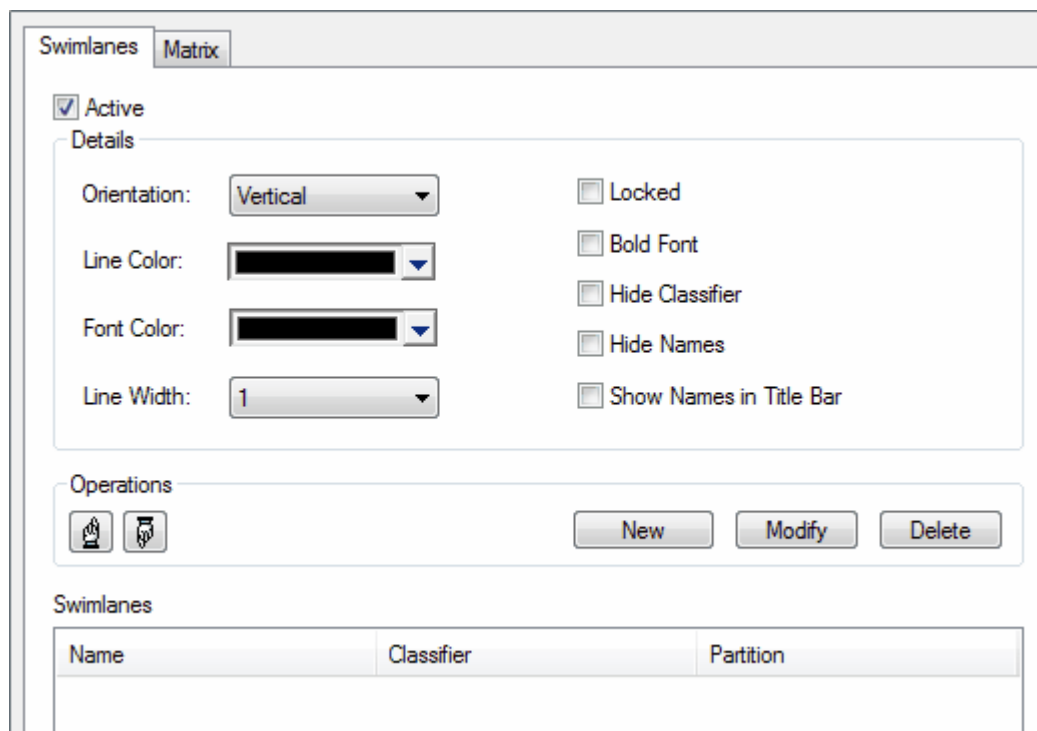

This dialog enables you to set the orientation (vertical or horizontal), line color and width of the swimlanes, and

lock the swimlanes to prevent further movement. You can also specify the font color and bold font, hide names, hide the classifier and show the name in the title bar. Use the **New**, **Modify** and **Delete** buttons to

change aspects of the selected swimlane. Use the  and  (up and down) buttons to change the order of swimlanes within the diagram.

If you set a background color for a swimlane, it takes on the same shading profile as the main diagram background.

#### See Also

- [Swimlanes Matrix](#)<sup>[444]</sup>

#### 4.5.6.22 Show Realized Interfaces of Class

You can display each interface directly realized by a Class as a 'lollipop' style interface node, which protrudes from the left-hand side of the Class.

Connectors can be directly attached to the node, indicating usage of the interface part of the Class or component. See the example below:

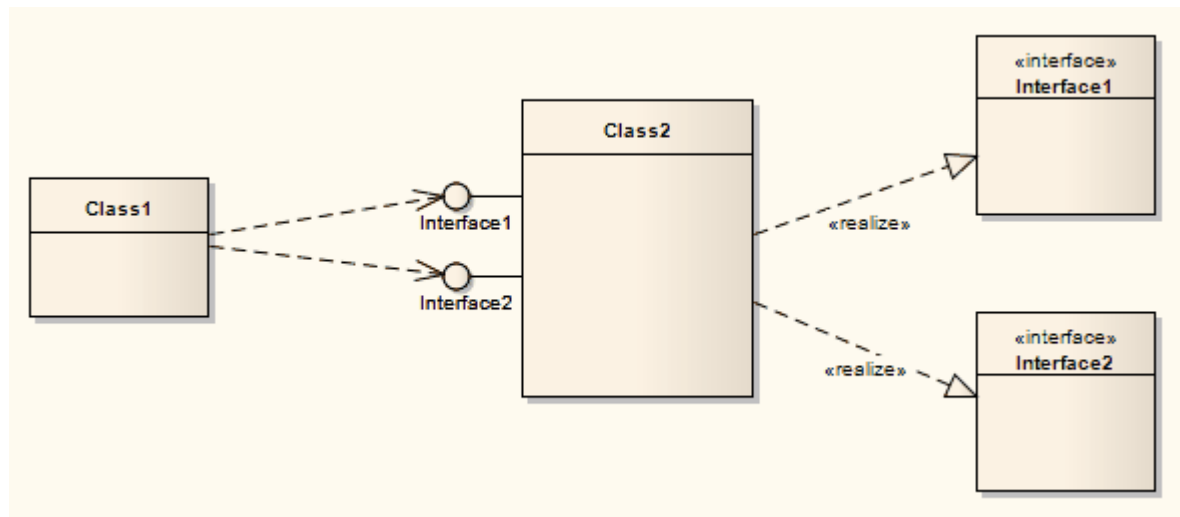

In this example, *Class2* realizes *Interface1* and *Interface2* as represented by the interface nodes protruding from the Class. *Class1* is dependent on these two interfaces, which is shown by the Dependency connectors linking to the nodes.

To show nodes for the interfaces a Class realizes, as in the above diagram, right-click on the Class and select the **Embedded Elements | Show Realized Interfaces** context menu option. This setting applies only to the selected Class, and can be changed at any time.

#### 4.5.6.23 Label Menu Section

You can add labels to both connectors and elements, using the element or connector context menu as follows:

- Element:
  - Select the [Embedded Elements](#)<sup>[552]</sup> menu option and either the **Add <element>** option or the **Embedded Elements** option; the label is the embedded element name
  - Apply an [alternative image](#)<sup>[447]</sup> to an element (that might also have a [run state](#)<sup>[824]</sup>; the run state, attributes and operations of the element are then displayed as a label of the element.
- Connector - Select the [Properties](#)<sup>[626]</sup> option and define the connector name, stereotype, constraints and/or source and target roles.

Once you have these labels, you can edit and format them using the **Labels** context menu.

To display the **Labels** context menu, right-click on a label.



**Note:**

As labels can be concentrated on and around the element or connector, make sure that you click on a section of the required label that is clear of any other label or structure.

**Element Labels**

The **Labels** menu associated with embedded elements provides the following options:

Menu Option	Use to
<b>Set Label Color</b>	Specify a color for the label.
<b>Hide Label</b>	Hide the label; to unhide the label, right-click on the element and select the <b>Appearance   Show labels</b> <sup>[555]</sup> context menu option.
<b>Bold</b>	Set the label font to bold.
<b>Text Alignment</b>	Align the text within the label text area. The options available from the submenu enable you to specify left, center and right alignment.
<b>Label Rotation</b>	Orient the label in the horizontal or vertical planes, with the vertical plane offering the option of clockwise or anti-clockwise position.
<b>Default Position</b>	Move the label to the initial default location.
<b>Default Color</b>	Set the label color to the default color.

**Connector Labels**

The **Labels** menu associated with connectors provides the following options:

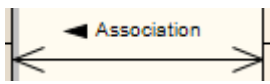
Menu Option	Use to
<b>Set Label Color</b>	Specify a color for the label.
<b>Hide Label</b>	Hide the label; to unhide the label use the <b>Visibility   Set Label Visibility</b> <sup>[622]</sup> option on the connector context menu.
<b>Bold</b>	Set the label font to bold.
<b>Text Alignment</b>	Align the text within the label text area. The options available from the submenu enable you to specify left, center and right alignment.
<b>Label Rotation</b>	Orientate the label horizontally or vertically and, if vertically, in a clockwise or anti-clockwise position.
<b>Direction</b>	<p>Set a small arrow at the end of the label pointing to either the label source or the destination dependent upon selection from the available options.</p>  <p>This is part of the label, so if there is no label there is no direction indicator.</p>
<b>Default Position</b>	Move the label to the default location.
<b>Default Color</b>	Set the label color to the initial default color.

**4.5.6.24 Pan and Zoom a Diagram****Pan**

Pan the **Diagram View** in the following ways:

- Use [**←**], [**→**], [**↑**], [**↓**], [**Page Up**], [**Page Down**], [**Home**] and [**End**] when the **Diagram View** is selected

- Use the scrollbars
- Use the middle mouse button
- Use the [Pan & Zoom](#) <sup>[1275]</sup> window.

## Zoom

Zoom into and out from a diagram using the zoom buttons on the diagram toolbar, or using the **Diagram | Zoom** submenu.



Change the zoom level by 10% by clicking on either the **Zoom In (+)** or **Zoom Out (-)** buttons. Alternatively, select the **Zoom In** or **Zoom Out** options from the **Diagram | Zoom** submenu.



There are three ways to return the diagram to 100%:

- Click on the  button
- Select **Zoom to 100%** from the **Diagram | Zoom** submenu
- **[Ctrl]**+middle-click the mouse.

### Tip:

You can zoom in and out of the main window dynamically by holding **[Ctrl]** and rolling the mouse wheel.

### Note:

- Changes in diagram magnification through the zoom options can be saved as permanent changes to the diagram.
- At high levels of zoom, element features cease to display. This is because of the difficulty the Windows font mapper has in choosing a font for extreme conditions, and the result can look odd.

### 4.5.6.25 Move Elements In Diagram Sections

As you build up a diagram, you might find that you need to move part of the diagram up, down or to one side.

You can move a section of a diagram in one of two ways:

- Hold the left mouse button down and drag over a group of elements to move (creating an outline around the elements), then click on an element in the outline and move the group as required
- Press **[Alt]** and click on the diagram, then drag the cursor to move everything beyond the cursor in the direction of the movement.

The first method enables you to reposition groups of elements within the larger diagram. The second method enables you to create space within the diagram without pushing some elements into others, as might happen if you cannot see the whole diagram on one screen.

When you press **[Alt]** and click on the diagram, as you move the cursor a line displays on the diagram just behind the cursor. If you are moving the cursor left, everything to the left of the line moves with the cursor. If you move the cursor up, everything above the line moves up.

However, if you move the cursor diagonally, two lines display to create a quadrant, and everything within the quadrant moves. For example, if you move the cursor left and down, everything below and left of the cursor moves.

## Fine Movement

To adjust (or 'nudge') the position of a single element or a selected group of elements, press **[Shift]+[←]**, **[←]**, **[↑]** or **[↓]**.

### 4.5.6.26 View Last and Next Diagram

Enterprise Architect enables you to step backwards and forwards through the currently-open diagrams, including the **Start Page**.



To view the previous or next diagram use the **Previous** or **Next** buttons on the **Diagram** toolbar.

Use the **Home** button to display the [default project diagram](#)<sup>[437]</sup> (if one has been specified).

### 4.5.6.27 Set Diagram Page Size

You can change the size of the diagram area (or scrollable/printable area) using the **Diagram Properties** dialog.

#### Note:

In the Corporate, Business and Software Engineering, Systems Engineering and Ultimate editions of Enterprise Architect, if security is enabled you must have [Update Diagrams](#)<sup>[198]</sup> permission to change diagram page setup.

To set the page size, follow the steps below:

1. Load a diagram.
2. Double-click on the background to open the **Diagram Properties** dialog.
3. Click on the **Diagram** tab and, in the **Appearance** panel ensure that the **Show Page Border** checkbox is selected.
4. On the **Page Setup** panel, click on the **Advanced** button. The **Print Advanced** dialog displays.
5. Click on the **Page Setup** button. The **Page Setup** dialog displays.

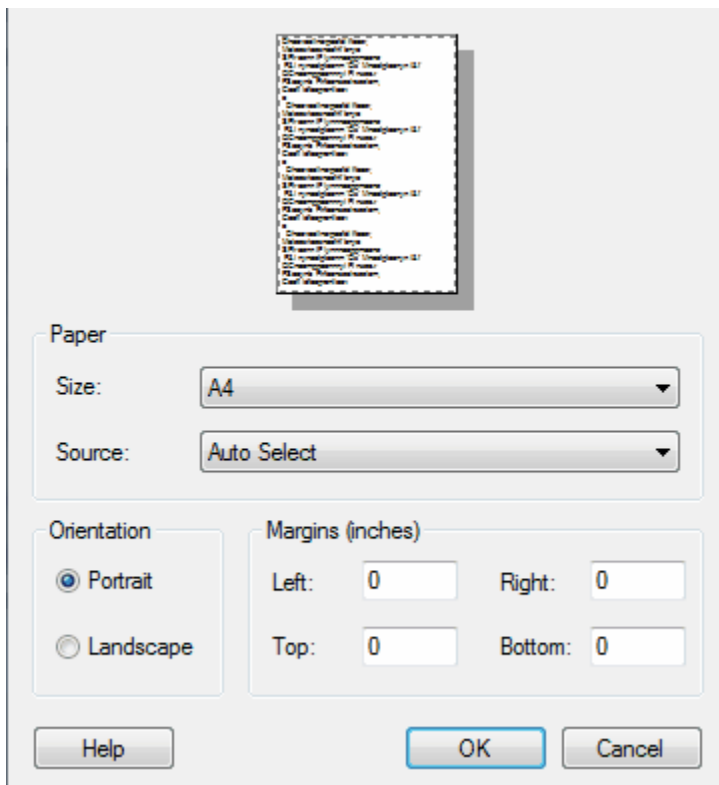
**Note:**

As you adjust the settings on this dialog, the page icon at the top illustrates the effects of your changes.

6. In the **Size** field, click on the drop-down arrow and select an appropriate page size.
7. In the **Orientation** panel click on the radio button for the orientation of the page to print.
8. In the **Margins** panel, type the required left, right, top and bottom page margins for the diagram, in inches.
9. Click on the **OK** button on the **Page Setup** dialog, the **Print Advanced** dialog, and the **Diagram Properties** dialog.

The area within the page boundary lines on your diagram is expanded or reduced accordingly. When you print or print preview, the output is cropped to these boundary lines and the diagram divided between the necessary number of pages.

### Setting the Default Paper Size for New Diagrams

You can set the default paper size for new diagrams on the **Diagram** page of the **Options** dialog (select the **Tools | Options | Diagram** menu option). Once the paper size is set there, all new diagrams have that as the default size.

See the [Configure Local Options - Diagram](#) topic.

#### 4.5.6.28 Scale Image to Page Size

When you [print](#) a diagram, by default the image is scaled to fit the size of the printer paper defined in the page set-up.

The image is not scaled up to fill the page, but it is scaled down if it exceeds the current page boundary. The image retains its current proportions; that is, it is scaled down equally in the X and Y dimensions. For a large diagram, this can mean that the components of the diagram are small and hard to read.

Alternatively, you can print a multi-page image; that is:

- allow the diagram image to print on as many printer pages as it naturally occupies, (no scaling), or
- scale the diagram image to exactly fit a specified number of pages.

In all three cases you also define the paper size and orientation.

## Scale Images

To turn off or customize image scaling options, follow the steps below:

1. Select the diagram to scale.
2. Double-click on the diagram background to display the **<type> Diagram: <name>** dialog, or right-click on the background and select the **Properties** context menu option.
3. Click on the **Diagram** tab and, in the **Page Setup** panel click on the **Advanced** button.

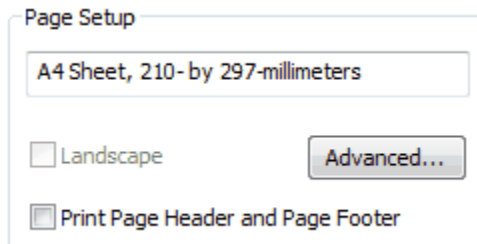

The **Print Advanced** dialog displays.

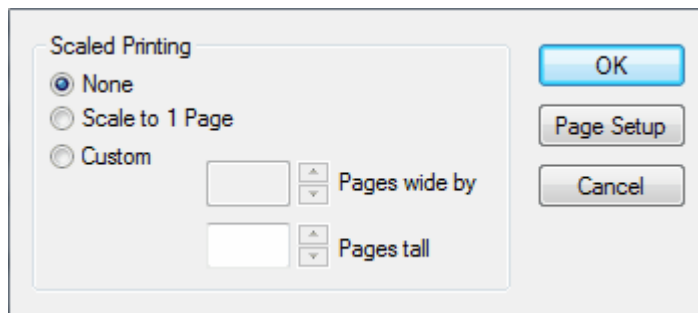

From the **Print Advanced** dialog the following options are available:

- **None:** select to print on as many pages as the diagram image covers
- **Scale to 1 page:** select to scale the diagram image to fit on the currently selected page
- **Custom:** select to specify the width and height of the diagram images across a specified number of pages
- **Page Setup:** click to select the [page size and alignment](#) <sup>[455]</sup>.

### Note:

Before printing, make sure you have selected the required page layout using the **Page Setup** button.

### 4.5.6.29 Lock Diagram

You can lock a diagram against inadvertent changes, such as moving or sizing elements.

To lock a diagram, follow the steps below:

1. Open the diagram to lock.
2. Right-click on the background to open the diagram context menu.
3. Click on the **Lock Diagram** option to prevent further changes.
4. Click on the **OK** button.

If a user selects an item on a locked diagram, the object border or outline displays in red.

### Note:

This does not apply in the Corporate, Business and Software Engineering, Systems Engineering and Ultimate editions if security is enabled. In that case, see the [Lock Model Elements](#) <sup>[204]</sup> topic.

### 4.5.6.30 Undo Last Action

When editing diagrams, Enterprise Architect supports multiple undo levels for moving, re-sizing and deleting elements, and for deleting connectors.

There are three ways to undo the last action:

- Press **[Ctrl]+[Z]**
- Select the **Edit | Undo** menu option
- Click on the **Undo** button in the **Default Tools** toolbar.



#### Warning:

Currently you cannot undo element additions or connector moves.

### 4.5.6.31 Redo Last Action

When editing diagrams, Enterprise Architect supports multiple undo levels for moving, re-sizing and deleting elements, and for deleting connectors. If an Undo action is in error, you can redo the action to reverse the Undo.

There are three ways to redo the last action:

- Press **[Ctrl]+[Y]**
- Select the **Edit | Redo** menu option
- Click on the **Redo** button in the **Default Tools** toolbar.



## 4.5.7 Layout Diagrams

Enterprise Architect provides a **Layout Tools** window to enable you to lay out the elements in a diagram.

Unless the diagram is very simple, this facility does not lay out the entire diagram; it consists of a set of tools to set out different areas or sets of elements in the diagram.

To start to lay out a diagram, follow the steps below:

1. Open the **Layout Tools** window; either:
  - Select the **View | Layout Tools** menu option, or
  - Right-click on the main toolbar and select the **Layout Tools** context menu option.

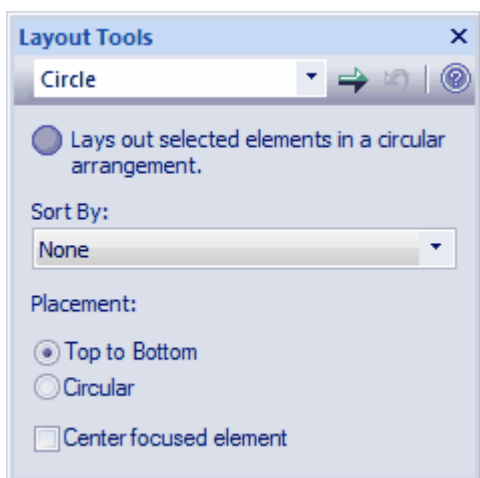

2. Select the elements to lay out on the currently-active diagram - hold **[Shift]** or **[Control]** while you click on each required element, or hold the mouse button down while you sweep over the area containing the required elements.

**Note:**

If no elements are selected on the active diagram, then all elements on the diagram are laid out (except where otherwise documented).

3. Click on the drop-down arrow on the top left field of the **Layout Tools** window, and select the required layout type.
4. The layout type determines the fields presented in the window, therefore the appropriate fields are described in the topic for each layout type.
  - [Circle/Ellipse](#) <sup>[459]</sup>
  - [Box](#) <sup>[463]</sup>
  - [Per Page](#) <sup>[464]</sup>
  - [Digraph](#) <sup>[465]</sup>
  - [Spring](#) <sup>[466]</sup>
  - [Neaten](#) <sup>[467]</sup>
  - [Converge/Diverge](#) <sup>[467]</sup>
  - [Fan Relations](#) <sup>[469]</sup>
  - [Auto Route](#) <sup>[470]</sup>
5. When you have completed the fields, click on the  button.

Enterprise Architect sets out the selected elements according to the options you have selected.

6. If you do not want to work with the new layout, click on the **Undo** button in the toolbar ().

Enterprise Architect also provides a facility for [automatically laying out a diagram](#) <sup>[471]</sup>. If necessary, you can manually adjust the final result of this automatic process.

#### 4.5.7.1 Circular/Elliptical Layout

The *Circle* and *Ellipse* layouts arrange the selected elements in a circle or elliptical pattern, using the largest horizontal and vertical element edge in the set of elements when calculating the radius of the layout arc.

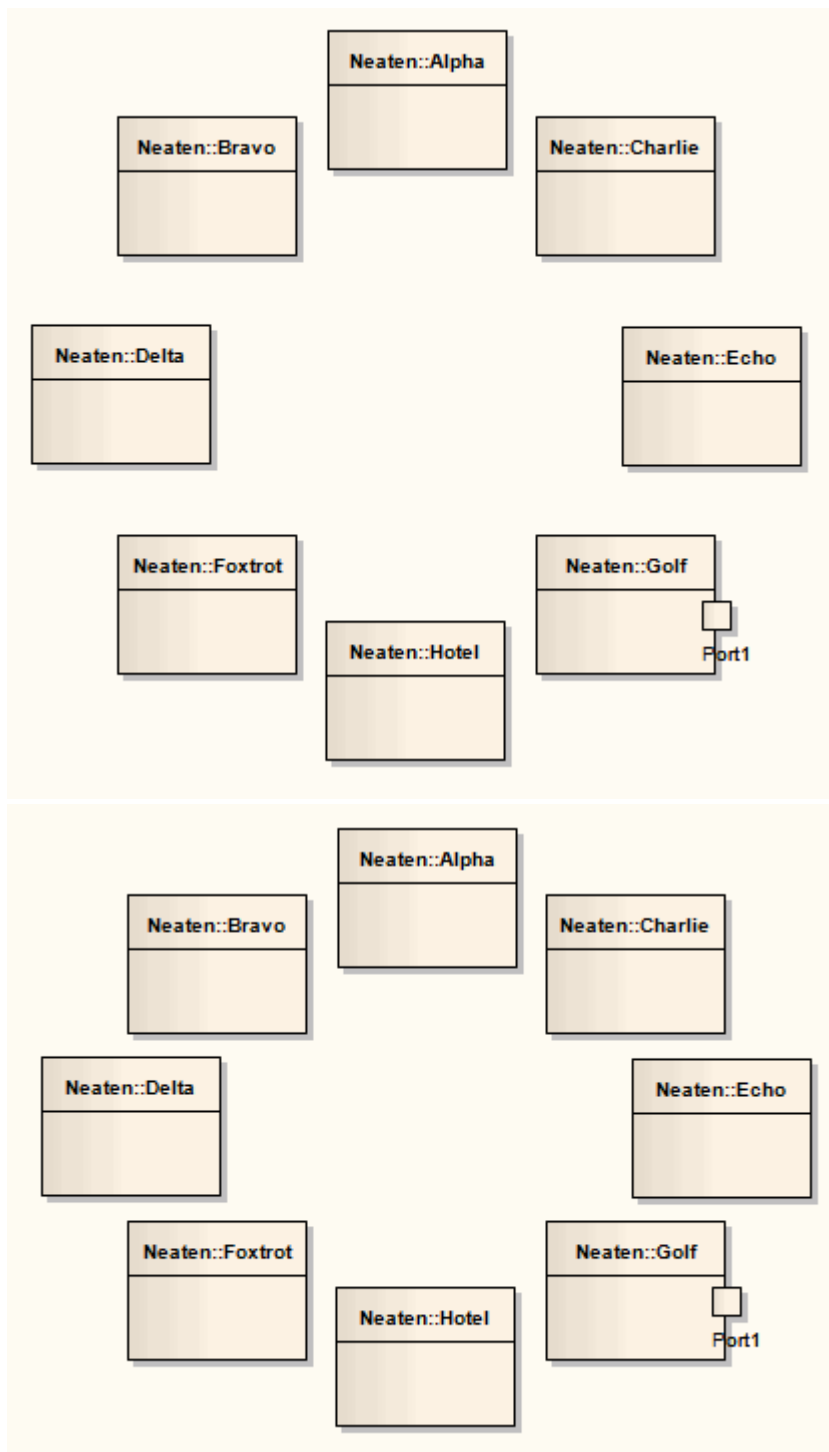

To invoke these layouts, follow the steps below:

1. Follow the general [Layout Diagrams](#) <sup>458</sup> procedure, and at step 3 select either **Circle** or **Ellipse** as required.
2. Click on the drop-down arrow in the **Sort By:** field and select the required sort parameter. The options are:
  - **None** - Elements are passed to the specified layout in the order in which they appear on the original diagram (left to right, top to bottom)
  - **Area (Ascending)** - Elements are passed to the specified layout in order of the screen space they occupy, smallest to largest



- **Area (Descending)** - Elements are passed to the specified layout in order of the screen space they occupy, largest to smallest
  - **Name (Ascending)** - Elements are passed to the specified layout in alphanumeric order, based on the element name
  - **Name (Descending)** - Elements are passed to the specified layout in reverse alphanumeric order, based on the element name
  - **Element Type** - Elements are grouped by type (for example, Class, Use Case) and in alphanumeric order within the group by name.
3. Under the **Placement** option, select either:
    - **Top to Bottom** (the elements are positioned in the required order, zig-zagged across the perimeter of the circle or ellipse - see *Diagram A*)
    - **Circular** (the elements are placed in the required order, clockwise around the perimeter of the circle or ellipse - see *Diagram B*)
  4. Select the **Center focused element** checkbox to put the last-selected element (the one with the hashed border) in the center of the circle or ellipse - see *Diagram C*.

*Diagram A - Top To Bottom Layout*

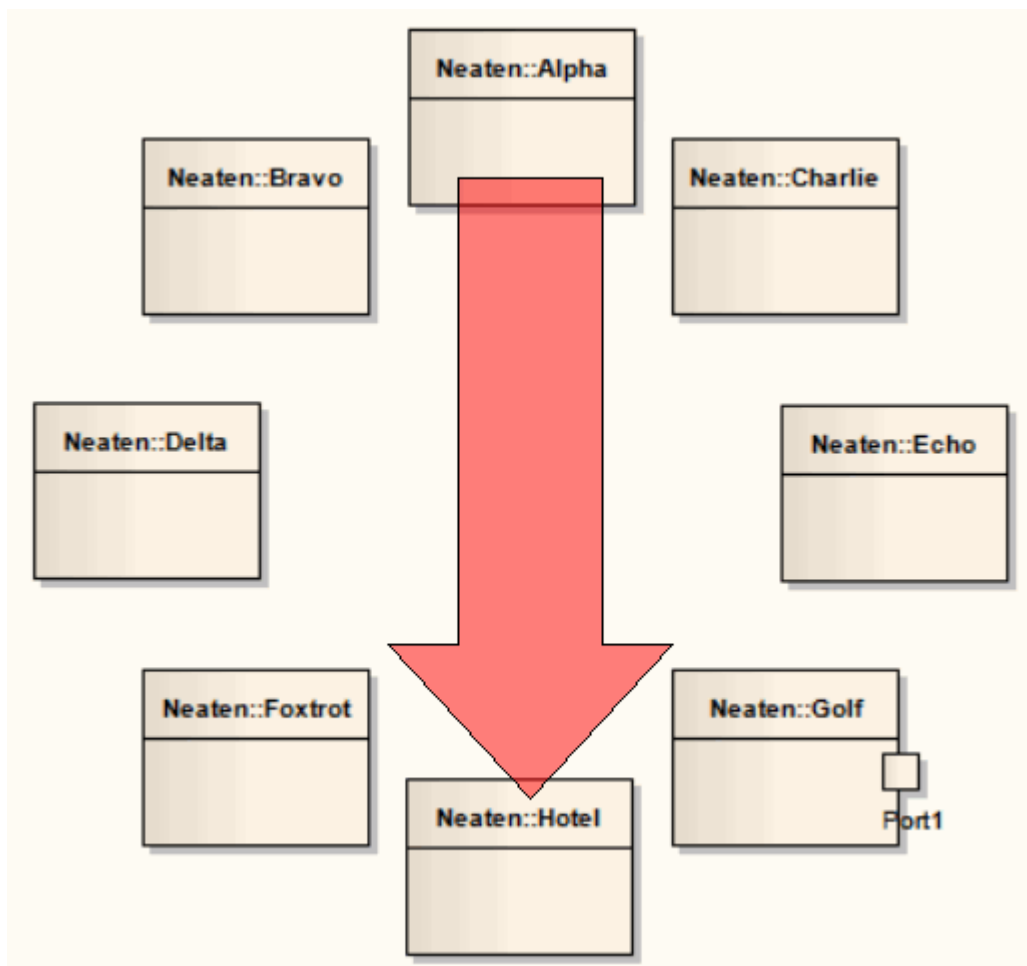

*Diagram B - Circular Layout*

Diagram C - Center Focused Element



#### 4.5.7.2 Box Layout

The *Box* layout arranges the set of selected elements into a square grid.

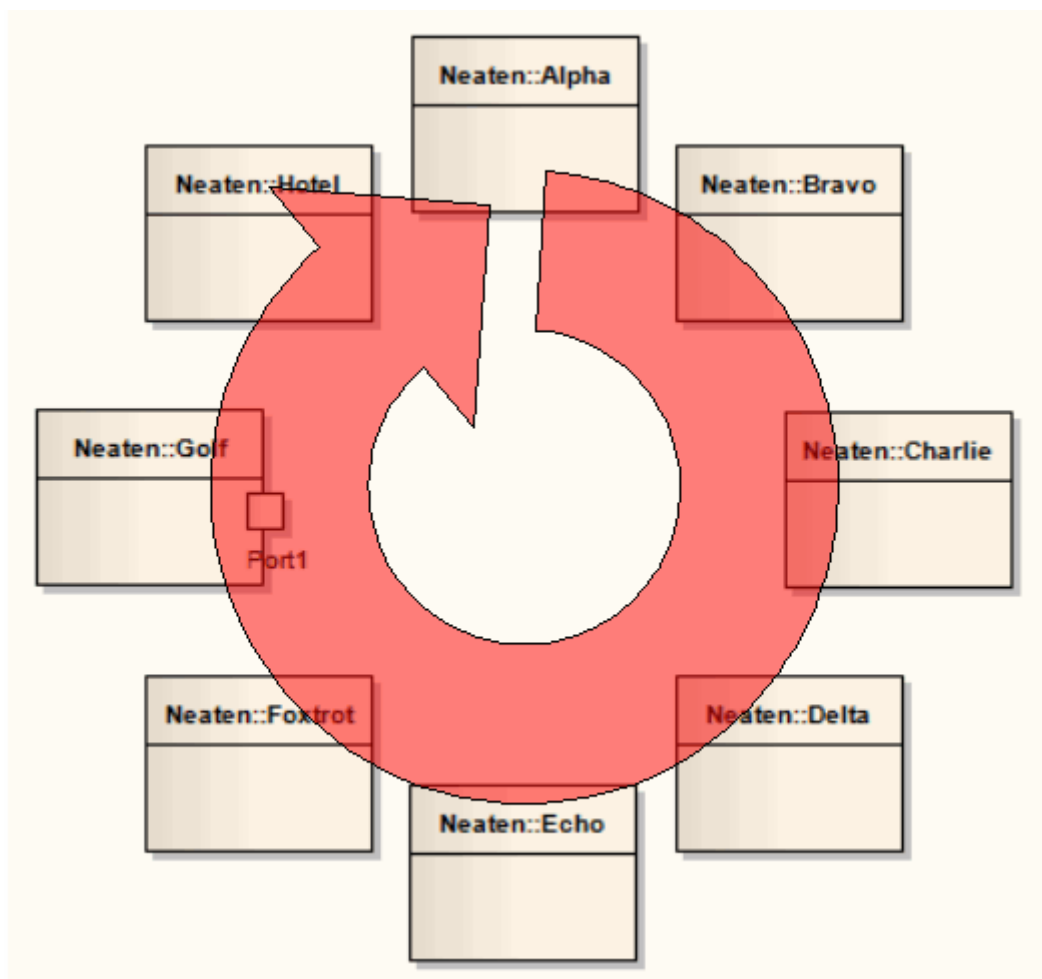
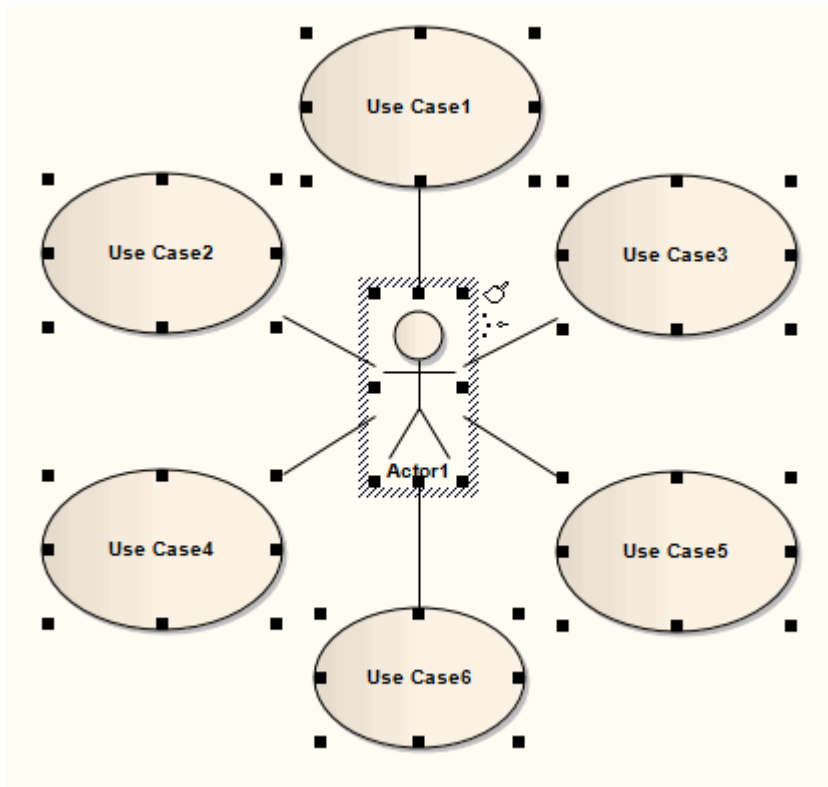
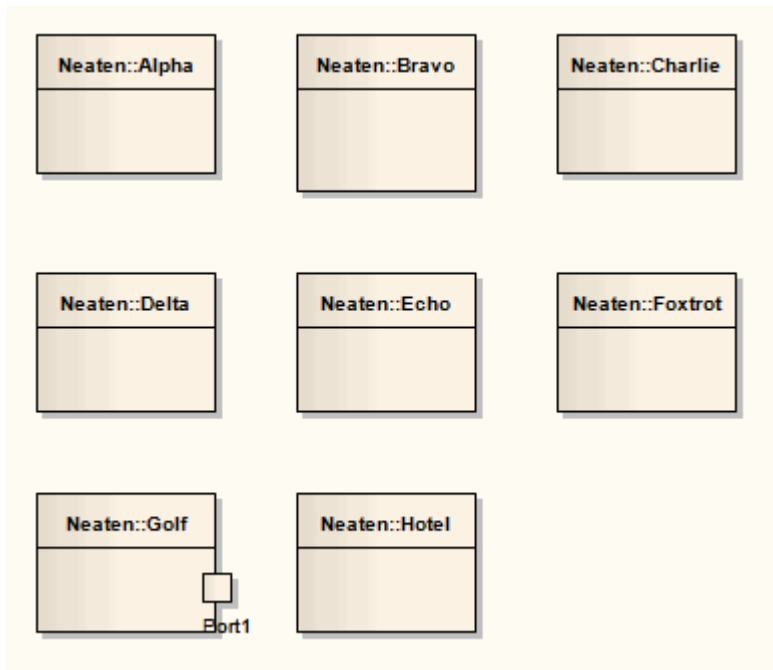

The dimensions of the box are determined by the square root of the number of selected elements (for example, 16 elements create a 4x4 box).

To invoke this layout, follow the steps below:

1. Follow the general [Layout Diagrams](#)<sup>(458)</sup> procedure, and at step 3 select **Box**.
2. Click on the drop-down arrow in the **Sort By:** field and select the required sort parameter. The options are:
  - **None** - Elements are passed to the specified layout in the order in which they appear on the original diagram (left to right, top to bottom)
  - **Area (Ascending)** - Elements are passed to the specified layout in order of the screen space they occupy, smallest to largest
  - **Area (Descending)** - Elements are passed to the specified layout in order of the screen space they occupy, largest to smallest
  - **Name (Ascending)** - Elements are passed to the specified layout in alphanumeric order, based on the element name
  - **Name (Descending)** - Elements are passed to the specified layout in reverse alphanumeric order, based on the element name
  - **Element Type** - Elements are grouped by type (for example, Class, Use Case) and in alphanumeric order within the group by name.
3. In the **Padding (px)** field, type the vertical and horizontal distance between elements, in pixels.
4. Select the appropriate element distribution option:
  - **Automatically distribute:** Automatically calculate the dimensions of the box (the square root of the number of selected elements; for example, 16 elements create a 4x4 box)
  - **Specify distribution:** Manually define the width of the box, in columns.
5. If you selected **Specify Distribution**, in the **Columns** field type the required number of columns.

### 4.5.7.3 Per Page Layout

The *Per Page* layout divides each diagram page into a number of cells, which house the selected elements. The number of cells per page is determined by the page distribution parameter, as explained below.



To invoke this layout, follow the steps below:

1. Follow the general [Layout Diagrams](#)<sup>(458)</sup> procedure, and at step 3 select **Per Page**.
2. Click on the drop-down arrow in the **Sort By:** field and select the required sort parameter. The options are:
  - **None** - Elements are passed to the specified layout in the order in which they appear on the original diagram (left to right, top to bottom)

- **Area (Ascending)** - Elements are passed to the specified layout in order of the screen space they occupy, smallest to largest
  - **Area (Descending)** - Elements are passed to the specified layout in order of the screen space they occupy, largest to smallest
  - **Name (Ascending)** - Elements are passed to the specified layout in alphanumeric order, based on the element name
  - **Name (Descending)** - Elements are passed to the specified layout in reverse alphanumeric order, based on the element name
  - **Element Type** - Elements are grouped by type (for example, Class, Use Case) and in alphanumeric order within the group by name.
3. In the **Padding (px)** field, type the vertical and horizontal distance between cells, in pixels.
  4. Select the appropriate page distribution option:
    - **Automatically distribute**: Automatically calculate the optimum number of cells, taking into consideration the largest horizontal and vertical element edges
    - **Specify distribution**: Manually enter the per page grid dimensions.
  5. If you selected **Specify Distribution**, in the **Rows** and **Columns** fields type the required number of rows and columns.
  6. Select the **Center Elements** checkbox to place each element in the center of its cell. Otherwise the element placement defaults to the top left corner of the cell.
  7. In the **Start Page** field, type the number from which to start page numbering. Pages begin at the top left and continue horizontally to the right.

#### 4.5.7.4 Digraph Layout

The *Digraph* layout arranges the selected elements into a directed graph (digraph for short).

The Digraph attempts to highlight the hierarchy of the elements while keeping the direction of all connectors pointing to the same edge of the diagram.

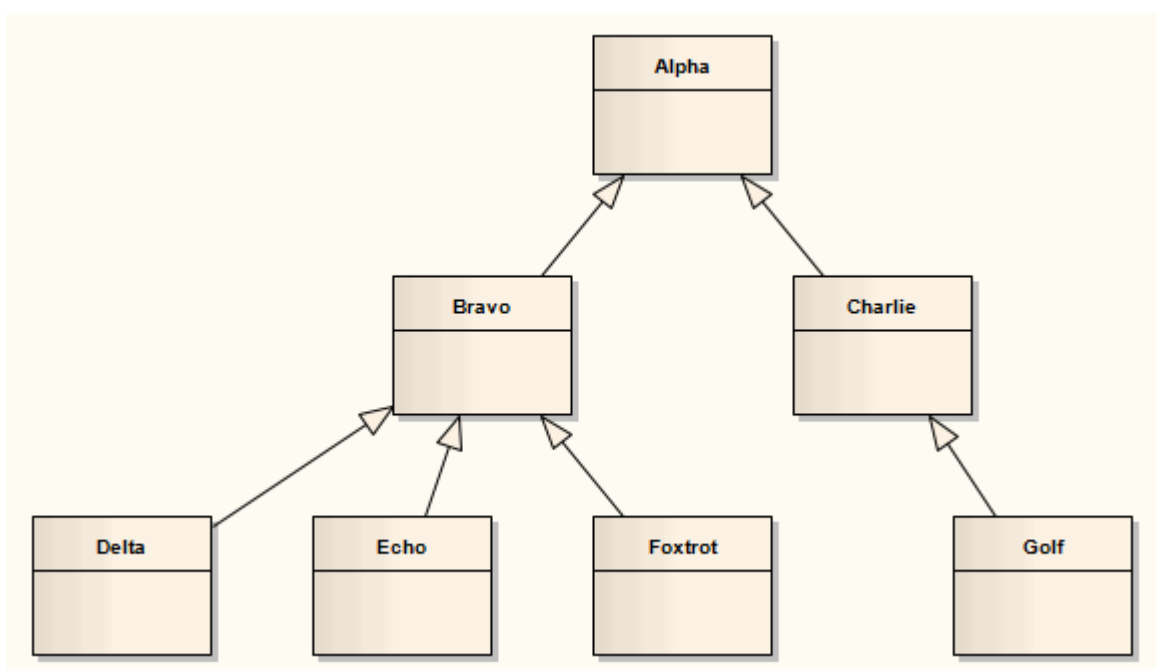

The Digraph layout provides the same behaviour as the Automatic Diagram layout. For information on how to apply this layout, see the [Layout Diagrams](#)<sup>[458]</sup> topic and, for details of the layout parameters, the [Layout a Diagram Automatically](#)<sup>[471]</sup> topic.

### 4.5.7.5 Spring Layout

The *Spring* layout uses a force-directed approach to arrange the selected elements organically.

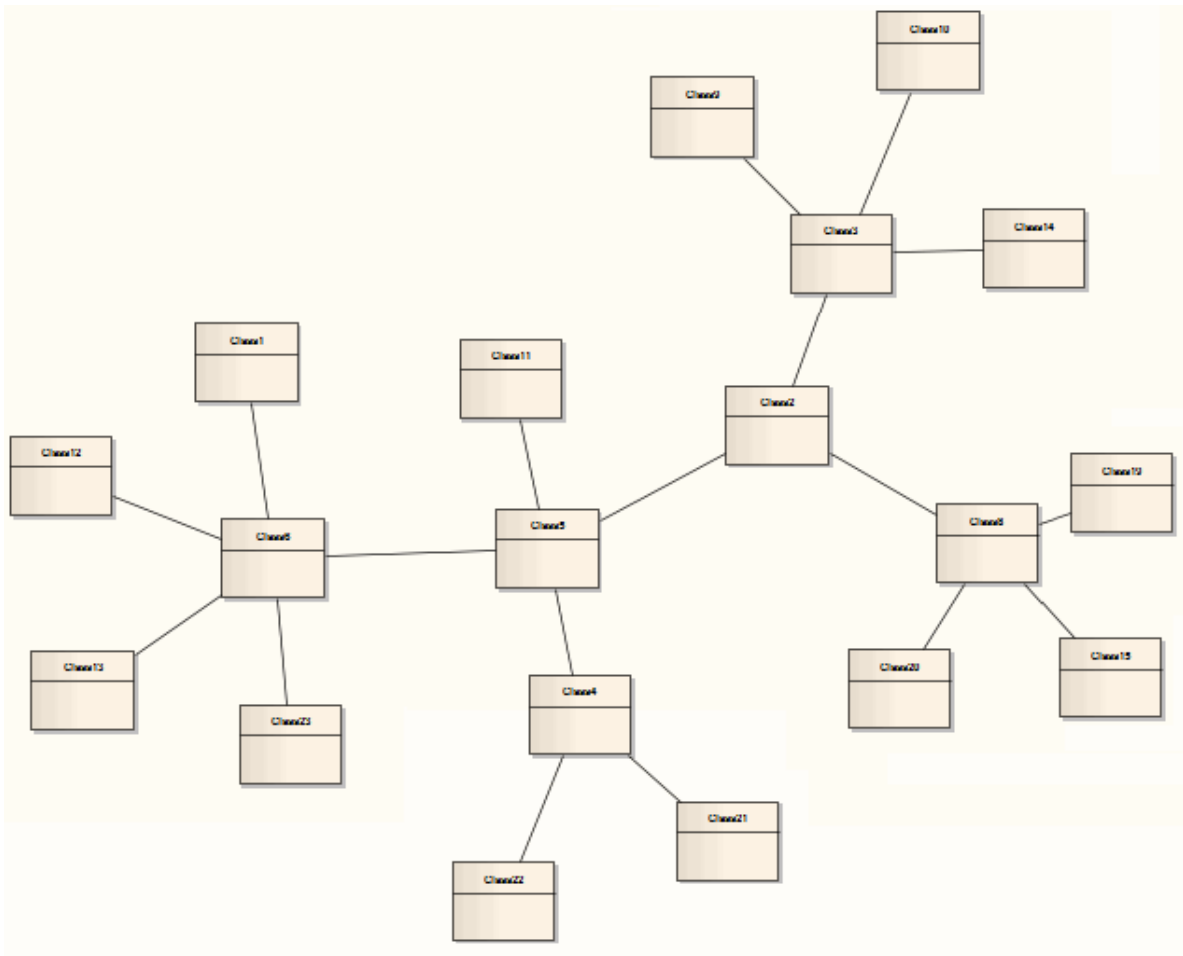

The Spring layout employs a physical analogy to lay out elements. Each element is treated as a particle with a like electrical charge that repels other elements. Connectors act as springs (hence the term Spring layout) that draw connected elements back together. The layout is good for highlighting clusters of related objects and identifying symmetry in the graph.

To invoke this layout, follow the steps below:

1. Follow the general [Layout Diagrams](#) <sup>(458)</sup> procedure, and at step 3 select **Spring**.
2. In the **Iterations** field, type the number of iterations, or rounds, to perform to reach the final layout.

The layout is developed over several iterations. Depending on the complexity of the graph, increasing the number of iterations produces a better result but takes longer to calculate.

3. If the diagram contains elements that significantly vary in size, and that might overlap in the final layout, select the **Scale to prevent overlap** checkbox to scale up the positions of the selected elements (preserving size) until no elements overlap.

### 4.5.7.6 Neaten Layout

The *Neaten* layout attempts to arrange the selected elements into a grid based on their horizontal and vertical proximity to each other. Elements that share the same row or column are aligned based on the **Column Snap** and **Row Snap** parameters.

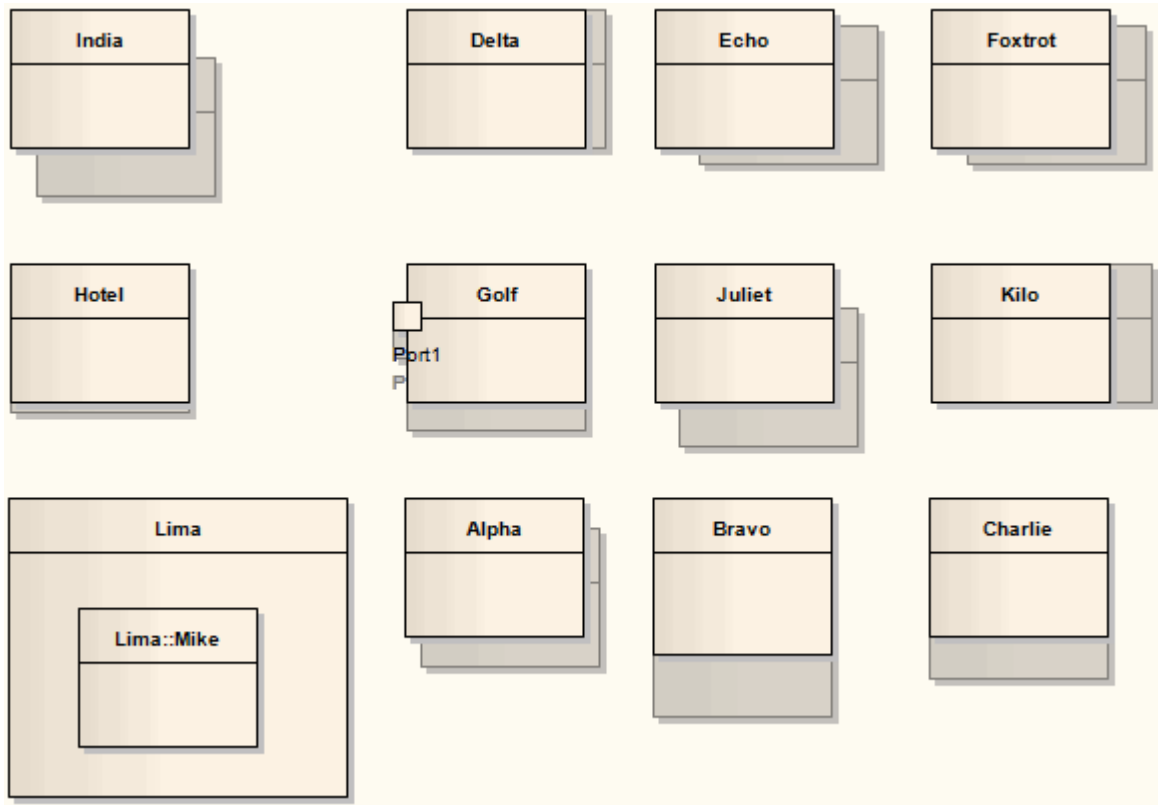

To invoke this layout, follow the steps below:

1. Follow the general [Layout Diagrams](#) procedure, and at step 3 select **Neaten**.
2. In the **Threshold (px)** field, type the height or width distance, in pixels, at which elements should be considered to be in the same row or column. A lower threshold value produces a tighter result, with only elements that are extremely similar - vertically or horizontally - considered to be in the same row or column.
3. In the **Column Snap** field, click on the drop-down arrow and select the appropriate alignment for elements in the same column.
  - **Left** - elements are aligned with the left edge of the left-most element in the column
  - **Center** - elements are aligned with the vertical center of the center-most element in the column
  - **Right** - elements are aligned with the right edge of the right-most element in the column.
4. In the **Row Snap** field, click on the drop-down arrow and select the appropriate alignment for elements in the same row.
  - **Top** - elements are aligned with the top edge of the highest element in the row
  - **Center** - elements are aligned with the horizontal center of the center-most element in the row
  - **Bottom** - elements are aligned with the bottom edge of the lowest element in the column.

### 4.5.7.7 Converge/Diverge Layout

The *Converge* layout attracts the set of selected elements towards the center of their bounding rectangle.

Conversely, the *Diverge* layout repels the set of selected elements away from the center of their bounding rectangle.

The Converge/Diverge layout also tries to maintain connector angles if an element in the set contains a connector with waypoints.

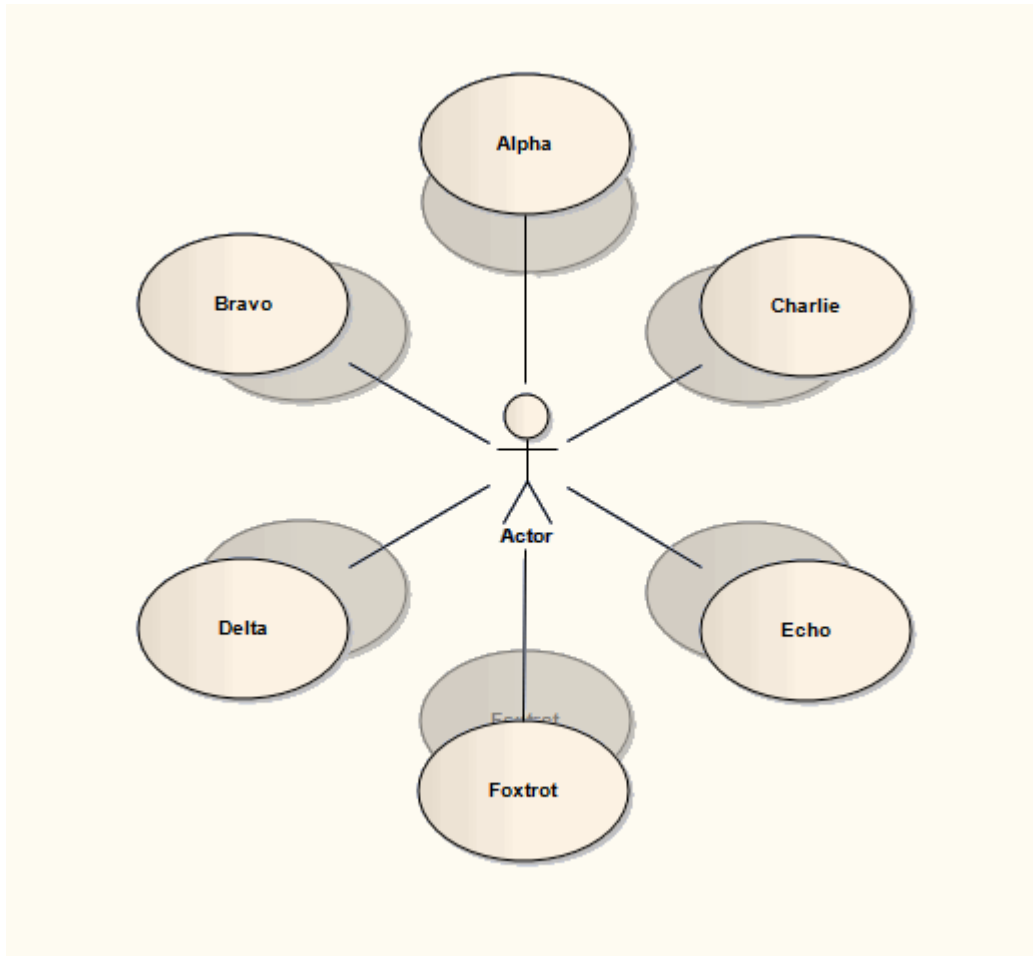

To invoke this layout, follow the steps below:

1. Follow the general [Layout Diagrams](#)<sup>[458]</sup> procedure, and at step 3 select **Converge/Diverge**.
2. For **Direction**, select the required layout:
  - **Converge** - attracts the set of selected elements to the center point
  - **Diverge** - repels the set of selected elements from the center point
3. The **Amount (%)** slider determines how far the elements are moved towards or away from the center point. The movement is the element's current distance from the center point multiplied by the percentage value set on the slider. In the Converge layout, the element moves towards the center point; in the Diverge layout the element moves further away from the center point.

Set the slider to the required percentage.



#### 4.5.7.8 Fan Relations Layout

The *Fan Relations* layout arranges the immediate relations of an element around a specified edge.

This layout requires a single element to be selected on the diagram, to be used as the context for the layout.

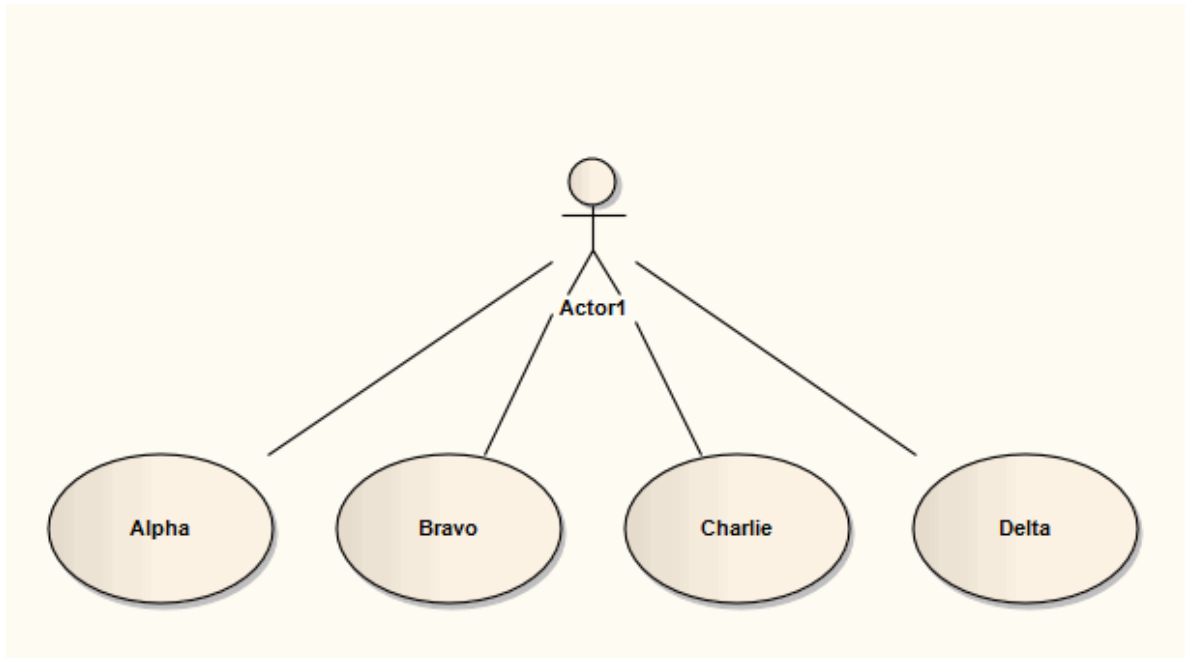

To invoke this layout, follow the steps below:

1. Open the **Layout Tools** window; either:
  - Select the **View | Layout Tools** menu option, or
  - Right-click on the main toolbar and select the **Layout Tools** context menu option.

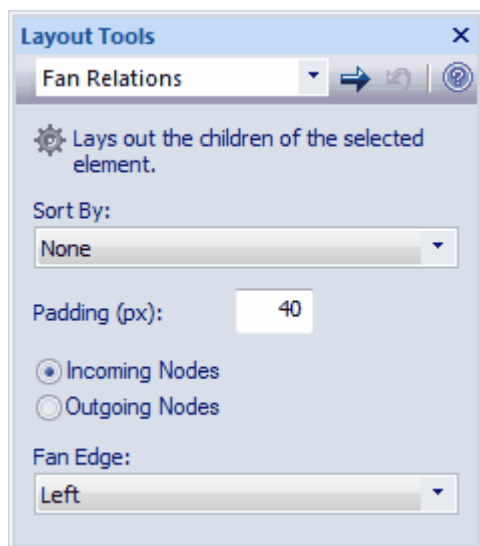

2. Select the single element around which to lay out related elements on the currently-active diagram.
3. Click on the drop-down arrow on the top left button of the **Layout Tools** window, and select **Fan Relations**.
4. Click on the drop-down arrow in the **Sort By:** field and select the required sort parameter. The options are:
  - **None** - Elements are passed to the specified layout in the order in which they appear on the original

diagram (left to right, top to bottom)

- **Area (Ascending)** - Elements are passed to the specified layout in order of the screen space they occupy, smallest to largest
  - **Area (Descending)** - Elements are passed to the specified layout in order of the screen space they occupy, largest to smallest
  - **Name (Ascending)** - Elements are passed to the specified layout in alphanumeric order, based on the element name
  - **Name (Descending)** - Elements are passed to the specified layout in reverse alphanumeric order, based on the element name
  - **Element Type** - Elements are grouped by type (for example, Class, Use Case) and in alphanumeric order within the group by name.
5. In the **Padding (px)** field, type the separation required between the selected element and its related elements, in pixels.
  6. Select the connector direction to use in determining the related elements to lay out. Either:
    - **Incoming Nodes** - to lay out related elements that have the selected element as the target
    - **Outgoing Nodes** - to lay out related elements that have the selected element as the source.
  7. In the **Fan Edge** field, click on the drop-down arrow and specify the edge of the selected element from which to lay out the related elements.
    - **Left** - to arrange related elements to the left of the selected element
    - **Right** - to arrange related elements to the right of the selected element
    - **Top** - to arrange related elements from the top of the selected element
    - **Bottom** - to arrange related elements from the bottom of the selected element.

#### 4.5.7.9 Auto Route Layout

The *Auto Route* layout orthogonally routes connectors between the selected elements.

The layout attempts to find the shortest path between the two connected elements while minimizing crossings. In the following layout, the original connectors are shown in red.

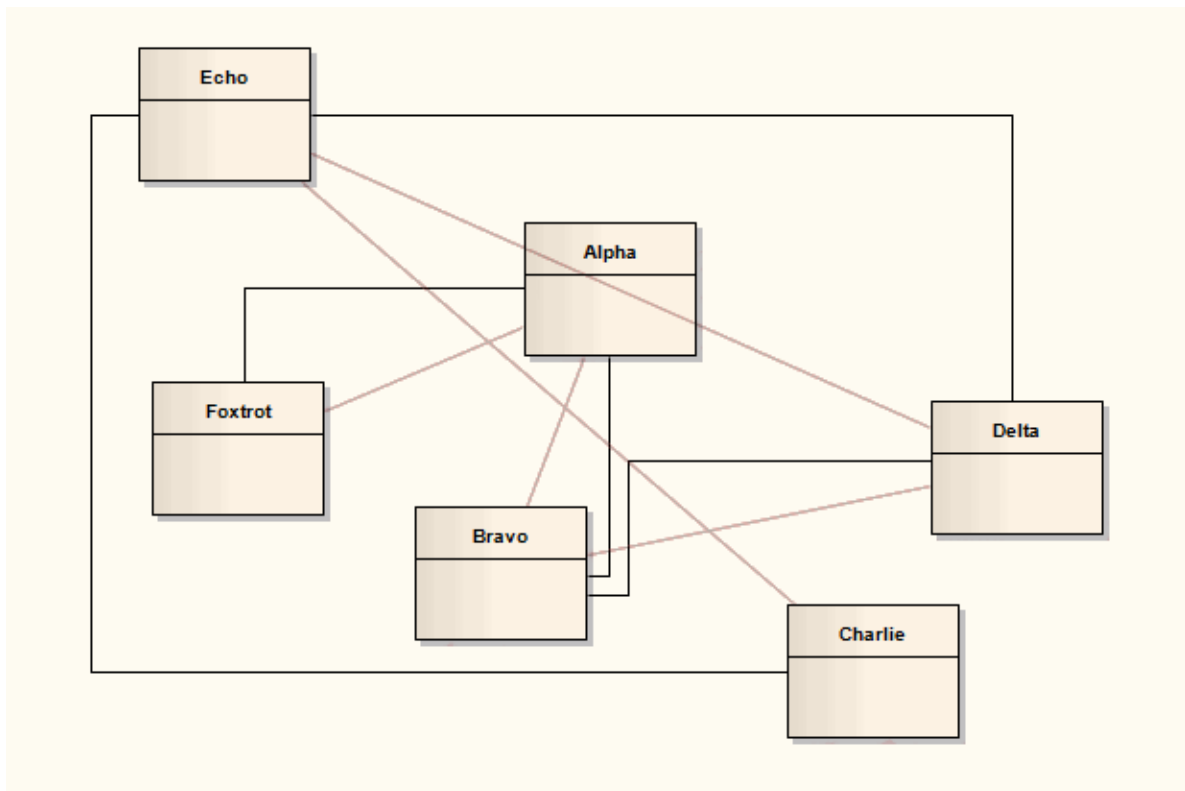

To invoke this layout, follow the steps below:

1. Follow the general [Layout Diagrams](#) procedure, and at step 3 select **Auto Route**.

2. When calculating connector routes, the algorithm divides the diagram into cells of a size determined by the **Cell Size** value. A smaller cell size results in connectors being placed closer together.

In this **Cell Size (px)** field, type the value in pixels.

3. In the **Element Margin** field, type the preferred separation between connector segments and element borders, in pixels.

#### 4.5.7.10 Lay Out a Diagram Automatically

Enterprise Architect provides the facility to layout diagrams automatically.

This creates a tree-based structure from the diagram elements and relationships in a diagram. Owing to the complexity of many diagrams, you might then have to do some manual 'tweaking'.

##### Notes:

- This facility is available for Structural diagrams and Extended diagrams, but not for Behavioral diagrams (see the [UML Diagrams](#)<sup>[673]</sup> topic for a description of the diagram types). However, the facility is also available for Sequence diagrams generated by the Enterprise Architect Debugger.
- Dynamic and Analysis diagrams are **NOT** suited to this form of layout - please ensure first that the diagram type you are laying out benefits from the action.
- If you dislike the autolayout, you can reverse it before saving the diagram. Click **[Ctrl]+[Z]**.

### Layout a Diagram

To layout a diagram, follow the steps below:

1. Select a diagram.
2. Click on either:
  - The **Diagram | Layout Diagram** option, or
  - The **Auto Layout** button on the diagram toolbar.

### Access the Diagram Layout Options Dialog

For a fine degree of control of the elements in your diagram, you can use the **Diagram Layout Options** dialog. Generally the default layout parameters provide adequate layouts for a wide range of diagrams, but there are times when more specific settings are required. To access the **Diagram Layout Options** dialog, follow the steps below:

1. Double-click on the background of the diagram to display the **Diagram Properties** dialog.
2. Click on the **Diagram** tab, then click on the **Set Layout Style** button. The **Diagram Layout Options** dialog displays.
3. When you have made the required changes, click on the **OK** button to save the changes.

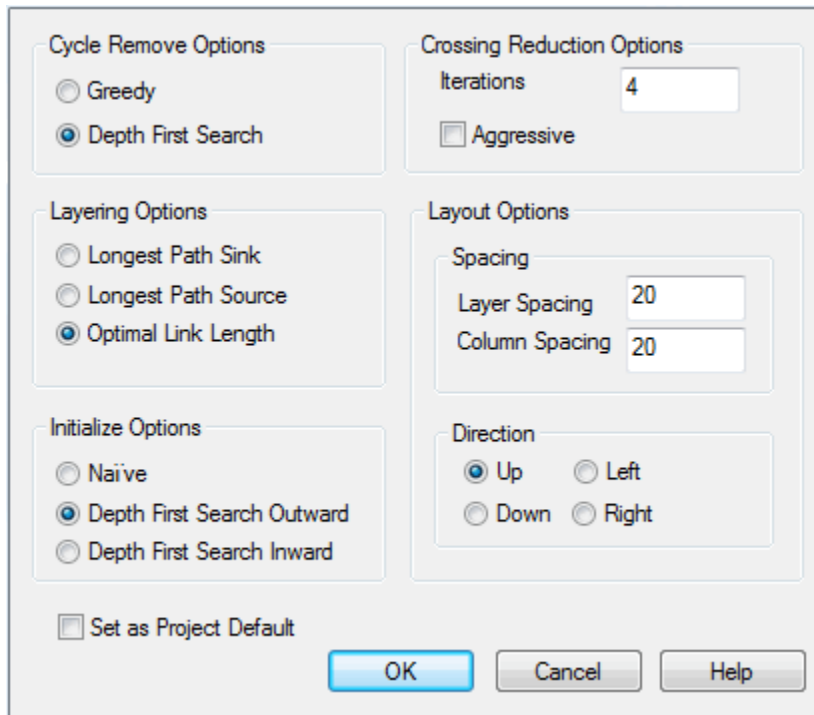

You can alter any of the following settings on the **Diagram Layout Options** dialog to refine your layout:

- **Cycle Remove Options** panel - these settings remove cycles in the element organization (where element X is the source of a path but also becomes the target of a branch of the path), by reversing the connectors that impose the cycling and then reorganizing the diagram and reinstating the reversed relationships. This identifies the primary source element in the diagram.
  - **Greedy** - Select to use the *Greedy Cycle Removal* algorithm, which minimizes the number of connectors reversed.
  - **Depth First Search** - Select to use the *Depth First Search Cycle Removal* algorithm, which establishes the longest linear sequence possible, before establishing parallel sequences and branches. This algorithm is less effective in large and/or complex diagrams, but produces a more natural layout than the *Greedy* algorithm.
- **Crossing Reduction Options** panel - these options determine how long the routine should look for ways of reorganizing the layout to avoid crossed relationships:
  - **Iterations** - Type the number of iterations to be used during cycle removal (more than 8 does not usually provide any improvement).
  - **Aggressive** - Select to use an aggressive (detailed and time-consuming) crossing reduction step.
- **Layering Options** panel - these settings determine how elements are organized in layers during layout:
  - **Longest Path Sink** - Select to use the *Longest Path Sink Layering* algorithm, where the final target elements (*sinks*, which have no relationships issuing from them) are arranged in a layer at the top of the diagram, and the relationship paths built downwards from there in as many layers as there are nodes in the longest path.
  - **Longest Path Source** - Select to use the *Longest Path Source Layering* algorithm, where the original *source* elements (those with no relationships entering them) are arranged in a layer at the bottom of the diagram and the relationship paths built up from there in as many layers as there are nodes in the longest path.
  - **Optimal Link Length** - Select to use the *Optimal Link Length Layering* algorithm, which organizes the elements into whichever layers minimize the total source-to-sink relationship chain; in this layout you can have both source elements and sink elements at various levels of the diagram.
- **Layout Options** panel
  - **Layer Spacing** - Type the default number of logical units between layers of elements (vertical spacing).
  - **Column Spacing** - Type the default number of logical units between elements within a layer (horizontal spacing).
  - **Up, Down, Left, Right** - Select the direction in which directed connectors should point, to set the position of the primary source element and the overall flow of the diagram.
- **Initialize Options** panel - the autolayout routine inserts line waypoints and connectors into relationship

paths to help plot the direction of relationships. The routine then assigns an index number to every node, such that nodes in the same layer are numbered left to right. The settings in this panel determine how those index numbers are assigned.

- **Naive** - Select to use the *Naive Initialize Indices* algorithm, which assigns index numbers to nodes as they are encountered in a sweep and tends to place all waypoints to the right of real nodes (and therefore long relationships between a small number of elements to the right of chains of short relationships between several elements).
- **Depth First Search Outward** - Select to use the *Depth First Out Initialize Indices* algorithm, which assigns index numbers to nodes as they are encountered in a depth first search from source nodes outwards (and would therefore place longer relationship chains to the left of shorter chains, with the primary source node at the start of the diagram flow).
- **Depth First Search Inward** - Select to use the *Depth First In Initialize Indices* algorithm, which also assigns index numbers to nodes as they are encountered in a depth first search, but from sink nodes inwards (and would therefore place longer relationship chains to the left of shorter chains, with the ultimate target node at the end of the diagram flow).
- **Set as Project Default** checkbox
  - Select this checkbox to apply the diagram layout settings to all diagrams in the project. If you later check this box and click on the **OK** button for a different diagram, the new settings override the settings saved earlier.

The following is an example of an automatically laid out diagram, with the following options set:

- **Depth First Search**
- **Optimal Link Length**
- **Depth First Search Outward**
- **Direction - Up.**

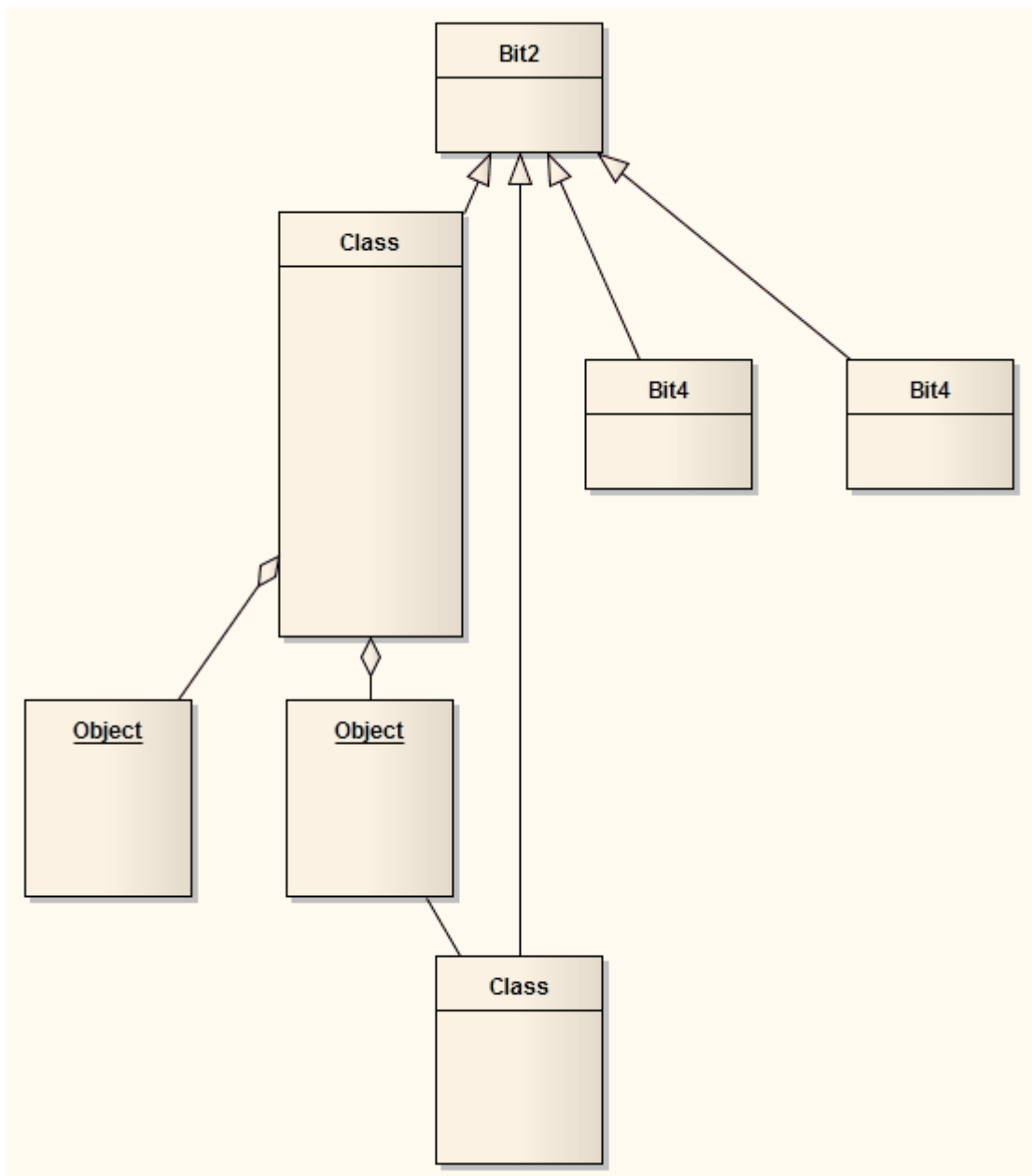

#### 4.5.8 The Quick Linker

The *Quick Linker* provides a simple and fast way to create new elements and connectors on a diagram.

When an element is selected in a diagram, the **Quick Linker** arrow is displayed at the upper right corner of the element, as shown below:

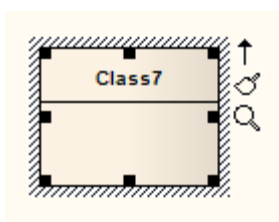

Simply clicking and dragging the icon enables you to create new connectors and elements on the diagram, as explained in the following topics:

- [Create New Elements](#)<sup>[475]</sup>
- [Create Connectors](#)<sup>[476]</sup>

The connectors and elements suggested by the Quick Linker are the commonest objects appropriate to the context. You can select others from the [Toolbox](#) pages. Also, a Technology Developer can edit the lists of elements and connectors, and create new combinations.

#### 4.5.8.1 Create New Elements

To create new elements using the Quick Linker, follow the steps below:

1. Select a start element on the current diagram.

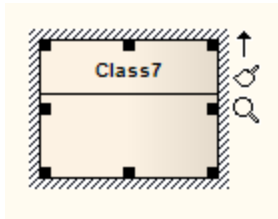

2. Drag the Quick Linker arrow onto an empty area of the diagram.

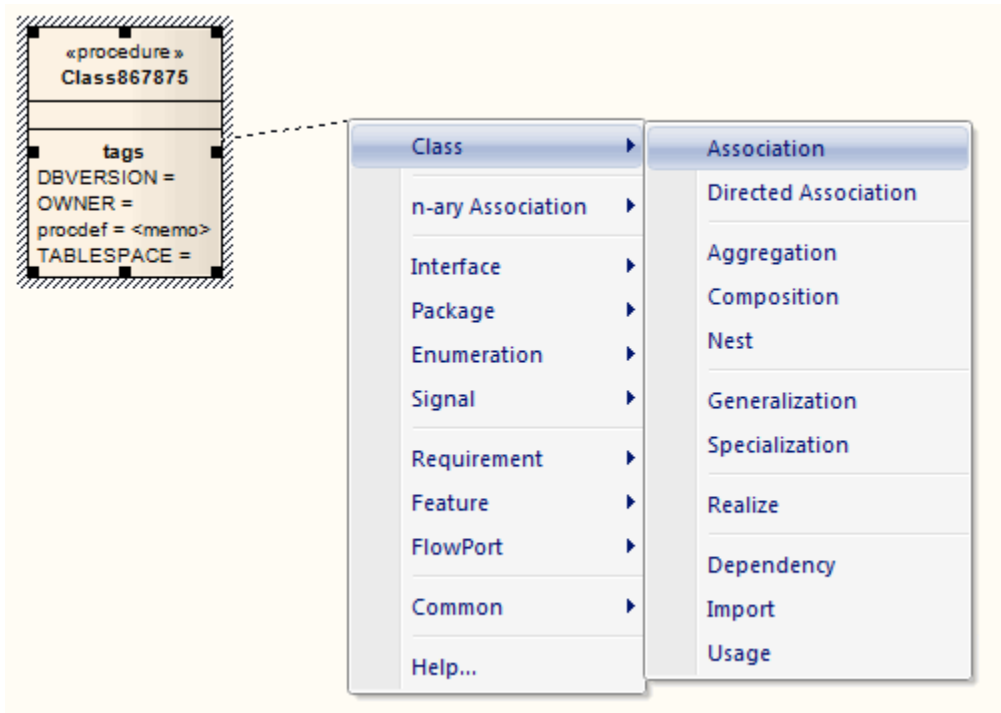

3. Use the Quick Linker context menu to select the type of element and connector to create.

#### Tips:

- Press and hold **[Shift]** while selecting the type of connector to select an existing classifier as the target.
- For rapid modeling, you can suppress the [Properties](#) dialog when creating new elements. See the option **Tools | Options | Objects | Edit Object on New**.

**Note:**

The available Quick Linker options depend on the type of element selected. For example, the Quick Linker options for a Class (above) differ from those of an Actor (below). These are the most appropriate, commonly used elements and connectors for the source element; you can create other target elements and connectors by selecting them from the appropriate [Toolbox](#) page.

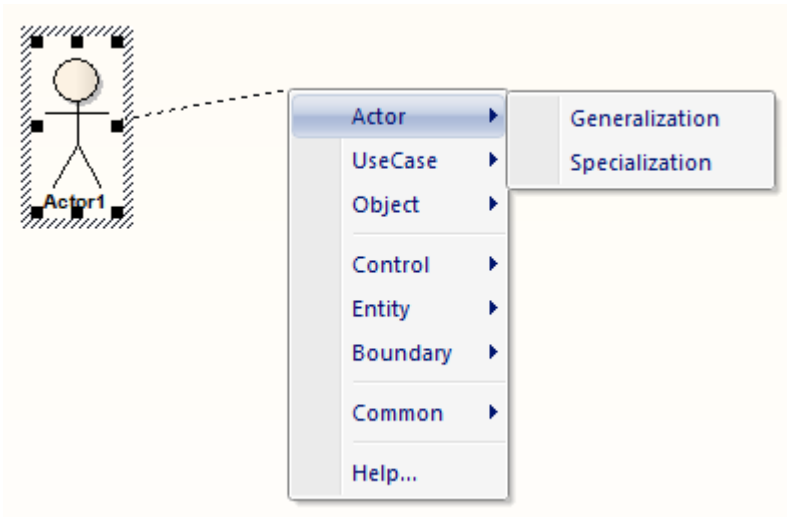

#### 4.5.8.2 Create Connectors

To create new connectors between existing elements using the Quick Linker, follow the steps below:

1. Select the source element on the current diagram.

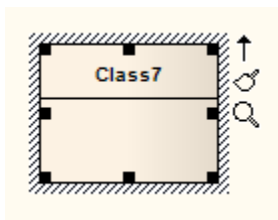

2. Drag the **Quick Linker** arrow onto another element in the diagram.
3. Release the mouse button and use the **Quick Linker** context menu to select the type of connector.

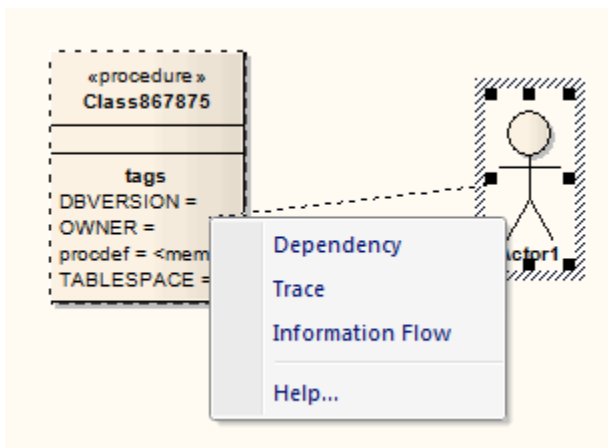



**Notes:**

- The list of connectors provides the most appropriate, commonly-used connectors for the source and target element types. If you want to use a different connector, select the appropriate **Toolbox** page, click on the required connector and then on the source element, and drag across to the target element.
- The connector does not actually establish until you release the mouse button over the target element. However, a dotted line shows where the connector would be at any point, and the solid outline of the nearest element or extension changes to a hatched outline as you move the cursor onto it; this helps you identify where the connector will connect to, if there are many closely-arranged elements, Parts, Ports and other extensions.
- You can also bend the connector, pressing **[Shift]** as you drag the cursor in a new direction.

## 4.6 Elements



Models are constructed from elements, each of which has its own meaning, rules and notation.

The properties and features of an element can be defined and displayed through a set of [windows and dialogs](#) [480].

Elements can be used at different stages of the design process for different purposes. The basic elements for UML 2.3 are depicted in the following diagrams:

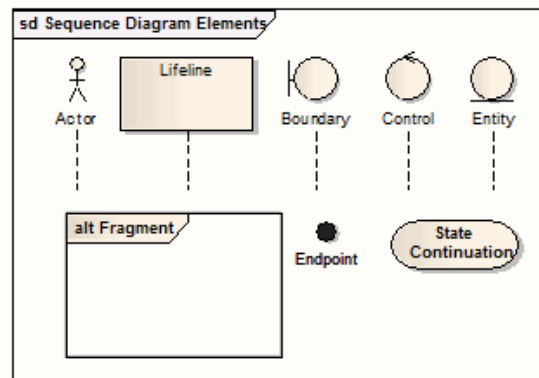
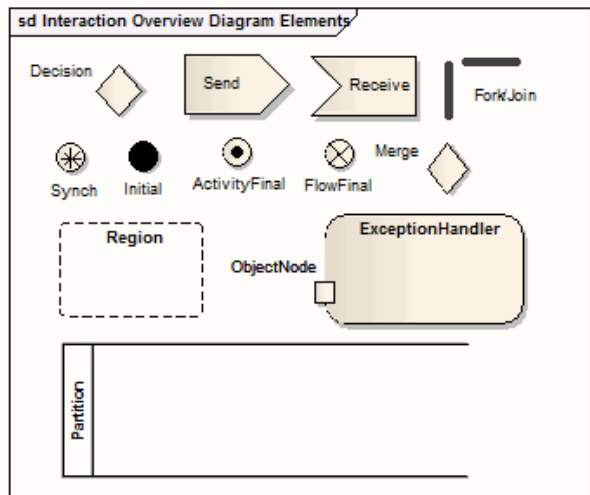
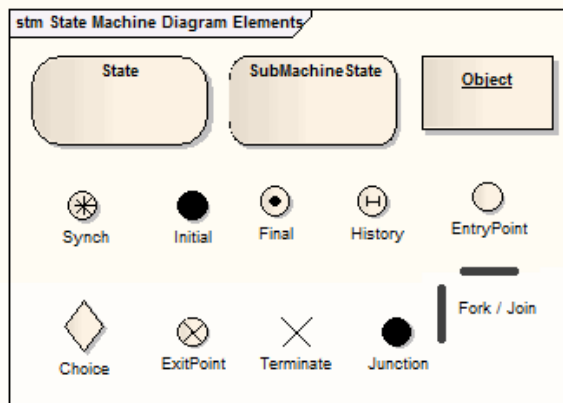
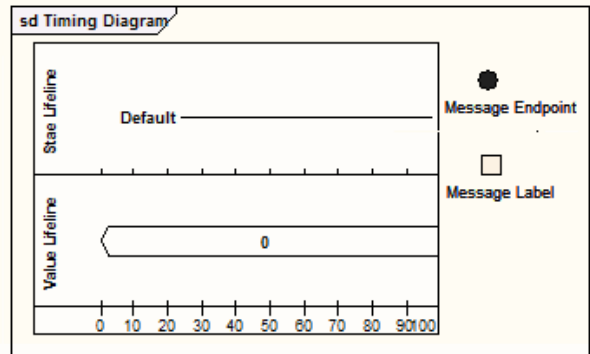
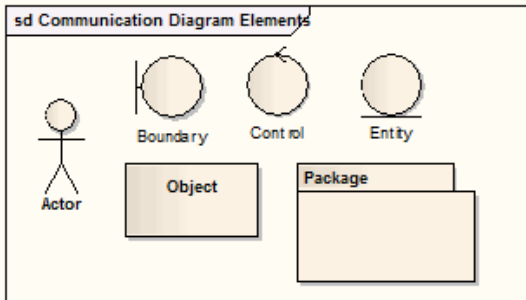
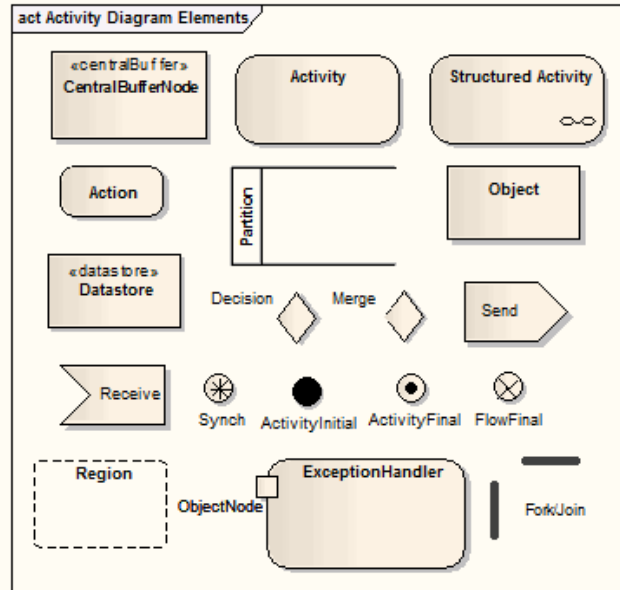
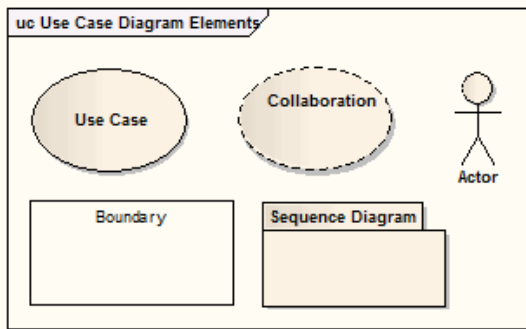

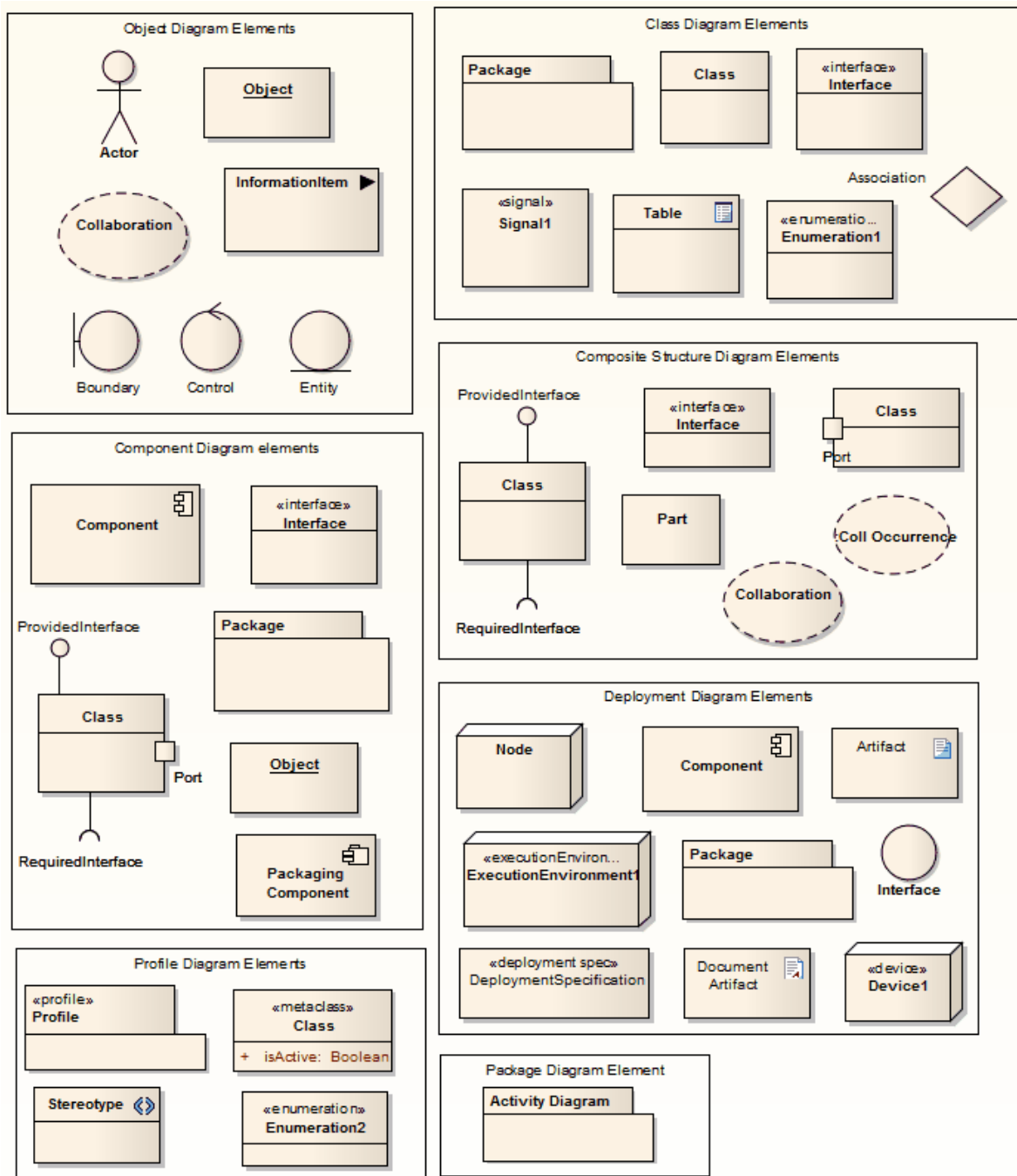

### 4.6.1 Element Property Displays

To define, assign and review the properties and features of elements, you can use the following:

- [Properties Dialog](#) <sup>[481]</sup>
- [Properties Docked Window](#) <sup>[508]</sup>
- [Element Browser](#) <sup>[510]</sup>
- [Scenarios & Requirements Window](#) <sup>[514]</sup>
- [Select <Item> Dialog](#) <sup>[515]</sup>

### 4.6.1.1 Properties Dialog

This topic area describes element: properties and their settings; object files and classifiers; responsibilities; constraints; connectors; scenarios; Tagged Values; associated files and boundary element settings.

To display the element **Properties** dialog, use any of the following methods:

- Select an element in the **Diagram View** and select the **Element | Properties** menu option
- Right-click on an element in the **Diagram View**, and select the **Properties** context menu option
- Select an element in the **Diagram View**, and press **[Alt]+[Enter]**
- Double-click on an element in the **Diagram View**
- Right-click on an element in the **Project Browser**, and select the **Properties** context menu option.

To suppress display of the **Properties** dialogue when placing a new element, uncheck the **Edit Object on New** option on the **Objects** page of the **Options** dialog (**Tools | Options | Objects**).

#### Note:

There are several variations of the **Properties** dialog:

- The dialog for a Table or Stored Procedure element has slight differences on the **General** tab, and a **Table (Stored Procedure) Details** tab instead of a **Details** tab; see the [Working With Tables](#) topic.
- The dialog for a Class element of a stereotype other than Table is as shown in [General Settings](#).
- The dialog for an element of any other type does not have a **Details** tab.
- **Port** and **Part** elements have a **Property** tab.
- Activity elements have a **Behavior** tab, and Action and Invocation elements (depending on their type) have other tabs such as **Effect**, **Trigger** and **Call** tabs.
- **Action Pins** have a **Pin** tab.

In all cases, the **Properties** dialog is an expandable window, which you can stretch to enable longer entry and clearer inspection of the text field values.

The following topics describe each of the tabs in the Class **Properties** dialog in detail.

- [General](#)
- [Details](#)
- [Requirements](#)
- [Constraints](#)
- [Links](#)
- [Scenarios](#)
- [Files](#)
- [Tagged Values](#)

Follow the links for information on [Tagged Values](#), [Object files and Classifiers](#), and the [Boundary element](#) appearance.

#### 4.6.1.1.1 General Settings

The **General** tab of the element **Properties** dialog enables you to record information on the element as a container, such as the name, status, or scope.

The tab is illustrated below:

To define the element, complete the following fields:

Field	Use to
<b>Name</b>	Change the element's name.
<b>Stereotype</b>	(Optional) Type the name of a stereotype for the element, or click on the drop-down arrow and select one.
<b>Abstract</b>	Indicate that the element is abstract.
<b>Author</b>	Enter or select the name of the original author.
<b>Status</b>	Indicate the current status of the element (such as Approved, Proposed).

Field	Use to
<b>Scope</b>	Indicate the element's scope (public, private, protected, package).
<b>Complexity</b>	Indicate the complexity of the element (used for project estimation). Assign <b>Easy</b> , <b>Medium</b> or <b>Hard</b> .
<b>Alias</b>	Enter an alias (alternative display name) for the object.
<b>Language</b>	Select the programming language for the object.
<b>Keywords</b>	Enter free-text items such as keywords or context information. This can be filtered in <b>Use Case Metrics</b> and <b>Search</b> dialogs.
<b>Phase</b>	Indicate the phase this element is to be implemented in (for example, 1, 1.1, 2.0 ...).
<b>Version</b>	Enter the version of the current element.
<b>Notes</b>	Enter any notes text associated with the element, as described for the <a href="#">Notes</a> <sup>[641]</sup> window. You can format the notes text using the <a href="#">Notes</a> <sup>[642]</sup> toolbar at the top of the field.

Further facilities are made available by pressing the **Advanced** button. See [Advanced Settings](#) <sup>[463]</sup> for details.

#### 4.6.1.1.1 Advanced Settings

Some elements support additional attributes. These are *Generalizable* elements; click on the **Advanced** button on the element **Properties** dialog to set:

- **IsRoot** - the element is a root element and cannot be descended from another
- **IsLeaf** - the element is *final* and cannot be a parent for other elements
- **IsSpecification** - the element is a specification
- **IsActive** - the element is active; for example, an [Active Class](#) <sup>[812]</sup>
- **Multiplicity** - the number of instances of the element that can exist. The value displays on the element in a diagram, in the *Name* compartment. Use the format defined in the [Cardinality](#) <sup>[665]</sup> tab.

Advanced Options

Is Root

Is Leaf

Is Specification

Is Active

Multiplicity:

OK Cancel

#### 4.6.1.1.2 Details

The **Details** tab of the element **Properties** dialog enables you to define the structural and processing details for the selected Class element.

#### Note:

When launched from MDG Integration, the **Attributes** and **Operations** buttons are not available.

Field/Button	Use to
<b>Cardinality</b>	<p><b>Note:</b></p> <p>Cardinality and Multiplicity are effectively the same. It is recommended that you define the value in the <b>Multiplicity</b> field of the <a href="#">Advanced dialog</a><sup>[483]</sup>; this ensures that the value displays on the element in a diagram.</p> <p>Select the number of elements in a set for the Class.</p>
<b>Visibility</b>	Select the visibility of the Class.



Field/Button	Use to
<b>Attributes</b>	Define attributes for the Class. The <a href="#">Attributes Properties</a> <sup>[558]</sup> dialog displays.
<b>Operations</b>	Define operations for the Class. The <a href="#">Operations Properties</a> <sup>[570]</sup> dialog displays.
<b>Concurrency</b>	Specify how concurrent activities should be processed.
<b>Collection Classes</b>	Define Collection Classes (for generating code from Association connectors) that apply to this Class. The <a href="#">Collection Classes for Association Roles</a> <sup>[1345]</sup> dialog displays.
<b>Type</b>	Select the type of Class template parameter to add or list. You can also edit or delete parameters. See the <a href="#">Parameterised Classes</a> <sup>[813]</sup> topic.
<b>Arguments</b>	Select a parameter and type any required argument for that parameter.

#### 4.6.1.1.3 Requirements

The **Requirements** tab of the element **Properties** dialog enables you to define the requirements that this element is designed to meet.

Requirements are of two types: [internal requirements](#) <sup>[925]</sup> (responsibilities) and [external requirements](#) <sup>[487]</sup> (system requirements, elements connected to this element by a Realize connector). The **Requirements** tab lists both types, but you can only edit the internal type on this tab.

Requirement	Type	External
Log in to system	Performa...	
Password Protection	Functional	
Report on User Account	Functional	Yes
Req 00126	Functional	Yes

You can show the requirements for an element on the diagram directly, using the [Feature Visibility](#) <sup>[438]</sup> function. (It is also possible to show inherited requirements in this way).

Field/Button	Use to
<b>Requirement</b>	Enter the name and high level detail of the requirement.
<b>Type</b>	Specify the type; for example, <b>Functional</b> or <b>Non-functional</b> . Functional requirements are things that the system must <i>do</i> , such as identify franked, unfranked and total credit for a dividend; non-functional requirements are things that the system must <i>be</i> , such as reliable, cost effective.
<b>Last update</b>	Specify the date of the last requirement update.
<b>Status</b>	Specify the current status of the requirement.
<b>Difficulty</b>	Identify the complexity of implementing the current requirement.
<b>Priority</b>	Specify how urgent the requirement is.
<b>Stability</b>	Specify the estimated stability of the requirement.

Field/Button	Use to
	This is an indication of the probability of the requirement - or understanding of the requirement - changing. High stability indicates a low probability of the requirement changing.
Notes	Record details of the requirement. As for the <a href="#">Notes</a> [641] window, you can format the notes text using the <a href="#">Notes</a> [642] toolbar at the top of the field.
Move External	Make an <a href="#">internal responsibility into an external requirement</a> [926].
New	Create a new requirement.
Save	Save changes to requirements.
Delete	Delete a selected requirement.
Defined	List the defined requirements associated with this element.

#### 4.6.1.1.3.1 External Requirements

*External* requirements are those Requirement elements that have been connected to the current element using a *Realize* connector.

By creating a connector from an element to a requirement, you create an expectation that the element must implement the requirement as part of the system solution.

In Enterprise Architect, linked requirements are shown in the **Requirements** tab of the element **Properties** dialog, but they are marked *external* and cannot be directly edited (on selection, the tab fields are grayed out).

Double-click an external requirement in the list to activate the **Properties** dialog for the associated requirement, where you can view and modify the requirement details and check the requirement hierarchy details.

The screenshot shows a 'Properties' dialog box with three tabs: 'Properties', 'Files', and 'Tagged Values'. The 'Properties' tab is active. The 'Short Description' field is highlighted and contains the text 'Store User Details'. Below it are fields for 'Alias', 'Status' (Proposed), 'Type' (Functional), 'Difficulty' (Medium), 'Phase' (1.0), 'Priority' (Medium), 'Version' (1.0), 'Author' (Frederick Walter), 'Last Update' (27/05/2009), 'Key Words', and 'Created' (8/05/2009). At the bottom is a 'Notes' text area with a rich text editor toolbar. The notes contain the text: 'A facility is required to securely store user details separately from the customer database.' The dialog has 'OK', 'Cancel', and 'Help' buttons at the bottom.

#### See Also

- [Create Requirements](#)<sup>[918]</sup>
- [Make Internal Requirement External](#)<sup>[926]</sup>

#### 4.6.1.1.4 Constraints

Elements can have associated constraints placed on them. These are the conditions under which the element must exist and function.

Typical constraints are pre- and post- conditions, which indicate things that must be true before the element is created or accessed and things that must be true after the element is destroyed or its action complete.

Use the [Feature Visibility](#)<sup>[438]</sup> function to show constraints for an element directly on the diagram (it is also possible to show inherited constraints in this way).

#### Add Constraints to a Model Element

To add constraints to a model element, follow the steps below:

1. Open the element **Properties** dialog.
2. Select the **Constraints** tab.

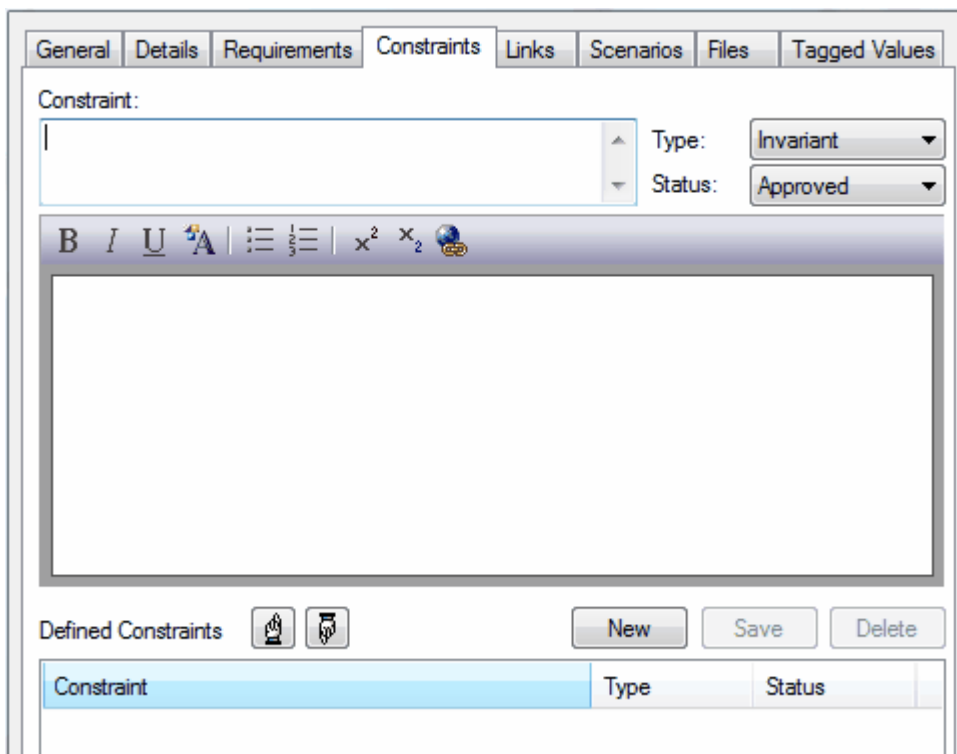

3. In the **Constraint** field, type the name of the constraint.
4. In the **Type** and **Status** fields, click on the drop-down arrow and select the constraint type (**Pre-condition**, **Post-condition** or **Invariant**) and status.
5. In the larger text field, type any additional notes required.
6. Click on the **Save** button.

Constraints are used in conjunction with [responsibilities](#) [485] to define the conditions and rules under which an element operates and exists.

#### 4.6.1.1.5 Links

The **Links** tab of the element **Properties** dialog displays a list of all relationships (connectors) active for the current element.

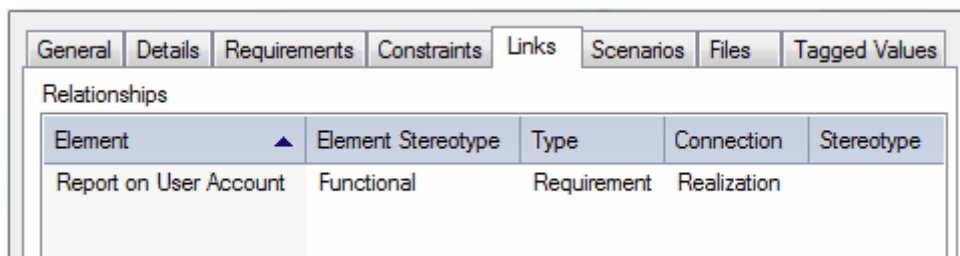

The **Relationships** panel lists the relationships this element has. The:

- **Element** column identifies the elements this element is related to
- **Element Stereotype** column identifies the stereotype (if any) of the element
- **Type** column identifies the element type of the related element
- **Connection** column identifies the type of relationship
- **Stereotype** column identifies the stereotype (if any) of the relationship.

From the **Links** tab you can perform operations on a relationship, by right-clicking on the relationship to display the context menu.



To:

- Hide the relationship on the diagram, click on the **Hide Relation** menu option; the option then changes to **Show Relation**, which you select to redisplay the relationship on the diagram
- Display the relationship [Properties](#) <sup>[626]</sup> dialog, click on the **Relationship Properties** menu option
- Highlight the related element in the **Project Browser**, click on the **Locate Related Object** menu option
- Delete the relationship from the model and all diagrams, click on the **Delete Relationship** menu option; the system prompts you to confirm the deletion.

#### 4.6.1.1.6 Scenarios

A scenario is a real-world sequence of operations that you create to describe how an element works in real-time; for example, its functional behavior, business work flows and end-to-end business processes.

You can create scenarios in most types of element, but they are generally most applicable to Use Cases.

The **Scenario** tab of the element **Properties** dialog has two internal tabs:

- The **Description** tab, which enables you to create scenarios and provide a simple text description either of each scenario, or of the structure of each scenario.
- The [Structured Specification](#) <sup>[493]</sup> tab, which enables you to create scenarios or select those you have created elsewhere and, for each scenario:
  - Create a series of steps for each part of the scenario
  - Structure the scenario to show how the basic path diverges into the alternate paths and exception paths
  - Generate a [number of types of diagram](#) <sup>[499]</sup> from the structure
  - Generate a structured scenario [from an Activity diagram](#) <sup>[513]</sup>
  - Generate a structured scenario [from text on the clipboard](#) <sup>[496]</sup>; this option has a variation in the **Description** tab that enables you to [translate scenario descriptions](#) <sup>[497]</sup> created prior to release 8.0 of Enterprise Architect, into structured scenarios in the latest release.

#### Notes:

- The **Scenarios** tab does not prevent you from creating more than one basic path, but it would be unusual to define more than one.
- All the functions available on the **Scenarios** tabs are also available through the [Scenarios & Requirements](#) <sup>[514]</sup> window/view. Use the **Browse Element** icon in the window toolbar to list and select the scenarios for the element.

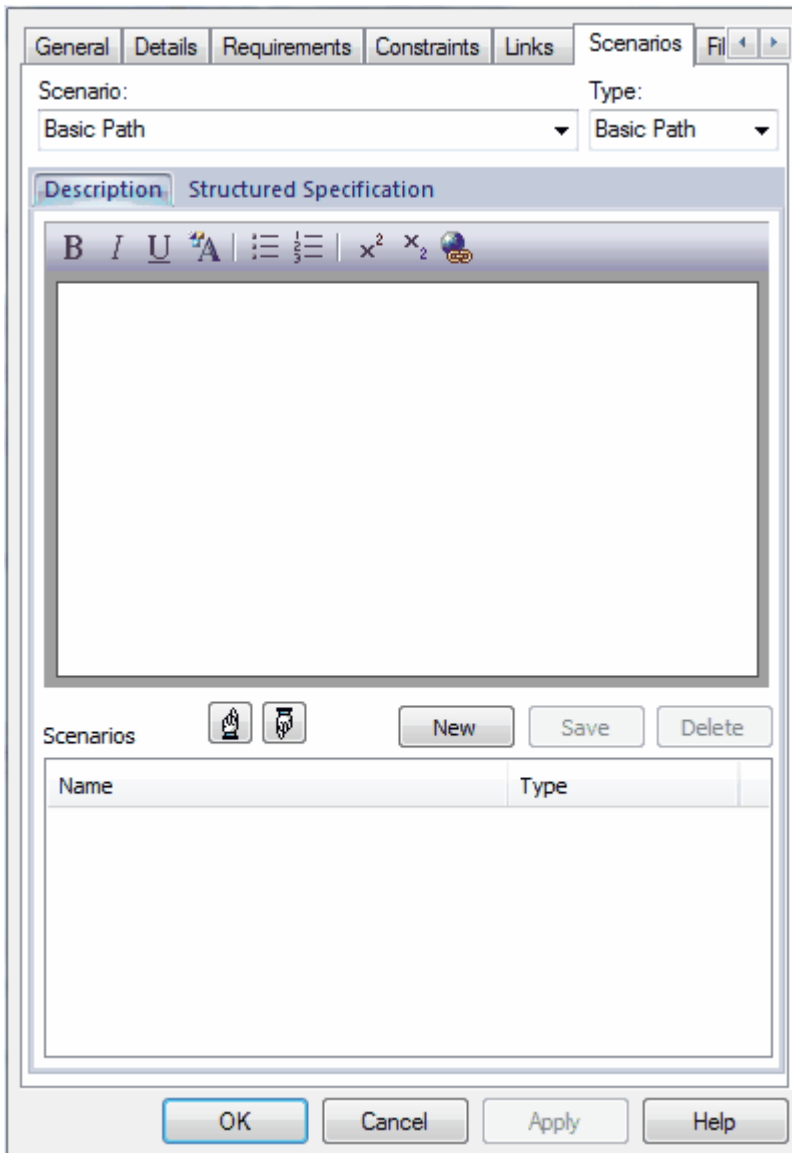

### Description Tab

When you first select the **Scenarios** tab, it defaults to the **Description** tab and sets both the **Scenario** (name) field and the **Type** field to **Basic Path**, to enable you to define the basic path first. You can overwrite the scenario name with more appropriate text if required. As you go on to create other scenarios, you set the type to **Alternate** or **Exception** as appropriate.



Complete the fields as described below.

Field	Use to
Scenario	Type in the name of the scenario (or, for existing scenarios, click on the drop-down arrow and select one from the list).
Type	Specify the type of scenario; the options are: <ul style="list-style-type: none"> <li>• <b>Basic Path</b> - the direct set of steps for the scenario</li> <li>• <b>Alternate</b> - an alternative set of steps, in parallel with part of the basic path</li> <li>• <b>Exception</b> - the path the scenario follows if a step of the basic path does not produce an appropriate result.</li> </ul>
Description	Record a textual description of how the user uses the current element. As for the <a href="#">Notes</a> window, you can format the notes text using the <a href="#">Notes</a> toolbar at the top of the field. As well as the <a href="#">Notes</a> window facilities, you can also generate a structured specification from the text in this field. Highlight the text, right-click on it and select the <b>Create Structure from Notes</b> context menu option.

Field	Use to
	The text is copied to the <a href="#">Structured Specification</a> <sup>493</sup> tab for the current scenario, either as a new specification or as the continuation of an existing specification, with a new step created at each carriage return. Subsequent changes to the text on the <b>Structured Specification</b> tab are not reflected on the <b>Description</b> tab.
<b>New</b>	Clear the data fields so that you can enter data in them to create a new scenario.
<b>Save</b>	Save a new scenario, or changes to an existing scenario.
<b>Delete</b>	Delete a scenario selected from the <b>Scenarios</b> panel, below.
<b>Scenarios</b>	Display a list of defined scenarios for this element.  You can change the order in which the scenarios are listed, using the  and  buttons.



#### 4.6.1.1.6.1 Structured Specification Tab

The **Structured Specification** tab, encompassing the *Structured Scenario Editor*, enables you to define the structure, actions and interactions of the [scenarios](#)<sup>[496]</sup> defined for an element such as a Use Case. These scenarios can be the main (basic) path, alternate paths, or exception paths.

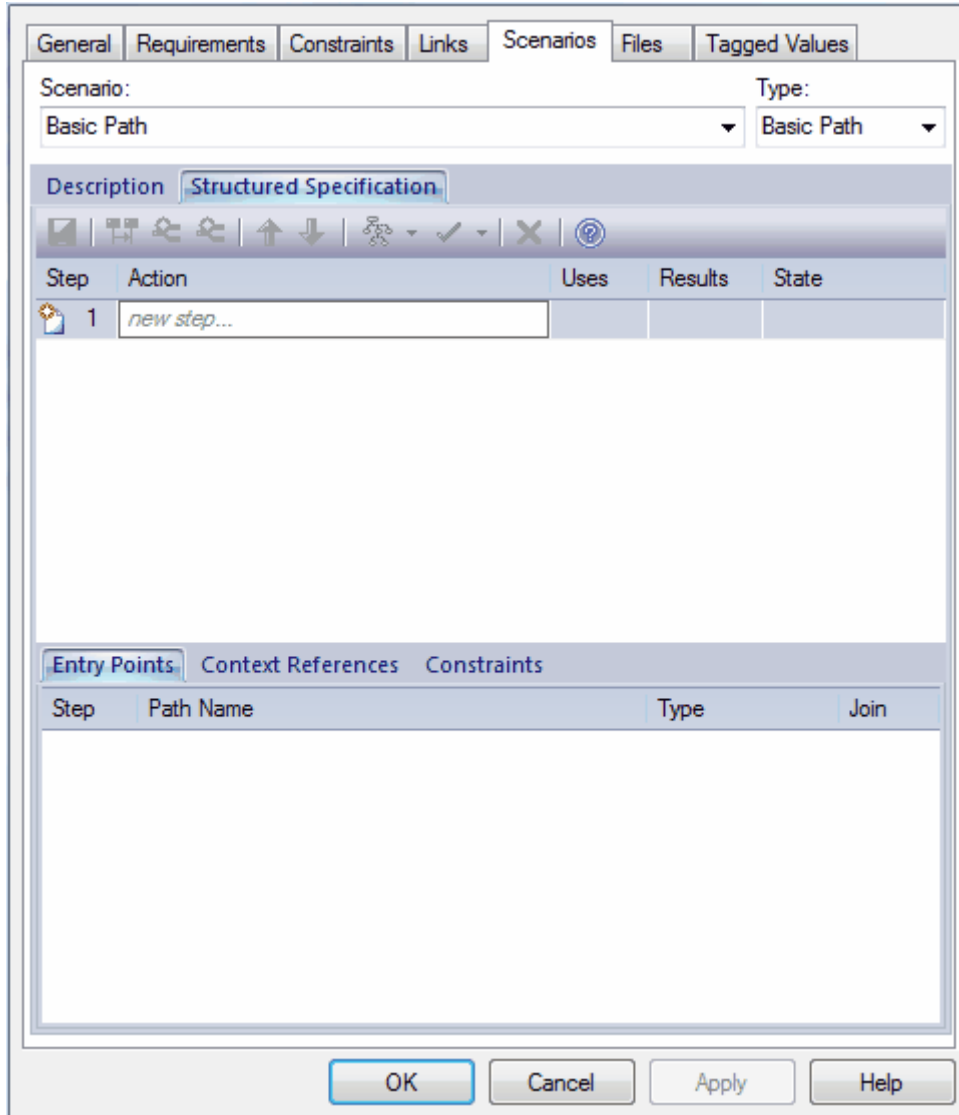

When you open the **Structured Specification** tab it defaults to the basic path (as shown above) so that if it does not already exist, you can create it. You can create alternate paths and exception paths as part of the process of adding them to steps of the basic path.

You can also create all three types of scenario paths on the [Description](#)<sup>[496]</sup> tab, or in the [Scenarios & Requirements](#)<sup>[514]</sup> window.

The **Structured Specification** tab offers a wide range of facilities for generating and modifying scenario specifications. These are available through the:

- [Structured Specification Toolbar](#)<sup>[495]</sup>
- [Item context menu](#)<sup>[496]</sup>
- [Selected Text context menu](#)<sup>[497]</sup>
- [Entry Points context menu](#)<sup>[498]</sup>
- [Floating Toolbar](#)<sup>[499]</sup>

You can create a specification for a scenario in one of several ways:

- Enter the specification yourself, as described below
- Generate a specification [from an Activity diagram](#)<sup>[513]</sup> created under a Use Case element
- Generate a specification [from the notes text](#)<sup>[490]</sup> of the scenario in the **Description** tab
- Generate a specification from [text held on the clipboard](#)<sup>[496]</sup>.

To enter the specification yourself, starting with the basic path, follow the steps below:

1. In the **Scenario** field, click on the drop-down arrow and select the *Basic Path* scenario.
2. In the *new step* field in the **Action** column, type the text of the first step or action.

**Notes:**

- By default, the steps begin with a user step (indicated by an *actor* icon) and alternate between user and system (indicated by a *screen* icon) steps. However, you can control the responsible entity assigned to a step by typing a keyword within the first 15 characters of the text in the **Action** column; either 'User' or 'Actor' for a user step, or 'System' for a system step.

Once a step has been saved, you can change the responsible entity by either double-clicking on the icon or right-clicking on the step, and selecting the **Set Step as 'System'** or **Set Step as 'User'** context menu option as required.

- An entry for the basic path displays in the **Entry Points** tab, as **Step 0** with no value in the **Join** column (the basic path does not rejoin itself).

3. Tab to the **Uses** column and, if necessary, type the name of each element used in this step.

**Note:**

The values in the **Uses**, **Results** and **State** columns, whilst optional, are significant if you want to [generate a diagram](#)<sup>[499]</sup> from the specification. If you type the name of an element linked to the current element (and listed in the [Context References](#)<sup>[506]</sup> tab), the element name is highlighted and underlined.

4. Tab to the **Results** column and, if necessary, type the outcome of completing this step.
5. Tab to the **State** column and, if necessary, type the name of the state into which the step moves the action.
6. When you move out of the **Action** column, the next *new step* field displays underneath. Repeat steps 2 to 5 as many times as is necessary.

The **Structured Specification** tab should now resemble the following illustration:

Step	Action	Uses	Results	State
1	First step of basic path	<a href="#">Customer</a>	Machine activated	ON
2	Continue, or go to <a href="#">alternate</a> step Access 1	<a href="#">Use Case 1</a>		
3	Continue main path	<a href="#">Customer</a>		
4	Continue or go to <a href="#">alternate</a> step ATM	<a href="#">ATM</a>	Machine Validating	VALIDATION
5	Continue on main path			
6	Continue, or if error go to Exception	<a href="#">Use Case 2</a>		
7	Continue and finish			
8	<i>new step...</i>			

Step	Path Name	Type	Join
0	In-House Account Processing	Basic Path	-
4a	ATM Path	Alternate	End
6a	Data Not Found	Exception	End



As you develop the scenario, you can [move steps](#)<sup>[495]</sup> to different positions in the scenario, and [insert](#)<sup>[497]</sup> *new step* lines within the body of the scenario.







You can also create [constraints](#)<sup>[507]</sup> on the element that have an impact on the scenarios.

Repeat the *Scenario Steps* procedure for each scenario you have created. You can now adapt, enhance and interrelate the scenario specifications using the facilities of the **Structured Specification** tab:

- [Structured Specification Toolbar](#)<sup>[495]</sup>
- [Item context menu](#)<sup>[496]</sup>
- [Selected Text context menu](#)<sup>[497]</sup>
- [Entry Points context menu](#)<sup>[498]</sup>
- [Floating Toolbar](#)<sup>[499]</sup>.

The icons on the **Structured Specification** toolbar offer the following facilities:

Icon	Use to
	Save changes to the scenario specification.
	Return to the basic path specification (if another specification is currently displayed).
	(Only enabled when the basic path is displayed - you cannot add an alternate path to another alternate path or an exception path.) Create a branch from the selected step to an alternate path scenario - select the path from the displayed list. If the appropriate scenario does not yet exist, double-click on the <i>new path</i> line and type the scenario name, then click off the line and back on to it. Click on the <b>OK</b> button.

Icon	Use to																				
	<p><b>Note:</b></p> <p>An entry for this alternate path displays in the <b>Entry Points</b> tab, as <b>Step a</b> of the basic path step it branches from; in the <b>Join</b> column, click on the drop-down arrow and select the number of the step at which action flows back to the basic path, or select <b>End</b> if the path terminates separately from the basic path.</p> <table border="1"> <thead> <tr> <th>Step</th> <th>Path Name</th> <th>Type</th> <th>Join</th> </tr> </thead> <tbody> <tr> <td>0</td> <td>In-House Account Processing</td> <td>Basic Path</td> <td>-</td> </tr> <tr> <td>2a</td> <td>Access1</td> <td>Alternate</td> <td>6</td> </tr> <tr> <td>4a</td> <td>ATM Path</td> <td>Alternate</td> <td>End</td> </tr> <tr> <td>6a</td> <td>Data Not Found</td> <td>Exception</td> <td>End</td> </tr> </tbody> </table>	Step	Path Name	Type	Join	0	In-House Account Processing	Basic Path	-	2a	Access1	Alternate	6	4a	ATM Path	Alternate	End	6a	Data Not Found	Exception	End
Step	Path Name	Type	Join																		
0	In-House Account Processing	Basic Path	-																		
2a	Access1	Alternate	6																		
4a	ATM Path	Alternate	End																		
6a	Data Not Found	Exception	End																		
	<p>(Only enabled when the basic path is displayed - you cannot add an exception path to another exception path or an alternate path.)</p> <p>Create a branch from the selected step to an exception path scenario - select the path from the displayed list. If the appropriate scenario does not yet exist, double-click on the <i>new path</i> line and type the scenario name, then click off the line and back on to it. Click on the <b>OK</b> button.</p> <p><b>Note:</b></p> <p>An entry for this exception path displays in the <b>Entry Points</b> tab, as <b>Step a</b> of the basic path step it branches from; in the <b>Join</b> column, click on the drop-down arrow and select the number of the step at which action flows back to the basic path, or select <b>End</b> if the path terminates separately from the basic path.</p>																				
	Move the currently-selected step one place up (including any <i>new step ...</i> entry).																				
	Move the currently-selected step one place down (including any <i>new step ...</i> entry).																				
	Display a list of diagrams that you can <a href="#">generate from the scenario</a> <sup>[499]</sup> ; select the type of diagram that you want to generate.																				
	<a href="#">Generate Test Cases</a> <sup>[505]</sup> based on this Use Case scenario; you can generate either internal Test Cases or External Test Cases.																				
	Delete the selected step from the scenario.																				
	Display the Help topic for this tab.																				

To display this context menu, right-click on a step or blank line on the **Structured Specification** tab. The following options are available:

Option	Use to
<p><b>Create Structure From Clipboard Text - New Line Delimited</b></p> <p><b>Create Structure From Clipboard Text - Sentence Delimited</b></p>	<p>Generate a set of steps from a text description or list captured on the clipboard. A new step is generated:</p> <ul style="list-style-type: none"> <li>• after each carriage return in the captured text (<b>New Lines</b>), or</li> <li>• for each sentence in the text; that is, after each full stop/space/capital letter combination (<b>Sentences</b>).</li> </ul> <p>If a set of steps is already displayed, it is overwritten by the generated steps.</p>

Option	Use to
<b>Create Structure From Generated Activity Diagram</b>	Generate a set of steps <a href="#">from an Activity Diagram</a> <sup>[513]</sup> created for a Use Case. If a set of steps is already displayed, it is overwritten by the generated steps.
<b>Add Alternate Path</b>	Create a branch from the selected basic path step to an alternate path (see previously).
<b>Add Exception Path</b>	Create a branch from the selected basic path step to an exception path (see previously).
<b>Insert Step Above [Shift]+[Insert]</b>	Insert a <i>new step...</i> line above the currently-selected step. (Press <b>[Esc]</b> to return this new line to the end of the scenario.)
<b>Insert Step Below [Insert]</b>	Insert a <i>new step...</i> line below the currently-selected step. (Press <b>[Esc]</b> to return this new line to the end of the scenario.)
<b>Insert End Step [Ctrl]+[n]</b>	Insert a <i>new step...</i> line at the end of the scenario.
<b>Set Step As 'User' Set Step As 'System'</b>	Switch the entity responsible for performing the action of the selected step between user and system.
<b>Link Step to Use Case</b>	<p>Either <i>include</i> the actions of an existing Use Case element, <i>extend</i> an existing Use Case element, or <i>invoke</i> a Use Case as the action of the selected step. Selecting the appropriate sub-option displays the <a href="#">Select Use Case</a> <sup>[515]</sup> dialog, which you use to browse for and select the required Use Case element.</p> <p>The appropriate <i>includes</i>, <i>extends</i> or <i>invokes</i> stereotyped connector is created between the current element and the selected Use Case.</p> <p>For the <i>include</i> and <i>extend</i> actions, any text in the <b>Action</b> field is overwritten by the link to the Use Case. For the <i>invoke</i> action, the following link is added to the end of the <b>Action</b> text:</p> <p>[Invokes: &lt;<a href="#">Use Case Name</a>&gt;]</p>
<b>Merge With Step</b>	Merge the selected step with another. A list of the other steps in the scenario displays; click on the step to merge with the selected step.
<b>Move After Step</b>	Move the selected step to another position in the scenario. A list of the other steps in the scenario displays; click on the step after which to position the selected step.
<b>Delete</b>	Delete the selected step. A prompt displays to confirm the deletion. Any subsequent steps are moved up one place.

To display this context menu, *highlight* the text in a user-editable field within a step on the **Structured Specification** tab. The following options are available:

Option	Use to
<b>Create</b>	Create a <a href="#">glossary definition</a> <sup>[647]</sup> or a <a href="#">new element</a> <sup>[524]</sup> based on the highlighted text.
<b>Link Step to Use Case</b>	<p>Either <i>incorporate</i> the actions of an existing Use Case element, <i>extend</i> an existing Use Case element or <i>invoke</i> a Use Case element, as the action of the selected step. Selecting the appropriate sub-option displays the <a href="#">Select Use Case</a> <sup>[515]</sup> dialog, which you use to browse for and select the required Use Case element.</p> <p>Any text in the <b>Action</b> field is overwritten by the link to the Use Case, except for the <i>invoke</i> action where the following link is added to the end of the <b>Action</b> text:</p> <p>[Invokes: &lt;<a href="#">Use Case Name</a>&gt;]</p>

Option	Use to
<b>Link to existing Element</b>	( <b>Uses</b> and <b>Results</b> fields only.) Create a Realization or Dependency relationship to a Requirement, Feature or other element elsewhere in the model.  You select the element and connector types from submenu options, which then display the <a href="#">Select Element</a> <sup>[515]</sup> dialog, which you use to browse for and select the required element.
<b>Insert context reference</b>	Add a reference to an element stored elsewhere in the model, and create an entry for the element in the <a href="#">Context References</a> <sup>[508]</sup> tab.  Selecting this option displays the <a href="#">Select Element</a> <sup>[515]</sup> dialog, which you use to browse for and select the required reference element.  See also the <a href="#">Structured Specification Floating Toolbar</a> <sup>[499]</sup> topic.
<b>Insert glossary definition</b>	Insert an existing glossary term at the cursor position. To select the term, double-click on it in the displayed list.  When you select the term it is inserted into the field as highlighted and underlined text, which displays the definition when you move the cursor over it. If you highlighted part of the original text, the term overwrites that text.
<b>Split Step</b>	Splits the selected step into two consecutive steps.  The option is available only if you highlight a <i>portion</i> of the text in the selected field. The new step takes the highlighted text as its <b>Action</b> text.
<b>Search for &lt;text&gt;</b>	Displays a sub-menu of options for <a href="#">locating the selected text in a number of locations</a> <sup>[1437]</sup> .
<b>Undo</b>	Undo any unsaved changes you have just made in the step.
<b>Cut</b>	Perform simple editing operations on the highlighted text.
<b>Copy</b>	
<b>Paste</b>	
<b>Delete</b>	
<b>Select All</b>	

The **Entry Points** tab shows how the basic path, alternate path and exception path scenarios for the element are organized and interrelated.

If an alternate path or exception path has been defined but has not yet been added to the basic path, it is not listed on this tab.

You can switch focus between the **Entry Points** tab and the **Structured Specification** tab by pressing **[Alt]+[Q]**.

To display the context menu for this tab, highlight an entry and right-click on it. The following options are available:

Option	Use to
<b>Edit Path</b>	Display the steps of the scenario in the <b>Structured Specification</b> tab, with the first step highlighted.
<b>Join with Step</b>	(Available only if the basic path scenario is displayed in the <b>Structured Specification</b> tab. Not available to edit the basic path scenario.)  Highlight the <b>Join</b> field and its drop-down arrow. Click on the drop-down to define or change the step number at which the alternate or exception path rejoins the basic path. Select <b>End</b> if the path does not rejoin the basic path steps.

Option	Use to
<b>Remove Entry Point</b>	(Available only if the basic path scenario is displayed in the <b>Structured Specification</b> tab. Not available to delete the basic path.) Delete the relationship between the selected path and the basic path, and remove the entry from the <b>Entry Points</b> tab.

Wherever a reference to another element exists on the **Scenario** tab (that is, where the text is highlighted and underlined), if you hover the cursor over the element name a short floating toolbar displays, which you can use to:

- display the element **Properties** dialog
- locate the element in its parent diagram
- locate the element in the **Project Browser**.

#### 4.6.1.1.6.2 Generate Diagrams

If you have created a structured scenario, you can generate any of the following diagrams from that scenario:

- [Activity](#) <sup>[500]</sup>
  - With [ActivityParameter](#) <sup>[500]</sup>
  - With [Action](#) <sup>[500]</sup>
  - With [Action Pin](#) <sup>[500]</sup>
- [Rule Flow](#) <sup>[501]</sup>
- [State Machine](#) <sup>[501]</sup>
- [Sequence](#) <sup>[503]</sup>
- [Robustness](#) <sup>[504]</sup>

To generate the required diagram, follow the steps below:

1. Create the scenario structure on the [Structured Specification](#) <sup>[493]</sup> tab.
2. Click on the **Generate Diagram** icon (  ) in the toolbar on the tab.
3. Click on the type of diagram to generate.

Enterprise Architect generates the diagram and notifies you that generation is complete. Close the **Properties** dialog to review the diagram.

If the diagram being generated already exists under the selected element, the following prompt displays:

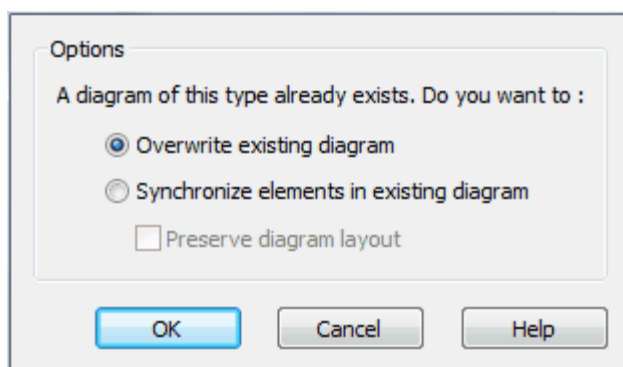

Select the appropriate radio button to:

- Overwrite the existing diagram (delete the existing diagram and elements, and create a new diagram and elements) or
- Synchronize the elements in the existing diagram with the scenario steps (however, Sequence and Robustness diagrams cannot be synchronized).

**Note:**

The **Synchronize elements in existing diagram** option enables the **Preserve Diagram Layout** checkbox, which you can select to preserve the existing arrangement of elements and connectors on the diagram. Any *new* elements are added to the diagram in the default position, and you manually position them in the diagram as required. If you do not select the checkbox, the diagram is recast in the default layout.

It is recommended that you uncheck the **Preserve Diagram Layout** checkbox if you are synchronizing elements with scenario steps:

- When new steps have been added or existing steps have been deleted or moved within the Use Case
- For the first time in a Use Case that has been [imported from XML](#) <sup>[290]</sup> with the **Strip GUIDs** option selected
- For the first time in a Use Case that has been [copied and pasted](#) <sup>[53]</sup> in the **Project Browser**, or
- For the first time in a Use Case whose containing package has been [copied and pasted](#) <sup>[388]</sup> in the **Project Browser**.

An Activity is generated as a child of the selected element, to act as a container for the diagram.

- The scenario steps are modeled as Activities
- The values of the *Uses*, *Results* and *State* columns for each step are added as Tagged Values of the corresponding Activity.

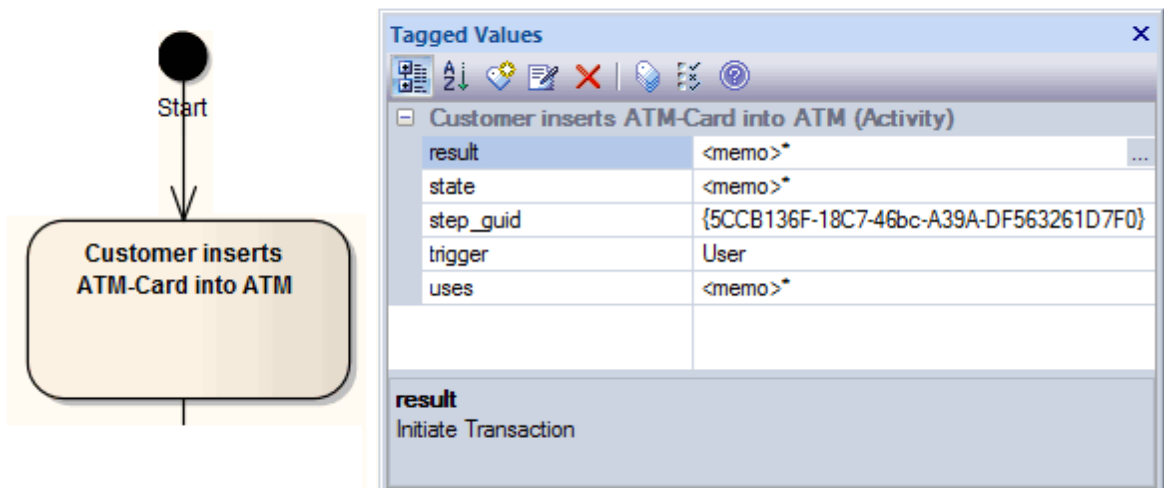
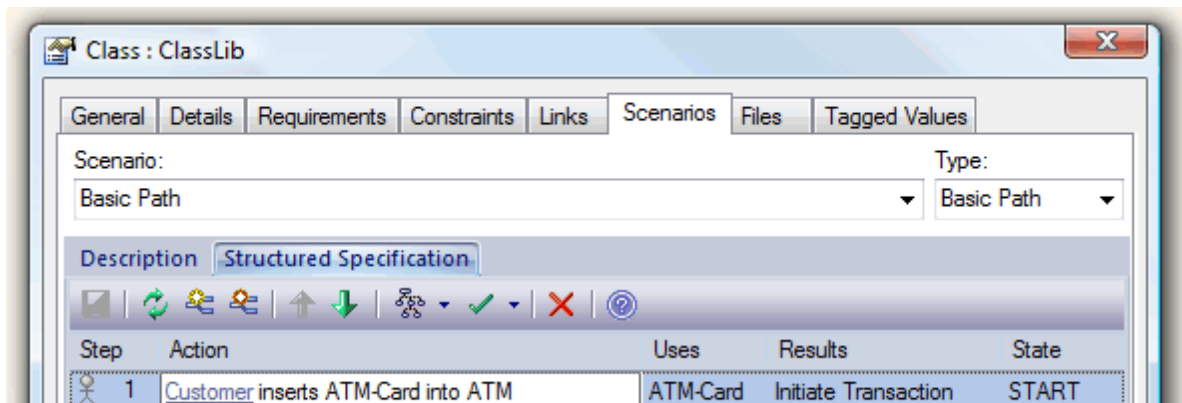
**Activity with ActivityParameter**

- The values of the *Uses* and *Results* columns are modeled as ActivityParameters
- The value of the *State* column is added as a Tagged Value of the Activities.



**Note:**

ActivityParameters are added to the **Project Browser** and not to the diagram.

**Activity with Action**

- The scenario steps are modeled as Actions
- The values of the *Uses*, *Results* and *State* columns are added as Tagged Values of the Actions.

**Activity with ActionPin**

- The scenario steps are modeled as Actions
- The values of the *Uses* and *Results* columns are modeled as Input Pins and Output Pins respectively
- The value of the *State* column is added as a Tagged Value of the Actions.

**Note:**

ActionPins are added to the **Project Browser** and not to the diagram.

A Rule Flow Activity is created as a child of the selected element, to act as a container for the diagram.

- The scenario steps are modeled as RuleTasks.
- The values of the *Uses*, *Results* and *State* columns are added as Tagged Values of the RuleTasks.

A StateMachine is created as a child of the selected element, to act as a container for the diagram.

- Each value in the *State* column is modeled as a State.
- The scenario steps become the Transition connectors between the States
- The values of the *Uses* and *Results* columns are added as Tagged Values of the Transitions.

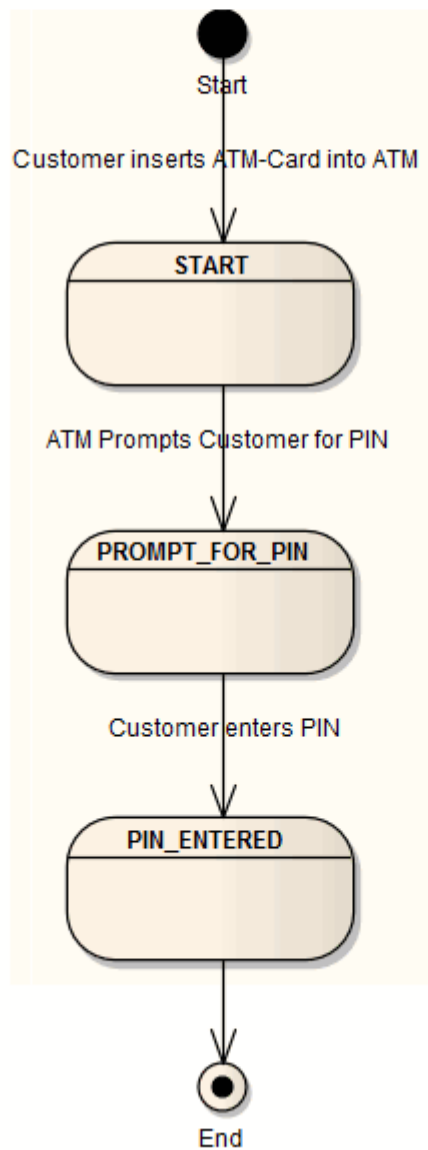
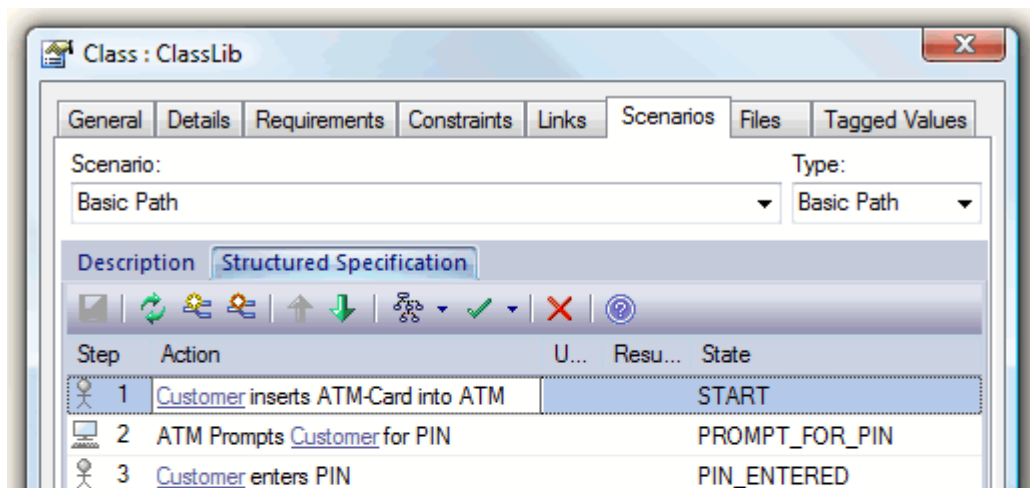

An Interaction is created as a child of the selected element, to act as a container for the diagrams - the Basic, Alternate and Exception paths are modeled as separate Sequence diagrams under the Interaction.

**Note:**

All the elements involved in the scenario should be identified in the [Context Reference](#) <sup>[506]</sup> tab. That is, relationships must already exist between the scenario parent element and the other elements named in the scenario.

- Each Context Reference element named in a scenario step is modeled as a Lifeline
- The step itself becomes the Message between an originator and its destination(s)
- The first Context Reference element in a step is treated as the originator
- The subsequent Context Reference element(s) become the destination(s).

**Note:**

Because the diagram generator acts on element names in the step, you should take care to avoid using the element names as normal text. For example, in step 1 in the dialog below, the term *ATM-Card* is interpreted as a reference to the ATM element, and **two** *Customer inserts ATM-Card into ATM* Messages are generated for the step. (To avoid confusion, in the diagram the first Message has been deleted.)

- The values of the *Uses*, *Results* and *State* columns are added as Tagged Values of the Message.

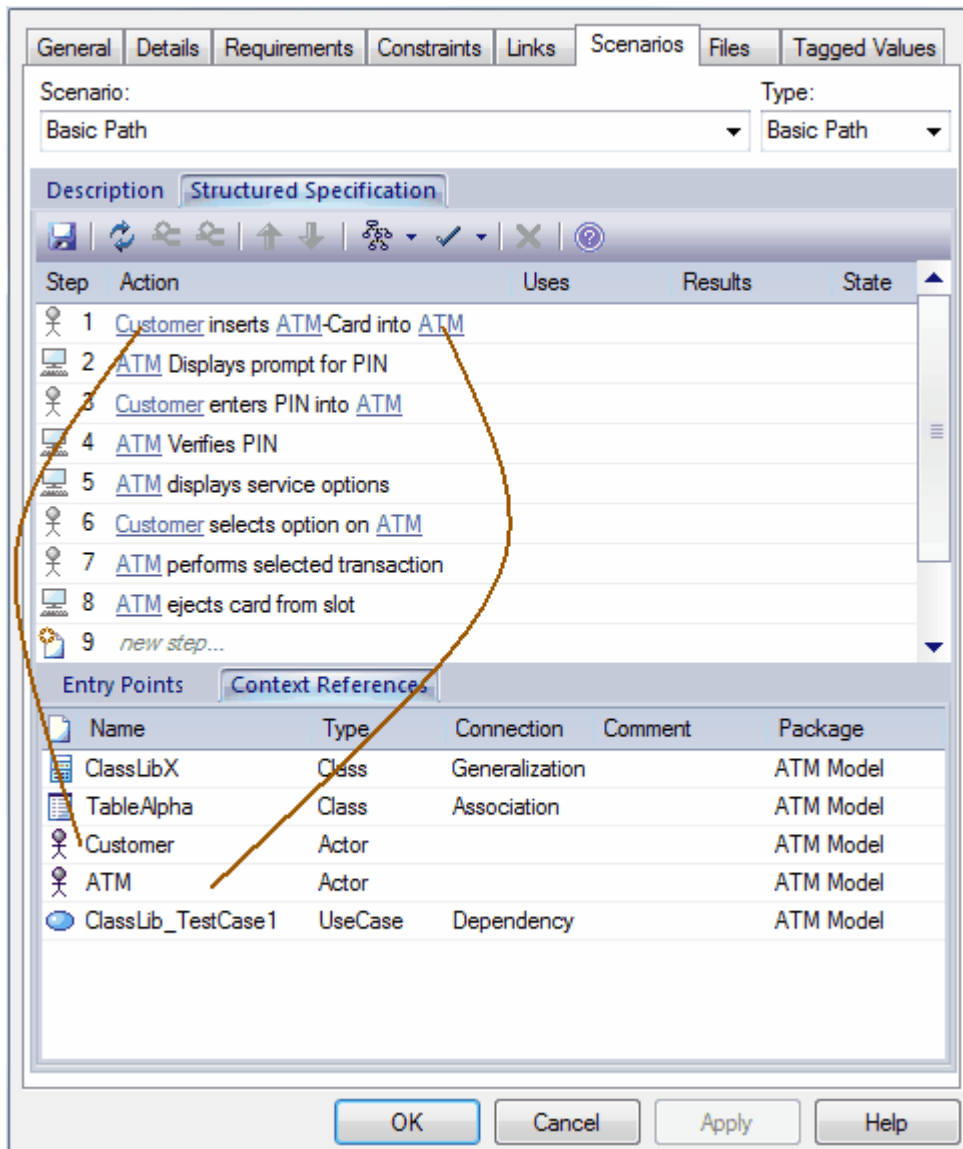

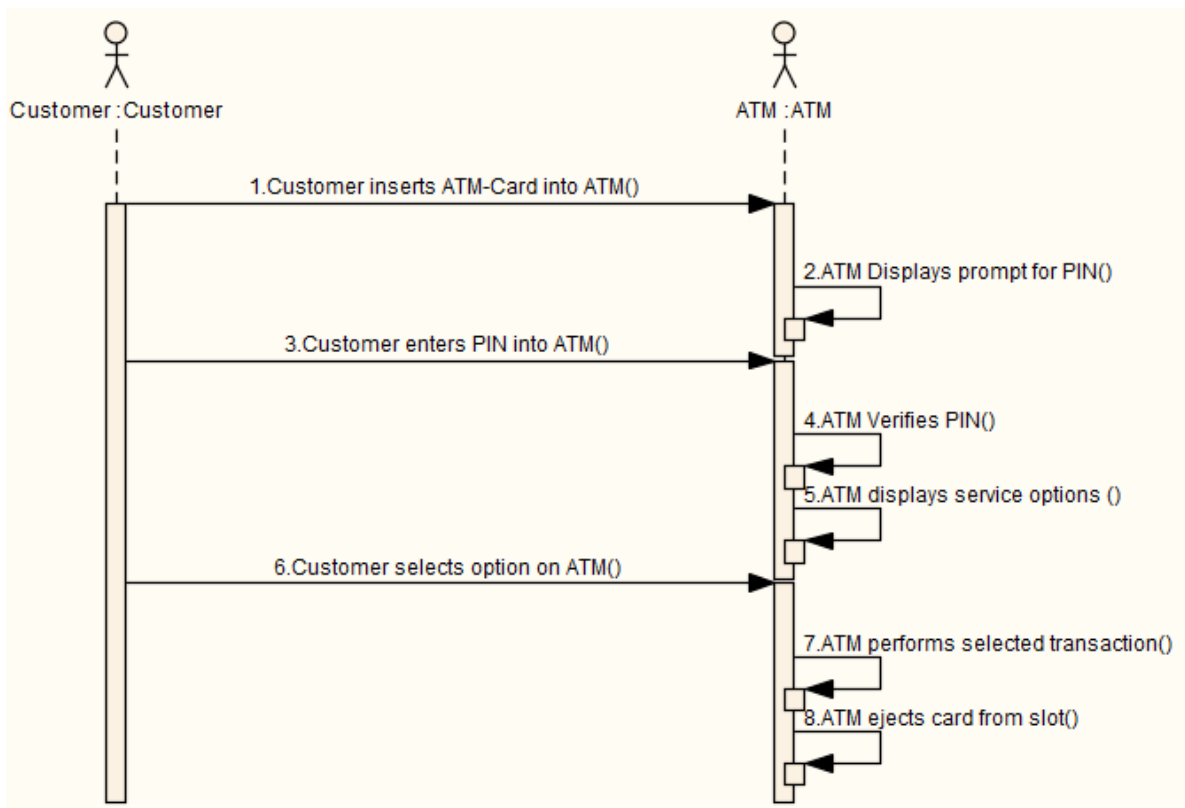

A [Collaboration](#) [814] is created as a child of the selected element, to act as a container for the [Robustness](#) [835] diagram.

#### Notes:

- All the elements involved in the scenario should be identified in the [Context Reference](#) [506] tab. That is, relationships must already exist between the scenario parent element and the other elements named in the scenario.
- Any values in the **Uses**, **Results** and **State** columns are ignored and not represented in the diagram.
- Each [UI element](#) [849] in a step becomes a [Boundary](#) [836] element. A [Dependency](#) [861] relationship is created from this Boundary element to the UI element (this connector is not shown on the diagram).
- Each Actor referenced in a step is dropped into the Robustness diagram as a simple link.
- Each Class referenced in a step is dropped into the Robustness diagram as a simple link, and is given the stereotype *entity*.
- Each step with a *System* trigger becomes a [Controller](#) [838]. Alternate/exception path Controllers are displayed with a red background color.
- Each step with a *User* trigger becomes the name of the [Association](#) [855] between Controllers.

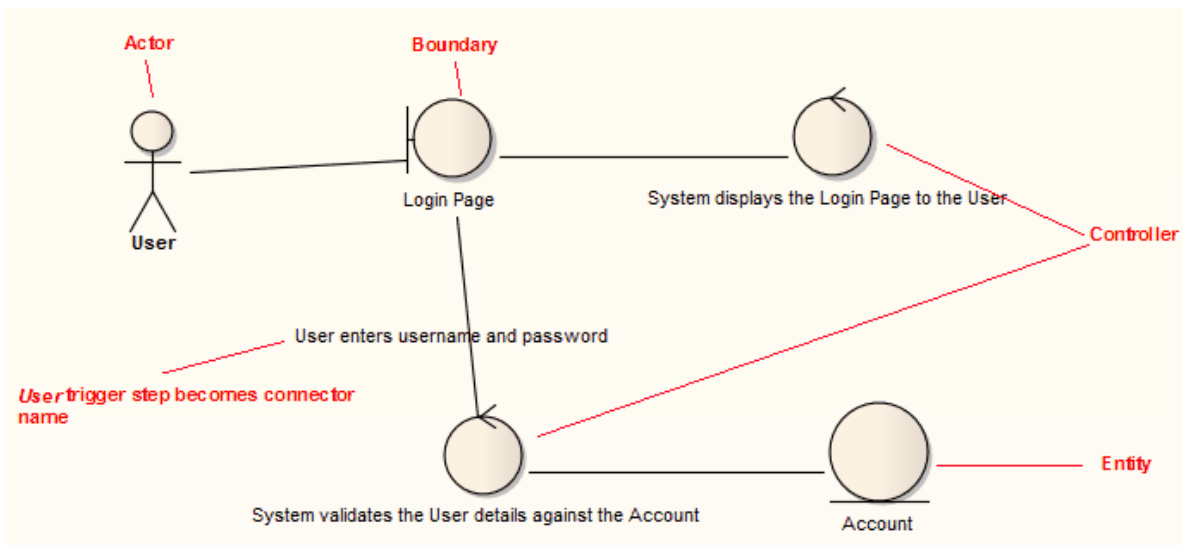
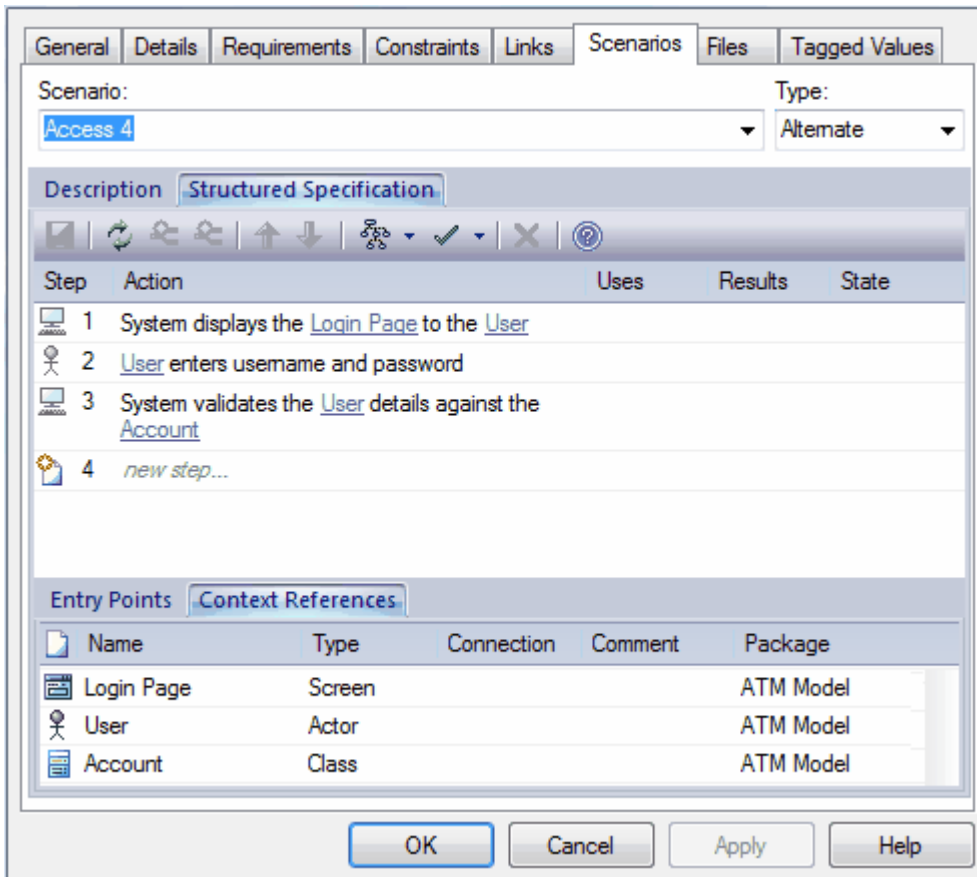

#### 4.6.1.1.6.3 Generate Test Cases

When you select a scenario and click on the **Test Case Generation** icon in the window toolbar, Enterprise Architect prompts you to select to generate either an Internal Test Case or an External Test Case.

##### Internal Test Case

A test is generated for the basic path and each alternate and exception path in the scenario, and added to the selected element. In addition, for each step in the basic, alternate and exception paths that has a value in the *Results* column, a test is generated and added to the selected element.

A diagram is created under the selected element, to which the selected element and a Note (showing the element's Structured Specification) is added. The created tests are displayed in the [Test Scripts compartment](#) <sup>[1549]</sup> of the selected element on the diagram.

Another way to view these tests is to click on the element and display the [Testing](#) <sup>[1537]</sup> window (**View | Testing**).

**Note:**

These generated tests are written to the **Scenario** test tab of the **Testing** window. You can [move](#) <sup>[1544]</sup> the tests to another test-type tab if required.

### External Test Case

A [Test Case](#) <sup>[848]</sup> element is created, linked to the selected element using the [Trace](#) <sup>[892]</sup> connector. A diagram is created under this Test Case element, to which the selected element, the Test Case element and a Note (showing the element's Structured Specification) is added. The created tests are displayed in the [Test Scripts compartment](#) <sup>[1549]</sup> of the Test Case element on the diagram.

A test case is generated and added to the Test Case element for the basic path, and for each alternate and exception path. In addition, for each step in the basic, alternate and exception paths that has a value in the *Results* column, a test is generated and added to the Test Case element.

**Note:**

You can review the tests within the Test Case element using the **Testing** window, as for Internal Test Cases.

#### 4.6.1.1.6.4 Context References Tab

On the **Scenarios** tab of the element **Properties** dialog, the **Context References** tab displays a list of all elements that are either:

- connected to the current element by any connector, on the current diagram or another, or
- defined as a cross reference (or [custom reference](#) <sup>[527]</sup>) on the current element.

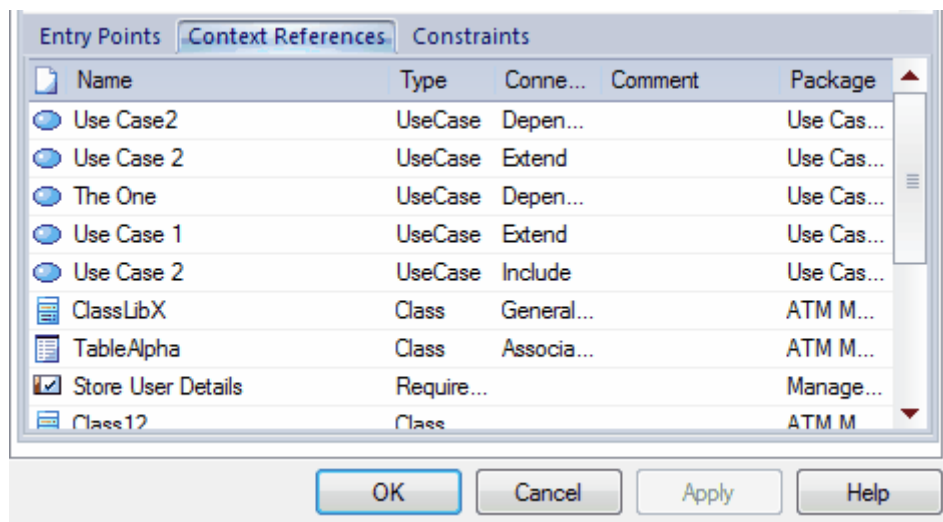

This tab enables you to add custom references - right-click anywhere in the list and select the **Add Reference** context menu option. The [Select Element](#) <sup>[515]</sup> dialog displays, in which you can locate and select the required cross reference element or elements. For each cross reference you can also use context menu options to delete the entry in the list, or to open the **Comment** field so that you can add or edit comment text.

For each element in the **Context References** list, wherever the name of that element appears in the structured specification, the name is highlighted and underlined. You can press **[Ctrl]+click** on the highlighted name to view the element **Properties** dialog.

#### 4.6.1.1.6.5 Scenario Constraints Tab

The Structured Specification **Constraints** tab is a simple link to the **Constraints** <sup>488</sup> tab of the element overall. It lists existing constraints; if you select the toolbar icons to add or edit a constraint, control switches to the element **Constraints** tab.

#### 4.6.1.1.7 Associated Files

An element can be linked to files held in the database, using the **Files** tab of the element's **Properties** dialog.

**Note:**

Linked files are a good way to link elements to additional documentation and/or source code.

You can also insert **hyperlinks** <sup>840</sup> in diagrams to other files, and launch them directly from the diagram. This is an alternative method to that described here.

Field/Button	Use to
<b>File Path</b>	Type in or browse for the directory path and name of the file.
<b>Type</b>	Display the local file or web address.
<b>Last Write</b>	Display the date and time the file was last updated.
<b>Size</b>	Display the size of the file.
<b>Notes</b>	Type in free text about the file.
<b>Files</b>	Display the list of linked files.
<b>Launch</b>	Open the selected file. Local files open with their default application and web files open in the default browser.

#### 4.6.1.1.8 Tagged Values Tab

The **Tagged Values** tab of the element **Properties** dialog simply provides the **Tagged Values** <sup>632</sup> window within the frame of the **Properties** dialog.

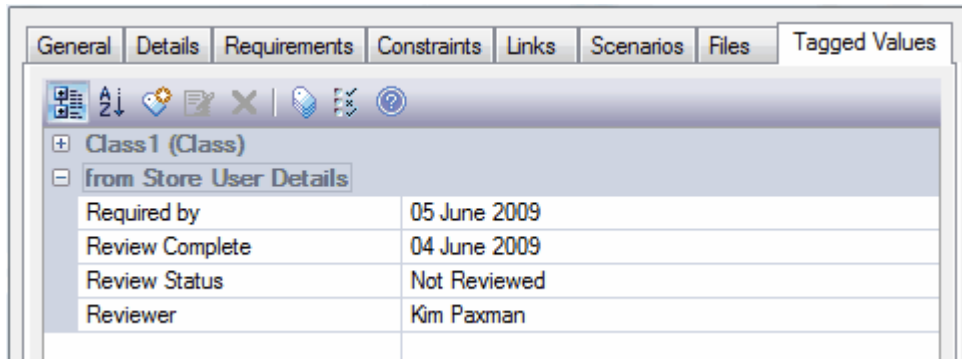

#### 4.6.1.2 Properties Docked Window

Access: **View | Element Properties**.

The **Properties** window provides a convenient way to view (and in some cases edit) common properties of elements. When an element is selected, the **Properties** window shows the element's name, stereotype, version, author, dates and other pertinent information.

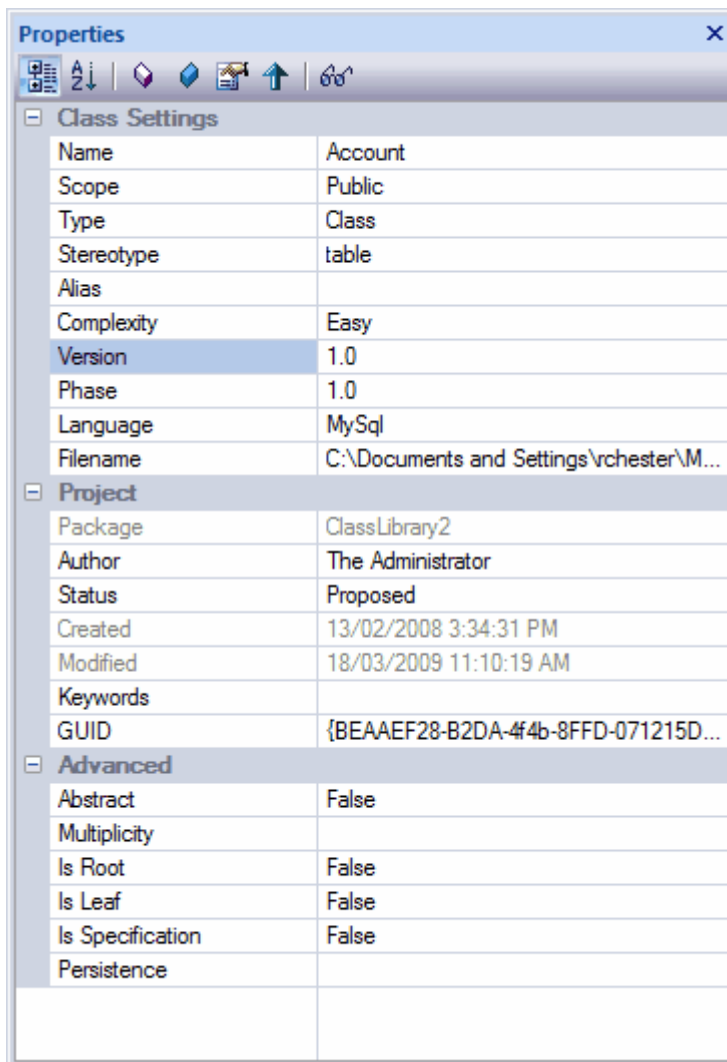

**Tip:**

The **Properties** window can be a quick method of setting a single property (such as **Phase** or **Status**). To access and edit all properties of an element, double-click on the element in a diagram or in the **Project Browser**.

**Properties Sections**

The **Properties** window is divided into three expandable sections:

- **<Element type> Settings** - for the basic element details
- **Project** - for general housekeeping settings
- **Advanced** - only active for generalizable elements.

**Notes:**

- When you click on a field name, a brief explanation of that field displays at the bottom of the **Properties** window, unless you have selected the **Hide Properties Info Section** <sup>[352]</sup> checkbox on the **General** page of the **Options** dialog (as for the above screen illustration).
- If you click on the field value for an editable field, a drop-down arrow displays that enables you to select a different value.

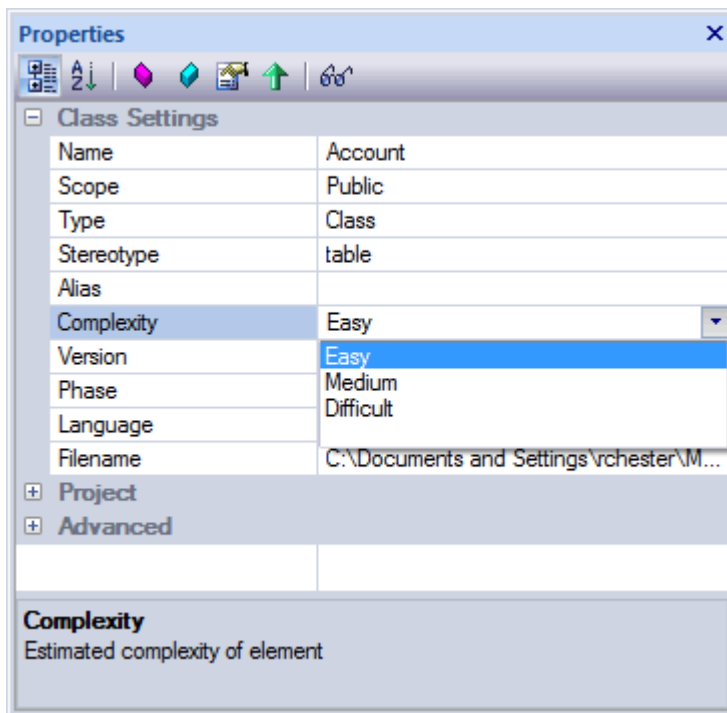

#### 4.6.1.3 The Element Browser

Access: **View | Element Browser**, or right-click on the **Main Menu** bar and select the **Element Browser** context menu option.

The **Element Browser** window lists a range of added-on properties of the selected element, as shown below both collapsed and fully expanded.

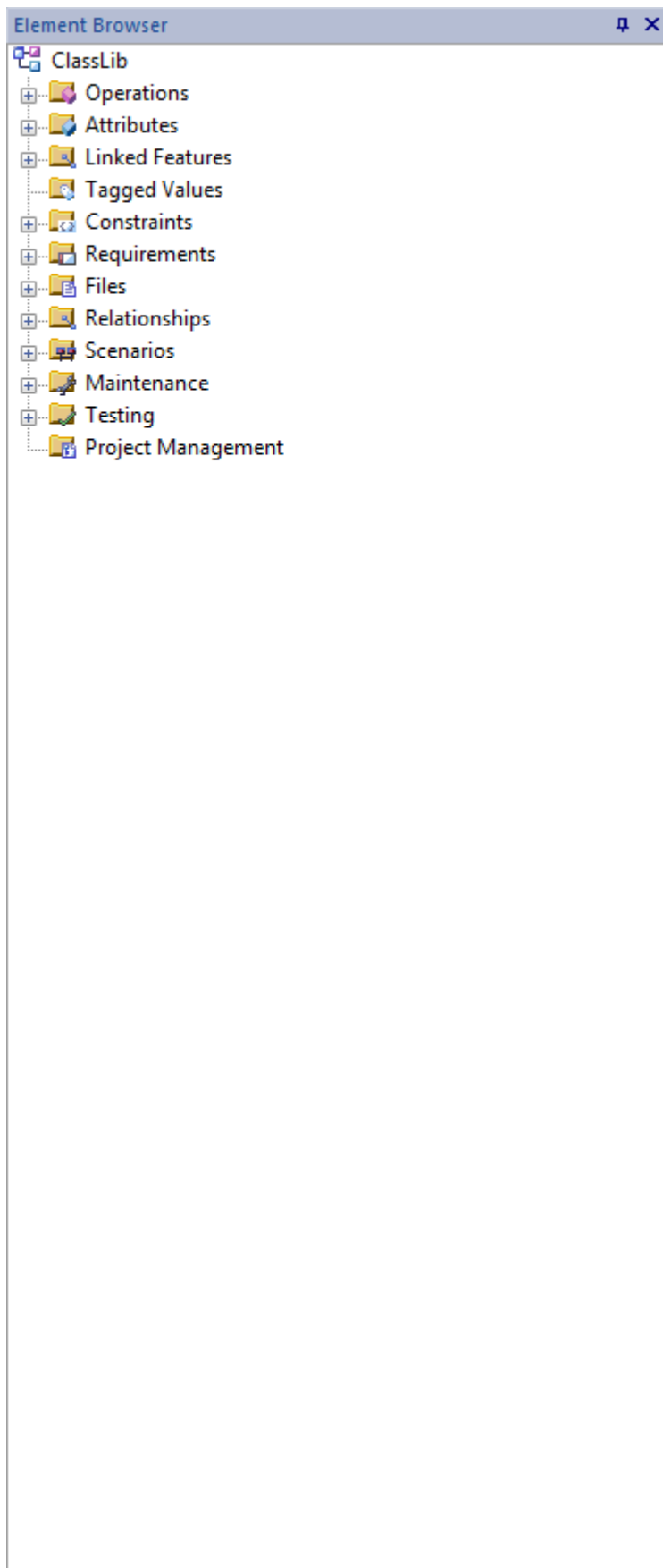

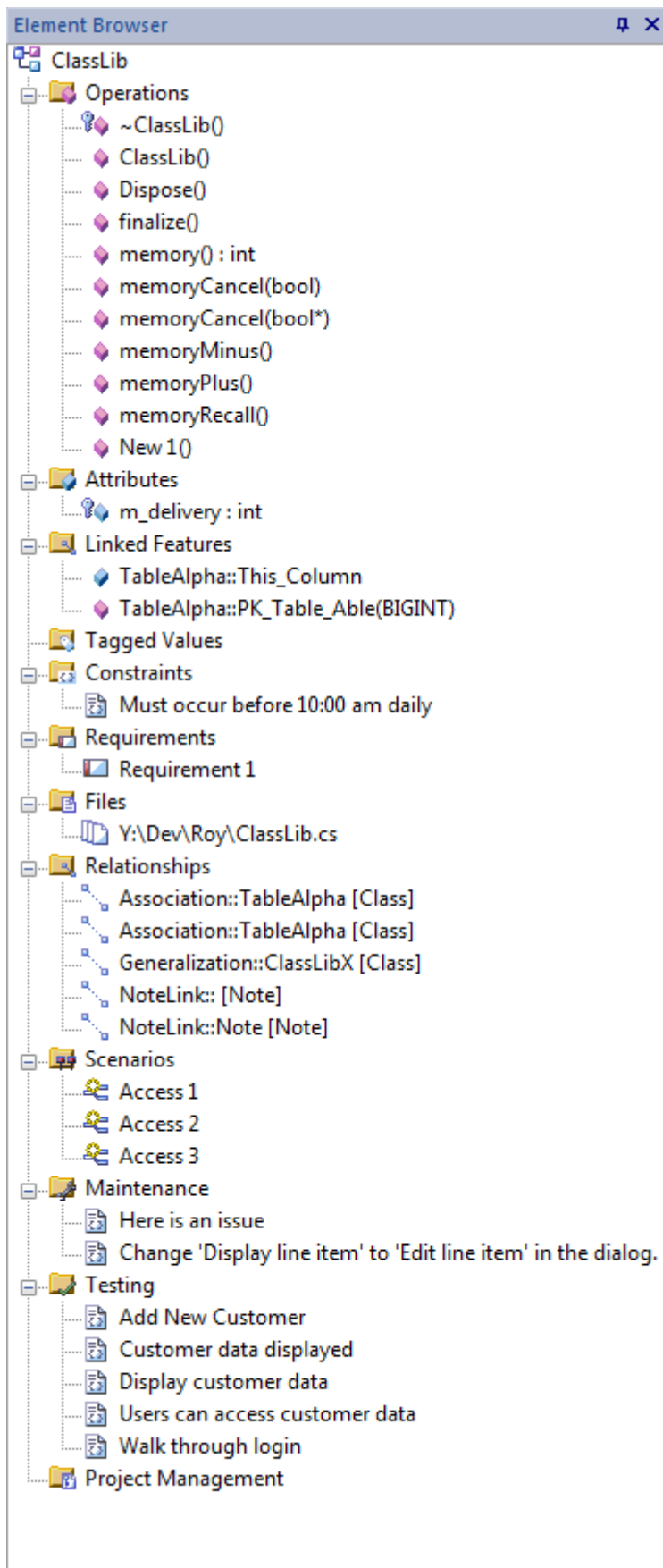

The following properties are listed, where they are present in the element:

- [Operations](#) <sup>[569]</sup>
- [Attributes](#) <sup>[558]</sup>
- [Linked Features \(Linked Operations and Attributes\)](#) <sup>[617]</sup>
- [Tagged Values](#) <sup>[632]</sup>
- [Constraints](#) <sup>[488]</sup>
- [Internal Requirements](#) <sup>[485]</sup> (Responsibilities)
- [Attached Files](#) <sup>[507]</sup>
- [Relationships](#) <sup>[489]</sup>
- [Scenarios](#) <sup>[490]</sup>
- [Maintenance Items](#) <sup>[1558]</sup>
- [Testing Items](#) <sup>[1537]</sup>
- [Project Management Items](#) <sup>[312]</sup>, <sup>[313]</sup>

#### Notes:

- If you double-click on the element name at the top of the dialog (the root node) the **Properties** dialog for the element displays, at the **General** tab.
- If you right-click on a folder name, the **Edit <object>** context menu option displays. When you select this option, the appropriate window or dialog displays, or the element **Properties** dialog displays the appropriate tab, to enable you to update the items in the folder.
- If you double-click on an item within the *Requirements*, *Scenarios* or *Constraints* folders, the [docked window or view](#) <sup>[514]</sup> displays with the focus on the selected item.
- If you double-click on an item within the *Relationships* folder, the relationship [Properties](#) <sup>[626]</sup> dialog displays for that relationship.
- If you double-click on an item within the *Files* folder, the file opens either on a separate tab in the **Diagram View** workspace (if the file can be opened within Enterprise Architect) or in the default Windows viewer/ editor for the file type (if the file cannot be opened within Enterprise Architect).
- If you double-click on an operation or attribute in the *Operations* or *Attributes* folders, the appropriate **Properties** dialog displays.
- If you right-click on an attribute or operation, whether in the *Attributes* or *Operations* folder or in the *Linked Features* folder, a context menu displays that enables you to display the source code; alternatively, click on the attribute or operation and press **[Ctrl]+[E]**, or - in the *Linked Features* folder - double-click on the attribute or operation.
- The source code viewer in which the source code displays depends on which editor you [select as the default](#) <sup>[1337]</sup>, either for the project as a whole or for a specific programming language. If you select the Enterprise Architect internal editor, the code displays in the [Source Code Viewer](#) <sup>[1441]</sup> with the cursor positioned on the selected feature.
- The right-click context menu for an operation also provides options to set a number of types of [recording marker](#) <sup>[1499]</sup>.

#### 4.6.1.3.1 Generate Scenario From Activity Diagram

You can [generate a range of diagrams](#) <sup>[499]</sup> from a scenario in an element.

Conversely, you can also generate a structured scenario within an element from an Activity diagram, reverse engineering the steps from the diagram elements (effectively either regenerating the scenario within the Use Case, or transferring a scenario into another Use Case).

#### Notes:

- The source Activity diagram must be generated from another Use Case Scenario.
- Any existing scenario steps are deleted and replaced by the generated scenario.
- This facility does not operate on the enhanced Activity diagrams generated from a Use Case - those generated with ActivityParameters, Actions and Action Pins.

To generate the scenario from the Activity diagram, follow the steps below:

1. Open the element **Properties** dialog, select the **Scenarios** tab, and select the **Structured Specification** tab.
2. Right-click in the empty space within the tab, and select the **Create Structure From Generated Activity Diagram** context menu option. The **Select an Activity** (generated from a UseCase Scenario) containing the Diagram dialog displays.
3. Search for and select the Activity containing the required diagram. Enterprise Architect validates the diagram (displaying the results in the **Output** window) and, if the diagram is valid, generates the scenario steps in the **Structured Specification** tab (replacing any existing scenario steps).

#### 4.6.1.4 The Scenarios & Requirements Window

Access: **View | Scenarios & Requirements**.

The **Scenarios & Requirements** window provides a convenient way to quickly add, view, edit and delete rules applied to an element.

The window shows details of the entities that impose such rules or restrictions on the element, namely:

- The element's internal responsibilities or requirements
- The element's internal constraints (not external **Constraint** notes)
- The element's scenarios.

The **Scenarios & Requirements** window is typically used to examine Use Case and Test Case elements, and any other elements that realize an external Requirement.

For convenience, you can display the window as either a dockable window around the edge of your workspace, or as a view in the center of your workspace (in which the Scenarios, Constraints and

Requirements are shown on separate tabs). Use the  icon in the window toolbar to toggle between these display options.

To review an internal requirement, constraint or scenario for an element:

1. Select the element in the **Project Browser** or diagram and either press **[Ctrl]+[Shift]+[3]** or select the **View | Scenarios & Requirements** menu option; the **Scenarios & Requirements** window displays.

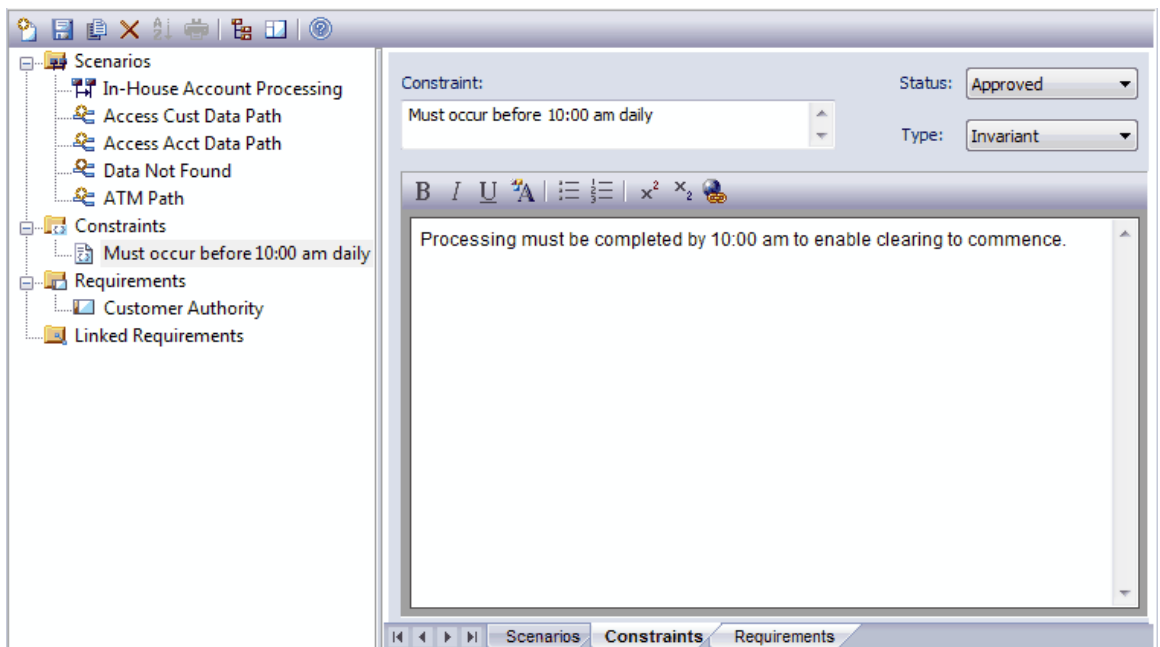

2. Either:
  - Click on the required item in the list panel on the left of the window, or
  - If the **Element Browser** is not already displayed, click on the  icon and select the required item from the **Constraints**, **Requirements** or **Scenarios** folder. The appropriate screen displays, with the details of the selected item in the fields.
3. The toolbar icons, from left to right, enable you to :

- Add a new rule to the current screen (click on the appropriate folder to create an item of a different type)
- Save the new or edited item
- Save the current (edited) item as a new item
- Delete the current item
- Sort the contents of the *selected* folder into alphabetical order
- (*Print icon unavailable*)
- Display the **Element Browser** window, or highlight the current item in the **Element Browser** window
- Switch between a docked window display and a workspace view display.

You can also add or edit formatted notes in the **Notes** field, using the [Notes](#)<sup>[642]</sup> toolbar at the top of the field.

The list panel also provides a context menu that provides options for adding a new item to a folder, deleting the selected item or, for a requirement, [converting an internal responsibility into an external Requirement](#)<sup>[926]</sup> element.

Click on these links for information on the fields of the [Scenarios](#)<sup>[490]</sup>, [Constraints](#)<sup>[488]</sup> and [Requirements](#)<sup>[485]</sup> tabs.

#### 4.6.1.5 Select <Item> Dialog

The **Select <Item>** dialog is a multi-purpose browser and search tool for locating model items such as Classifier elements, properties, attributes and behaviors.

The <Item> in the dialog title changes to represent the type of item the original operation is working on. The dialog is called in a range of operations; for example, setting:

- The base type or [classifier](#)<sup>[520]</sup> for an [Object](#)<sup>[823]</sup>, [Swimlane](#)<sup>[450]</sup> or [Lifeline](#)<sup>[783]</sup>
- Classifiers for the [return types](#)<sup>[570]</sup> for operations
- Classifiers for [generalization sets](#)<sup>[620]</sup>
- The associated behavior for a [behavior call](#)<sup>[582]</sup>
- The type and return type for [operation parameters](#)<sup>[593]</sup>
- [Activities for State transitions](#)<sup>[892]</sup>
- [Activities from which to generate Use Case Scenarios](#)<sup>[513]</sup>
- [Pattern element defaults](#)<sup>[904]</sup>
- The values of [Tagged Values](#)<sup>[635]</sup>.

To select a required item, follow the steps below:

1. During an operation, when it is necessary to locate an element or feature, you click on the [ ... ] (browse) button. The **Select <Item>** dialog displays.

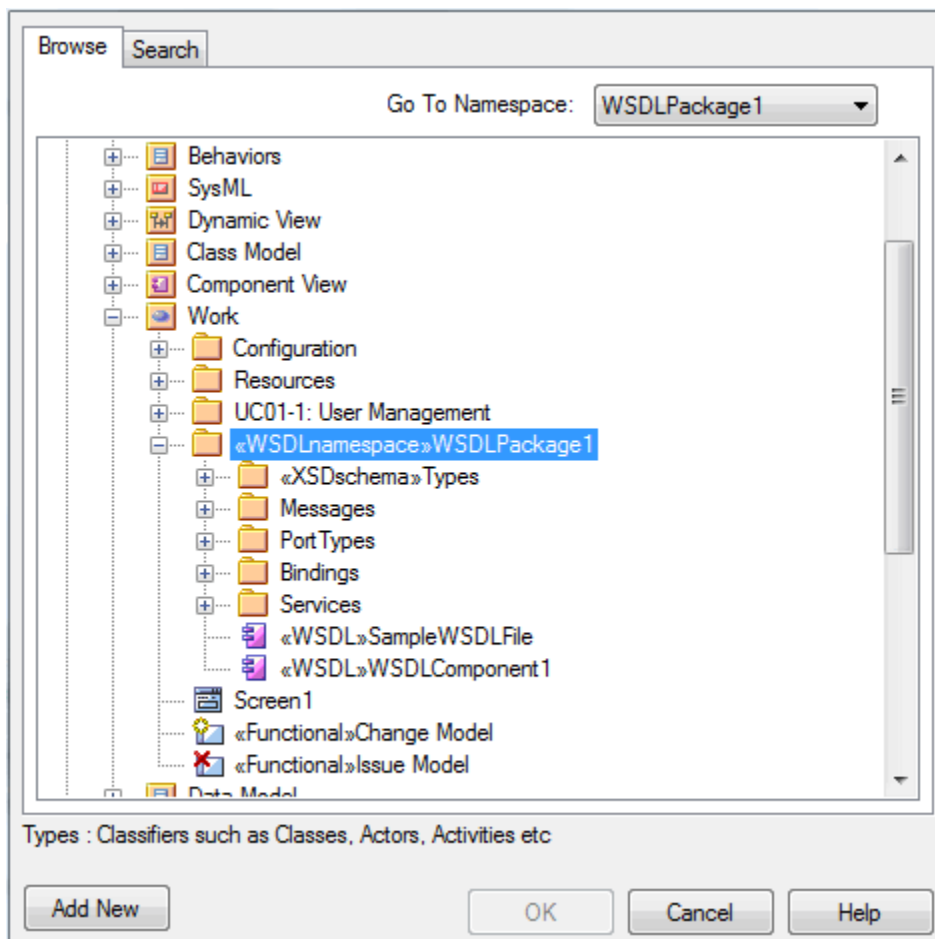

2. If required, in the **Go To Namespace** field select a namespace to reduce the scope of the displayed hierarchy. The dialog opens the section of the hierarchy associated with that namespace, and closes all previously-open sections associated with other namespaces.
3. You can either:
  - expand the selected area of the hierarchy on the **Browse** tab, or any other package, and locate the required item (go to step 5) or
  - click on the **Search** tab and, in the **Find** field, type a partial or complete text string to search for the item.

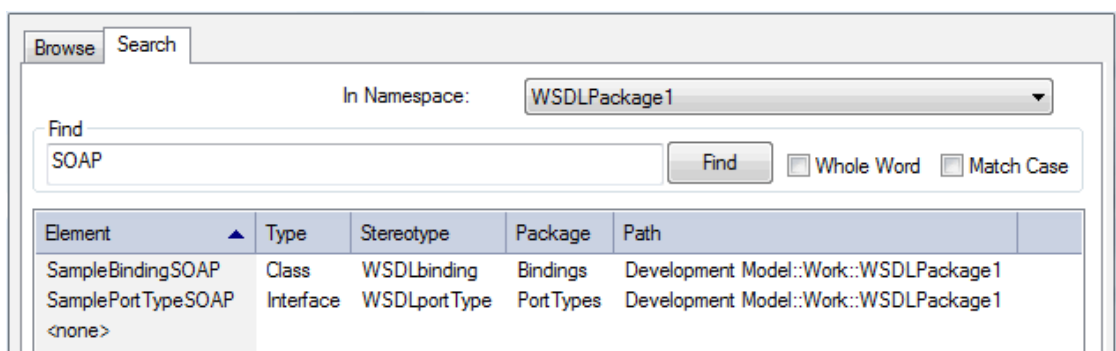

4. On the **Search** tab, you can filter the search further by selecting the **Whole Word** and **Match Case** checkboxes.

Each list entry shows the name of the item, the type, any stereotype the item has, the immediate package in which the item is held, and any successive parent packages (the package path). You can either:

- Select the item immediately on the **Search** tab or



- Right-click on one item or a group of items and select the **Locate item(s) in tree** context menu option; this redisplay the **Browse** tab and highlights each selected item in the <namespace> hierarchy.
5. Click on the required item.
  6. Click on the **OK** button.

**Note:**

When you have selected an item, the **Select <Item>** dialog retains the context and item. Next time you display the dialog, if the context is similar the dialog opens to the same Namespace and item. For example, if you have selected an activity for a State transition and you start to do the same for another transition, the dialog opens to the activity you previously selected.

If the context is totally dissimilar, the dialog opens with the Namespace <any> and a collapsed model hierarchy.

If the available items do not meet your requirements, you can create a new item and define the appropriate properties. Click on the **Add New** button. The appropriate **Add <Item>** dialog displays, on which you define the required item.

**Note:**

The **Add New** button is not always available, depending on the context and the type of item being searched for.

## Multiple Selection

Where an operation permits the selection of multiple items, the **Select <Item>** dialog is automatically enabled to support this. To select the items, press **[Ctrl]** as you click on each item. Having selected an item, you can continue to expand and browse the hierarchy, and/or search for items; the dialog retains the existing selections until you click on the **OK** button.

### 4.6.1.5.1 Select Property Dialog

The **Select Property** dialog is a specific instance of the **Select <Item>** <sup>[515]</sup> dialog; it is used to select Ports, Parts, Attributes and Association Ends as redefined or subsetted properties, from a *hierarchical list* of Classes and their contained properties in the model.

For example, consider the section of the model below:

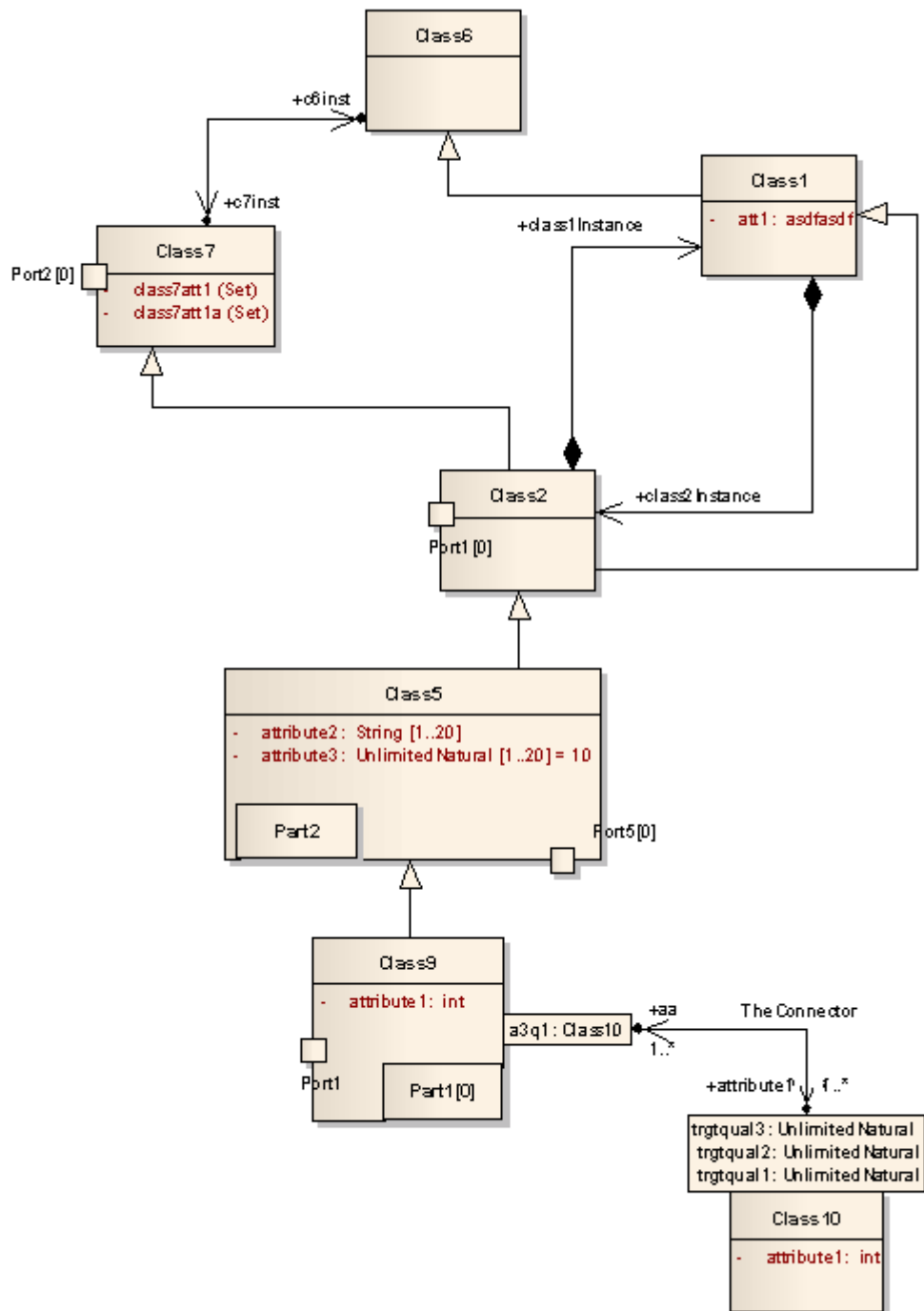

This would be represented in the dialog as follows:

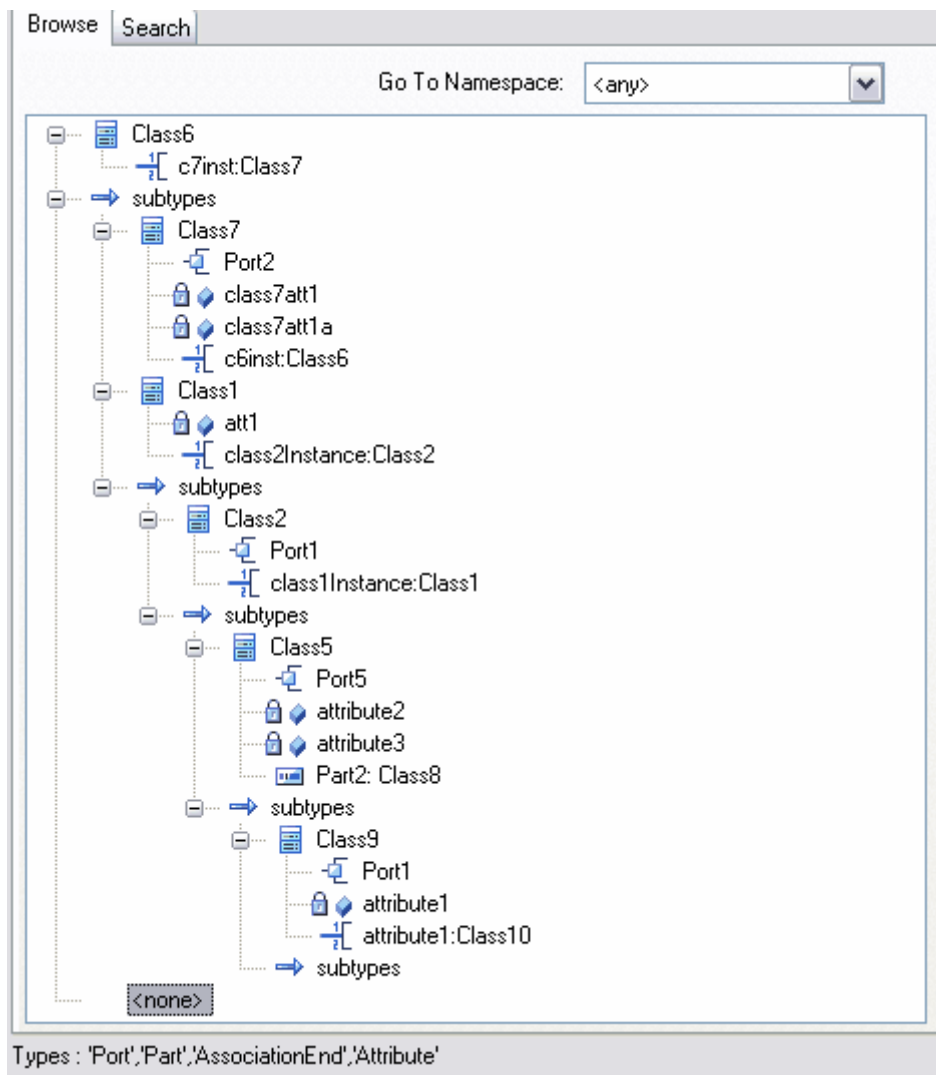
**Note:**

Association ends should be owned by the Class to be listed in the dialog.

Locate and click on the required object to select it, then click on the **OK** button. (To select several objects at once, press and hold **[Ctrl]** while you click on each object.)

## 4.6.2 Object Classifiers

Many elements model classifications (such as Classes and Actors), whilst other elements model *instances* of such classifications (such as Objects, Actors again, and Sequence diagram objects). These instance elements represent real things in a run-time scenario; for example, a *Person* element named *Joe Smith*. In UML this is written as *Joe Smith: Person*.

You can define a classifier first, and then instances of that classifier. Alternatively, as a model develops from a rough sketch to a detailed design, many objects become examples of a defined Class, so in the early analysis phase you might model a *Joe Smith* and a *Jane Smith*, and later a *Person* Class from which *Joe* and *Jane* are instantiated.

Enterprise Architect enables you to associate an Object with its template element (its classifier), such as a Class. Doing this greatly increases the descriptive power of the model in capturing the functionality and responsibility of Objects at run-time and their associated state. For example, if you describe a *Person* Class with attributes such as *Age*, *Name*, *Address* and *Sex*, and functions such as *GetAge* and *GetName*, then when you associate your Object with the *Person* Class it is seen to have all the *Person* Class behavior and state (as well as inherited state and behavior from *Person's* ancestors).

**Tip:**

This is a powerful means of moving your model from the analysis phase into detailed design.

Elements that are classifiers and support instances of themselves at runtime can be dropped from the **Project Browser** as a link to the classifier itself, or a new instance of the classifier. The example below shows a linked Node element on the left and an instance of the Node on the right. Note that the instance is drawn like a simple element with the : <ElementName> displayed. If you name your instance it displays <InstanceName> : <ElementName>.

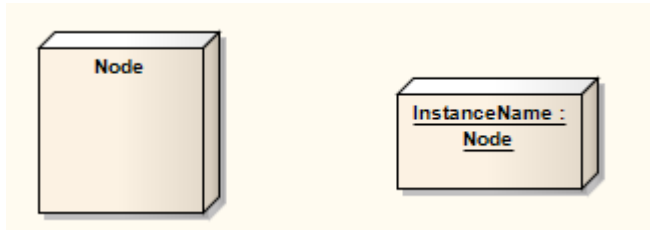

#### 4.6.2.1 Using Classifiers

If you right-click on an Object in a diagram, the element context menu displays the **Advanced | Instance Classifier** menu option. Select this option to choose a single element (generally a Class) as the classifier or template for this Object.

The [Select <Item>](#) <sup>[515]</sup> dialog displays. Use this to set the instance classifier.

The Object name is then displayed as *Object: Classifier*, for example a Person object named Joe Smith is displayed as *Joe Smith: Person*.

#### Several Changes Occur if an Object has a Classifier

It is important to remember that an Object is only an instance of a classifier at runtime, so the appropriate attributes and operations are those of the classifier, not the Object. Therefore, in the context menu for the Object, if you select the **Attributes** or **Operations** menu options, the **Attributes** or **Operations** dialog displays for the classifier, not the Object.

If you set the classifier for an Object in a Sequence diagram, when you add a message the drop-down list of available messages derived from the target Object come from the classifier, not the Object selected. This enables you to associate Sequence diagram objects with Classes and use the defined behavior of the Class to model actual behavior at run time.

You can also select a message for a State Flow connector. The same rules apply as for Sequence diagram objects.

Note that in the **Message** dialog you can also select to include messages defined in the target classifier's inheritance hierarchy.

#### 4.6.3 Visual Representation

Each UML element has a default representation. However, you can:

- [Change the appearance](#) <sup>[521]</sup>, features, position and - for some elements - orientation through a number of toolbars
- Display or hide various types of information held in the element, in [compartments](#) <sup>[521]</sup>.

### 4.6.3.1 Element Icons

When you add an element to a diagram, or select an existing element, a number of small icons display off the right hand side of the element, underneath the Quicklinker arrow. For example:

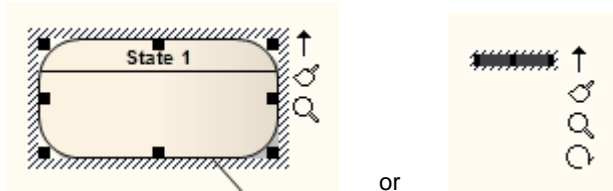

These icons display small versions of the diagram toolbars or perform specific actions, to enable you to quickly edit the element you have highlighted.

Icon	Description
	Rotates a Fork/Join element from vertical to horizontal and vice-versa.
	Displays the <a href="#">Format</a> <sup>[85]</sup> toolbar, for changing element appearance.
	Displays the <a href="#">Current Element</a> <sup>[84]</sup> toolbar, to edit the element's properties and features.
	When multiple elements are selected, displays the <a href="#">Diagram</a> <sup>[83]</sup> Toolbar for changing or aligning the elements together.
	Toggles an <a href="#">Activity Partition</a> <sup>[756]</sup> between vertical and horizontal.

### 4.6.3.2 Compartments

In addition to the attributes and operations compartments shown in a Class element, Enterprise Architect also supports other compartments that can optionally be displayed.

To set the visibility of the various compartments, see [Feature Visibility](#)<sup>[438]</sup>.

#### Tags Compartment

The **tags** compartment lists all Tagged Values for an element as entered in the [Tagged Values](#)<sup>[632]</sup> window.

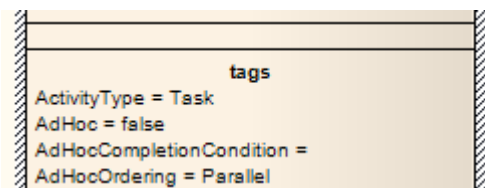

Or, in the [fully qualified](#)<sup>[438]</sup>, expanded format:

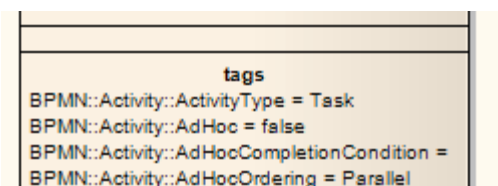

**Note:**

The **fully-qualified** option operates only on those Tagged Values that were created in Enterprise Architect release 7.1 or later. It does not expand Tagged Values created in earlier releases.

## Responsibility Compartment

The responsibility compartment shows a list of responsibilities as entered on the [Requirements](#) <sup>[485]</sup> tab of the element **Properties** dialog.



## Constraint Compartment

The constraint compartment shows a list of element constraints as entered in the [Constraints](#) <sup>[488]</sup> tab of the element **Properties** dialog.

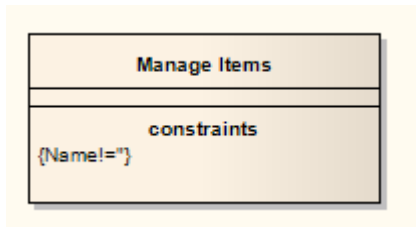

## Testing Compartment

The testing compartment lists all of the tests associated with an element as listed in the [Testing](#) <sup>[1537]</sup> window (select the **View | Testing** menu option).

## Maintenance Compartment

The maintenance compartment lists all of the defects, changes, issues and tasks associated with an element, as listed in the [Maintenance](#) <sup>[1558]</sup> window (select the **View | Other Element Tools | Maintenance** menu option).

### 4.6.4 Element Tasks

This topic describes the following common tasks that you can perform on elements in Enterprise Architect:

- [Create Elements](#) <sup>[523]</sup>
- [Add Elements Directly to Packages](#) <sup>[524]</sup>
- [Use Auto Naming and Auto Counters](#) <sup>[525]</sup>
- [Set Element Parent](#) <sup>[526]</sup>
- [Show Element Use](#) <sup>[526]</sup>
- [Set Up Cross References](#) <sup>[527]</sup>
- [Move Elements Between Packages](#) <sup>[530]</sup>
- [Move Elements Within Diagrams](#) <sup>[529]</sup>
- [Copy Elements Between Packages](#) <sup>[531]</sup>
- [Change Element Type](#) <sup>[532]</sup>
- [Align Elements](#) <sup>[532]</sup>
- [Resize Elements](#) <sup>[533]</sup>
- [Delete Elements](#) <sup>[534]</sup>
- [Customize Visibility of Elements](#) <sup>[535]</sup>
- [Create Notes and Text](#) <sup>[536]</sup>
- [Link Note to Internal Documentation](#) <sup>[537]</sup>

- [Set an Element's Default Appearance](#) <sup>[538]</sup>
- [Get/Set Project Custom Colors](#) <sup>[540]</sup>
- [Use Element Templates](#) <sup>[542]</sup>
- [Highlight Context Element](#) <sup>[543]</sup>
- [Make Linked Element a Local Copy](#) <sup>[544]</sup>
- [Copy Features \(Attributes and Operations\) Between Elements](#) <sup>[544]</sup>
- [Move Features Between Elements](#) <sup>[545]</sup>

**Note:**

In the Corporate, Business and Software Engineering, Systems Engineering and Ultimate editions of Enterprise Architect, if security is enabled you must have [Update Element](#) <sup>[198]</sup> permission to update element properties or delete an element.

#### 4.6.4.1 Create Elements

Elements within a model are typically arranged on diagrams to visually communicate the relationships between a given set of elements. Enterprise Architect provides simple mechanisms for creating elements in the model, using diagrams or the [Project Browser](#).

#### Create Elements on a Diagram

The fastest and simplest way to create elements directly on a diagram is to press **[Spacebar]** or **[Insert]** on the diagram. This displays a list of elements and connectors that mirrors the current [Toolbox](#) pages; usually these are the most appropriate elements and connectors for the diagram.

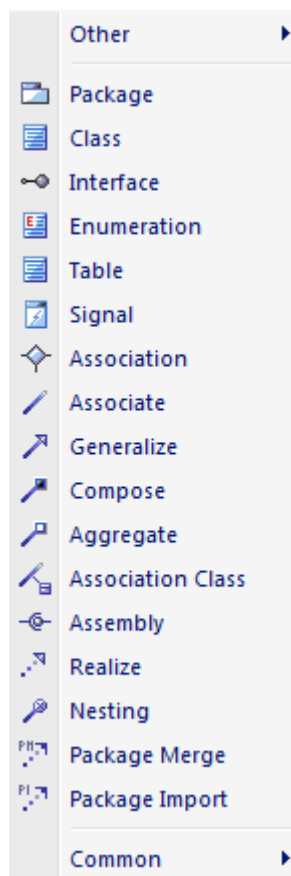

You can display and select from a longer list of elements by clicking on the **Other** option.

The following topics describe other approaches for creating elements on a diagram:

- [Create Elements In Place Using the Quick Linker](#) <sup>[475]</sup>
- [Create Elements Using the Toolbox](#) <sup>[399]</sup>

- [Create Elements Using the Diagram Context Menu](#) <sup>[394]</sup>
- [Create a Group of Elements Using UML Patterns](#) <sup>[901]</sup>
- [Create Domain Specific Elements from UML Profiles](#) <sup>[907]</sup>.

**Tip:**

If you are creating several elements of one type, after creating the first just press **[Shift]+[F3]** or **[Ctrl]+click** to create the next element of that type.

## Re-Use Existing Elements

Be aware that once you have created elements, you can re-use them by [dragging them](#) <sup>[430]</sup> from the **Project Browser** and dropping them onto your diagrams.

## Add Elements Directly to a Package

Sometimes it is useful to add elements to a package, without a diagrammatic representation. This can be accomplished via the **Project Browser** window and is explained in the following topic:

- [Add Elements Directly to a Package](#) <sup>[524]</sup>.

**See Also**

- [Behavioral Diagram Elements](#) <sup>[742]</sup> - summary of all elements used in Behavioral diagrams
- [Structural Diagram Elements](#) <sup>[809]</sup> - summary of all elements used in Structural diagrams

### 4.6.4.2 Add Elements Directly To Packages

You can quickly add new elements to a package without the necessity of adding a diagram element at the same time. This is particularly useful in defining a group of Requirements, Changes, Issues, base Classes or other element types that might not require diagrammatic representation in the model.

To add a new element to a package, follow the steps below:

1. In the **Project Browser**, right-click on the appropriate package. The context menu displays.
2. Select the **Add | Add Element** menu option. The **New Element** dialog displays.

3. In the **Name** field, type the name of the element.
4. In the **Type** field, click on the drop-down arrow and select the element type.

**Note:**

The drop-down list is populated from one of the **Toolbox** page groups (including profile, Add-In and MDG Technology groups). If the list does not represent the group containing the element you require, click on the **Select Group** button and, from the list, select the appropriate **Toolbox** page group. The drop-down list then shows the elements from that group.

The <default> group in the list contains a basic set of elements drawn from across the UML Behavioral and Structural groups, and the Enterprise Architect Extended groups.

5. If required, in the **Stereotype** field either type the stereotype name or click on the drop-down arrow and



select the stereotype.

6. Select the **Open Properties Dialog on Creation** checkbox if the **Properties** dialog is to open immediately after the element is created.
7. Deselect the **Close Dialog on OK** checkbox to add multiple elements in one session.
8. Click on the **OK** button to create the element.

**Note:**

If you have a diagram open, the **Add to Current Diagram** checkbox is available and defaulted to selected to add the new element to the diagram. If you do not want the element in that diagram, deselect the checkbox.

#### 4.6.4.3 Use Auto Naming and Auto Counters

The **Auto Element Naming** dialog enables you to configure automatic naming for any element type. Each element can have separately configured automatic names and aliases.

To set up auto naming, follow the steps below:

1. Select the **Settings | Auto Name Counters** option from the main menu. The **Auto Name Counters** dialog displays.

2. In the **Type** field, click on the drop-down arrow and select the element type (for example, Activity).
3. In the **Name** panel:
  - In the **Prefix** field, type a prefix for the new name (optional).
  - In **Counter** field, type the counter value; use as many 0's as required to pad the name.
  - In the **Suffix** field, type a suffix for the new name (optional).
  - If required, click on the **Active** checkbox to turn auto naming on for this element type.
4. In the **Alias** panel:
  - In the **Prefix** field, type a prefix for the new alias (optional).
  - In **Counter** field, type the counter value; use as many 0's as required to pad the alias.
  - In the **Suffix** field, type a suffix for the new alias (optional).
  - If required, click on the **Active** checkbox to turn alias auto naming on for this element type.
5. Click on the **Save** button.

New elements of this type now have an automatically-generated name and/or alias with an incrementing counter value.

**Note:**

If an Alias is active then auto naming applies; however, to view the Alias in a diagram requires that the option **Use Alias if Available** is selected in [Diagram Properties](#).<sup>[425]</sup>

#### 4.6.4.4 Set Element Parent

You can manually set an element's parent or an interface it realizes, using the **Type Hierarchy** dialog.

To set the element parent, follow the steps below:

1. Select a generalizable element in a diagram.
2. Select the **Element | Advanced | Set Parents and Interfaces** menu option. Alternatively:
  - Press **[Ctrl]+[I]** or
  - Right-click and select the **Advanced | Parent** context menu option.

The **Set Parents and Interfaces** dialog displays.

3. You can elect to enter a parent or interface name by either manually typing it in, or clicking on the **Choose** button to locate the element within the current model.
4. Set the **Type** of relationship (**Implements** or **Generalizes**) from the drop-down list.
5. Click on the **Add** button to add the relationship.
6. Click on the **Delete Selected** button to remove the current selected relationship.

#### Note:

If Parents are not in the same diagram as their corresponding related element, the parentage is shown in the top right corner of the child element, as shown below:

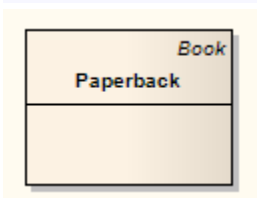

#### 4.6.4.5 Show Element Use

You can display the use of an element using the **Element Usage** dialog. This lists all occurrences of the element throughout the model, and enables you to easily navigate to any occurrence.

To show element usage, follow the steps below:

1. Select an element in a diagram.
2. Select the **Element | Find in Diagrams** menu option. Alternatively, press **[Ctrl]+[U]**. If the element exists in other diagrams, the **Element Usage** dialog displays, listing all occurrences of the current

element in diagrams in the model.

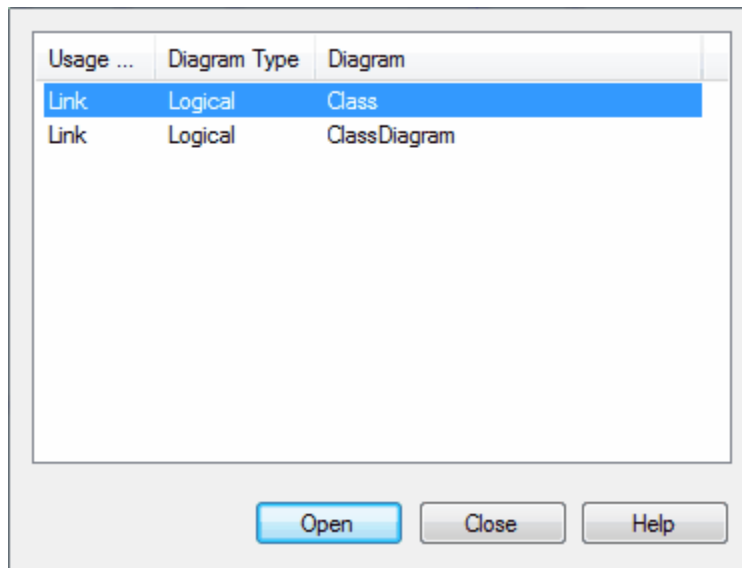

3. If you want to display the usage information in a more readable layout, you can resize the dialog and its columns.

Either:

- Double-click on a line item to open the relevant diagram and display the selected element (the **Element Usage** dialog remains open), or
- Click on the **Open** button to display the selected diagram and close the **Element Usage** dialog.

**Note:**

You can also access this feature from the **Project Browser**; select an element in the tree and select the **Element | Find in Diagrams** menu option. If there is only one instance of the element in any diagram, that diagram displays instead.

#### 4.6.4.6 Set Up Cross References

It is possible to set up a cross reference (or *Custom Reference*) from one element in Enterprise Architect to another. You can also view existing cross references on an element, using the **Context References** <sup>[506]</sup> tab on the element's **Properties** dialog, or the **Traceability** <sup>[1253]</sup> window.

To set up a cross reference, follow the steps below:

1. In the **Project Browser**, locate the target element or diagram (that is, the object of the cross reference).
2. Open a diagram that contains the elements that are to have the currently selected element as a reference.
3. Right-click on the element in the **Project Browser**. The context menu displays.
4. Select the **Add custom reference** menu option.
5. In the **Set up references** dialog, select the checkbox against each element to that is to have the target element as a reference.
6. Optionally, in the **Comment** field, type some text to describe the purpose of the reference.

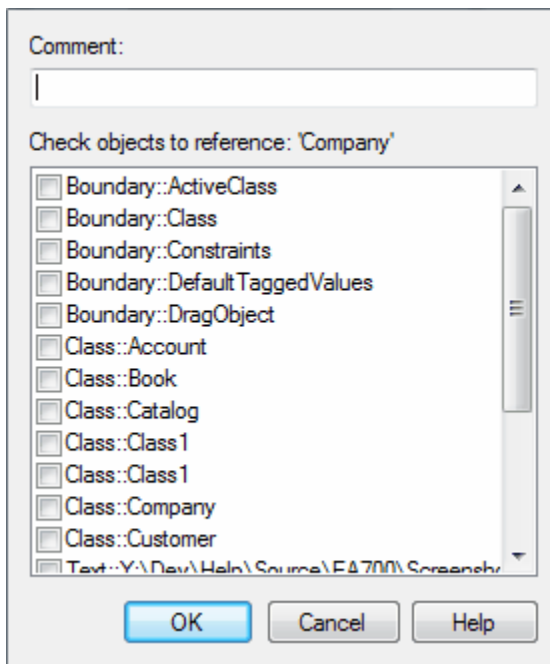

7. Click on the **OK** button.

### Use the Cross Reference

To use the cross reference, follow the steps below:

1. Select an element in a diagram.
2. Select the **Element | Custom References** menu option. Alternatively, either press **[Ctrl]+[J]**, or right-click on the element and select the **Find | Custom References** context menu option.
3. The **Custom References** dialog displays, showing a list of elements that have been set as cross references for the selected element.

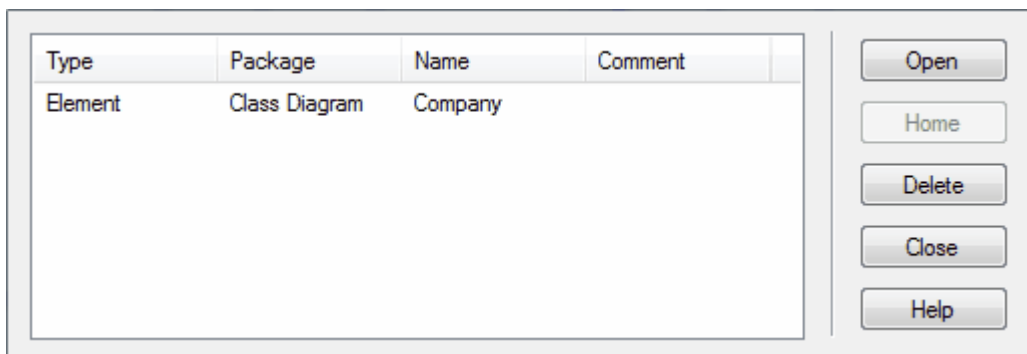

4. You can open the **Properties** dialog for an element by highlighting it and clicking on the **Open** button.
5. If you have a diagram cross reference, you can open that diagram.
6. If you have a string of diagram links, click on the **Home** button to return to the original diagram.

#### Note:

You can delete a cross reference by selecting it on the **Custom References** dialog and clicking on the **Delete** button. Cross references are also automatically deleted if the source or target element in the reference is deleted.

#### 4.6.4.7 Move Elements Within Diagrams

Any one of the following options enables you to move an element within a diagram. Select an element or group of elements in the diagram view, then:

- Use the mouse to drag the element to the required position (the cursor switches to the four-arrow icon as shown below)

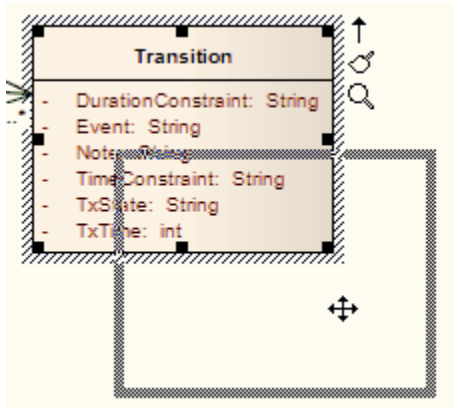

- Hold down **[Shift]** and use the arrow keys to move the element by increments to the required position
- Use the **Left, Right, Up** and **Down** options in the **Element | Move** submenu
- Align multiple elements using the **Element | Alignment** submenu, the **Alignment** options in the right-click context menu, or the **Alignment** buttons on the **Diagram** toolbar.



#### Confirm Possible Parent Elements

As you organize the elements within a diagram, you can drag any element over another and, provided the dragged element is within and on top of the possible parent, it is always encapsulated by the lower element and moved within the lower element. However, the lower element might not be a valid parent.

You can confirm that a possible parent element is able to accept a selected child element. When you drag the child element over the potential parent, the target element border changes to a dashed line if it can accept the selected element as a child. If the border does not change, the selected element cannot be a child to the target element.

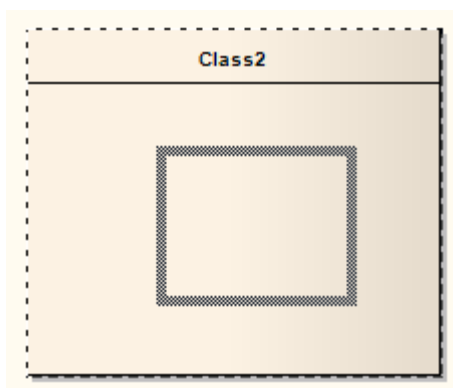

**Notes:**

- The **Support for Composite Objects** checkbox must be selected on the [Objects](#) <sup>3621</sup> page of the **Options** dialog (select the **Tools | Options | Objects** option). If this option is not selected, the dashed border does not show and the child element cannot be embedded on the parent in the diagram.
- Both elements must already exist on the diagram; an element border does not change if you drag a potential child element over it from the **Toolbox** or **Project Browser**.
- The child element must have equal or higher z-order placement than the parent; that is, the parent element must be level with or behind the child.
- The child element borders must be completely within the parent element borders.

For example, if you drag a Signal over a Class, the Class border changes; a Class element can be a parent to a Signal. If you drag a Class element over a Signal element, the Signal border does not change. A Signal cannot be a parent to a Class.

When you embed a child element on its parent, the child element becomes part of the parent element hierarchy in the **Project Browser**. Similarly, if you drag the child element out of the parent, the child element becomes independent and is no longer embedded in the parent element hierarchy.

#### 4.6.4.8 Move Elements Between Packages

Elements and packages can be moved from one package to another by dragging and dropping the element to the target destination in the **Project Browser**. Note that if you move a package, ALL the child packages and their contents are moved to the new location also.

To move an element between packages, follow the steps below:

1. Click on the element in the **Project Browser**. (See *Customer* in the diagram below.)
2. Drag the element so that the cursor is over the target package icon. The element symbol (and, in some operating systems, the element name) displays at the moving cursor position.)

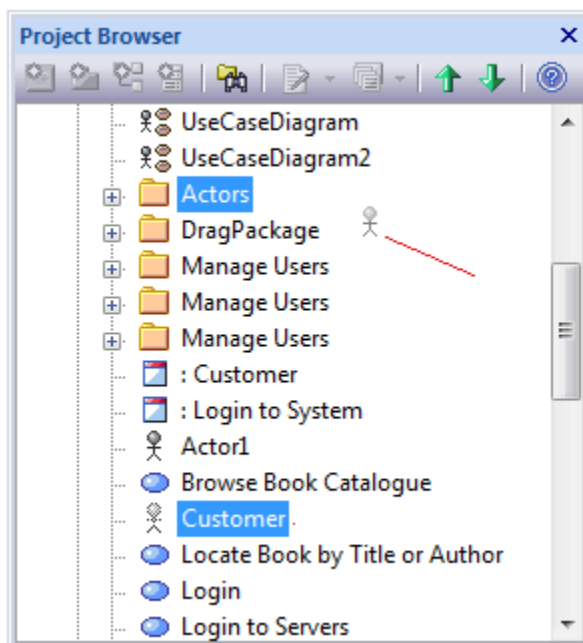

3. Release the mouse button. The element is moved into the target package.

**Tip:**

You can also drag the element under a host element in the new package; for example, drag an element under a Class.

**Notes:**

- Moving an element has no effect on any relationships that the element might have.
- Moving an element in the **Project Browser** has no effect on the use of that element in any diagram.
- Moving a diagram generally does not affect the location of elements in packages. If you move a diagram out of one package into another, all the elements in the diagram remain in the original package. However, certain elements (such as Decision, Initial and Final elements) are used only within one diagram, have no meaning outside that diagram, and are never re-used in any other diagram. Therefore, if you move a diagram containing these elements, they **are** moved to the new parent package with the diagram.

**Warning:**

In a multi-user environment, if one person moves or updates the **Project Browser** structure, other users must [reload their project](#) <sup>[267]</sup> to see the latest changes in the **Project Browser**. Although this is true of any addition or modification to the tree, it is most important when big changes are made, such as dragging a package to a different location.

#### 4.6.4.9 Copy Elements Between Packages

Enterprise Architect enables you to quickly and easily duplicate one or more elements, including their child elements and diagrams. You can insert a copy of an element under one or more other packages, in the same .eap file or any other .eap file.

**Notes:**

- A copy of an element does not have the external cross references of the source element; that is:
  - if one element is copied it has no connectors
  - if more than one element is copied, only the connectors between the copied elements are retained
    - however, if those elements come from a Sequence or Communication diagram and the diagram itself is not copied, the message connectors between the copied elements are not retained.
- You cannot paste an element into a package that is [locked](#) <sup>[205]</sup> by another user or that is [checked in](#) <sup>[267]</sup>. The **Paste...** option is grayed out in the context menu.

To copy elements, follow the step below :

1. In the **Project Browser**, select each required element, right-click on one of them and select the **Copy Element(s) to Clipboard** context menu option (or click on a selected element and press **[Ctrl]+[C]**). The **Copy Element(s) to Clipboard** dialog briefly displays until the copy operation completes.

To paste the copied elements, follow the step below:

1. In the **Project Browser**, right-click on the package into which to paste the copied elements, and select the **Paste Element(s) from Clipboard** context menu option (or click on the package and press **[Ctrl]+[V]**). The **Paste Element(s) from Clipboard** dialog briefly displays until the paste operation completes.

The target package is expanded and the pasted elements are exposed in the **Project Browser**. If you are pasting the elements within the same model as the copied source, the source parent package is also collapsed.

If the target package already contains:

- an element of the same type with the same name as a pasted element, the pasted element name has the suffix - *Copy*
- an element with the same name as the pasted element *including* the - *Copy* suffix, the suffix becomes - *Copy1* (or - *Copy 2*, - *Copy3* and so on, as copies of the element accumulate in the target package)

You can keep the same element names as the source, or you can rename each element either by clicking twice on it and editing the name in the **Project Browser**, or by double-clicking on it and editing the name in the **Properties** dialog.

#### 4.6.4.10 Change Element Type

To change an element type, follow the steps below:

1. In the **Diagram View**, click on the element to change.
2. Select the **Element | Advanced | Change Type** menu option. The **Select Element Type** dialog displays.

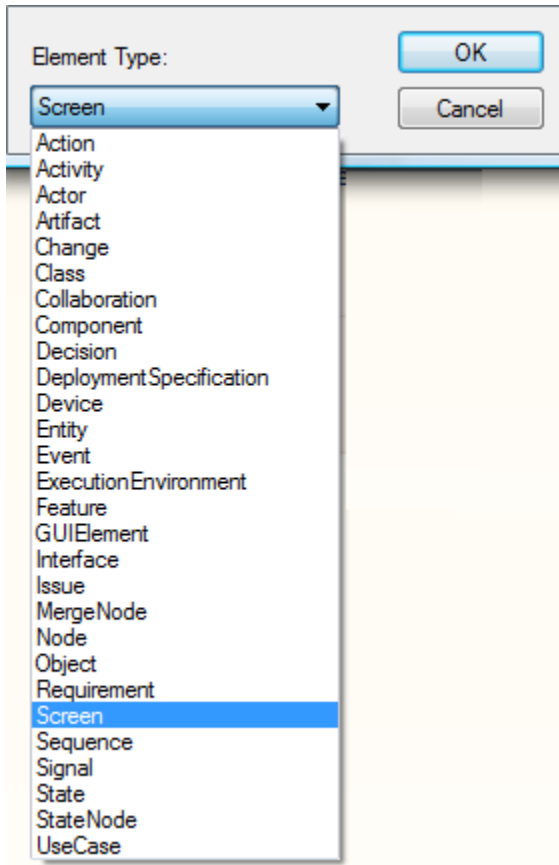

3. In the **Element Type** field, click on the drop-down arrow and select the required element type.
4. Click on the **OK** button.

The target is transformed into the required type.

#### 4.6.4.11 Align Elements

To align multiple elements, follow the steps below:

1. Select a group of elements by drawing a selection box around them all. (Or select them one by one by holding down **[Ctrl]** and clicking on each element).
2. Right-click on the element in the group to align others to. The context menu displays.
3. Select the alignment function you require.

All selected elements are aligned to the one beneath the cursor.

##### Tip:

You can also use the **Diagram** toolbar.



The first four buttons are used to align elements, and are made available when more than one element is selected in a diagram.

You can also select the **Element | Alignment** menu option.



#### 4.6.4.12 Resize Elements

Any one of the following options enables you to resize an element. Select an element or group of elements in the diagram view, then:

- Use the resize handles that appear at each corner and side to resize the element(s) by dragging with the mouse (the cursor switches to the double-ended arrow as shown below)

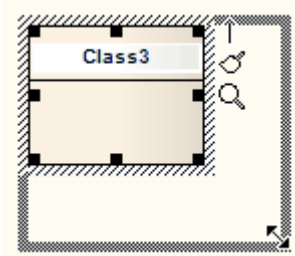

- Press and hold **[Ctrl]** and use the arrow keys to resize by increments as required
- Use the **Wider**, **Narrower**, **Taller** and **Shorter** options in the **Element | Move** submenu
- Autosize selected element(s) using the option in the **Element | Appearance** submenu, or by pressing **[Alt] + [Z]**. (With multiple elements selected, **Autosize** also appears in the right-click context menu)
- Set multiple elements to the same height, width or both, using these options in the **Element | Make Same** submenu, or the options in the right-click context menu.

#### Resize a Set of Objects to a Specific Size

If you right-click a selected set of objects, you can resize them to the same dimensions (height, width or both) using the context menu. When you select multiple elements using **[Ctrl]+click**, then resize the dimensions, the dimensions of the selected hatched object are used to set the dimensions of the other selected objects.

For example, in the diagram below, the *Message* Class height and width are used to set the height and width of the *Account* and *Message Folder* Classes. The aim is to make the *Account* and *Message Folder* elements the same height and width as the *Message* element.

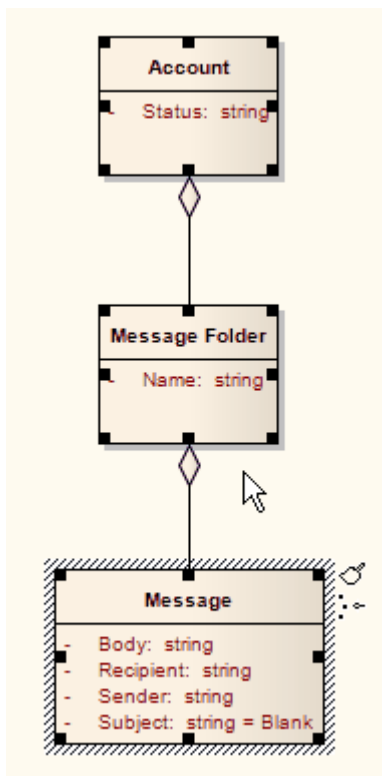

To do this follow the steps below:

1. Set one element to the required size (for example, *Message* as above).
2. Select all other elements (for example, *Account* and *Message Folder* as above).
3. Right-click on the pre-sized element (for example, *Message*).
4. Select your resizing option (such as same height, width) from the context menu.

#### See Also

- [Highlight Context Element](#)<sup>[543]</sup>

### 4.6.4.13 Delete Elements

#### Delete an Element From a Diagram

Follow the steps below:

1. In the active diagram, click on the element to delete.
2. Either:
  - Press **[Delete]**, or
  - Right-click to display the context menu and select the **Delete <element name>** option.

#### Note:

This does not delete the element from the model, only from the current diagram.

#### Delete an Element From the Model

Follow the steps below:

1. In the **Project Browser**, right-click on the element to delete. The context menu displays.
2. Select the **Delete <element name>** option. A confirmation prompt displays.
3. Click on the **Yes** button.

Alternatively:

1. Click on the element in the **Project Browser** and press **[Ctrl]+[Delete]**.

The element is completely removed from the model.

#### Delete Multiple Elements From a Diagram

Follow the steps below:

1. In the active diagram, **[Ctrl]+click** on each element to delete.
2. Either:
  - Press **[Delete]**, or
  - Right-click to display the context menu and select the **Delete selected elements** option.

#### Delete Multiple Elements From a Diagram and Model

Follow the steps below:

1. Open the diagram containing the elements to remove from the model.
2. Press **[Ctrl]+[A]** to select all of the elements in the diagram, or use **[Ctrl]+click** to select specific elements.
3. Press **[Ctrl]+[Delete]** to completely remove the elements from the model.

#### Delete Multiple Elements from the Project Browser and Model

Follow the steps below:

1. In the **Project Browser**, press and hold either **[Shift]** or **[Ctrl]** and click on the required items.
2. To completely remove the elements from the model, either:
  - Press **[Ctrl]+[Delete]**, or
  - Right-click on the selected items and select the **Delete selected item(s)** context menu option.

**Note:**

If you delete an element in this way, you delete all its properties and connectors as well.

#### 4.6.4.14 Customize Visibility of Elements

Some elements are hidden from view in packages and in RTF documents by default. These include Events, Decisions, Sequence elements and Associations. You have the option of turning these elements back on.

For example, some Events and Decisions contained in a package do not appear in the package view, as in the example below.

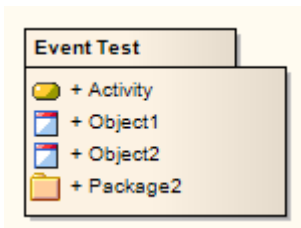

To show additional elements, follow the steps below:

1. Select the **Tools | Options | Objects** menu option. The **Objects** page of the **Options** dialog displays.
2. Click on the **Advanced** button. The **Advanced Settings** dialog displays.

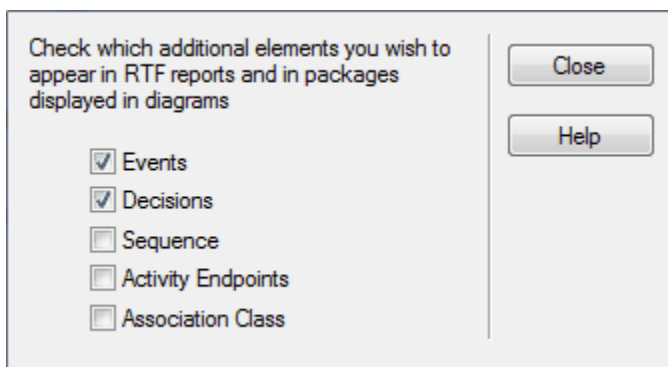

3. Select the checkbox for each type of element to show in packages and in RTF documents.
4. Click on the **Close** button on each dialog.
5. [Reload](#)<sup>[267]</sup> the current diagram if required.

The package from the example above now shows the Event and Decision elements it contains:

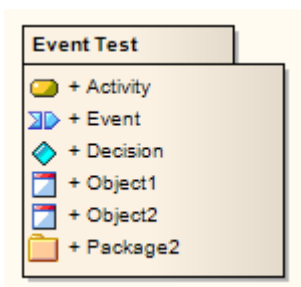

#### 4.6.4.15 Create Notes and Text

You can create both notes and text on a diagram; the two are slightly different.

##### Create a Note

To create a note, follow the steps below:

1. Drag the *Note* icon from the **Common** page of the **Toolbox** onto the diagram.
  - If you have the **Edit Object On New** <sup>[362]</sup> checkbox *deselected* on the **Objects** page of the **Options** dialog (**Tools | Options | Objects**), the Note element displays on your diagram; type your note text directly within the Note element

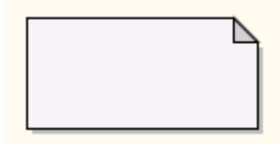

- If you have the checkbox selected, the **Notes** <sup>[641]</sup> window displays; type your text in that window. If you want to display the Notes information in a more readable layout, you can resize the dialog.

You can format the text if necessary, using the **Notes** <sup>[642]</sup> toolbar at the top of the window. When you have completed the text, click on the **OK** button to save it.

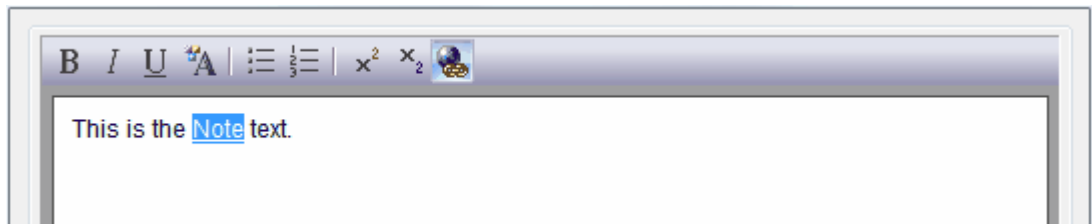

The Note text displays in the Note element.

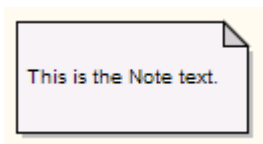

##### Note:

You can also create a note by clicking on the **New Note** icon (the text page) on the **UML Elements** <sup>[83]</sup> toolbar and clicking on the diagram.

##### Create Text

To create text, follow the steps below:

1. Drag the *Text Element* icon from the **Common** page of the **Toolbox** onto the diagram. The **Notes** <sup>[641]</sup> window displays.

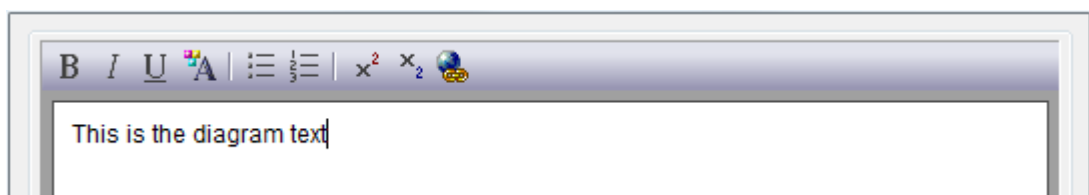

2. Type your text in the window. If you want to display the Notes information in more readable layout, you can resize the dialog.

You can format the text if necessary, using the [Notes](#) <sup>[642]</sup> toolbar at the top of the window. When you have completed the text, click on the **OK** button to save it.

Your text displays on the diagram in the following format, with no border:

This is the diagram text

#### 4.6.4.16 Link Note to Internal Documentation

It is possible to connect a *Note* element to another element's internal documentation. This enables you to externalize model documentation to the diagram level, and as Enterprise Architect keeps the note and the internal structure in synch, you do not have to worry about updating the note contents; this is done automatically.

In the example below, two notes are connected into an element's internal structures. One is connected to an attribute, and displays the attribute name and notes. The other is connected to a constraint, showing the constraint name and documentation.

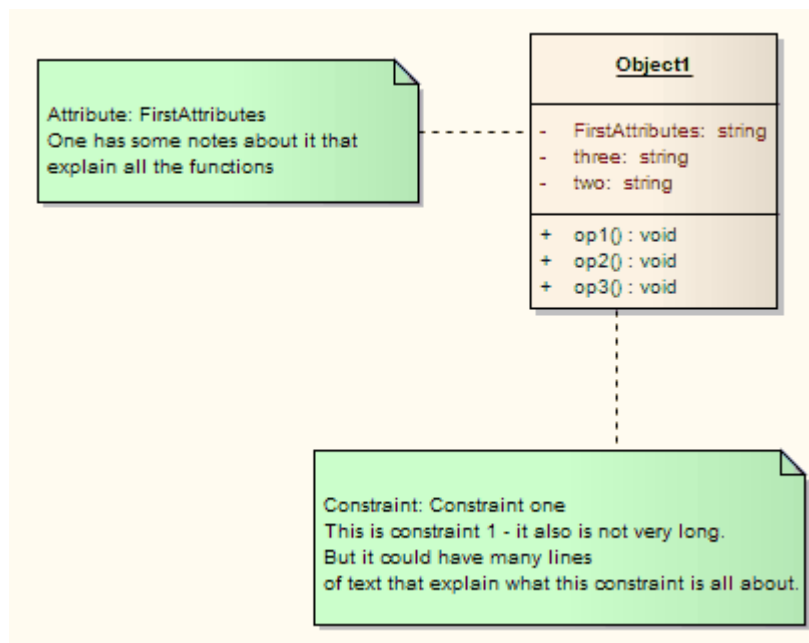

### Procedure

To connect a Note element to a feature of another design element, follow the steps below:

1. Click on the element and then click on the feature to link the note to.
2. Select the **Element | Inline Features | Create Linked Note** context menu option. This creates a Note element linked to the selected feature, reflecting the content of that feature.

*Alternatively:*

1. Insert the target element into a diagram.
2. Drag the *Note* icon from the **Common** page of the **Toolbox** onto the diagram, next to the target element. The **Notes** dialog displays. Do not type any text, just click on the **OK** button.
3. Click on the **Note Link** icon from the **Common** page of the **Toolbox**, click on the Note, and drag across to the target element to create the connector.
4. Right-click on the Note Link to display the context menu.
5. Select the **Link this Note to an Element Feature** menu option. The **Link note to element feature** dialog displays.

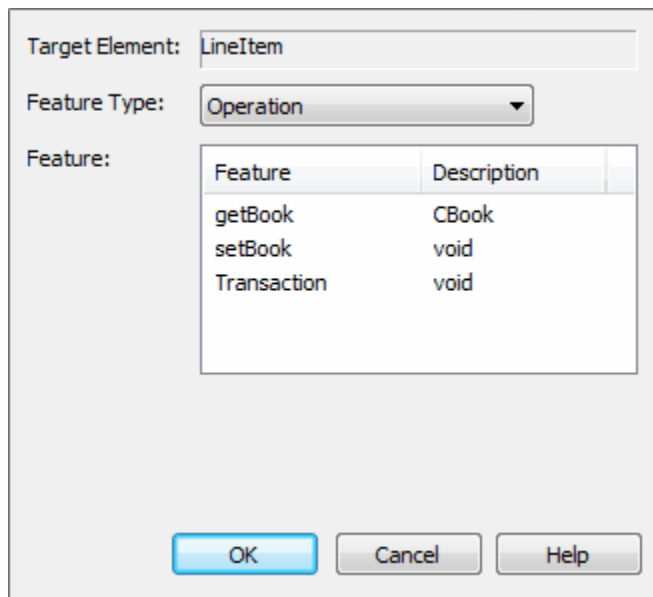

6. In the **Feature Type** field, click on the drop-down arrow and select the type of feature to link to.
7. In the **Feature** list, click on the specific feature to link to.
8. Click on the **OK** button.

The note now automatically derives its contents from the target element.

#### 4.6.4.17 Set an Element's Default Appearance

You can set the global appearance of all elements throughout a model, using the **Options** dialog. Select the **Tools | Options** menu option, then select **Standard Colors** <sup>[353]</sup> and **Diagram | Appearance** <sup>[356]</sup> from the options tree.

To override the global appearance and define a default appearance for a specific element on all diagrams on which it is found, right-click on the element and select the **Appearance | Default Appearance** context menu option. The **Default Appearance** dialog displays.

To change the appearance of an element on the current diagram only, use the **Format** <sup>[85]</sup> toolbar. If the **Format** toolbar is not displayed, select the **View | Toolbars | Format Tool** menu option.

#### Note:

You can adjust several elements at the same time. Select all of the required elements, right-click on one of them and select the **Default Appearance** context menu option, or use the **Format** toolbar.



## Change a Background, Font or Border Color

To reset the background color, font color or border color, follow the steps below:

1. On the **Default Appearance** dialog, select the **Background Color**, **Font Color** or **Border Color** radio button as appropriate.

### Note:

You have further options for changing the font of element text in the **Set Font** (556) menu option.

2. Deselect the **Use Default Color** checkbox, to enable the **Select** button.
3. Click on the **Select** button. The **Color** dialog displays.

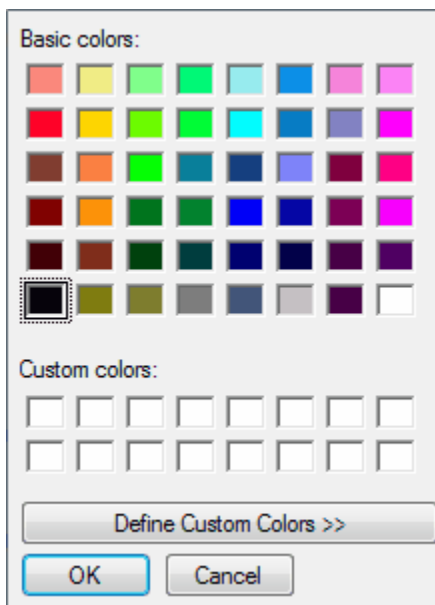

4. Select the required color (click on the **Define Custom Colors>>** button and define a specific color if necessary) and click on the **OK** button. You return to the **Default Appearance** dialog, on which the **Preview** panel indicates the selected color for the element.

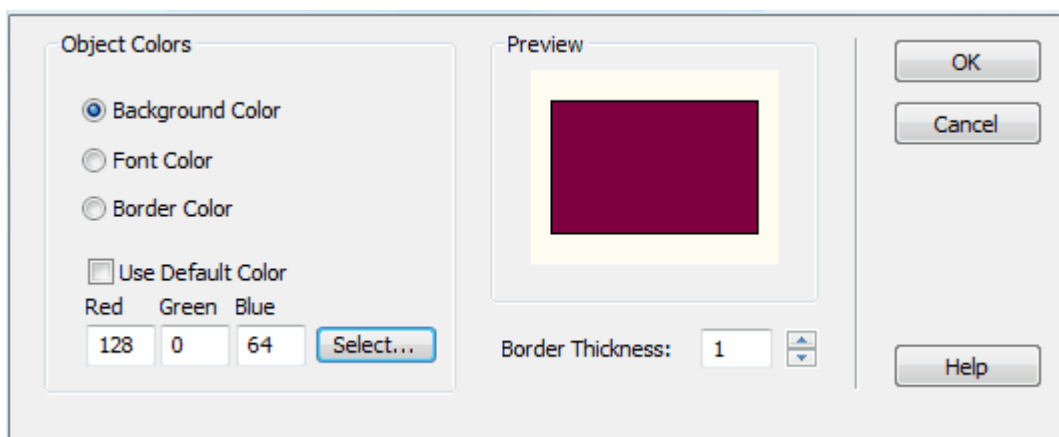

### Note:

To change to a different color, click on the **Select** button again, or to return to the default color, select the **Use Default Color** checkbox.

5. Click on the **OK** button. The new color is applied to the selected element or elements.

## Change the Border Thickness

To change the border thickness, follow the steps below:

1. On the **Default Appearance** dialog, in the **Border Thickness** field, type the number of points to apply. Alternatively, click on the scroll arrows to increase or decrease the number.

The **Preview** panel indicates the effect of the change in border thickness.



2. Click on the **OK** button. The new border thickness is applied to the selected element or elements.

### 4.6.4.18 Get/Set Project Custom Colors

If more than one person is working on a project, each person might want to use specific colors for elements within the project. The **Settings | Colors | Set Project Custom Colors** and **Get Project Custom Colors** options enable you to set specific colors and subsequently get the colors in a different session, without having to remember RGB values.

## Set a Project Custom Color

Follow the steps below to set your project's custom colors:

1. Select an element to be colored.
2. Select the **Element | Appearance | Default Appearance...** menu option. The **Default Appearance** dialog displays.



3. Deselect the **Use Default Color** checkbox to enable the **Select** button.
4. Click on the **Select** button. The **Color** dialog displays.



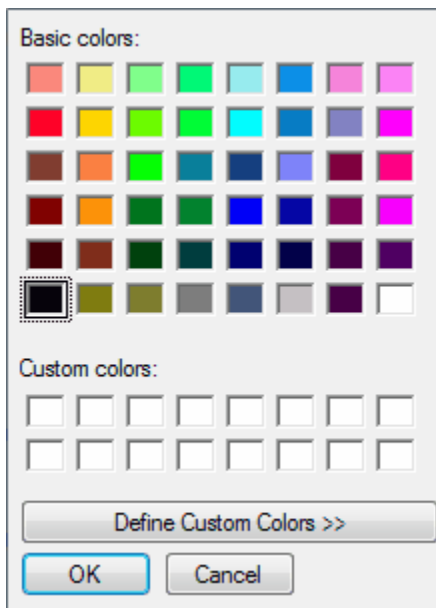

5. Click on the **Define Custom Colors »** button.
6. Create the color in the color mixer panel on the right of the dialog.

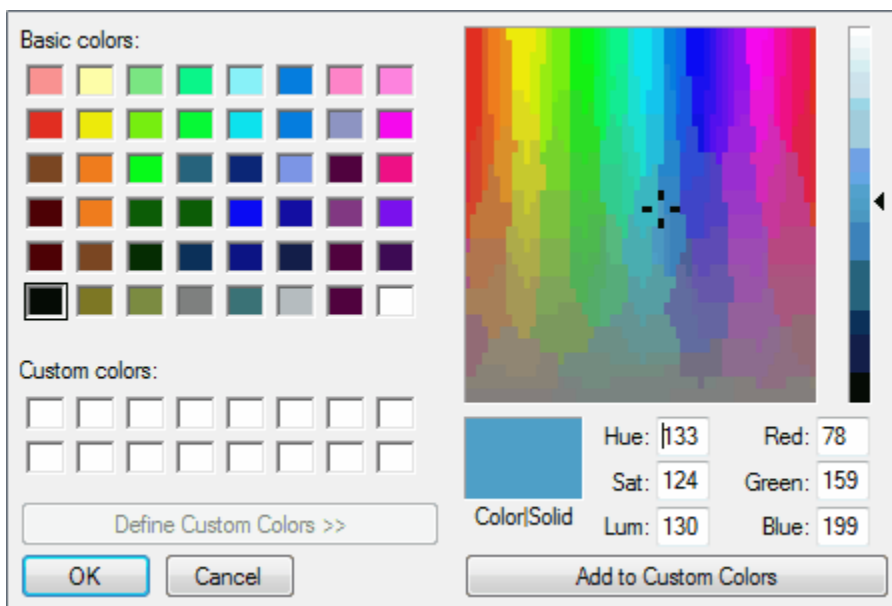

7. Click on the **Add to Custom Colors** button to add the color to the **Custom colors** blocks on the left hand side of the dialog.

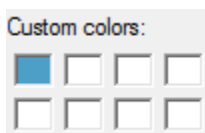

8. Click on the **OK** button to close the **Color** dialog, then click on the **OK** button to close the **Default Appearance** dialog.
9. Select the **Settings | Colors | Set Project Custom Colors** menu option to save the custom color you have created.

## Get a Project Custom Color

To get your project's custom colors, follow the steps below.

1. Select the **Settings | Colors | Get Project Custom Colors** menu option. This applies any saved custom colors to this project.
2. Click on an element to be colored and select the **Element | Appearance | Default Appearance** menu option. The **Default Appearance** dialog displays.
3. Deselect the **Use Default Color** checkbox to enable the **Select** button.
4. Click on the **Select** button to view the applied custom colors (as listed at step 7, above).
5. Click on the required color and click on the **OK** button to close the **Color** dialog, then click on the **OK** button to close the **Appearance** dialog. The element changes to the selected color.

### 4.6.4.19 Set Element Templates Package

In building up a model, you might want to represent or emphasize certain characteristics of elements in the appearance of those elements, or select particular display options as standard. For example, you could make new Interface elements a different default color to new Class elements, ensure all new Activity Partitions are vertical rather than horizontal, or set a specific group of display options for new diagrams. You could also define a set of characteristics to use for each development stage of a project.

To do all this, you create a diagram with all the characteristics you require, and store it in an element *Templates* package. Enterprise Architect then checks this folder whenever you start to create an element in a diagram and, if it finds a template for that diagram type, applies the settings in that template to the new element or to the display options of the diagram. For example, you could save a diagram under the name *ClassTemplate*, to apply a set of display characteristics to all new Class elements.

You should create the Templates package in an administrative View of the project file, rather than in any work area. This prevents the package from being changed or lost in any project development work.

There are two other ways in which you can modify the appearance of elements in diagrams:

- You can define the default appearance of elements (and other structures) grouped in a diagram by using [UML Profiles](#)<sup>[906]</sup>. These provide a means of extending the UML Language, which enables you to build UML models in particular domains. They are based on additional stereotypes and Tagged Values that are applied to elements, attributes, methods, connectors, connector ends and so on.
- You can modify the appearance of elements (and connectors) of a specific type using [stereotypes](#)<sup>[895]</sup>. Stereotypes take precedence over templates; if you drop an unsteretyped element - a Class, for example - onto a diagram, Enterprise Architect searches the Templates package for a Class diagram that defines an unsteretyped Class, and applies that definition to the new Class. If you drop a stereotyped Class onto a diagram, the stereotype defines the Class appearance so the template is not accessed. Stereotypes are much more flexible for defining the appearance of an element under different scenarios.

## Procedure

To set up the element Templates package, follow the steps below:

1. Create a new package in the appropriate administration View. You can give this package any name; *Templates* is an unambiguous option.
2. Within the Templates package create new diagrams, one for each type of diagram to template. Give them easily recognized names; for example *ClassTemplate* for the template for Class diagrams.
3. Add new elements to the template diagrams from the **Toolbox** and configure the size, appearance, notes, version and other properties.
4. Select the **Settings | Template Package** menu option to set the templates as the default element templates. The **Browse Project** window displays.

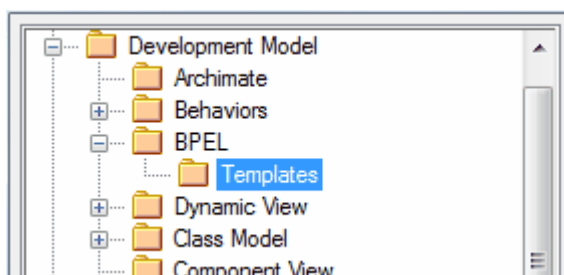

5. Locate and click on the Templates package, and click on the **OK** button to set the package as the default element template.

Now each new element you add to your project is created with the settings from the appropriate Template diagram.

**Note:**

If you decide not to use the default element template, set the default element template to **<none>** in the **Browse Project** window. The **<none>** package is at the bottom of the hierarchy shown in the **Browse Project** window.

#### 4.6.4.20 Highlight Context Element

You can show a hatched border around a selected element by selecting the **Always Highlight Context Element** checkbox on the Diagram **Behavior** page of the **Options** dialog (select the **Tools | Options | Diagram | Behavior** menu option). If you have selected this checkbox, the selected element displays similarly to the following example:

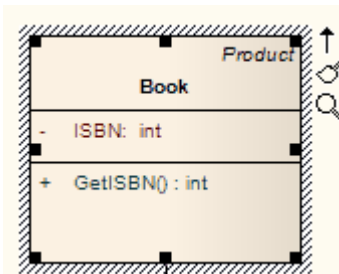

If you have not selected the **Always Highlight Context Element** checkbox, the selected element does not have a hatched border around it.

#### Multiple Selections

Whether you have selected the **Always Highlight Context Element** checkbox or not, if you select multiple elements one of the elements you select always has a hatched border. If you align the elements, this element is the one used to align the other elements against.

For example, if the elements in the diagram below are aligned, the top element aligns to the bottom element (the element showing a hatched border).

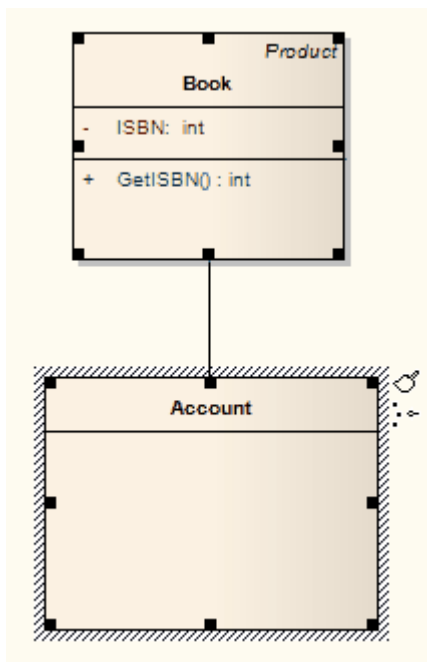

### Change the Element to Align Against

To change which element has a hatched border in a selected group (and thus the element that is aligned with) click on the element that the other elements are to align with.

#### 4.6.4.21 Make Linked Element a Local Copy

To convert a linked element to a local copy, follow the steps detailed below:

1. Open the diagram with the linked element.
2. Select the linked element and right-click on it to display its context menu.
3. Select the **Convert Linked Element to Local Copy** menu option.

The element changes to a local copy and is placed in the appropriate package.

#### 4.6.4.22 Copy Features Between Elements

Using drag and drop, you can copy [attributes](#)<sup>[558]</sup> and/or [operations](#)<sup>[569]</sup> from an element in the **Project Browser** on to another element in a diagram.

To move attributes and operations, see [Move Features Between Elements](#)<sup>[545]</sup>.

### Copy an Element Feature

To copy an element feature, follow the steps below:

1. Open a diagram that contains the target element (in the example below, the *AccountItem* Class is the target and *Customer* element is the donor).
2. Click on the attribute or operation and drag to the target element.

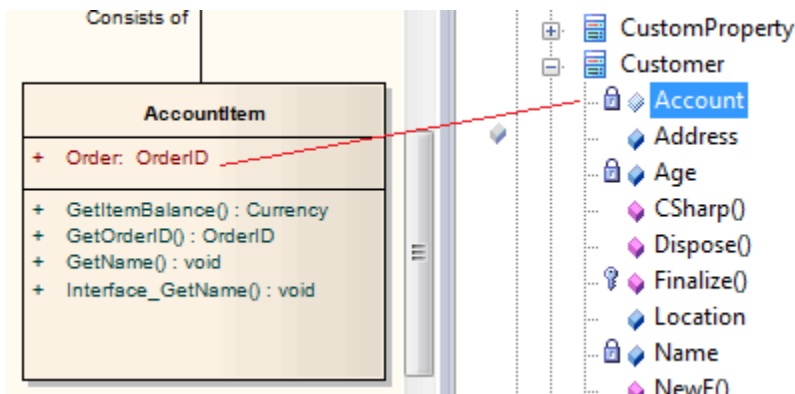

3. Release the mouse button.

The image below shows *AccountItem* after the attribute *Account* has been dropped from the browser on to it.

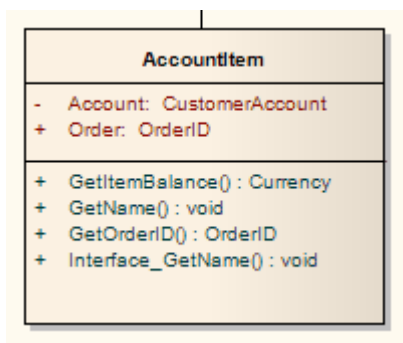

### Copy Multiple Element Features

To copy multiple element features, follow the steps below:

1. Open a diagram that contains the target element (in the example above, the *AccountItem* Class is the target and *Customer* element is the donor).
2. Hold down **[Ctrl]** (separate features) or **[Shift]** (select a range) and click on the attributes and/or operations to copy, then drag the selected features to the target element.
3. Release the mouse button.

#### 4.6.4.23 Move Features Between Elements

Using drag and drop, you can *move* [attributes](#)<sup>[558]</sup> and/or [operations](#)<sup>[569]</sup> from an element in the **Project Browser** on to another element within the **Project Browser**.

To *copy* attributes and operations, see [Copy Features Between Elements](#)<sup>[544]</sup>.

To move element features, follow the steps below:

1. In the **Project Browser**, locate the attributes and/or operations to move from the target element and select them while holding down **[Ctrl]** (single item select) or **[Shift]** (multiple item select).

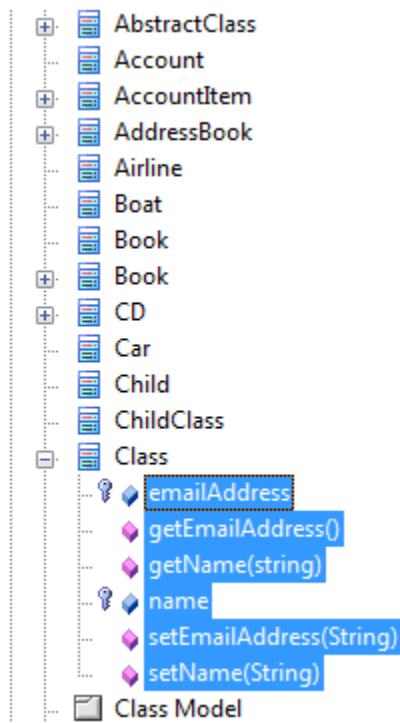

2. Holding down the mouse button, drag the attributes and/or operations to the target element. A single feature symbol (and, under some operating systems, the feature name) displays during the move; however all of the selected features are moved.

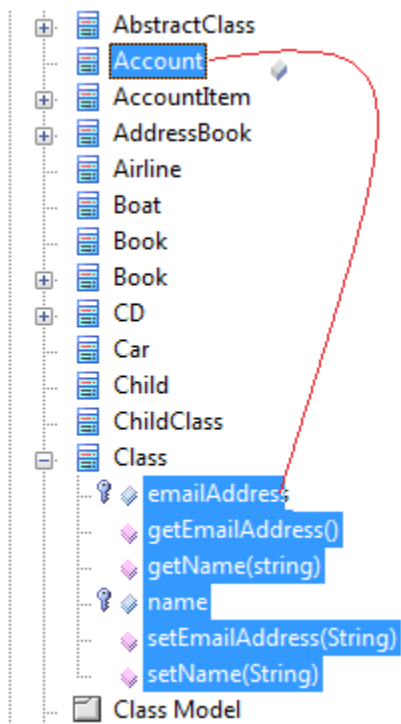

3. Release the mouse button. The image below shows the final stage of the attribute and operations move between the Class element and the Account element.

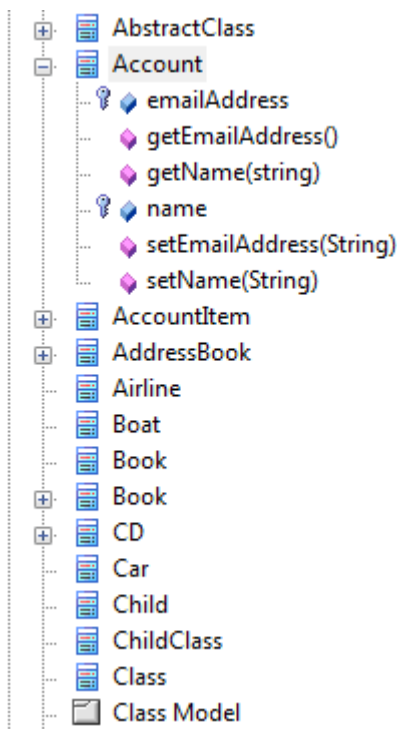

#### 4.6.5 Element Context Menu

Right-click on a single element in a diagram to open the element context menu. If two or more elements are selected, a different, [multiple selection context menu](#)<sup>[557]</sup> is displayed.

The element context menu is split into a number of sections and submenus:

- [Properties](#)<sup>[548]</sup>
- [Add](#)<sup>[550]</sup>
- [Find](#)<sup>[552]</sup>
- **Transform [Ctrl]+[H]** - [Transform](#)<sup>[1367]</sup> the selected element from one domain to another
- [Embedded Elements](#)<sup>[552]</sup>
- [Features](#)<sup>[554]</sup>
- **Generate DDL** - [Generate DDL](#)<sup>[1367]</sup> for a table, procedure or view Class
- [Code Engineering](#)<sup>[554]</sup>
- [Appearance](#)<sup>[555]</sup>
- **UML Help** - display the Enterprise Architect Help topic for the UML element type
- **Delete [Ctrl]+[D]** - delete the element.

##### Note:

Context menus vary between element types. The **Code Engineering** options won't display for a Use Case element, for example.

**Example Context Menu for a Class:**

**Example Context Menu for an Activity:**

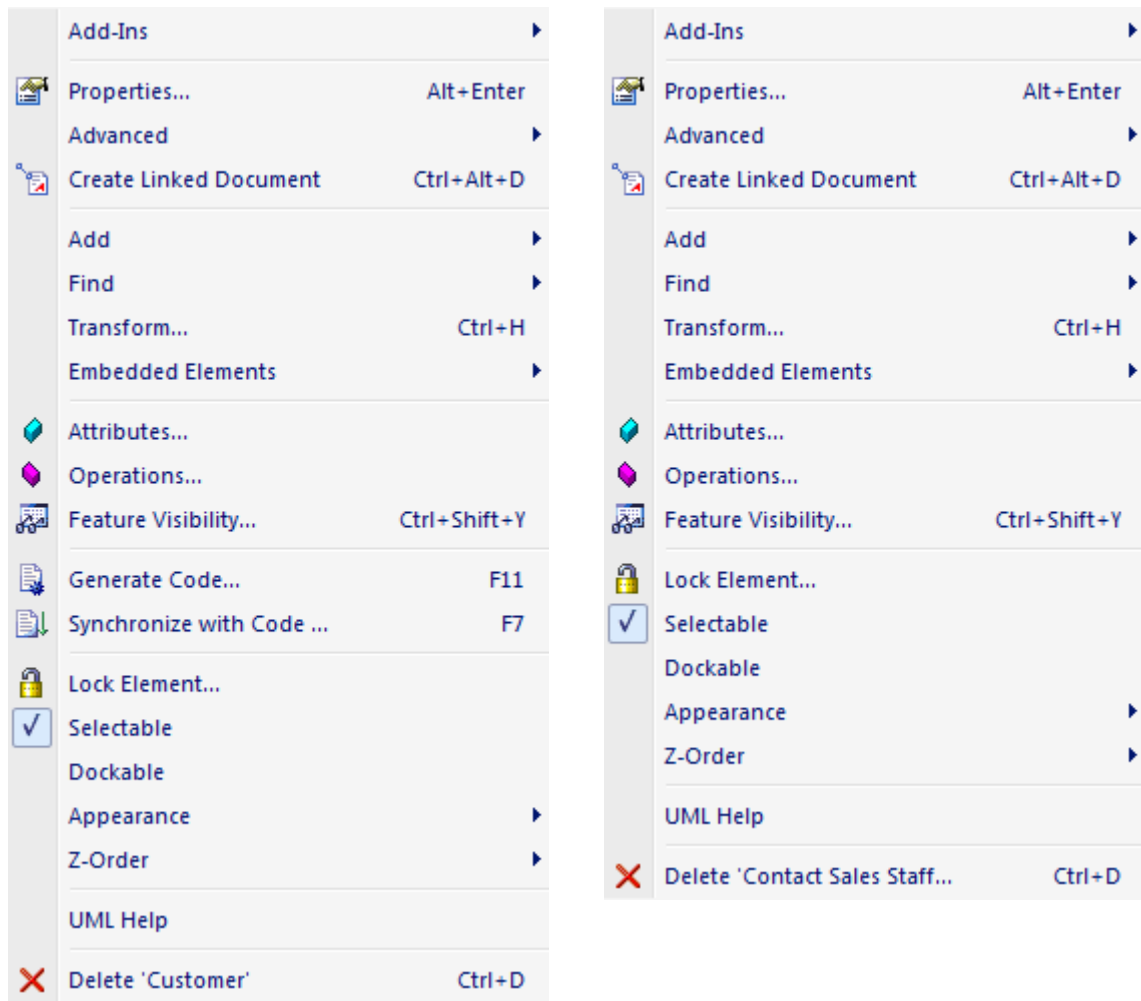

#### 4.6.5.1 Properties Menu Section

The **Properties** section of the element context menu can contain the following options:

Menu Option & Function Keys	Use to
<b>Properties [Ctrl]+[Enter]</b>	Open the <a href="#">Properties dialog</a> <sup>[481]</sup> for the selected element. For State Lifeline and Value Lifeline elements, display the <a href="#">Configure Timeline</a> <sup>[697]</sup> dialog.
<b>Advanced</b>	Open the <a href="#">Advanced</a> <sup>[549]</sup> sub-menu.
<b>Rule Composer</b>	For a Rule Task element, invoke the <a href="#">Rule Composer</a> <sup>[945]</sup> tab in Business Rule Modeling.
<b>Other Properties</b>	For State Lifeline and Value Lifeline elements, display the <a href="#">Properties dialog</a> <sup>[481]</sup> for the selected element.
<b>Create (or Edit) Linked Document [Ctrl]+[Alt]+[D]</b>	(Corporate, Business and Software Engineering, Systems Engineering and Ultimate editions) <a href="#">Create</a> <sup>[599]</sup> an RTF document linked to the element.
<b>Delete Linked Document</b>	Delete an existing linked document for the element.



#### 4.6.5.1.1 Advanced Submenu

The **Advanced** submenu on an element context menu can contain the options listed in the table below.

**Notes:**

- Context menus vary between element types. Not all menu options shown here are present on all element context menus; for example, the **Partition Activity** option only displays for an Activity element.
- If an element appearance is overridden by a [Shape Script](#)<sup>[1147]</sup>, several of the appearance options are disabled; for example, **Use Rectangle (Circle) Notation**.

Menu Option & Function Keys	Use to
<b>Custom Properties</b> [Ctrl]+[Shift]+[Enter]	Open the <a href="#">Custom Properties</a> <sup>[550]</sup> dialog.
<b>Parent</b> [Ctrl]+[I]	<a href="#">Set the element parent</a> <sup>[526]</sup> .
<b>Instance Classifier</b> [Ctrl]+[L]	Set the <a href="#">instance classifier</a> <sup>[515]</sup> for the element, on the <b>Select &lt;Item&gt;</b> dialog.
<b>Classifier Properties</b> [Ctrl]+[Alt]+[Enter]	Open the <a href="#">Properties</a> <sup>[481]</sup> dialog for the <i>classifier</i> of the selected element.
<b>Make Composite</b>	Set the element as a <a href="#">Composite element</a> <sup>[837]</sup> .
<b>Change to State (Value) Lifeline</b>	Switch one type of Lifeline element to the other.
<b>Show Composite Diagram</b>	Display a mini-picture of the contents of a composite element within that element.
<b>Multiplicity</b>	Define the <a href="#">multiplicity</a> for the element, using the format defined on the <a href="#">Cardinality</a> <sup>[665]</sup> tab.  This is the number of instances of the element that can exist in a set. The value displays on the element in a diagram, in the <i>Name</i> compartment.
<b>Edit Extension Points</b>	For an extended Use Case, display the <a href="#">Use Case Extension Points</a> <sup>[807]</sup> dialog, which you use to insert the point at which the behavior should be inserted.
<b>Association Class</b>	<a href="#">Connect the Class to a new Association</a> <sup>[857]</sup> (if the element is a Class).
<b>Use Rectangle (Circle) Notation</b>	Use <a href="#">rectangle notation</a> <sup>[808]</sup> for the element.
<b>Partition Activity</b>	Define an <a href="#">Activity Partition</a> <sup>[756]</sup> .
<b>Set Run State</b>	Add a new instance variable to the element using the <a href="#">Define Run State</a> <sup>[824]</sup> dialog.
<b>Set Property Value</b>	(Part elements) Set the property value for the Part, using the <b>Set Property Values</b> dialog.
<b>Override Attribute Initializers</b> [Ctrl]+[Shift]+[R]	Pre-define initial values for attributes that can be used to override existing defaults.
<b>Convert to Instance (Property)</b>	Convert this classifier to an instance or a property, depending on the type of classifier selected (for example, SysML classifiers are always converted to properties).
<b>Convert Linked Element To Local Copy</b>	Convert the occurrence of the element on this diagram from a link to the original element to a local copy of the element.

Menu Option & Function Keys	Use to
<b>Make Sender/Receiver</b>	Toggle the element from a sender to a receiver and vice versa.
<b>Accept Time Event</b>	Change the notation for an Accept Event action to an Accept Time Event action.
<b>Set Object State [Ctrl] +[Shift]+[S]</b>	Set the <a href="#">state of an object</a> <sup>[824]</sup> /instance based on the child states of its classifier.
<b>Define Concurrent Substates</b>	<a href="#">Define a set of substates</a> <sup>[681]</sup> that can be held simultaneously within that composite state.
<b>Use State Label Notation</b>	Display State Label Notation for a State object (the element name is displayed on a box on top of the element rather than inside it).
<b>Deep History</b>	Change the type of a shallow History pseudo-state to a deep History. Applies only when right-clicking on a <a href="#">History</a> <sup>[777]</sup> pseudo-state.
<b>Set Attached Links</b>	<a href="#">Attach the selected Note element</a> <sup>[612]</sup> to a connector, or several connectors.
<b>Link to Diagram Note</b>	Display the diagram notes as the Note element text. The option simply deletes any current text and blocks the Note from being edited other than through the <b>Notes</b> field in the diagram <b>Properties</b> dialog.

#### 4.6.5.1.2 Custom Properties Dialog

Certain elements and connectors feature the **Custom Properties** option in their context menu. The following example shows the **Custom Properties** dialog for an Activity element. Properties differ between the various types of element or connector.

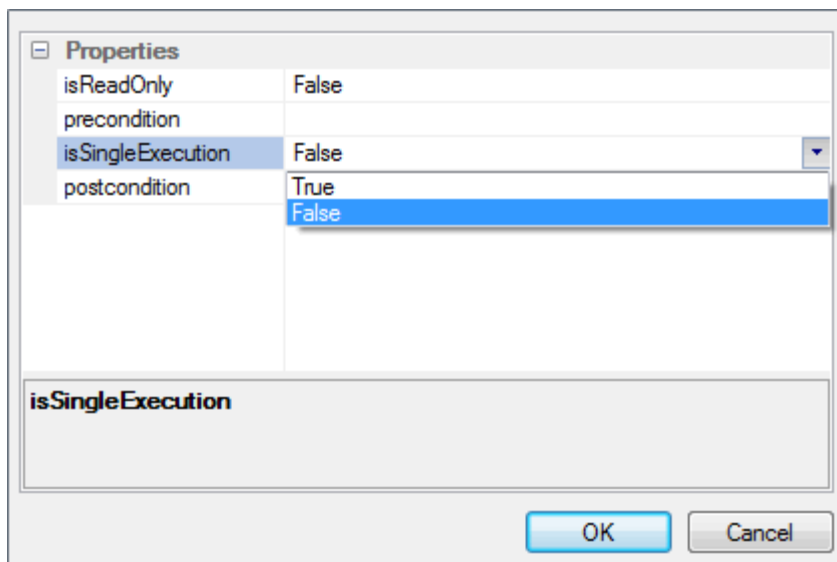

As shown above, you can change the values of properties either by selecting the value from the property's drop-down list or by typing the value in the field to the right of the property.

#### 4.6.5.2 Add Submenu

The **Add** submenu enables you to add supporting elements and diagrams to the selected element.

Menu Option	Use to
<b>Tagged Value</b>	<a href="#">Add a Tagged Value</a> <sup>[634]</sup> .

Menu Option	Use to
Related Elements	Open the <a href="#">Insert Related Elements</a> [551] dialog.
Note	Create and attach a blank <a href="#">Note</a> [536] element to the current element.
Constraint	Create and attach a blank <a href="#">Constraint</a> [785] element to the current element.
Activity	Add an <a href="#">Activity</a> [753] element as a child of the current <a href="#">Classifier</a> [519] element, with either an Activity diagram or an Interaction Overview diagram.
Interaction	Add an <a href="#">Interaction</a> [779] element as a child of the current Classifier element, with either a Sequence diagram, a Communication diagram or a Timing diagram.
State Machine	Add a <a href="#">State Machine</a> [796] element as a child of the current Classifier element, with a State Machine diagram.
RuleFlow activity	For a Class element, create a <a href="#">Rule Flow Activity</a> [939] element with a child Rule Flow diagram, as a behavior for the Class.
Add Diagram	Add a child diagram to the Classifier element, using the <a href="#">New Diagram</a> [422] dialog.

**Note:**

Not all menu options shown here are present on all element context menus. Context menus vary between element types. The options relating to Classifiers, for example, are not available for Object elements.

**4.6.5.2.1 Insert Related Elements**

The **Insert Related Elements** dialog can be accessed from the **Add | Related Elements** option on most element context menus. This dialog enables you to insert connected elements from elsewhere in the model into the current diagram.

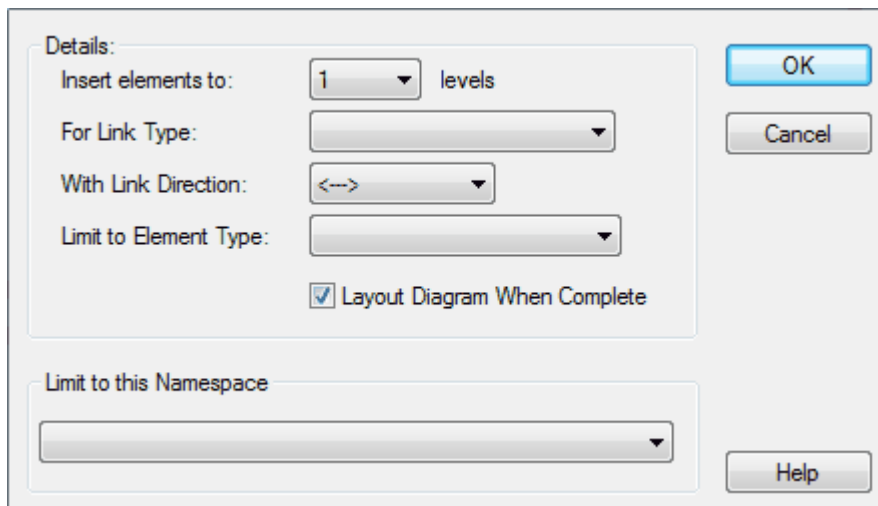

You can specify the following details:

Option	Use to
<b>Insert elements to: «x» levels</b>	Select the level down to which to insert connected elements, between levels 1 and 5.  You can select levels 4 or 5 to see how far the element/relationship hierarchy extends, but as this can produce a complicated and tangled diagram, it is better to use level 1 or 2 on selected elements in turn.

Option	Use to
For Link Type	Select a type of connector to limit the inserted elements to those connected by that relationship type.
With Link Direction	Select whether the connectors are to be a single direction or bi-directional.
Limit to Element Type	Select a type of element to limit the inserted elements to those of that element type.
Layout Diagram When Complete	Select whether Enterprise Architect should layout the diagram after the elements have been inserted. The layout applied is the <a href="#">Digraph</a> <sup>[465]</sup> layout.  <b>Note:</b> If no elements have been added, this option has no effect. Elements have to be added for Enterprise Architect to adjust the layout.
Limit to this Namespace	Select a specific namespace from which the inserted elements are to come.

#### 4.6.5.3 Find Submenu

The **Find** submenu on the element context menu can contain the following options:

Menu Option & Function Keys	Use to
In Project Browser [Alt]+[G]	Highlight the currently selected element in the <b>Project Browser</b> .
Locate Classifier In Project Browser [Ctrl]+[Alt]+[G]	Highlight the classifier for the currently-selected object, in the <b>Project Browser</b> .
Locate Operation in Project Browser [Ctrl]+[Alt]+[G]	Highlight the call operation for the currently-selected <b>Activity</b> <sup>[744]</sup> , in the <b>Project Browser</b> .
In Diagrams [Ctrl]+[U]	Open the <b>Element Usage</b> <sup>[526]</sup> dialog.
Custom References [Ctrl]+[J]	Set up <b>Cross References</b> <sup>[527]</sup> .
Add to Favorites	Add the element to the <b>Favorites folder</b> <sup>[669]</sup> in the <b>Resources</b> window.

#### 4.6.5.4 Embedded Elements Submenu

The **Embedded Elements** submenu on the element context menu can contain the following options:

Menu Option	Use to
Add Port	Add an embedded Port to the element.
Add Required Interface	Add an embedded Required Interface to the element.
Add Provided Interface	Add an embedded Provided Interface to the element.
Add Action Pin	Add an embedded Action Pin to the element.
Add Expansion Node	Add an embedded Expansion Node to the element.
Add Object Node	Add an embedded Object Node to the element.
Add Activity Parameter	Add an embedded Activity Parameter to the element.
Add Entry Point	Add an embedded Entry Point to the element.
Add Exit Point	Add an embedded Exit Point to the element.

Menu Option	Use to
Embedded Elements	Open the <a href="#">Embedded Elements</a> <sup>[553]</sup> window.
Show Realized Interfaces	Display each interface <a href="#">directly realized</a> <sup>[452]</sup> by a Class.
Show Dependent Interfaces	Display each dependency relationship for that model element as a lollipop style node attached to its left-hand side.

**Note:**

Not all menu options shown here are present on all element context menus. Context menus vary slightly between element types. Of the **Add** options, only **Add Port** displays for a Class element, for example.

**4.6.5.4.1 Embedded Elements Window**

The **Embedded Elements** dialog enables you to embed particular elements into other elements. For example, a Port can be embedded into a Class. The **Embedded Elements** option is available on the context menu of some elements.

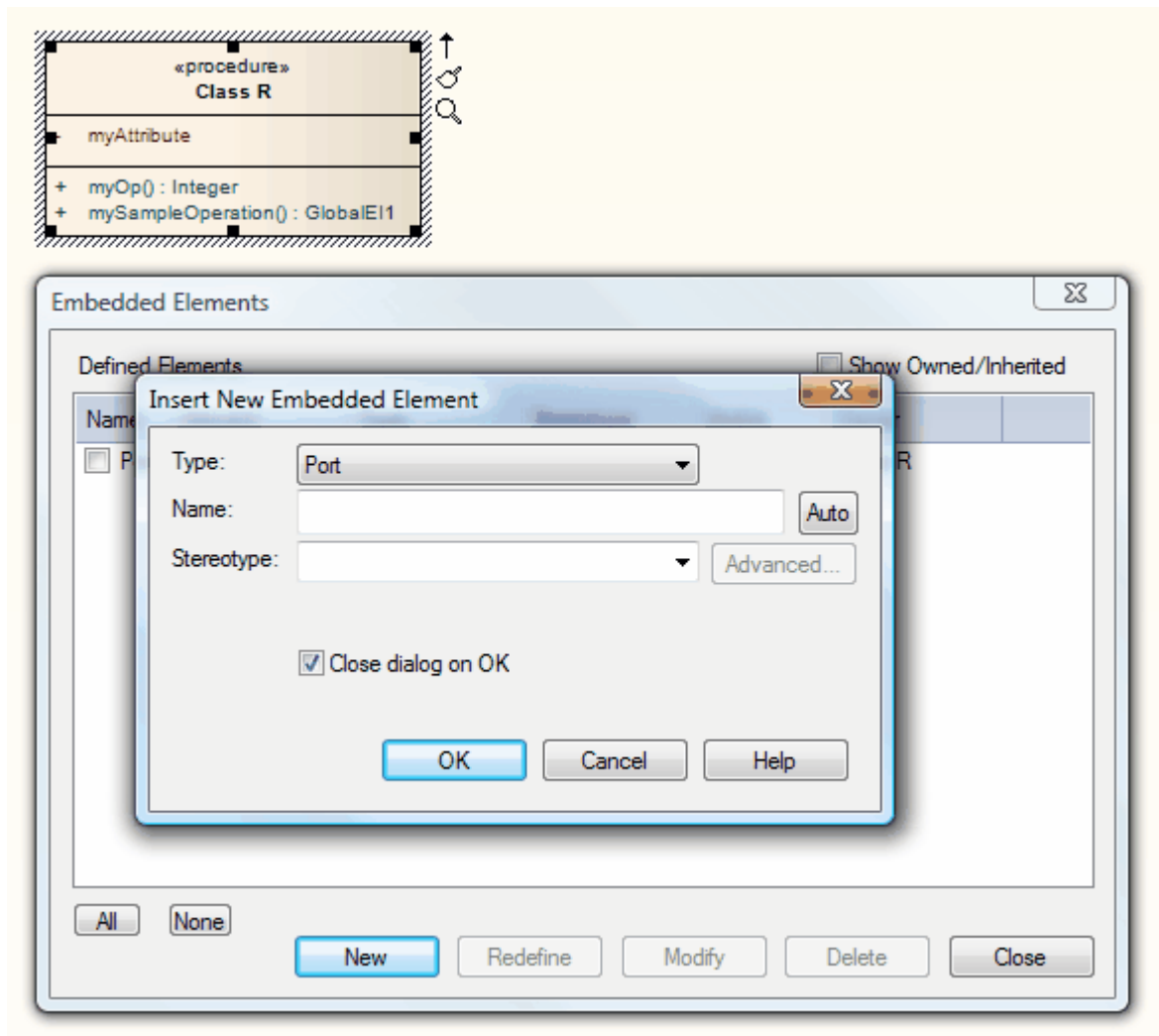

In the **Embedded Elements** dialog, click on the **New** button to create a new embedded element. Enter details such as type, name and stereotype, and click on the **OK** button. The embedded element now shows on the primary element as shown below.

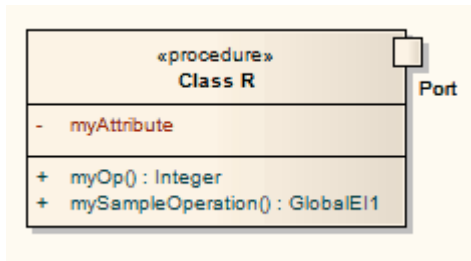

You can add as many embedded elements as necessary. Modify or delete embedded elements using the **Embedded Elements** dialog.

To incorporate inherited or owner properties, select the **Show Owned/Inherited** checkbox.

The name of the embedded element is a label, which you can edit using the **Labels** <sup>[452]</sup> context menu.

#### 4.6.5.5 Features Menu Section

The **Features** section of the element context menu can contain the following options:

Menu Option & Function Keys	Use to
<b>Attributes</b>	Open the <b>Attributes</b> <sup>[558]</sup> dialog.
<b>Operations</b>	Open the <b>Operations</b> <sup>[570]</sup> dialog.
<b>Feature Visibility</b> [Ctrl]+[Shift]+[Y]	Open the <b>Feature Visibility</b> <sup>[438]</sup> dialog.

#### Note:

Not all menu options shown here are present on all element context menus. Context menus vary slightly between element types. The **Attributes** and **Operations** options won't display for an Action element, for example.

#### 4.6.5.6 Code Engineering Menu Section

The **Code Engineering** submenu on the element context menu can contain the following options:

Menu Option & Function Keys	Use to
<b>Generate Code</b> [F11]	<b>Generate source code</b> <sup>[1309]</sup> for the selected element (forward engineer).
<b>Synchronize With Code</b> [F7]	<b>Reverse engineer source code</b> <sup>[1328]</sup> for the selected element.
<b>View Source Code</b> [F12]	<b>Open the source editor</b> <sup>[1441]</sup> if a file exists for that selected element.
<b>Create Workbench Instance</b> [Ctrl]+[Shift]+[J]	<b>Create a workbench instance</b> <sup>[1521]</sup> for the <b>Debug Workbench</b> (if a debug command has been configured for the parent package).

#### Note:

Not all menu options shown here are present on all element context menus. Context menus vary slightly between element types. These Code Engineering options won't appear for a Use Case element, for example.

#### 4.6.5.7 Appearance Menu Section

The **Appearance** section of the element context menu can contain the following options:

Menu Option	Use to
<b>Lock Element</b>	<p>Lock the element so it can't be edited. To unlock the element, select <b>Lock Element</b> again.</p> <p><b>Note:</b></p> <p>This does not apply in the Corporate, Business and Software Engineering, Systems Engineering and Ultimate editions when security is enabled; in that situation, see the <a href="#">Lock model elements</a><sup>[204]</sup> topic.</p>
<b>Selectable</b>	<p>Toggle whether the element is selectable or not. If an element is selectable, you can move it around the diagram and perform right-click context menu operations.</p> <p>If an element is unselectable, you cannot move it around the diagram and the only right-click operation available is to make the element selectable.</p> <p>This option has no effect on double-click operations on the element, such as displaying child diagrams or <b>Properties</b> dialogs.</p> <p>Note that an element on a locked diagram is also unselectable - if you click on it, the element outline displays in red.</p>
<b>Dockable</b>	<p>Align and join two elements either vertically or horizontally, on the current diagram only.</p> <p>Both elements must have the <b>Dockable</b> option selected, and must have the joining edges parallel. As the distance between the elements narrows, the moving element snaps to the edge of the other element. For <a href="#">Activity Partitions</a><sup>[786]</sup>, the option is selected by default.</p> <p>Deselecting the <b>Dockable</b> option does not separate the elements; if necessary, you can simply move the elements apart again.</p>
<b>Appearance</b>	Display the <b>Appearance</b> submenu; see the table below.
<b>Z-Order</b>	Set the <a href="#">Z-Order</a> <sup>[437]</sup> of the element.

**Note:**

You can also change the appearance (and other aspects) of [several selected elements at once](#)<sup>[557]</sup>.

#### Appearance Sub-Menu

Menu Option & Function Keys	Use to
<b>Default Appearance [F4]</b>	<p>Override the <i>global</i> default appearance of all elements (which you set on the <b>Options</b> dialog, <a href="#">Standard Colors</a><sup>[353]</sup> page and <a href="#">Diagram Appearance</a><sup>[356]</sup> page) with a different <a href="#">default for just the selected element</a><sup>[538]</sup> on all diagrams in which it is found.</p> <p>To change the appearance of the selected element on the <i>current diagram only</i>, use the <a href="#">Format toolbar</a><sup>[85]</sup>.</p>
<b>Apply Image From Clipboard</b>	Paste the image held on the clipboard onto the selected element.
<b>Select Alternate Image [Ctrl]+[Shift]+[W]</b>	Select an alternative image using the <a href="#">image manager</a> <sup>[447]</sup> .
<b>Hide/Show Name Under</b>	Hides or redisplay the name label under an element with an alternative image.

Menu Option & Function Keys	Use to
Image	
Set Font	Change the <a href="#">font</a> <sup>[556]</sup> type, size, color and effects for the text in an element.
Show Labels	Reveal any hidden labels on the element.
Copy Appearance to Painter	Copy the default element appearance (set using the <b>Default Appearance</b> option, above) to the painter. You then paste the default appearance using the <b>Paste Appearance</b> option on the <a href="#">Diagram toolbar</a> <sup>[837]</sup> .
Copy Image to Clipboard	Copy the element image to the clipboard.

**Note:**

Not all menu options shown here are present on all element context menus. Context menus vary slightly between element types. The **Alternate Image** option won't display for a Lifeline element, for example.

**4.6.5.7.1 Set Element Font**

You can change the appearance of the text within an element, for one or more selected elements, by either:

- Selecting the **Appearance | Set Font** context menu option, or
- Selecting the **Font** icon on the [Format](#)<sup>[85]</sup> toolbar.

The **Font** dialog displays.

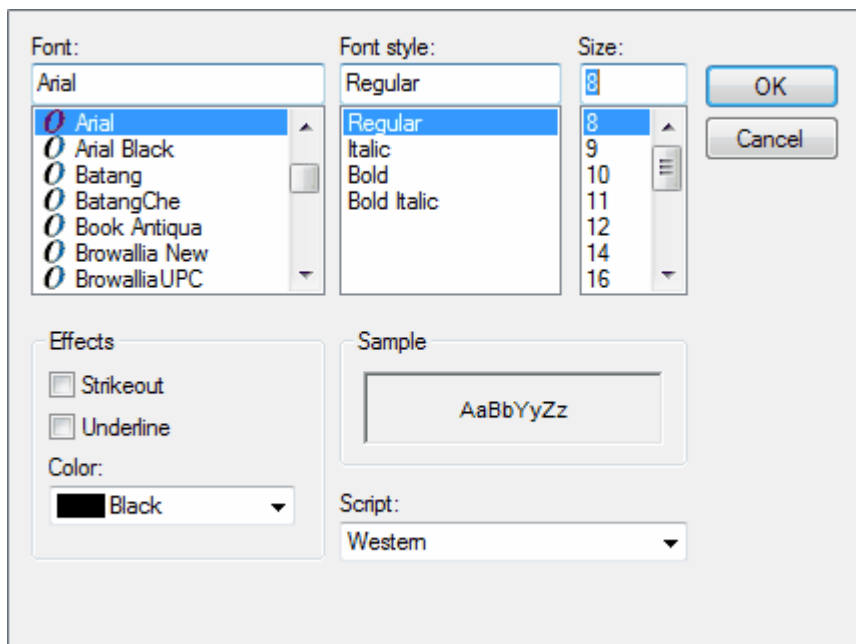

Select the font, style, size, color and effects, and (if necessary) the script type. Click on the **OK** button to save your changes.



#### 4.6.5.8 Element Multiple Selection Menu

You can perform operations on two or more elements on a diagram at once. To select the required elements, either click and drag the cursor over the group to highlight them, or press **[Shift]** and click on each element. Right-click on an element to display the following context menu:

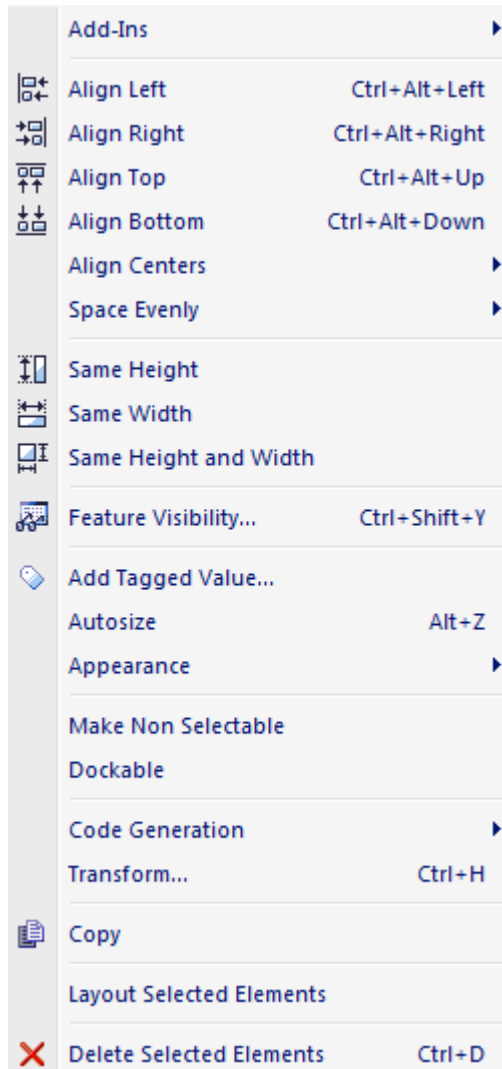

This menu enables you to do the following:

#### Note:

Where elements are made the same, they are matched to the element you right-clicked on.

- Align elements (by left edge, right edge, top, bottom, center in a column or center in a row)
- Space elements evenly (across or down)
- Standardize the dimensions of the selected elements
- Specify the [visibility of features](#) <sup>[438]</sup> for all selected elements
- [Add the same Tagged Value](#) <sup>[635]</sup> to all selected elements
- Automatically resize elements to match (element content permitting)
- Turn the [Dockable](#) <sup>[555]</sup> option on or off for all selected elements on a diagram
- Set the [default appearance](#) <sup>[538]</sup> and [font](#) <sup>[556]</sup> for multiple elements at once
- Make the selected elements on the diagram [non-selectable](#) <sup>[555]</sup>; to make them selectable again, right-click on the diagram and select the **Make All Elements Selectable** context menu option
- Generate code for all selected elements at once, or synchronize the code against the selected elements

- [Transform](#) <sup>[1387]</sup> the selected elements
- Copy all selected elements to the clipboard
- Automatically adjust the layout of the selected elements on the diagram
- Delete all selected elements.

**Tip:**

It is much faster to assign an appearance or characteristic to a group of elements than to one element at a time.

### 4.6.6 Attributes

Attributes are features of an element that represent the properties or internal data elements of that element. Not all element types support attributes, and others have restrictions - for example, attributes of Interfaces must have Public scope.

Elements with attributes (typically Classes) display their features in diagrams in the manner shown below. Attributes display in the first compartment of properties in colored text - the default color is red (for example, *Age : int*).



For a Customer Class, *CustomerName* and *CustomerAddress* can be attributes. Attributes have several important characteristics, such as type, scope (visibility), static, derived and notes.

### Create and Modify Element Attributes

**Note:**

This facility is only available if the element supports attributes.

In the **Project Browser**, Classes with attributes have their features collected beneath them, each preceded by a blue box (◆).

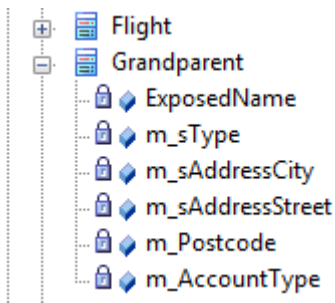

1. In the **Diagram** view, either:
  - Right-click on the element to be edited, and from the context menu select the **Attributes** menu option
  - Click on the element and press **[F9]**, or
  - Drag the attribute from the **Project Browser** onto the element.
2. The **<Element name> Attributes** dialog displays.

Name	Type	Initial Value
m_delivery	int	

**Notes:**

- If you make changes and do not save them, the **Cancel** button prompts you to save or cancel the changes, whilst the **Close** button closes the dialog immediately and does not save the changes.
- If you are creating many attributes, go to the **Attribute/Operations** page of the **Options** dialog (**Tools | Options | Source Code Engineering | Attribute/Operations**) and select the **After save, re-select edited item** checkbox. Now, when you create an attribute and click on the **Save** button, the dialog fields clear ready for you to enter the details of the next attribute. This helps you when you want to create attributes quickly and might not necessarily want to fully define each one as you create it.

See the topics on the **Attributes** dialog [General](#)<sup>[560]</sup>, [Detail](#)<sup>[562]</sup> and [Constraints](#)<sup>[563]</sup> tabs.

**Note:**

If the parent element provides source or target roles for a connector, the connector can be attached to a specific attribute. See the [Connect to Element Feature](#)<sup>[61]</sup> topic.

**See Also**

- [Attribute Tagged Values](#)<sup>[564]</sup>
- [Create Properties](#)<sup>[565]</sup>
- [Display Inherited Attributes](#)<sup>[567]</sup>
- [Create Object From Attribute](#)<sup>[568]</sup>

**4.6.6.1 Attributes Dialog - General Tab**

The **General** tab of the **Attributes** dialog is shown below:

The screenshot shows the 'Attributes' dialog box with the 'General' tab selected. The dialog contains the following fields and options:

- Name:** m\_delivery
- Alias:** (empty)
- Type:** int
- Scope:** Private
- Stereotype:** input element
- Containment:** Not Specified
- Initial:** (empty)
- Notes:** (Rich text editor with formatting tools)
- Options:**
  - Derived
  - Static
  - Property
  - Const

At the bottom of the dialog, there is a table of attributes and several buttons:

Name	Type	Initial Value
m_delivery	int	

Buttons: New, Copy, Save, Delete, Close, Cancel, Help.

To review an existing attribute, click on the attribute name in the **Attributes** panel.

To delete an existing attribute, click on the attribute name in the **Attributes** panel and click on the **Delete** button.

To create a new attribute, either:

- Click on the **New** button, or
- Click on an existing attribute name in the **Attributes** panel, and click on the **Copy** button.

Review, edit or complete the fields as indicated in the following table.

Field	Use to
<b>Name</b>	Display the name of the attribute. For a new attribute, type the name (with no spaces).
<b>Alias</b>	Display an optional alias for the attribute. If necessary, type in a new alias.
<b>Type</b>	Display the attribute's type. If necessary, click on the drop-down arrow and select a different type.  The type can be defined by the code language (data type) or by a classifier element. When you click on the drop-down arrow, the first set of values in the list provides the data types, and the second (longer) set provides the possible classifiers.  To add new code language data types that can be displayed in this list, see the <a href="#">Data Types</a> <sup>[666]</sup> topic.
[ ... ] (Select) button	Open the <a href="#">Select &lt;Item&gt;</a> <sup>[515]</sup> dialog, which you use to select or define a different attribute classifier type that might not be in the <b>Type</b> drop-down list.
<b>Scope</b>	Define the attribute as <b>Public</b> , <b>Protected</b> , <b>Private</b> or <b>Package</b> . If necessary, click on the drop-down arrow and select a different scope.
<b>Stereotype</b>	Define the optional stereotype of the attribute. If necessary, either type a different stereotype name or click on the drop-down arrow and select a stereotype.
<b>Containment</b>	Define the containment type (by reference, by value or not specified). If necessary, click on the drop-down arrow and select a different containment type.
<b>Derived</b>	Indicate that the attribute is a calculated value. If you select this checkbox, the attribute name in the element attributes compartment has the derived symbol ( <i>l</i> ) as a prefix.
<b>Static</b>	Indicate that the attribute is a static member.
<b>Property</b>	Indicate that the attribute has <a href="#">automatic property creation</a> <sup>[565]</sup> .
<b>Const</b>	Indicate that the attribute is a constant.
<b>Is Literal</b>	(For Enumeration elements.) Defaults to selected, to define the attribute as an enumeration literal. Deselect to define the attribute as a normal element attribute.  In the <b>Attributes</b> compartment on the diagram, the enumeration literals are listed separately, above the normal attributes. (Ensure that the <b>Stereotype</b> field for the normal attribute is not set to <b>enum</b> .)
<b>Initial</b>	Display an optional initial value. If necessary, type in a new initial value.
<b>Notes</b>	Enter any free text notes associated with the attribute. You can format the notes text using the <a href="#">Notes</a> <sup>[642]</sup> toolbar at the top of the field.

To change the position of an attribute in the list in the **Attributes** panel, click on the **Scroll Up** or **Scroll Down** (hand) buttons.

#### Note:

By default, the attributes are listed in alphabetical order. Before changing this sequence, you must deselect the **Sort Features Alphabetically** checkbox on the **Objects** page of the **Options** dialog (**Tools | Options | Objects**).

If you have changed the attribute details, click on the **Save** button to save the changes.

#### 4.6.6.2 Attributes Dialog - Detail

To define additional details relating to collections, click on the **Detail** tab of the **Attributes** dialog.

Field	Use to
Multiplicity	
Lower bound	Define a lower limit to the number of elements allowed in the collection.
Upper bound	Define an upper limit to the number of elements allowed in the collection.
Allow Duplicates	Indicate that duplicates are allowed. Maps to the UML property <i>isUnique</i> , value <i>FALSE</i> ).
Ordered Multiplicity	Indicate that the collection is ordered.
Redefined Property	Review the redefined properties for the attribute. Add redefined properties by clicking on the <b>Add</b> button to display the <a href="#">Select Property</a> <sup>[517]</sup> dialog.
Subsetted Property	Review the subsetted properties for the attribute. Add subsetted properties by clicking on the <b>Add</b> button to display the <a href="#">Select Property</a> <sup>[517]</sup> dialog.

Field	Use to
Collection	Code the attribute as an array, so that it can contain multiple concurrent values rather than a single value.
Attribute is a Collection	Indicate that the attribute is a collection (array).
Container Type	Enter the name of the container type.
Other	
Transient	(For Java code) indicate that the attribute can change regardless of what the code is performing.
Qualifiers	Click on this button to add <a href="#">Qualifiers</a> <sup>[830]</sup> to the attribute, The <a href="#">Qualifiers</a> <sup>[832]</sup> dialog displays.

When you have completed these fields, click on the **Save** button.

#### 4.6.6.3 Attributes Dialog - Constraints

Attributes can also have constraints associated with them. Typically these indicate such things as maximum value, minimum value and length of field.

Select the **Constraints** tab of the **Attributes** dialog to define these constraints.

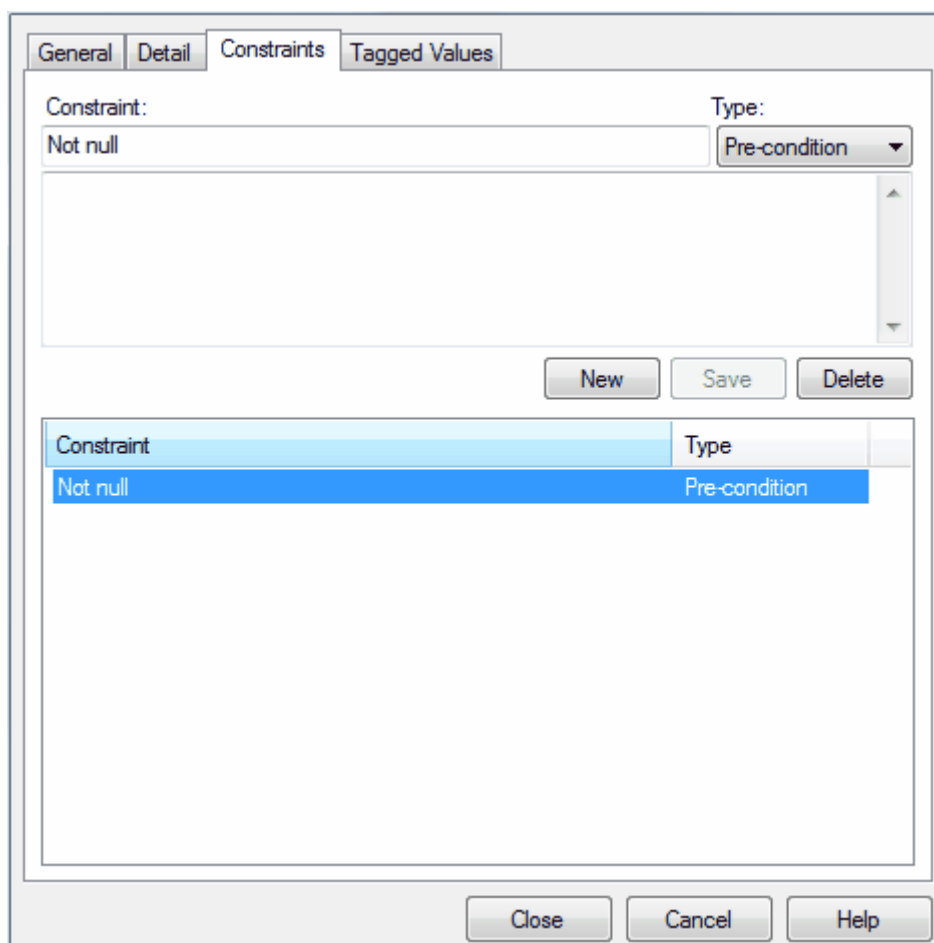

To review an existing constraint, click on the constraint name in the panel at the bottom of the dialog.

To delete an existing constraint, click on the constraint name in the panel and click on the **Delete** button.

To create a new constraint, click on the **New** button.

Review, edit or complete the fields as indicated in the following table.

Field	Use to
Constraint	Type the constraint name.
Type	Click on the drop-down arrow and select the constraint type.
(Notes)	Type any comments or notes concerning the constraint.

If you have created or edited the data, click on the **Save** button to save the changes.

#### 4.6.6.4 Attribute Tagged Values

You can define Tagged Values for an attribute. Tagged Values are a convenient means of extending the properties a model element supports. This in turn can be used by code generators and other utilities to transform UML models into other forms.

##### Note:

Tagged Values are supported for attributes, operations, objects and connectors.

#### Add a Tagged Value

To add a Tagged Value to an attribute, follow the steps below:

1. Click on the **Tagged Values** tab of the **Attribute Properties** dialog.

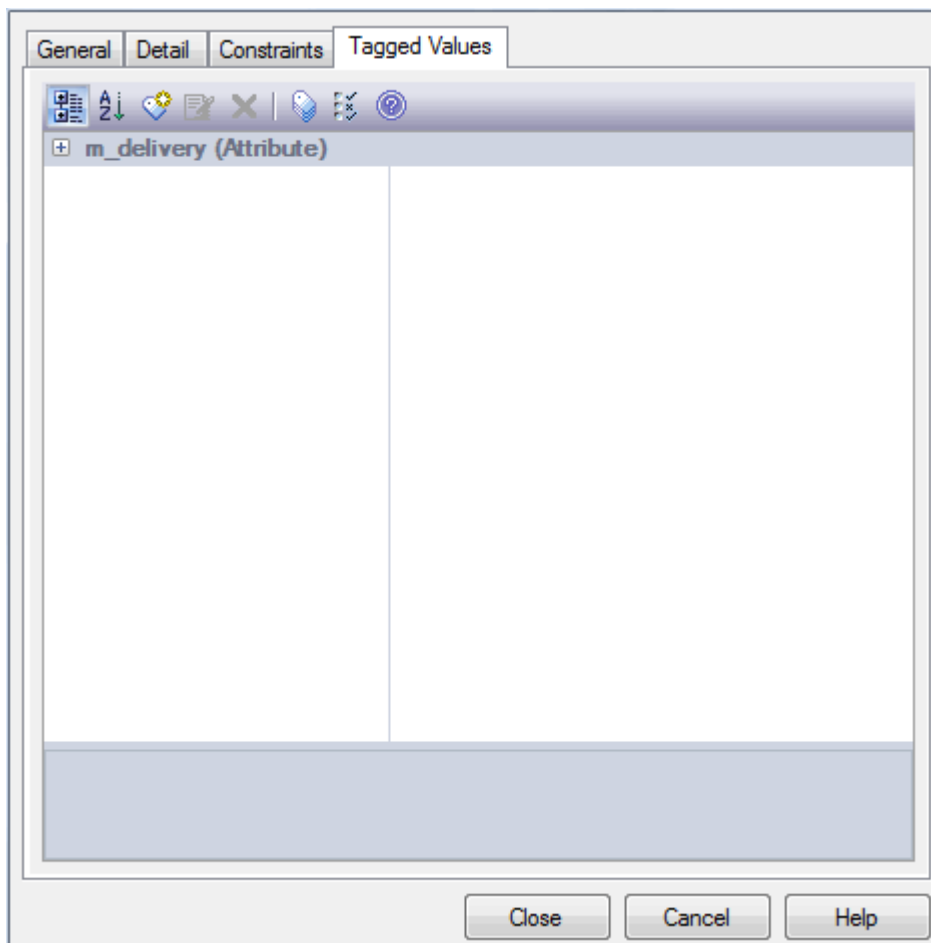



- Click on the **New tag** button (). The **Tagged Value** dialog displays.

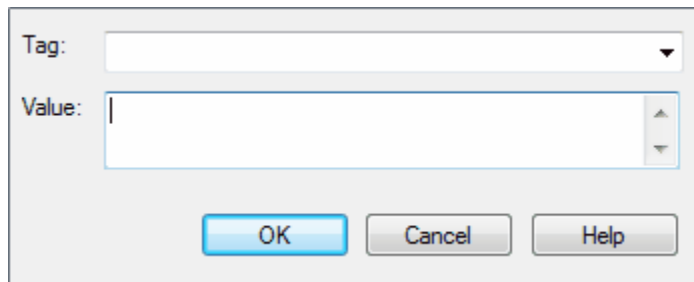

The **Tagged Value** dialog box contains a **Tag:** field with a drop-down arrow, a **Value:** text field, and three buttons at the bottom: **OK**, **Cancel**, and **Help**.

- In the **Tag** field, type the tag name or click on the drop-down arrow and select a defined tag.
- If appropriate, in the **Value** field type a specific value for the tag.
- Click on the **OK** button to confirm the operation. The tag name and value are displayed under the attribute in the **Tagged Values** tab.

**Note:**

You can define custom tags by [creating a Custom Tagged Value Type](#)<sup>[117]</sup>.

#### 4.6.6.5 Create Properties

Enterprise Architect has capabilities for automatically creating properties in various languages. Property creation is controlled from the **General** tab of the **Attribute** dialog.

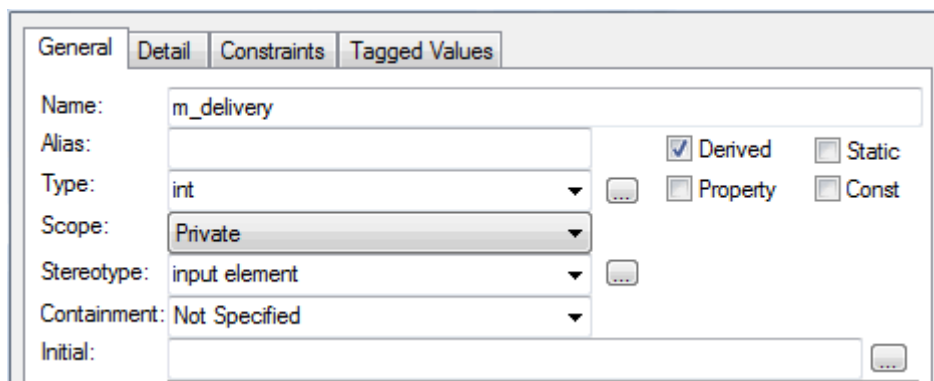

The **Attribute** dialog is shown with the **General** tab selected. The **Name** field contains 'm\_delivery'. The **Type** is 'int'. The **Scope** is 'Private'. The **Stereotype** is 'input element'. The **Containment** is 'Not Specified'. The **Initial** field is empty. On the right, there are checkboxes for **Derived** (checked), **Static**, **Property**, and **Const**.

Select the **Property** checkbox. The **Create Property Implementation** dialog immediately displays.

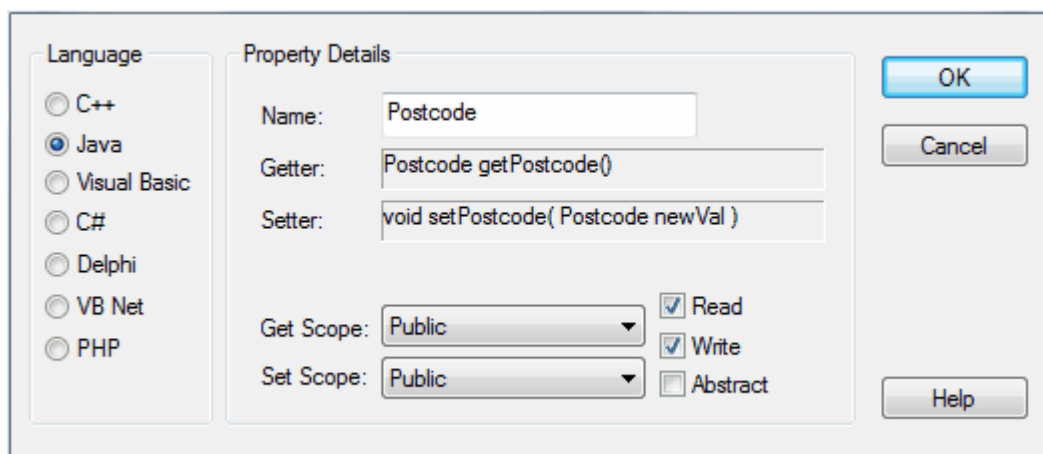

The **Create Property Implementation** dialog shows the **Language** panel with **Java** selected. The **Property Details** section includes:
 

- Name:** Postcode
- Getter:** Postcode getPostcode()
- Setter:** void setPostcode( Postcode newVal )
- Get Scope:** Public
- Set Scope:** Public
- Checkboxes for **Read** (checked), **Write** (checked), and **Abstract**.

 Buttons for **OK**, **Cancel**, and **Help** are on the right.

The **Language** panel defaults to the Class language; however, you can change this and generate the

properties for any language. Each language has slightly different syntax and generates slightly different results. For example:

- Java and C++ generate get and set functions
- C# and VB.Net create property functions
- Delphi creates get and set functions as well as a specialized Delphi property Tagged Value.

Type in the required details and click on the **OK** button. Enterprise Architect generates the required operations and properties to comply with the selected language.

Note that *get* and *set* functions are stereotypes with «*property get*» «*property set*» making it easy to recognize property functions. You can also hide these specialized functions by deselecting the **Property Methods** checkbox in the **Features** tab of the **Diagram Properties** dialog for a specific diagram (select the **Diagram | Properties** menu option). This makes it easier to view a Class, uncluttered by many *get* and *set* methods.

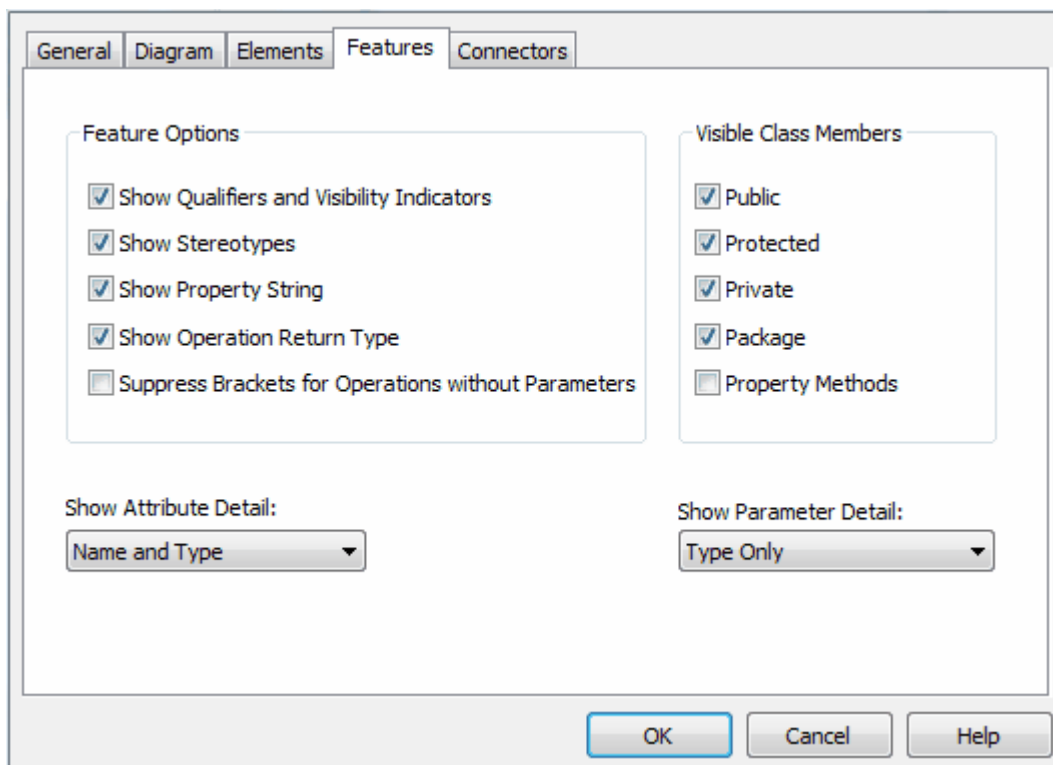

Note that for Delphi you must enable the **Tagged Values** compartment to see the generated properties. See [Compartments](#)<sup>[52]</sup> for the steps for doing this.

#### 4.6.6.6 Display Inherited Attributes

When displaying a Class with attributes in a diagram, you can also show the inherited attributes from all parents in the elements type hierarchy (ancestors).

To show inherited attributes, use the [Feature Visibility](#) <sup>[438]</sup> dialog.

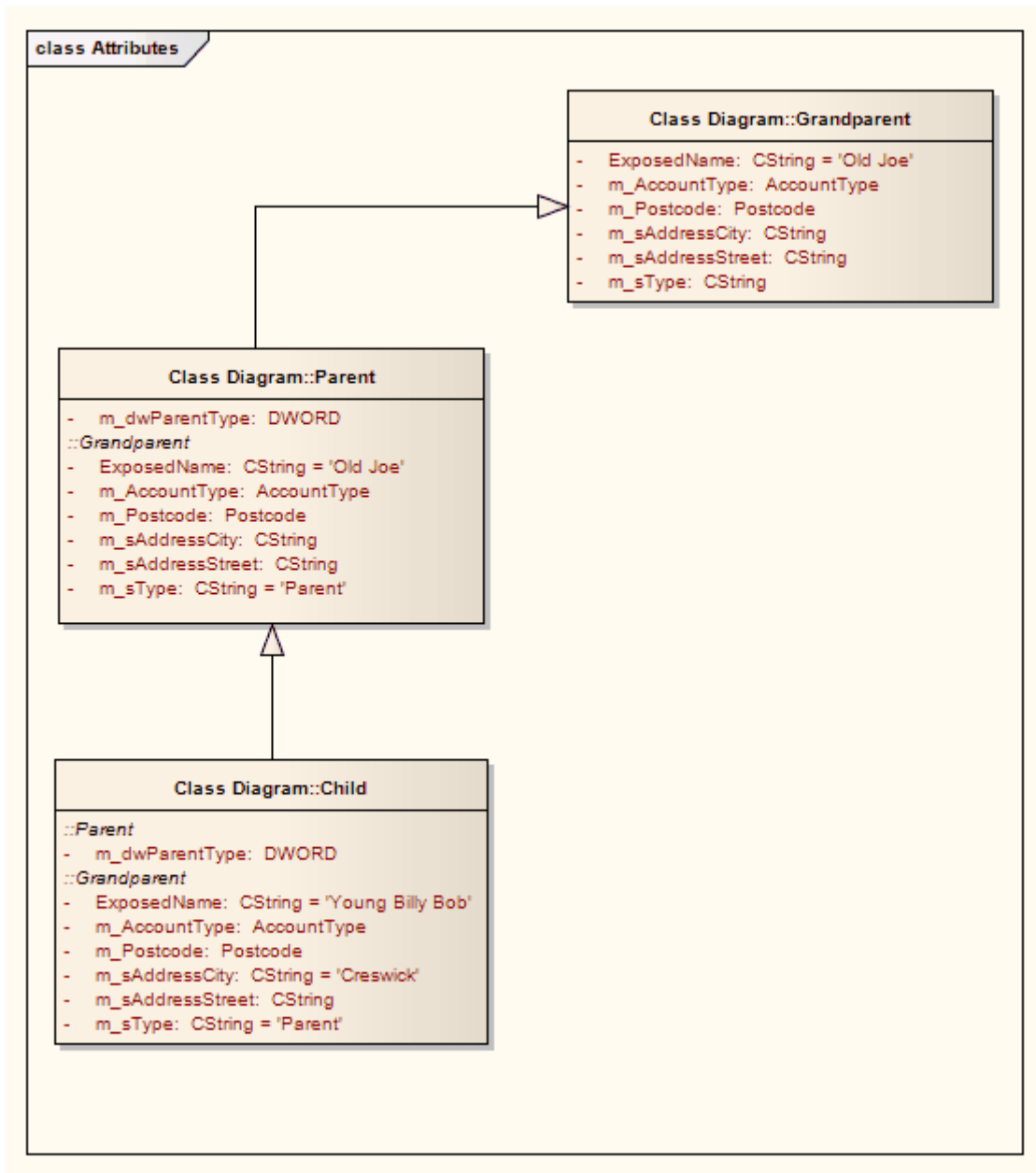

Note that for elements that have attributes, you can also override an inherited attribute's initial value, using the element context menu option **Advanced | Override Attribute Initializers**. This displays the **Override Attribute Initializers** dialog.

In the **Override Attribute Initializers** dialog, select the variable name and enter a new initial value. If required, you can type a note in the **Note** field. When you display inherited attributes, Enterprise Architect merges the list of attributes from all ancestors and merges the attribute initializers, so that the final child Class displays the correct attribute set and initial values.

#### 4.6.6.7 Create Object From Attribute

If you drag an attribute from the **Project Browser** onto an *Activity* diagram, the attribute generates an Object element of the same name. This is very useful for creating connectors between elements and specific attributes. For example, a Class element of stereotype *table* defines its fields as attributes; Requirement elements that define requirements for those fields can then be linked to the appropriate table fields via the attribute Object elements.

##### Note:

From Enterprise Architect release 7.5, you can create this relationship more directly by linking an attribute in an element to another element, or linking two attributes in different elements. See the [Connect to Element Feature](#) topic.

In the following diagram, the *billingAddress* Object was generated by dragging the *billingAddress* attribute from the *Account* Class in the **Project Browser** onto the diagram. The user then created *Realize* relationships between the *Account* element and the *billingAddress* element, and between the *billingAddress* element and the *REQ028* Requirement element.

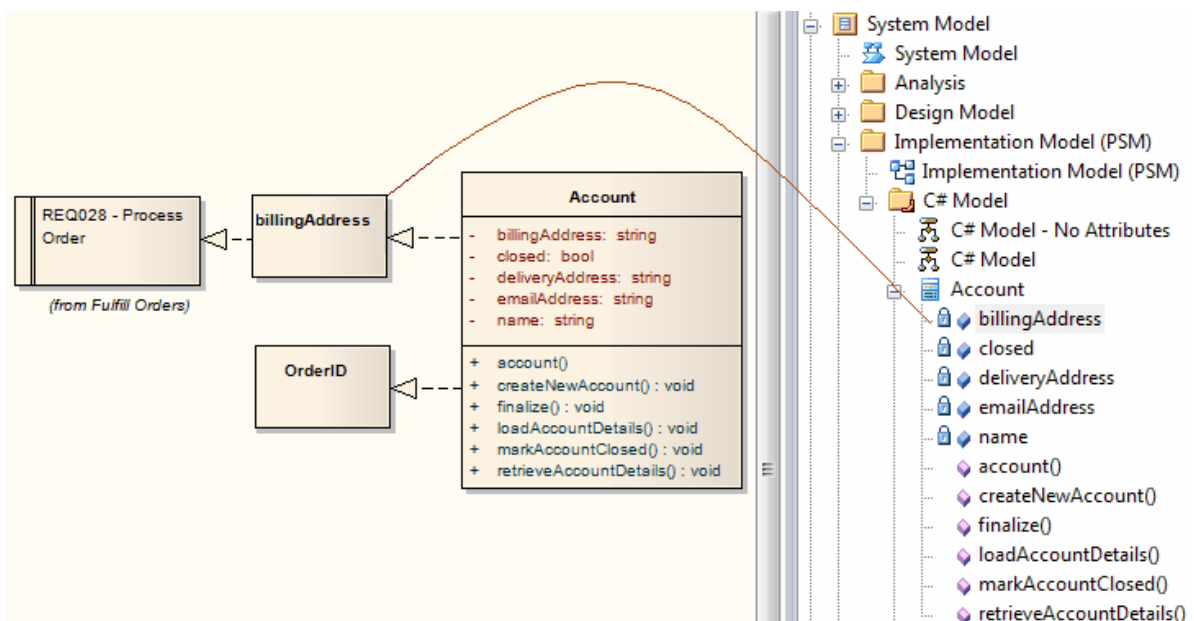

## 4.6.7 Behavior

Enterprise Architect enables you to define an element's behavior through the element's operations and parameters. You can also define the behavior of more specific behavioral elements such as Activities, Interactions, Actions and Interaction Occurrences, through the **Behavior** and **Call** tabs of the element **Properties** dialogs. For further details, see the following topics:

- [Operations](#) <sup>[569]</sup>
- [Interactions and Activities](#) <sup>[581]</sup>
- [Behavior Calls](#) <sup>[581]</sup> (Actions and Interaction Occurrences)
- [Behavior Parameters](#) <sup>[583]</sup>
- [Behavior Call Arguments](#) <sup>[582]</sup>

### 4.6.7.1 Operations

Operations are features of a Class or other element that represent the behavior or services an element supports. For a Customer Class, *UpdateCustomerName* and *GetCustomerAddress* can be operations. Operations have several important characteristics, such as type, scope (visibility), static, abstract and notes.

#### How to Access Operations

If an element supports operations (typically Classes and Interfaces), the right-click context menu contains the **Operations** menu item. Select this to open the [Operations dialog](#) <sup>[570]</sup>. Alternatively, press **[F10]**.

#### How Operations Appear in Diagrams

Elements with operations (typically Classes) display their features in diagrams in the manner shown below. Operations display in the second compartment of properties in colored text - the default color is dark green (for example, *Finalize()* : void). Some characteristics display in shorthand form; for example, *static* displays as \$, *abstract* as \*.

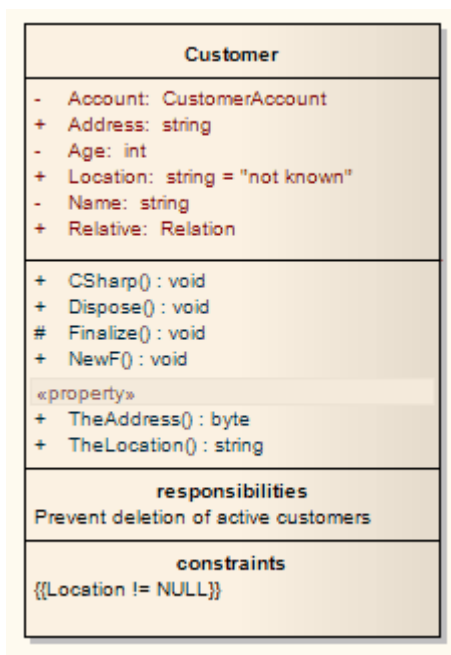

#### Note:

If the parent element provides source or target roles for a connector, the connector can be attached to a specific operation. See the [Connect to Element Feature](#) <sup>[611]</sup> topic.

#### Operations in the Project Browser

In the **Project Browser**, Classes with operations have their features collected beneath them, each preceded by

a pink box (  ). Right-click on an operation and select the **Operation Properties** context menu option to open the **Operations** dialog and edit details for the feature.

From the **Project Browser**, you can drag operations onto new elements to give them the same operations.

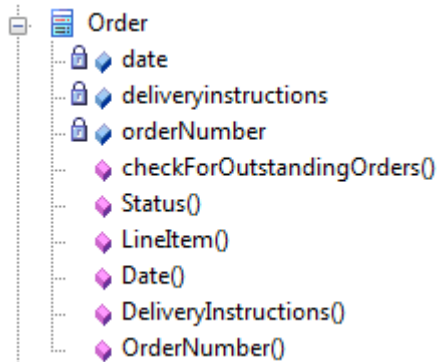

#### See Also

- [Behavior Parameters](#) <sup>[583]</sup>

#### 4.6.7.1.1 Operations Dialog - General

The **Operations** dialog has five tabs:

- General, from which you can also define [operation parameters](#) <sup>[583]</sup>
- [Behavior](#) <sup>[573]</sup>
- Pre-conditions and Post conditions (that is, [Constraints](#) <sup>[577]</sup>)
- Tagged Values.

The **General** tab of the **Operations** dialog enables you to define new operations and set the most common properties, including name, access type and return.

#### Note:

The **General** tab can vary according to the type of element you are adding an operation to. If defining operations for a data modeling table, see the [Index, Trigger, Check Constraint](#) <sup>[1033]</sup> topic. The following illustrations are for the operations of an Object element and a State element.

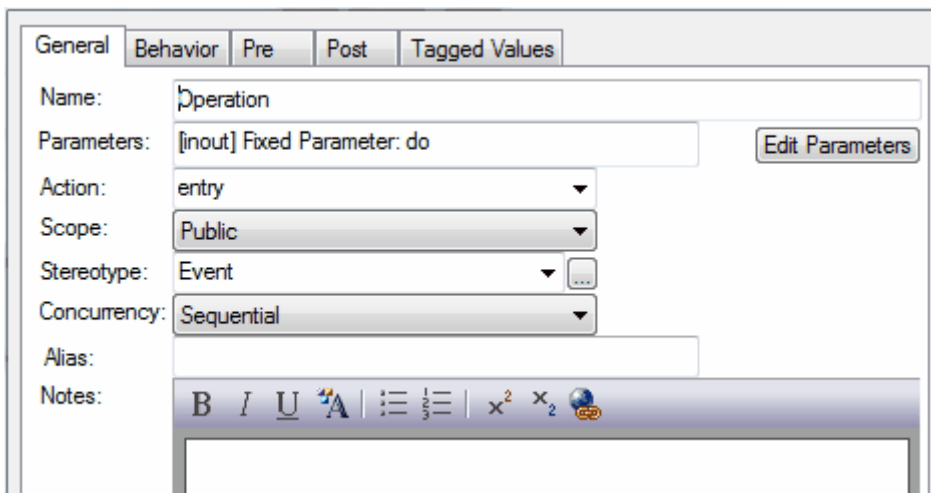
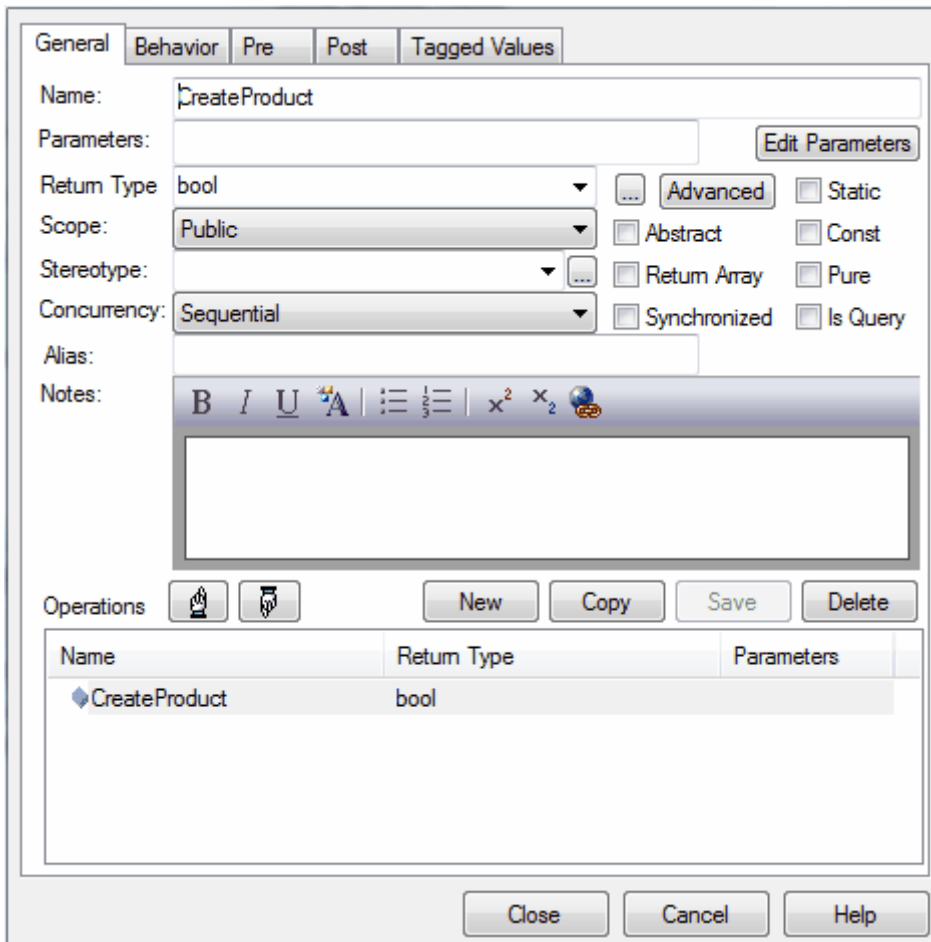

Field/Button	Use to
Name	Display the selected operation name.
Parameters	Display the parameter list. See <a href="#">Parameters Dialog</a> <sup>[583]</sup> for information regarding what this string can contain.
Edit Parameters	Open the <b>Parameters</b> dialog.

Field/Button	Use to
<b>Return Type</b>	<p>(Not shown for <i>State</i> or <i>State Machine</i> elements.)</p> <p>Display the data type returned by the operation.</p> <p>The type can be defined by the code language (data type) or by a classifier element. When you click on the drop-down arrow, the set of values in the list provides the appropriate data types.</p> <p>To select or define possible classifiers, either click on the <b>Select Type</b> option in the list, or click on the [ ... ] (Select) button to display the <a href="#">Select &lt;Item&gt;</a><sup>[515]</sup> dialog.</p> <p>To add new code language data types that can be displayed in this list, see the <a href="#">Data Types</a><sup>[666]</sup> topic.</p>
[ ... ] (Return Type Browse button)	<p>Open the <a href="#">Select &lt;Item&gt;</a><sup>[515]</sup> dialog to select the operation return type.</p> <p>(Not shown for <i>State</i> or <i>State Machine</i> elements.)</p>
<b>Action</b>	<p>Define the action of the operation: <b>do</b>, <b>exit</b> or <b>entry</b>.</p> <p>(For <a href="#">State</a><sup>[789]</sup> or <a href="#">State Machine</a><sup>[796]</sup> elements.)</p>
<b>Scope</b>	Select <b>Public/Protected/Private/Package</b> .
<b>Stereotype</b>	Specify an optional stereotype for this operation.
<b>Concurrency</b>	Set the concurrency of the operation.
<b>Alias</b>	Define an optional alias for the operation.
<b>Notes</b>	Enter free text notes. You can format this text if necessary, using the <a href="#">Notes toolbar</a> <sup>[642]</sup> at the top of the field.
<b>Virtual/Abstract</b>	<p>If the operation's language is set to C++, map to the C++ <i>Virtual</i> keyword. Otherwise this option is <i>Abstract</i>, pertaining to an abstract function.</p> <p>(Not shown for <i>State</i> or <i>State Machine</i> elements.)</p>
<b>Return Array</b>	<p>Indicate that the return value is an array.</p> <p>(Not shown for <i>State</i> or <i>State Machine</i> elements.)</p>
<b>Synchronized</b>	<p>Specify a code engineering flag that relates to multi threading in Java.</p> <p>(Not shown for <i>State</i> or <i>State Machine</i> elements.)</p>
<b>Static</b>	<p>Indicate that the operation is a static member.</p> <p>(Not shown for <i>State</i> or <i>State Machine</i> elements.)</p>
<b>Const</b>	<p>Indicate that the return type of this method is constant.</p> <p>(Not shown for <i>State</i> or <i>State Machine</i> elements.)</p>
<b>Pure</b>	<p>Indicate that C++ is pure virtual syntax - for example:</p> <pre>virtual void myFunction( ) = 0;</pre> <p>(Not shown for <i>State</i> or <i>State Machine</i> elements.)</p>
<b>IsQuery</b>	<p>Indicate that this method does not modify the object.</p> <p>(Not shown for <i>State</i> or <i>State Machine</i> elements.)</p>
<b>Operations</b>	List the defined operations.
<b>Up/Down Buttons</b>	Change the order of operations in the list.
<b>New</b>	Create a new operation.



Field/Button	Use to
Copy	Copy the currently selected operation.
Save	Save a new operation, or save modified details for existing operation.
Delete	Delete the currently selected operation.

**Note:**

- If you make changes and do not save them, the **Cancel** button prompts you to confirm or cancel the changes, whilst the **Close** button closes the dialog immediately and does not save the changes.
- If you are creating many operations, go to the [Attribute/Operations](#) page of the [Options](#) dialog ([Tools | Options | Source Code Engineering | Attribute/Operations](#)) and select the **After save, re-select edited item** checkbox. Now, when you create an operation and click on the **Save** button, the dialog fields clear ready for you to enter the details of the next operation. This helps you when you want to create operations quickly and might not necessarily want to fully define each one as you create it.

**4.6.7.1.1 Operations Dialog - Behavior**

This topic illustrates how to elaborate a method's function in a diagram.

The **Behavior** tab of the **Operations** dialog enables you to enter free text to describe the functionality of an operation. Use pseudo-code, structured English or just a brief description.

You can also use the **Behavior** tab to formally describe a method or State action and have the text appear under the method/action name in a diagram.

**State Operations - Behavior**

A State's *do*, *entry* and *exit* operations optionally refer to other behaviors such as Activities, Interactions or Operations. Use the [ ... ] (browse) button to invoke the [Select <Item>](#) dialog, and locate and select the required behavior.

**Show Behavior in a Diagram**

To show behavior in a diagram, follow the steps below:

1. Create or locate the required operation.
2. Click on the **Behavior** tab of the **Operations** dialog.

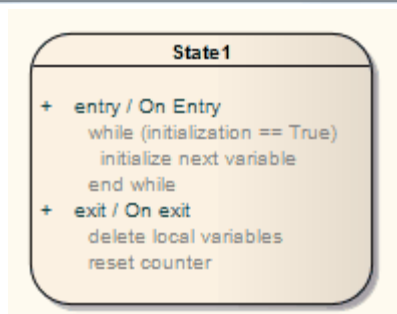
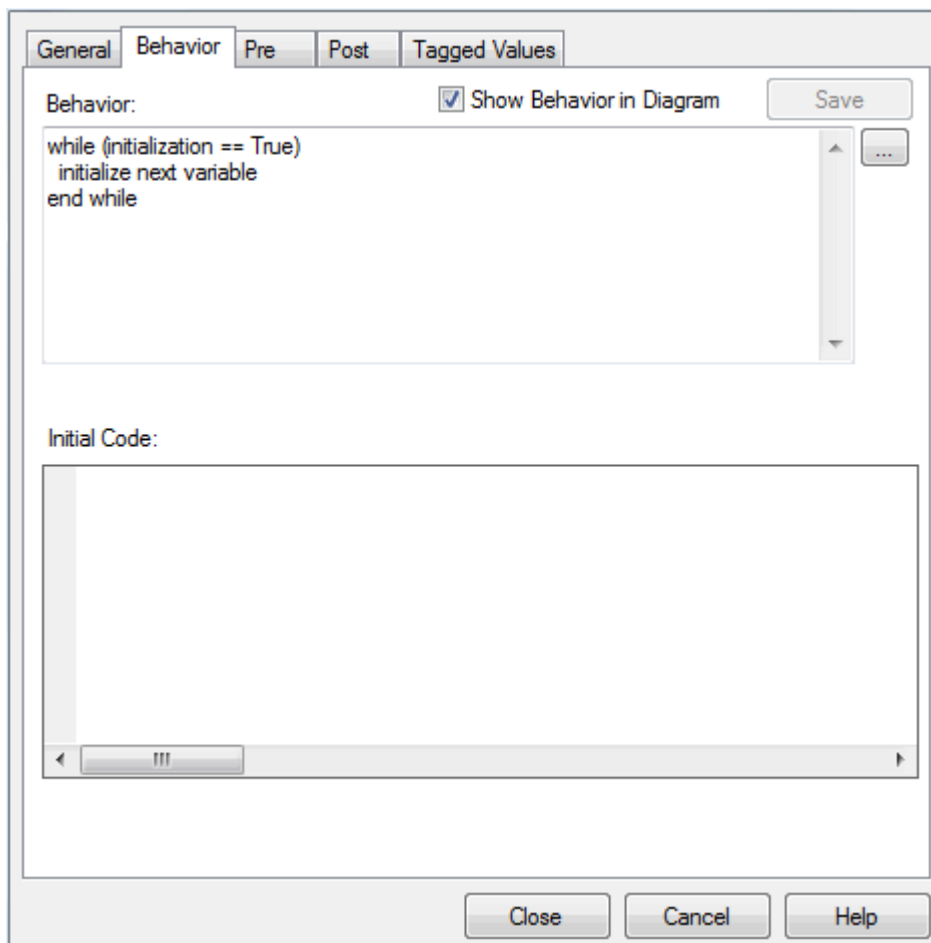

3. Select the **Show Behavior in Diagram** checkbox.
4. Click on the **Save** button.

### Associate With Behavior

A Class operation can be associated with a behavior elsewhere in the model. Display the operation's **Properties** dialog, select the **Behavior** tab, click on the [ ... ] (browse) button and select the required behavior from the **Select Element** <sup>[515]</sup> dialog. The behavior is set in the **Behavior** field, and the operation is then set as the specification of the associated behavior. For example:

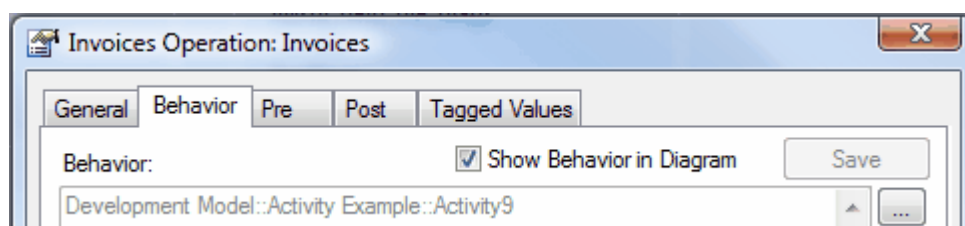

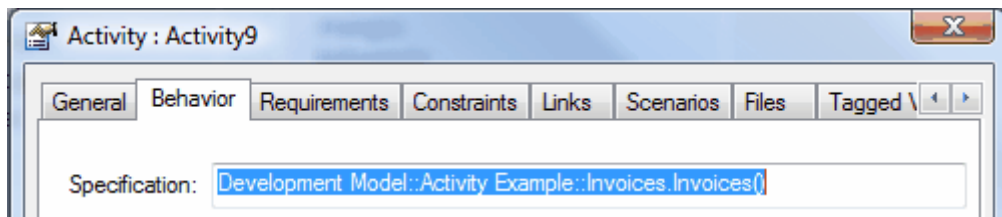

In behavioral code generation, the behavior of the associated behavioral element is generated as the *operation's* code. In the following illustration, *Op1* is associated with the Activity *Activity*.

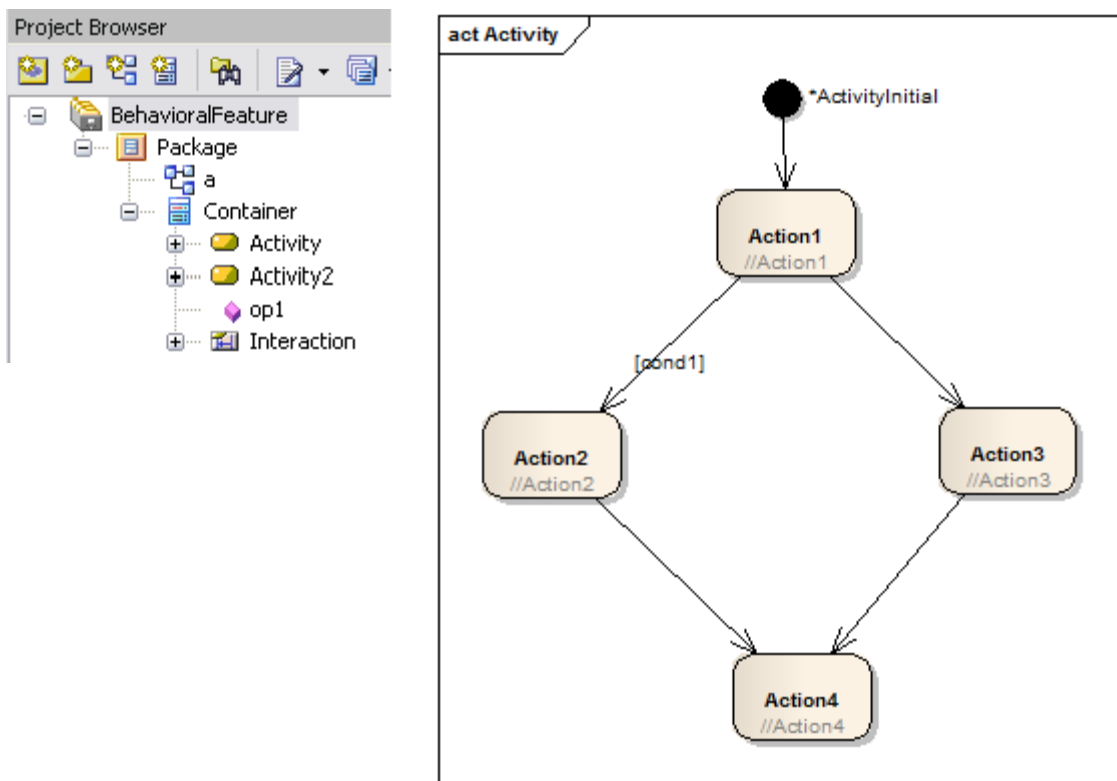

The generated code for Op1 is as follows:

```

package Package;
public class Container {
    public Container(){
    }

    public void finalize() throws Throwable {
    }

    public void op1(){
        /*Activity element(Activity1)'s behavior rendered as          operation(op1)'s code*/
        //Action1;
        if (cond1)
        {
            //Action2;
        }
        else
        {
            //Action3;
        }
        //Action4;
    }
}
    
```

```
/*Activity element(Activity1)not rendered*/
public void Activity2()
{
    // behavior is a Activity
}

public void Interaction()
{
    // behavior is a Interaction
}
}
} //end Container
```

### See Also

- [Initial Code](#) <sup>[576]</sup>

On the **Behavior** tab of the **Operations** dialog, you can use the **Initial Code** field to enter code to be inserted into an operation body when the operation is first generated to file. After this point, forward code generation and synchronization do not replace the existing operation code with the **Initial Code** field.

By default, the **Initial Code** field also is not imported into the model during reverse engineering, but you can select to import the field by selecting the **Include method bodies in model when reverse engineering** checkbox on the **Options** <sup>[1341]</sup> dialog.

This field is most useful when combined with [UML Patterns](#) <sup>[901]</sup>. Elements within a pattern often require the same stub code. Notice that the language specific patterns available from [www.sparxsystems.com/resources/developers/uml\\_patterns.html](http://www.sparxsystems.com/resources/developers/uml_patterns.html) include initial code for some of the defined operations. This helps speed up the process of applying patterns from model to implementation. The **Initial Code** section is also useful for ensuring that the generated code is directly compilable.

This example shows the contents of the **Initial Code** field for the *Instance()* operation of the *Singleton* element in the C# Singleton pattern:

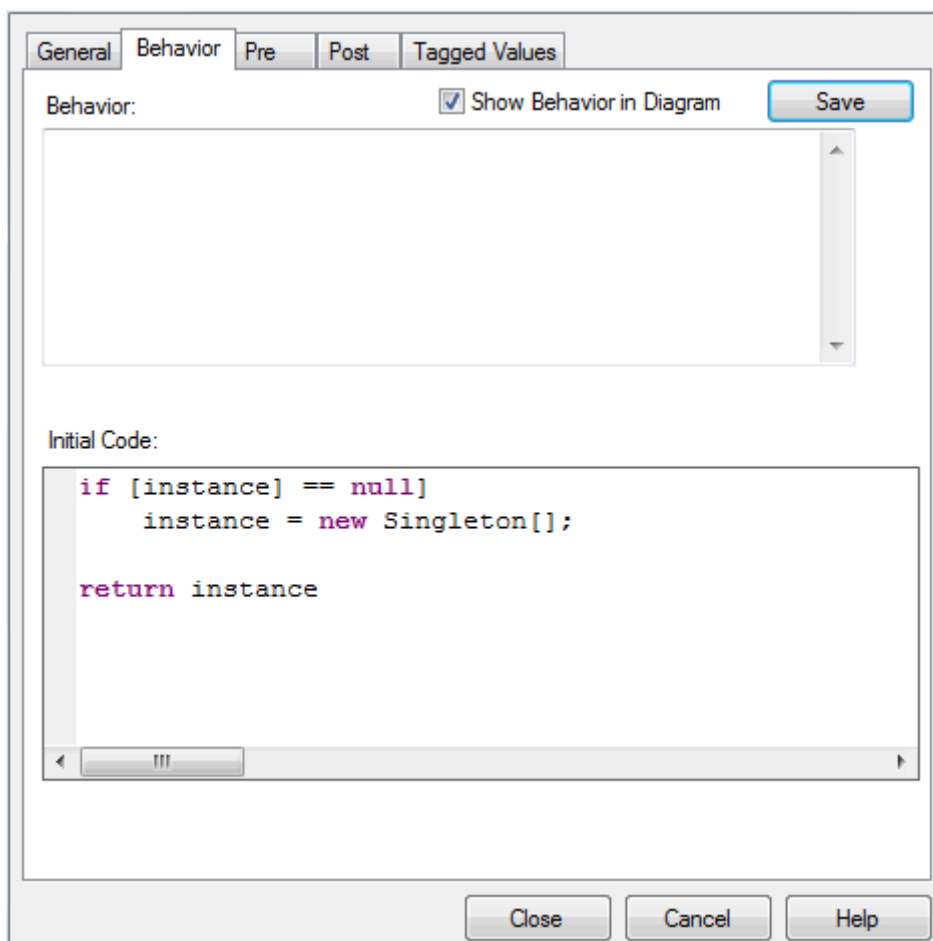

#### 4.6.7.1.1.2 Operations Dialog - Constraints

Operations can have pre- and post- conditions defined. For each type, give the condition a name, a type and enter notes.

Constraints define the contractual behavior of an operation, what must be true before they are called and what is true after. In this respect they are related to the state model of a Class and can also relate to the guard conditions that apply to a transition.

The screenshot shows a dialog box with the following components:

- Tabbed interface with tabs: General, Behavior, **Pre**, Post, Tagged Values.
- Input fields: "PreCondition:" (text box) and "Type:" (dropdown menu).
- A large text area for entering notes.
- Buttons: "New", "Save", "Delete" (located below the text area).
- Table: "Defined Preconditions" with columns "Pre-Condition" and "Type".
- Bottom buttons: "Close", "Cancel", "Help".

#### 4.6.7.1.2 Operation Tagged Values

Operations can have Tagged Values associated with them. Tagged Values offer a convenient extension mechanism for UML elements, so you can define any tags you like and then assign values to them using this form.

Tagged Values are written to the XMI output, and can be input to other third party tools for code generation or other activities.

##### Tip:

Tagged Values are supported for attributes, operations, objects and connectors.

#### Add a Tagged Value

To add a Tagged Value for an operation, follow the steps below:

1. Click on the **Tagged Values** tab of the operation **Properties** dialog.

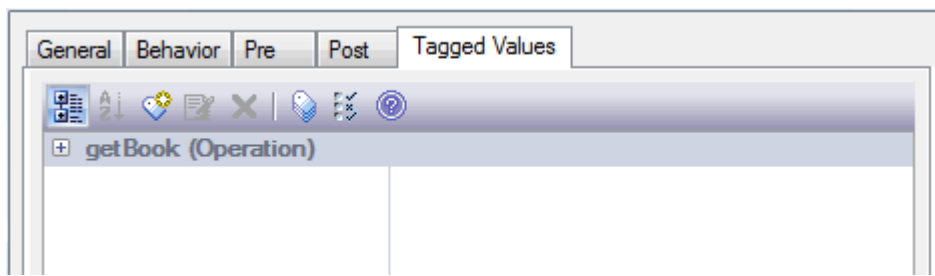

2. Click on the **New Tags** button. The **Tagged Value** dialog displays.

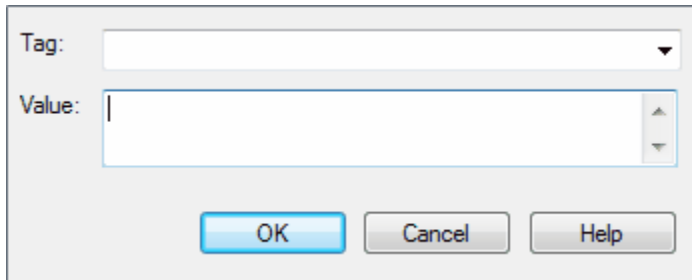

3. In the **Tag** field, type the tag name (or select a defined tag from the drop-down list), then in the **Value** field type the initial tag value.
4. Click on the **OK** button to confirm the operation.

**Note:**

You can define custom tags using a predefined Tagged Value Type. For more information see [Create a Custom Tagged Value](#).

#### 4.6.7.1.3 Override Parent Operations

In Enterprise Architect, you can automatically override methods from parent Classes and from realized Interfaces.

Select a Class that has a parent or realized interface and select the **Element | Advanced | Overrides & Implementations** menu option.

In the **Override Operations/Interfaces** dialog, check the operations/interfaces to automatically override and click on the **OK** button. Enterprise Architect generates the equivalent function definitions in your child Class.

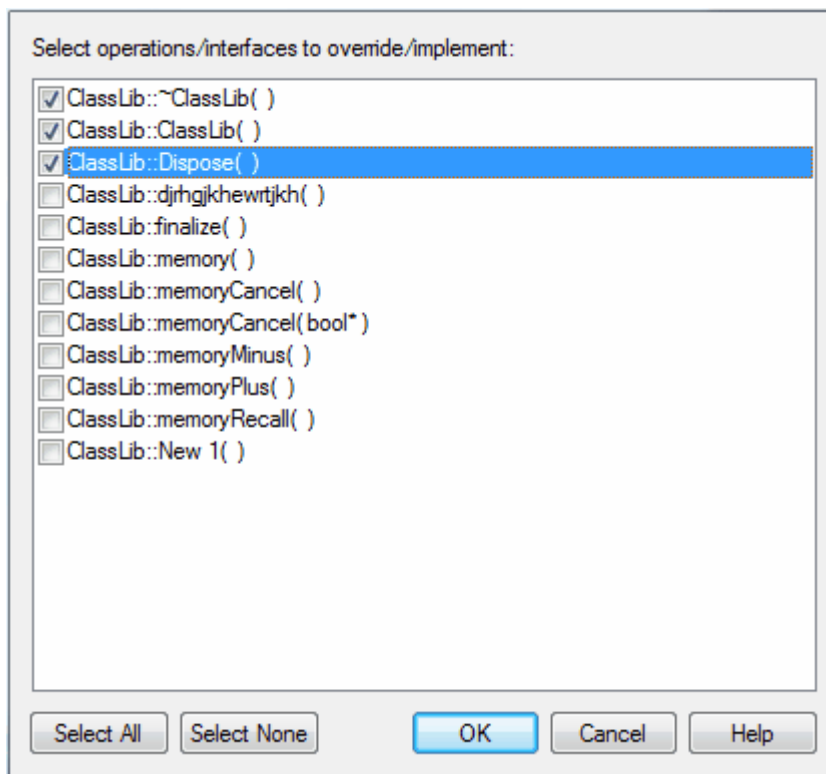

You can configure Enterprise Architect to display this dialog each time you add a Generalization or Realization connector between Classes, and review their possible operations/interfaces to override/implement. Do this from the **Links** page of the **Options** dialog (select the **Tools | Options | Links** menu option).

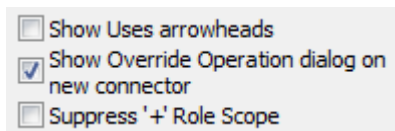

#### 4.6.7.1.4 Display Inherited Operations

You can configure an element in a diagram to display the complete operation set obtained from all ancestors in the element's type hierarchy, as well as those directly owned. To do this, use the **Element | Feature Visibility** <sup>[438]</sup> function from the main menu, or press **[Ctrl]+[Shift]+[Y]**.

The following diagram illustrates this behavior when enabled for each element in a simple hierarchy.

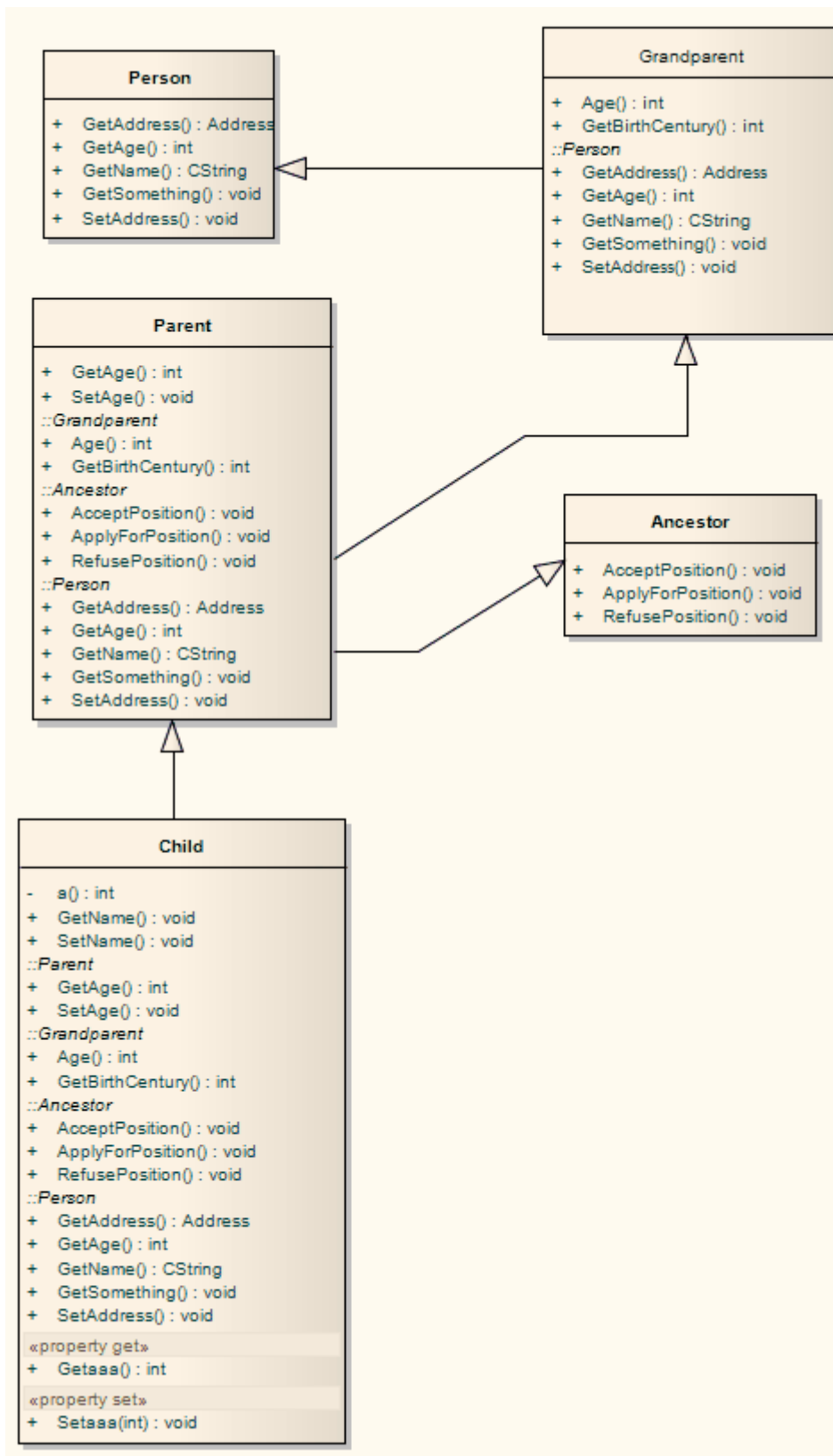



### 4.6.7.2 Interactions and Activities

The behavioral aspects of Interactions and Activities are modeled using the **Behavior** tab of the element **Properties** dialog, which enables you to assign parameters and return types to the elements.

Use the **Edit Parameters** button to [edit an element's parameters](#)<sup>[583]</sup>. When you create a new parameter using the dialog, it internally creates an [Activity Parameter Node](#)<sup>[755]</sup> for an Activity or an *Interaction Parameter* for an Interaction. In the **Return** field, click on the drop-down arrow and select the return type of the element.

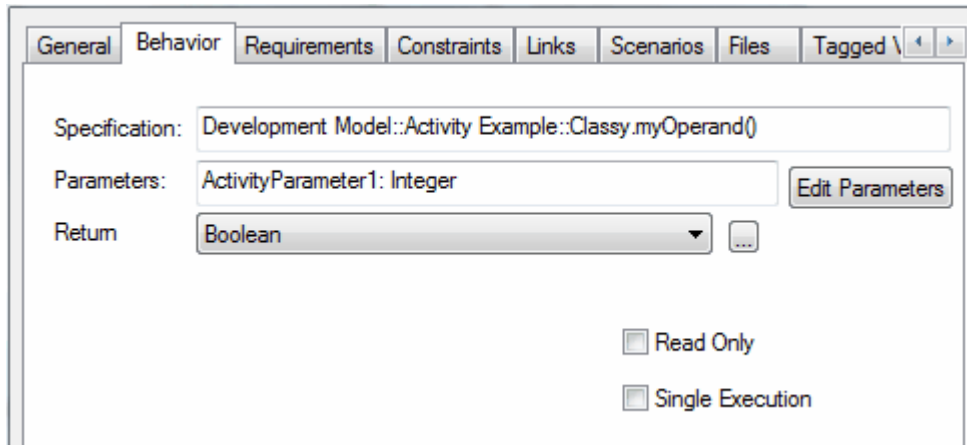

The specification field is populated automatically when an operation is [associated with the activity as a behavior](#)<sup>[573]</sup>.

### 4.6.7.3 Behavior Calls

A behavior call is the invocation of a behavior. You can represent an invocation with a [Call Operation Action \(Operation\)](#), [Call Behavior Action \(Activity\)](#)<sup>[745]</sup> or [Interaction Occurrence \(Interaction\)](#)<sup>[780]</sup> element. You model the properties of the behavior call using the **Call** tab of the element **Properties** dialog, on which you:

- Edit [Arguments](#)<sup>[582]</sup>
- [Re-associate the call with a different behavior](#)<sup>[582]</sup>
- [Synchronize the arguments](#)<sup>[582]</sup> with the parameters in the associated behavior.

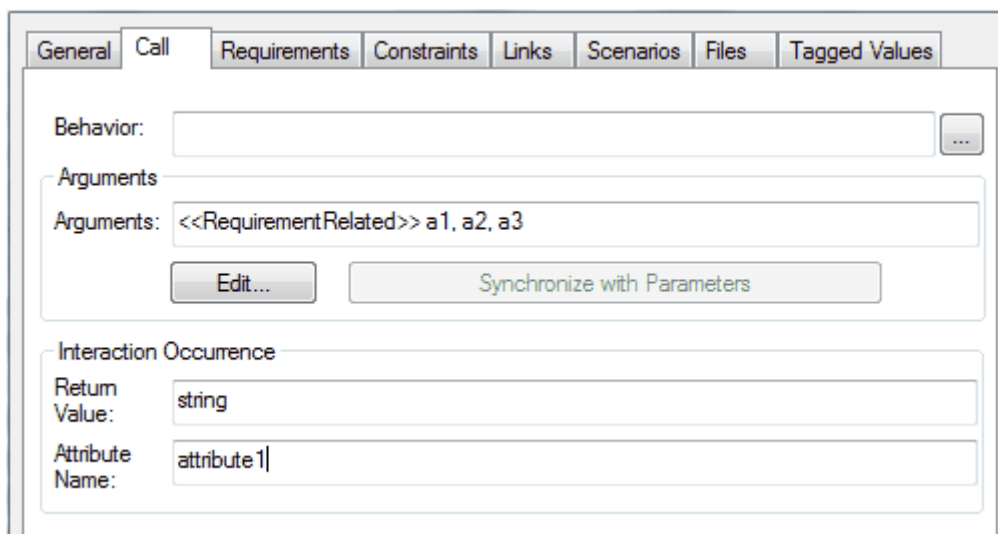

Click on the **Edit** button to create and delete arguments, and relate them to a corresponding parameter in the associated behavior.

Click on the [ ... ] (**Select Behavior**) button to re-associate the invocation with a different behavior or to

remove any association with the current behavior.

The **Interaction Occurrence** panel is displayed only for Interaction Occurrence elements. It enables you to enter the return value and attribute of the behavior call.

#### 4.6.7.3.1 Associate with Different Behaviors

On the **Call** tab of the Behavior Call **Properties** dialog, when you click on the [ ... ] (**Select Behavior**) button the **Select <Item>** <sup>[515]</sup> dialog displays, listing all available behaviors in the model.

Select **<none>** to remove any existing association between an invocation and a behavior, or select another classifier to re-associate the invocation with a different behavior.

The **Synchronize with Parameters** button is enabled only if a valid behavior is identified in the **Behavior** field.

#### 4.6.7.3.2 Synchronize Arguments

On the **Call** tab of the element **Properties** dialog, click on the **Synchronize with Parameters** button to synchronize the number of arguments in the invocation element with the number of parameters in the associated behavior. This automatically creates or deletes arguments based on the number of parameters in the behavior. If any arguments are to be deleted, Enterprise Architect prompts you to confirm the operation. Click on the **Yes** button to confirm.

##### Note:

The **Synchronize with Parameters** button is enabled only if the invocation is associated with a valid behavior, as identified in the **Behavior** field.

#### 4.6.7.4 Behavior Call Arguments

You define the arguments of a **Behavior Call** <sup>[581]</sup> using the **Arguments** dialog, which you display by clicking on the **Edit** button on the **Call** tab of the element **Properties** dialog.

Name	Parameter	Type	Value
Dynamic Vie...	param2		
Dynamic Vie...	param1		

1. In the **Name** field, type the name of an argument to map to the behavior.
2. In the **Parameters** field, click on the drop-down arrow and select a behaviors parameter from the list of parameters associated with the behavior.
3. In the **Value** field, set any required value.
4. If a diagram is displayed, and if required, select the **Show in current diagram** checkbox to add an [Action Pin](#)<sup>[749]</sup> on the diagram.
5. Click on the **Save** button.
6. If appropriate, click on the **New** button and repeat steps 1 to 5 for another argument:parameter mapping.

If you attempt to map a newly created argument to a parameter that is already associated with a different argument, Enterprise Architect identifies the mapping and prompts you to confirm that you intend to change the association.

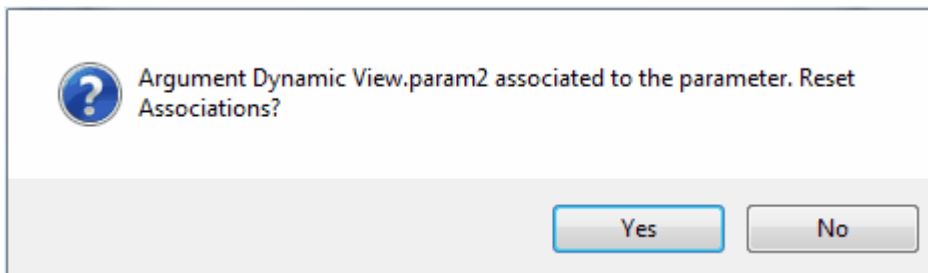

#### 4.6.7.5 Behavior Parameters

This topic area describes the facilities for defining, editing and extending the parameters of behavioral operations, Activities and Interactions. See:

- [Parameters Dialog](#)<sup>[583]</sup>
- [Parameter Tagged Values](#)<sup>[585]</sup>
- [Operation Parameters By Reference](#)<sup>[586]</sup>

##### 4.6.7.5.1 Parameters Dialog

The **Parameters** dialog enables you to define the parameters of an operation, Activity or Interaction. The parameter list is reproduced in code in the order the parameters appear in the parameters list, so use the **Up** and **Down** buttons to move parameters into their required positions. Additionally, you can select the **Add new to end** checkbox to force new parameters to appear at the end of the list instead of the top.

#### Tip:

Set the amount of parameter detail to display in a specific diagram using the [Show Parameter Detail](#)<sup>[429]</sup> drop-down list on the **Diagram Properties** dialog. The setting applies only to the current diagram. The default is to show the type only.

The screenshot shows a dialog box for configuring a parameter. At the top, there are fields for Name (param3), Type (Activity1), and Default. Below these are Stereotype, Kind (in), Fixed, Alias, and Add new to end. A Multiplicity... button is also present. Below the fields is a list of parameters with columns for Name, Type, and Default. The list contains param3 (Activity1) and param2 (Activity1).

Name	Type	Default
param3	Activity1	
param2	Activity1	

Option	Use to
<b>Name</b>	Type the parameter name.
<b>Type</b>	Select the data type of the parameter. Alternatively, click on the [ ... ] button and select the element classifier to define the type.
<b>Default</b>	Type an optional default value for the parameter.
<b>Stereotype</b>	Type a stereotype name, or click on the drop-down arrow and select a stereotype for the parameter.
<b>Kind</b>	Indicate the way a parameter is passed to a function: <ul style="list-style-type: none"> <li>• <b>In</b> = By Value</li> <li>• <b>InOut</b> = By Reference</li> <li>• <b>Out</b> is passed by Reference, but only the return value is significant.</li> </ul>
<b>Fixed</b>	Set the parameter to <i>const</i> , even if passed by reference.
<b>Alias</b>	Type an optional alias for the parameter.
<b>Add new to end</b>	Place new parameters at the end of the list instead of the start.
<b>Multiplicity</b>	Display the <b>Multiplicity</b> dialog, to specify the multiplicity of the parameters.
<b>Notes</b>	Type any additional notes on the parameter.

## Multiplicity Dialog

Field	Use to
Lower bound	Define a lower limit to the number of elements allowed in the collection.
Upper bound	Define an upper limit to the number of elements allowed in the collection.
Allow Duplicates	Indicate that duplicates are allowed. Maps to the UML property <i>isUnique</i> , value <i>FALSE</i> ).
Multiplicity is Ordered	Indicate that the collection is ordered.

### See Also

- [Parameter Tagged Values](#)<sup>[585]</sup>
- [Operation Parameters by Reference](#)<sup>[586]</sup>

### 4.6.7.5.2 Parameter Tagged Values

Behavioral parameters can have Tagged Values associated with them. Tagged Values offer a convenient extension mechanism for UML elements; you can define any tags you like and then assign values to them using this form.

Tagged Values are written to the XMI output, and can be input to other third party tools for code generation or other activities.

#### Tip:

Tagged Values are supported for attributes, operations, objects and connectors.

## Add a Tagged Value

To add a Tagged Value for a parameter, follow the steps below:

1. Double-click on the operation, Activity or Interaction containing the parameter in a diagram or in the **Project Browser**. The **Properties** dialog displays.
2. Click on the **Tagged Values** tab, which shows the Tagged Values for the selected object and its parameters.
3. Click on the required parameter in the **Parameters** compartment of the **Tagged Values** tab, and click on the **New Tags** button. The **Tagged Value** dialog displays.

4. In the **Tag** field, type the tag name (or select a defined tag from the drop-down list), then in the **Value** field type the initial tag value .
5. Click on the **OK** button to confirm the Tagged Value.

#### Tip:

Custom tags can be created using a predefined Tagged Value Type. For more information see [Create a Custom Tagged Value](#)<sup>[117]</sup>.

#### 4.6.7.5.3 Operation Parameters by Reference

##### Note:

This facility currently applies to operations only.

You can select to highlight parameters declared as 'Kind: *inout*' or 'Kind: *out*' with an additional user-defined prefix or suffix. On the [Objects](#) <sup>[362]</sup> page of the **Options** dialog (select the **Tools | Options | Objects** menu option), the **Feature reference indicator** panel enables you to set whether references are highlighted or not.

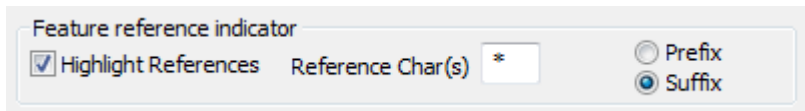

If you select the **Highlight References** checkbox, you can also indicate whether a prefix or suffix should be used, and the actual reference character to use. In the example above, the **&** character has been set as a prefix.

When you declare a parameter of type *inout*, it is assumed you are passing the parameter by reference rather than by value. If you have elected to highlight references, then this is displayed in the **Diagram View**.

The example below shows that, in the *getName* operation, the parameter *strName* is a *string* reference, and is highlighted using the chosen character and position.

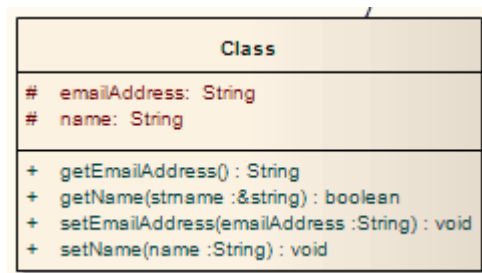

### 4.6.8 In-place Editing Options

This topic explores the tasks that can be performed using in-place editing of elements on a diagram in Enterprise Architect. The tasks include:

- [View Properties](#) <sup>[587]</sup>
- [Edit Element Item Name](#) <sup>[588]</sup>
- [Edit Feature Stereotype](#) <sup>[588]</sup>
- [Edit Feature Scope](#) <sup>[589]</sup>
- [Edit Attribute Keyword](#) <sup>[590]</sup>
- [Edit Operation Parameter Keyword](#) <sup>[591]</sup>
- [Insert Operation Parameter](#) <sup>[593]</sup>
- [Edit Parameter Kind](#) <sup>[592]</sup>
- [Insert New Feature](#) <sup>[592]</sup> (Attribute or Operation)
- [Insert Maintenance Feature](#) <sup>[594]</sup>
- [Insert Testing Features](#) <sup>[595]</sup>
- [Delete Selected from Model](#) <sup>[587]</sup>

#### 4.6.8.1 In-place Editing Tasks

To use the options that are available through the in-place editing menu, follow the steps below:

1. Open the diagram containing the element.
2. Click on the element, and on the item to manipulate within the element. The item line is highlighted in a lighter shade (the default is white), to indicate that it has been selected.



3. Edit and manipulate the items in the element, either by pressing the appropriate keyboard keys or by right-clicking on the highlighted item and choosing a task from the **Element Items** context menu. The following commands are available:

To...	Select menu option...	Or press...
Change the name, scope or stereotype of the element or element item	<b>Edit Selected</b>	[F2]
Display the dialog containing details of the element	<b>View Properties</b>	[Enter]
Insert a new item in the element	<b>Insert New After Selected</b>	[Insert]
Locate the item in the <b>Project Browser</b>	<b>Find in Project Browser</b>	
Add an attribute to the element	<b>Add Attribute</b>	[Ctrl]+[Shift]+[F9]
Add an operation to the element	<b>Add Operation</b>	[Ctrl]+[Shift]+[F10]
Insert a feature on the specific element item, such as Maintenance features and Testing features	<b>Add Other</b>	[Ctrl]+[F11]
Delete the selected item from the model	<b>Delete Selected from Model</b>	[Delete]
Display the source code for the element.	<b>View Source code</b>	[F12]
Set a breakpoint on a highlighted operation (including a <a href="#">breakpoint</a> , <a href="#">start recording marker</a> , <a href="#">end recording marker</a> or <a href="#">stack auto-capture marker</a> )	<b>Set Breakpoint</b>	
Navigate Diagram Selection, to navigate the diagram between elements without having to use the mouse		[Ctrl]+[Shift]+[arrow key]
Toggle element highlight option on and off		[Shift]+[Enter]

Other options that are available while editing element attributes or operations in a diagram include:

To...	Press...
Accept current changes	[Enter]
Accept current changes and open a new slot to add a new item	[Ctrl]+[Enter]
Abort the edit, without save	[Esc]
Display the context menu for in-place editing	[Shift]+[F10]

To...	Press...
Invoke the <i>Select &lt;Item&gt;</i> dialog	[Ctrl]+[Shift]+[Space]

**Note:**

Most of the in-place editing menu commands have keyboard alternatives. For many of them, if the selected item happens to be off-screen when you press the appropriate keys, the diagram automatically scrolls to show the whole element, so that you can see what you are changing.

#### 4.6.8.2 Edit Element Item Name

The in-place editing feature enables you to change the name of the element, or the name of an operation or attribute, directly from the diagram. To use this feature follow the steps below:

1. Open the diagram containing the element.
2. Click on the element and on the name to change within the element. The item line is highlighted in a lighter shade (the default is white), to indicate that it has been selected.

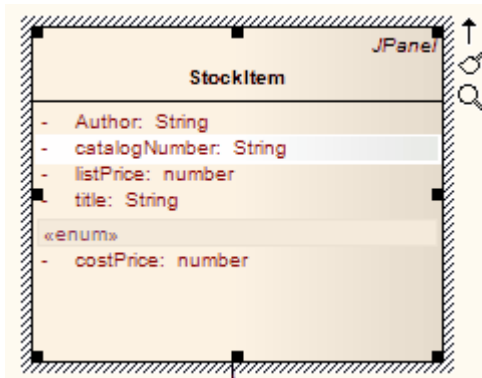

3. Right-click on the item. The context menu displays.
4. Select the **Edit Selected** menu option (or press **[F2]**) to enable you to edit the item directly from the diagram. The name of the attribute or operation is highlighted.

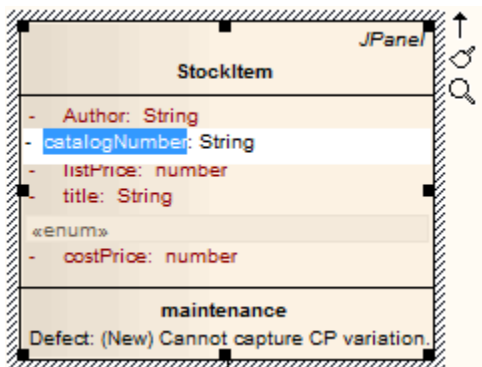

5. Delete or type over the name.
6. Press **[Enter]** to accept the change, or **[Esc]** to cancel the change.

#### 4.6.8.3 Edit Feature Stereotype

You can use the in-place editing feature to change the *stereotype* of an operation or attribute directly from the diagram. To use this feature, follow the steps below:

1. Open the diagram containing the element.
2. Click on the element, and on the item to edit within the element. The item line is highlighted in a lighter shade (the default is white), to indicate that it has been selected.



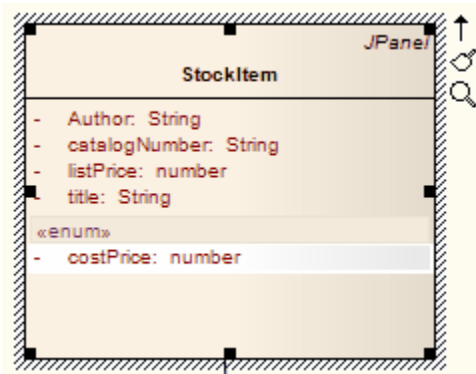

3. Right-click on the item. The context menu displays.
4. Select the **Edit Selected** menu option (or press **[F2]**) to enable you to edit the attribute or operation directly from the diagram. The name of the item is highlighted.
5. Move the cursor to the position before the name or within the existing attribute or operation stereotype (denoted by «stereotype name»).

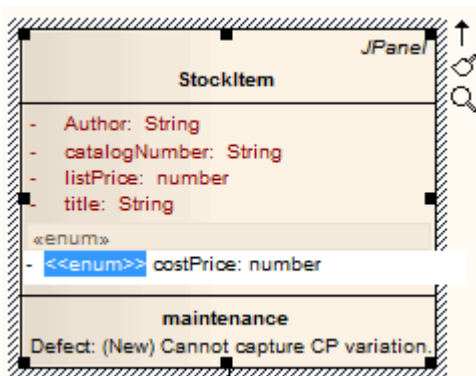

6. Delete or type over the previous name to change the stereotype name of the attribute or operation.
  7. Press **[Enter]** to accept the change or **[Esc]** to cancel the change.
- You can assign multiple stereotypes by including a comma-separated list inside the stereotype markers.

#### 4.6.8.4 Edit Feature Scope

The in-place editing feature enables you to rapidly change the scope of an attribute or operation directly from the diagram. To use this feature follow the steps below:

1. Open the diagram containing the element.
2. Click on the element and on the item to edit within the element. The item line is highlighted in a lighter shade (the default is white), to indicate that it has been selected.

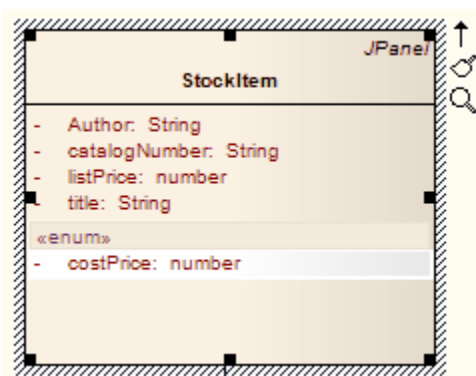

3. Right-click on the item. The context menu displays.

4. Select the **Edit Selected** menu option (or press **[F2]**) to enable you to edit the attribute or operation directly from the diagram. The name of the item is highlighted.
5. Move the cursor to the scope of the item and delete the previous entry.

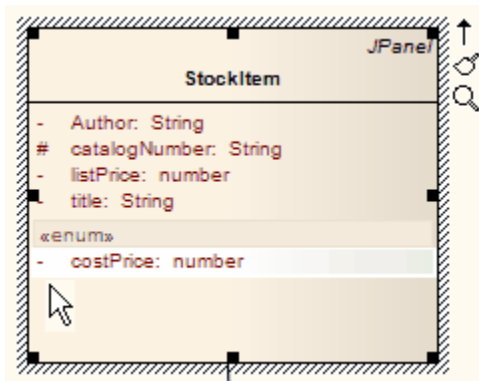

6. Reassign the entry by typing in one of the following symbols:
  - + indicates that the scope is Public
  - - indicates that the scope is Private
  - ~ indicates that the scope is Package
  - # indicates that the scope is Protected.
7. Press **[Enter]** to save the change, or **[Esc]** to cancel the change. The diagram is updated to reflect the changes. (Also see the *catalogNumber* attribute in the above screen illustrations.)

#### 4.6.8.5 Edit Attribute Keyword

You can add features such as attribute keywords and classifiers directly to an element, using the **Element Keywords and Classifiers** menu. This enables you to rapidly assign details element item by element item, directly from a diagram. To use this feature, follow the steps below:

1. In Enterprise Architect, open the diagram containing the element.
2. Click on the element, and on the attribute to edit within the element. The item line is highlighted in a lighter shade (the default is white), to indicate that it has been selected.

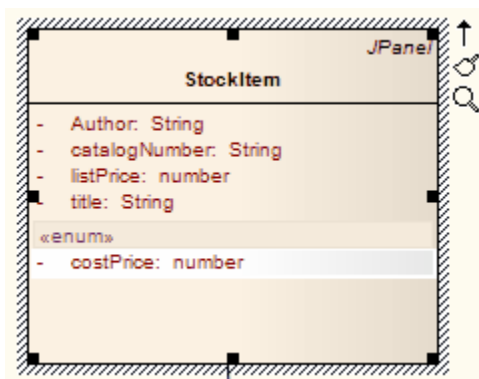

3. Right-click on the item. The context menu displays.
4. Select the **Edit Selected** menu option (or press **[F2]**) to enable you to edit the attribute directly from the diagram. The name of the attribute is highlighted.
5. Right-click on the attribute name to display the context menu.

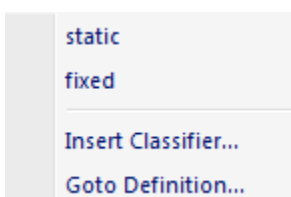

6. From the context menu, you can:

- Change the attribute classifier to static or fixed - select the **static** or **fixed** menu options as appropriate; the diagram is updated to reflect the changes.
- Display the Class properties - click on the **Goto Definition** menu option; Enterprise Architect locates the Class in the **Project Browser** and opens its [Properties](#) <sup>[48]</sup> dialog.

If the data type is a raw data type, Enterprise Architect displays the message: *The data type is a raw data type.*

#### 4.6.8.6 Edit Operation Parameter Keyword

You can directly edit operation classifiers by element, using the in-place editing menu. This enables you to rapidly assign parameter keywords. To use this feature, follow the steps below:

1. Open the diagram containing the element.
2. Click on the element, and on the operation to edit within the element. The item line is highlighted in a lighter shade (the default is white), to indicate that it has been selected.

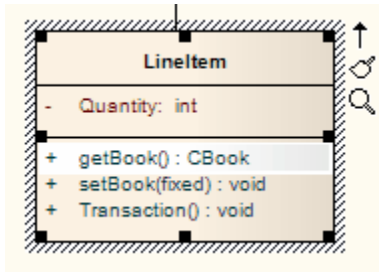

3. Right-click on the item. The context menu displays.
4. Select the **Edit Selected** menu option (or press **[F2]**) to enable you to edit the operation directly from the diagram. The name of the operation is highlighted.
5. Right-click on the data type of a parameter to display the context menu.

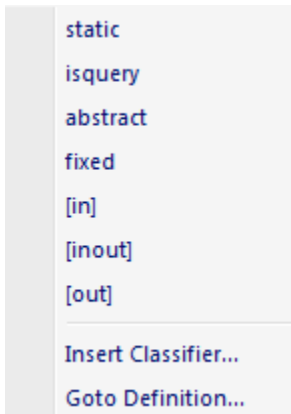

6. From the context menu you can:

- Change the operation classifier by clicking on the appropriate menu option - **static**, **isquery**, **abstract** or **fixed**. The diagram is updated to reflect the changes.
- Display the Class properties - click on the **Goto Definition** menu option.

If the data type is Class, Enterprise Architect locates the Class in the **Project Browser** and opens its [Properties](#) <sup>[48]</sup> dialog.

If the data type is a raw data type, Enterprise Architect displays the message *This data type is a raw data type.*

If the data type is not defined in the model, the message is: *The data type is not defined in the model.*

#### 4.6.8.7 Edit Parameter Kind

You can edit operation parameter kinds such as *[in]*, *[inout]* and *[out]* directly from a diagram element by element, using the **Element Keywords and Classifiers** menu. This enables you to rapidly assign the parameter directly from a diagram. To use this feature follow the steps below:

1. In Enterprise Architect, open the diagram containing the element.
2. Click on the element, and on the operation to edit within the element. The item line is highlighted in a lighter shade (the default is white), to indicate that it has been selected.

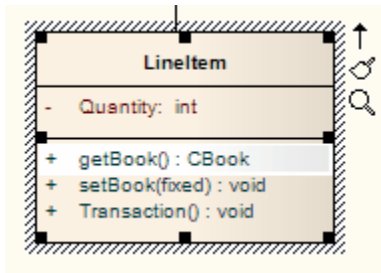

3. Right-click on the item. The context menu displays.
4. Select the **Edit Selected** menu option (or press **[F2]**) to enable you to edit the item directly from the diagram. The name of the item is highlighted.
5. Right-click on the item name to display the context menu.

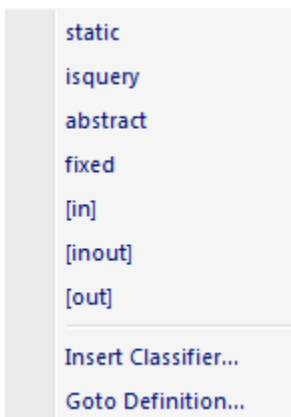

6. Select the appropriate menu option for the parameter kind value: **[in]**, **[inout]** and **[out]**. The diagram is updated to reflect the change.

#### 4.6.8.8 Insert New Feature

You can add attributes and operations to an element using the in-place editing options. To add attributes and operations to a Class diagram element, follow the steps below:

1. Open the diagram containing the element to which you are adding an attribute or operation.
2. Click on the element and, within the element, on the item after which to insert the operation or attribute. The item line is highlighted in a lighter shade (the default is white), to indicate that it has been selected.



3. Press **[Insert]**. Alternatively, right-click on the selected element item to display the context menu and select the **Insert New After Selected** menu option. Enterprise Architect inserts a new data line in the diagram, underneath the selected item.
4. Type in the relevant information for the attribute or operation.
5. Press **[Enter]** to accept the change or **[Esc]** to cancel the change. The diagram is updated to reflect the changes.

#### 4.6.8.9 Insert Operation Parameter

You can add operation parameters to an operation through the in-place editing options, using hotkey commands or menu shortcuts. To add parameters to operations in a Class diagram element, follow the steps below:

1. Open the diagram containing the element.
2. Click on the element, and on the operation to update within the element. The item line is highlighted in a lighter shade (the default is white), to indicate that it has been selected.

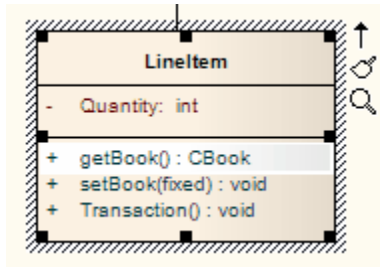

3. Press **[F2]**, or right-click on the selected item to display the context menu and select the **Edit Selected** option.
4. Move the cursor inside the parameter brackets and type the parameter name followed by a colon (for example, `bks:` for a vector containing books).
5. Give the parameter a type. Place the cursor after the colon at the end of the name and right-click the mouse to display the inline editing options context menu; select the **Insert Classifier** option.

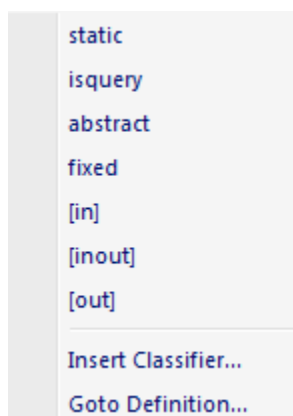

The [Select <Item>](#) <sup>[515]</sup> dialog displays. Select the required classifier.

- Press **[Enter]** to accept the change or **[Esc]** to cancel the change. The diagram is updated to reflect the changes.

#### 4.6.8.10 Insert Maintenance Feature

You can rapidly assign maintenance details such as Defects, Changes, Issues and Tasks directly to an element from a diagram, using the **Element Items** menu. To use this feature follow the steps below:

- Open the diagram containing the element.
- Click on the element name. The name is highlighted in a lighter shade (the default is white), to indicate that it has been selected.

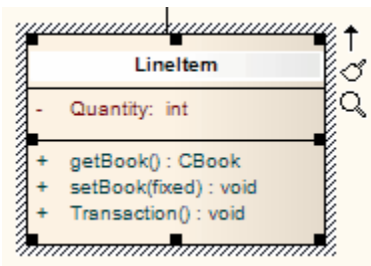

- Either:
  - Press **[Ctrl]+[F11]** or
  - Right-click on the highlighted name to display the context menu, and select the **Add Other** option.

The **Insert Feature** dialog displays.

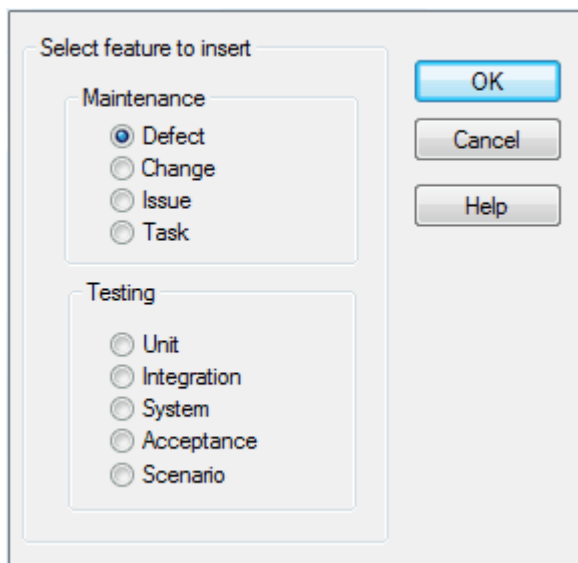

- Click on the appropriate radio button option to associate the required maintenance feature with the element item.
- Click on the **OK** button. The **<Maintenance Feature> details for <element>** dialog displays.

Name:  Auto

Requested:  Date: 19/11/2009  Status: New

Implemented by:  Date: 19/11/2009  Priority: Low

Version:

Description History

**B I U A** | |  $x^2$   $x_2$

6. Complete the fields to define the maintenance activity, and then click on the **Apply** button. To create a subsequent maintenance activity of this type, click on the **New** button.
7. When you have defined all of the maintenance activities of this type, click on the **OK** button. The maintenance details are added to the element.

To ensure that the maintenance items are visible in the diagram element, as shown in the example below, select the **Maintenance** checkbox on the **Elements** tab of the **Diagram Properties** dialog. For more information on diagram appearance options, see the [Show Maintenance Script in Diagram](#) <sup>[156]</sup> topic.

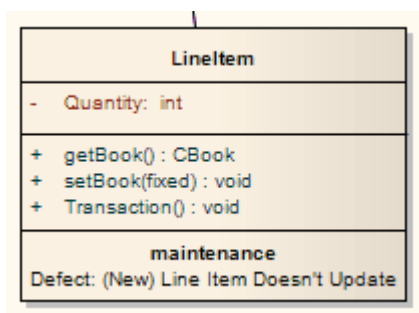

#### 4.6.8.11 Insert Testing Features

You can rapidly add testing features such as Unit, Integration, System, Acceptance and Scenario tests to an element directly from a diagram, using the **Element Items** menu. To use this feature follow the steps below:

1. Open the diagram containing the element.
2. Click on the element. The element name is highlighted in a lighter shade (the default is white), to indicate that it has been selected.

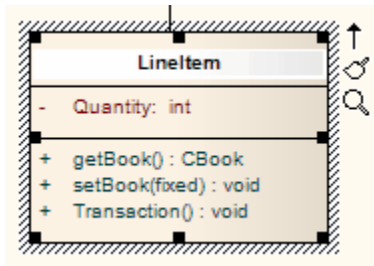

3. Either:

- Press **[Ctrl]+[F11]** or
- Right-click on the highlighted name to display the context menu and select the **Add Other** option.

The **Insert Feature** dialog displays.

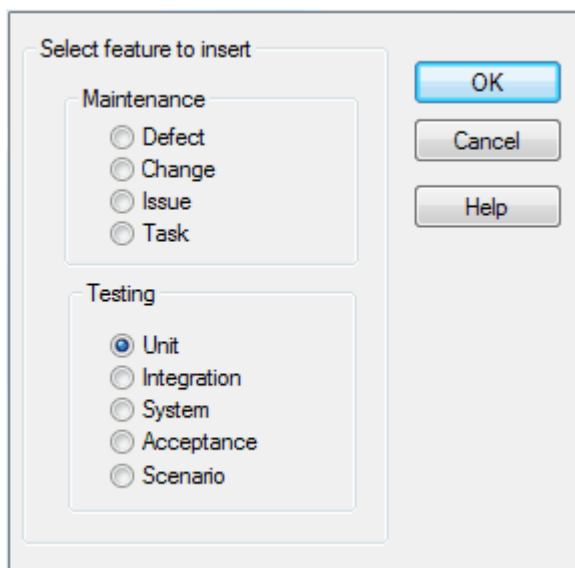

4. Click on the appropriate radio button option to associate the required testing feature with the element.
5. Click on the **OK** button. The **Testing** window opens, showing the appropriate panel for the type of test selected.

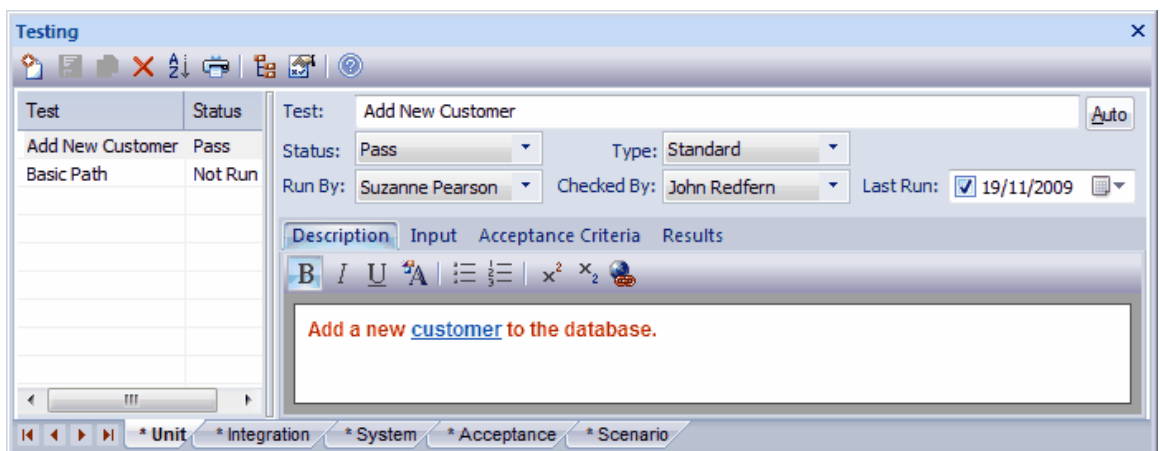

6. [Complete the fields](#) <sup>(1537)</sup> to define the test activity, and then click on the **Save** icon in the window toolbar. The test is added to the element.
7. To create a subsequent test activity of this type, click on the **New** icon, or to add items for other types of test, click on the appropriate tab.



To ensure that the test items are visible in the diagram element, as shown in the example below, select the **Testing** checkbox on the **Elements** tab of the **Diagram Properties** dialog. For more information on diagram appearance options, see the [Show Test Script Compartments](#)<sup>[1549]</sup> topic.

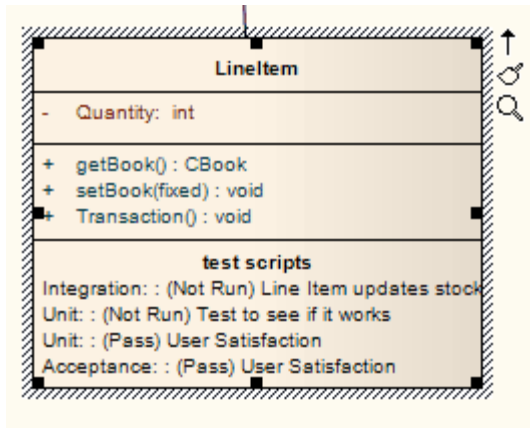

#### 4.6.9 Linked Documents

In the Corporate, Business and Software Engineering, Systems Engineering and Ultimate editions of Enterprise Architect, you can link an RTF document to any UML element in the model.

All editions of Enterprise Architect provide an additional UML Artifact - [Document Artifact](#)<sup>[819]</sup> - that can contain an RTF document internally.

You create linked documents from Linked Document Templates, which you define with the [Document Template Editor](#); see the [Create Linked Document Templates](#)<sup>[603]</sup> and [Edit Linked Document Templates](#)<sup>[604]</sup> topics.

The Document Artifact and the Document Editor are illustrated below:

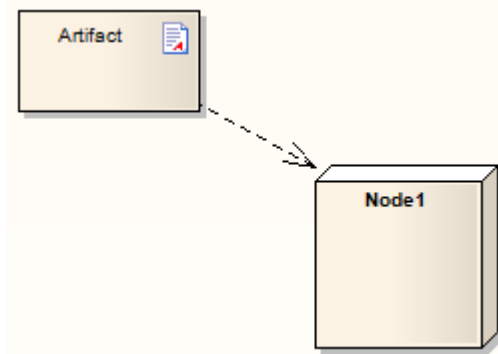

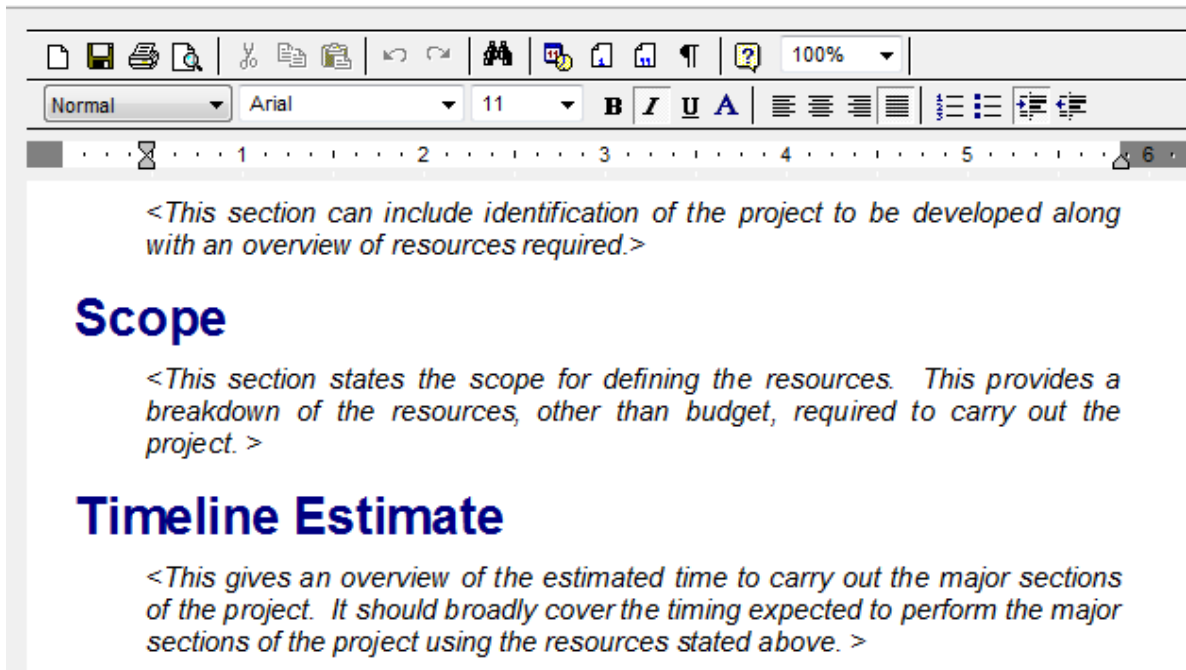

*<This section can include identification of the project to be developed along with an overview of resources required.>*

## Scope

*<This section states the scope for defining the resources. This provides a breakdown of the resources, other than budget, required to carry out the project. >*

## Timeline Estimate

*<This gives an overview of the estimated time to carry out the major sections of the project. It should broadly cover the timing expected to perform the major sections of the project using the resources stated above. >*

**Note:**

When you have saved the document, an **A** symbol displays in the bottom right corner of the element.

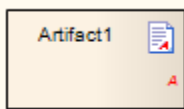

Documents created via the Document Artifact element are rendered into RTF Documentation by selecting the **Linked Document** checkbox in the [RTF Style Template Editor](#). See the [Select Components For Documentation](#)<sup>[1578]</sup> topic.

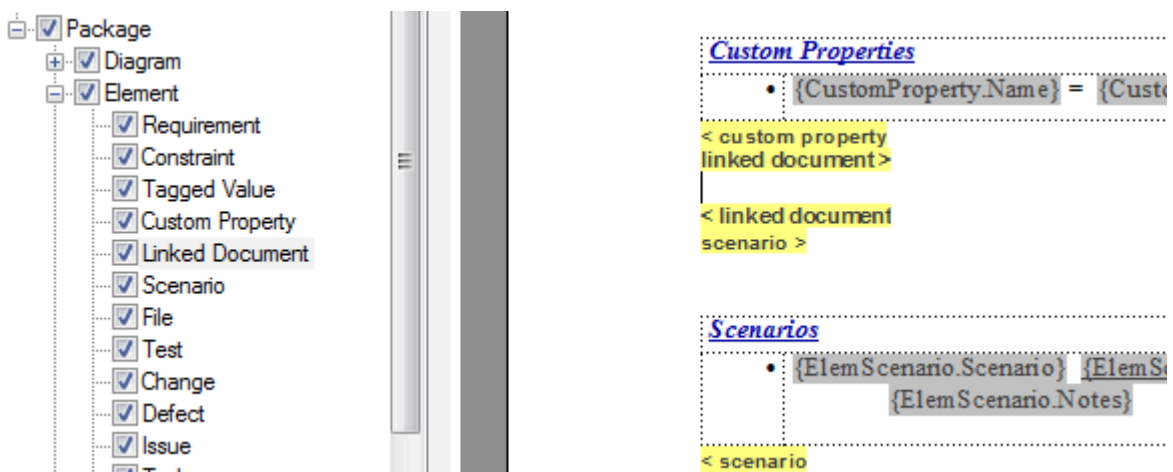

**Package**

- Diagram**
- Element**
  - Requirement
  - Constraint
  - Tagged Value
  - Custom Property
  - Linked Document**
  - Scenario
  - File
  - Test
  - Change
  - Defect
  - Issue
  - Test

**Custom Properties**

- {CustomProperty.Name} = {Cust

**Scenarios**

- {ElemScenario.Scenario} {ElemS  
{ElemScenario.Notes}

The **Linked Document** checkbox is within the **Element** hierarchy, towards the end. Remember that checkboxes can be moved up and down the hierarchy (as has been done above) to position information in the generated document as you require. In some templates, the **Linked Document** checkbox is only available as a child of the **External Requirements** checkbox.

The linked document is rendered into the RTF documentation at:

linked document >

<linked document

#### See Also

- [Create Document Artifact](#) <sup>[599]</sup>
- [Link Document to UML Element](#) <sup>[599]</sup>
- [Edit Linked Documents](#) <sup>[600]</sup>
- [Hyperlink From Linked Document](#) <sup>[601]</sup>
- [Create Element From Document](#) <sup>[602]</sup>
- [Replace or Delete Documents](#) <sup>[602]</sup>
- [Generate RTF Documentation Dialog](#) <sup>[1573]</sup>

#### 4.6.9.1 Create Document Artifact

You create a Document Artifact element in a [Component](#) <sup>[730]</sup> or [Deployment](#) <sup>[727]</sup> diagram.

Drag and drop the *Document Artifact* element from the **Toolbox** into your diagram.

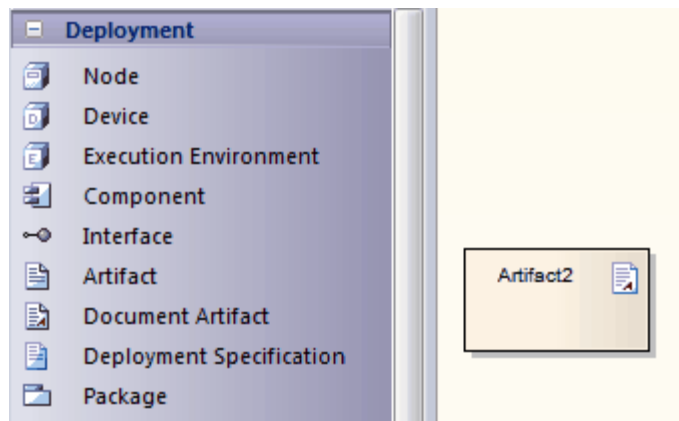

Double-click on the Document Artifact element. The [Linked Document Editor](#) <sup>[600]</sup> opens, with the **New Linked Document** dialog.

In the **Copy template** field, click on the drop-down arrow and select a previously-created *Linked Document Template*. Click on the **OK** button.

For more information on how to create and edit Linked Document Templates, see [Create Linked Document Templates](#) <sup>[603]</sup> and [Edit Linked Document Templates](#) <sup>[604]</sup>.

#### 4.6.9.2 Link Document to UML Element

##### Note:

This operation is available in the Corporate, Business and Software Engineering, System Engineering and Ultimate editions.

Click on an element in the [Project Browser](#), [Element List](#), [Model Search](#) or diagram, and:

- select the **Element | Linked Document** menu option
- in the **Notes** window, click on the **Linked Document** icon in the toolbar
- press **[Ctrl]+[Alt]+[D]** or
- right-click and select the **(Create) Linked Document** option from the context menu.

Alternatively, open the element [Properties](#) dialog and click on the **Linked Document** icon in the toolbar in the **Notes** field.

The following dialog displays.

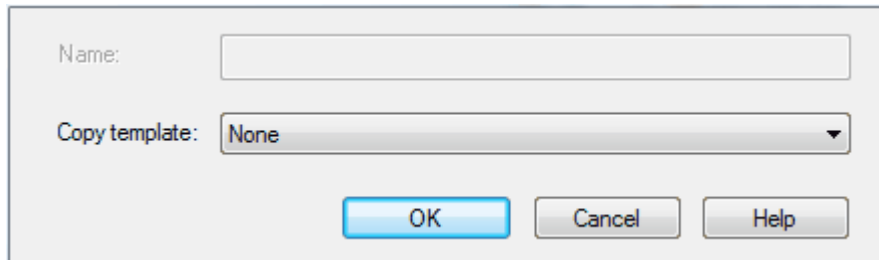

Select the previously-created template from which to create the document.

Click on the **OK** button.

The [Linked Document editor](#) <sup>[600]</sup> displays, in which you enter the text of the document.

**Note:**

When you have saved the document, an **A** symbol displays in the bottom right corner of the element.



For more information on how to create Linked Document Templates, see [Create Linked Document Templates](#) <sup>[603]</sup> and [Edit Linked Document Templates](#) <sup>[604]</sup>.

### 4.6.9.3 Edit Linked Documents

Enterprise Architect provides a Windows-like word processor to help you edit Linked Documents. This is a simplified version of the RTF Style Template Editor, and it provides the same convenient features.

The main difference between the two editors is that you access the *RTF Style Template Editor* features through a menu bar at the top of the screen, whilst you access the *Linked Document Editor* features through a context menu. To access the context menu, just right-click anywhere on the document.

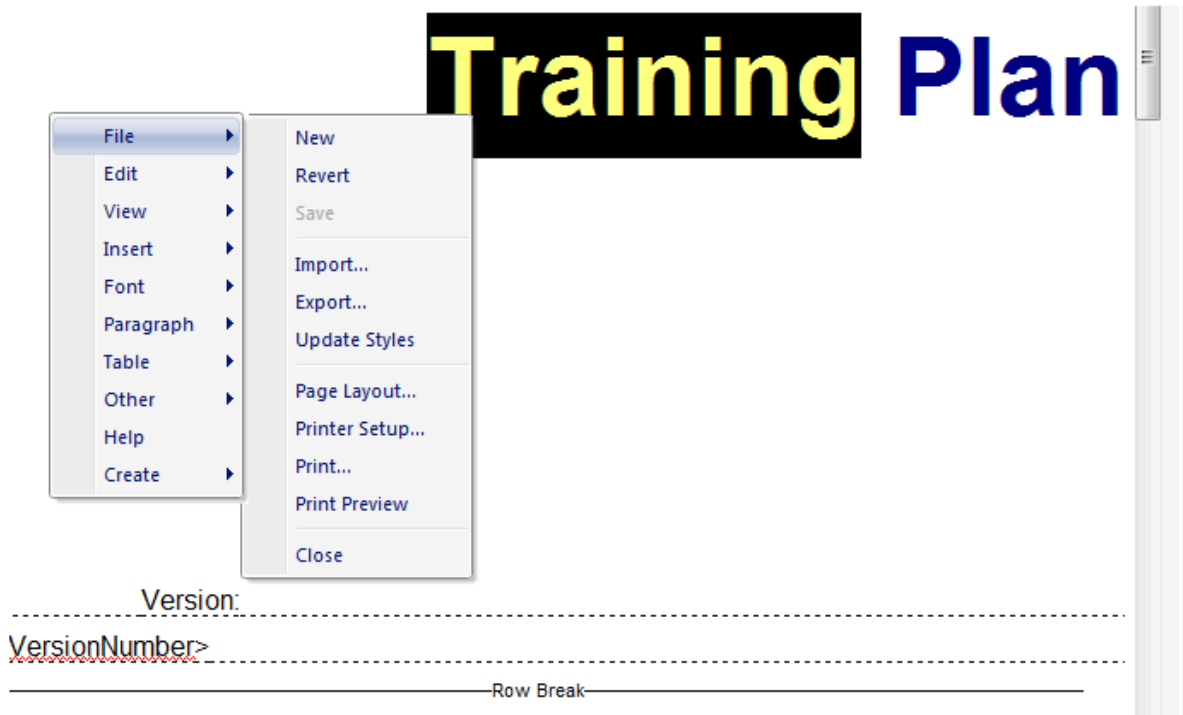

You can format and edit the document in a number of ways, and add links from and references to the content of the document. For example, you can highlight a word or term in the linked document and select **Create | Glossary Definition** to [create a glossary definition](#)<sup>[326]</sup> for that term. Anyone reading the document can, if they check for the term in the [Project Glossary](#), [read the definition](#)<sup>[324]</sup>.

The following topics provide assistance on using the **Document Editor**.

- [Scroll Through Text](#)<sup>[1588]</sup>
- [File and Print Options](#)<sup>[1588]</sup>
- [Cut and Paste Options](#)<sup>[1589]</sup>
- [Image and Object Imports](#)<sup>[1591]</sup>
- [Character Formatting](#)<sup>[1592]</sup>
- [Paragraph Formatting](#)<sup>[1593]</sup>
- [Tab Support](#)<sup>[1595]</sup>
- [Page Breaks and Repagination](#)<sup>[1595]</sup>
- [Insert Headers and Footers](#)<sup>[1596]</sup>
- [Insert Bookmarks](#)<sup>[1597]</sup>
- [Table Commands](#)<sup>[1597]</sup>
- [Sections and Columns](#)<sup>[1599]</sup>
- [Stylesheets and Table of Contents](#)<sup>[1600]</sup>
- [Text/Picture Frame and Drawing Objects](#)<sup>[1604]</sup>
- [Search/Replace Commands](#)<sup>[1605]</sup>
- [Hyperlink From Linked Document](#)<sup>[601]</sup>
- [Create Elements From Linked Documents](#)<sup>[602]</sup>

#### 4.6.9.4 Hyperlink From Linked Document

Within a linked document, you can add hyperlinks to other objects (elements, packages, diagrams, attributes and operations) in the Enterprise Architect **Project Browser**.

To do this, click on the object in the **Project Browser** and drag it to the point at which to create the hyperlink. The linked document editor automatically creates the hyperlink, using the object name as the hyperlink text. You can edit this text if required.

Similarly, you can create a hyperlink to an element in the model by highlighting the link text in the linked

document, right-clicking on it and selecting the **Create | Link to Existing Element** context menu option. This displays the [Select Classifier](#)<sup>[515]</sup> dialog, from which you select the element to link to.

In either case, when you next open the document, you can double-click on the hyperlink to locate and highlight the object in the **Project Browser**. You can then perform all normal operations on the object, including opening any linked document on the highlighted element.

You can also create a hyperlink to a wide range of additional objects, such as web pages, Help files, [Model Searches](#)<sup>[1235]</sup> and [Team Review](#)<sup>[208]</sup> Forums, by highlighting the appropriate text and then selecting the **Create | New | Hyperlink** context menu option. This displays the [Hyperlink Details](#)<sup>[840]</sup> dialog.

For an alternative method of creating a hyperlink to an external document, Help file or web page, see the [Hyperlinks and Bookmarks](#)<sup>[1597]</sup> topic.

#### 4.6.9.5 Create Element From Document

Using the **Linked Document Editor**, you can create document-specific elements and diagrams in the **Project Browser**, with hyperlinks from the document to the created item. When you click on the hyperlink, the element or diagram is highlighted in the **Project Browser**. The element or diagram is created in the same package as the element for which the linked document was created.

You can create and link to any type of element or diagram, but the facility has specific options for the following element types:

- [Class](#)<sup>[811]</sup>
- [Requirement](#)<sup>[846]</sup>
- [Issue](#)<sup>[1563]</sup>.

You can create the same arrangement with *existing* elements, diagrams and packages by dragging them from the **Project Browser** into the text of the document, creating a [hyperlink](#)<sup>[607]</sup> with the item name as the text.

### Create Item

To create an element or diagram in the **Project Browser**, whilst in a linked document, follow the steps below:

1. Open the linked document, either from a [Document Artifact](#)<sup>[599]</sup> element or through the [context menu](#)<sup>[599]</sup> for an existing element (Corporate, Business and Software Engineering, System Engineering and Ultimate editions).
2. Enter some text, including appropriate text to act as the link (such as the element or diagram name).
3. Highlight the appropriate text and right-click on it. The editor context menu displays.
4. Select the **Create | New** menu option, and the required submenu option. If you select the:
  - **Class, Requirement or Issue** option, the corresponding element is immediately created in the **Project Browser**.
  - **Other** option, the [New Element](#)<sup>[524]</sup> dialog displays; specify the element type and - if appropriate - stereotype, and click on the **Create** button.
  - **Diagram** option, the [New Diagram](#)<sup>[422]</sup> dialog displays; specify the diagram type and click on the **OK** button.
5. The highlighted text is now a hyperlink. Click on the link to highlight the new element or diagram in the **Project Browser**.

You can now edit or expand the element or diagram as required.

#### 4.6.9.6 Replace or Delete Documents

If a linked document is out of date, you can either [edit](#)<sup>[600]</sup> the text or replace the entire contents from another file. To replace the contents:

1. Click in the body of the document and press **[Ctrl]+[A]** to select all the document text.
2. Press **[Delete]**.
3. Right-click and select the **File | Import** context menu option. The Windows **Open** dialog displays, in which you can browse for the file to import into the document.
4. Click on the **Save** icon in the **Linked Document** screen toolbar.

Alternatively, you can delete the linked document. To do this:

1. Click on an element in the **Project Browser** or diagram, and either:
  - select the **Element | Delete Linked Document** menu option or

- right-click and select the **Delete Linked Document** context menu option.
2. Enterprise Architect prompts you to confirm the deletion; click on the **Yes** button.
- If required, you can now create another linked document for the element.

#### 4.6.9.7 Create Linked Document Templates

Linked Document templates can be created via the **Resources** window.

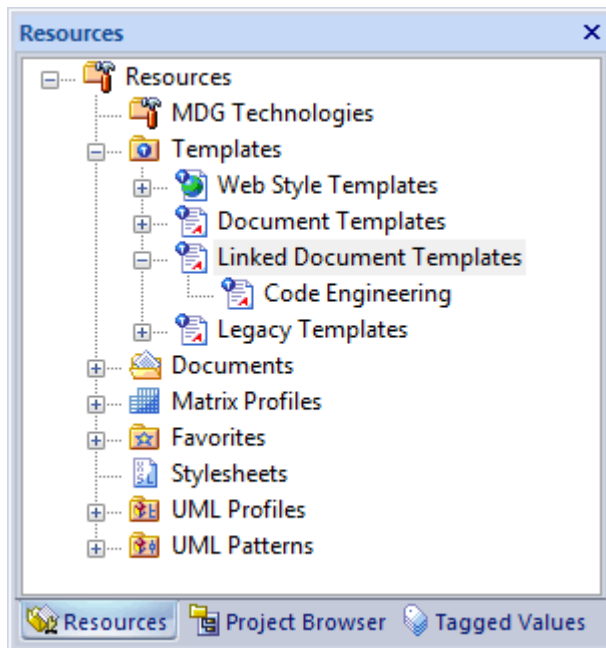

Under the *Templates* folder, right-click on the **Linked Document Templates** icon and click on the **Create Template** context menu option. The following dialog displays.

Enter a name for your template, or select a previously-created template. Click on the **OK** button.

You can group your templates into folders. Right-click on your newly created template and select the **Assign Template to Group** context menu option. Enter a category name and click on the **OK** button.

You can also [modify](#)<sup>[604]</sup> and delete the templates using the context menu options.

#### Note:

You can transport these linked document templates between models, using the [Export Reference Data](#)<sup>[223]</sup> and [Import Reference Data](#)<sup>[223]</sup> options on the **Tools** menu.

#### 4.6.9.8 Edit Linked Document Templates

Double-click on a previously created template in the **Resource View** to invoke the **Linked Document Template Editor**.

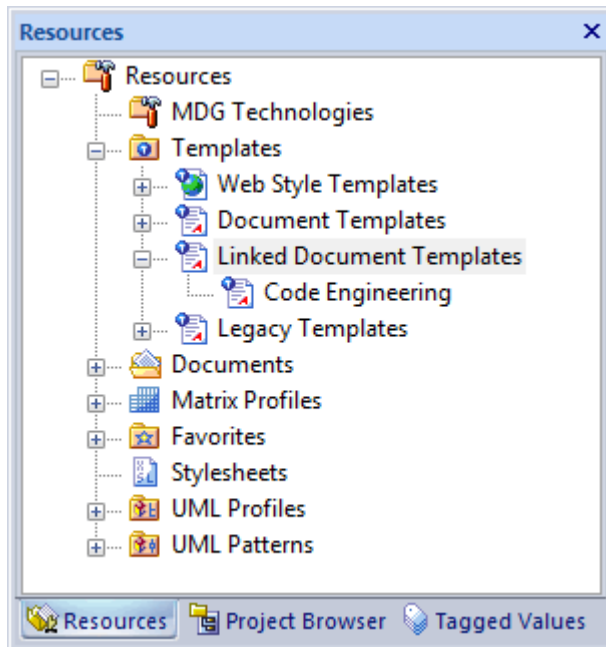

The **Document Template Editor** is built into Enterprise Architect.

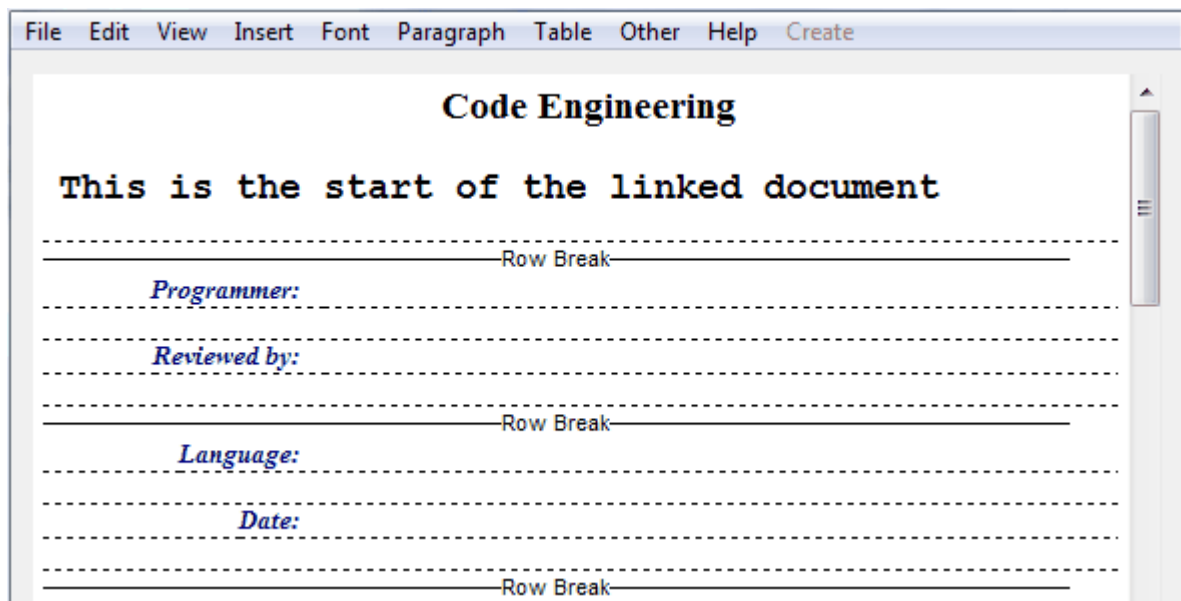

The following topics provide assistance on using the **Document Editor**.

- [Scroll Through Text](#) <sup>(1588)</sup>
- [File and Print Options](#) <sup>(1588)</sup>
- [Cut and Paste Options](#) <sup>(1589)</sup>
- [Image and Object Inserts](#) <sup>(1591)</sup>
- [Character Formatting](#) <sup>(1592)</sup>
- [Paragraph Formatting](#) <sup>(1593)</sup>
- [Tab Support](#) <sup>(1595)</sup>



- [Page Breaks and Repagination](#) <sup>[1595]</sup>
- [Headers and Footers](#) <sup>[1596]</sup>
- [Hyperlinks and Bookmarks](#) <sup>[1597]</sup>
- [Table Commands](#) <sup>[1597]</sup>
- [Sections and Columns](#) <sup>[1599]</sup>
- [Stylesheets and Table of Contents](#) <sup>[1600]</sup>
- [Text/Picture Frame and Drawing Objects](#) <sup>[1604]</sup>
- [Search/Replace Commands](#) <sup>[1605]</sup>

## 4.7 Connectors

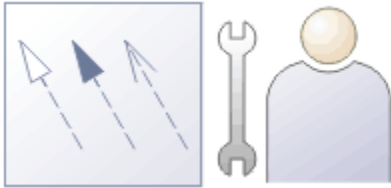

UML connectors, along with elements, form the basis of a UML model. Connectors link elements together to denote some kind of logical or functional relationship between them. Each connector has its own purpose, meaning and notation and is used in specific kinds of UML diagrams. For more information on using connectors, see:

- [Connector Context Menu](#) <sup>[606]</sup>
- [Connector Tasks](#) <sup>[609]</sup>
- [Connector Properties](#) <sup>[626]</sup>

### Off-Page Connector

UML, and therefore Enterprise Architect, does not have a connector that continues activity flow between two diagrams. In creating a model diagram, if the need arises to continue flow to another diagram, you should consider revising and simplifying the structure of the process so that groups of Actions are captured in composite Activity elements, and each group of Actions is modeled within the child diagram of an Activity.

[BPMN](#) <sup>[956]</sup>, however, does enable you to create off-page connectors. You can also use the [Suppress Line Segments](#) <sup>[617]</sup> menu option to indicate continuation of flow in a large diagram that, when printed, occupies several pages. Be aware that these options are purely diagrammatic and do not indicate any diagram relationships in any of the relationship tools.

### 4.7.1 Connector Context Menu

If you right-click on a connector in a diagram, the connector context menu displays. This provides quick access to some important functions. The menu is split into up to seven distinct sections:

- **Add-Ins** - displays in the first section only if you have Add-Ins installed and registered, such as Eclipse
- [Properties](#) <sup>[607]</sup>
- [Type Specific](#) <sup>[607]</sup>
- [Style](#) <sup>[608]</sup>
- [Appearance](#) <sup>[609]</sup>
- **UML Help** - Displays the Enterprise Architect Help topic for this connector type
- **Delete** - delete the connector with this option.

#### Note:

Not all menu options are present on all connector context menus. Context menus vary slightly between connector types. The type-specific menu options are not always included, for example.

#### Example Context Menu for a Generalization:

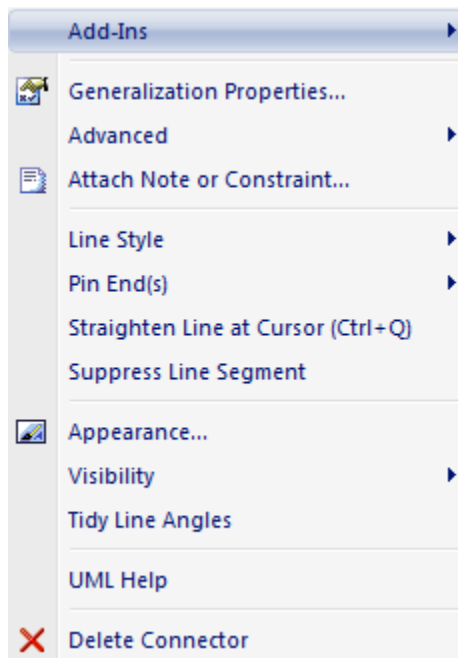

### Connector Role Context Menu

For connectors with *Roles*, right-clicking a connector within up to 60 pixels of an end point displays a role-specific context menu.

The **Role** context menu has three additional menu options:

- A **Source/Target Role...** menu option that opens the connector specification dialog with the respective [role page](#) [629] selected.
- A **Multiplicity** submenu that enables the multiplicity for the role to be set.
- A **Link to Element Feature** menu option that displays a dialog through which you can attach the end of the connector to a [specific attribute or operation](#) [617].

#### 4.7.1.1 Properties Menu Section

The *Properties* section of the connector context menu contains the following options:

Menu Option	Use to
<Connector type> Properties	Open the <a href="#">Properties</a> [626] window for the selected connector.
Advanced	Display the <a href="#">Advanced</a> [608] menu.
Attach Note or Constraint	<a href="#">Attach a note or constraint</a> [612] to the connector.

#### Note:

Not all menu options are present on all connector context menus. Context menus vary slightly between connector types. The type specific menu options are not always included, for example.

#### 4.7.1.2 Type-Specific Menu Section

The *Type-Specific* section of the connector context menu is specific to the object, and only appears for a few different connectors. Some examples are shown below:

Connector	Menu Option	Use to
Transition	<b>Message</b>	Set the value of the Message.

Connector	Menu Option	Use to
Aggregation	<b>Set Aggregation to Composite</b>	Change the Aggregation to composite.
Aggregation	<b>Set Aggregation to Shared</b>	Set the Aggregation to shared. Appears after <b>Set Aggregation to Composite</b> has been selected.

**Note:**

Not all menu options are present on all connector context menus. Context menus vary between connector types. The type-specific menu options are not always included, for example.

#### 4.7.1.3 Advanced Menu Section

The *Advanced* section of the connector context menu contains the following options:

Menu Option	Use to
<b>Set Source and Target</b>	<a href="#">Change the source and/or target</a> [614] of the connector.
<b>Change Type</b>	<a href="#">Change the connector type</a> [614].
<b>Reverse Direction</b>	Reverse the direction of the connector. For example, if the connector is an arrow, the arrowhead swaps to the other end.
<b>Specialize Associations</b>	Specify how the properties of this Association specialize the properties of other Associations.
<b>Information Flows Realized</b>	<a href="#">Realize</a> [866] any information items <a href="#">conveyed</a> [865] on an <a href="#">Information Flow</a> [864] connector between these same two elements.
<b>Dependency Properties</b>	Select a stereotype for the Dependency (or Trace, Role Binding, Occurrence or Represents connector).
<b>Custom Properties</b>	Display the <a href="#">Custom Properties</a> [550] dialog, on which you can set the values for predefined properties for a particular type of connector. For example, set <b>isDerived</b> to <b>True</b> or <b>False</b> for an Association.

**Note:**

Not all menu options are present on all connector context menus. Context menus vary slightly between connector types. The type specific menu options are not always included, for example.

#### 4.7.1.4 Style Menu Section

The *Style* section of the connector context menu provides the following options:

Menu Option & Function Keys	Use to
<b>Line Style</b>	<a href="#">Set the connector line style</a> [615] - options are Direct, Auto Routing, Custom, Bezier, Tree (Horizontal) or Tree (Vertical).
<b>Pin End(s)</b>	Pin the connector start and/or end to the current position on the target element. A sub-menu displays to offer the options of pinning the start point only, the end point only, or both.  Once one or both ends are pinned, a fourth option is available to unpin both ends.
<b>Bend Line at Cursor [Ctrl]+[Q]</b>	<a href="#">Insert an anchor point</a> [615] on the line at the point of the cursor so you can change the shape of the line.

Menu Option & Function Keys	Use to
<b>Suppress Line Segment</b>	Hide a segment of a connector so that you can view a part of the diagram that it crosses.  To reverse the change, right-click on the connector and select the <b>Show All Line Segments</b> context menu option.
<b>Straighten Line at Cursor [Ctrl]+[Q]</b>	<a href="#">Remove an anchor point</a> <sup>[615]</sup> on the line at the point of the cursor. (This is the exact opposite of <b>Bend Line at Cursor</b> , and <b>[Ctrl]+[Q]</b> toggles the connector point between the options.)

**Note:**

Not all menu options are present on all connector context menus. Context menus vary slightly between connector types. The type specific menu options are not always included, for example.

#### 4.7.1.5 Appearance Menu Section

The *Appearance* section of the connector context menu provides the following options:

Menu Option	Use to
<b>Appearance</b>	Set the line color and line thickness of the connector.
<b>Visibility</b>	Set connector visibility; see table below for sub-menu options.
<b>Tidy Line Angles</b>	<a href="#">Tidy the line angles</a> <sup>[616]</sup> of a custom connector.

#### Visibility Sub-Menu

Menu Option	Use to
<b>Hide Connector</b>	Hide the connector. To show the connector again, follow the steps in the <a href="#">Hide/Show Connectors</a> <sup>[621]</sup> topic.
<b>Hide Connector in Other Diagrams</b>	<a href="#">Hide or show the connector in other diagrams</a> <sup>[621]</sup> .
<b>Hide All Labels</b>	Hide or show all labels attached to the connector.
<b>Set Label Visibility</b>	<a href="#">Hide or show labels</a> <sup>[622]</sup> attached to the connector, individually.

**Note:**

Not all menu options are present on all connector context menus. Context menus vary slightly between connector types. The type specific menu options are not always included, for example.

#### 4.7.2 Connector Tasks

This topic details some of the tasks associated with managing model connectors, such as:

- [Connect Elements](#) <sup>[610]</sup>
- [Connect to an Element Feature](#) <sup>[611]</sup>
- [Change Connector Styles](#) <sup>[612]</sup>
- [Arrange Connectors](#) <sup>[613]</sup>
- [Change Connector Type](#) <sup>[614]</sup>
- [Create Connector in Project Browser](#) <sup>[615]</sup>
- [Reverse Connector](#) <sup>[623]</sup>
- [Delete Connectors](#) <sup>[619]</sup>

- [Hide/Show Connectors](#)<sup>[621]</sup>
- [Hide/Show Labels](#)<sup>[622]</sup>
- [Create Generalization Set](#)<sup>[620]</sup>
- [Change the Source or Target Element](#)<sup>[614]</sup>
- [Set Relation Visibility](#)<sup>[619]</sup>
- [Add a Note to a Connector](#)<sup>[612]</sup>
- [Use Tree Style Hierarchy](#)<sup>[625]</sup>
- [Create Connector in Project Browser](#)<sup>[618]</sup>
- [Show Uses Arrow Head](#)<sup>[625]</sup>
- [Set Association Specializations](#)<sup>[623]</sup>
- [Change Sequence Message Scope](#)<sup>[624]</sup>

**Note:**

In the Corporate, Business and Software Engineering, System Engineering and Ultimate editions, if security is enabled, you must have [Update Element](#)<sup>[198]</sup> permission to update or delete a connector.

### 4.7.2.1 Connect Elements

#### Connect Elements on a Diagram

The fastest and simplest ways to create connectors are using the Quick Linker and using the **Toolbox**. The following topics describe these and other approaches for creating connectors on a diagram:

- [Create Connectors In Place Using the Quick Linker](#)<sup>[476]</sup>
- [Create Connectors Using the Toolbox](#)<sup>[399]</sup>
- [Create a Group of Elements Using UML Patterns](#)<sup>[901]</sup>
- [Create Domain Specific Connectors From UML Profiles](#)<sup>[906]</sup>

**Tip:**

To create another connector of the same type as the last connector you used, click on the appropriate source element and press **[F3]**.

#### Select Connectors

To select a connector, simply click on it. Drag handles display, indicating that the connector is selected. This gives the connector focus for keyboard commands such as **[Delete]**, and displays connector properties in docked windows such as the **Tagged Values** window. If there is more than one connector on a diagram, you can cycle through them using the arrow keys.

#### Drag Connectors

You can drag a connector to position it. Click on the connector and drag the connector to where it is to appear. Note that there are some limitations on how far or to where you can drag a connector.

**Notes:**

- You can reposition a connector by selecting and dragging the connectors as required.
- If a connector has source and target roles, you can attach either end of the connector to a [specific attribute or operation](#)<sup>[611]</sup> in the source or target element.

**Tip:**

To reattach the end of a connector to a different source or target element, see the [Change the Source or Target Element](#)<sup>[614]</sup> topic.

#### Connector Properties and Commands

You can double-click on a connector to [change properties](#)<sup>[626]</sup>, or right-click to display the context menu

containing commands to [change connector type](#)<sup>[614]</sup> and [direction](#)<sup>[623]</sup>.

You can also highlight the connectors on a specific element. Select the element and press **[L]**. All the connectors issuing from or terminating at that element are highlighted.

## Create Connectors Without a Diagram

Sometimes it is useful to create relationships between elements without a diagrammatic representation. You can do this using the [Project Browser](#) and the [Relationship Matrix](#), as explained in the following topics:

- [Add Connectors With the Project Browser](#)<sup>[618]</sup>
- [Add Connectors With the Relationship Matrix](#)<sup>[1266]</sup>.

### 4.7.2.2 Connect to Element Feature

If a connector has source and target roles, you can connect either end of the connector to a specific operation or attribute in the source or target element. This is entirely a visual aid, to indicate which features are significant in the relationship. In code generation or transformation, the link is interpreted as a normal source-element to target-element relationship.

To do this, follow the steps below:

1. Right-click on the end of the connector joined to the element containing the required feature.
2. Select the **Link to Element Feature** context menu option. The [Link to Element Feature](#) dialog displays.

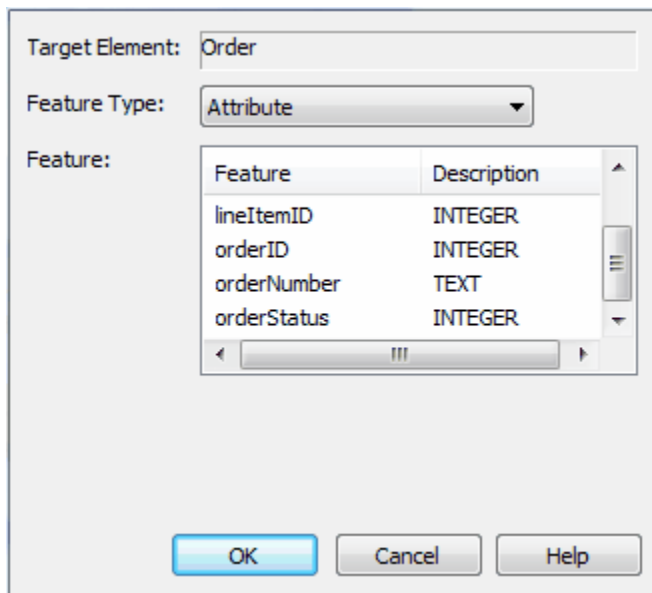

3. In the **Feature Type** field, click on the drop-down arrow and select the required feature type - **Attribute** or **Operation**. The attributes or operations from the element are listed in the **Feature** field.
4. Click on the required attribute or operation, and click on the **OK** button.

The end of the connector changes to a bracket next to the selected feature.

StaffName: VARCHAR2(50)

You might create a number of feature-to-feature relationships between two elements (such as a Class and a Table that represents the Class data) to produce a diagram similar to the following:

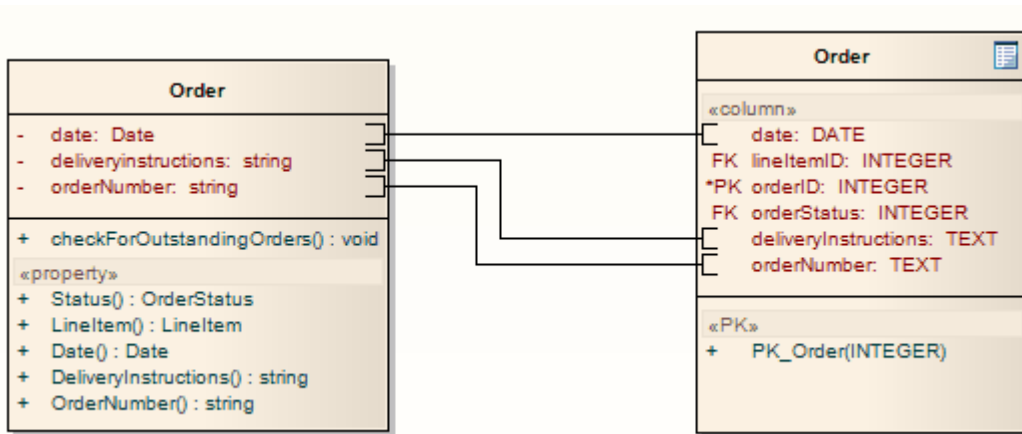

You can change the feature to which the connector is attached by following the above procedure and selecting the new feature.

You can break the link to the selected feature in the following ways:

- Follow the above procedure, setting the **Feature Type** to **None**.
- Delete the attribute or operation from the element
- Change the connector type to a type that does not have source and target roles
- Change the connector to a different source or target element that does not contain the feature.

Note that reversing the direction of the connector does not break the connector's attachment to the feature.

#### 4.7.2.3 Add a Note to a Connector

This topic describes how you can connect notes and constraints to graphical relationships.

Notes enable you to provide explanations and further detail for one or more connectors on a diagram, with a visible note element, as in the example below.

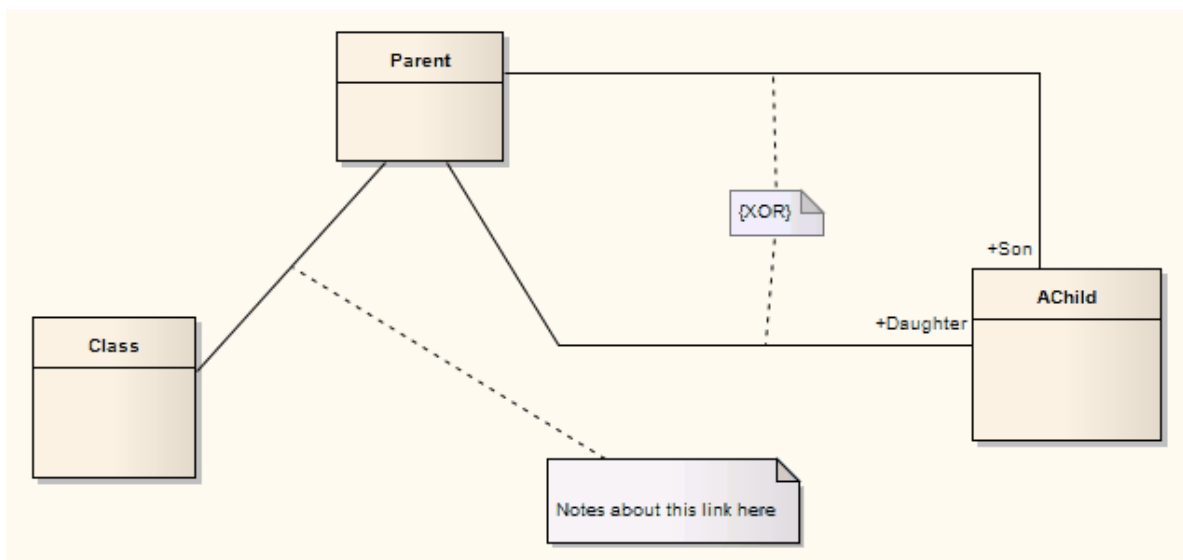

Constraints let you specify a logical or informal constraint against a set of connectors; for example the {XOR} constraint in the image above indicates that only one of the connectors in the specified set can be true at any one time (exclusivity).

#### Attach a Note or Constraint to a Connector

To attach a note or constraint to one or more connectors, follow the steps below:



1. Right-click on one of the connectors to attach a note to. The context menu displays.
2. Select the **Attach Note or Constraint** menu option. The **Link Relations** dialog displays.
3. Check all the connectors that participate in the set. In the example below, two connectors have been checked to participate in a logical constraint.

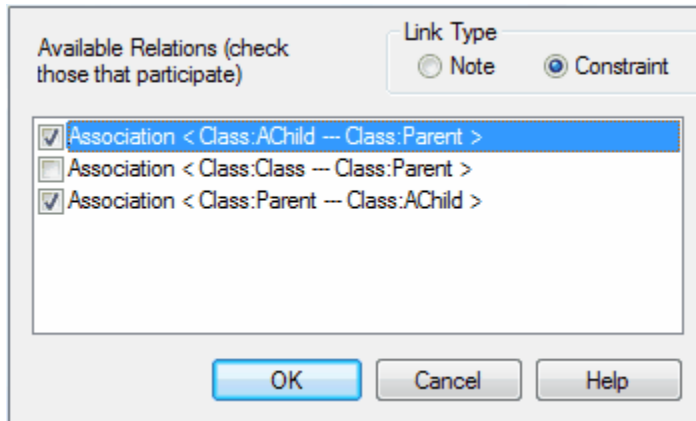

4. Click on the **OK** button to complete the note or constraint creation.
5. You can then use the normal **Note** dialog to enter the appropriate text for the note or constraint.

**Note:**

The constraint note is drawn slightly differently to a regular note, and has { and } automatically added to visually indicate the constraint form.

#### 4.7.2.4 Arrange Connectors

Connectors between two elements can be moved around the element borders to create a good layout. There is a limit to how much a connector can be moved around, but generally it is very easy to find an acceptable layout. For the best layouts, use the *custom* line style; this enables you to add as many line points and bends as you require to create a clean and readable diagram.

#### Move a Connector

To move a connector, follow the steps below:

1. Click once on the connector to select it.
2. Holding the mouse button down, move the connector in the required direction.
3. To refine the movement, click and hold very near to one end of the connector; this enables a slightly different movement range.
4. To further refine the movement and range, select either a *routed*, *direct* or *custom* line style. Each behaves slightly differently (see [Connector Styles](#) <sup>(615)</sup>).

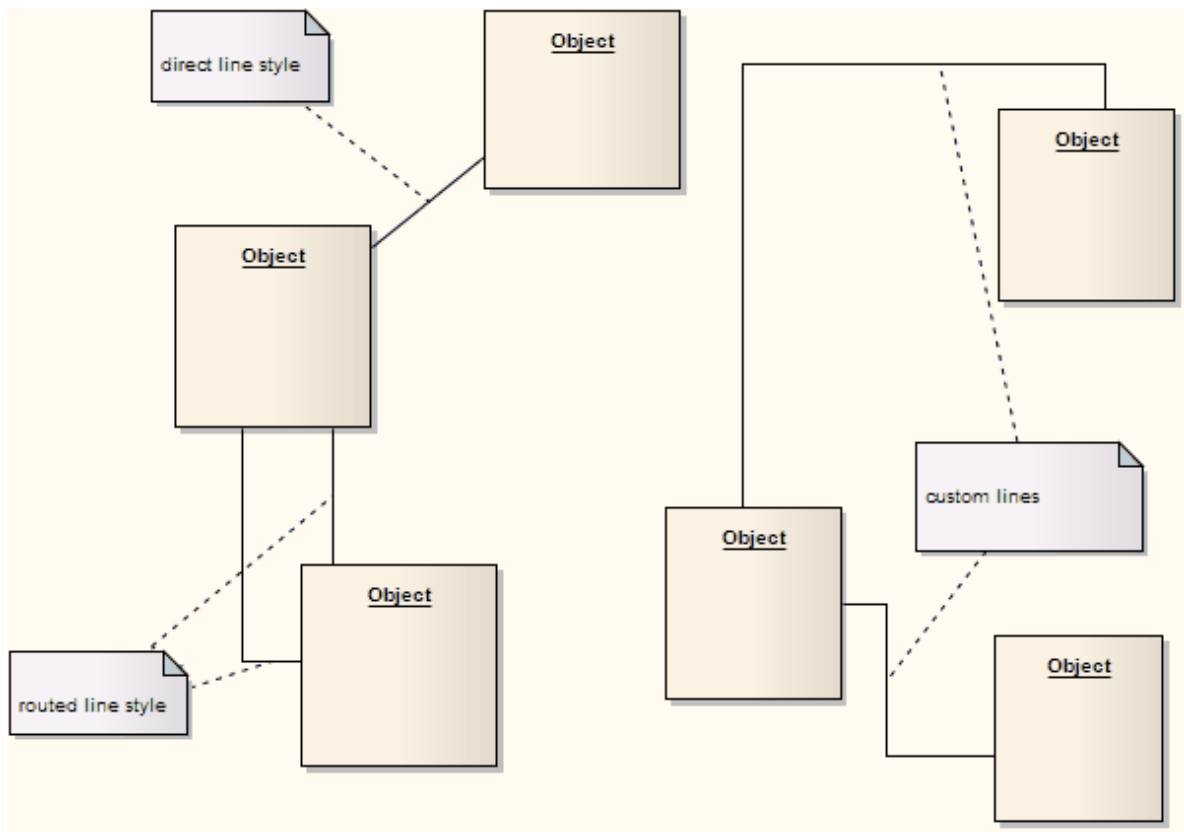

#### 4.7.2.5 Change Connector Type

To change a connector type, follow the steps below:

1. In the **Diagram view**, right-click on the connector to change. The context menu displays.
2. Select the **Connection Detail | Change Type** menu option.

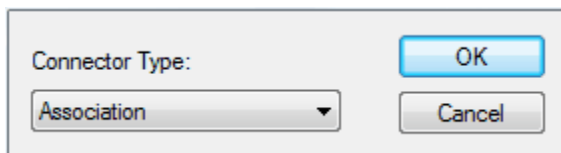

3. In the **Connector Type** field, click on the drop-down arrow and select the required connector type.
4. Click on the **OK** button to apply changes.

#### 4.7.2.6 Change the Source or Target Element

After you have created a connector between two elements, you might later want to change either the source or target. Instead of deleting and re-creating the connector, Enterprise Architect enables you to change the source or target. There are two ways of doing this: using the **Set Source and Target** dialog or using the mouse.

##### Using the Set Source and Target dialog

To change the source or target element of a connector using the **Set Source and Target** dialog, follow the steps below:

1. Right-click on the connector to open the context menu.
2. Select the **Advanced | Set Source and Target** menu option. The **Set Source and Target** dialog displays.

3. Click on the drop-down arrows on the **From Element** and **To Element** fields, and select the source and target elements.
4. Click on the **OK** button to apply changes.

### Using the Mouse

To change the source or target element of a connector using the mouse, follow the steps below:

1. Click on the connector and position the cursor over the 'handle' at one end.
2. When the cursor changes, click the mouse and drag the handle to the new element.

#### Note:

The connector does not actually move until you release the mouse button over the new source or target element. However:

- A dotted line shows where the connector would be during the move, and
- The solid outline of the nearest element or extension changes to a hatched outline as you move the cursor onto it; this helps you identify where the connector will connect to, if there are many closely-arranged elements, Parts, Ports and other extensions.

### 4.7.2.7 Connector Styles

Connectors come in six different routing styles:

Style	Description
<b>Direct</b>	A straight line from element A to element B. You can move the line (back and forward, up and down) to a limited degree.
<b>Auto Routing</b>	A vertical and horizontal route from A to B with 90-degree bends. You can move the line to improve the route, but the location and number of bends are not configurable.
<b>Bezier</b>	A smooth curved line from A to B. Bezier style is directly available for Data Flow diagram connectors, Mind Mapping connectors, State Flows, State Transitions, Object Flows, and Control Flows.  <b>Note:</b> You can convert other types of relationship to Bezier style by assigning the Tagged Value <b>_Bezier</b> , with an integer value other than <b>0</b> . However, some relationship types (such as Aggregate) do not accommodate this style very well.  This Tagged Value over-rides the value of the <b>Style</b> field in the connector <a href="#">Properties</a> dialog.
<b>Custom Line</b>	The most flexible option. You can add one or more line points and bend and push the line into virtually any shape, using the <b>Toggle Line Point at Cursor</b> option.
<b>Tree Style - Vertical</b> <b>Tree Style - Horizontal</b>	A line from element A to B with two right-angle bends, and the end points fixed to selected locations on the elements (Vertical or Horizontal).

Style	Description
	<p><b>Note:</b></p> <p>You can convert relationships to Tree style by assigning the Tagged Value <code>_TreeStyle</code>, with a value of <b>H</b> (Horizontal) or <b>V</b> (Vertical).</p> <p>This Tagged Value over-rides the value of the <b>Style</b> field in the connector <a href="#">Properties</a> dialog.</p>
<b>Lateral - Vertical</b> <b>Lateral - Horizontal</b>	<p>A line from element A to B with a single right-angle bend, and the end points fixed to selected locations on the elements (Vertical or Horizontal).</p> <p><b>Note:</b></p> <p>You can convert relationships to Lateral style by assigning the Tagged Value <code>_TreeStyle</code>, with a value of <b>LH</b> (lateral-horizontal) or <b>LV</b> (lateral vertical).</p> <p>This Tagged Value over-rides the value of the <b>Style</b> field in the connector <a href="#">Properties</a> dialog.</p>

### Set the Connector Style

To set the connector style, follow the steps below:

1. Right-click on the connector to change; the context menu displays.
2. Select the **Line Style** option.
3. From the submenu, select the required style - Direct, Auto Routing, Custom, Tree or Lateral (or Bezier, where appropriate).

Alternatively:

1. Select the connector to change.
2. Press the following keys to change the style:
  - **[Ctrl]+[Shift]+[D]** for Direct
  - **[Ctrl]+[Shift]+[A]** for Auto Routing
  - **[Ctrl]+[Shift]+[C]** for Custom
  - **([Ctrl]+[Shift]+[Z]** for Bezier, where appropriate).

### Bend Connectors

To bend a connector to quickly and easily route connectors in the required layout, follow the steps below:

1. Right-click on the connector; the context menu displays.
2. Set the line style to Custom Line (**[Ctrl]+[Shift]+[C]**); this enables the **Bend Line at Cursor** option in the context menu.
3. Click on the **Bend Line at Cursor** option to add a line point.

**Note:**

Right-clicking a line point displays the **Straighten Line at Cursor** context menu option, which you can use to remove the line point.

4. Using the mouse, drag the line point to the required position.

Alternatively:

1. Hold down **[Ctrl]** or **[Shift]** and click on a point on the connector to create a line point.

**Note:**

**[Ctrl]+click** also removes a line point.

2. Using the mouse, drag the line point to the required position.

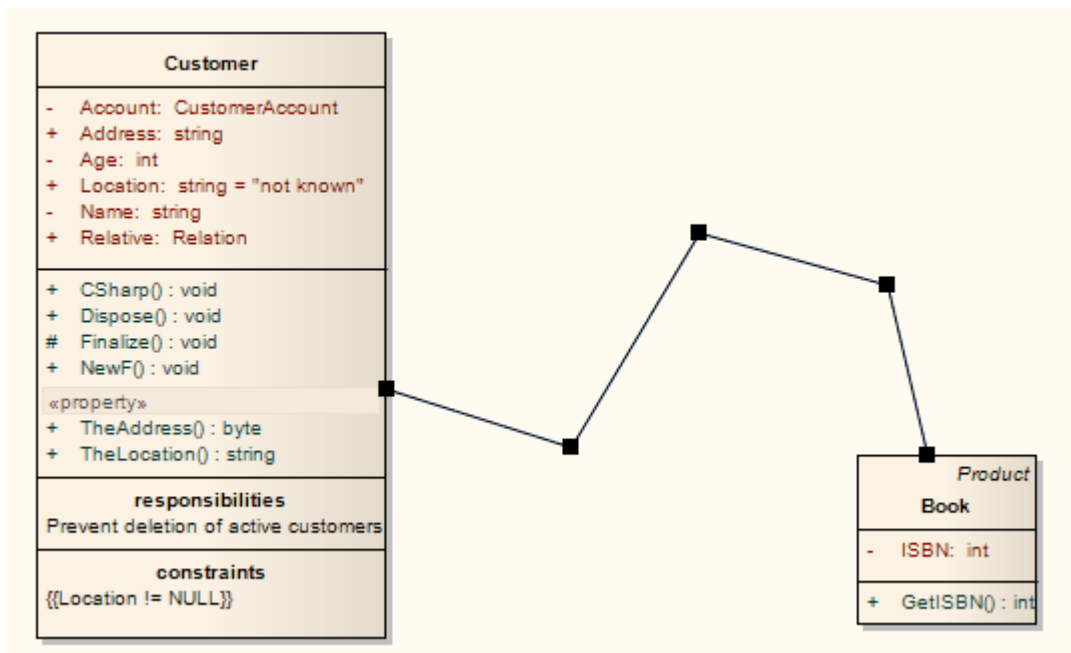

## Tidy Line Angles

To tidy line angles (custom connector), follow the steps below:

1. Right-click on the connector; the context menu displays.
2. Click on the **Tidy Line Angles** menu option; this nudges the custom line in horizontal and vertical increments, saving you the time of trying to get a good layout manually.

### Note:

You can set the **Tidy Line Angles** option to operate by default; click on the **Tools | Options** menu option to display the **Options** dialog, and select the **Diagram Behavior** page.



## Suppress Line Segments

To suppress individual line segments, follow the steps below:

1. Right-click on the connector; the context menu displays.
2. Set the line style to Custom Line (**[Ctrl]+[Shift]+[C]**), this enables the **Suppress Line Segment** option in the context menu.
3. Click on the **Suppress Line Segment** option to suppress a line between two bend points.

### Note:

The segment you right-clicked on is suppressed.

4. To show the segment again, right-click on the line and click on the **Show All Line Segments** context menu option.

One application for this is to represent the continuation of flow when your diagram crosses the page boundary marker in the **Diagram View**. When you suppress the line segment that crosses the boundary, the link name (connector properties) displays at both ends of the hidden segment. When you print the diagram on multiple pages, the link name identifies the connection apparently broken by the page boundary.

### 4.7.2.8 Create Connector in Project Browser

You can create a connector from one element to another directly in the **Project Browser**.

#### Connect Elements from the Project Browser

To connect elements from the **Project Browser**, follow the steps below:

- In the **Project Browser**, either:
  - Right-click on the element to create a connector for, and select the **Add | Create Link** context menu option, or
  - Select the element, press **[Insert]** and select the **Create Link** context menu option.
 The **Create Link** dialog displays.
- In the **Direction** field, click on the drop-down arrow and select the direction of the new connector (**Outgoing** means this element is the source).

The screenshot shows the 'Create Link' dialog box. The 'From Element' section has the following fields:

- Name: AbstractClass
- Type: Class
- Direction: Outgoing
- Link Type: Association

The 'To Element(s)' section has the following fields:

- Choose target(s):
- Select Target Type: Class

The table below shows the elements available in the 'Choose target(s)' list:

Package	Name
Abstract Class Model (PIM)	Account
Abstract Class Model (PIM)	LineItem
Abstract Class Model (PIM)	Order
Abstract Class Model (PIM)	OrderStatus
Abstract Class Model (PIM)	ShoppingBasket
Abstract Class Model (PIM)	StockItem
Abstract Class Model (PIM)	Transaction
Account	AccountBean
Account	AccountBean
Account	AccountPK
Activity Elements	Class1

- In the **Link Type** field, click on the drop-down arrow and select the type of connector.
- In the **Choose target(s)** list, click on the name of the target. (If necessary, in the **Select Target Type** field click on the drop-down arrow and select a feature to list only elements having that feature.)
- Click on the **OK** button to create the connector.

#### Note:

You can also reproduce an existing connector between two elements when you paste those elements from the **Project Browser** into a diagram as instances. [An option](#) <sup>(430)</sup> enables you to copy the relationship as well, or just the elements.

### 4.7.2.9 Relationship Visibility

You can change the visibility of individual connectors or relationships, diagram by diagram.

#### Set Relationship Visibility

To set relationship visibility, follow the steps below:

1. Open the diagram to change.
2. Select the **Diagram | Visible Relations** menu option. Alternatively, press **[Ctrl]+[Shift]+[I]**. The **Set Visible Relations** dialog displays.

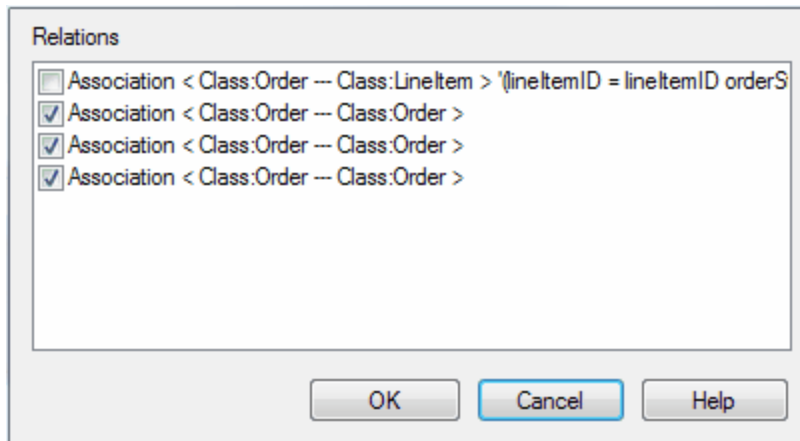

3. Select the checkbox against each list item to show, and clear the checkbox against each item to hide. If you want to display the information in a more readable layout, you can resize the dialog.
4. Click on the **OK** button to apply the changes.

### 4.7.2.10 Delete Connectors

To delete a connector, follow the steps below:

1. Right-click on the connector. The context menu displays.

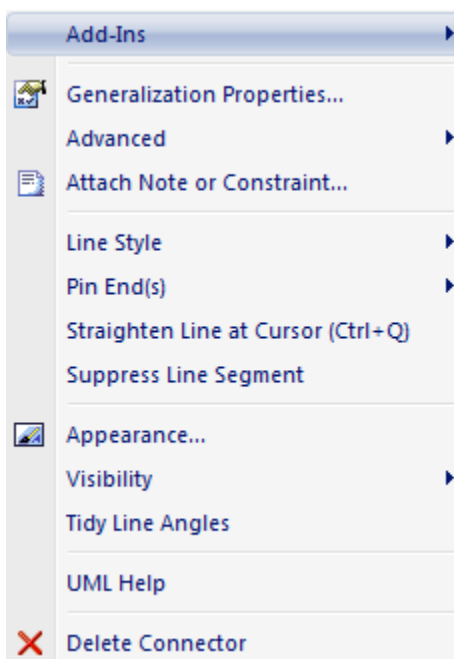

2. Select the **Delete Connector** option. The **Remove Connector** dialog displays.

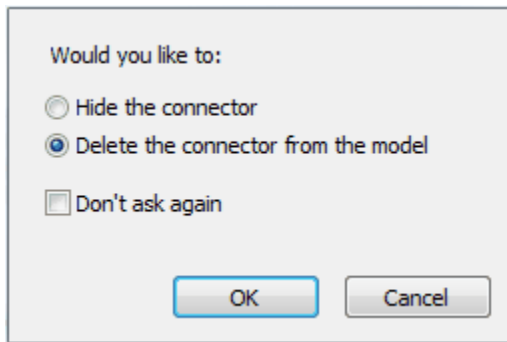

3. This dialog provides the options to hide the connector so that it remains functional, or remove the connector completely. Click on the appropriate radio button and click on the **OK** button.

If you select the **Hide** option, it has the same effect as [hiding the connector](#)<sup>[621]</sup> on the **Links** tab of the source element **Properties** dialog, or using the **Visibility | Hide Connector** context menu option. It also hides the connector on the [Relationships](#)<sup>[1269]</sup> window.

**Note:**

The dialog does not display if:

- You have previously selected the **Don't ask again** checkbox or
- On the **Links** page of the **Options** dialog (**Tools | Options | Links**) the **Prompt on connector deletes** checkbox is not selected.

Selecting the **Don't ask again** checkbox also deselects the **Prompt on connector deletes** checkbox.

Selecting the **Prompt on connector deletes** checkbox restores the dialog if you have used the **Don't ask again** checkbox.

If you hide the dialog, the **Delete Connector** context menu option defaults to the setting you last used on the dialog. Make sure that you have selected the right option to default to.

#### 4.7.2.11 Generalization Sets

A *generalization set* enables you to specify the relationship of a group of subtypes.

To create a generalization set, follow the steps below:

1. Right-click on the connector. The context menu displays.
2. Select the **Advanced | Generalization Set | New** menu option. The following dialog displays.



Name:

Base Type:

Power Type:

Is Covering

Is Disjoint

Generalizations:

Is Member	Name	Subtype/Instance
<input type="checkbox"/>		CD
<input type="checkbox"/>		Book

3. In the **Name** field, type the name of the Generalization set; for example, **Gender**.
4. In the **Power Type** field, either type a new power type, or click on the drop-down arrow or browser button [ ... ] and select an existing one from the [Select <Item>](#) <sup>[515]</sup> dialog.
5. Check the **IsMember** column for the child subtypes that are part of this Generalization set.

The OMG UML specification (*UML Superstructure Specification, v2.1.1, section 7.3.21, p. 77*) states:

*Each Generalization is a binary relationship that relates a specific Classifier to a more general Classifier (e.g. from a class to its superclasses). Each GeneralizationSet defines a particular set of Generalization relationships that describe the way in which a general Classifier (or superclass) may be divided using specific subtypes.*

#### 4.7.2.12 Hide/Show Connectors

Connectors/relations that appear in multiple diagrams can be selectively shown or hidden. This makes it easier to read diagrams where elements might have many connectors, but not all are relevant in the context of the current diagram.

##### Hide or Show a Connector in the Current Diagram

To hide or show a connector in the current diagram, follow the steps below:

1. Double-click on the required diagram element in the **Diagram** view. The element **Properties** dialog displays.
2. Select the **Links** tab. This lists the connectors linked to the element, whether or not they are hidden on the diagram.
3. Right-click on the connector to hide or show. The context menu displays.
4. Select the **Show Relation** menu option to show the hidden connector on the diagram, or the **Hide Relation** menu option to hide the visible connector.

**Tip:**

Alternatively, hide a connector by right-clicking on it on the diagram and selecting the **Visibility | Hide Connector** context menu option. However, you must use the **Links** tab of the element **Properties** dialog to show the relationship again.

**Note:**

Certain elements, such as Requirements, do not have a **Links** tab in the **Properties** dialog. In these cases, open the **Relationships** window (**View | Other Element Tools | Relationships**) for the element and right-click on the relationship in the list to display the context menu. This enables you to hide or show that relationship in the diagram. Be aware that, in the Corporate, Business and Software Engineering, System Engineering and Ultimate editions with security on, locks on the diagram and elements can make the required option unavailable.

### Hide or Show a Connector in Other Diagrams

To hide or show a connector in other diagrams, follow the steps below:

1. Right-click on the connector in the diagram. The context menu displays.
2. Select the **Visibility | Hide Connector in Other Diagrams** menu option. The **Set Connector Visibility** dialog displays.

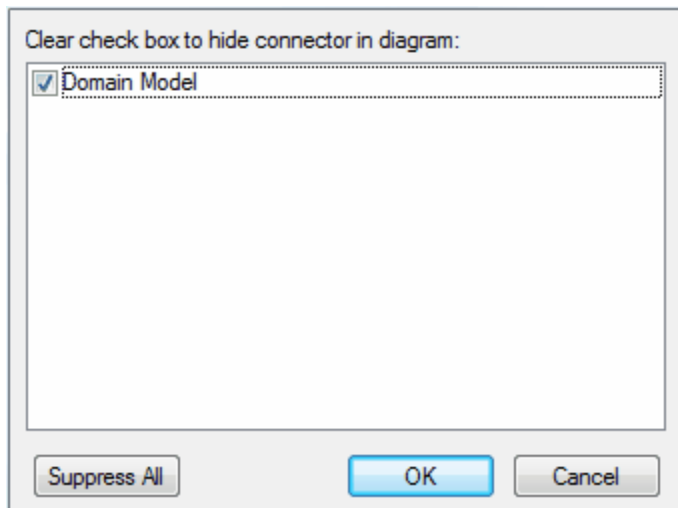

3. If the two connected elements have been included in other diagrams, these diagrams are listed here. In the list, all diagrams for which the checkbox is selected show the connector. Deselect the checkbox for any diagrams in which to hide the connector. If you want to display the information in a more readable layout, you can resize the dialog.

**Tip:**

To hide the connector in all of the diagrams listed, click on the **Suppress All** button.

4. Click on the **OK** button to save the changes.

#### 4.7.2.13 Hide/Show Labels

You can hide or display one or more labels on a connector. To do this, follow the steps below:

1. Right-click on the connector. The context menu displays.
2. Select the **Visibility | Set Label Visibility** menu option. The **Label Visibility** dialog displays.

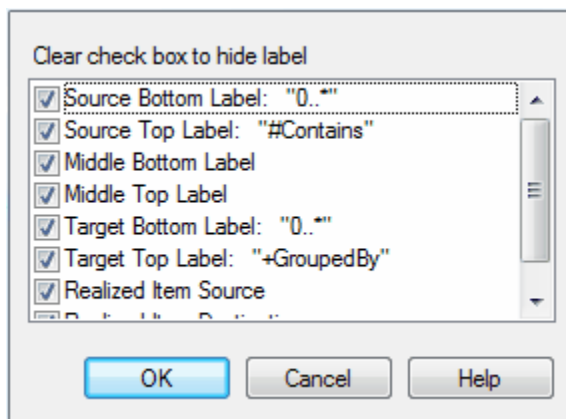

If you have several, long labels, you can resize this dialog for greater clarity.

3. Select the checkbox against each label to display, and clear the checkbox against each label to hide.
4. Click on the **OK** button.

#### 4.7.2.14 Connector In-place Editing Options

You can edit many of the Enterprise Architect connector labels directly on the diagram. Each label can be bound to a single connector field.

##### Procedure

To put a label into Edit mode, either:

- Select the **Edit Label** option from the context menu, or
- Select a label and press **[F2]**.

To save the current text to the field, either press **[Return]** or deactivate the **Edit** window.

To cancel edit mode without saving any changes, press **[Esc]**.

#### 4.7.2.15 Reverse Connector

You can reverse the direction of a connector without having to delete and re-create it. This is helpful if your design changes or you add the connector wrongly to begin with.

##### Procedure

To reverse a connector, follow the steps below:

1. Right-click on the incorrect connector to open the context menu.
2. Select the **Connection Detail | Reverse Direction** menu option.

#### 4.7.2.16 Set Association Specializations

UML enables specialization of properties defined by Associations. Enterprise Architect enables this through the **Specialize Associations** option in the advanced section of the context menu for an Association.

The following dialog displays, showing all Associations between the two Classes connected by the current Association and their parents.

Role: Type	owningProp...	Role: Type	defaultValue
ownedElement: Element		owner: Element	
owner: Element	subsets	ownedElement: Element	subsets
owningLower: MultiplicityElement		lowerValue: ValueSpecification	

The left two columns define the source role of the current Association, while the right two define the target role. With this you are able to select the relationships of each end of the properties listed. When a relationship is set then this is drawn at the corresponding end of the connector on any diagram it appears on.

The dialog above displays when you select the **Advanced | Specialize Associations** context menu option on the lowest Association connector in the following diagram.

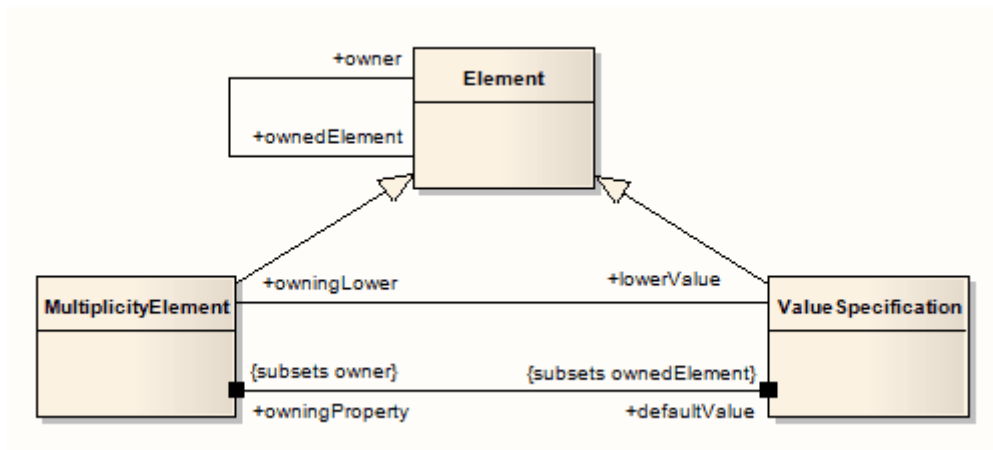

#### 4.7.2.17 Change Sequence Message Scope

A message in a Sequence diagram represents a dynamic interaction from one element to another. Sometimes when you are designing your model you might have to change either the start or end point of a message as the responsibilities of elements change during design. For this reason, Enterprise Architect enables you to change the message scope by setting a new start or end element.

From Element	LineItem
To Element	Order
<input type="button" value="OK"/> <input type="button" value="Cancel"/> <input type="button" value="Help"/>	

#### Change Message Scope

To change message scope, follow the steps below:

1. Select the message in the Sequence diagram.
2. Right-click on the message to open the context menu.
3. Select **Advanced | Set Source and Target**.
4. In the pop up dialog, in the **From Element** and **To Element** fields, click on the drop-down arrows and

select the required elements.

5. Click on the **OK** button to save changes.

The message is re-routed to meet your changed requirements.

#### 4.7.2.18 Show Uses Arrow Head

By default the *Use* connector in Use Cases has no arrow head. To generate arrow heads on the connectors, follow the steps below.

1. Select the **Tools | Options Links** menu option. The **Links** page of the **Options** dialog displays.
2. In the **General** panel, select the **Show Uses arrowheads** checkbox.

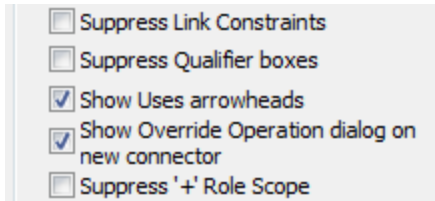

3. Click on the **Close** button.

When you save the Use Case diagram, the Use connectors change to display arrowheads.

#### 4.7.2.19 Tree Style Hierarchy

In Enterprise Architect you can create a tree style inheritance diagram using a special form of the *Generalization* connector, as shown below.

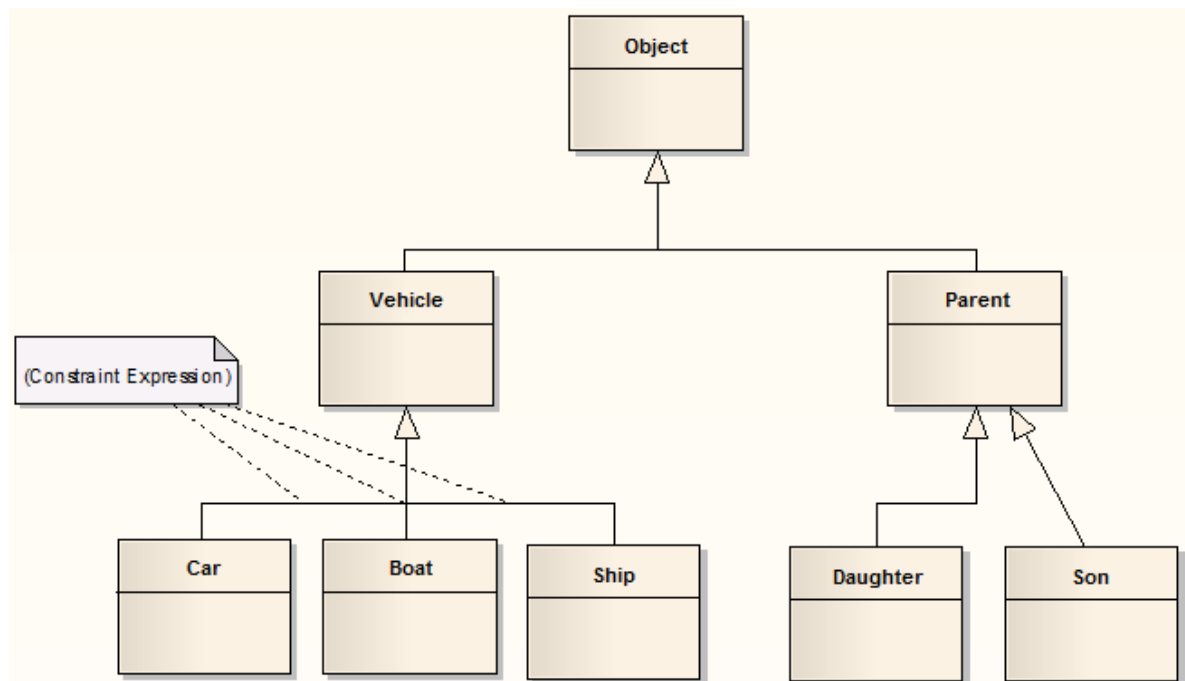

#### Note:

The Son ->Parent connector has not yet been put in Tree Style - Vertical style.

This style of diagram provides a clearer layout for inheritance hierarchies and is easy to work with.

#### Create a Tree Style Connector

To create a tree style connector, follow the steps below:

1. Create a normal Generalization between two elements.
2. Right-click on the connector to open the context menu.
3. Select the **Line Style | Tree Style - Vertical** or the **Line Style | Tree Style - Horizontal** menu option.
4. Enterprise Architect automatically makes the Generalization layout conform to a specific shape. By adding more Generalization connectors, and checking their **Tree Style** options, you can achieve the appearance of the diagram above. You can slide the root and child Classes left and right to achieve the required result; Enterprise Architect maintains the conformity of the branch connectors.

### Set the Default Connector Style

To set this style of connector as default, follow the steps below:

1. Select the **Tools | Options | Links** menu option. The **Links** page of the **Options** dialog displays.

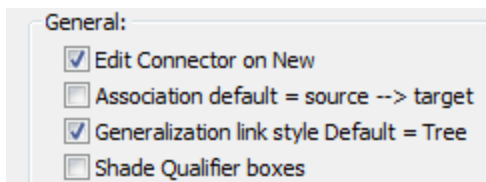

2. Select the **Generalization link style Default = Tree** checkbox to make this branching style the default style for inheritance connectors.

### 4.7.3 Connector Properties

To access the connector **Properties** dialog, double-click on a connector in a diagram. You can change several characteristics of connectors from this dialog.

Many of these characteristics generate text labels on or around the connector. You can change these labels using the **Label** <sup>[452]</sup> context menu.

The connector **Properties** dialog has the following tabs:

- General (see below)
- **Constraints** <sup>[628]</sup>
- **Source Role** <sup>[629]</sup>
- **Target Role** <sup>[631]</sup>
- **Tagged Values** <sup>[631]</sup>

The **General** tab enables you to configure the name of the connector, the direction, the line style, the stereotype (optional) and a comment.

The screenshot shows the 'General' tab of the UML Connector Properties dialog. The 'Source' field contains 'Class\_assg' and the 'Target' field contains 'Account'. The 'Name' and 'Alias' fields are empty. The 'Direction' dropdown is set to 'Destination -> Source' and the 'Style' dropdown is set to 'Custom'. The 'Stereotype' dropdown is empty with a '...' button next to it. Below these fields is a 'Notes' section with a rich text editor toolbar containing icons for Bold (B), Italic (I), Underline (U), Text Color (A), Bulleted List, Numbered List, Text Color, Text Background Color, and a globe icon. At the bottom of the dialog are 'OK', 'Cancel', and 'Help' buttons.

Option	Use to
<b>Source</b>	Type in the name of the source element for the connector.
<b>Target</b>	Type in the name of the target element for the connector.
<b>Name</b>	(Optional) Type a name for the connector. If entered, the name displays on the diagram.
<b>Alias</b>	(Optional) Type an alternative name or alias for the connector.
<b>Direction</b>	Select the appropriate direction details: from source to destination, destination to source, or bi-directional.  Some connectors have arrow heads that depend on this setting. Some connectors are logically dependent on this (such as Inheritance).
<b>Style</b>	Select the appropriate connection style; choose from: <b>Direct</b> , <b>Auto-Routing</b> , <b>Bezier</b> , <b>Custom</b> , <b>Tree (Vertical)</b> or <b>Tree (Horizontal)</b> .
<b>Stereotype</b>	(Optional) Type the name of a stereotype for the connector, or click on the drop-down arrow and select one. Alternatively, click on the [ ... ] button and select the stereotype from the <a href="#">Stereotype Selector</a> dialog.  If entered, the stereotype is displayed on the diagram and over-rides the connector type in the RTF documentation.
<b>Virtual Inheritance</b>	Indicate that inheritance is virtual. Available only for <i>Generalization</i> connectors.
<b>Scope</b>	Select the appropriate value for the scope (used for inheritance). Available only for <i>Generalization</i> connectors where the child Class is C++.

Option	Use to
<b>Notes</b>	(Optional) Type any notes on the connector. The notes are displayed in documentation, if required.  As for the <a href="#">Notes</a> <sup>[641]</sup> window, you can format the text, using the <a href="#">Rich Notes Text</a> <sup>[642]</sup> toolbar at the top of the field.

#### See Also

- [Message Scope](#) <sup>[624]</sup>

### 4.7.3.1 Connector Constraints

A UML connector can also have associated constraints placed on it. Constraints tell us something about the rules and conditions under which a relation operates. For example, it might be a pre-condition that a customer is of a certain type before an Association connector to an Account is allowed.

#### Tip:

Constraints about an Association (connector) can be added to further refine the model. Constraints detail the business and operational rules for the model.

### Set Constraints on a Connector

To set constraints on a connector, follow the steps below:

1. Double-click on a connector to open the Connector **Properties** dialog.
2. Select the **Constraints** tab.
3. Fill in details of the constraint(s) that apply and click on the **Save** button.

The screenshot shows the 'Constraints' tab of the Connector Properties dialog. At the top, there are tabs for 'General', 'Constraints', 'Source Role', 'Target Role', and 'Tagged Values'. The 'Constraints' tab is active. Below the tabs, there are two input fields: 'Constraint:' containing 'Actomame=12 characters' and 'Type:' with a dropdown menu set to 'Invariant'. Below these fields is a large empty text area. At the bottom of this section are three buttons: 'New', 'Save', and 'Delete'. Below these buttons is a table titled 'Defined Constraints' with two columns: 'Constraint' and 'Constraint Type'. The table contains one row with 'Actomame=12 characters' in the 'Constraint' column and 'Invariant' in the 'Constraint Type' column. At the very bottom of the dialog are three buttons: 'OK', 'Cancel', and 'Help'.



Option	Use to
<b>Constraint</b>	Type in the name of the constraint.
<b>Type</b>	Specify the type of constraint (such as pre-condition).
<b>Notes</b>	Type in any notes about the connector.
<b>Defined Constraints</b>	Review the list of constraints for this connector.

### 4.7.3.2 Source Role

This description refers to the role of the *Source* element in a relationship, but applies equally to the role of the *Target* element.

A connector can have certain properties assigned to one end, and be associated with the particular role that element plays in the relationship. You can enter details about this role to further develop your model.

### Set Source Role Details

To set the source role details, follow the steps below:

1. Double-click on a connector. The Connector **Properties** dialog displays.
2. Select the **Source Role** tab.
3. Enter the required details and click on the **OK** button.

Option	Use to
<b>&lt;Type&gt; Role</b>	Type in or select the name of the role to be played.
<b>Alias</b>	Type an alias for the role, if required.

Option	Use to
<b>Role Notes</b>	Type in any required notes about the role.
<b>Derived</b>	Indicate that the role value or values can be computed from other information.
<b>Owned</b>	Indicate that the role is owned by the opposite Class rather than the Association. Selecting this checkbox adds a 'dot' to the appropriate end of the connector. (  )
<b>Derived Union</b>	Indicate that the role is derived from the properties that subset it.
<b>Multiplicity</b>	<p>Specify the role multiplicity. (You can define the values of this field on the <a href="#">Cardinality</a> <sup>[665]</sup> tab of the <b>UML Types</b> dialog.)</p> <p>This is the range of instances of the role that can be active in the relationship; for example, <i>one</i> employee can be assigned to tasks; for the target role you define the range of instances (such as tasks) the employee could be assigned to.</p> <p>The values have the following formats:</p> <ul style="list-style-type: none"> <li>• *, or <b>0..*</b> - zero, one or many instances</li> <li>• <b>0..n</b> - zero or up to n instances, but no more than n</li> <li>• <b>n</b> - exactly n instances</li> <li>• <b>n..*</b> - n, or more than n instances.</li> </ul> <p>Note that you can also define source and target element multiplicity in the element <a href="#">Attribute properties</a> <sup>[562]</sup>.</p>
<b>Ordered</b>	Indicate that the role is a list and the list is ordered.
<b>Allow Duplicates</b>	Indicate that the role can contain duplicate elements (relevant only if multiplicity is > 1). Maps to the UML property <i>isUnique</i> (selecting the checkbox maps to the <i>isUnique</i> value of <i>FALSE</i> ).
<b>Containment</b>	Indicate the nature of the containment at the Destination (reference, value...).
<b>Access</b>	Select the access level for the role.
<b>Aggregation</b>	Select the type of aggregation that this role uses.
<b>Target Scope</b>	Select the level at which this role applies (instance or classifier).
<b>Navigability</b>	Select whether or not this role is navigable (non-navigable ends are shown depending on diagram properties).
<b>Changeable</b>	Select whether this role is subject to change.
<b>Constraint(s)</b>	Type in any constraint on the role.
<b>Qualifier(s)</b>	<p>Type any qualifiers or restrictions on the role. Separate multiple qualifiers with a semi-colon.</p> <p>Alternatively, click on the [ ... ] button at the end of the field, and define a new qualifier on the <a href="#">Qualifiers</a> <sup>[832]</sup> dialog. (Qualifiers typed into the <b>Qualifier(s)</b> field are also automatically added to this dialog.)</p>
<b>Stereotype</b>	(Optional) Type the name of a stereotype that applies to this end of the Association, or click on the [ ... ] button at the end of the field and select a stereotype from the <a href="#">Stereotype Selector</a> <sup>[897]</sup> dialog.
<b>Member Type</b>	Type a role type that can be used when generating collection Classes for multiplicity > 1.

**Note:**

Source role details are displayed at the start end of a connector. If you have drawn the connector the wrong way, you can always use the **Reverse Direction** menu option from the connector context menu.

### 4.7.3.3 Target Role

A connector can have certain properties assigned to one end, and be associated with the particular role that element can play in the relationship.

You can enter details about this role to further develop your model.

### Set Destination Role Details

To set the destination role details, follow the steps below:

1. Double-click on a connector to open the Connector **Properties** dialog.
2. Select the **Target Role** tab.
3. The details and appearance of this tab are identical to the **Source Role** tab. See [Source Role](#) <sup>[629]</sup>.

**Note:**

Destination role details are displayed at the terminating end of a connector on the diagram.

### 4.7.3.4 Connector Tagged Values

The **Tagged Values** tab of the connector **Properties** dialog simply provides the [Tagged Values](#) <sup>[632]</sup> window within the frame of the **Properties** dialog. You can define Tagged Values for the connector and, on *Association* and *Aggregation* connector types, you can set additional Tagged Values for the source and/or target role.

### Set Tagged Values

To set Tagged Values for the connector, follow the steps below:

1. On the **Properties** dialog for the connector, click on the **Tagged Values** tab.

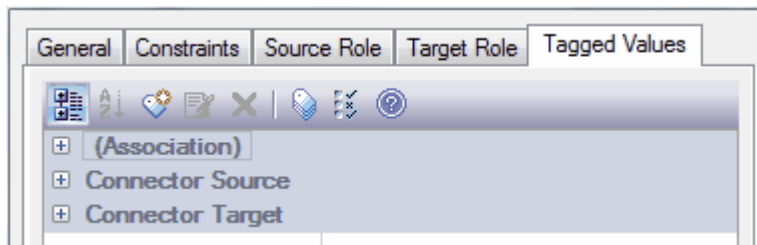

2. Select the connector type, **Connector Source** or **Connector Target** as required.
3. Either click on the **New Tags** button or press **[Ctrl]+[N]**. The **Tagged Value** dialog displays.

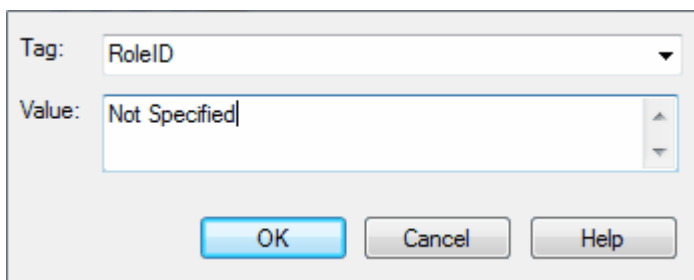

4. In the **Tag** field type the tag name and value, or click on the drop-down arrow and select a predefined Tagged Value type.
5. Click on the **OK** button to save the changes.

## 4.8 Tagged Values

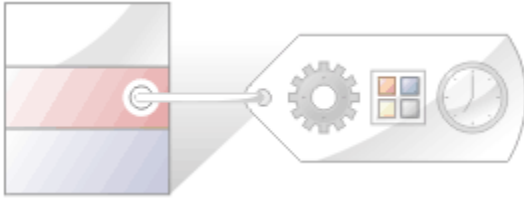

### What is a Tagged Value?

*Tagged Values* are a convenient way of adding additional information to an element, in addition to that directly supported by UML. UML provides the *Tagged Value* element for just this purpose. Often Tagged Values are used during code generation or by other tools to pass information or operate on elements in particular ways. Tagged Values are the preferred method of extending the code generation capabilities of the modeling tool per element, per language.

A Tagged Value, strictly, is the *value* of a property of a modeling [item](#)<sup>[633]</sup>, the property being called a *tag*. For example, a Class element called *Person* might have a tag called **Age** with the Tagged Value of **42**. More loosely, the combination of tag and value can be referred to as a Tagged Value.

A [Tagged Value Type](#)<sup>[664]</sup> is a group of parameters that define and/or limit the possible values of a tag and, in many instances, how a specific value is assigned to the tag. For example, the tag **Age** might have a Tagged Value Type of **Integer**, so the user simply types in a numeric value. Alternatively, the type could be **Spin**, with lower and upper limits of, say, **20** and **120**, so the user sets a value by clicking on arrows in the field to increment or decrement the value within the limits of 20 and 120.

To quickly add Tagged Values to one of more elements, see the [Quick Add - Tagged Value to Elements](#)<sup>[634]</sup> topic.

### The Tagged Values Window

The **Tagged Values** window is used to view and modify Tagged Values for the currently selected modeling item, either in the current diagram or in the **Project Browser**.

The **Tagged Values** window is, by default, set to hide fully qualified values (which show exactly where the Tagged Value came from) and duplicate values, as in the first window below. If you prefer, you can change the settings to [show duplicate values](#)<sup>[637]</sup> and fully-qualified values, as in the second window below:

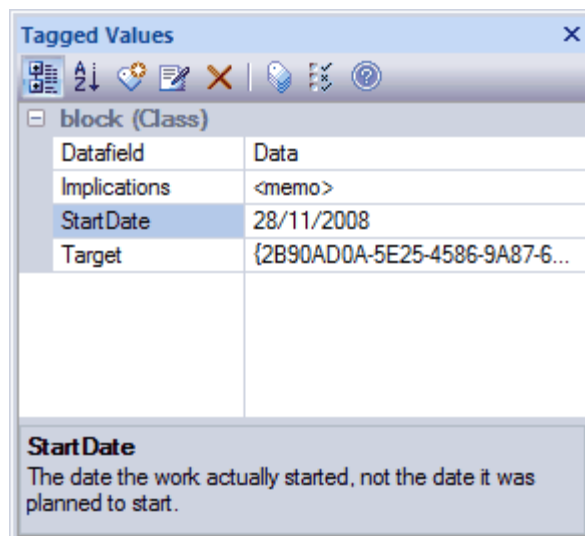

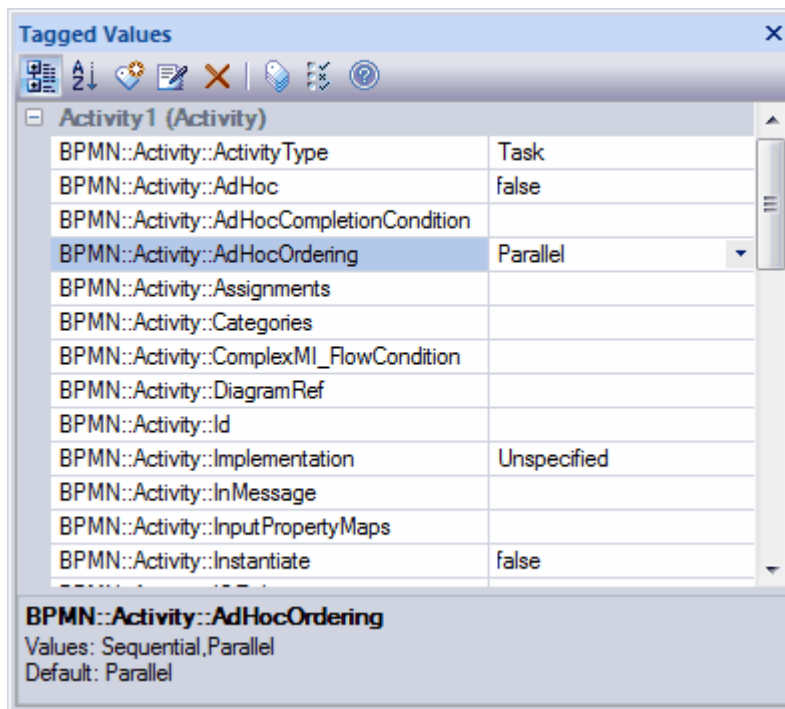
**Note:**

Fully qualified Tagged Values can be displayed only if the Tagged Value was created in Enterprise Architect release 7.1 or later. You cannot display the fully qualified path for Tagged Values from earlier releases.

The **Tagged Values** window is a dockable window. You can use it to perform the following actions:

- [Assign a Tagged Value to an Item](#) <sup>[635]</sup>
- [Modify Tagged Values](#) <sup>[635]</sup>
- [Assign Notes to a Tagged Value](#) <sup>[636]</sup>
- [Perform advanced tag management.](#) <sup>[638]</sup>

A Technology Developer can also create new structured Tagged Values, reference data Tagged Values and [custom Tagged Values](#) <sup>[117]</sup> from predefined [Tagged Value Types](#) <sup>[116]</sup>.

## Model Elements and Features with Tagged Values

The following model components can use the **Tagged Values** window as a convenient way to quickly view and modify Tagged Values:

Component	Description
Elements	Elements display their own Tagged Values along with any inherited values.
Object Instances	Object Instances display owned tags and those obtained from their classifier.
Ports and Parts	Ports and parts display information similar to objects and display Port/Part 'Type' instead of a classifier. Tags are included for all parents and other structures of the Ports type.
Attributes	Include owned Tagged Values and those received from attribute type classifiers, with the inclusion of any inherited ones.
Operations	Owned properties only.
Connectors	Owned properties only.

When over-riding an inherited property, Enterprise Architect copies the tag from the parent down to the child element and sets the new value, leaving the original tag unchanged.

To edit Tagged Values, use the **Tagged Values** toolbar, as described below.

### Tagged Values Toolbar Buttons

The buttons in the **Tagged Values** toolbar enable you to add, edit, sort, delete and arrange the Tagged Values of model features.



From left to right, the button functions are as follows:

- The **Show in compartments** button displays the Tagged Values in element compartments on diagrams
- The **Sort and Show Alphabetically** button sorts the current Tagged Values for the element alphabetically
- The **New Tagged Value** button adds a new tag, to which you assign a value
- The **Edit Tagged Value Notes** button enables you to create notes that explain the purpose of the Tagged Value
- The **Delete Tagged Value** button removes the currently selected Tagged Value
- The **Default Tagged Value Types** button enables quick access to tag definitions created in the **Configuration** menu
- The **Tagged Value Options** button enables you to show or hide the fully qualified paths for the Tagged Values in the window, and to show duplicate Tagged Values
- The **Help** button displays help relating to use of the **Tagged Values** window.

#### 4.8.1 Quick Add - Tagged Value To Elements

It is possible to add a single Tagged Value to one or more elements with a special shortcut.

1. From an element context menu (or the context menu of a multi-selection) choose the **Add | Tagged Value** menu option. (Alternatively, select one or more elements and press **[Shift]+[Ctrl]+[T]**). The **Tagged Values** dialog displays, which enables you to enter a **Name** and **Value** for the tag.

2. Click on the **OK** button to add your new Tagged Value to all the currently selected elements.

#### Note:

You can also use the **Current Element** toolbar. The last button is a shortcut to the *Add Tagged Value* function.

To delete this property you must open the element **Properties** dialog, go to the **Tagged Values** tab and manually delete the item. There is currently no shortcut to delete tags from multiple elements simultaneously.

To add notes to the Tagged Value, go to the **Tagged Values** tab, click on the Tagged Value name, and click on the **Edit Notes** button in the tab toolbar. The **Notes** dialog displays.

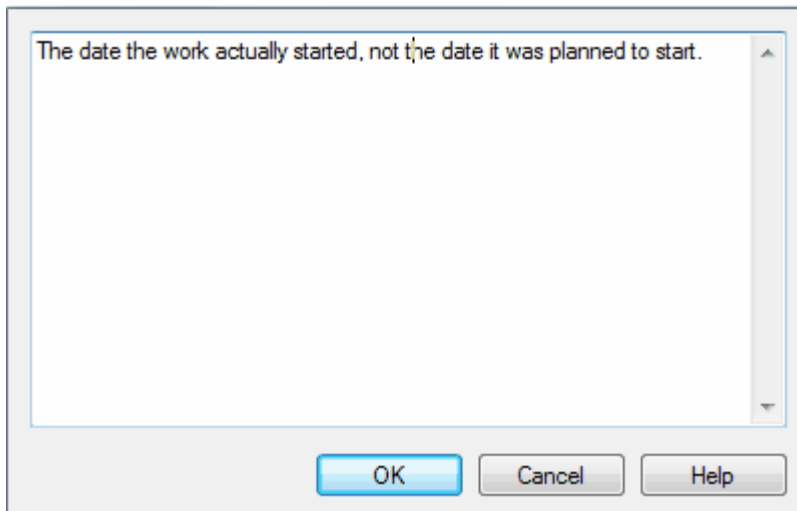

Any **Notes** text you enter also displays in the *Info* section at the bottom of the **Tagged Values** window.

#### 4.8.2 Assign a Tagged Value to an Item

You can assign Tagged Values to several model features, as listed in the [Model Elements and Features with Tagged Values](#)<sup>[633]</sup> topic.

To add a Tagged Value follow the steps below:

1. If necessary, create user-defined tags using a predefined [Tagged Value Type](#)<sup>[1166]</sup>.
2. Select the model feature to associate with the defined Tagged Value.
3. Ensure that the **Tagged Values** window is visible (select the **View | Tagged Values** menu option, or press **[Ctrl]+[Shift]+[6]**).

Alternatively, open the **Properties** dialog for the object and select the **Tagged Values** tab.

4. Either click on the **New Tags** button or press **[Ctrl]+[N]**. The **Tagged Value** dialog displays.

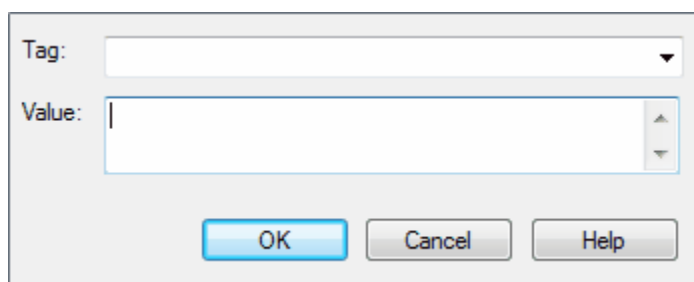

5. In the **Tag** field, type the tag name or click on the drop-down arrow and select the appropriate tag to assign to the item.

##### Note:

Direct entry of *predefined* Tagged Values is only available for predefined tags of type **string**.

6. If appropriate, type a specific value for the tag in the **Value** field.
7. To confirm selection of the Tagged Value, click on the **OK** button.

#### Modify Tagged Values with the Tagged Values Window

Once a Tagged Value has been assigned to the model feature it is possible to edit the values from the **Tagged Values** window. To edit the Tagged Values follow the steps below:

1. Click on the **View | Tagged Values** menu option, or press **[Ctrl]+[Shift]+[6]**. The **Tagged Values** window displays.
2. Click on the model feature for which to edit the Tagged Values. The window shows all of the tags for the

selected feature, each with their current value.

3. Edit the fields as appropriate. The information entered can only reflect the value types that have been defined by the tag's Tagged Value Type.

There are four types of value field for a Tagged Value:

- 'Open' fields, in which you can type any appropriate value
- 'Drop-down list' fields, where you click on the drop-down arrow to select from a discrete list of possible values such as **M** or **F**, or **Win**, **Lose** or **Draw**
- 'Spin' fields, where you click on up or down arrows in the field to increase or decrease the value within certain limits
- 'Further detail' fields, where you click on an ellipsis ([...]) in the field to display a dialog in which you enter information (such as notes) or indicate a source of further information (such as a [classifier](#) <sup>[515]</sup>).

The example below shows a value being modified, using a drop-down list.

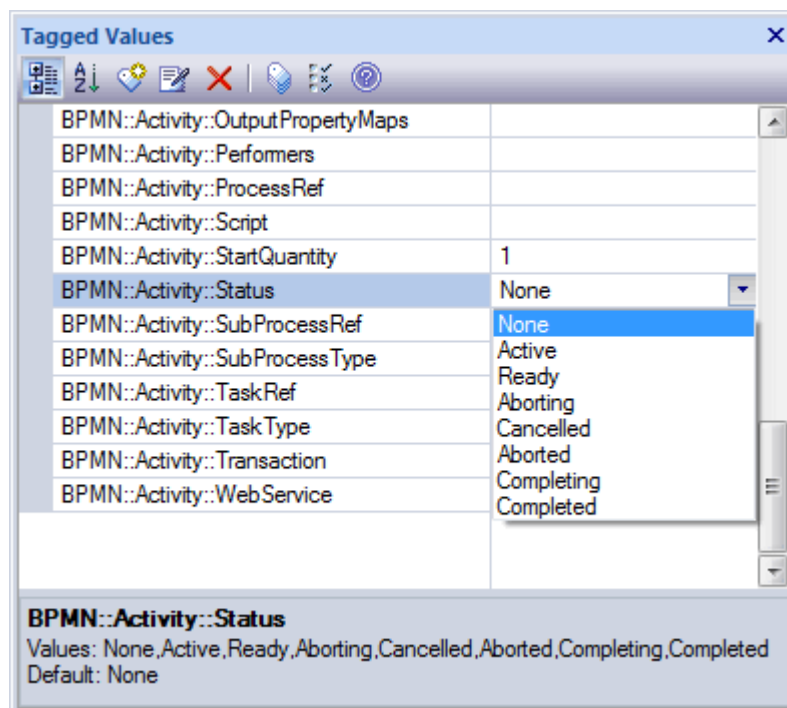

#### Note:

To override a Tagged Value defined in a parent element, edit the value in the **from <parentname>** compartment of the **Tagged Values** window. Once this has been done the tag is moved into the selected element's Tagged Values; this does not affect the Tagged Values defined in the parent element.

### 4.8.3 Assign Notes to a Tagged Value

Once the Tagged Value has been assigned to a [model feature](#) <sup>[633]</sup>, it is possible to add information and notes describing the Tagged Value to the information property of the Tagged Value. To facilitate this from the **Tagged Values** window, follow the steps below:

1. Click on the **View | Tagged Values** menu option, or press **[Ctrl]+[Shift]+[6]**. The **Tagged Values** window displays.
2. Click on the model feature for which to edit the Tagged Values; its Tagged Values display in the **Tagged Values** window.
3. Click on the Tagged Value to add information to.
4. Click on the **Edit Tagged Value Notes** button or press **[Ctrl]+[E]**. The **Tagged Value Note** dialog displays.



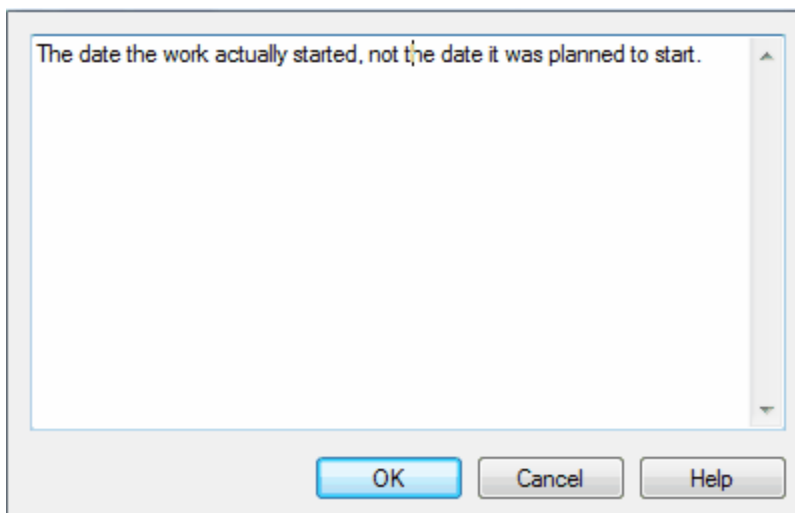

5. In the **Note** field, type the information relating to the Tagged Value, then click on the **OK** button. The information is displayed in the lower portion of the **Tagged Values** dockable window whenever the Tagged Value is selected.

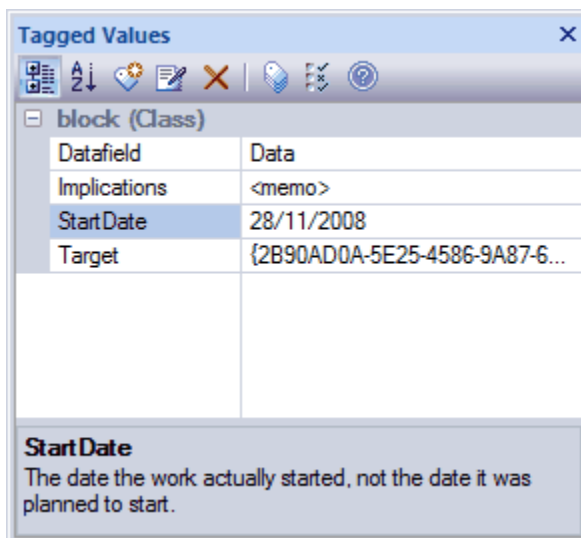

#### 4.8.4 Show Duplicate Tags

Tagged Values are by default set to hide duplicate values. This setting is used to facilitate inherited and overridden tag names.

To set the **Tagged Values** window to show duplicate values, follow the steps below:

1. On the **Tagged Values** window toolbar, click on the **Options** icon.
2. Select the **Show Duplicate Tags** context menu option.

Alternatively:

1. Select the **Tools | Options** menu option. The **Options** dialog displays.
2. From the hierarchical tree, select the **Objects** item.

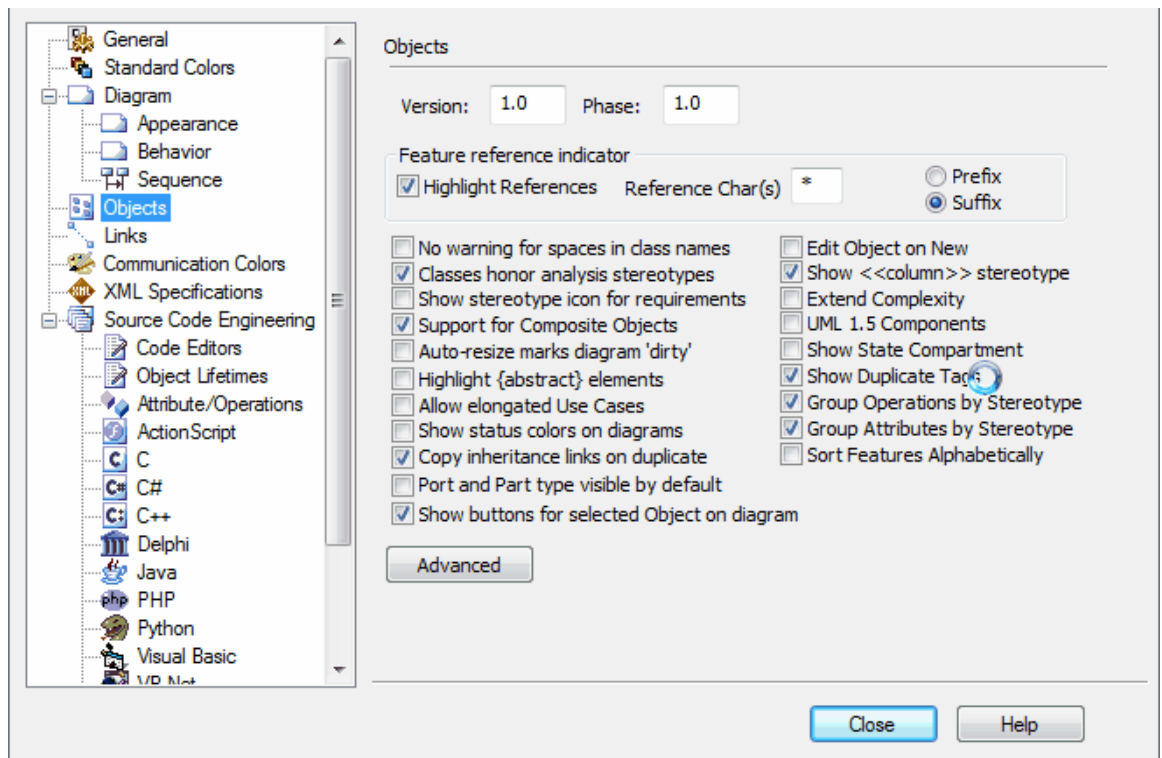

3. Select the **Show Duplicate Tags** checkbox.

In either procedure, to hide duplicate values again deselect the option or check box.

#### 4.8.5 Advanced Tag Management

Tagged Values can also be managed within a type hierarchy and with respect to element instances, using the [Tagged Values](#) <sup>632</sup> window.

Using the **Tagged Values** window it is possible to:

- View Tagged Values inherited from parent Classes or realized interfaces or applied stereotypes
- Override Tagged Values derived from parents or applied stereotypes with a unique value for the current element
- Delete Tagged Values from the current element (if a parent version of the Tagged Value exists, it re-appears in the list after the override is deleted).

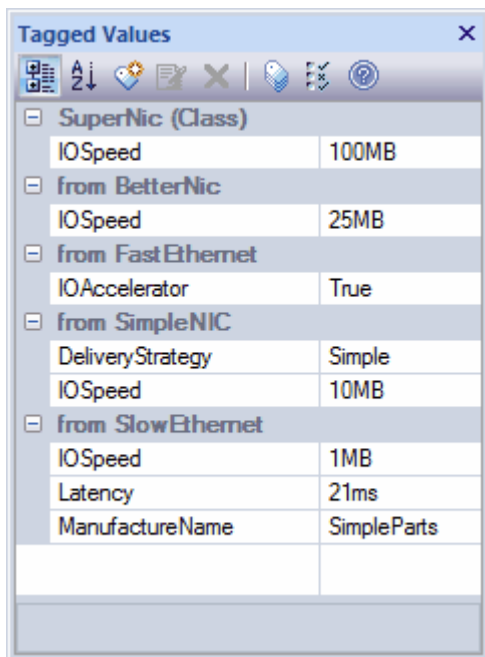

Source	Property	Value
SuperNic (Class)	IOSpeed	100MB
from BetterNic	IOSpeed	25MB
from FastEthernet	IOAccelerator	True
from SimpleNIC	DeliveryStrategy	Simple
from SimpleNIC	IOSpeed	10MB
from SlowEthernet	IOSpeed	1MB
from SlowEthernet	Latency	21ms
from SlowEthernet	ManufactureName	SimpleParts

The diagram below illustrates a complex tag hierarchy and the way Tagged Values can be either inherited or overridden in specialized Classes to create the final tagged property set for an element.

Note also that a similar concept applies to instances, in which case the full tag set is created from the directly owned tags, plus all of those merged in from the classifier's type hierarchy, additional stereotypes and realized interfaces.

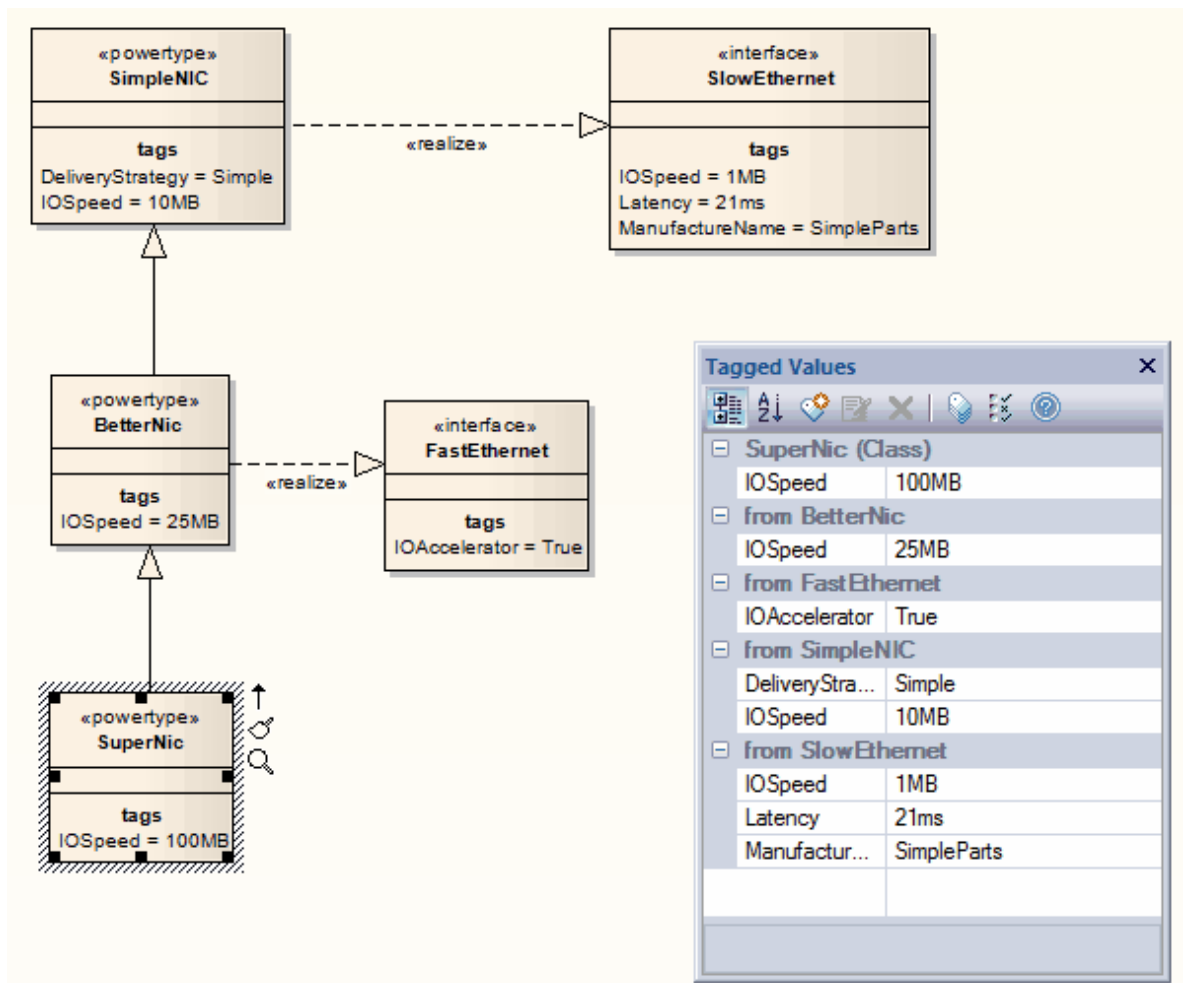

## 4.9 Notes



You use the **Notes** window to view and edit the documentation (notes) associated with elements, diagrams, attributes, operations and connectors, either from a diagram (for both elements and connectors) or from the **Project Browser** (elements only). When you select an element, the note displayed changes to reflect the current selection. If you make changes to notes in this window, they are saved.

Notes are the main documentation feature you use to describe an element or connector. In the documentation that Enterprise Architect generates, notes feature prominently.

If you want to display the Notes information in a more readable layout, you can resize the dialog. You can also format the notes text using the [Notes](#) <sup>[642]</sup> toolbar at the top of the **Notes** window.

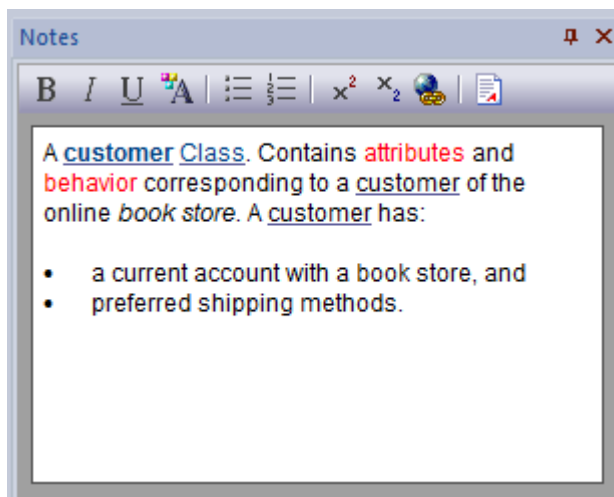

You can cut, copy, paste and delete text in the **Notes** window, or in any **Notes** or **Description** field that shows the **Notes** toolbar, using a right-click context menu. From the context menu, you can also select an option to *spell-check* a highlighted word.

### Tip:

You can also edit notes by double-clicking on an element or connector in a diagram or in the **Project Browser**, to open the **Properties** dialog. Any formatting changes made in one display are reflected in the other.

### Note:

On the **Testing**, **Maintenance** and **Project Management** windows, any descriptive, history, input or results text for a selected item is also displayed in the **Notes** window. You *cannot* edit this text in the **Notes** window.

## Glossary Entries

The **Notes** window or field also enables you to create a [Project Glossary](#) <sup>[323]</sup> entry from text you have highlighted in the window or field. To create the Glossary entry, follow the steps below:

1. Highlight the notes text to use as the Glossary definition (if suitable text is available), and press **[Ctrl] +[C]** to copy it.
2. Highlight the text to use as the Glossary term, and right-click on it to display the context menu.
3. Select the **Create | Glossary Definition** menu option. The [Glossary Detail](#) <sup>[323]</sup> dialog displays, with the selected term in the **Term** field.

4. If you have copied some definition text, paste it into the **Meaning** field. Otherwise type a suitable definition of the term in this field.
5. In the **Type** field, select the appropriate term type.
6. Click on the **Apply** button to save the new Glossary definition.

The term displays in the **Notes** text as a roll-over hyperlink (as shown in the above screen illustration) which, when you move the cursor over it, displays the Glossary definition of the term.

Having created a glossary definition anywhere else in the model, you can insert the glossary term in the text of the **Notes** window (or **Notes** panel of a dialog) as a rollover hyperlink to the definition. To do this:

1. In the **Notes** dialog, move the cursor to the point in the text at which to insert the glossary term.
2. Press **[Ctrl]+[Space]**. The glossary term selection list displays.

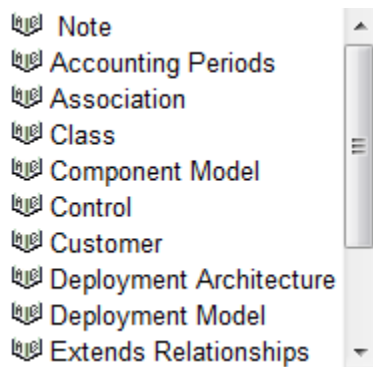

3. Double-click on the term to insert in the **Notes** text. The term is inserted as a rollover hyperlink to the definition.

#### 4.9.1 Notes Toolbar

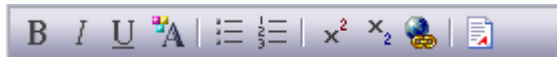

Although it is not an independent toolbar that you can pin to the screen top or sides, or float in your work area, the **Notes** toolbar appears in many places across Enterprise Architect in the **Notes** and **Description** fields of:

- The element **Properties** dialog:
  - **General** tab
  - **Requirements** tab
  - **Scenario** tab
  - Hyperlink Notes
- The **Diagram Properties** dialog
- The **Connector Properties** dialog
- The **Message Properties** dialog
- The **Operations** and **Attributes Properties** dialogs
- The **Testing** Window descriptions
- The **Notes** window
- The **Rules and Scenarios** Window for:
  - Requirements
  - Linked Requirements
  - Scenarios.

**Notes:**

- If the toolbar is displayed but grayed out, the text field is read-only and cannot be edited. Other **Description** or **Notes** fields in Enterprise Architect might not have the toolbar, in which case the Notes facility is not available for those fields.
- For any **Notes** text that is displayed on a diagram, you must select the **Render Formatted Notes** checkbox on the [Feature Visibility](#) <sup>[438]</sup> dialog <sup>[438]</sup> in order to reproduce the formatting.
- You can create a [Project Glossary](#) <sup>[323]</sup> term and definition from text in any field that has the **Notes** toolbar. See [The Notes Window](#) <sup>[64]</sup>.

The options of this toolbar operate on selected text and any new text continuing from the formatting. The options (with some keyboard shortcuts) are, from left to right:

- Make text bold **[Ctrl]+[B]**
- Make text italic **[Ctrl]+[I]**
- Underline text **[Ctrl]+[U]**
- Change the font color of the text
- Insert list bullet points **[Ctrl]+[.]** (*full stop*)
- Insert list numbering **[Ctrl]+[1]**
- Make text superscript
- Make text subscript
- Insert a hyperlink - this displays the following **Hyperlink Details** dialog, on which you specify the type of hyperlink and type in or browse for the location of the target of the hyperlink.

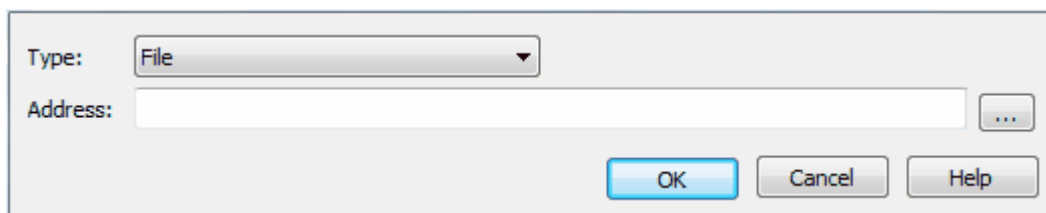

Additional keyboard shortcuts:

- Undo changes **[Ctrl]+[Z]**
- Redo changes **[Ctrl]+[Y]** or **[Ctrl]+[Shift]+[Z]**
- Copy **[Ctrl]+[C]**
- Paste **[Ctrl]+[V]**
- Cut **[Ctrl]+[X]**

Any Note text appearing in the element Note *compartments* in diagrams is not formatted.

## 4.10 Reference Data



Reference data is used in many places to provide content for drop-down list boxes. Setting up a project often involves setting up the base set of reference types to use. Reference data options can be set up from the **Settings** menu, including:

- [People](#) <sup>[645]</sup>
- [General Types](#) <sup>[653]</sup>
- [Maintenance](#) <sup>[660]</sup>
- [Metrics and Estimation](#) <sup>[659]</sup>
- [UML](#) <sup>[662]</sup>
- [Data Types](#) <sup>[666]</sup>

Having set up the reference data in a project, you can also [export and import](#) <sup>[223]</sup> it between projects.

### Note:

In the Corporate, Business and Software Engineering, System Engineering and Ultimate editions of Enterprise Architect, if security is enabled you must have [Manage Reference Data - Update](#) <sup>[198]</sup> permission to update and delete reference items.

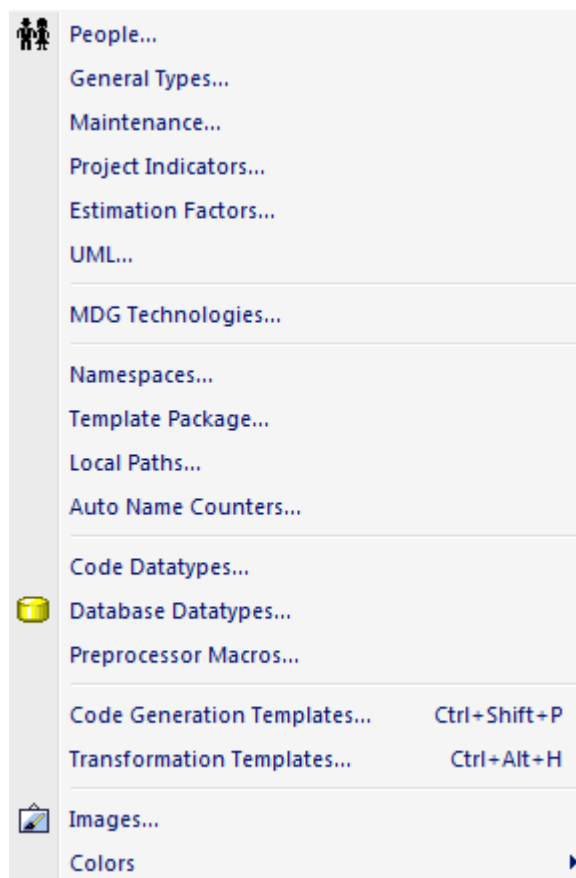



### 4.10.1 People

The **People** dialog enables you to control the following for your project:

- [Project Authors](#) <sup>[648]</sup>
- [Project Roles](#) <sup>[648]</sup>
- [Project Resources](#) <sup>[650]</sup>
- [Project Clients](#) <sup>[651]</sup>

Project Author(s) | Project Roles | Resources | Project Clients

Name(s):  ...

Role:

Notes:

New Save Delete

Defined Authors

Name	Description
Benjamin Hutton	Application Analyst
Frank McIver	Use Case Modeller
Greg Nichols	Project Manager
Jane Ward	VB Programmer
Ken Nielsen	Deployment
Leanne Hamison	Use Case Modeller
Pat Taylor	C++ Programmer
Paulene Dean	Business Analyst

Close Help

To display this dialog, select the **Settings | People** menu option.

#### 4.10.1.1 Project Authors

You can define the people who are working on a project, such as the authors of specific elements.

To define the project authors, select the **Settings | People** menu option. The **People** dialog displays, defaulted to the **Project Author(s)** tab.

Project Author(s) | Project Roles | Resources | Project Clients

Name(s):  ...

Role:

Notes:

New Save Delete

Defined Authors

Name	Description
Benjamin Hutton	Application Analyst
Frank McIver	Use Case Modeller
Greg Nichols	Project Manager
Jane Ward	VB Programmer
Ken Nielsen	Deployment
Leanne Hamison	Use Case Modeller
Pat Taylor	C++ Programmer
Paulene Dean	Business Analyst

Close Help

Complete the fields as described below:

Option	Use to
<b>Name</b>	<p>Type the name of the person registered as a Project Author.</p> <p>If you are using a Windows Active Directory, you can select names from the directory. Click on the [ ... ] (Browse) button to display the <a href="#">Select Users</a> <sup>[647]</sup> dialog.</p> <p>You can also type a list of names separated by semi-colons. This enables you to define a group of people sharing a role, such as a team of Developers, Testers or Analysts. Do not leave any spaces between the names and the semicolon.</p> <p><b>Note:</b></p> <p>If you enter multiple names, Enterprise Architect adds them separately and in alphabetical order to the <b>Defined Authors</b> list. If you then click on one of these names, Enterprise Architect displays that name only in the <b>Name</b> field.</p>
<b>Role</b>	<p>Specify the role the Project Author plays in the project (such as <b>Designer</b>, <b>Analyst</b>, or <b>Architect</b>).</p> <p>You can type a role name or click on the drop-down arrow and select a role defined through the <a href="#">Project Roles</a> <sup>[648]</sup> tab.</p>

Option	Use to
	<b>Note:</b> If you type a role, this is not added to the roles on the <b>Project Roles</b> tab.
<b>Notes</b>	Type any additional notes concerning the Project Author.
<b>Defined Authors</b>	Review the Project Authors already defined.

Click on the **Save** button to add the new names to the **Defined Authors** list.

To add further Authors, click on the **New** button.

To delete a Project Author, click on the name in the **Defined Authors** list and click on the **Delete** button.

**Note:**

You can transport these author definitions between models, using the **Export Reference Data** <sup>[223]</sup> and **Import Reference Data** <sup>[225]</sup> options on the **Tools** menu.

## Select from User Directory

If your company is using a Windows Active Directory, you can select the Project Author names from the local or corporate-wide directory. To do this, follow the steps below:

1. On the **Project Author(s)** tab, click on the [ ... ] button. The **Select Users** dialog displays.

2. Click on the **Object Types** button and select the checkbox for the object type **User**.
3. Click on the **OK** button to return to the **Select Users** dialog.
4. Click on the **Locations** button. The **Locations** dialog displays.

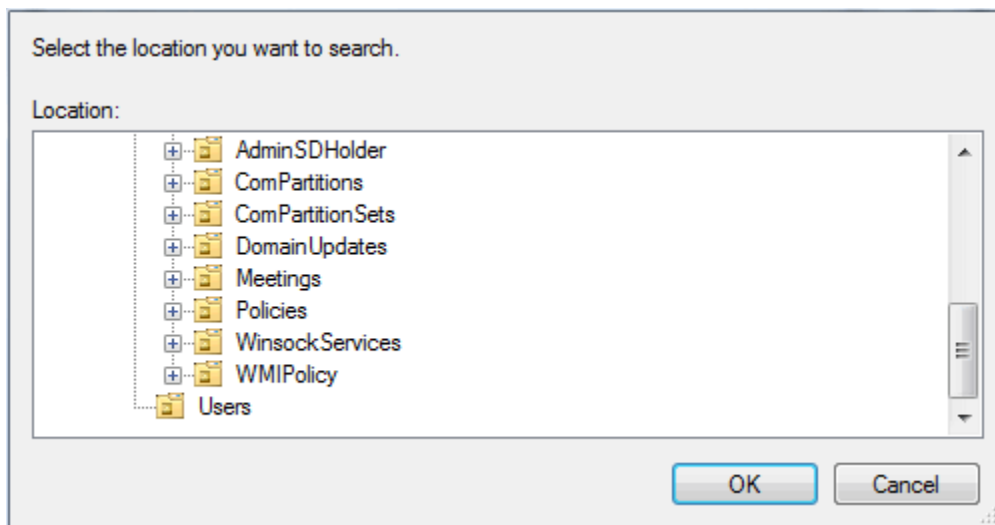

5. Click on the appropriate area or level of the directory, and click on the **OK** button. The **Select Users** dialog redisplay.
6. In the **Enter the object names to search** field, type the first letter of the user name to search for.
7. Click on the **Check Names** button. The **Multiple Names Found** dialog displays, listing the names starting with the specified letter found in the directory location.
8. Click on the required name (or press and hold **[Ctrl]** and click on several names), and click on the **OK** button. The simple **Select Users** dialog redisplay, with the selected names listed.
9. Click on the **OK** button. The **Project Authors** tab redisplay, with the selected name or names in the **Name(s)** field.

#### 4.10.1.2 Project Roles

People associated with a project play a *role* in analysis, design or implementation, such as Application Analyst, Architect, Developer and Project Manager. Project roles define the activities that resources can undertake.

To define the role types that are captured within Enterprise Architect, select the **Settings | People** menu option and, on the **People** dialog, click on the **Project Roles** tab.

Project Author(s) Project Roles Resources Project Clients

Role:  Description:

New Save Delete

Defined Roles

Type	Description
Application Analyst	Define and model the application s...
Business Analyst	Model business processes
C++ Programmer	Programming in Visual C++
Developer	Application development
Java Programmer	Java programming
Project Manager	Manage schedule
Solution Architect	Lead Technical and Project Archit...
Use Case Modeller	Use Case modelling
VB Programmer	Visual Basic Programming

Close Help

To add further roles, click on the **New** button and complete the fields as described below:

Option	Use to
<b>Role</b>	Type the name of the role.
<b>Description</b>	Type a short description of the role.
Notes	Type any additional information related to the role.
<b>Defined Roles</b>	Review all roles that have been previously defined in Enterprise Architect.

Click on the **Save** button to add the new role to the **Defined Roles** list.

The **Defined Roles** list is available for selection for any element in the model; for example, you can select roles on the **Project Authors** <sup>[645]</sup> tab of the **People** dialog, and the **Resource Allocation** <sup>[314]</sup> tab of the **Project Management** window. You can also specify other roles on these dialogs, but such roles are not added to the **Defined Roles** list.

To delete a role, click on the role type in the **Defined Roles** list and click on the **Delete** button.

**Notes:**

- Deleting a role has no effect on any Project Author definition having this role; the deleted role becomes a simple text entry in the Project Author definition.
- You can transport these role definitions between models, using the [Export Reference Data](#)<sup>[223]</sup> and [Import Reference Data](#)<sup>[225]</sup> options on the **Tools** menu.

**4.10.1.3 Project Resources**

*Resources* are, for example, project authors, analysts, programmers and architects. That is, anyone who might work on the system over time, either adding to the model or programming and designing elements of the system outside Enterprise Architect.

To record information on project resources, select the **Settings | People** menu option and, on the **People** dialog, click on the **Resources** tab.

Complete the fields as described below:

Option	Use to
<b>Name</b>	Type the name of the person listed as a resource. The resource name is available for use in <a href="#">Resource Management</a> <sup>[314]</sup> .
<b>Organization</b>	Type the name of the organization employing the resource.

Option	Use to
<b>Role(s)</b>	Type the role the resource plays in the project (for example, Designer, Analyst, Architect).
<b>Phone 1, Phone 2, Mobile, Fax</b>	Type the contact telephone numbers for the resource.
<b>Email</b>	Type the email address for the resource.
<b>Notes</b>	Type any additional notes on the resource.
<b>Available Resources</b>	Review resources that have already been defined.

Click on the **Save** button to add the new resource to the **Available Resources** list.

To add further resources, click on the **New** button.

To delete a resource, click on the name in the **Available Resources** list and click on the **Delete** button.

**Note:**

You can transport these resource definitions between models, using the [Export Reference Data](#) and [Import Reference Data](#) options on the **Tools** menu.

#### 4.10.1.4 Project Clients

*Project clients* are the eventual owners of the software system.

To capture client details associated with the current model, select the **Settings | People** menu option and, on the **People** dialog, click on the **Project Clients** tab.

Project Author(s) | Project Roles | Resources | Project Clients

Name:  Organization:

Role(s):

Phone 1:  Phone 2:

Mobile:  Fax:

Email:

Notes:

Defined Clients

Name	Role(s)
Ralph Spencer	Client Project Manager

Complete the fields as described below:

Option	Use to
<b>Name</b>	Type the name of the client.
<b>Organization</b>	Type the name of the organization that employs the client.
<b>Role(s)</b>	Type the role the client plays in the project (for example, Manager, Sponsor).
<b>Phone 1, Phone 2, Mobile, Fax</b>	Type the contact telephone numbers for the client.
<b>Email</b>	Type the email address of the client.
<b>Notes</b>	Type additional notes on the client.
<b>Defined Clients</b>	Review clients that have already been defined.

Click on the **Save** button to add the new client to the **Defined Clients** list.

To add details of further clients, click on the **New** button.

To delete a client record, click on the name in the **Defined Clients** list and click on the **Delete** button.



**Note:**

You can transport these client definitions between models, using the [Export Reference Data](#) <sup>[223]</sup> and [Import Reference Data](#) <sup>[223]</sup> options on the **Tools** menu.

## 4.10.2 General Types

The **General Types** dialog enables you to configure:

- [Status types](#) <sup>[653]</sup>
- [Constraint types](#) <sup>[655]</sup>
- [Constraint Status types](#) <sup>[656]</sup>
- [Requirement types](#) <sup>[657]</sup>
- [Scenario types](#) <sup>[658]</sup>

To display the **General Types** dialog, select the **Settings | General Types** menu option.

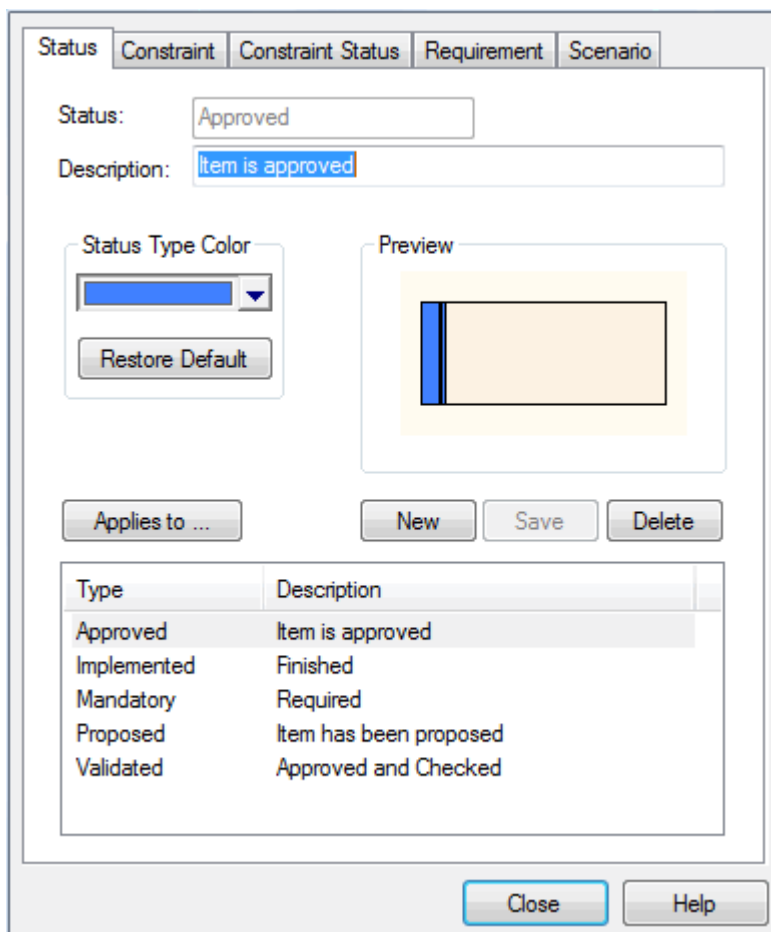

### 4.10.2.1 Status Types

You can configure a basic list of status types used in Enterprise Architect. Note that whilst most dialogs use this list, not all do so.

To configure status types, select the **Settings | General Types** menu option. The **General Types** dialog displays at the **Status** tab.

Type	Description
Approved	Item is approved
Implemented	Finished
Mandatory	Required
Proposed	Item has been proposed
Validated	Approved and Checked

## Create New Status Type

When you display the **Status** tab, the fields default to the definition of the first type in the **Type** list. To add a new type, click on the **New** button and:

- In the **Status** field, type the name of the status
- In the **Description** field, type a short description of the status
- Click on the **Save** button.

The status type displays in the **Type** list. Add the status definition as described in the following sections.

### Note:

You can transport the status types (and the colors assigned to status types) between models, using the [Export Reference Data](#) <sup>[223]</sup> and [Import Reference Data](#) <sup>[225]</sup> options on the **Tools** menu.

## Status Type Color

It is possible to assign a color to each status type, which gives a visual indication of the status of each diagram object. Select a named status type from the **Type** list, click on the **Status Type Color** drop-down list and select the color for that status. Click on the **Save** button to keep your changes.

### Note:

To ensure status colors display on your diagrams, open the **Options** dialog at the [Objects](#) <sup>[362]</sup> page and select the **Show status colors on diagrams** checkbox.

## Apply Colors to UML Elements

By default, status colors only apply to [Requirement](#) <sup>[846]</sup>, [Issue](#) <sup>[1563]</sup> and [Change](#) <sup>[1564]</sup> elements. You might decide to also apply these colors to other UML elements, such as Use Cases or Classes. To do this, click on the **Applies to...** button and select the checkbox against each required element type in the **Applied Status Colors** list.

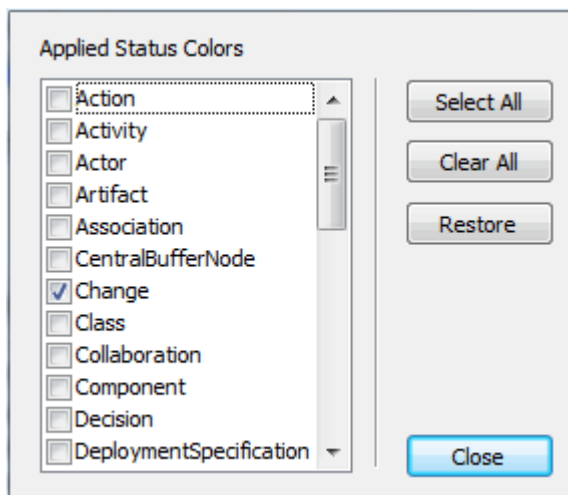
**Note:**

Requirement, Feature, Issue and Change elements have a status color compartment, but other elements do not. The status color for these elements is applied to the element shadow. Therefore, on the [Options dialog Diagram Appearance](#) <sup>(356)</sup> page you must also select the **Element Shadows on** checkbox.

#### 4.10.2.2 Constraint Types

The **Constraint** tab of the **General Types** dialog enables you to define constraints. These are picked up in a variety of places where constraints might fall into more categories than the basic (default) *Pre-*, *Post-* and *Invariant* conditions.

To access this dialog, select the **Settings | General Types** menu option. Click on the **Constraint** tab.

The screenshot shows a dialog box with the following components:

- Tabs: Status, **Constraint**, Constraint Status, Requirement, Scenario
- Constraint:
- Description:
- Note:
- Buttons: New, Save, Delete
- Table: Defined Constraint Types
 

Name	Description
Invariant	A state the object must always be in
Post-condition	An ending state that must be met
Pre-condition	A starting state that must be met
Process	A process that must occur
- Buttons: Close, Help

To add a new constraint, click on the **New** button and:

- In the **Constraint** field, type the name of the constraint; for example, *Assumption*
- In the **Description** field, type a brief description of the constraint
- In the **Note** field type any additional information required
- Click on the **Save** button.

The constraint displays in the **Defined Constraint Types** list.

**Note:**

You can transport these constraints between models, using the [Export Reference Data](#)<sup>[223]</sup> and [Import Reference Data](#)<sup>[225]</sup> options on the **Tools** menu.

#### 4.10.2.3 Constraint Status Types

You can configure the basic list of *constraint status types* used in Enterprise Architect, using the **Constraint Status** tab of the **General Types** dialog.

To access this dialog, select the **Settings | General Types** menu option. Click on the **Constraint Status** tab.

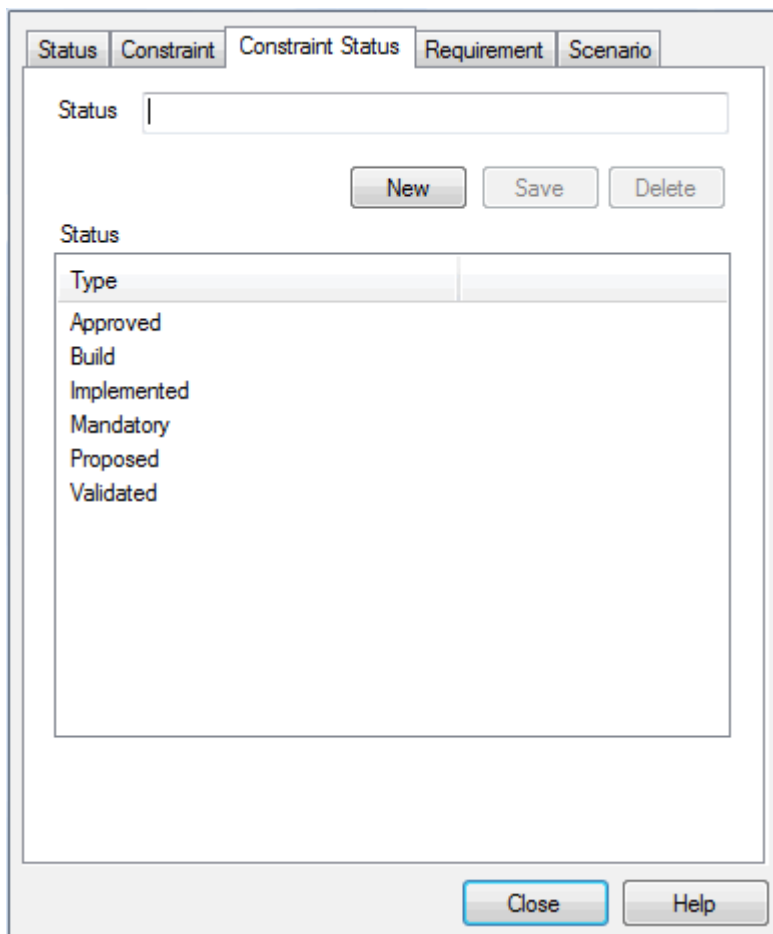

To add a new constraint status type, click on the **New** button, type the status type in the **Status** field, and click on the **Save** button. The constraint status type displays in the **Status** list.

**Note:**

You can transport these constraint status types between models, using the [Export Reference Data](#)<sup>[223]</sup> and [Import Reference Data](#)<sup>[225]</sup> options on the **Tools** menu.

#### 4.10.2.4 Requirement Types

The **Requirement** tab of the **General Types** dialog enables you to specify the generic set of requirement types that can be entered into the requirements sections of dialogs. This helps to maintain a single set of typed requirements.

To access this dialog, select the **Settings | General Types** menu option. Click on the **Requirement** tab.

Requirement:      Description:      Weight: 1

Defined Requirement Types

Name	Description	Weight
Display	System will display in a specific...	1.0
Functional	Functional Requirement	1.0
Performance	Performance based requirement	1.0
Printing	System printing requirement	1.0
Report	The system will produce a report	1.0
Testing	Testing requirement	1.6
Validate	Validate a particular rule	1.0

To add a new requirement type, click on the **New** button and:

- In the **Requirement** field type the name of the requirement type
- In the **Description** field type a short description of the requirement type
- In the **Weight** field type the weighting to apply to the requirement type
- In the **Note** field, type any additional information on the requirement type
- Click on the **Save** button.

The requirement type displays in the **Defined Requirement Types** list.

**Note:**

You can transport these requirement types between models, using the [Export Reference Data](#)<sup>[223]</sup> and [Import Reference Data](#)<sup>[223]</sup> options on the **Tools** menu.

#### 4.10.2.5 Scenario Types

A drop-down list of scenario types is available in the [Scenario](#)<sup>[490]</sup> tab of an element **Properties** dialog, with the standard types *Basic Path*, *Exception* and *Alternate Flow*. You can set additional scenario types using the **Scenario** tab the **General Types** dialog.

To access this dialog, select the **Settings | General Types** menu option. Click on the **Scenario** tab.

Scenario Type: Description: Weight: 1

Defined Scenario Types

Scenario Type	Description	Weight
Alternate	Alternate pathway	1.0
Basic Path	Basic execution path	1.0
Exception	Path if Basic Path fails	1.0

To add a new scenario type, click on the **New** button and:

- In the **Scenario Type** field type the name of the scenario type
- In the **Description** field type a short description of the scenario type
- In the **Weight** field type the weighting to apply to the scenario type
- In the Note field, type any additional information on the scenario type
- All four fields must be completed. Click on the **Save** button.

The scenario displays in the **Defined Scenario Types** list.

**Note:**

You can transport these scenario types between models, using the [Export Reference Data](#)<sup>[223]</sup> and [Import Reference Data](#)<sup>[223]</sup> options on the **Tools** menu.

#### 4.10.2.6 Metrics and Estimation

TCF values, EFC values and Default Hour Rate for a project are controlled from the **Estimation Factors** dialog.

Risk, metric and effort types for a project are controlled from the **Project Indicators** dialog.

For further information on these see the [Project Management](#)<sup>[312]</sup> and [Resource Management](#)<sup>[313]</sup> topics, or specifically:

- [Technical Complexity Factors](#)<sup>[336]</sup>
- [Environment Complexity Factors](#)<sup>[337]</sup>
- [Default Hours](#)<sup>[340]</sup>
- [Effort Types](#)<sup>[319]</sup>
- [Metric Types](#)<sup>[320]</sup>
- [Risk Types](#)<sup>[322]</sup>

### 4.10.3 Maintenance

To control [Testing types](#)<sup>[661]</sup> for your project, select the **Settings | Maintenance** menu option to display the **Maintenance** dialog.

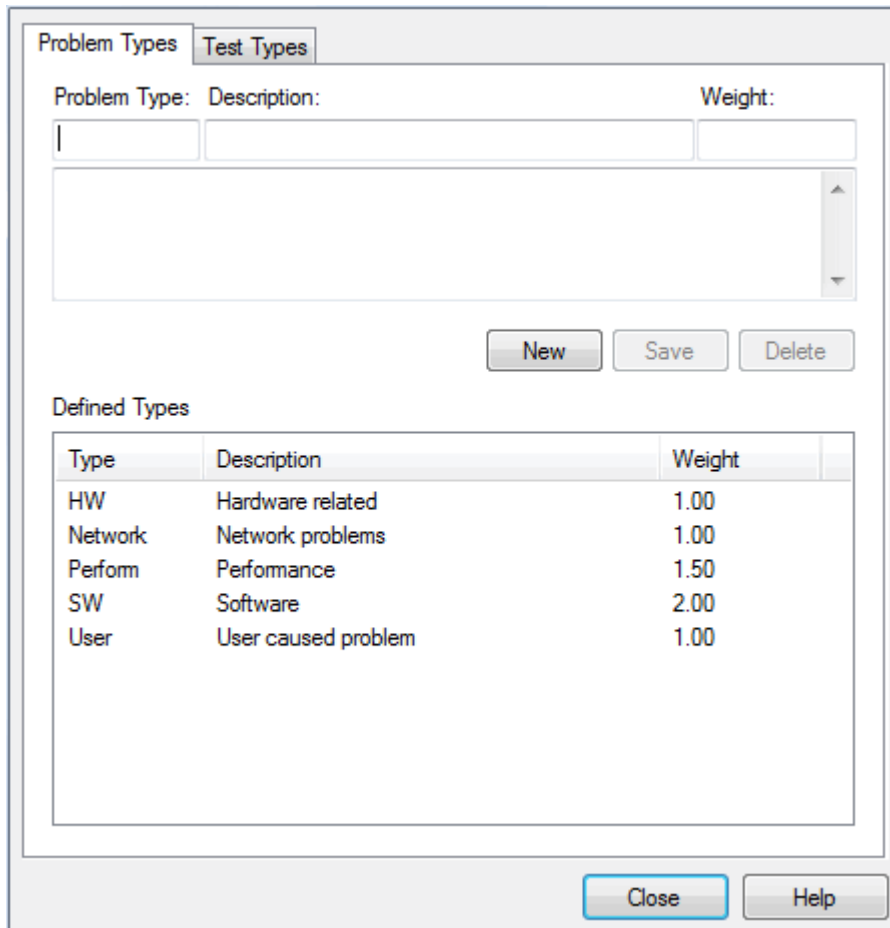

Type	Description	Weight
HW	Hardware related	1.00
Network	Network problems	1.00
Perform	Performance	1.50
SW	Software	2.00
User	User caused problem	1.00

#### 4.10.3.1 Problem Types

**NOT CURRENTLY USED**

For the maintenance and change control screens, you can use the **Maintenance** dialog to set the base *Problem Types* that are handled. Examples are hardware-related issues, performance problems, software bugs and network problems.

To access this dialog, select the **Settings | Maintenance** menu option. The **Maintenance** dialog displays, defaulting to the **Problem Types** tab.



Problem Types | Test Types

Problem Type: Description: Weight:

New Save Delete

Defined Types

Type	Description	Weight
HW	Hardware related	1.00
Network	Network problems	1.00
Perform	Performance	1.50
SW	Software	2.00
User	User caused problem	1.00

Close Help

To add a new problem type, click on the **New** button and:

- In the **Problem Type** field type the name of the problem type
- In the **Description** field type a short description of the problem type
- In the **Weight** field type the weighting to apply to the problem type
- In the **Note** field, type any additional information on the problem type
- Click on the **Save** button.

The problem type displays in the **Defined Types** list.

**Note:**

You can transport these problem types between models, using the [Export Reference Data](#) and [Import Reference Data](#) options on the **Tools** menu. You transport the problem types together with test types as a *Maintenance Types* file.

#### 4.10.3.2 Testing Types

Use the **Test Types** tab of the **Maintenance** dialog to add testing types to the basic set that comes with Enterprise Architect. Typical test types are load tests, performance tests and function tests.

To access this dialog, select the **Settings | Maintenance** menu option. The **Maintenance** dialog displays. Click on the **Test Types** tab.

Problem Types | Test Types

Test Type: | Description: Weight: 1

Defined Types

Name	Description	Weight
Load	Performance under load	1.0
Regression	Regression Testing	1.0
Standard	Simple Test procedure	1.0

To add a new test type, click on the **New** button and:

- In the **Test Type** field type the name of the testing type
- In the **Description** field type a short description of the testing type
- In the **Weight** field type the weighting to apply to the testing type
- In the **Note** field, type any additional information on the testing type
- Click on the **Save** button.

The testing type displays in the **Defined Types** list.

**Note:**

You can transport these test types between models, using the [Export Reference Data](#)<sup>[223]</sup> and [Import Reference Data](#)<sup>[225]</sup> options on the **Tools** menu. You can either export the test types together with the default problem types, as a *Maintenance Types* file, or separately as a *Test Types* file.

#### 4.10.4 UML Types

The **UML Types** dialog enables you to configure [stereotypes](#)<sup>[662]</sup>, [Tagged Value types](#)<sup>[664]</sup> and the [cardinality list](#)<sup>[665]</sup> for your project.

Select the **Settings | UML** menu option to display this dialog.

##### 4.10.4.1 Stereotype Settings

Enterprise Architect has an extensive set of [Standard Element Stereotypes](#)<sup>[899]</sup> that you can [apply](#)<sup>[896]</sup> to any UML construct. Using the **Stereotypes** tab of the **UML Types** dialog, a Technical Developer can also customize the stereotypes for your project by adding, modifying and deleting them. For information on customizing stereotypes, see [Custom Stereotypes](#)<sup>[1093]</sup>

Stereotypes can be modified to make use of metafiles (image files) or customized colors, or to make use of the Enterprise Architect [Shape Scripts](#)<sup>[664]</sup> to make new element shapes to determine the shape and dimensions of the element.

**Note:**

In the Corporate, Business and Software Engineering, System Engineering and Ultimate editions of Enterprise Architect, if security is enabled you must have [Configure Stereotypes](#)<sup>[198]</sup> permission to add, modify or delete stereotypes.

To display the **Stereotypes** tab, select the **Settings | UML** menu option. The **UML Types** dialog displays, showing the **Stereotypes** tab.

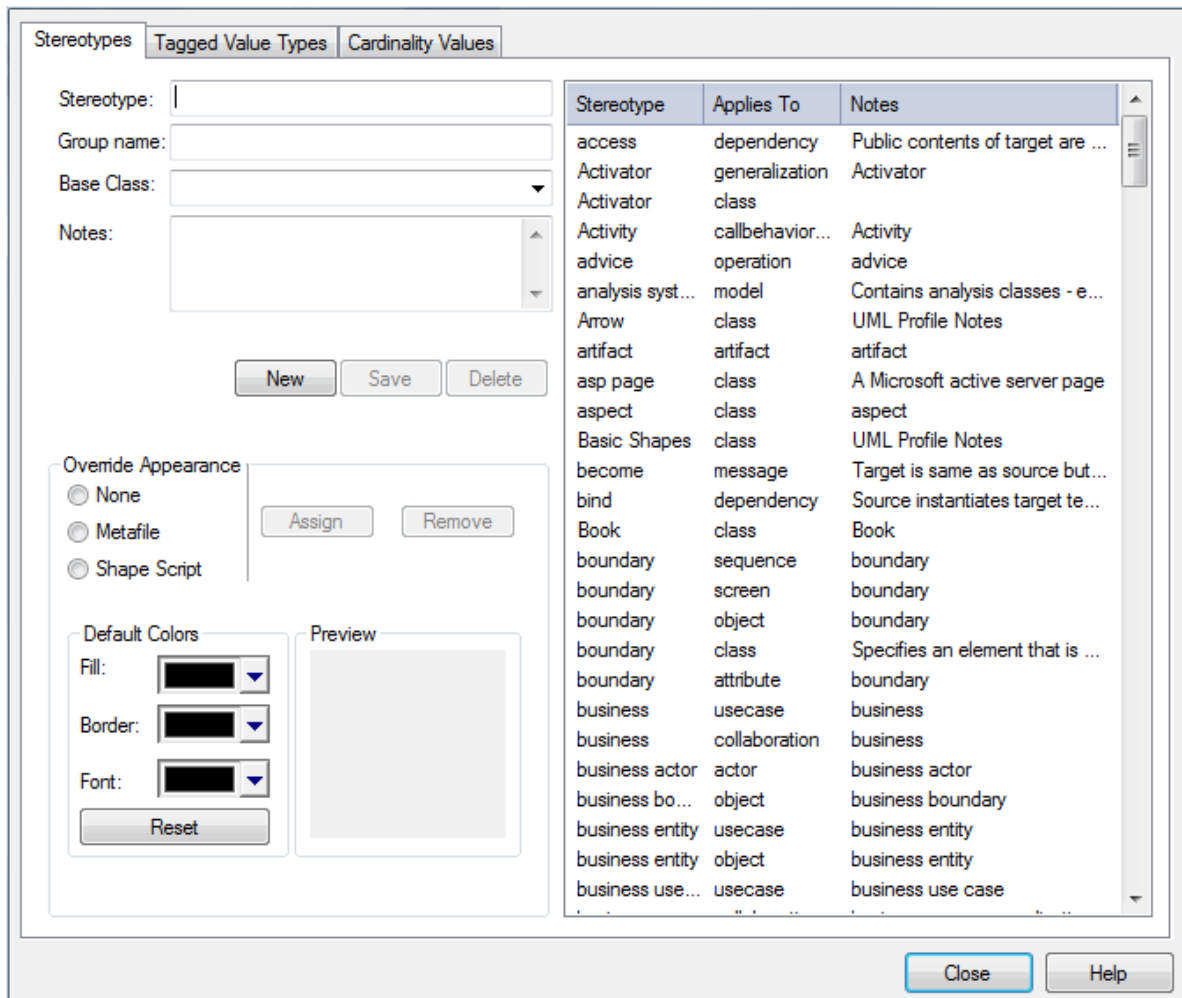

#### 4.10.4.1.1 Shape Editor

The **Shape Editor** enables a Technology Developer to specify custom shapes via a scripting language; that is, to create *Shape Scripts*. These custom shapes are drawn instead of the standard UML notation. Each script is associated with a particular Stereotype, and is drawn for every element of that stereotype.

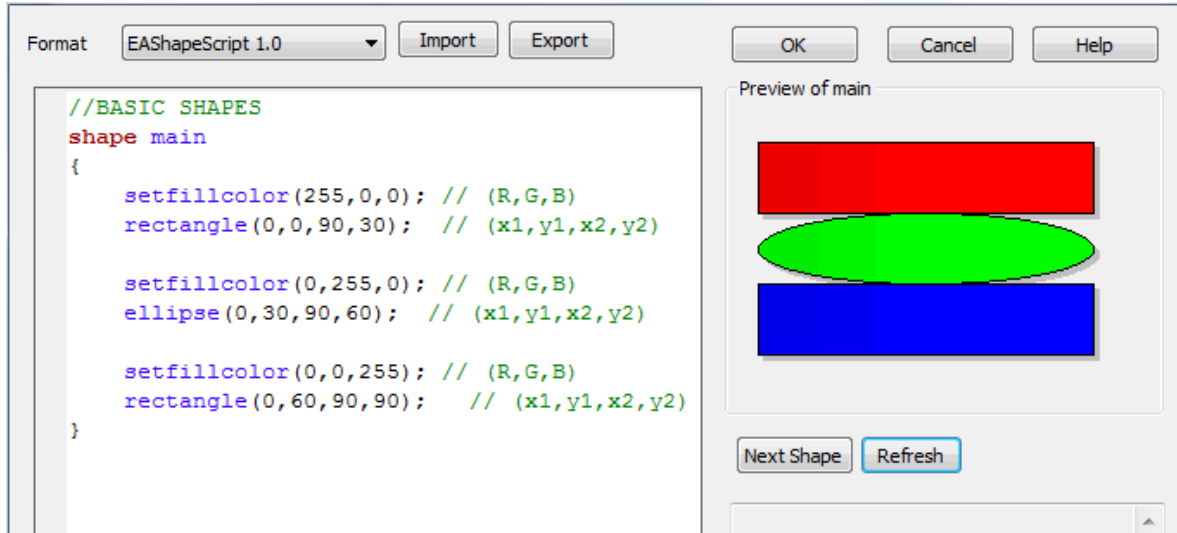

#### Notes:

- Shape Scripts adopt the same color gradient settings as normal elements, as defined in the **Standard Colors** page of the **Options** dialog.
- If an element's appearance is modified by a Shape Script, many of the **Advanced** context menu options for that element are disabled.

For information on creating Shape Scripts, see the [Shape Scripts](#) topic.

#### 4.10.4.2 Tagged Value Types

Tagged Values are used in a variety of places within Enterprise Architect to specify additional information about an element or connector. The **Tagged Value Types** tab of the **UML Types** dialog enables a Technology Developer to rapidly create Tagged Values, using a range of [predefined structured Tagged Values](#) to [create structured tags](#) that adhere to a specific format. For example, for model features that use the *predefined* tag *Boolean* you can use the **Tagged Values** window to assign a value of *True* or *False* and no other value.

You can also add default Tagged Value names and create [predefined reference data Tagged Value types](#) and [custom masked Tagged Value types](#).

Any Tagged Value names created display in the drop-down lists of Tagged Value names in the **Tagged Value** dialogs for elements, operations and attributes. For more information regarding the use of Tagged Values see the [Tagged Values Window](#) topic.

To display the **Tagged Value Types** tab, select the **Settings | UML** menu option to display the **UML Types** dialog, and click on the **Tagged Value Types** tab.

The screenshot shows the 'UML Types' dialog box with the 'Cardinality Values' tab selected. The 'Tag Name' and 'Description' fields are empty. The 'Detail' area is also empty. The 'Defined Tag Types' table is as follows:

Type	Description
Completion Date	
Datafield	Database field
eXPIRY	a
Role	Person role
Software	Software component

For further information on adding and modifying Tagged Values, see [Tagged Value Types](#) <sup>[1168]</sup>.

**Note:**

You can transport these Tagged Value Type definitions between models, using the [Export Reference Data](#) <sup>[223]</sup> and [Import Reference Data](#) <sup>[225]</sup> options on the **Tools** menu. Tagged Value Types are exported as *Property Types*.

#### 4.10.4.3 Cardinality

The **Cardinality Values** tab of the **UML Types** dialog enables you to add, modify and delete values in the default cardinality list.

The cardinality values are used to define the multiplicity of [source](#) <sup>[629]</sup> and [target](#) <sup>[631]</sup> elements in relationships. This is the range of instances of the role that can be active in the relationship; for example, one employee can be assigned to tasks; for the target role you define the range of instances (such as tasks) the employee could be assigned to.

The cardinality values are also used to define the multiplicity of a Classifying element; that is, the number of instances of the element that can exist. For example, the Class element *Building Walls* might have a multiplicity of 2..n, meaning that at least two walls must exist (to support the roof) but there can be many walls if the building design required it.

The values have the following formats:

- \*, or 0..\* - zero, one or many instances
- 0..n - zero or up to n instances, but no more than n
- n - exactly n instances

- **n..\*** - n, or more than n instances.

To access this dialog, select the **Settings | UML** menu option. Click on the **Cardinality Values** tab.

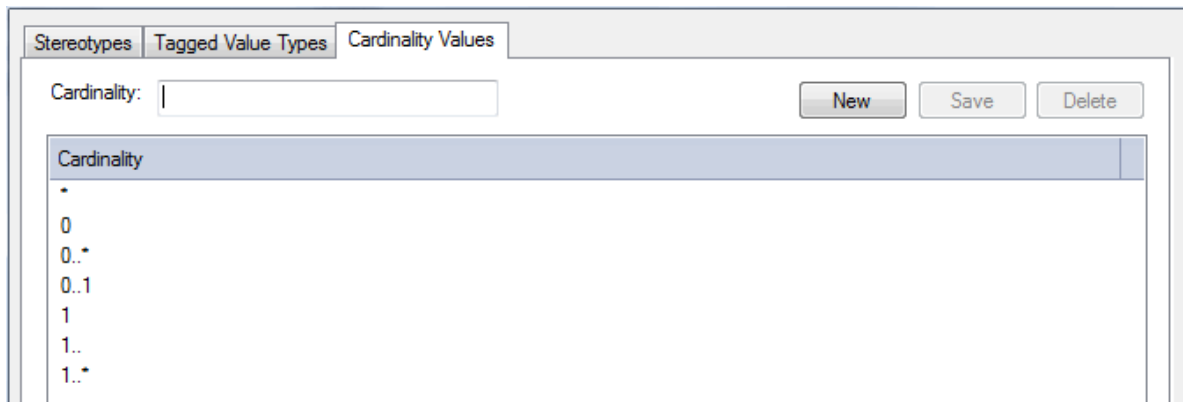

To add a new cardinality value, click on the **New** button. To modify an existing value, click on it in the **Cardinality** list.

In the **Cardinality** field, type the required cardinality value. Click on the **Save** button.

**Note:**

You can transport these cardinality values between models, using the [Export Reference Data](#)<sup>[223]</sup> and [Import Reference Data](#)<sup>[223]</sup> options on the **Tools** menu.

#### 4.10.4.4 Data Types

Different programming languages support different inbuilt data types. The **Programming Languages Datatypes** dialog enables you to extend and manage the set of inbuilt data types associated with a language as well as create new programming languages for use within Enterprise Architect.

**Notes:**

- In the Corporate, Business and Software Engineering, System Engineering and Ultimate editions of Enterprise Architect, if security is enabled you must have [Configure Datatypes](#)<sup>[198]</sup> permission to update and delete data types.
- You can delete data types that you have defined, but you cannot delete any of the predefined data types.

To access this dialog, select the **Settings | Code Datatypes** menu option.

Product Name:

Datatype:

Common Type:

Size

None      Default:       Max:

Length           

Precision & Scale           

Defined Datatypes for Programming Languages                 

Product	Datatype	Size Unit	Default	Max
Java	boolean			
Java	byte			
Java	char			
Java	double			
Java	float			
Java	int			
Java	long			
Java	short			

Option	Use to
<b>Product Name</b>	Specify the name of the programming language.
<b>Add Product</b>	Add a new programming language to the drop-down fields for Class elements within the Enterprise Architect model and enable the new language to be made available to the <a href="#">Code Template Editor</a> <sup>[1305]</sup> once at least one datatype has been added to the language.
<b>Datatype</b>	Specify the name of the datatype; this is the language-specific name of the datatype.
<b>Common Type</b>	Specify the common type, the generic name of the datatype; for example, the Java <i>boolean</i> datatype has a common datatype <i>Boolean</i> .
<b>New</b>	Create a new data type.
<b>Save</b>	Save the newly created datatype.
<b>Delete</b>	Delete the selected datatype.

**Note:**

You can transport these data types between models, using the [Export Reference Data](#) <sup>[223]</sup> and [Import Reference Data](#) <sup>[225]</sup> options on the **Tools** menu.

## 4.10.5 Resources

Access: **View | Other Project Tools | Resources.**

The **Resources** window displays a tree of Technologies, Templates, Documents, UML Profiles and Patterns, commonly-used model elements and Matrix profiles. This view provides useful shortcuts and re-use functions that you can use to add stock elements to the current model, and patterns and elements for additional information.

**Tip:**

In the Corporate, Business and Software Engineering, Systems Engineering and Ultimate editions of Enterprise Architect, if security is enabled you must have [Configure Resources](#) [198] permission to maintain **Resources** window items.

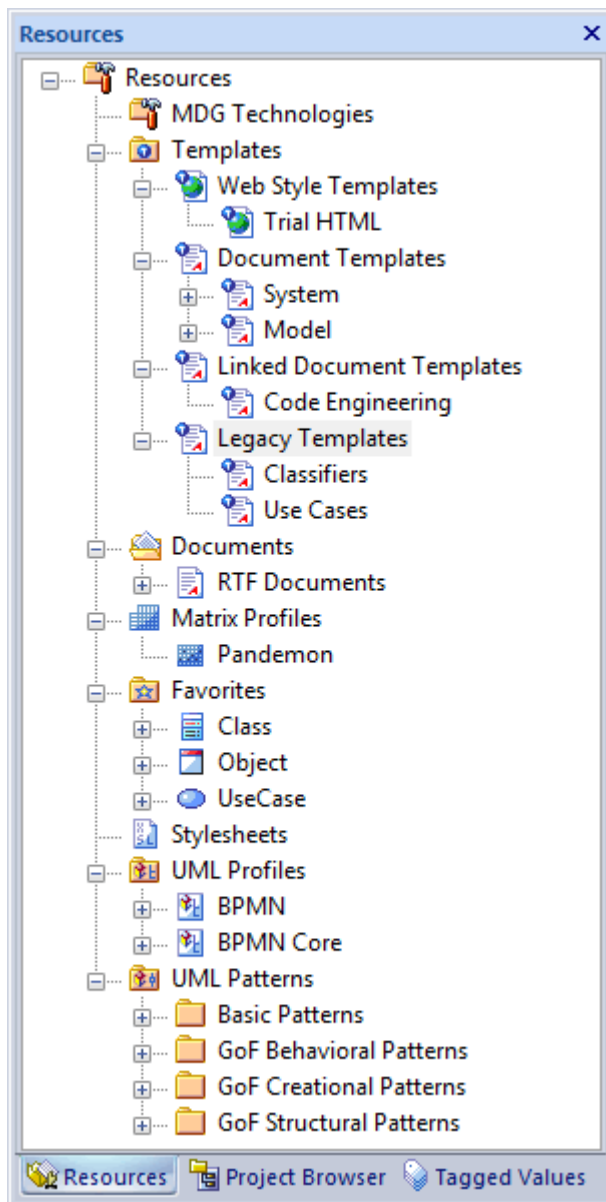

- [MDG Technologies](#) [1066], [UML Profiles](#) [906] and [UML Patterns](#) [901] provide a convenient way to insert complex new elements and features without having to retype or reconfigure each element

**Note:**

From release 7.5 of Enterprise Architect, the method of importing MDG Technologies into the **Resources** window is available but *not recommended*. However, you might previously have imported Technologies into the **Resources** window, and these are still available until you specifically delete them (right-click on the Technology and select the **Delete Technology** context menu option).

You can also [synchronize](#) [910] the Tagged Values and constraints for any elements created from a profile element in the **Resources** window.

- **Templates** provides a range of templates for creating [HTML \(web\)](#) [1649] reports, [RTF](#) [1569] reports in either the [legacy report generator](#) [1628] or the [extended RTF report generator](#) [1570], [linked documents](#) [597] and MDG Technology reports; you can create, edit, copy and delete your own templates, and view and copy system-



supplied or technology-supplied templates using context menu options

- **Documents** <sup>[1568]</sup> provides a shortcut to saved RTF documents

**Tip:**

To add a document to the shortcut list, select the **Project | Documentation | Rich Text Format (RTF) Report** menu option. Once you have defined your document click on the **Resource Document** button and type in a name. The document name then displays in the **Resources** window. By [right-clicking on the document name](#) <sup>[1608]</sup> you can regenerate documents individually or as a batch, or open them directly from Enterprise Architect.

- **Matrix Profiles** <sup>[1267]</sup> provides quick access to saved **Relationship Matrix** profiles; double-click on a profile to load the matrix with the saved settings and source-target packages
- **Favorites** <sup>[669]</sup> provides a shortcut to elements that you configure as a shortcut
- **Stylesheets** enables you to import XSL Style sheets, which are then available in the drop-down list on the **XML Export** dialog.

**Note:**

If you select a style sheet on export, Enterprise Architect applies that style sheet to the XMI generated before saving to file. This makes it convenient to generate other forms of output from the base XMI content. Combined with UML Profiles, this is a powerful means of extending Enterprise Architect to generate almost any content required.

#### 4.10.5.1 Favorites

The **Resources** window contains a *Favorites* folder. Here you can hyperlink to any UML element from the model as a whole, and conveniently drag and drop instances or links to this element into other diagrams. This is particularly useful where certain elements - such as the list of Actors in a system - are re-used again and again, and switching to the *Actors* folder is not convenient. In cases like this, using the Favorites folder makes managing and creating your model much easier.

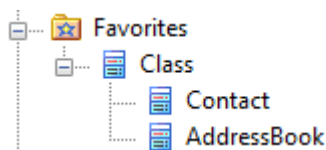

### Modify the Favorites Folder

#### Add to the Favorites Folder

To add an element to the Favorites folder:

- In a diagram, right-click on the element to add.
- From the context menu select the **Find | Add to Favorites** option.
- Switch back to the **Resources** window and check the Favorites folder; the new element should be listed in its category within the favorites.

#### Delete from the Favorites Folder

To delete a favorite:

- Right-click on it within the Favorites folder in the **Resources** window.
- Select **Delete Favorite** from the context menu.
- Confirm the action by clicking on the **Yes** button.

#### View Properties of a Favorite

To view a favorite's properties from the Favorites folder:

- Select and right-click on the favorite in the **Resources** window.
- Select **Element Properties** from the context menu.

**Part**

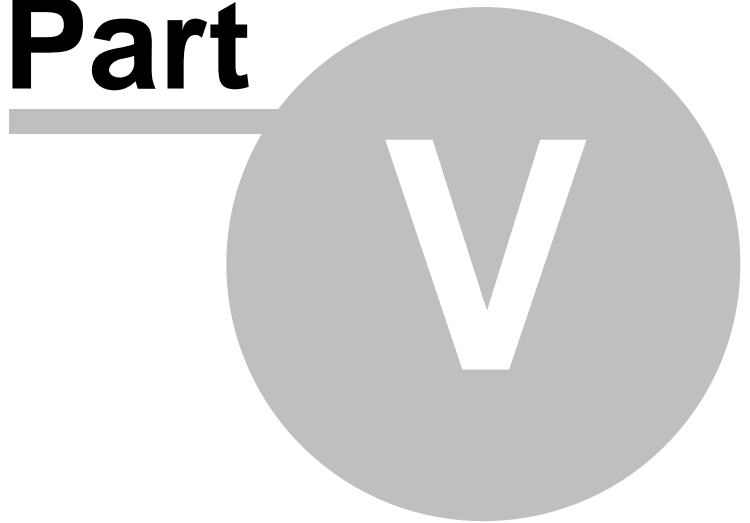

## 5 Modeling Languages



Enterprise Architect is a UML-based modeling tool. However, it strongly supports modeling with extensions to UML and with other existing modeling languages, and enables you to create your own modeling tools as MDG Technologies.

For information on the modeling languages and facilities supported, see:

- [Standard UML Models](#)<sup>[672]</sup>
- [Specialized UML Models](#)<sup>[917]</sup>
- [Build Your Own Modeling Language.](#)<sup>[1092]</sup>

## 5.1 Standard UML Models



### The Unified Modeling Language (UML)

Enterprise Architect's modeling platform is based on the Unified Modeling Language (UML) 2.3, a standard that defines rules and notations for specifying business and software systems. The notation supplies a rich set of graphic elements for modeling object oriented systems, and the rules state how those elements can be connected and used. UML is not a tool for creating software systems; instead, it is a visual language for communicating, modeling, specifying and defining systems.

UML is not a prescriptive process for modeling software systems; it does not supply a method or process, simply the language. You can therefore use UML in a variety of ways to specify and develop your software engineering project. This language is designed to be flexible, extendable and comprehensive, yet generic enough to serve as a foundation for all system modeling requirements. With its specification, there is a wide range of elements characterized by the kinds of diagrams they serve, and the attributes they provide. All can be further specified by using stereotypes, Tagged Values and profiles. Enterprise Architect supports many different kinds of UML elements (as well as some custom extensions). Together with the connectors between elements, these form the basis of the model.

See:

- [UML Diagrams](#) <sup>[673]</sup>
- [UML Elements](#) <sup>[741]</sup>
- [UML Connectors](#) <sup>[852]</sup>

### Wide Range of Applications

Although initially conceived as a language for software development, UML can be used to model a wide range of real world domains and processes (in business, science, industry, education and elsewhere), organizational hierarchies, deployment maps and much more. Enterprise Architect also provides additional custom diagrams and elements, to address further modeling interests. This topic is intended to provide an introduction to Enterprise Architect's diagrams, elements and connectors, and its [modeling process](#) <sup>[370]</sup>. It also illustrates its alignment, when applicable, to the Unified Modeling Language.

### Extending UML for New Domains

Using [UML Profiles](#) <sup>[906]</sup>, [UML Patterns](#) <sup>[907]</sup>, Grammars, Data Types, Constraints and other extensions, UML and Enterprise Architect can be tailored to address a particular modeling domain not explicitly covered in the original UML specification. Enterprise Architect makes extending UML simple and straightforward and, best of all, the extension mechanism is still part of the UML Specification.

### Find Out More

UML is an open modeling standard, defined and maintained by the Object Management Group. Further information, including the full UML 2.3 documentation, can be found on the OMG website at <http://www.omg.org>.

#### Tip:

If you are unfamiliar with UML, please explore the topics in this section, the Diagram [Toolbox](#) <sup>[399]</sup> descriptions, and the *EAXample* project supplied with Enterprise Architect. The online [UML Tutorial](#) (parts 1 and 2) and [UML 2.0 Tutorial](#) are also very helpful.

#### Recommended Reading:

In addition to the UML Specification available from the OMG, two books that provide excellent introductions to UML are:

- *Schaum's Outlines: UML* by Bennet, Skelton and Lunn. Published by McGraw Hill.

ISBN 0-07-709673-8

- *Developing Software with UML* by Bern Oestereich. Published by Addison Wesley. ISBN 0-201-36826-5

## 5.1.1 UML Diagrams

### What is a UML Diagram?

A UML diagram is a representation of the components or elements of a system or process model and, depending on the type of diagram, how those elements are connected or how they interact from a particular perspective. For example, how and why an object changes state, or how requirements are realized by the process or a system.

### Types of Diagram

There are two major groupings of UML diagrams:

- [Structural Diagrams](#)<sup>[719]</sup> which depict the structural elements composing a system or function, reflecting the static relationships of a structure, or run-time architectures.
- [Behavioral Diagrams](#)<sup>[673]</sup> which show a dynamic view of the model, depicting the behavioral features of a system or business process.

Enterprise Architect provides the following additional diagram types that *extend* the core UML diagrams for business process modeling, formal requirements specifications and other domain-specific models:

- [Analysis](#)<sup>[733]</sup> diagrams
- [Custom](#)<sup>[734]</sup> diagrams
- [Requirements](#)<sup>[736]</sup> diagrams
- [Maintenance](#)<sup>[737]</sup> diagrams
- [User Interface](#)<sup>[738]</sup> diagrams
- [Database](#)<sup>[739]</sup> diagrams
- [Business Modeling and Business Interaction](#)<sup>[739]</sup> diagrams.

Enterprise Architect also supports diagram types specific to [MDG Technologies](#)<sup>[1065]</sup>, including integrated technologies such as [Archimate](#)<sup>[1073]</sup>, [BPMN](#)<sup>[952]</sup>, [Data Flow Diagrams](#)<sup>[1076]</sup>, [Eriksson-Penker Extensions](#)<sup>[1080]</sup>, [ICONIX](#)<sup>[1084]</sup> and [Mind Mapping](#)<sup>[1087]</sup>.

### Work with Diagrams

Diagrams are developed in the main workspace in which you create and connect model elements. You create them by right-clicking a package and selecting the **New Diagram** context menu option, or load them by double-clicking their diagram icon in the **Project Browser**.

For full details on how to work with diagrams, see [Diagram Tasks](#)<sup>[421]</sup>.

#### 5.1.1.1 Behavioral Diagrams

Behavioral diagrams depict the behavioral features of a system or business process. Behavioral diagrams include the following diagram types:

#### Activity Diagrams

[Activity diagrams](#)<sup>[674]</sup> model the behaviors of a system, and the way in which these behaviors are related in an overall flow of the system.

#### Use Case Diagrams

[Use Case diagrams](#)<sup>[676]</sup> capture Use Cases and relationships among Actors and the system; they describes the functional requirements of the system, the manner in which external operators interact at the system boundary, and the response of the system.

## State Machine Diagrams

[State Machine diagrams](#)<sup>[678]</sup> illustrate how an element can move between states, classifying its behavior according to transition triggers and constraining guards.

## Timing Diagrams

[Timing diagrams](#)<sup>[690]</sup> define the behavior of different objects within a time-scale, providing a visual representation of objects changing state and interacting over time.

## Sequence Diagrams

[Sequence diagrams](#)<sup>[706]</sup> are structured representations of behavior as a series of sequential steps over time. They are used to depict work flow, message passing and how elements in general cooperate over time to achieve a result.

## Communication Diagrams

[Communication diagrams](#)<sup>[715]</sup> show the interactions between elements at run-time, visualizing inter-object relationships.

## Interaction Overview Diagrams

[Interaction Overview diagrams](#)<sup>[717]</sup> visualize the cooperation between other interaction diagrams (Timing, Sequence, Communication and Interaction Overview diagrams) to illustrate a control flow serving an encompassing purpose.

### See Also

- [Behavioral Modeling](#)<sup>[569]</sup>
- [Code Generation from Behavioral Models](#)<sup>[1314]</sup>

### 5.1.1.1.1 Activity Diagram

*Activity diagrams* are used to model the behaviors of a system, and the way in which these behaviors are related in an overall flow of the system.

The logical paths a process follows, based on various conditions, concurrent processing, data access, interruptions and other logical path distinctions, are all used to construct a process, system or procedure.

#### Note:

You can create [Analysis diagrams](#)<sup>[733]</sup> (Simplified Activity), containing the elements most useful for business process modeling, using the [New Diagram](#)<sup>[422]</sup> dialog.

## Example Diagram

The following diagram illustrates some of the features of Activity diagrams, including Activities, Actions, Start Nodes, End Nodes and Decision points.

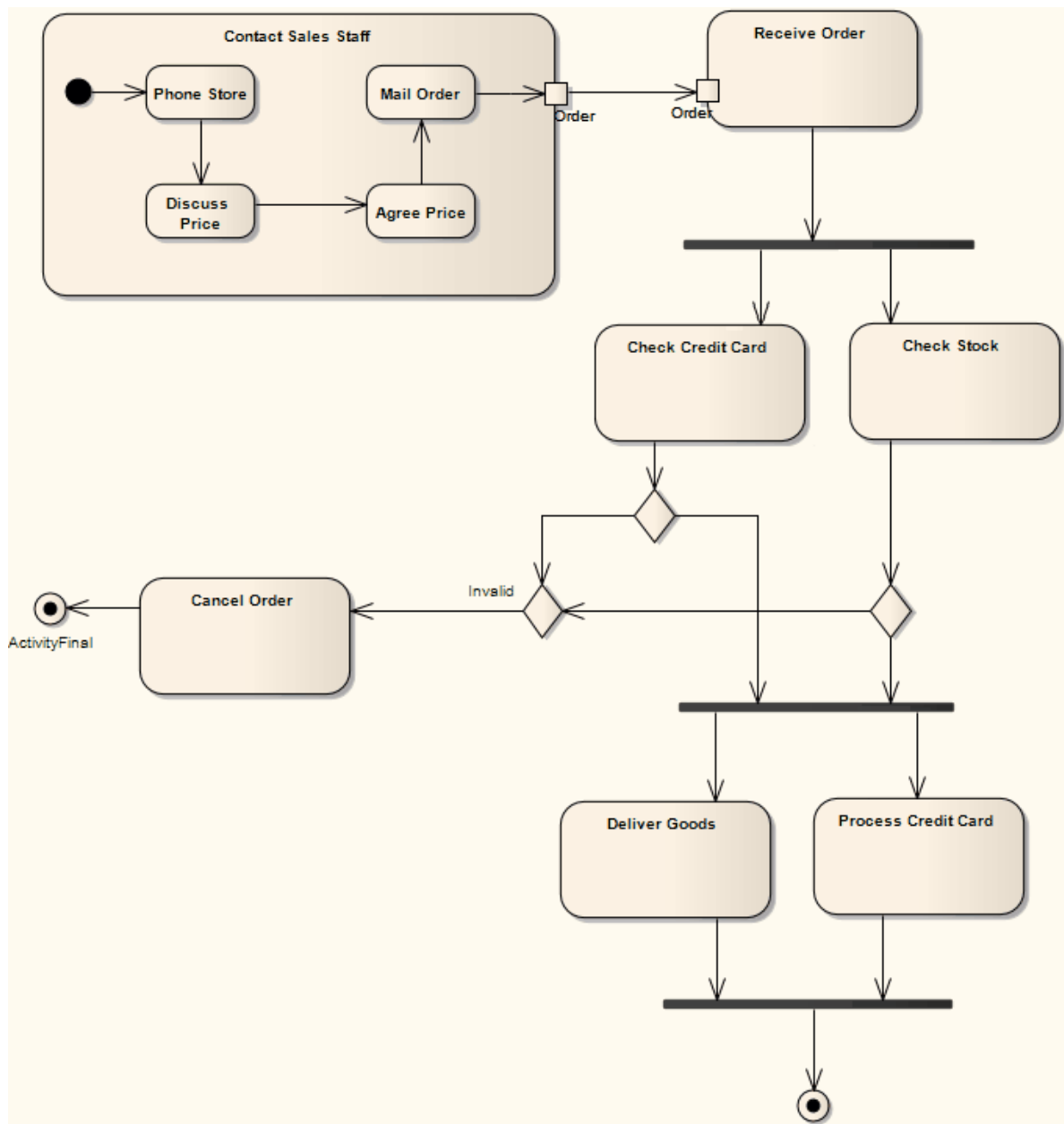

### Toolbox Elements and Connectors

Select Activity diagram elements and connectors from the [Activity](#) <sup>[412]</sup> [pages](#) <sup>[412]</sup> of the **Toolbox**.

**Tip:**

Click on the following elements and connectors for more information.

Activity Diagram Elements	Activity Diagram Connectors
Activity	Control Flow
Structured Activity	Object Flow
Action	Interrupt Flow

Activity Diagram Elements	Activity Diagram Connectors
 Partition	
 Object	
 Central Buffer Node	
 Datastore	
 Decision	
 Merge	
 Send	
 Receive	
 Synch	
 Initial	
 Final	
 Flow Final	
 Region	
 Exception	
 Fork/Join	
 Fork/Join	

### 5.1.1.1.2 Use Case Diagram

A *Use Case* diagram captures Use Cases and relationships between Actors and the subject (system). It describes the functional requirements of the system, the manner in which outside things (Actors) interact at the system boundary, and the response of the system.

In developing a Use Case diagram, also consider:

- [Use Case Extension Points](#)<sup>[807]</sup>
- [Use Rectangle Notation](#)<sup>[808]</sup>
- [Business Use Case](#)<sup>[739]</sup> (stereotyped Use Case)

### Example Diagram

The following diagram illustrates some features of Use Case diagrams:



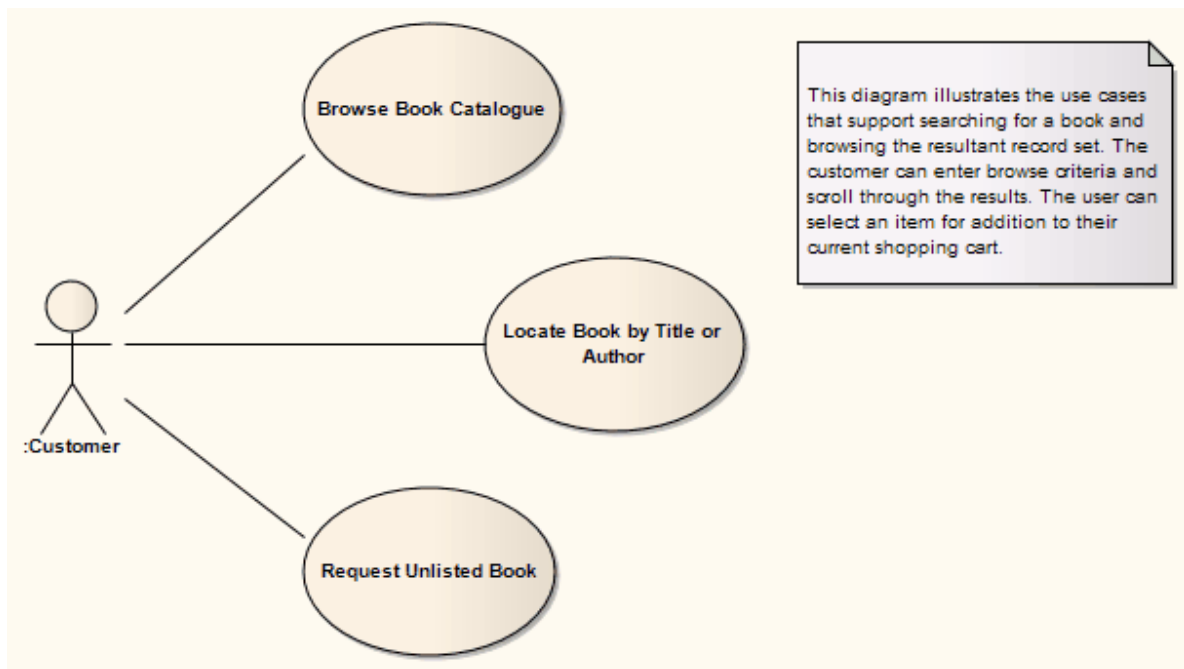

## Toolbox Elements and Connectors

Select Use Case diagram elements and connectors from the [Use Case](#) <sup>[406]</sup> [pages](#) <sup>[406]</sup> of the [Toolbox](#).

### Tip:

Click on the following elements and connectors for more information.

Use Case Diagram Elements	Use Case Diagram Connectors
Actor	Use
Use Case	Associate
Test Case	Generalize
Collaboration	Include
Boundary	Extend
Package	Realize
	Invokes
	Precedes

### Note:

*Invokes* and *Precedes* relationships are defined by the Open Modeling Language (OML). They are stereotyped *Dependency* relationships; *Invokes* indicates that Use Case A, at some point, causes Use Case B to happen, whilst *Precedes* indicates that Use Case C must complete before Use Case D can begin.

### 5.1.1.1.3 State Machine Diagrams

**Note:**

State Machine diagrams were formerly known as State diagrams.

A *State Machine* diagram illustrates how an element (often a Class) can move between states, classifying its behavior according to transition triggers and constraining guards. Other aspects of State Machine diagrams further depict and explain movement and [behavior](#)<sup>[573]</sup>.

For information on code generation from State Machine diagrams, see the [SW Code Generation - State Machine Diagrams](#)<sup>[1316]</sup> and [State Machine Modeling for HDLs](#)<sup>[1319]</sup> topics.

State Machine representations in UML are based on the *Harel State Chart Notation* (see the *OMG UML Superstructure Specification 2.1.1, section 15.1*), and therefore are sometimes referred to as *State Charts*.

You can display a State Machine as a diagram (as below) or as a [table](#)<sup>[682]</sup> in one of three relationship formats. In all formats, you use the same [Toolbox elements and connectors](#)<sup>[411]</sup>.

To select the display format, follow the steps below:

1. Right-click on the diagram background to display the context menu.
2. Select the **Statechart Editor** option.
3. Select the appropriate display option:
  - **Diagram**
  - **Table (State-Next State)**
  - **Table (State-Trigger)**
  - **Table (Trigger-State)**.

### Example Diagram

The following diagram illustrates some features of State Machine diagrams. The *Saved State* is a [Composite](#)<sup>[790]</sup> State, and enclosed States are [sub-states](#)<sup>[790]</sup>. Initial and final [pseudo-states](#)<sup>[682]</sup> indicate the entry to and exit from the State Machine. Composite States and sub-states are both [State](#)<sup>[789]</sup> elements, a Composite State being an expanded State element that encloses other State elements, which are then referred to as sub-states. Composite States and State Machines can also contain [Regions](#)<sup>[681]</sup>.

**Note:**

State elements can display either with or without a line across them. The line - as shown below - displays when the element has features such as attributes (which could be hidden) or when the [Show State Compartment](#)<sup>[362]</sup> checkbox is selected in the **Objects** page of the **Options** dialog.

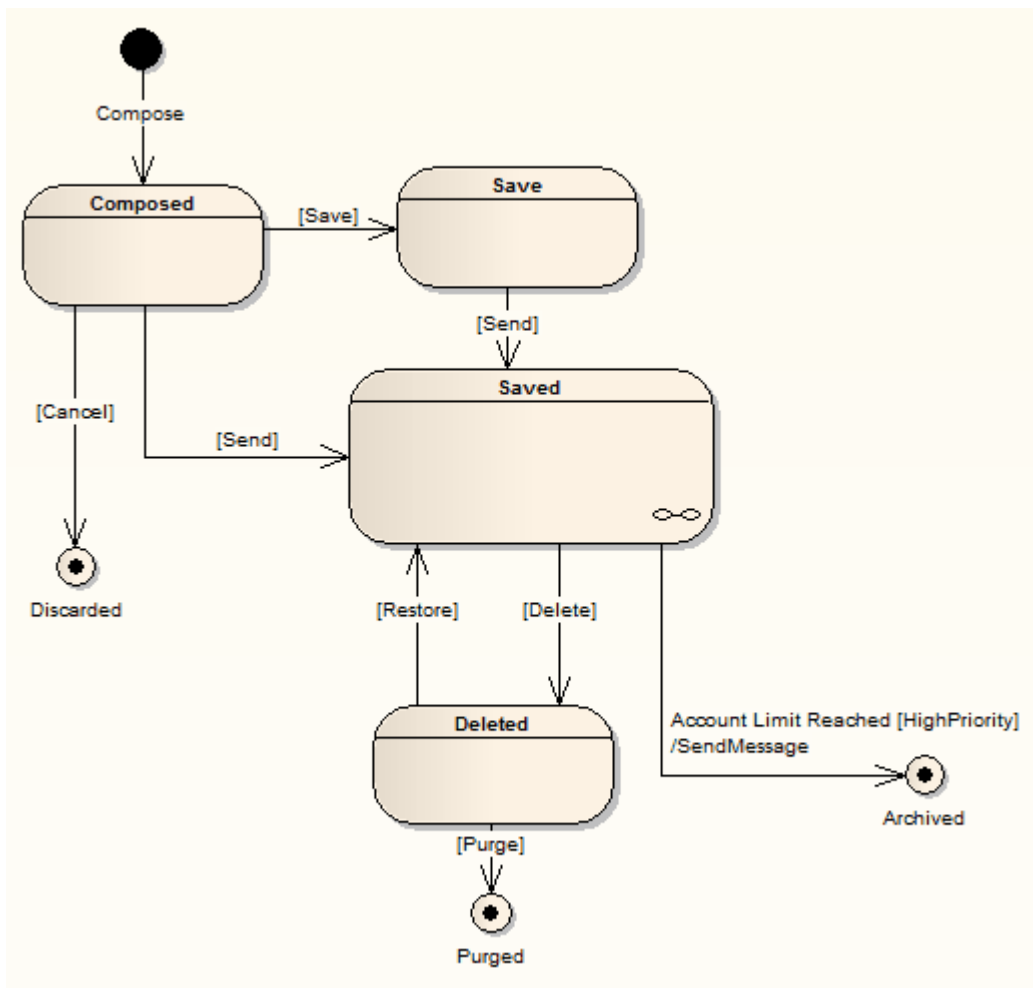

You have two options for exposing the contents of a composite State, such as *Saved*. Firstly, you can double-click on the element to display its child diagram separately, as shown below:

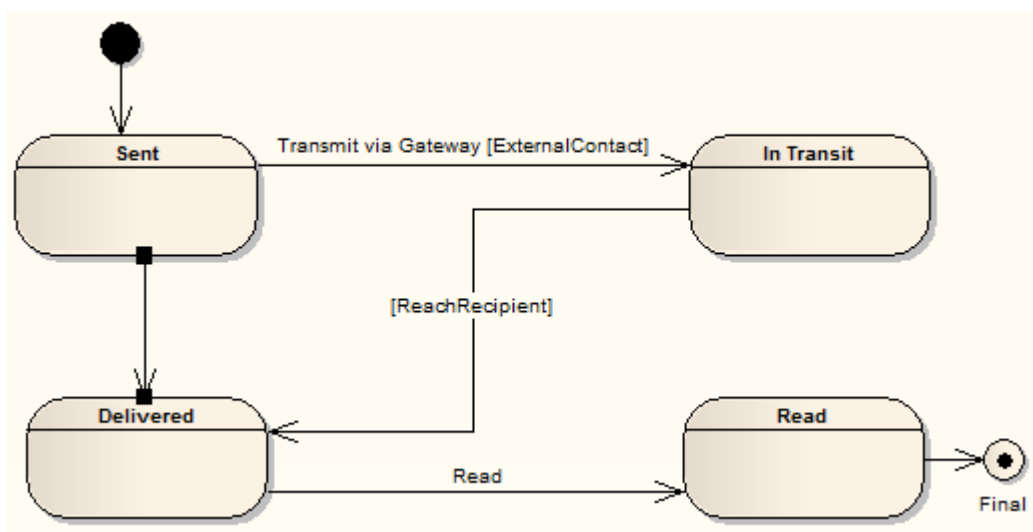

Alternatively, you can right-click on the composite element and select the **Advanced | Show Composite Diagram** context menu option, which displays the child diagram in the context of the parent diagram.

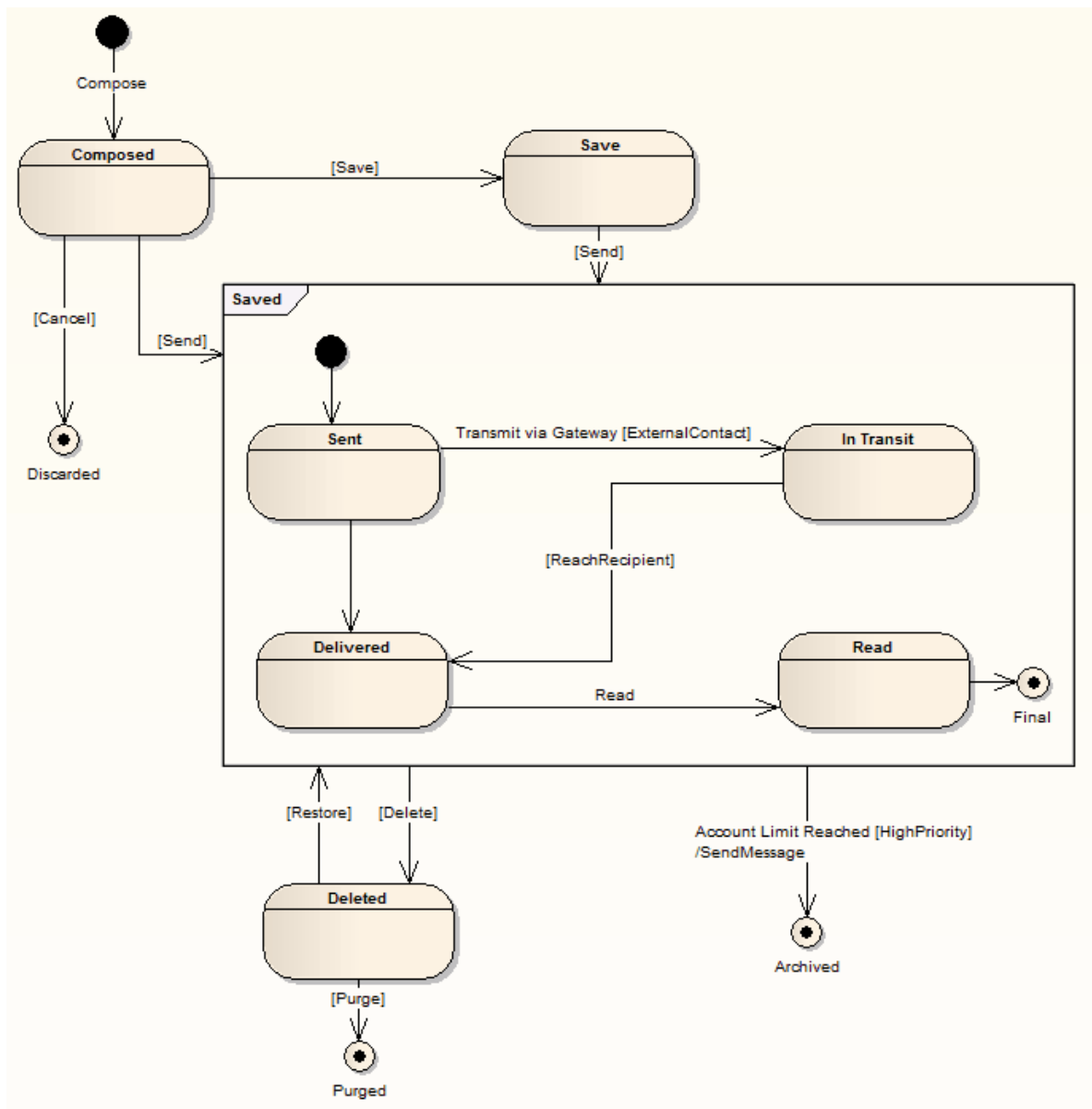

















### Toolbox Elements and Connectors

Select State Machine diagram elements and connectors from the [State](#) <sup>[41]</sup> [pages](#) <sup>[41]</sup> of the **Toolbox**.

#### Tip:

Click on the following elements and connectors for more information.

State Machine Diagram Elements	State Machine Diagram Connectors
 State	 Transition
 State Machine	 Object Flow
 Initial	

State Machine Diagram Elements	State Machine Diagram Connectors
 Final	
 History	
 Synch	
 Object	
 Choice	
 Junction	
 Entry	
 Exit	
 Terminate	
 Fork/Join	
 Fork/Join	

### OMG UML Specification

The OMG UML specification (*UML Superstructure Specification, v2.1.1, Section 15.3.12, p. 560*) states:

*A state machine owns one or more regions, which in turn own vertices and transitions.*

*The behiored classifier context owning a state machine defines which signal and call triggers are defined for the state machine, and which attributes and operations are available in activities of the state machine. Signal triggers and call triggers for the state machine are defined according to the receptions and operations of this classifier.*

*As a kind of behavior, a state machine may have an associated behavioral feature (specification) and be the method of this behavioral feature. In this case the state machine specifies the behavior of this behavioral feature. The parameters of the state machine in this case match the parameters of the behavioral feature and provide the means for accessing (within the state machine) the behavioral feature parameters.*

*A state machine without a context classifier may use triggers that are independent of receptions or operations of a classifier, i.e. either just signal triggers or call triggers based upon operation template parameters of the (parameterized) state machine.*

#### 5.1.1.3.1 Regions

Regions can be created in [Composite States](#)<sup>[790]</sup> or [State Machines](#)<sup>[789]</sup> on a [State Machine diagram](#)<sup>[678]</sup>.

Regions indicate concurrency, such that a single State is active in each region. Multiple transitions can occur from a single event dispatch, so long as similarly triggered transitions are divided by Regions.

To create a Region in a Composite State or State Machine element, follow the steps below:

1. Right-click on the element, and select the **Advanced | Define Concurrent Substates** context menu option. The **State Regions** dialog displays.

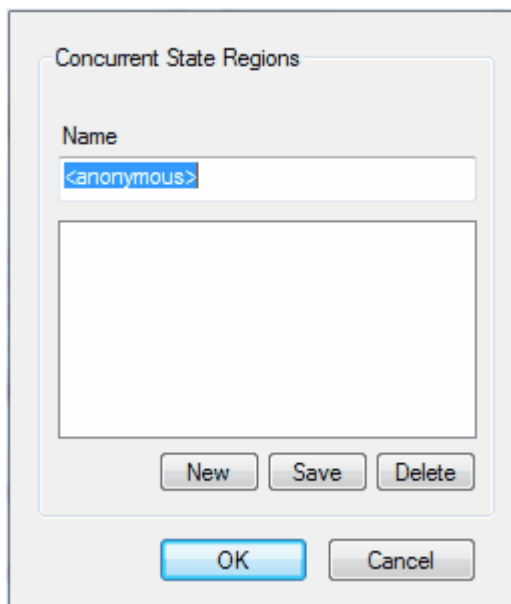

2. Create the Regions of a State, which can be named or anonymous.
3. Click on the **OK** button.

### OMG UML Specification

The OMG UML specification (*UML Superstructure Specification, v2.1.1, p. 544*) states:

*A region is an orthogonal part of either a composite state or a state machine. It contains states and transitions.*

#### 5.1.1.1.3.2 Pseudo-States

*Pseudo-states* are a UML 2.3 abstraction for various types of transient vertices used in [State Machine](#)<sup>[678]</sup> diagrams. Pseudo-states are used to express complex transition paths. The following types of pseudo-state are available:

- [Initial](#)<sup>[778]</sup>
- [Entry Point](#)<sup>[769]</sup>
- [Exit Point](#)<sup>[771]</sup>
- [Choice](#)<sup>[758]</sup>
- [Junction](#)<sup>[782]</sup>
- [History](#)<sup>[777]</sup>
- [Terminate](#)<sup>[804]</sup>
- [Final](#)<sup>[772]</sup>
- [Fork](#)<sup>[775]</sup>
- [Join](#)<sup>[776]</sup>

### OMG UML Specification

The OMG UML specification (*UML Superstructure Specification, v2.1.1, p. 536*) states:

*A pseudostate is an abstraction that encompasses different types of transient vertices in the state machine graph... Pseudostates are typically used to connect multiple transitions into more complex state transitions paths. For example, by combining a transition entering a fork pseudostate with a set of transitions exiting the fork pseudostate, we get a compound transition that leads to a set of orthogonal target states.*

#### 5.1.1.1.4 State Machine Table

A *State Machine table* is one of two variants of a State Machine (the other is the [State Machine diagram](#))<sup>[678]</sup>. It displays the information of the State Machine in table form, and is a method of specifying the discrete behavior of a finite state-transition system; that is, what state the State Machine moves to and the conditions under which the transition takes place.

You can display the state transition as one of two different relationships:

- **State - Trigger:** The rows indicate the current states and the columns indicate trigger events (or the other way around if you prefer, in a **Trigger - State** format). The cell at the intersection of a row and column identifies the target state in the transition if the trigger occurs, and the condition (or guard) of the transition.

State \ Trigger		Event1	Event2	Event3	Event4	<None>
		E0	E1	E2	E3	E4
Initial	S0					S1
State1	S1				S2	
State2	S2	S6	<u>[Guard]</u> S4			
	SubState1	S3	S4			
	SubState2	S4		<u>[Cond]</u> S2		
	SubState3	S5				
State3	S6					S7
Final	S7					

- **State - Next State:** The rows and columns both indicate states, and the cell at the intersection of a row and column indicates the event that triggers a transition from the current (row) state to the next (column) state, the condition (or guard) of the event, and the effect of the transition.

Next State		Initial	State 1	State2			State3	Final	
					SubState1	SubState2			SubState3
State		S0	S1	S2	S3	S4	S5	S6	S7
Initial	S0		_____						
State 1	S1			Event4 _____					
State2	S2					Event2 [Guard] _____		Event1 _____	
	SubState1	S3				Event2 _____			
	SubState2	S4			Event3 [Cond] _____				
	SubState3	S5							
State3	S6							_____	
Final	S7								

## Select Format

You can display a State Machine as a diagram or table, and as a table in one of three relationship formats.

To select the display format, follow the steps below:

1. Right-click on the diagram background to display the context menu.
2. Select the **Statechart Editor** option.
3. Select the appropriate display option:
  - **Diagram**
  - **Table (State-Next State)**
  - **Table (State-Trigger)**
  - **Table (Trigger-State)**

To define the State Machine Table further, see:

- [State Machine Table Options](#)<sup>[684]</sup>
- [State Machine Table Operations](#)<sup>[686]</sup>

### 5.1.1.1.4.1 State Machine Table Options

You can choose the [State Machine table](#)<sup>[682]</sup> layout and set other options from the **State Machine Diagram: Options** dialog, which you display by either:

- Double-clicking on the State Machine table background or
- Right-clicking on the background and selecting the **State Table Options** context menu option.



Table Format: State - Next State

**Cell Size**

Transition Cell Width:

Transition Cell Height:

Left Edge Cell Width:

Top Edge Cell Height:

**Display Options**

Always Display an Empty State Zone

Enable State Enumeration  
Prefix:

Enable Event Enumeration  
Prefix:

**Cell Color**

State/Trigger Cell:

State/Trigger Enumeration:

Transition Cell:

**Sample State Table**

		Trigger		
		Trigger0	Trigger1	Trigger2
State	State	E0	E1	E2
	State0	P0		
State1	P1		P2	
State2	P2			

**Highlight Options**

Highlight Zones Related to Selected Transition

Highlight Color:

Use Different Color for Target State

Target Zone Color:

Advanced...
Restore Defaults
Apply
OK
Cancel
Help

Option	Use to
<b>Table Format</b>	Select the required table format: <ul style="list-style-type: none"> <li><b>State - Trigger:</b> rows represent States, each state name in a left edge cell; columns represent Triggers, each trigger name in a column header cell; the intersection of a row and column identifies the Transition (if there is one); the Transition cell displays information about the next State and the condition (guard) of the Transition</li> <li><b>Trigger - State:</b> as above, except that rows represent triggers and columns represent states</li> <li><b>State - Next State:</b> both rows and columns represent states; intersection of row and column defines the transition (if there is one) from the row state to the column state.</li> </ul>
<b>Cell Size</b>	
<b>Transition Cell Width</b>	Specify the width of the transition cells (that is, the column width).
<b>Transition Cell Height</b>	Specify the height of the transition cells (that is, the row height).
<b>Left Edge Cell Width</b>	Specify the width of the left edge (row title) cells.
<b>Top Edge Cell Height</b>	Specify the height of the top edge (column title) cells.
<b>Cell Color</b>	
<b>State/Trigger Cell</b>	Select the color of the row and column title cells.

Option	Use to
<b>State/Trigger Enumeration</b>	Select the color of the enumeration (row/column numbering) cells.  <b>Note:</b> You must select at least one of the <b>Enable State Enumeration</b> and <b>Enable Event Enumeration</b> checkboxes to set this color.
<b>Transition Cell</b>	Select the color of the transition cells (in the main body of the table).
<b>Highlight Options</b>	
<b>Highlight Zones Related to Selected Transition</b>	Highlight the cells for all elements involved in a selected transition - the initial state, the target state, and the trigger.
<b>Highlight Color</b>	Select the color of the highlight.
<b>Use Different Color for Target State</b>	Highlight the cell for the target element in a transition in a different color to the cell for the source element.
<b>Target Zone Color</b>	Select the color of the highlight.
<b>Display Options</b>	
<b>Always Display an Empty State Zone</b>	Add an empty row (and, on a <i>State - Next State</i> table, an empty column) to the end of the table.  The title cell contains an ellipsis (...). You can click twice (not double-click) on the ellipsis to edit it and identify a new state. In this case, another empty state zone is automatically added.
<b>Enable State Enumeration</b>	Add a cell to each state title cell, to number the state. Numbering starts at 0.
<b>Prefix</b>	If required, type a prefix for the state number or delete the default <b>S</b> to have no prefix.
<b>Enable Event Enumeration</b>	Add a cell to each event or trigger title cell, to number the event. Numbering starts at 0.
<b>Prefix</b>	If required, type a prefix for the event number or delete the default <b>E</b> to have no prefix.
<b>Sample State Table</b>	Display a preview of the table format as you define it.
<b>Advanced</b>	Define diagram options. The <b>State Machine Diagram Properties</b> <sup>[423]</sup> dialog displays.
<b>Restore Defaults</b>	Reapply the State Table diagram default values.
<b>Apply</b>	Apply changed options to the State Table diagram.

#### 5.1.1.1.4.2 State Machine Table Operations

##### Overview

As a *State Machine table* <sup>[682]</sup> is a variant of a *State Machine diagram* <sup>[678]</sup>, most of the operations for manipulating the data are the same as for State Machine diagrams. These include operations to:

- Create new items by drag-and-dropping a specified object from the **Toolbox** to the current diagram
- Delete an item
- Apply to the diagram elements in the **Project Browser**
- Display or change the properties of the State, Trigger or Transition
- Apply to the diagram, such as **Lock Diagram**, **Zoom**, and *in place editing* of the element.

The operations specific to State Machine tables are described in the following topics:

- [Change Position of State Machine Table](#) <sup>[687]</sup>
- [Change Size of State Machine Table](#) <sup>[687]</sup>
- [Insert New State \(and Substate\)](#) <sup>[687]</sup>
- [Insert Trigger](#) <sup>[688]</sup>
- [Insert/Change Transition](#) <sup>[688]</sup>
- [Reposition State/Trigger Cells](#) <sup>[689]</sup>
- [Add Legend](#) <sup>[689]</sup>
- [Find Cell in State Machine Diagram](#) <sup>[689]</sup>
- [State Machine Table Conventions](#) <sup>[689]</sup>
- [Export State Table To CSV File](#) <sup>[690]</sup>

If necessary, you can move the State Machine table around in the **Diagram View**. To change the position of the State Machine table, follow the steps below:

1. Press **[Ctrl]+[A]** or double click on the top left cell to select the whole State Machine table.
2. Drag and drop the State Machine table to the required position. Alternatively, use **[Shift]+[→]**, **[←]**, **[↑]** or **[↓]** to move the State Machine table.

There are three ways to change the size of the State Machine table:

- Change the cell size on the [State Machine Diagram: Options](#) <sup>[684]</sup> dialog.
- Press **[Ctrl]+[A]** or double click on the top left cell to select the whole State Machine table, then press **[Ctrl]+[→]**, **[←]**, **[↑]** or **[↓]** to change the size.
- Select the State Machine table, then drag the shape handles to change the size.

You can insert a new State in the State Machine table, using one of following methods:

- In the top left cell in the State Machine table, move the cursor to the word **State** to display a **+** at the end of the word; click on the **+** to create a new State
- Right-click in the top left cell in the State Machine table to display the context menu, and select the **Add State** menu option
- Right-click on an existing State cell in the State Machine table to display the context menu, and select the
  - **Insert New State Before** option to insert a new State before the current State, or
  - **Insert New State After** option to insert a new State after the current State
- Click on an existing State cell in the State Machine table, and press **[Insert]** to create and insert a new State above the selected State
- In the **Toolbox**, on the **State Elements** page, click on an element and then click on:
  - the diagram background to add a new State to the end of the table, or
  - an existing State cell to add the new State just above it.

#### Note:

From the **State Elements** page of the **Toolbox** you can insert *State*, *Initial*, *Final*, *Entry*, *Exit* and *Terminate* elements.

## Add a Substate

To add a Substate to a selected State, follow the steps below:

1. Right-click on the required State cell in the State Machine table. The context menu displays.
2. Select the **Add Substate** menu option. Enterprise Architect adds the Substate to the State.

#### Note:

If the selected State does not allow a Substate, then the **Add Substate** menu option is grayed out.

You can also drag one existing State over another. If the second State allows Substates, the dragged State then becomes its Substate.

Similarly, you can change the parent State of a Substate by dragging the Substate from the original parent State to a different State.

## Remove Parent Relation of a Substate

To remove the parent relation of a Substate and make it a separate State, follow the steps below:

1. Right-click on the Substate in the State Machine table. The context menu displays.
2. Select the **Remove Parent Relation** menu option. The Substate cell becomes a State cell.

You can also drag and drop the Substate onto the top left cell of the State Machine table. The dragged Substate again becomes a State cell.

If the State Machine table format is either *State-Trigger* or *Trigger-State*, you can use one of the following methods to insert a new Trigger:

- In the top left cell in the State Machine table, move the cursor to the word **Event** to display a **+** at the end of the word; click on the **+** to create a new Trigger
- In the top left cell in the State Machine table, right-click to display the context menu and select the **Add Trigger** menu option to create a new Trigger
- Select an existing Trigger in the State Machine table, then press **[Insert]** to insert a new Trigger before the existing Trigger
- Click on an existing Trigger in the State Machine table, right-click to display the context menu and select either the:
  - **Insert New Trigger Before** option to insert a new Trigger before the current Trigger, or
  - **Insert New Trigger After** option to insert a new Trigger after the current Trigger.

You can insert a new Transition using one of the following methods:

- Right-click on the cell in which to create a Transition, to display the context menu
  - If the State Machine table format is *State-Trigger* or *Trigger-State*, the context menu lists the States you can choose as the target of the Transition; click on the required State name to create the Transition
  - If the State Machine table format is *State-Next State*, click on the **Insert Transition** menu option to create the Transition.
- In the **State Relationships** page of the **Toolbox**, select the *Transition* element, then click on the cell in the State Machine table in which to create the Transition. Double-click on the Transition to define it in the **Transition Properties** dialog.

## Change the Transition

As for the [State Chart](#)<sup>[678]</sup> diagram, to change the properties of a Transition double-click the Transition cell and edit the details on the **Transition Properties** dialog.

## Change Transition States

You can change the source and target of the Transition by right-clicking the Transition and selecting the **Advanced | Set Source and Target** context menu option.

Alternatively, you can change the Transition source, target or Trigger by clicking on the Transition and dragging it to a different cell.

If the State Machine table format is either **State-Trigger** or **Trigger-State**, you can change the target state of a transition by:

1. Highlighting the target state name in the Transition cell and clicking on it to display a list of the states in the table.
2. Clicking on the preferred target state name.

## Highlight States and Trigger Related to Transition

You can select options to highlight the source State, target State and Trigger cells associated with a Transition, using the **Highlight Options** panel on the [State Machine Diagram: Options](#)<sup>[684]</sup> dialog. When you click on the Transition cell its associated State and Trigger cells are highlighted.

Alternatively, click on the Transition cell and press and hold **[L]**.

You can change the position of a selected State or Trigger cell in one of the following ways:

- Right-click on the State or Trigger title cell and select the appropriate **Order | Move xxx** context menu option
- Click on the cell and press **[Shift]+[→]**, **[←]**, **[↑]** or **[↓]**.

You can add a simple legend to any State Machine Table cell that has no transition. The two legend symbols are:

- **I** - Ignore
- **N** - Never Happen

To assign a legend symbol to a State Machine Table cell, follow the steps below:

1. Right-click on the cell to which to assign the legend. The context menu displays.
2. Select the appropriate menu option:
  - **Legend | Ignore**
  - **Legend | Never Happen.**

The required symbol displays in the center of the cell.

To remove a legend symbol from a cell, right-click on the cell and select the **Legend | Remove Legend** context menu option.

On the State Machine table you can select a State or Trigger element and locate it in a State Machine diagram, by selecting the **Find | Locate in State Chart** context menu option. Enterprise Architect switches to the State Machine diagram and highlights the selected element. You can locate a Transition relationship in a similar way, by selecting the **Locate in State Chart** context menu option.

#### Note:

A Trigger on a State Machine table might or might not exist on the corresponding State Machine diagram. If the Trigger does not exist on the State Machine diagram, the **Locate in State Chart** option is disabled.

Conversely, on the State Machine diagram, you can select a State or Trigger element and locate it on the corresponding State Machine table, by selecting the **Find | Locate in State Table** context menu option. Enterprise Architect switches to the State Machine table and highlights the selected element. You can locate a Transition relationship in a similar way, by selecting the **Locate in State Table** context menu option.

## Trigger

- Deleting a Trigger removes it completely from the model, therefore you cannot UNDO a Trigger deletion
- There is a *<None>* column at the end of the **Event** heading row. This is for Transitions that have no Trigger information.

## State

From the **Toolbox** you can insert the following *State* element types only (although the State Machine table might pick up and display other types, such as *Submachine State*):

- State
- Initial
- Final
- Entry
- Exit
- Terminate.

## Transition

The Transition cell displays its properties in one of two ways, depending on the State Machine table format. If the State Machine table format is *State - Trigger* or *Trigger - State*, the Transition cell displays the *Guard* and *Target* as shown below:

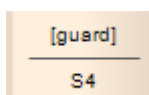

If the State Machine table format is *State - Next State*, then the Transition cell displays the *Trigger*, *Guard* and *Effect* as shown below:

Event3 [guard]
Effect 1

The State Machine table enables you to edit the *Guard* and *Effect* in place. If the *Guard* or *Effect* is empty for your selected Transition cell, the cell displays an ellipsis [ ... ] instead. Click twice (not double-click) on the ellipsis to type in the *Guard* and *Effect* names.

To export a State Machine Table to a CSV file, follow the steps below:

1. Open the required State Machine Table.
2. Right-click on the diagram background and select the **Export Statechart to CSV file** context menu option.
3. The **Save As** browser dialog displays. Select the appropriate directory location and type in the .CSV filename.
4. Click on the **Save** button.

### 5.1.1.1.5 Timing Diagram

One of four types of *Interaction* diagram. (The other three are [Sequence Diagrams](#)<sup>[706]</sup>, [Interaction Overview Diagrams](#)<sup>[717]</sup> and [Communication Diagrams](#)<sup>[715]</sup>.)

A *Timing diagram* defines the behavior of different objects within a time-scale. It provides a visual representation of objects changing state and interacting over time.

You can use Timing diagrams to define hardware-driven or embedded software components; for example, those used in a fuel injection system or a microwave controller. You can also use Timing diagrams to specify time-driven business processes.

To create and edit a Timing diagram, see the following topics:

- [Create a Timing Diagram](#)<sup>[692]</sup>
- [Set a Time Range](#)<sup>[692]</sup>
- [State Lifeline](#)<sup>[794]</sup>
- [Value Lifeline](#)<sup>[808]</sup>
- [Edit a Timing Diagram](#)<sup>[692]</sup>
- [Time Intervals](#)<sup>[700]</sup>
- [Message \(Timing Diagram\)](#)<sup>[882]</sup>

### Example Diagram

An example of a Timing diagram is shown below:

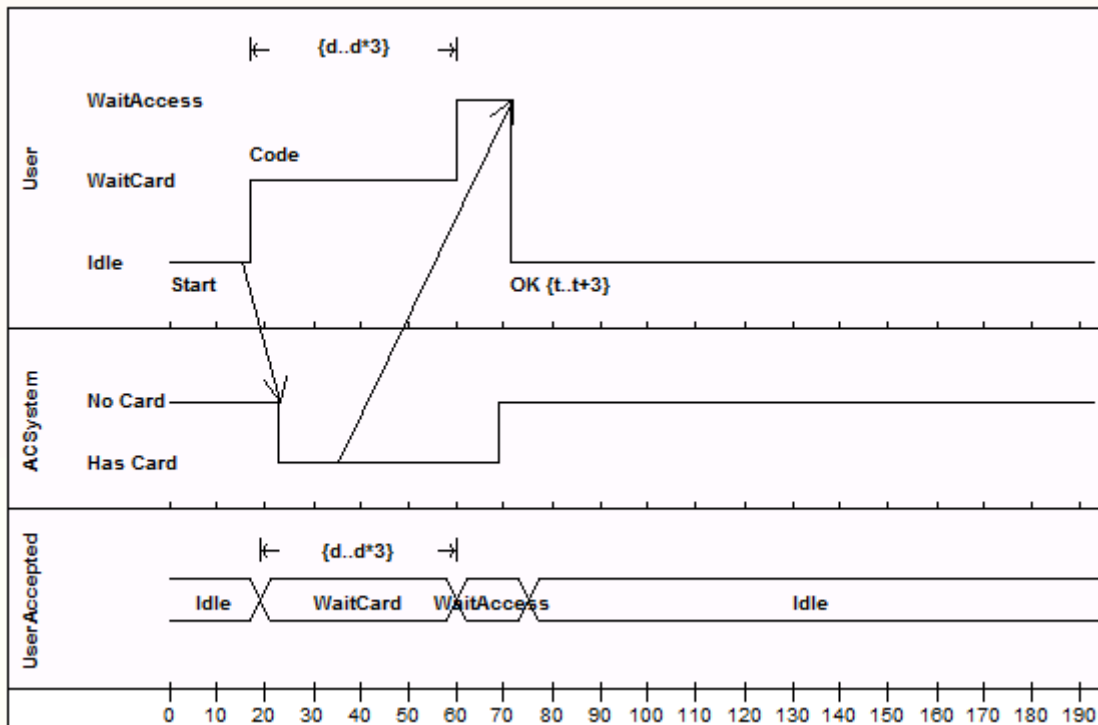

(See OMG UML Superstructure Specification, v2.1.1, p. 454, figures 14.30 and 14.31).

### Toolbox Elements and Message

Select Timing diagram elements and connectors from the [Timing](#) <sup>[410]</sup> [pages](#) <sup>[410]</sup> of the **Toolbox**.

**Tip:**

Click on the following elements and connectors for more information.

Timing Diagram Elements	Timing Diagram Message
State Lifeline	Message
Value Lifeline	
Message Label	
Message Endpoint	
Diagram Gate	

### OMG UML Specification

The OMG UML specification (*UML Superstructure Specification, v2.1.1, p. 517*) states:

*Timing Diagrams are used to show interactions when a primary purpose of the diagram is to reason about time. Timing diagrams focus on conditions changing within and among Lifelines along a linear time axis.*

*Timing diagrams describe behavior of both individual classifiers and interactions of classifiers, focusing attention on time of occurrence of events causing changes in the modeled conditions of the Lifelines.*

The OMG UML specification (*UML Superstructure Specification, v2.1.1, p. 519*) also states:

The primary purpose of the timing diagram is to show the change in state or condition of a lifeline (representing a Classifier Instance or Classifier Role) over linear time. The most common usage is to show the change in state of an object over time in response to accepted events or stimuli. The received events are annotated as shown when it is desirable to show the event causing the change in condition or state.

#### 5.1.1.1.5.1 Create a Timing Diagram

To create a Timing diagram, follow the steps below:

1. Right-click on a package in the **Project Browser**. The context menu displays.
2. Select the **Add | Add Diagram** menu option. The **New Diagram** dialog displays.
3. In the **Select From** panel, select **UML Behavioral**.
4. In the **Diagram Types** panel, select **Timing**.
5. Click on the **OK** button. The **Diagram** view displays, on which you create the Timing elements for the diagram. See [Set a Time Range](#)<sup>[692]</sup> and [Edit a Timing Diagram](#)<sup>[692]</sup>.

#### 5.1.1.1.5.2 Set a Time Range

Before adding Lifeline elements to your Timing diagram, set a time range. To do this, follow the steps below:

1. Right-click on the diagram. The context menu displays.
2. Select the **Set Timeline Range** option. The **Set Timeline Range** dialog displays.

3. In the **Start Time** and **End Time** fields, type the numeric values for the start and end points of the timeline; for example, set the range **0** to **100**.

#### Note:

The start time must be less than the end time.

4. In the **Time Units** field, type the unit in which the time is measured; for example, **seconds** or **minutes**.
5. If it is not necessary to show the time range on the diagram, select the **Suppress In Diagram** checkbox.
6. Click on the **OK** button. If you have not suppressed it, the time range displays underneath the Lifeline elements that you create on the diagram.

#### 5.1.1.1.5.3 Edit a Timing Diagram

On a Timing Diagram, you can add *State Lifeline* elements and *Value Lifeline* elements. You can maintain the *states* and *transitions* on these Lifeline elements either on the diagram itself or via the **Configure Timeline** dialog. See the following topics:

- [Add and Edit a State Lifeline Element](#)<sup>[693]</sup>
- [Edit States in a State Lifeline Element](#)<sup>[693]</sup>
- [Edit Transitions in a State Lifeline Element](#)<sup>[694]</sup>
- [Add and Edit a Value Lifeline Element](#)<sup>[696]</sup>
- [Add States in a Value Lifeline Element](#)<sup>[696]</sup>
- [Edit Transitions in a Value Lifeline Element](#)<sup>[696]</sup>
- [Configure Timeline dialog - States Tab](#)<sup>[697]</sup>
- [Configure Timeline dialog - Transitions Tab](#)<sup>[699]</sup>



From the **Timing** elements page of the **Toolbox** drag a [State Lifeline](#)<sup>[794]</sup> element onto your diagram. The element displays on the diagram.

To define the name of the State Lifeline, follow the steps below:

1. Right-click on the element. The context menu displays.
2. Select the **Other Properties** option. The **Timeline <name>** dialog displays, showing the **General** tab.
3. Overtyping the **Name** field.
4. Click on the **Apply** button and the **OK** button.

## Sizing and Scale

In the top left corner of a selected Lifeline element are the left and right *quick sizing buttons* (↔). These buttons increase or decrease the width of the Lifeline element, which in turn controls the scale width of each time unit. By increasing the width of the element you increase the resolution when adding transitions, which makes them easier to edit.

### Note:

In order to edit the State Lifeline element, you must click on it to select it.

## Set Timeline Start Position

You might require more space at the start of your timelines; for example, to use long state names. To insert this space in all the timelines on a diagram, follow the steps below:

1. Right-click on the diagram background to display the context menu.
2. Select the **Set Timeline Start Position** menu option. The **Set Timeline Start Position** dialog displays.
3. The **Value 80 to 300** field defaults to **80** as the minimum distance in pixels between the start of the timeline element and the start of the timeline itself. Type a new value up to 300 pixels and click on the **OK** button to increase the space at the start of the timeline, as shown in the following diagrams.

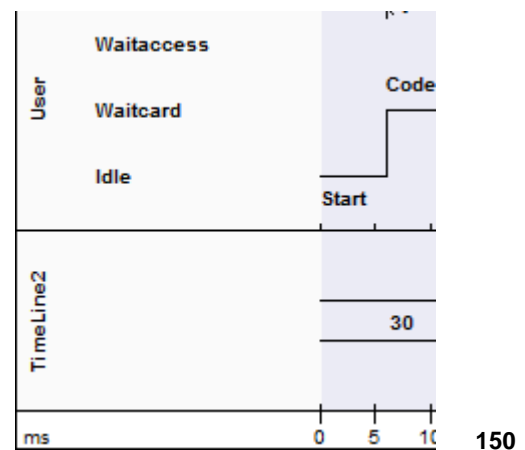
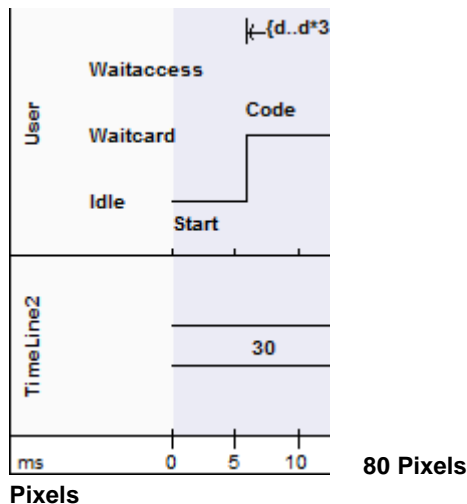

You now edit the [states](#)<sup>[693]</sup> and [transitions](#)<sup>[694]</sup> in the State Lifeline.

## Add States

1. Click on the *State Lifeline* element. The **New State** button (🔧) and **Edit States** button (📄) display at the bottom left of the element.
2. Click on the **New State** button. The **New State** dialog displays.

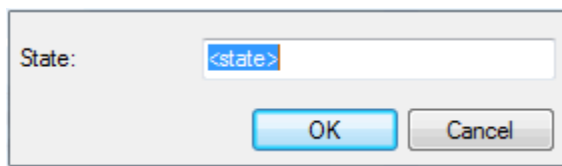

3. In the **State** field, type the name of the state.
4. Click on the **OK** button.

**Note:**

You must add at least two states; for example, **On** and **Off**.



5. As you add states, increase the height of the element by dragging a handle-box (  ) on the edge of the element.

**Note:**

You can also add states using the **States** tab of the **Configure Timeline** dialog. Add either:

- Discrete states to the Timeline as described in [Add a New State](#) <sup>[698]</sup>, or
- A continuous range of numeric states as described in [Numeric Range Generator](#) <sup>[698]</sup>.

## Edit States

1. Click on the State Lifeline element and click on the required state. The **Edit State** dialog displays.
2. In the **State** field, change the name as required.
3. Click on the **OK** button.
4. If necessary, change the order of the states by either:
  - Clicking on the up or down arrows (  and  ) beside each state name, or
  - Right-clicking on the state name and selecting the **Move Up** or **Move Down** context menu options.

**Note:**

You can also edit the states using the **States** <sup>[697]</sup> tab of the **Configure Timeline** dialog.

## Delete States



1. Right-click on the state name. The context menu displays.
2. Select the **Delete** option.

Alternatively:



1. Click on the State Lifeline element.
2. Hold down **[Ctrl]** and move the cursor over the state name. The cursor changes form (  ).
3. Click the mouse button. The state name is deleted.

## Add and Move Transitions

After you have added states, you can add transitions via the diagram. As you move the cursor over the timeline, the cursor changes to one of three shapes:

- The *move* cursor (  ) displays when it is directly over the timeline. Hold down the mouse button and drag the line to move the timeline to a state above or below the current position. You can move the transition more than one state up or down, if necessary.
- The *new transition up* cursor (  ) displays when it is just below the timeline, and there is another state above the line. Press and hold **[Alt]**; the cursor changes (  ). Click to create a new transition to the state above the line. To push the transition up more than one state, then move the cursor onto the line and drag it up. The transition is for one interval unit; to make it longer, see *Change the Transition Time* below.

If you do not hold **[Alt]**, the cursor does not change and the whole timeline from the transition onwards moves up.

- The *new transition down* cursor (  ) displays when it is just above the transition line, and there is another state below the line. Press and hold **[Alt]**; the cursor changes (  ). Click to create a new transition to the state below the line. To push the transition down more than one state, then move the cursor onto the line and drag it down. The transition is for one interval unit; to make it longer, see *Change the Transition Time* below.

If you do not hold **[Alt]**, the cursor does not change and the whole timeline from the transition onwards moves down.

As you move the cursor over the vertical line of a transition, the time at which the transition occurs displays next to the line.

## Edit Transitions

Follow the steps below:

1. Click directly on the appropriate transition line, after the transition begins. Alternatively, right-click on the transition line to display the context menu, and select the **Edit** menu option.

The **Edit Transition** dialog displays. The fields in this dialog are all optional.

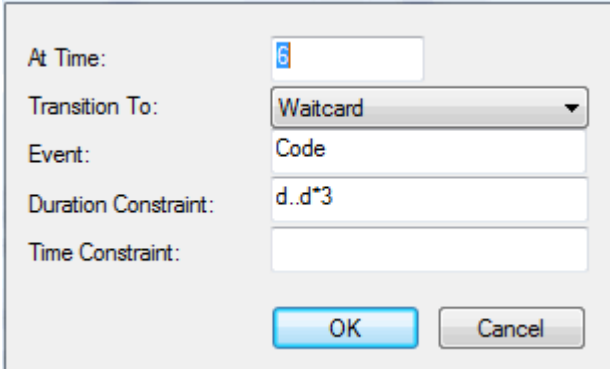

2. In the **At Time** field, type the point on the timescale at which the transition occurs.
3. In the **Transition To** field, type the name of the state to which the transition occurs.
4. In the **Event** field, type the name of the event that the transition represents; this displays on the Timeline element just above the transition line.
5. In the **Duration Constraint** field, type any constraint on the duration of the transition; this displays on the Timeline element, along the top of the element over the transition.
6. In the **Time Constraint** field, type any constraint on the start of the transition. This displays on the Timeline element at the start of the transition.
7. Click on the **OK** button.

### Notes:



- Once **Event**, **Duration Constraint** or **Time Constraint** are displayed on the diagram, you can edit them directly by clicking on them to display their specific dialog. You can also delete them by pressing and holding **[Ctrl]** as you click on them; the cursor changes form when you press **[Ctrl]**.
- You can also edit transitions using the [Transitions](#) <sup>699</sup> tab of the **Configure Timeline** dialog.

## Change the Transition Time

Move the cursor over one or other of the vertical transition lines and drag the line left or right to change the time of the transition. While on the line, the cursor shape changes to the horizontal movement cursor (  ).

## Merge Transitions

If necessary, you can 'push' a transition to merge it with the next or previous transition point on any Lifeline element on the diagram.

Position the cursor off the appropriate side of the transition line; the cursor changes form ( or ). Click the mouse button. The system locates the nearest transition in the required direction, on any element on the diagram, and merges the current transition with that transition.

## Delete Transitions

Transitions are automatically deleted when you move the transition to the same state as the previous transition state, and release the cursor.



Alternatively, right-click on the transition line to display the context menu, and select the **Delete** menu option.

From the **Toolbox** drag a [Value Lifeline](#)<sup>[806]</sup> element onto your diagram. The element displays on the diagram.

To edit the Value Lifeline name, follow the steps below:

1. Right-click on the element. The context menu displays.
2. Select the **Other Properties** option. The **Timeline <name>** dialog displays, showing the **General** tab.
3. Overtyping the **Name** field.
4. Click on the **Apply** button and the **OK** button.

## Sizing and Scale

In the top left corner of a selected Lifeline element are the left and right *quick sizing* buttons ( ). These buttons increase or decrease the width of the Lifeline element, which in turn controls the scale width of each time unit. By increasing the width of the element you increase the resolution when adding transitions, which makes them easier to edit.

### Note:

In order to edit the Value Lifeline element, you must click on it to select it.

You now [add states](#)<sup>[696]</sup> and [edit transitions](#)<sup>[696]</sup> on the Value Lifeline.



Adding States to a Value Lifeline is similar to adding states to a [State Lifeline](#)<sup>[693]</sup> element.

### Notes:

- For a Value Lifeline, only the first state displays on the diagram. The other states are added to a list to access when creating transitions; they only display on the Lifeline element as you create transitions to those states.
- You can only edit or delete states in a Value Lifeline element using the [States](#)<sup>[697]</sup> tab of the **Configure Timeline** dialog.

## Add Transitions

After you have added states to the Value Lifeline element, you can add transitions via the diagram. To do this, follow the steps below:

1. Move the cursor above the transition line. The cursor changes form ( ).
2. Click the mouse button. The **New Transition Event** dialog displays.

The dialog box has the following fields and controls:

- At Time:** A text input field containing the number '10'.
- Transition To:** A drop-down menu with a downward-pointing arrow.
- Event:** A text input field.
- Duration Constraint:** A text input field.
- Time Constraint:** A text input field.
- Buttons:** 'OK' and 'Cancel' buttons at the bottom.

3. In the **Transition To** field, click on the drop-down arrow and select a state from the list of available states; this displays on the Lifeline element within the transition box. The remaining fields on the dialog are optional.
4. In the **Event** field, type the name of the event that the transition represents; this displays on the Lifeline element just below and at the start of the transition line.
5. In the **Duration Constraint** field, type any constraint on the duration of the transition; this displays on the Lifeline element, along the top of the element over the transition.
6. In the **Time Constraint** field, type any constraint on the start of the transition. This displays on the Lifeline element at the start of the transition, just after the Event name.
7. Click on the **OK** button to create the new transition.

## Edit Transitions

To edit a transition, follow the steps below:

1. Click on the state name in the transition. Alternatively, right-click on the state name to display the context menu, and select the **Edit** menu option.

The **Edit Transition** dialog displays; this is the same as the **New Transition Event** dialog, except that the **At Time** field is enabled.

2. If necessary, overwrite the **At Time** field to define a different start point.

### Note:

You cannot change the **At Time** field for the first state in the timeline; this is always **0**.

3. Edit the remaining fields as necessary.
4. Click on the **OK** button to save the changes.

## Change the Transition Time

To change the start or end time of a transition, click on the start or end point of the transition and drag it to the new position. While on the line, the cursor shape changes to the horizontal movement cursor (↔).

## Delete Transitions

To delete a transition, press and hold **[Ctrl]** and click on the transition state name. While you hold **[Ctrl]** on the transition state name, the cursor changes form (↔).

Alternatively, right-click on the state name to display the context menu, and select the **Delete** menu option.

You can also manage states using the **States** tab of the **Configure Timeline** dialog. To display this, either:

- Double-click on the Lifeline element
- Right click on the Lifeline element and, from the context menu, select the **Properties** option, or
- On a Value Lifeline, click on the **Edit States** button (🔧).

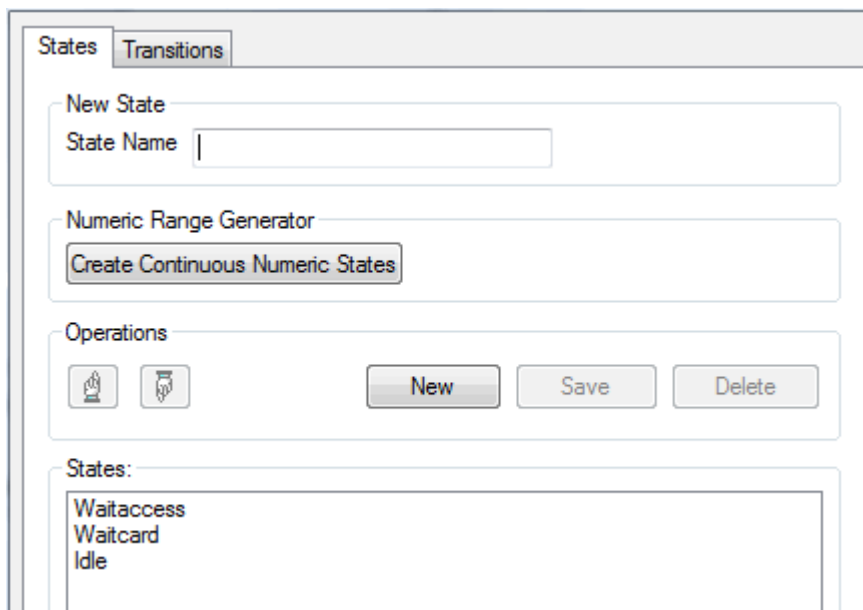

The **Configure Timeline** dialog defaults to the **States** tab.

All states currently defined for the Lifeline element are listed in the **States** panel.

#### Add a New State:

1. In the **State Name** field, type the name of the first new state in the Lifeline element; for example, **WaitState**.
2. Click on the **Save** button. The state is added to the **States** panel and (for a State Lifeline Element) to the diagram.
3. Click on the **New** button.
4. In the **State Name** field, type the name of the next state in the Lifeline element.
5. Repeat steps 2 to 5 until you have added all required states (you must add at least three to the Lifeline element).
6. When you have added all the required states, click on the **OK** button to close the **Configure Timeline** dialog.



#### Edit an Existing State:

1. Click on the state in the **States:** list.
2. In the **State Name** field, change the name of the state.
3. Click on the **Save** button.

#### Delete an Existing State:

1. Click on the state in the **States:** list.
2. Click on the **Delete** button.

#### Change the Order of States:

1. Click on the state in the **States:** list.
2. Click on the  or  buttons to move the state up or down the sequence.

### Numeric Range Generator

You can also use the **Configure Timeline** dialog to create a range of states having numeric values to be applied to the Timeline.

#### Important:

This operation deletes all existing states and transitions for the Timeline element.

1. Display the **Configure Timeline** dialog.
2. Click on the **Create Continuous Numeric States** button. The **Numeric Range Generator** dialog displays.
3. In the **High Value** and **Low Value** fields, type the upper and lower values of the range.
4. In the **Step Value** field, type the increase interval.

**Note:**

Nonsense values do not parse; **Low Value** must be less than **High Value**, and **Step Value** must be a positive value smaller than the total range.

5. In the **Units** field, type the name of the measurement unit; for example, **minutes**.
6. Click on the **OK** button. Enterprise Architect displays a warning that existing states and transitions will be deleted.
7. Click on the **Yes** button. The **Configure Timeline** dialog redisplay, with the defined range of states listed in the **States** panel.
8. Click on the **OK** button. For a:
  - Value Lifeline, the first state is shown on the Timeline for the full time range of the Timeline.
  - State Lifeline, the range of states is displayed as the y-axis of the Timeline.

You can also manage transitions using the **Transitions** tab of the **Configure Timeline** dialog. To display this, either:

- Double-click on the Lifeline element
- Right click on the Lifeline element and, from the context menu, select the **Properties** option, or
- On a Value Lifeline, click on the **Edit States** button (  ).

The **Configure Timeline** dialog defaults to the **States** tab. Click on the **Transitions** tab.

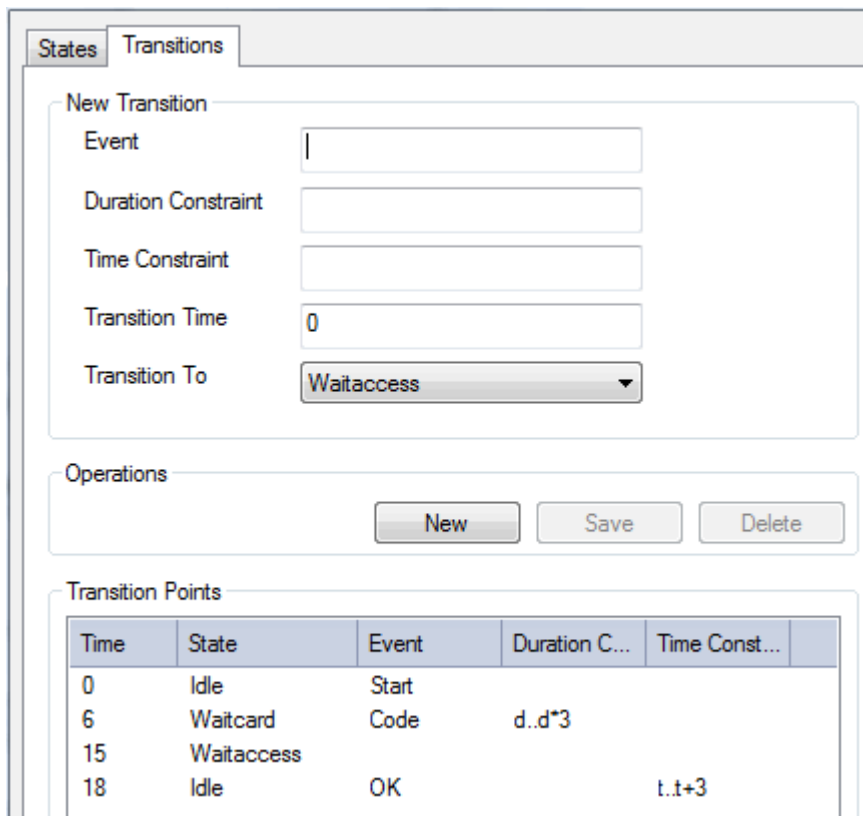

Time	State	Event	Duration C...	Time Const...
0	Idle	Start		
6	Waitcard	Code	d..d*3	
15	Waitaccess			
18	Idle	OK		t..t+3

All transitions defined for the Timeline element are listed in the **Transition Points** panel.

### Add a New Transition

1. Click on the **New** button.
2. In the **New Transition** panel, type the details of the transition.
3. Click on the **Save** button.

### Edit a Transition

1. Click on a transition in the list.
2. In the **Edit Transition** panel, edit the fields for the transition as required.
3. Click on the **Save** button.

### Delete a Transition

1. Click on a transition in the list.
2. Click on the **Delete** button. The transition is removed from the dialog and the Lifeline.
3. Click on the **OK** button.

#### 5.1.1.1.5.4 Time Intervals

You create and manage Time Intervals using the *Interval Bar* (the pale line along the top of each selected Lifeline element). Time Intervals enable you to perform various operations on transitions, such as copy and paste. They also enable you to compress sections of the timeline so that they are not visible.

Each Time Interval displays across all Timeline elements down to the last element on the diagram.

### Create Time Intervals

To create a Time Interval, follow one of the three sets of steps below:

#### Interval Bar - Context Menu

1. Right-click on the Interval Bar at approximately the point at which to start or finish the Time Interval.

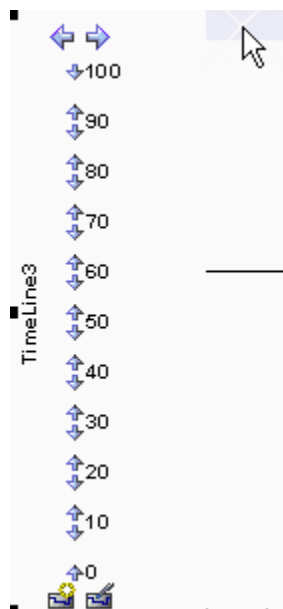

The context menu displays.

2. Select the **Create Time Interval** option. The Time Interval displays down all the timeline elements, as a narrow pale band with a blue compression box at the top.



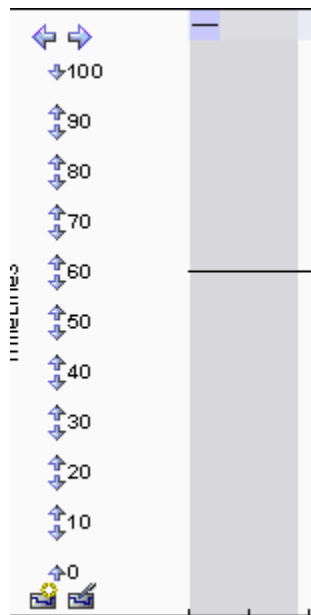

3. Move the cursor to the edge of the Time Interval in the Interval Bar so that the cursor changes to the drag form (↔) and drag the edge to the correct start or end point.

#### Interval Bar - [Shift] key

1. Move the cursor over the Interval Bar and press **[Shift]**. The cursor changes shape (⇨).
2. Click to create the Time Interval.
3. Move the cursor to the edge of the Time Interval in the Interval Bar so that the cursor changes to the drag form (↔) and drag the edge to the correct start or end point.

#### Timeline - Context menu

1. Right-click on the timeline just after a transition. The context menu displays.
2. Click on the **Select** menu option. Enterprise Architect creates a Time Interval covering the period from the selected transition up to the next transition.

#### Notes:

- If there are other Time Intervals in this period, Enterprise Architect replaces them with the single Time Interval for the transition state. You should consider this when creating the Time Interval, as it extends across the other Timeline Elements in the diagram.
- A value of this method is that it creates a Time Interval for a period in which no transitions occur, which could be lengthy. You can then compress this Time Interval (see below) to hide the period of inactivity. See also [Compress Timeline](#)<sup>[704]</sup>.

### Compress Time Intervals

You can compress Time Intervals to conserve space on long timelines.

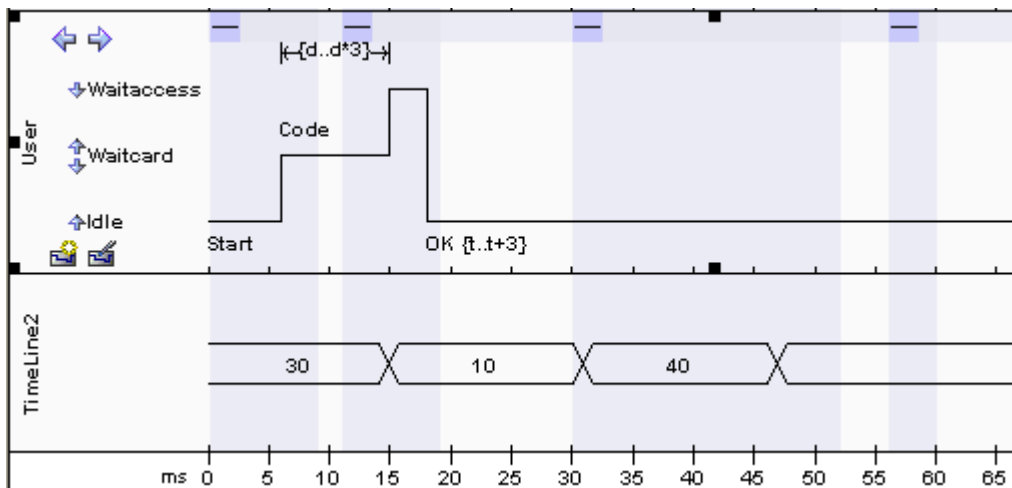

#### Uncompressed Time Intervals

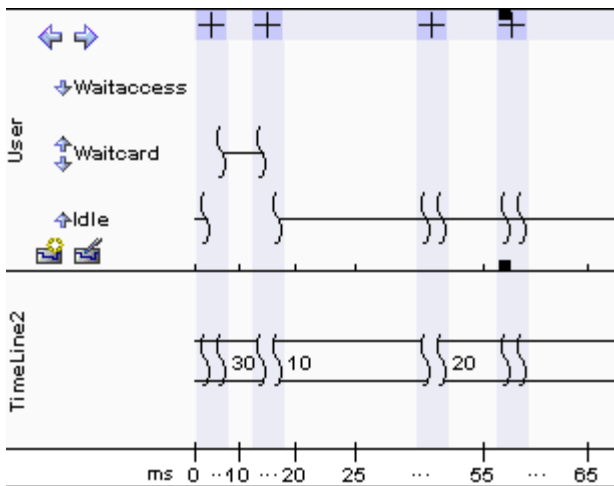

### Compressed Time Intervals

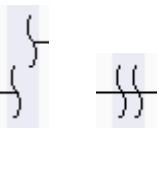

Notice:

Item	Description
	The compression toggle boxes: <ul style="list-style-type: none"> <li>•  is expanded, click on this to compress the selected time interval</li> <li>•  is compressed, click on this to expand the selected time interval again.</li> </ul>
	The compressed sections of the timelines themselves, in all elements. If there is space between the paired symbols, there are transitions within the compressed section. If the timeline continues through the paired symbols there are no transitions in the compressed section.
25 ... 55	The compressed sections in the time range underneath the elements.

You can also compress and expand Time Intervals using context menu options; see [Time Interval Operations on Transitions](#) [703].

### Select Time Intervals

- To select a Time Interval across all elements on the diagram, click on the Interval Bar within the Time Interval.

- To select a number of individual Time Intervals, press and hold **[Ctrl]** while clicking on the Interval Bar within each Time Interval.
- To select all Time Intervals in a range, click on the Interval Bar within the first Time Interval in the range, then press and hold **[Shift]** and click on the Interval Bar within the last Time Interval in the range. All Time Intervals between the two are selected.

After you have selected one or more Time Intervals, you can modify the selection in the following ways:

- To exclude Lifeline elements from the selection, press and hold **[Ctrl]** and click on any part of the selection within that element. In the diagram below, the Value Lifeline is excluded from selection.

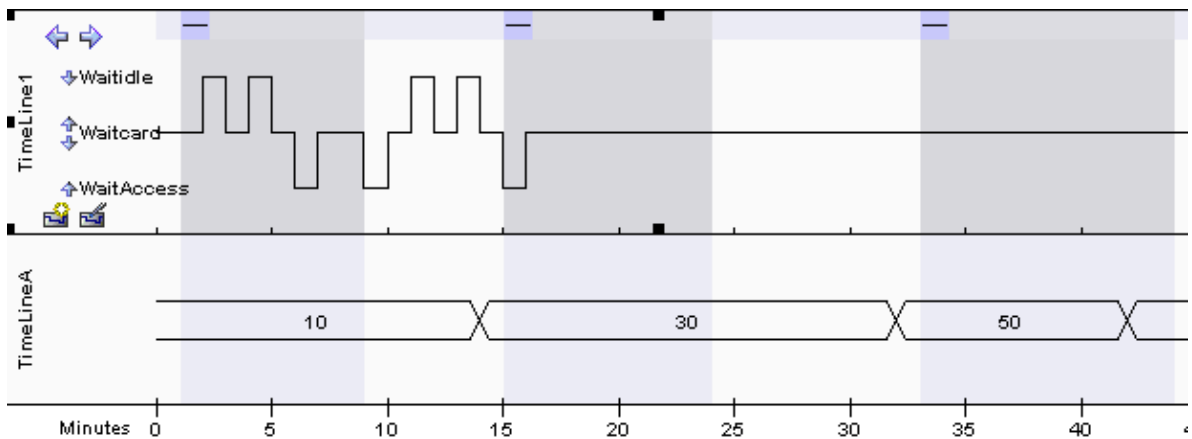

Repeat the step to toggle the selection and re-include the element. See also [Toggle Interval Selection](#)<sup>[704]</sup>.

- To select only one Lifeline element and exclude all others, press and hold **[Shift]** and click on any part of the selection within that element.

#### Note:

Selection is useful for cutting, copying and pasting transitions.

## Move and Resize Time Intervals

To move a Time Interval, move the cursor over the Interval bar within the Time Interval, hold down the mouse button and drag the interval left or right.

To resize a Time Interval, move the cursor over the Interval Bar at the start or end edge of the Time Interval, hold down the mouse button and move the edge left or right.

#### Note:

Time Intervals can meet, but cannot overlap.

## Delete Time Intervals

[Select](#)<sup>[702]</sup> each Time Interval to be deleted and press **[Delete]**.

#### Note:

Deleting the Time Interval does not delete transitions within that interval.

You can operate on selected [Time Intervals](#)<sup>[700]</sup>, or all Time Intervals in the diagram.

## Selected Intervals

#### Note:

The Copy, Cut and Delete operations act on all selected Time Intervals over the whole diagram, not just the current one.

To select and update specific Time Intervals, right-click on the Interval Bar within an interval. The following context menu displays.

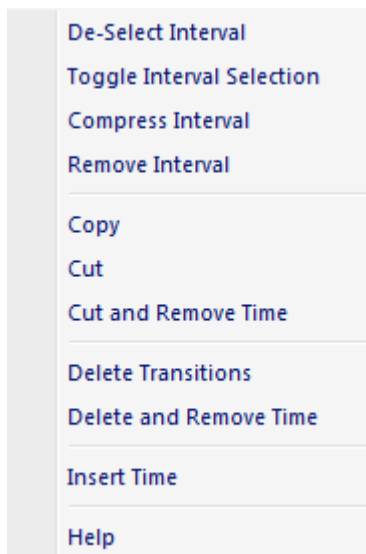

Option	Use to
<b>Select Interval</b> <b>Deselect Interval</b>	Select the Time Interval or, if the interval is already selected, deselect it. You can select several Time Intervals in this way, accessing the menu separately on each interval.
<b>Toggle Interval Selection</b>	Switch the selection or deselection of the Time Interval within the selected Timeline element.  You select or deselect a Time Interval across all Timeline Elements, but the Toggle option acts only on the element in which you access the menu. See also <a href="#">Select Time Intervals</a> [702].
<b>Compress Interval</b>	Compress the Time Interval, and hide all transitions within that Time Interval. This is also useful for hiding long sections of inactivity on the time line. Also see <a href="#">Compress Timeline</a> [704], below.
<b>Remove Interval</b>	Delete the Time Interval.
<b>Copy</b>	Copy the transitions for all selected Time Intervals.
<b>Cut</b>	Copy and delete the selected transitions from the diagram.
<b>Cut and Remove Time</b>	Copy and delete the transitions that lie in the selected Time Intervals from the diagram.  This option also removes time from the timeline, the amount being the duration of the Time Interval. All transitions and Time Intervals to the right of the selected time interval are moved left.
<b>Delete</b>	Delete the selected transitions from the diagram.
<b>Delete and Remove Time</b>	Delete the transitions that lie in the selected Time Intervals from the diagram.  This option also removes time from the timeline, the amount being the duration of the Time Interval. All transitions and Time Intervals to the right of the current Time Interval are moved left.
<b>Insert Time</b>	Add time to the timeline and move all transitions and time intervals to the right. Also expand the duration of the current Time Interval.

### Compress Timeline

The Compression toggle boxes and **Compress Interval** menu option operate on the Time Interval and compress the timeline and all transitions within the Interval. You have an alternative option that operates on

the timeline and compresses a single transition state.

1. Right-click on the timeline (rather than the Interval Bar) just after a transition. The context menu displays.
2. Click on the **Compress** menu option. Enterprise Architect creates a new Time Interval covering the period from the selected transition up to the next transition, and then compresses that Time Interval.

#### Notes:

- If there are other Time Intervals in this period, Enterprise Architect replaces them with the single Time Interval for the transition state. You should consider this when creating and compressing the Time Interval, as it extends across the other Timeline elements in the diagram.
- A value of this method is that it creates a Time Interval for a period in which no transitions occur, which could be lengthy, and then compresses this Time Interval to hide the period of inactivity.

## All Time Intervals in the Diagram

To create a new Time Interval or work across all Time Intervals in the diagram, right-click on the Interval Bar between Time Intervals. The following context menu displays.

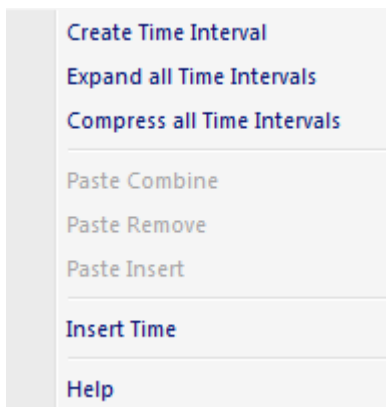

#### Note:

The **Paste** menu options become active after transitions have been copied.

Menu Option	Use to
Create Time Interval	<a href="#">Create a single Time Interval</a> 
Expand all Time Intervals	Expand all Time Intervals over the whole diagram.
Compress all Time Intervals	Compress all Time Intervals over the whole diagram.
Paste Combine	Paste copied transitions over any existing transitions within the copied time frame.  <b>Note:</b> The diagram does not allow two consecutive transitions to the same state, and removes the second transition automatically.
Paste Remove	Delete all the transitions and then pastes the copied transition within the copied time frame.
Paste Insert	Insert time, moving all transitions and Time Intervals to the right to make room to paste in the copied transitions.
Insert Time	Add time to the timeline and move all transitions and Time Intervals to the right. This option does not change the duration of any Time Interval.

## Copy and Paste Transitions From One Timeline Element to Another

A special mode enables you to copy transitions from one Timeline element to another. Any states that don't exist in the Timeline element you are pasting to are created.

1. Press and hold **[Shift]** and select the Timeline element within a Time Interval to copy or cut.
2. Right-click on the Interval Bar (it doesn't matter which element you select). The context menu displays.
3. [Copy or cut](#)<sup>[704]</sup> the transitions. You can also cut and remove time.
4. Select the timeline to paste transitions to and right-click on the Interval Bar. The context menu displays.
5. Select one of the paste operations. Note that states are created if they don't already exist in the timeline.

### Note:

Any new states created might be in the wrong order. You can change the order via the diagram [quick buttons](#)<sup>[693]</sup>.

## Shift Transitions Left or Right

You can move transitions within a selected Time Interval or multiple selected Time Intervals.

1. Select all the Time Intervals containing the transitions to be shifted; see [Select Time Intervals](#)<sup>[702]</sup>.
2. Press and hold **[Shift]** and click on the Interval Bar (it doesn't matter which Timeline element you select) and move the transition left or right.

### Note:

You cannot drag transitions over other transitions; the move stops when the moved transition collides with a stationary transition.

### Tip:

If you have collision problems, use **[Shift]+select** to shift transitions for a single Timeline element.

### 5.1.1.1.6 Sequence Diagram

A *Sequence* diagram is one of four types of *Interaction* diagram. (The other three are [Timing Diagram](#)<sup>[690]</sup>, [Interaction Overview Diagram](#)<sup>[717]</sup> and [Communication Diagram](#)<sup>[715]</sup>.)

A Sequence diagram is a structured representation of behavior as a series of sequential steps over time. It is used to depict work flow, message passing and how elements in general cooperate over time to achieve a result.

- Each [sequence element](#)<sup>[710]</sup> is arranged in a horizontal sequence, with messages passing back and forward between elements.
- Messages on a Sequence diagram can be of several types; the Messages can also be configured to reflect the operations and properties of the source and target elements (see the *Notes* in the [Message](#)<sup>[868]</sup> topic).
- An Actor element can be used to represent the user initiating the flow of events.
- Stereotyped elements, such as [Boundary](#)<sup>[836]</sup>, [Control](#)<sup>[838]</sup> and [Entity](#)<sup>[839]</sup>, can be used to illustrate screens, controllers and database items, respectively.
- Each element has a dashed stem called a *lifeline*, where that element exists and potentially takes part in the interactions.

To configure a Sequence diagram, see the following topics:

- [Denote the Lifecycle of an Element](#)<sup>[708]</sup>
- [Layout of Sequence Diagrams](#)<sup>[709]</sup>
- [Sequence Element Activation](#)<sup>[711]</sup>
- [Lifeline Activation Levels](#)<sup>[712]</sup>
- [Message Label Visibility](#)<sup>[714]</sup>
- [Change the Top Margin](#)<sup>[714]</sup>
- [Change the Timing Details](#)<sup>[874]</sup>.

Also take note of the important information in the [Sequence Diagrams and Version Control](#)<sup>[710]</sup> topic.

Robustness diagrams, used extensively in [ICONIX](#)<sup>[1084]</sup>, can be created as Sequence diagrams.

To toggle the numbering of messages on a Sequence diagram, select or deselect the [Show Sequence Numbering](#)<sup>[360]</sup> checkbox on the [Options](#) dialog.

### Example Diagram

The following example Sequence diagram demonstrates several different elements:

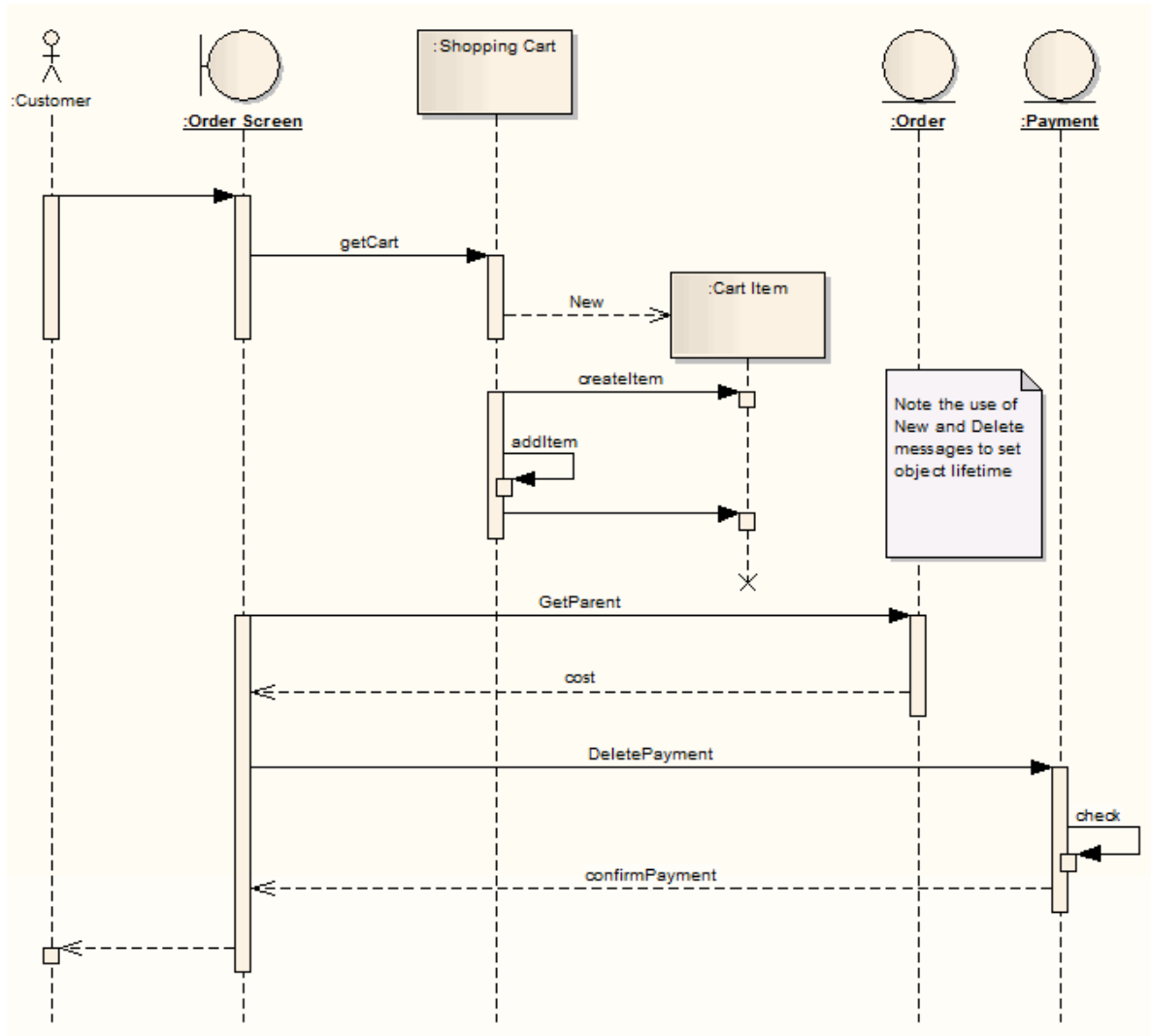

### Toolbox Elements and Connectors











Select Sequence diagram elements and connectors from the [Interaction](#)<sup>[410]</sup> [pages](#)<sup>[410]</sup> of the [Toolbox](#).

Enterprise Architect also supports a number of [stereotyped elements](#)<sup>[739]</sup> to represent various entities in business modeling.

**Tip:**

Click on the following elements and connectors for more information.

Sequence Diagram Elements	Sequence Diagram Connectors
Actor	Message

Sequence Diagram Elements	Sequence Diagram Connectors
 Lifeline	 Self-Message
 Boundary	 Recursion
 Control	 Call
 Entity	
 Fragment	
 Endpoint	
 Diagram Gate	
 State/Continuation	

## OMG UML Specification

The OMG UML specification (*UML Superstructure Specification, v2.1.1, p. 503*) states:

*A sequence diagram describes an Interaction by focusing on the sequence of Messages that are exchanged, along with their corresponding OccurrenceSpecifications on the Lifelines.*

### 5.1.1.1.6.1 Denote Lifecycle of an Element

You can capture element lifetimes using messages that are denoted as *New* or *Delete* message types. To do this, follow the steps below:

1. Double-click on a message within a Sequence diagram to display the **Message Properties** dialog.
2. In the **Lifecycle** field, click on the drop-down arrow and select **New** or **Delete**.
3. Click on the **OK** button to save the changes.

The example below shows two elements that have specific creation and deletion times.

#### Note:

To show the termination **X** on the lifeline in the following example diagram, you must switch on garbage collection: **Tools | Options | Diagram | Sequence | Garbage Collect**.



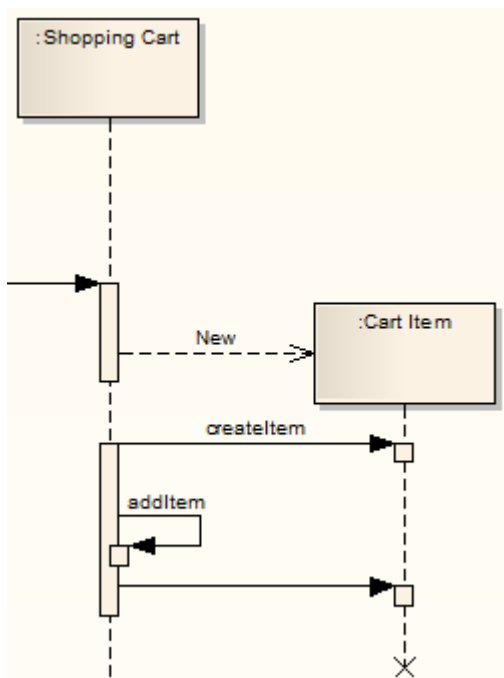

#### 5.1.1.1.6.2 Layout of Sequence Diagrams

You can modify the vertical height of sequence messages to get an attractive and effective layout. To offset message positions, follow the steps below:

1. Select the appropriate message in a Sequence diagram.
2. Use the mouse to drag the message up or down as required.

As you drag a message up or down a lifeline, any messages or fragments below that message are shifted up or down the same amount. However, be aware that if you drag up or down past the next or previous message, Enterprise Architect interprets that as the requirement to swap positions, rather than simply offset a message position.

The example below shows an economical use of space in a Sequence diagram.

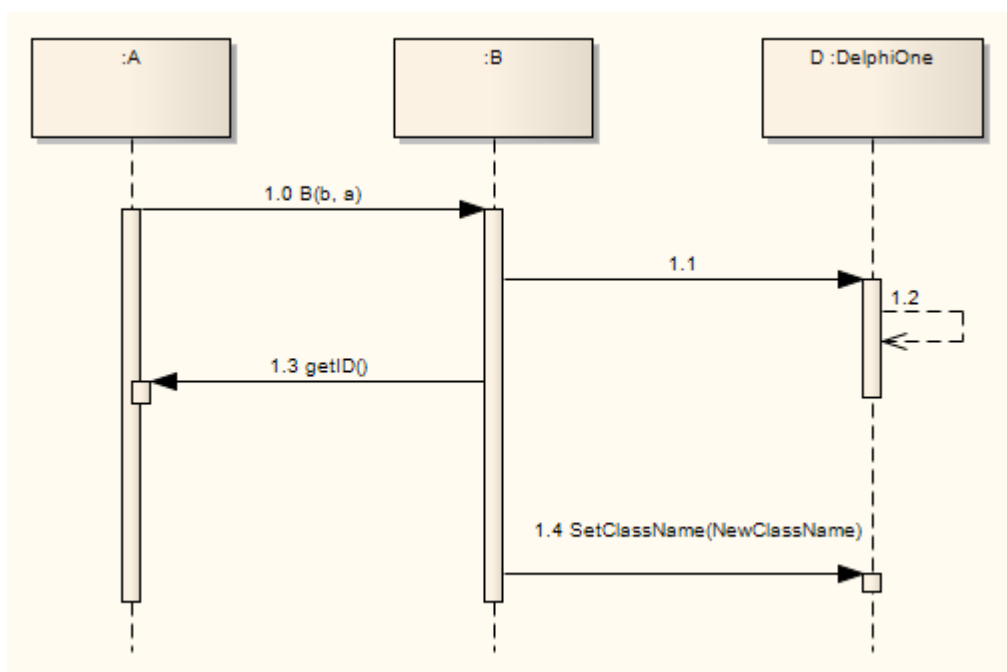

### 5.1.1.1.6.3 Sequence Elements

A [Sequence diagram](#) <sup>(706)</sup> models a dynamic view of the interactions between model elements at runtime.

Sequence diagrams are commonly used as explanatory models for Use Case scenarios. By creating a Sequence diagram with an Actor and elements involved in the Use Case, you can model the sequence of steps the user and the system undertake to complete the required tasks. An element in a Sequence diagram is usually either an Actor (the stimulus that starts the interaction) or a collaborating element.

#### Note:

A Sequence diagram is often attached directly under the Use Case to which it refers. This helps keep elements together, both in the model and when documentation is produced. To do this, right-click the Use Case on the diagram and select the **Advanced | Make Composite** context menu option.

The example below shows some possible elements of Sequence diagrams and their stereotyped display.

- *Actor* - An instance of an actor at runtime.
- *Lifeline* - An Object element with the stereotype Lifeline.
- *Boundary* - Represents a user interface screen or input/output device.
- *Entity* - A persistent element - typically implemented as a database table or element.
- *Control* - The active component that controls what work gets done, when and how.

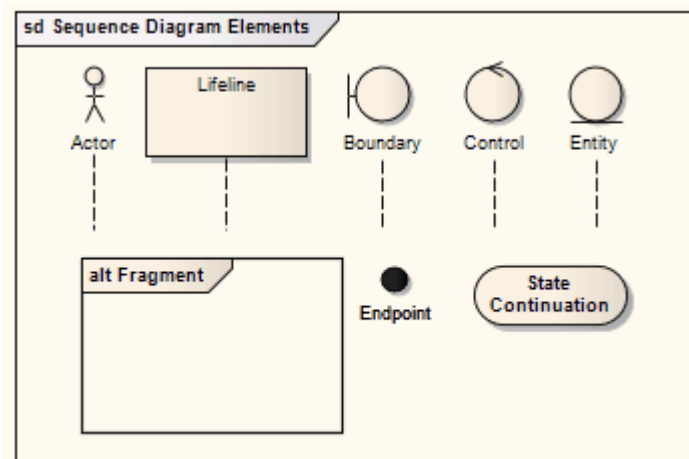

#### Tip:

Use Sequence diagrams early in analysis to capture the flow of information and responsibility throughout the system. Messages between elements eventually become method calls in the Class model.

### 5.1.1.1.6.4 Sequence Diagrams and Version Control

You might create Sequence diagrams that use elements from other packages as the Lifelines within the diagram. In such cases, the diagrams could be corrupted when the element packages are checked in and out under version control. This is because during checkout the elements are first deleted from the model and then re-imported, and although they are reinstated in the diagrams, any Messages connecting them are not.

So, if the diagram and its elements reside in different packages, a round-trip of the element package through version control might damage the Sequence diagram.

The solution is to drag-and-drop each Class onto the Sequence diagram as an *object* - when you drop the Class onto the Sequence diagram, in the **Paste Element** dialog select the **as Instance of Element (Object)** option. This creates a new object in the *diagram's* parent package, based on the selected Class element. You then create the Messages between the objects.

Therefore, to ensure that a Sequence diagram is not damaged by round-trips of other packages through version control, remember that:

- The Lifelines must be objects (even though Enterprise Architect allows you to drop elements as Lifelines onto a Sequence diagram, it is not a strictly UML compliant construct)

- The Lifelines must be in the same package as the diagram.

The following illustration shows the **Project Browser** with two packages: *P1*, containing the elements, and *P2*, containing a Sequence diagram that uses those elements. The diagram itself is also shown.

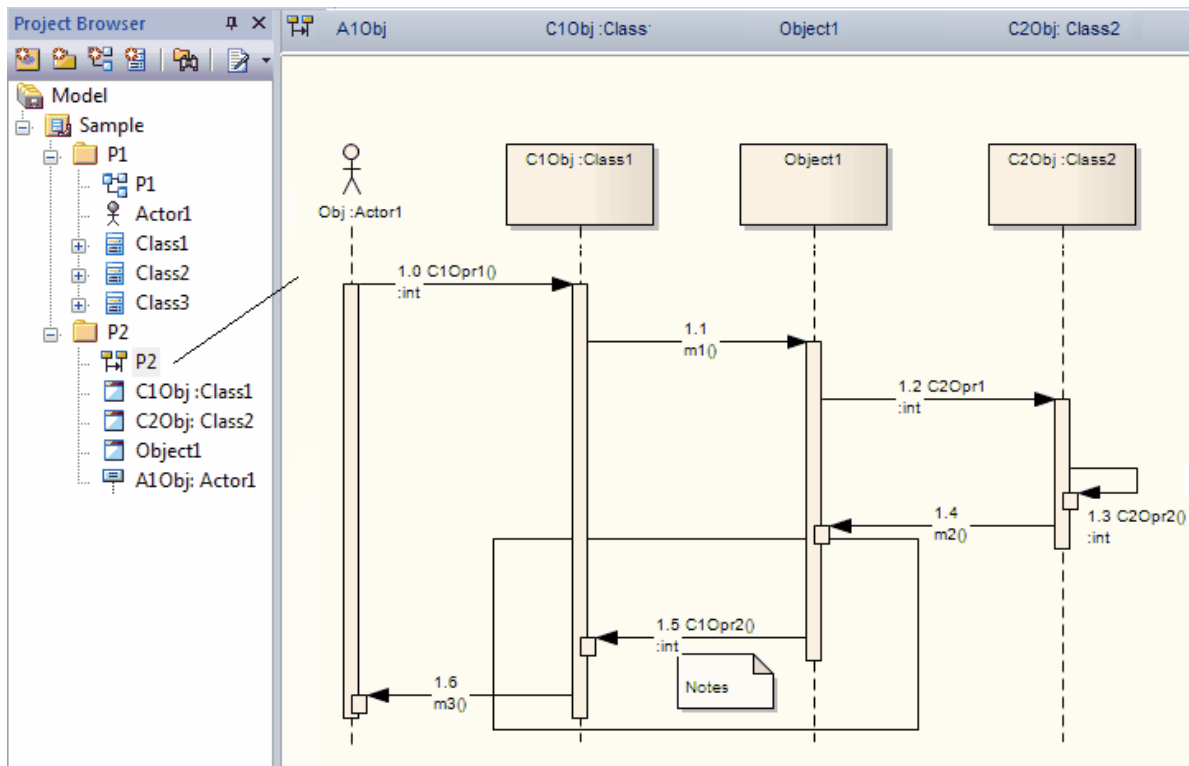

This diagram will not be damaged, because all the Lifelines are objects and these objects reside in the same package as the Sequence diagram.

#### 5.1.1.1.6.5 Sequence Element Activation

Sequence elements in a [Sequence diagram](#)<sup>[706]</sup> have *Activation rectangles* drawn along their lifelines. These rectangles describe the time the element is active during the overall period of processing. This visual representation can be suppressed by right-clicking the Sequence diagram, and selecting the **Suppress Activations** context menu option.

In general, Enterprise Architect calculates the period of activation for you, but in some cases you might want to fine tune the rectangle length. There are several context menu options on a sequence message that you can use to accomplish this. To access the following context menu, right-click on the message and select the **Activations** context menu option.

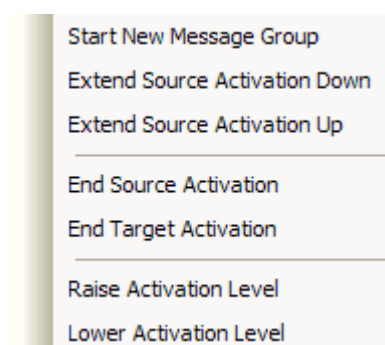

- **Start New Message Group:** Starts off a new round of processing in the current diagram. This enables you to describe more than one processing scenario in a single diagram.
- **Extend Source Activation Down:** Forces an element to stay active beyond the normal processing period. This could be used to express an element that continues its own processing concurrently with other

processes.

- **Extend Source Activation Up:** Forces an element's activation upwards.
- **End Source Activation:** Truncates the activation of the source element after the current message. This is useful for expressing an asynchronous message after which the source element becomes idle.
- **End Target Activation:** Ends a Forced Activation started by the **Extend Source Activation** options.

The **Raise Activation Level** and **Lower Activation Level** options display on the context menu only where their use is appropriate. For example, after a self-message the next message starts by default at a lower activation level but the **Raise Activation Level** command displays on the context menu to enable you to raise its level.

A more convenient way to change activation levels is directly on the diagram. Whenever appropriate, left and/or right arrows display on specific connectors. In the following diagram, see connector 1.3. Click on the arrow to raise or lower the activation level.

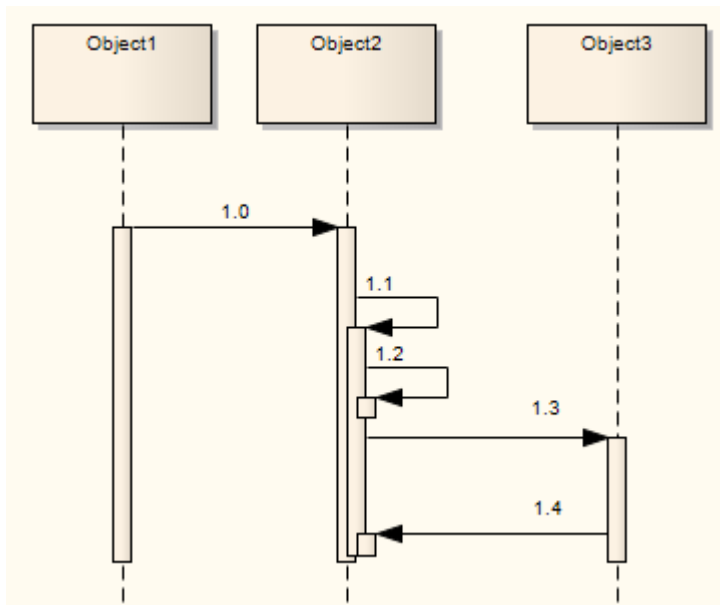

**Note:**

Program flow can more accurately be depicted with nested activation levels for callback messages.

#### 5.1.1.1.6.6 Lifeline Activation Levels

Complicated processing systems can be easily negotiated and reflected in Sequence diagrams, by adding activation layers on a single lifeline. For example, a Class invokes the method *Sample A*, which in turn calls *Sample A1*. To produce the arrangement in the diagram, select the **More tools | Interaction** menu option, click on the **Self-message** icon in the **Interaction Relationships** panel and then click on the lifeline.

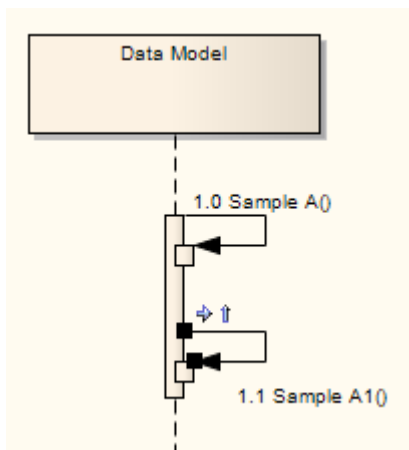

In order to raise the Activation level of *Sample A1*, click on the *raise arrow* of the selected connector. The lifeline now visually depicts that method *Sample A1* is called during the processing of *Sample A*.

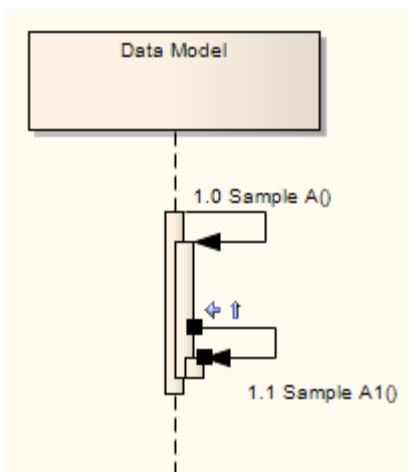

In the example below, a few more self-messages have been added. The message *Sample A2a* is called from *Sample A2* which in turn is called from *Sample A* (not *Sample A1*). *Sample A1* is called from *Sample A*.

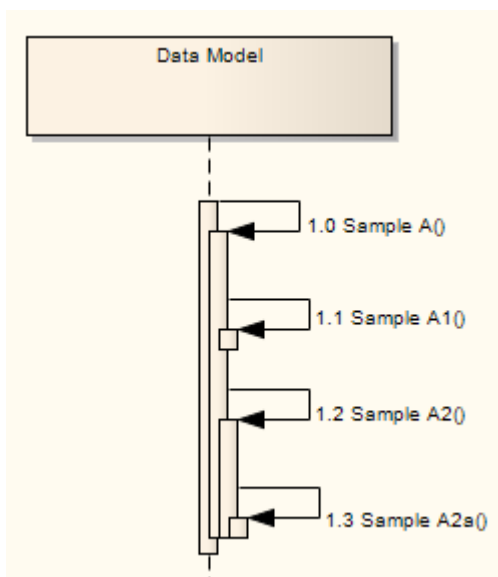

### 5.1.1.1.6.7 Sequence Message Label Visibility

On Sequence messages, you can control label visibility using the message context menu. To hide and show the labels used in Sequence messages, follow the steps below:

1. Right-click on the message within the Sequence diagram. The message context menu displays.
2. Select the **Set Label Visibility** menu option. The **Label Visibility** dialog displays.

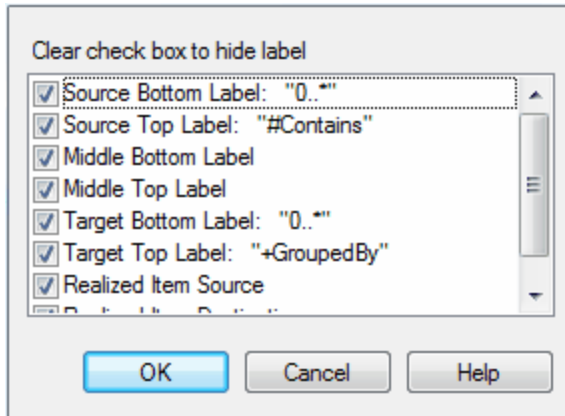

3. Select or clear the checkbox against each message label to display or hide, respectively.
4. Click on the **OK** button to save the settings.

### 5.1.1.1.6.8 Change the Top Margin

In order to change the top margin of a [Sequence diagram](#) <sup>[706]</sup> from the default 50 units, right-click on the diagram to display the context menu and select the **Set Top Margin** menu option. You can set the top margin to any value between 30 and 250 units.

### 5.1.1.1.6.9 Inline Sequence Elements

It is possible to represent [Part](#) <sup>[825]</sup> and [Port](#) <sup>[826]</sup> elements on a [Sequence diagram](#) <sup>[706]</sup>. Child Parts and Ports appear as inline sequence elements under their parent Class sequence element.

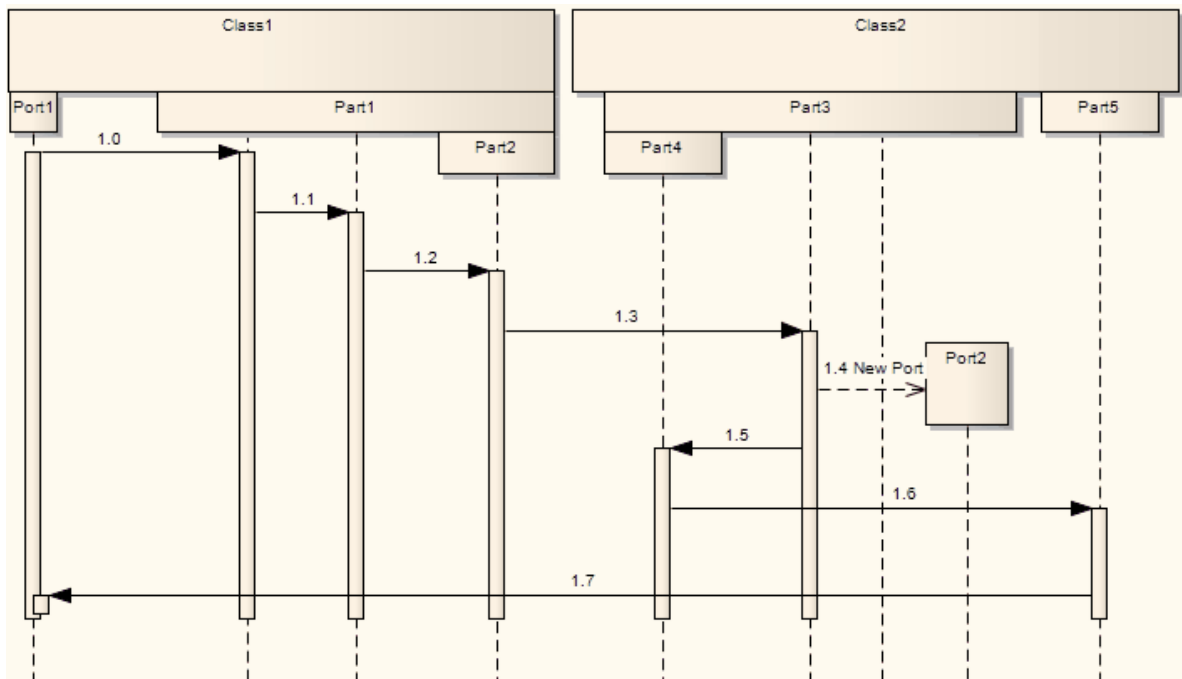

1. Right-click on the sequence elements containing the child Ports or Parts, to display the context menu.

2. Select the **Embedded Elements | Embedded Elements** menu option.
3. Select the checkbox against each Part or Port to show, and click on the **Close** button.

### 5.1.1.1.7 Communication Diagram

One of four types of *Interaction* diagram. (The other three are [Timing Diagrams](#)<sup>[690]</sup>, [Sequence Diagrams](#)<sup>[706]</sup> and [Interaction Overview Diagrams](#)<sup>[717]</sup>.)

A *Communication diagram* shows the interactions between elements at run-time in much the same manner as a Sequence diagram. However, Communication diagrams are used to visualize inter-object relationships, while Sequence diagrams are more effective at visualizing processing over time.

Communication diagrams employ ordered, labeled associations to illustrate processing. Numbering is important to indicate the order and nesting of processing. A numbering scheme could be:

- 1
- 1.1
- 1.1.1
- 1.1.2
- 1.2, and so on.

A new number segment begins for a new layer of processing, and would be equivalent to a method invocation.

*Robustness diagrams* are simplified Communication diagrams, but can be created in any diagram type that supports [Boundary](#)<sup>[836]</sup>, [Control](#)<sup>[838]</sup> and [Entity](#)<sup>[839]</sup> elements.

### Example Diagram

The example below illustrates a Communication diagram among cooperating object instances. Note the use of message levels to capture related flows, and the different [colors](#)<sup>[716]</sup> of the [messages](#)<sup>[879]</sup>.

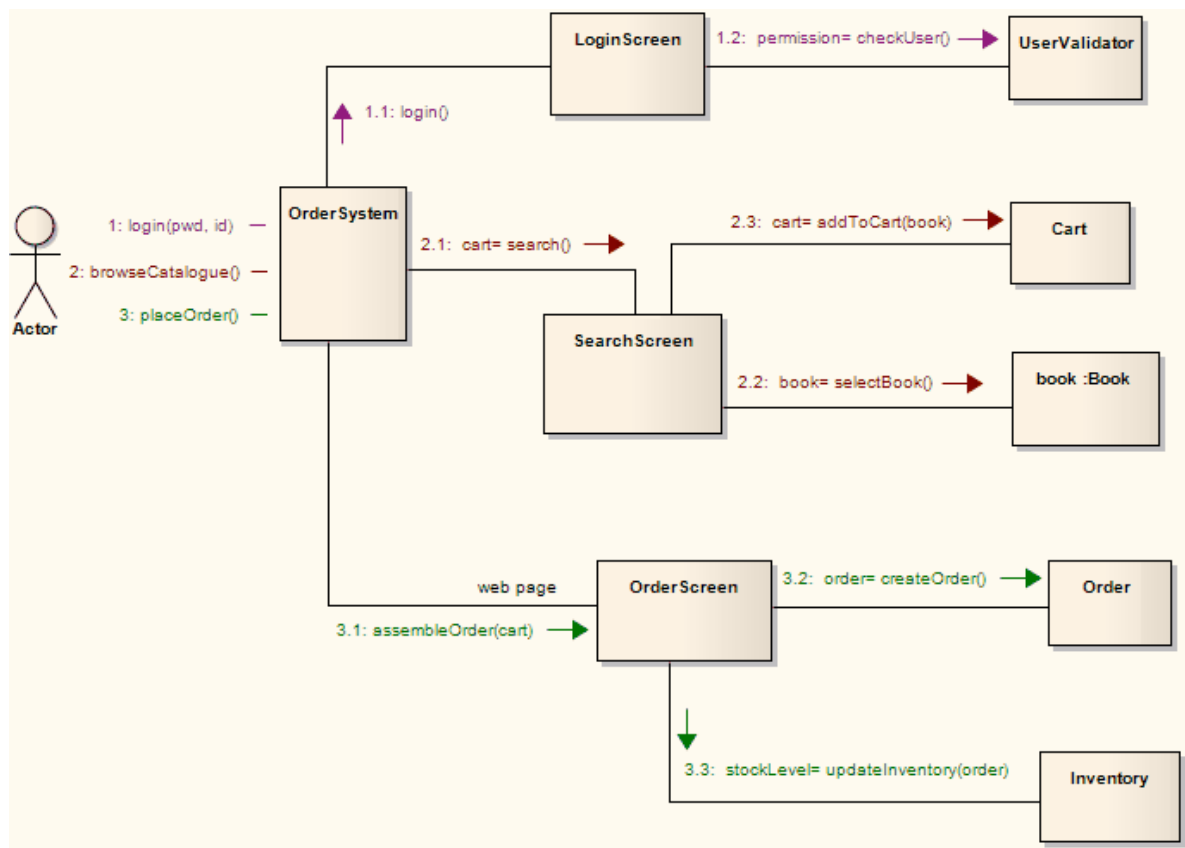









### Toolbox Elements and Connectors

Select Communication diagram elements and connectors from the [Communication](#)<sup>[409]</sup> [pages](#)<sup>[409]</sup> of the [Toolbox](#).

**Tip:**

Click on the following elements and connectors for more information.

Communication Diagram Elements	Communication Diagram Connectors
 Actor	 Associate
 Object	 Nesting
 Boundary	 Realize
 Control	
 Entity	
 Package	

## OMG UML Specification

The OMG UML specification (*UML Superstructure Specification, v2.1.1, p. 511*) states:

*Communication Diagrams focus on the interaction between Lifelines where the architecture of the internal structure and how this corresponds with the message passing is central. The sequencing of Messages is given through a sequence numbering scheme.*

*Communication Diagrams correspond to simple Sequence Diagrams that use none of the structuring mechanisms such as InteractionUses and CombinedFragments. It is also assumed that message overtaking (i.e., the order of the receptions are different from the order of sending of a given set of messages) will not take place or is irrelevant.*

**Note:**

Communication diagrams were known as Collaboration diagrams in UML 1.4.

### 5.1.1.1.7.1 Communication Diagrams in Color

Enterprise Architect enables you to highlight particular message flows in a [Communication diagram](#)<sup>[715]</sup> using different colors for each message set.

To highlight the colors in a Communication diagram, follow the steps below:

1. Select the **Tools | Options | Communication Colors** menu option. The **Communication Message Coloring** page of the **Options** dialog displays.
2. Select the **Use Communication Color** checkbox.
3. Click on the drop-down arrow of each **Message n** field, and select the required color for each message group.
4. Click on the **Close** button. On your Communication diagram, each sequence group of messages displays in a different color as shown below.



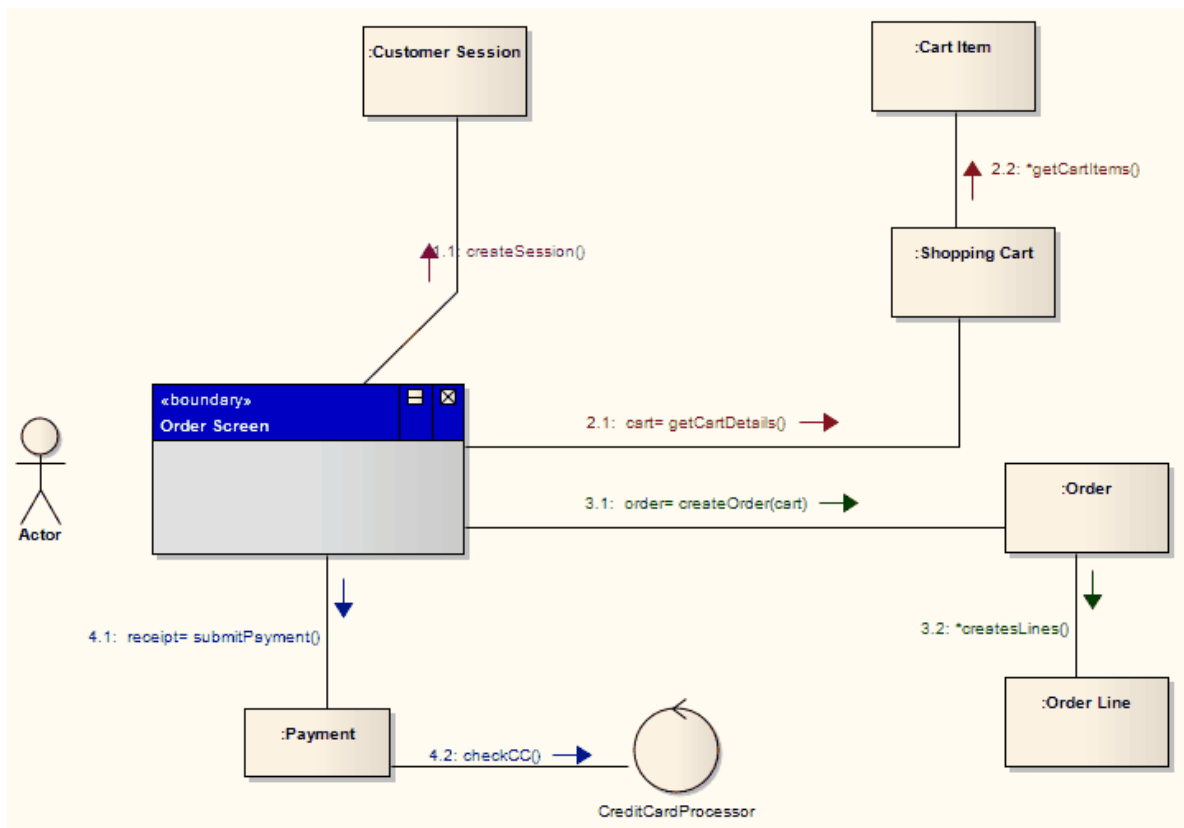

#### 5.1.1.1.8 Interaction Overview Diagram

One of four types of *Interaction* diagram. (The other three are [Timing Diagrams](#)<sup>[690]</sup>, [Sequence Diagrams](#)<sup>[706]</sup> and [Communication Diagrams](#)<sup>[715]</sup>.)

*Interaction Overview* diagrams visualize the cooperation between other interaction diagrams to illustrate a control flow serving an encompassing purpose. As *Interaction Overview* diagrams are a variant of [Activity diagrams](#)<sup>[674]</sup>, most of the diagram notation is the same, as is the process of constructing the diagram. Decision points, Forks, Joins, Start points and End points are the same. Instead of [Activity](#)<sup>[753]</sup> elements, however, rectangular elements are used. There are two types of these elements:

- [Interaction](#)<sup>[779]</sup> elements display an inline *Interaction* diagram, which can be any one of the four types
- [Interaction Occurrence](#)<sup>[780]</sup> elements are references to an existing *Interaction* diagram: they are visually represented by a frame, with **ref** in the frame's title space; the diagram name is indicated in the frame contents.

To create an *Interaction Occurrence*, simply drag an *Interaction* diagram from the **Project Browser** onto your *Interaction Overview* diagram. The **ref** frame displays, encapsulating an instance of the *Interaction* diagram.

#### Example Diagram

The following example depicts a sample sale process, shown in an *Interaction Overview* diagram, with sub-processes abstracted within *Interaction Occurrences*. The diagram appears very similar to an *Activity* diagram, and is conceptualized the same way; as the flow moves into an *interaction*, the respective *interaction's* process must be followed before the *Interaction Overview's* flow can advance.

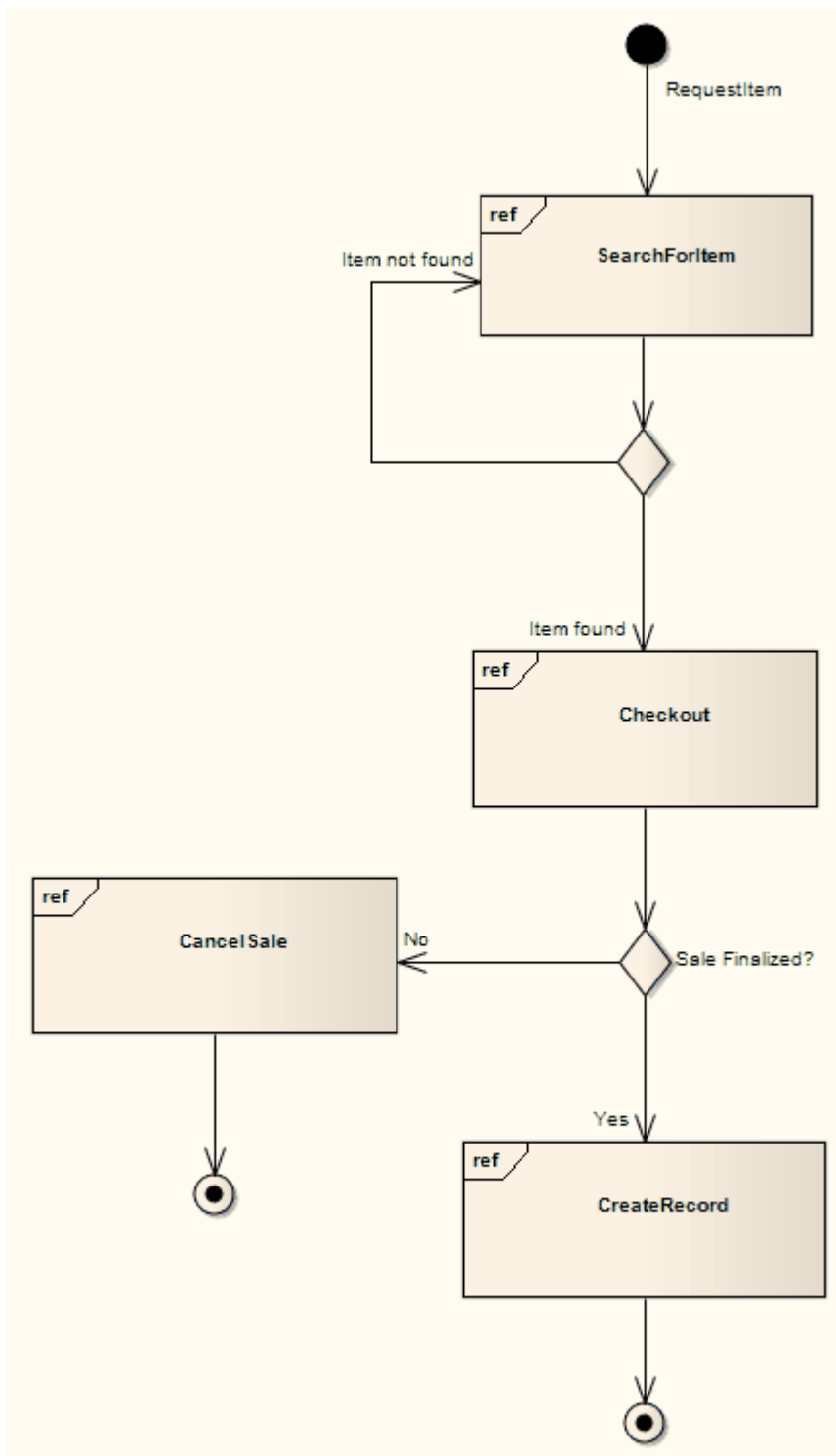

















### Toolbox Elements and Connectors

Select Interaction Overview diagram elements and connectors from the [Activity](#) <sup>[412]</sup> [pages](#) <sup>[412]</sup> of the **Toolbox**.

#### Tip:

Click on the following elements and connectors for more information.

Interaction Overview Diagram Elements	Interaction Overview Diagram Connectors
 Partition	 Control Flow
 Decision	 Object Flow
 Send	 Interrupt Flow
 Receive	
 Synch	
 Initial	
 Final	
 Flow Final	
 Region	
 Exception	
 Merge	
 Fork/Join	
 Fork/Join	

## OMG UML Specification

The OMG UML specification (*UML Superstructure Specification, v2.1.1, p. 514*) states:

*Interaction Overview Diagrams define Interactions (described in Chapter 14, "Interactions") through a variant of Activity Diagrams (described in Chapter 6, "Activities") in a way that promotes overview of the control flow.*

*Interaction Overview Diagrams focus on the overview of the flow of control where the nodes are Interactions or InteractionUses. The Lifelines and the Messages do not appear at this overview level.*

### 5.1.1.2 Structural Diagrams

*Structural diagrams depict the structural elements composing a system or function. These diagrams reflect the static relationships of a structure, such as Class or Package diagrams, or run-time architectures such as Object or Composite Structure diagrams.*

Structural diagrams include the following diagram types:

#### Class Diagrams

[Class diagrams](#)<sup>[721]</sup> capture the logical structure of the system, the Classes and objects that make up the model, describing what exists and what attributes and behavior it has.

#### Composite Structure Diagrams

[Composite Structure diagrams](#)<sup>[724]</sup> reflect the internal collaboration of Classes, Interfaces and Components (and their properties) to describe a functionality.

## Component Diagrams

[Component diagrams](#) <sup>[730]</sup> illustrate the pieces of software, embedded controllers and such that make up a system, and their organization and dependencies.

## Deployment Diagrams

[Deployment diagrams](#) <sup>[727]</sup> show how and where the system is to be deployed; that is, its execution architecture.

## Object Diagrams

[Object diagrams](#) <sup>[723]</sup> depict object instances of Classes and their relationships at a point in time.

## Package Diagrams

[Package diagrams](#) <sup>[720]</sup> depict the organization of model elements into packages and the dependencies amongst them.

## Profile Diagrams

[Profile Diagrams](#) <sup>[732]</sup> are those created in a <<profile>> package, to extend UML elements, connectors and components.

### 5.1.1.2.1 Package Diagram

*Package diagrams* depict the organization of model elements into packages and the dependencies amongst them, including package imports and package extensions. They also provide a visualization of the corresponding namespaces.

The following example demonstrates a basic Package diagram.

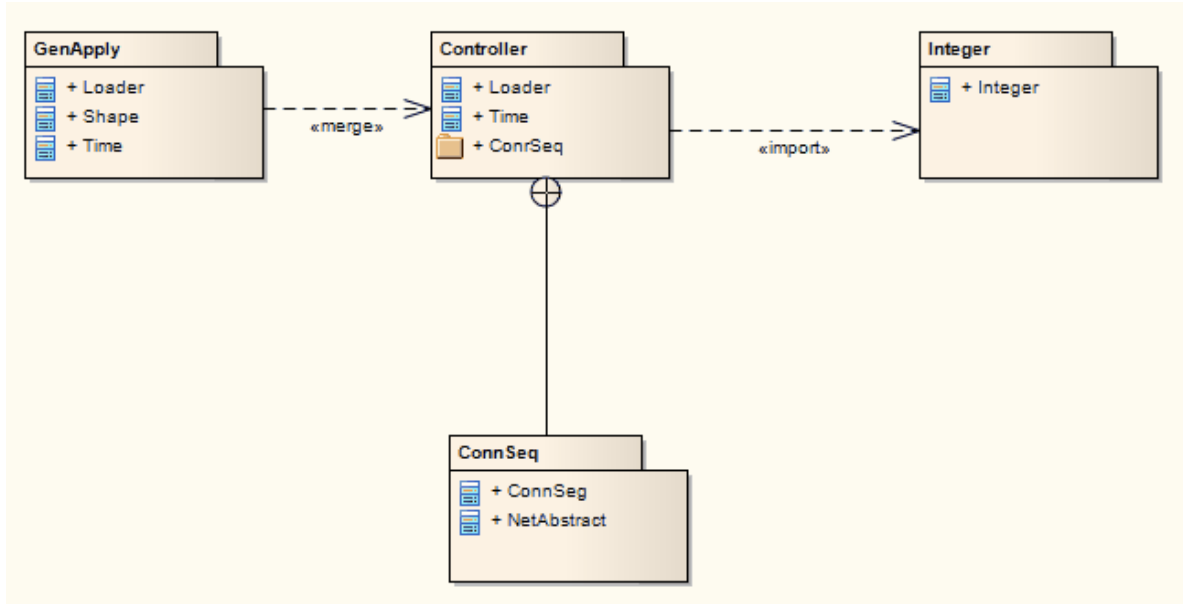

The nesting connector between *ConnSeq* and *Controller* reflects what the package contents reveal. Package contents can be listed by clicking on the diagram background to display the diagram's [Properties](#) <sup>[423]</sup> dialog, selecting the **Elements** tab and selecting the **Package Contents** checkbox.

The `«import»` connector indicates that the elements within the target *Integer* package, which in this example is the single Class *Integer*, are imported into the package *Controller*. The *Controller*'s namespace gains access to the *Integer* Class; the *Integer* namespace is not affected.

The `«merge»` connector indicates that the package *Controller*'s elements are imported into *GenApply*, including *Controller*'s nested and imported contents. If an element already exists within *GenApply*, such as *Loader* and *Time*, these elements' definitions are expanded by those included in the package *Controller*. All

elements added or updated by the merge are noted by a generalization relationship back to that package.

#### Notes:



















- Private elements within a package cannot be imported or merged.
- If you click on an element listed in a package, and then double-click, you can display and edit the [element properties](#) <sup>[46†]</sup>.

## Toolbox Elements and Connectors

Select Package diagram elements and connectors from the [Class](#) <sup>[407]</sup> [pages](#) <sup>[407]</sup> of the **Toolbox**.

#### Tip:

Click on the following elements and connectors for more information.

Package Diagram Elements	Package Diagram Connectors
 Package	 Associate
 Class	 Generalize
 Interface	 Compose
 Data Type	 Aggregate
 Enumeration	 Association Class
 Primitive	 Assembly
 Table	 Realize
 Signal	 Nesting
 Association	 Package Merge
	 Package Import

### 5.1.1.2.2 Class Diagram

The *Class* diagram captures the logical structure of the system: the [Classes](#) <sup>[81†]</sup> - including [Active](#) <sup>[812]</sup> and [Parameterized](#) <sup>[813]</sup> (template) Classes - and things that make up the model. It is a static model, describing what exists and what attributes and behavior it has, rather than how something is done. Class diagrams are most useful to illustrate relationships between Classes and Interfaces. Generalizations, Aggregations and Associations are all valuable in reflecting inheritance, composition or usage, and connections, respectively.

## Example Diagram

There are two forms of the [Aggregation](#) <sup>[854]</sup> relationship in the following diagram. The pale form indicates that the Class *Account* uses *AddressBook*, but does not necessarily contain *AddressBook*. The dark *Composite* Aggregation form indicates ownership or containment by the target Classes (at the diamond end) of the source Classes.

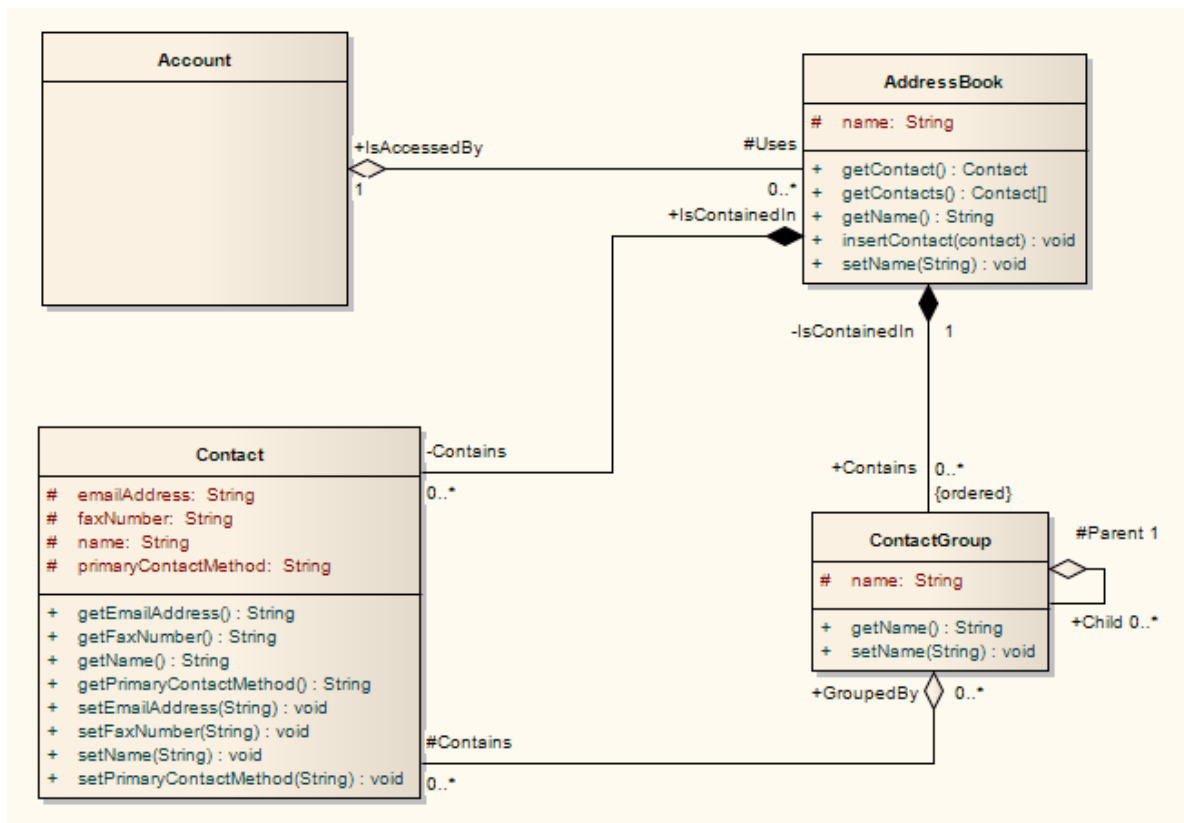

## Toolbox Elements and Connectors



Select Class diagram elements and connectors from the [Class](#) <sup>[407]</sup> pages of the **Toolbox**.

Enterprise Architect also supports a number of [stereotyped Class](#) <sup>[739]</sup> elements to represent various entities in web page modeling.

### Tip:

Click on the following elements and connectors for more information.

Class Diagram Elements	Class Diagram Connectors
Package	Associate
Class	Generalize
Interface	Compose
Data Type	Aggregate
Enumeration	Association Class
Primitive	Assembly
Table	Realize
Signal	Nesting

Class Diagram Elements	Class Diagram Connectors
 Association	 Package Merge
	 Package Import

### 5.1.1.2.3 Object Diagram

An *Object diagram* is closely related to a [Class diagram](#)<sup>[721]</sup>, with the distinction that it depicts object instances of Classes and their relationships at a point in time. This might appear similar to a [Composite Structure](#)<sup>[724]</sup> diagram, which also models run-time behavior; the difference is that Object diagrams exemplify the static Class diagrams, whereas Composite Structure diagrams reflect run-time architectures different from their static counterparts. Object diagrams do not reveal architectures varying from their corresponding Class diagrams, but reflect multiplicity and the roles instantiated Classes could serve. They are useful in understanding a complex Class diagram, by creating different cases in which the relationships and Classes are applied. An Object diagram can also be a kind of [Communication diagram](#)<sup>[715]</sup>, which also models the connections between objects, but additionally sequences events along each path.

#### Note:

Communication diagrams were known as Collaboration diagrams in UML 1.4.

### Example Diagram

The following example first shows a simple Class diagram, with two [Class](#)<sup>[811]</sup> elements connected.

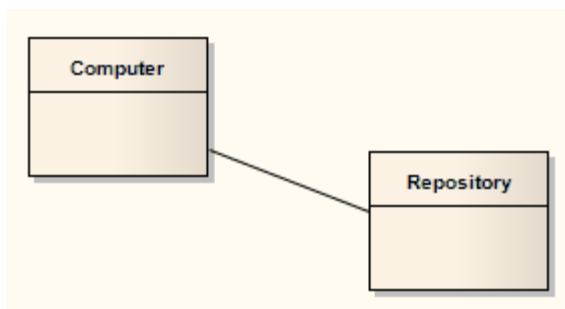

The Classes above are instantiated below as Objects in an Object diagram. There are two instances of *Computer* in this model, which can prove useful for considering the relationships and interactions Classes play in practice, as Objects.

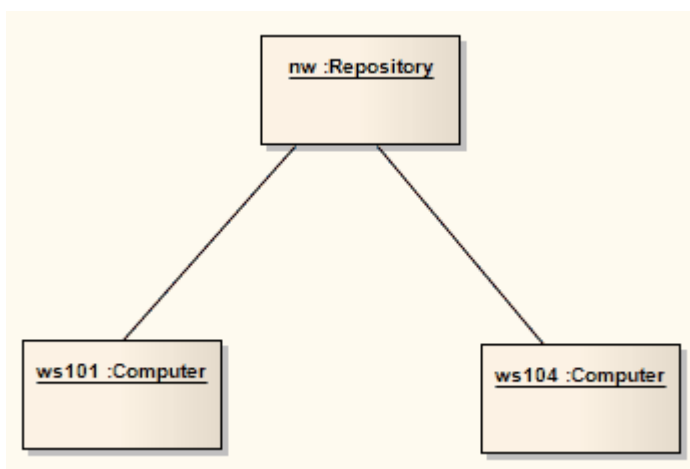











## Toolbox Elements and Connectors

Select Object diagram elements and connectors from the [Object](#) <sup>[408]</sup> pages of the [Toolbox](#).

Enterprise Architect also supports a number of [stereotyped Object](#) <sup>[739]</sup> elements to represent various entities in business modeling.

### Tip:

Click on the following elements and connectors for more information.

Object Diagram Elements	Object Diagram Connectors
 Actor	 Information Flow
 Object	 Associate
 Collaboration	 Dependency
 Information Item	
 Boundary	
 Control	
 Entity	

### 5.1.1.2.4 Composite Structure Diagram

A *Composite Structure* diagram reflects the internal collaboration of [Classes](#) <sup>[811]</sup>, [Interfaces](#) <sup>[821]</sup> or [Components](#) <sup>[816]</sup> (and their [Properties](#) <sup>[726]</sup>) to describe a functionality. Composite Structure diagrams are similar to [Class diagrams](#) <sup>[721]</sup>, except that they model a specific usage of the structure. Class diagrams model a static view of Class structures, including their attributes and behaviors. A Composite Structure diagram is used to express run-time architectures, usage patterns and the participating elements' relationships, which might not be reflected by static diagrams.

In a Composite Structure diagram, Classes are accessed as [Parts](#) <sup>[825]</sup> or run-time instances fulfilling a particular role. These Parts can have multiplicity, if the role filled by the Class requires multiple instances. [Ports](#) <sup>[826]</sup> defined by a Part's Class should be represented in the composite structure, maintaining that all connecting Parts provide the required interfaces specified by the Port. There is extensive flexibility, and an ensuing complexity, that come with modeling composite structures. To optimize your modeling, consider building [Collaborations](#) <sup>[814]</sup> to represent reusable patterns responding to your design issues.

### Example Diagram

The following diagram shows a Collaboration used in Composite Structure diagrams to model common patterns. This particular example shows a relationship for performing an installation.



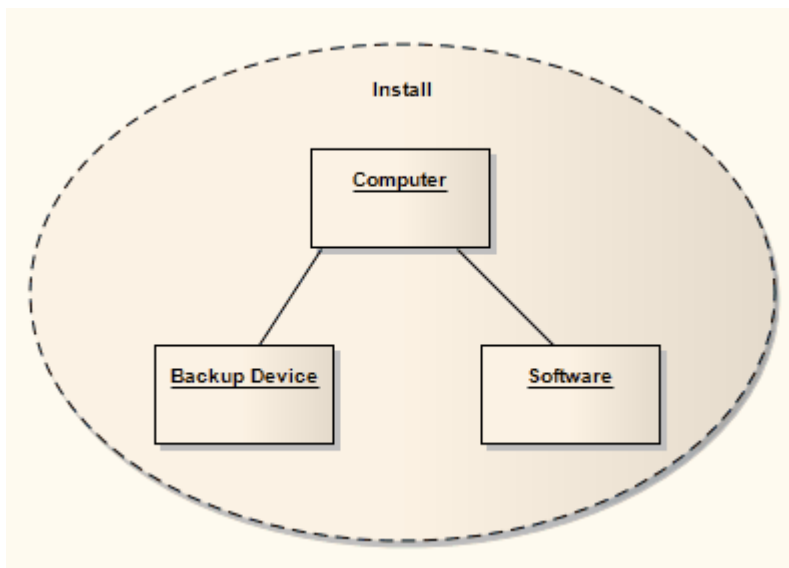

The following diagram uses the *Install* Collaboration in a [Collaboration Occurrence](#)<sup>[815]</sup>, and applies it to the *UtilLoad* Class via a «represents» relationship. This indicates that the classifier *UtilLoad* uses the collaboration pattern within its implementation.

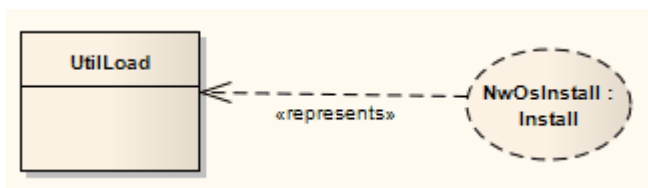

For further examples of Composite Structure diagrams, see the [Toolbox](#) elements listed below.

### Toolbox Elements and Connectors

Select Composite Structure diagram elements and connectors from the [Composite](#)<sup>[409]</sup> pages of the [Toolbox](#).

Enterprise Architect also supports a stereotyped Collaboration to represent a [Business Use Case Realization](#)<sup>[739]</sup> in business modeling.

#### Tip:

Click on the following elements and connectors for more information.

Composite Structure Diagram Elements	Composite Structure Diagram Connectors
Class	Connector
Interface	Assembly
Part	Role Binding
Port	Represents
Collaboration	Occurrence
Expose Interface	Delegate

## OMG UML Specification

The OMG UML specification (*UML Superstructure Specification, v2.1.1, p. 193*) states:

*A composite structure diagram depicts the internal structure of a classifier, as well as the use of a collaboration in a collaboration use.*

### 5.1.1.2.4.1 Properties

A *property* is a nested structure within a classifier, which is usually a [Class](#)<sup>[81†]</sup> or an [Interface](#)<sup>[82†]</sup> on a [Composite Structure diagram](#)<sup>[72†]</sup>. The contained structure reflects instances and relationships reflected within the containing classifier. Properties can have multiplicity.

To demonstrate properties, consider the following diagram, which demonstrates some properties of the *Library* Class.

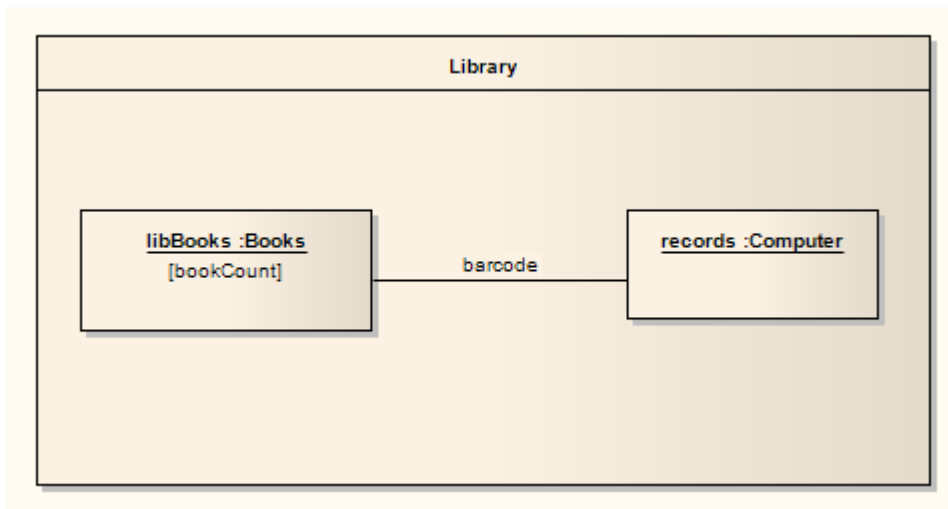

There are two [Parts](#)<sup>[825]</sup>, *libBooks* and *records*, which are instances corresponding to the Classes *Books* and *Computer* respectively. After dragging Parts from the **Toolbox** out to the workspace, right-click on a Part and select the **Advanced | Set Property Type** context menu option to connect to a classifier.

#### Note:

If Parts disappear when dragged onto the Class, adjust the Z-order of the Class (right-click on it and select the **Z-Order** context menu option).

The relationship between the two Parts is indicated by the connector, reflecting that communication between the Parts is via the *barcode*. This contained structure and its Parts are properties owned by the Library Class. To indicate a property that is not owned by composition to the containing classifier, use a box symbol with a dashed outline, indicating *association*. To do this, right-click on the Part and select the **Advanced | Custom Properties** context menu option. Set the **IsReference** option to **true**.

Properties can also be reflected using a normal composite structure (without containing it in a Class), with the appropriate connectors, parts and relationships indicated through connections to the Class. This alternative representation is shown in the following diagram. However, this depiction fails to express the ownership immediately reflected by containing properties within a classifier.

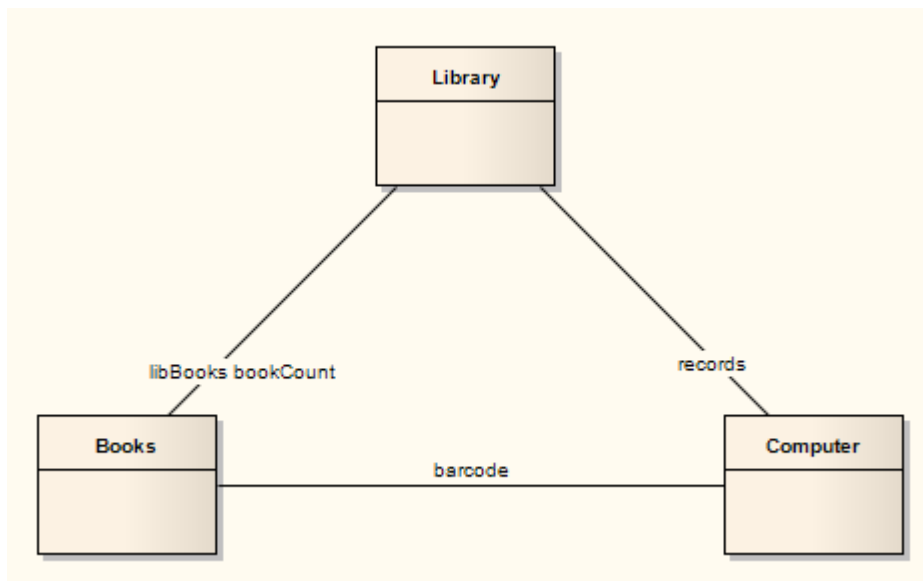

#### 5.1.1.2.5 Deployment Diagram

A *Deployment diagram* shows how and where the system is to be deployed; that is, its execution architecture. Hardware devices, processors and software execution environments (system [Artifacts](#)<sup>[810]</sup>) are reflected as [Nodes](#)<sup>[822]</sup>, and the internal construction can be depicted by embedding or nesting Nodes. [Deployment](#)<sup>[862]</sup> relationships indicate the deployment of Artifacts, and [Manifest](#)<sup>[867]</sup> relationships reveal the physical implementation of components. As Artifacts are allocated to Nodes to model the system's deployment, the allocation is guided by the use of *deployment specifications*.

A simple Deployment diagram is shown below, representing the arrangement of servers at a head office. The servers are represented by Nodes linked by either simple or aggregate Association relationships.

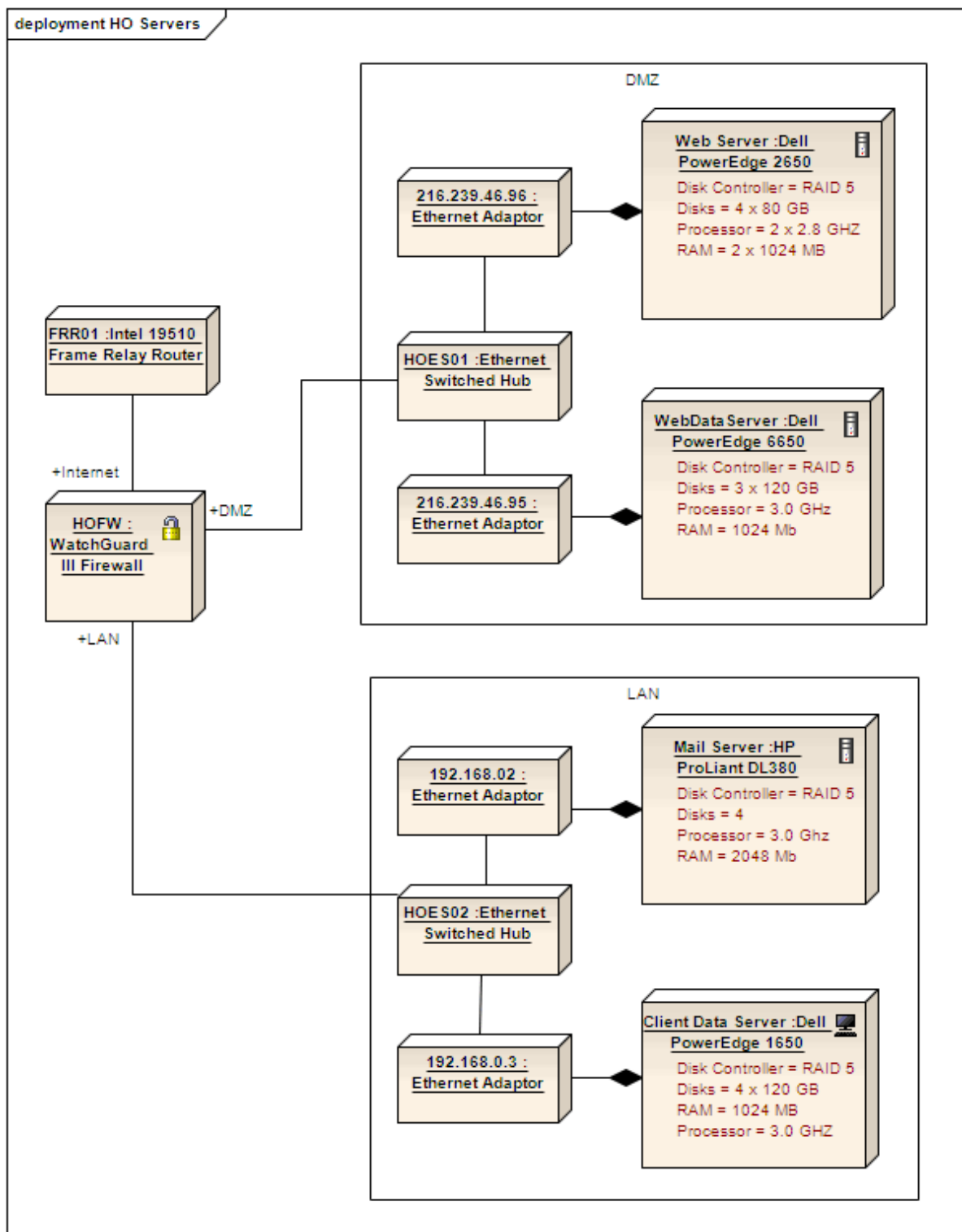

Deployment diagrams are ideal for using [alternative images](#)<sup>[447]</sup> for the objects that the elements represent. Such images can be substituted for the elements in the above diagram, as shown below:

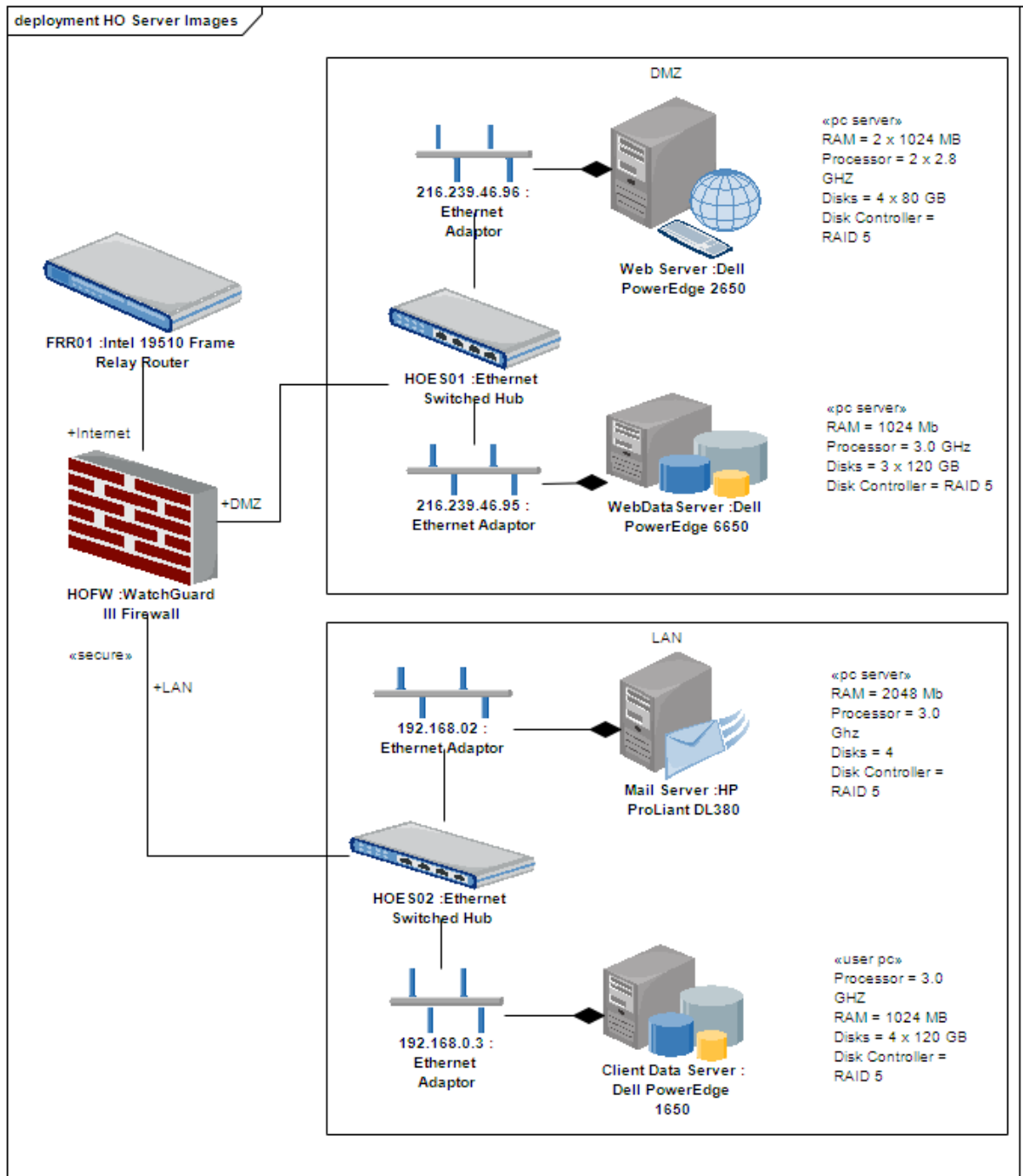















### Toolbox Elements and Connectors

Select Deployment diagram elements and connectors from the [Deployment](#) <sup>[413]</sup> pages of the [Toolbox](#).

**Tip:**

Click on the following elements and connectors for more information.

Deployment Diagram Elements	Deployment Diagram Connectors
Node	Associate

Deployment Diagram Elements	Deployment Diagram Connectors
 Device	 Communication Path
 Execution Environment	 Association Class
 Component	 Generalize
 Interface	 Realize
 Artifact	 Deployment
 Document Artifact	 Manifest
 Deployment Specification	 Nesting
 Package	

#### 5.1.1.2.6 Component Diagram

A *Component* diagram illustrates the pieces of software, embedded controllers and such that make up a system, and their organization and dependencies. A Component diagram has a higher level of abstraction than a [Class diagram](#)<sup>[72]</sup>; usually a component is implemented by one or more [Classes](#)<sup>[81]</sup> (or [Objects](#)<sup>[82]</sup>) at runtime. They are building blocks, built up so that eventually a component can encompass a large portion of a system.

#### Example Diagram

The following diagram demonstrates some components and their inter-relationships. [Assembly](#)<sup>[85]</sup> connectors connect the provided interfaces supplied by *Product* and *Customer* to the required interfaces specified by *Order*. A [Dependency](#)<sup>[86]</sup> relationship maps a customer's associated account details to the required interface *Payment*, indicated by *Order*.

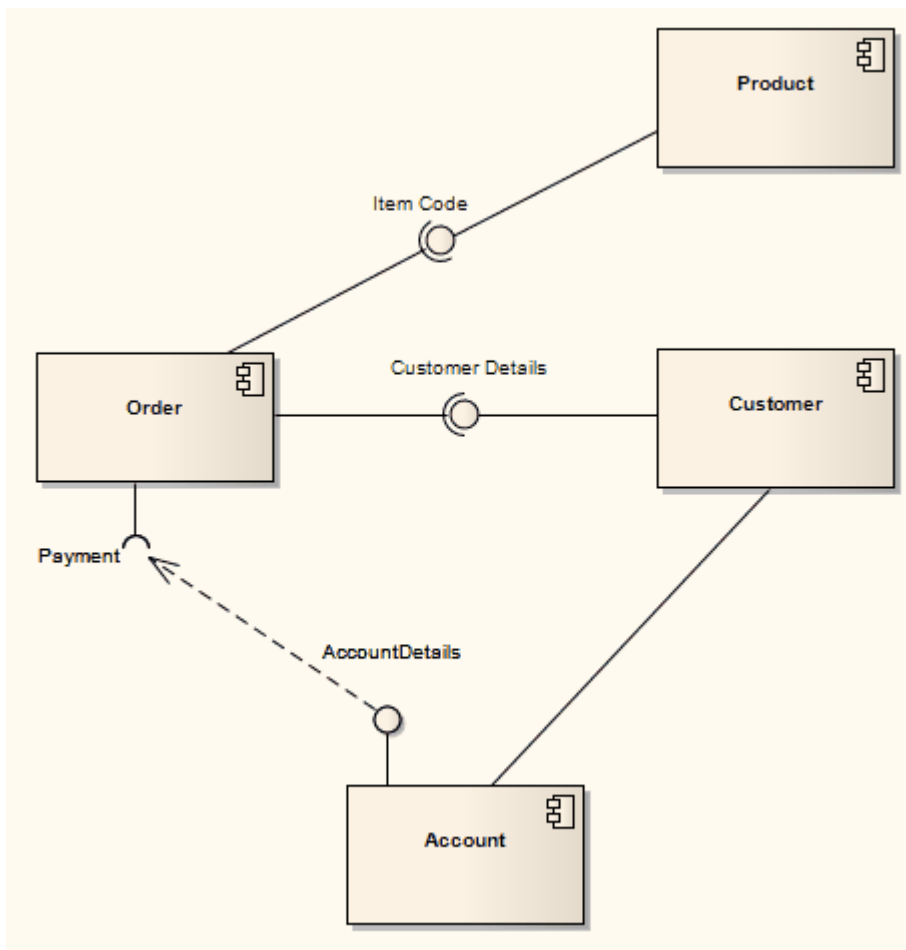



### Toolbox Elements and Connectors

Select Component diagram elements and connectors from the [Component](#) <sup>[412]</sup> pages of the [Toolbox](#).

#### Tip:

Click on the following elements and connectors for more information.

Component Diagram Elements	Component Diagram Connectors
Package	Assembly
Packaging Component	Delegate
Component	Associate
Class	Realize
Interface	Generalize
Object	
Port	

Component Diagram Elements	Component Diagram Connectors
 Expose Interface	
 Artifact	
 Document Artifact	

### 5.1.1.2.7 Profile Diagram

A *Profile* diagram is any diagram created in a <<profile>> package.

Profiles provide a means of extending the UML. They are based on additional stereotypes and Tagged Values that are applied to UML elements, connectors and their components. A Profile is a collection of such *extensions* that together describe some particular modeling problem and facilitate modeling constructs in that domain.





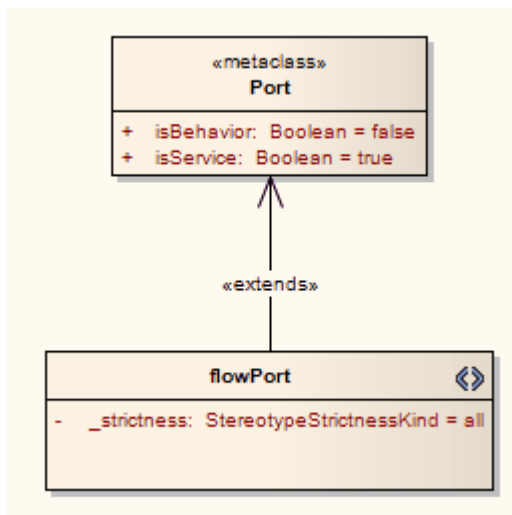



For information on creating a Profile diagram, see the [Developing Profiles](#)<sup>[1095]</sup> and [Create Profiles](#)<sup>[1095]</sup> topics.

A typical unit on a Profile diagram resembles the following illustration:



### Toolbox Elements and Connectors

Select the following Profile diagram elements and connectors from the [Profile](#)<sup>[414]</sup> pages of the [Toolbox](#).

Profile Diagram Elements	Profile Diagram Connectors
 Profile	 Extension
 Stereotype	 Generalize
 Metaclass	 Application
 Enumeration	 Tagged Value
	 Redefinition



### 5.1.1.3 Extended Diagrams

In addition to diagrams defined by the UML, Enterprise Architect provides some extended diagram platforms to model business processes or develop custom diagrams.

- [Analysis Diagram](#) <sup>[733]</sup>
- [Custom Diagram](#) <sup>[734]</sup>
- [Requirements Diagram](#) <sup>[736]</sup>
- [Maintenance Diagram](#) <sup>[737]</sup>
- [User Interface Diagram](#) <sup>[738]</sup>
- [Database Schema](#) <sup>[739]</sup>
- [Documentation](#) <sup>[1616]</sup>
- [Business Modeling and Business Interaction](#) <sup>[739]</sup>

#### 5.1.1.3.1 Analysis Diagram

An *Analysis diagram* is a simplified [Activity diagram](#) <sup>[674]</sup>, which is used to capture high level business processes and early models of system behavior and elements. It is less formal than some other diagrams, but provides a good means of capturing the essential business characteristics and requirements.

Enterprise Architect supports some of the [Eriksson-Penker Business Extensions](#) <sup>[1080]</sup> that facilitate [business process modeling](#) <sup>[930]</sup>. The complete Eriksson-Penker Business Extensions UML Profile can also be loaded into Enterprise Architect and used to create detailed process models.

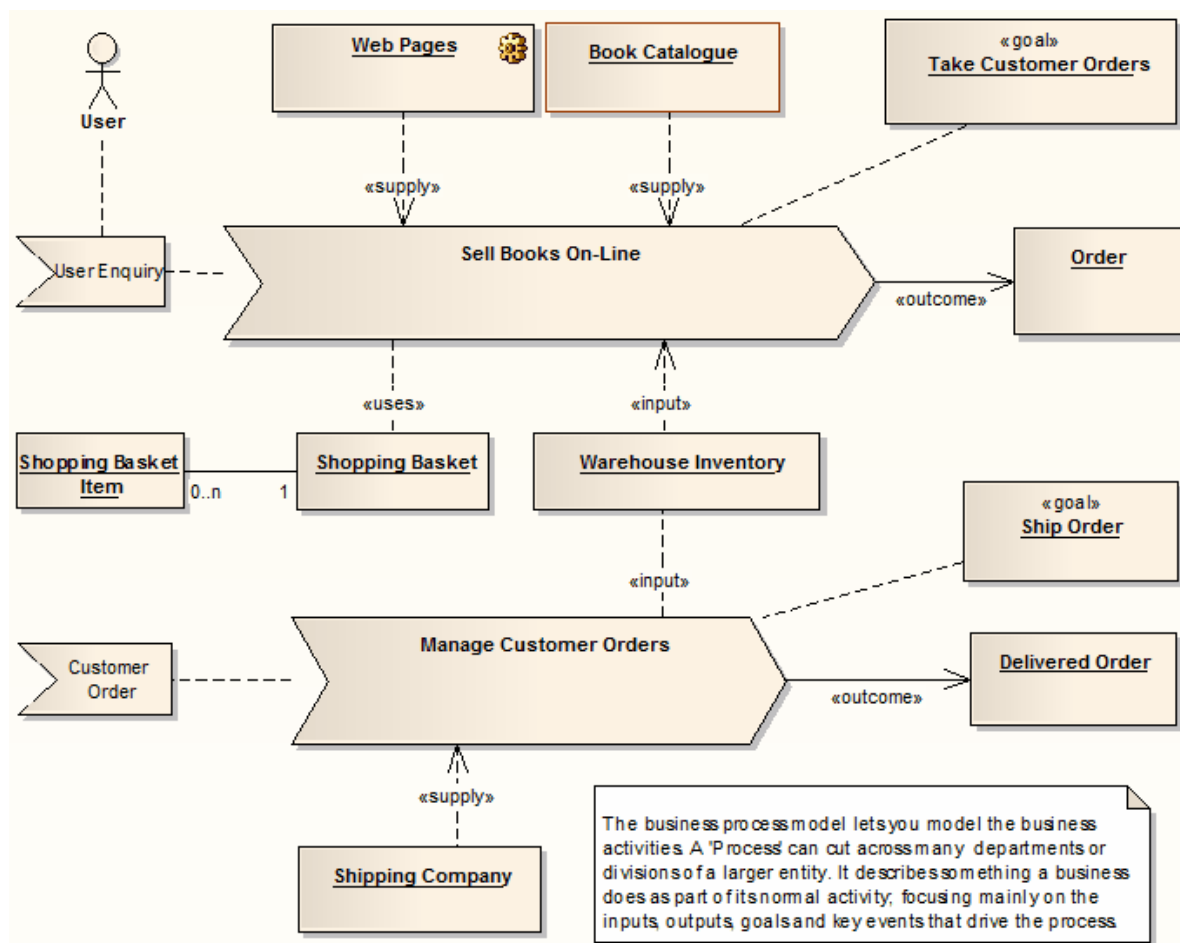



















*Robustness diagrams*, used extensively in [ICONIX](#) <sup>[1084]</sup>, can be created as Analysis diagrams.

### Toolbox Elements and Connectors

Select Analysis diagram elements and connectors from the [Analysis](#) <sup>[416]</sup> pages of the [Toolbox](#).

**Tip:**

Click on the following elements and connectors for more information. The *Information* element is a simple flow-chart representation of data or input/output.

Analysis Diagram Elements	Analysis Diagram Connectors
 Actor	 Information Flow
 Object	 Object Flow
 Process	 Associate
 Collaboration	 Realize
 Send	 Representation
 Receive	
 Information	
 Information Item	
 Decision	
 Merge	
 Boundary	
 Control	
 Entity	

### 5.1.1.3.2 Custom Diagram

A *Custom* diagram is an extended [Class diagram](#)<sup>[721]</sup> that is used to capture requirements, user interfaces or custom-design models.

The below example reflects a [Requirements diagram](#)<sup>[736]</sup>. [Requirement elements](#)<sup>[846]</sup> can be linked back to [Use Cases](#)<sup>[806]</sup> and [Components](#)<sup>[816]</sup> in the system to illustrate how a particular system requirement is met. [Change](#)<sup>[1564]</sup> and [Defect \(Issue\)](#)<sup>[1563]</sup> elements look the same as Requirement elements and can be coded and managed in the same way.

Screen design is supported through a stereotyped [Screen](#)<sup>[847]</sup> element and [UI Controls](#)<sup>[849]</sup>. Use this model to design high level system prototypes.

Custom models provide a few extensions to the UML model and enable some exploratory and non-rigorous experimentation with model elements and diagrams.

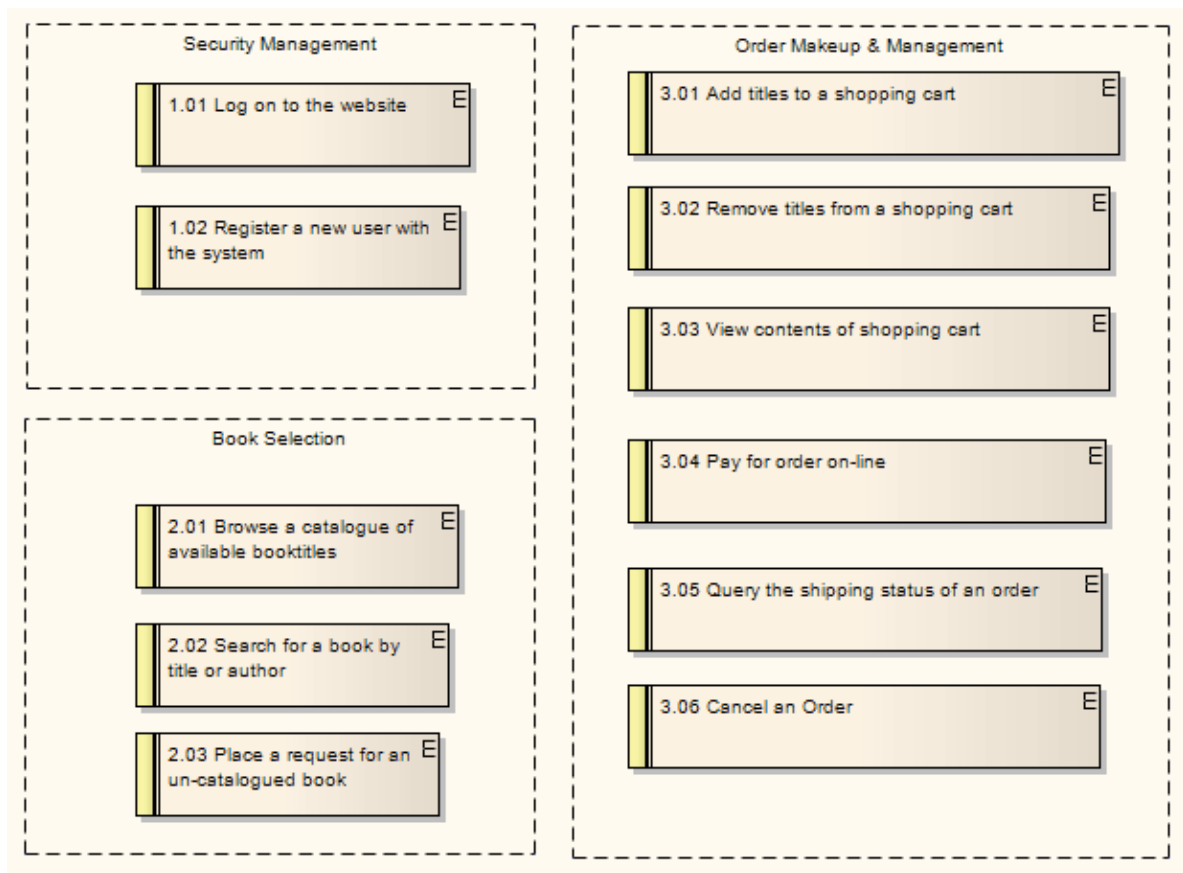

## Toolbox Elements and Connectors

Select Custom diagram elements and connectors from the [Custom](#) <sup>[417]</sup> pages of the [Toolbox](#).

### Tip:

Click on the following elements and connectors for more information.

Custom Diagram Elements	Custom Diagram Connectors
Package	Associate
Requirement	Aggregate
Issue	Generalize
Change	Realize
Screen	Nesting
UI Control	
Test Case	
Entity	

### 5.1.1.3.3 Requirements Diagram

A *Requirements* diagram is a custom diagram used to describe a system's requirements or features as a visual model.

Requirements are defined using *Requirement elements* (*Custom* elements of type *Requirement*). To view the detailed description of a Requirement, double-click on the element to display its properties. Requirement elements can be linked back to [Use Cases](#)<sup>[806]</sup> and [Components](#)<sup>[816]</sup> in the system to illustrate how a particular system requirement is met.

Requirements models provide extensions to the UML model and enable [traceability](#)<sup>[1245]</sup> between specifications and design requirements, and the model elements that realize them.

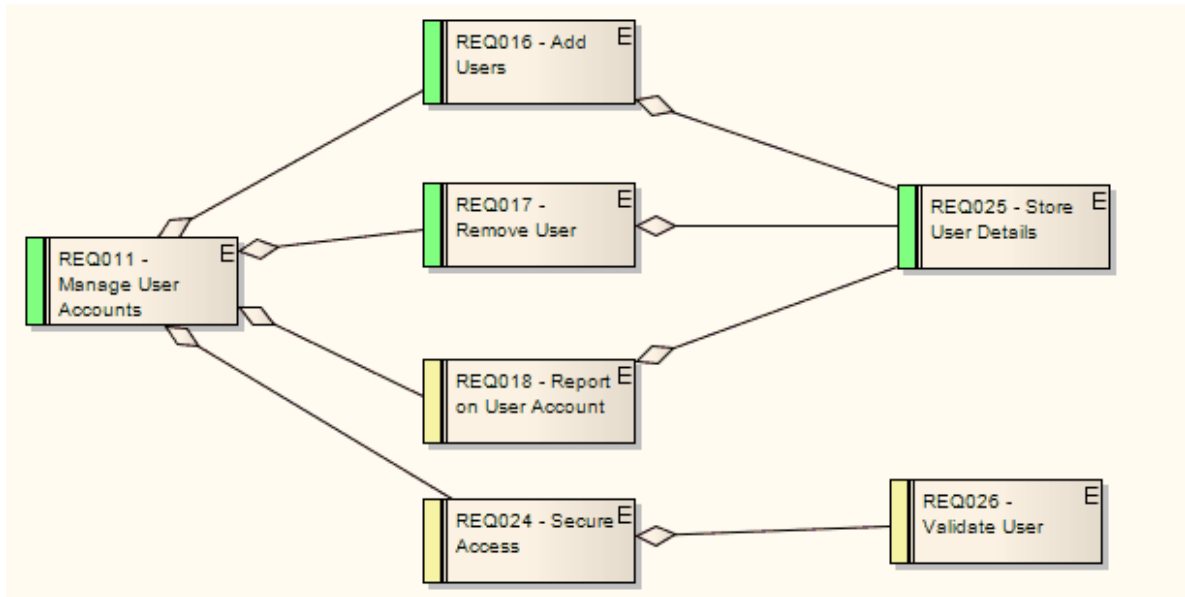

Requirements can have relationships with other elements such as other Requirements and Use Cases. To view the traceability of a requirement, use the [Traceability](#)<sup>[1253]</sup> window, which you access using the **View | Traceability** menu option (or press **[Ctrl]+[Shift]+[4]**).

### Toolbox Elements and Connectors

Select Requirements diagram elements and connectors from the [Requirements](#)<sup>[418]</sup> pages of the **Toolbox**.

#### Tip:

Click on the following elements and connectors for more information.

Requirements Diagram Elements	Requirements Diagram Connectors
Package	Aggregate
Requirement	Inheritance
Feature	Associate
Object	Implements

### 5.1.1.3.4 Maintenance Diagram

A *Maintenance diagram* is a custom diagram used to describe change requests and issue items within a system model.

An example Maintenance diagram is shown below. *Change*, *Task* and *Issue* elements can be linked back to other model elements in the system to illustrate how they must be modified, fixed or updated.

Maintenance models provide extensions to the UML model and enable change management of change items, and of the model elements that require the changes to be made to them.

## Changes

EA supports custom Elements of type 'Change'. These can be linked to other elements in the repository or used as a separate lists of any changes proposed for the model.

Below are a set of Change elements for the shopping basket with test definitions listed against them. They are ready for checking once they are confirmed as corrected.

The color markings reflect the Status of the element.

	View Basket - add: alter quantity against the entries.	☐
	<b>test scripts</b>	
	Unit : (Not Run) Alter Quantity	

	View Basket - Add button to update Change	☐
	<b>test scripts</b>	
	Unit : (Deferred) Update Cart Button operative	





	Create Account: password confirmation fails	☐
	<b>test scripts</b>	
	Unit : (Not Run) Password Confirmation	



## Toolbox Elements and Connectors

Select Maintenance diagram elements and connectors from the [Maintenance](#) <sup>[418]</sup> pages of the **Toolbox**.

### Tip:

Click on the following elements and connectors for more information.

Maintenance Diagram Elements	Maintenance Diagram Connectors
 Package	 Aggregate
 Issue	
 Change	

Maintenance Diagram Elements	Maintenance Diagram Connectors
 Test Case	
 Entity	

### 5.1.1.3.5 User Interface Diagram

*User Interface Diagrams* are custom diagrams used to visually mock-up a system's user interface using forms, controls and labels.

In the example *User Interface* diagram below, forms, controls and labels are arranged on the diagram to describe its appearance. *UI Control elements* can also be traced to other model elements linking the UI with the underlying implementation.

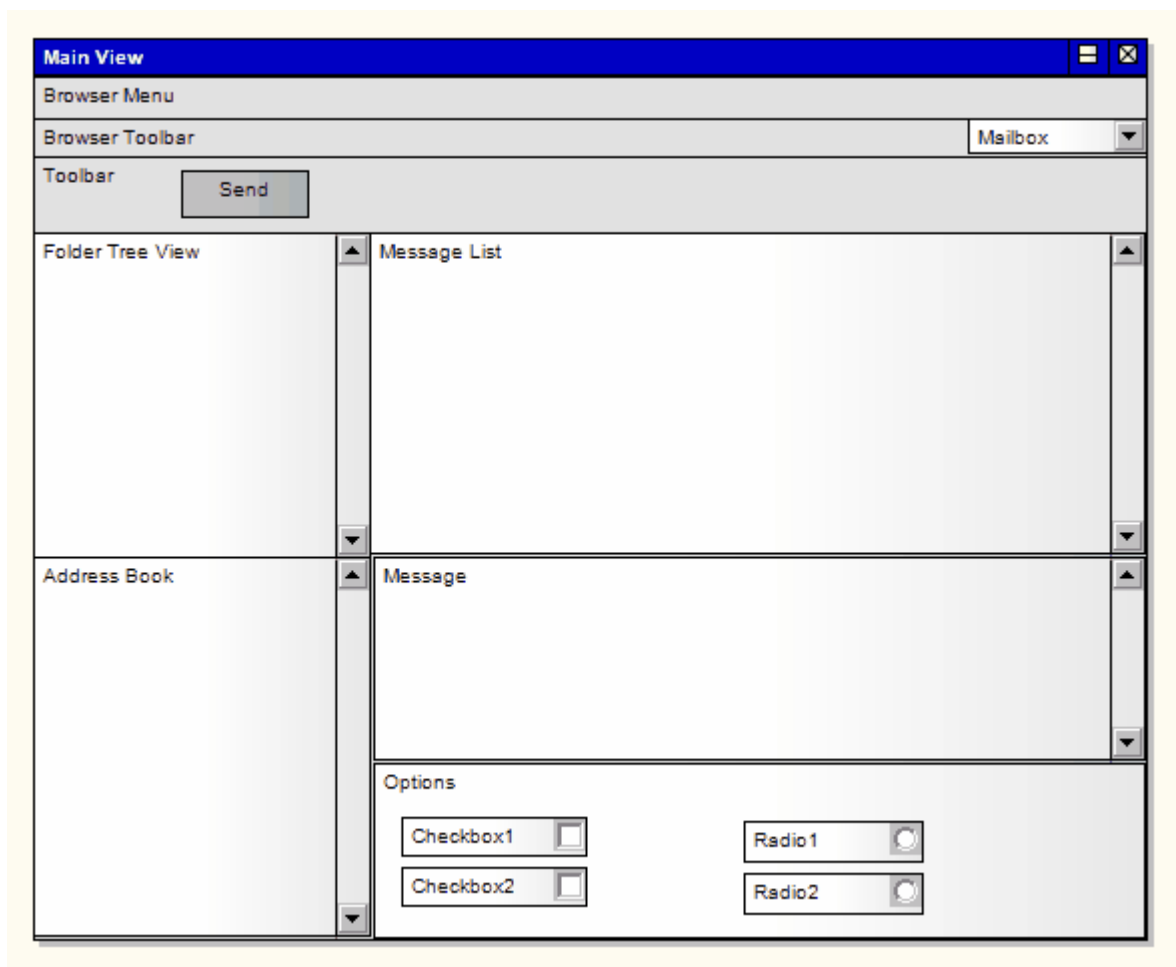









### Toolbox Elements and Connectors

Select User Interface diagram elements and connectors from the [User Interface](#)<sup>419</sup> pages of the [Toolbox](#).

#### Note:

Click on the following elements and connectors for more information.

User Interface Diagram Elements	User Interface Diagram Connectors
 Package	 Associate
 Screen	 Aggregate
 UI Control	 Generalize
 Object	 Realize

### 5.1.1.3.6 Database Schema

The following diagram shows an example Database Schema, used in [Data Modeling](#)<sup>[101]</sup>.

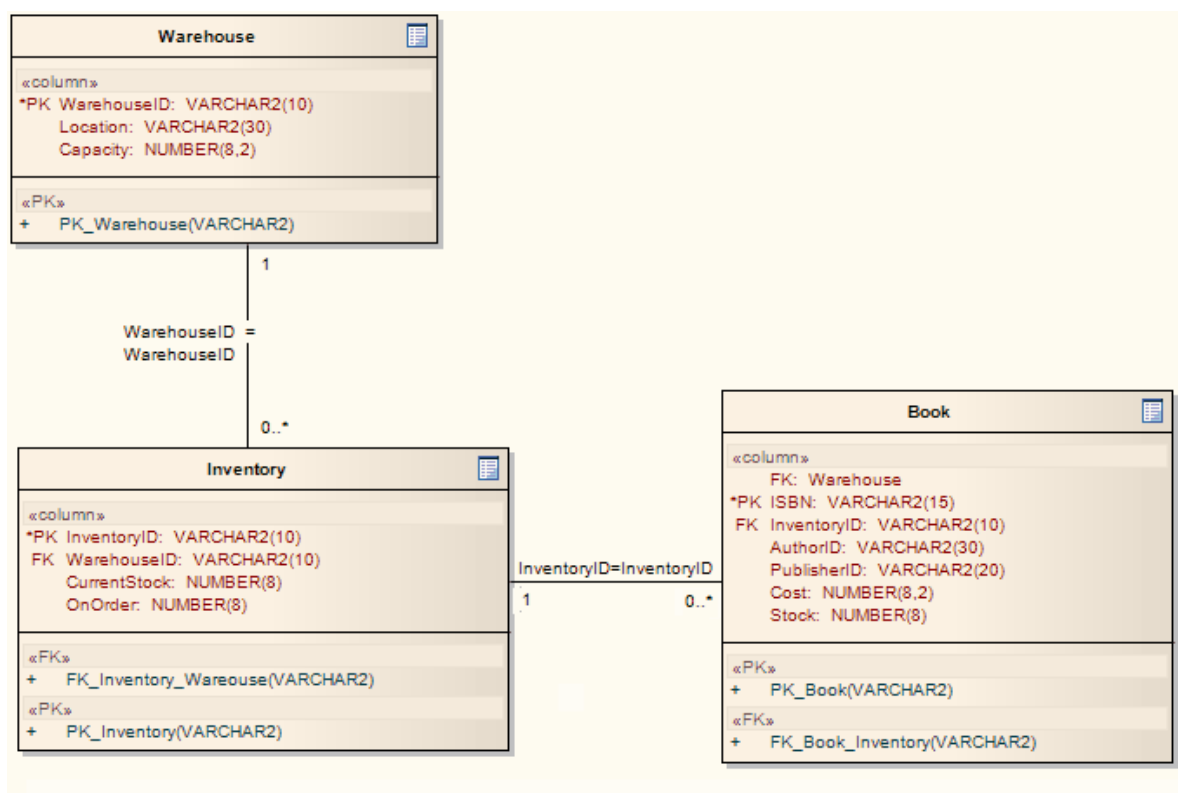

### Toolbox Elements and Connectors

Select Database Schema diagram elements from the [Data Modeling](#)<sup>[42]</sup> pages of the **Toolbox**.

### 5.1.1.3.7 Business Modeling/Interaction

*Business Modeling* diagrams and *Business Interaction* diagrams enable you to model both the structure and behavior of a business system.

Business Modeling diagrams are based on a *Class* (UML Structural) diagram, whilst Business Interaction diagrams are based on a *Sequence* (UML Behavioral) diagram. Both diagram types have the same default **Toolbox**, which consists of a **Business Modeling** element page. The available elements include stereotyped **Objects**<sup>[823]</sup>, and a stereotyped **Actor**<sup>[757]</sup> (*Business Actor*), **Use Case**<sup>[806]</sup> (*Business Use Case*) and **Collaboration**<sup>[814]</sup> (*Business Use Case Realization*).

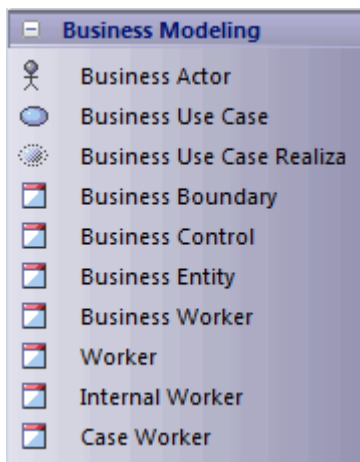

The following diagram shows the appearance of the elements when dragged and dropped onto a Business Modeling diagram:

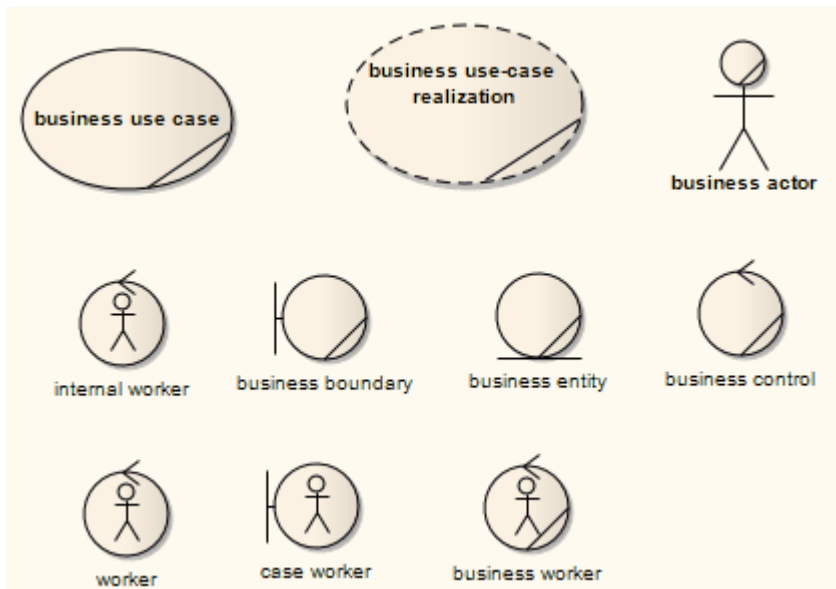

The following diagram shows the appearance of the elements when dragged and dropped onto a Business Interaction diagram:



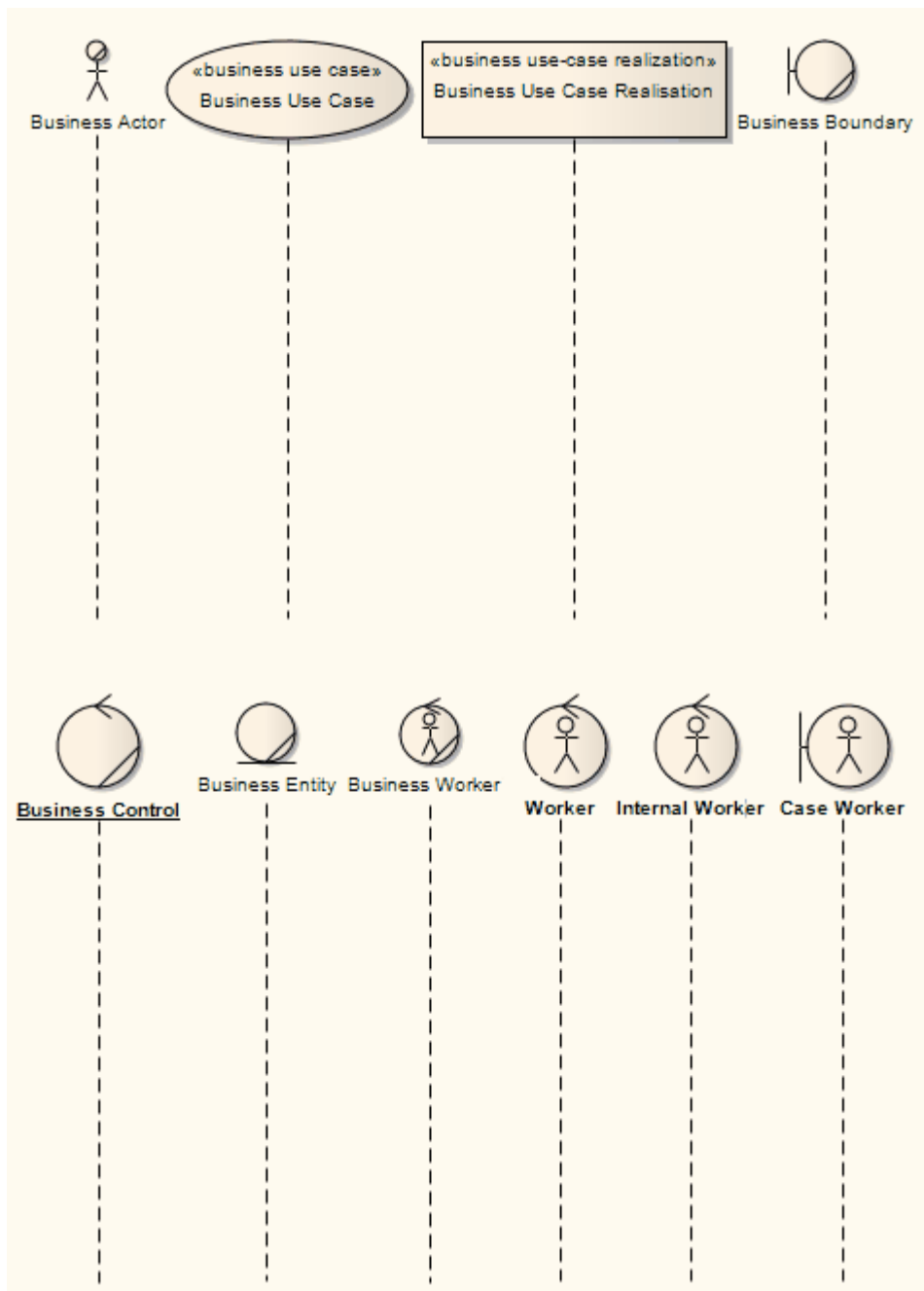

### 5.1.2 UML Elements

Models in UML are constructed from elements such as *Classes*, *Objects*, *Interfaces*, *Use Cases*, *Components* and *Nodes*, each of which has a different purpose, different rules and different notation. Model elements are used at different stages of the design process for different purposes.

This topic provides an introduction to elements defined by UML, which together compose the backbone of modeling. Most conceivable modeling elements are stereotypes or extensions of the elements introduced in this topic.

- During early analysis, Use Cases, Activities, Business Processes, Objects and Collaborations are used to capture the problem domain
- During elaboration, Sequence diagrams, Objects, Classes and State Machines are used to refine the system specification
- Components and Nodes are used to model larger parts of the system as well as the physical entities that are created and deployed into a production environment.

UML elements can be divided into two categories: those used on [Behavioral Diagrams](#)<sup>[742]</sup> and those used on [Structural Diagrams](#)<sup>[809]</sup>. This basic set can be [extended](#)<sup>[835]</sup> almost without limit using [Stereotypes](#)<sup>[895]</sup> and [UML Profiles](#)<sup>[906]</sup>.

### 5.1.2.1 Behavioral Diagram Elements

The following figure illustrates the main [UML elements](#)<sup>[741]</sup> that are used in [Behavioral Diagrams](#)<sup>[673]</sup>. For more information on using each element, click on the element name in this list:

- [Action](#)<sup>[743]</sup>, [Activity](#)<sup>[753]</sup>, [Actor](#)<sup>[757]</sup>
- [Central Buffer Node](#)<sup>[758]</sup>, [Choice](#)<sup>[758]</sup>, [Collaboration](#)<sup>[814]</sup>, [Combined Fragment](#)<sup>[759]</sup>
- [Datastore](#)<sup>[764]</sup>, [Decision](#)<sup>[765]</sup>, [Diagram Frame](#)<sup>[766]</sup>, [Diagram Gate](#)<sup>[767]</sup>
- [Endpoint](#)<sup>[768]</sup>, [Entry Point](#)<sup>[769]</sup>, [Exception](#)<sup>[769]</sup>, [Expansion Region](#)<sup>[769]</sup>, [Exit Point](#)<sup>[771]</sup>
- [Final](#)<sup>[772]</sup>, [Flow Final](#)<sup>[772]</sup>, [Fork](#)<sup>[773]</sup>
- [History](#)<sup>[777]</sup>
- [Initial](#)<sup>[778]</sup>, [Interaction](#)<sup>[779]</sup>, [Interaction Occurrence](#)<sup>[780]</sup>, [Interruptible Activity Region](#)<sup>[781]</sup>
- [Join](#)<sup>[773]</sup>, [Junction](#)<sup>[782]</sup>
- [Lifeline](#)<sup>[783]</sup>
- [Note](#)<sup>[785]</sup>
- [Object](#)<sup>[823]</sup>
- [Package](#)<sup>[825]</sup>, [Partition](#)<sup>[786]</sup>
- [Receive](#)<sup>[787]</sup>, [Region](#)<sup>[788]</sup>
- [Send](#)<sup>[789]</sup>, [State](#)<sup>[789]</sup>, [State/Continuation](#)<sup>[792]</sup>, [State Lifeline](#)<sup>[794]</sup>, [State Machine](#)<sup>[796]</sup>, [Structured Activity](#)<sup>[798]</sup>, [Synch](#)<sup>[802]</sup>, [System Boundary](#)<sup>[802]</sup>
- [Terminate](#)<sup>[804]</sup>, [Trigger](#)<sup>[804]</sup>
- [Use Case](#)<sup>[806]</sup>
- [Value Lifeline](#)<sup>[808]</sup>

**Note:**

Actor, Collaboration, Note, Object and Package elements are used in both Behavioral diagrams and Structural diagrams.

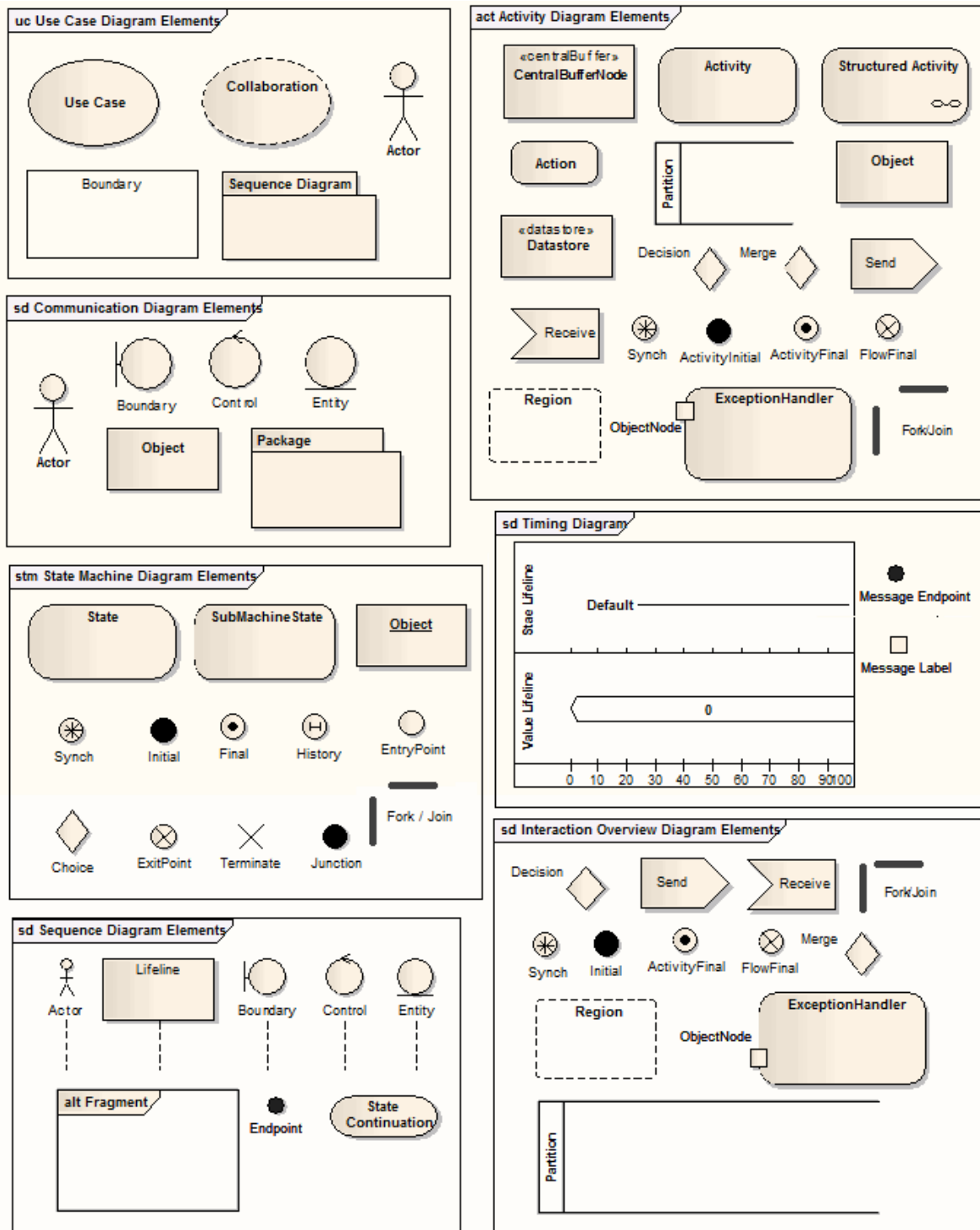

5.1.2.1.1 Action



An *Action* element describes a basic process or transformation that occurs within a system. It is the basic functional unit within an [Activity diagram](#)<sup>[674]</sup>. Actions can be thought of as children of [Activities](#)<sup>[753]</sup>. Both

represent processes, but Activities can contain multiple steps or decomposable processes, each of which can be embodied in an Action. An Action cannot be further broken down or decomposed.

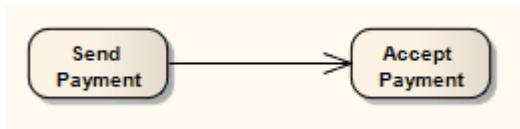

An Action can be further defined with [pre-condition and post-condition](#)<sup>[752]</sup> notes, and certain properties can be [graphically depicted](#)<sup>[745]</sup> on the Action (Enterprise Architect prompts you to define the type of Action you are creating when you first drag the **Action** icon from the **Toolbox**). The data values passed out of and into an Action can be represented by [Action Pins](#)<sup>[749]</sup>. For a named Action (that is, other than a basic Action) you can also [assign](#)<sup>[751]</sup> Action Pins to represent specific properties.

For a basic (*Atomic*) Action, you can define the effect of the Action using the **Effect** tab of the element **Properties** dialog, and select to display the effect on the diagram.

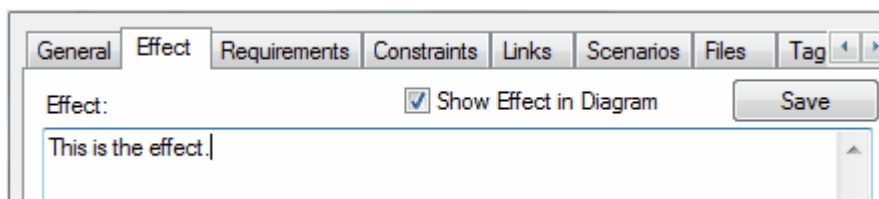

An Action can also be depicted as an [Expansion Node](#)<sup>[749]</sup> to indicate that the Action comprises an [Expansion Region](#)<sup>[769]</sup>.

## Class Operations in Activity Diagrams

Operations from Classes can be displayed on Activity diagrams as Actions. When an operation is shown as an Action, the notation of the Action displays the name of the Class that features the operation. To add an operation to an Activity diagram follow the steps below:

1. Open an Activity diagram.
2. From the **Project Browser** open a Class and locate the operation to be added to the Activity diagram.
3. Drag the operation on to the diagram.

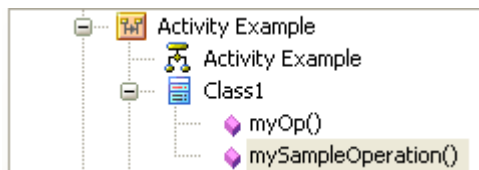

4. When the operation has been added to the Activity diagram the Action displays the name of the Class that features the operation.

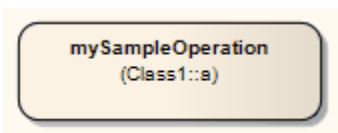

If you right-click on the Action in the diagram, you can locate the behavior classifier (CallBehavior Activity) or call operation (CallOperation Activity) in the **Project Browser** using the **Find | Locate Classifier in Project Browser** and **Find | Locate Operation in Project Browser** context menu options.

If it becomes necessary to change the operation that this Action refers to, follow the steps below:

1. Right-click on the Action. The context menu displays.
2. Select the **Advanced | Set Operation** menu option. The [Set Operation dialog](#)<sup>[748]</sup> displays.
3. If necessary, in the **In Namespace** field, select the model that contains the required operation.
4. Double-click on the required operation. The Action updates to show the new classifier and operation.

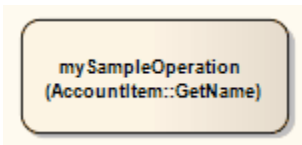

## Toolbox Icon



## OMG UML Specification

The OMG UML specification (*UML Superstructure Specification, v2.1.1, p. 241*) states:

*An action is a named element that is the fundamental unit of executable functionality. The execution of an action represents some transformation or processing in the modeled system, be it a computer system or otherwise.*

The OMG UML specification (*UML Superstructure Specification, v2.1.1, p. 313*) also states:

*An action may have sets of incoming and outgoing activity edges that specify control flow and data flow from and to other nodes. An action will not begin execution until all of its input conditions are satisfied. The completion of the execution of an action may enable the execution of a set of successor nodes and actions that take their inputs from the outputs of the action.*

### 5.1.2.1.1 Action Notation

Some properties can be graphically depicted on an [Action](#) <sup>743</sup> element, as shown in the examples below.

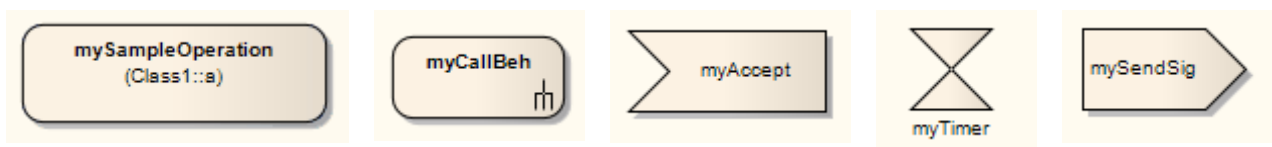

**Action Notation Kind:**  
CallOperation

**Action Notation Kind:**  
CallBehavior

**Action Notation Kind:**  
AcceptEvent

**Action Notation Kind:**  
AcceptEventTimer

**Action Notation Kind:**  
SendSignal

When you drag the **Action** icon from the **Activity** page of the **Toolbox** onto your diagram, a selection list displays showing the commonest types of Action to create. (If this list does not display, press **[Ctrl]** as you drag the icon.)

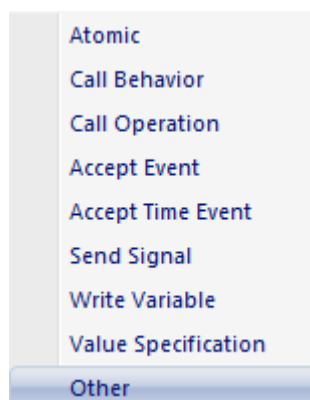

When you click on one of the specific types, that type of Action element displays on diagram. If you click on the **Other** option, the **New Action** dialog displays:

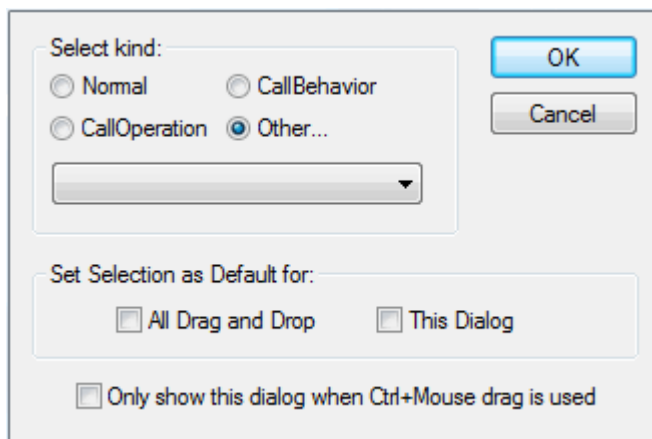

You can again select to create a normal (Atomic) Action element, a CallOperation or a CallBehavior, or you can select the **Other** radio button and click on the drop-down arrow in the blank field to select the Action type from an extensive list.

If you later decide that the Action type is not appropriate, you can change it by right-clicking on the Action and selecting the **Advanced | Custom Properties** context menu option, which displays the **Custom Properties** dialog. Set the Action type by selecting a value from the **Kind** drop-down list. For a Value Specification Action, you also set the value on this dialog.

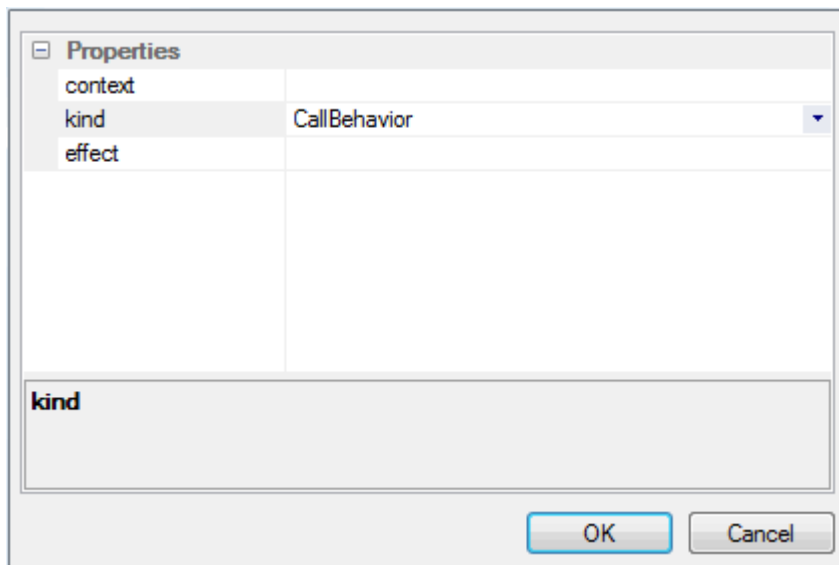

### AcceptEvent Actions

For an *Accept Event* Action element, the **Properties** dialog contains a **Triggers** tab on which you define one or more triggers to denote the type of events accepted by the Action, as defined in the following table:

Option	Use to
<b>Name</b>	Specify the name of the trigger.
<b>Type</b>	Specify the type of trigger: <b>Call</b> , <b>Change</b> , <b>Signal</b> or <b>Time</b> . <ul style="list-style-type: none"> <li><b>Call</b> - specifies that the event is a CallEvent, which sends a message to the associated object by invoking an operation.</li> <li><b>Change</b> - specifies that the event is a ChangeEvent, which indicates that the transition is the result of a change in value of an attribute.</li> <li><b>Signal</b> - specifies that the event is a SignalEvent, which corresponds to the</li> </ul>

Option	Use to
	receipt of an asynchronous signal instance. <ul style="list-style-type: none"> <li>• <b>Time</b> - corresponds to a TimeEvent; which specifies a moment in time.</li> </ul> <p><b>Note:</b> Code generation for State Machines currently supports Change and Time trigger events only, and expects a specification value.</p>
<b>Specification</b>	Specify the event instigating the Transition.

### SendSignal Action & BroadcastSignal Action

For a *SendSignal* or *BroadcastSignal* Action element, you can model the signal to be sent and the associated arguments to be conveyed, using the **Signal** tab of the element **Properties** dialog.

To complete this tab, follow the steps below:

1. In the **Signal** field, click on the [ ... ] button and select the required signal from the [Select Signal](#) dialog.
2. In the **Attribute** field, click on the drop-down arrow and select the attribute (as previously created in the

Signal element) with which the arguments are to be associated.

3. In the **Value** field, type the appropriate value for the attribute.
4. Identify the arguments (as [Action Pins](#)<sup>[749]</sup>) for the Signal; click on the **Add** button under the **Arguments** panel, and select the appropriate Pins from the [Select Pin](#)<sup>[515]</sup> dialog.

**Note:**

To assign more than one Pin, press **[Ctrl]** whilst you select each Pin.

5. Click on the **Save** button.

## Structural Feature Actions

Enterprise Architect supports the following types of *Structural Feature* Actions:

- AddStructuralFeatureValue
- ClearStructuralFeature
- ReadStructuralFeature
- RemoveStructuralFeatureValue
- WriteStructuralFeature

These actions can take Ports, Parts or Attributes as the target structural feature. To set the appropriate feature, follow the steps below:

1. Right-click on the Action element in the diagram, and select the **Advanced | Set Structural Feature** context menu option. The **Set Structural Feature** dialog displays.

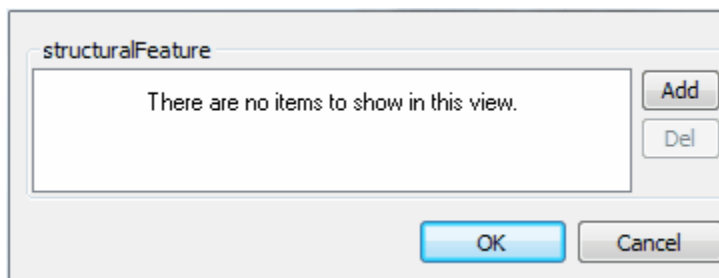

2. To locate the structural feature, click on the **Add** button. The **Select Property** dialog displays (a variant of the [Select <Item>](#)<sup>[515]</sup> dialog).
3. Browse or search for the appropriate structural feature, and double-click on it. The feature name and location displays in the **structuralFeature** field of the **Set Structural Feature** dialog.
4. Click on the **OK** button to save the setting.

The **Set Feature** dialog is the **Set Operation** dialog used to change the [operation represented by an Action](#)<sup>[744]</sup> on an Activity diagram.

As the **Set Operation** or **Set Attribute** dialog, it is also used to set the *Value* operation or attribute for Tagged Values of type [RefGUID](#)<sup>[1167]</sup> or for the target of a [hyperlink](#)<sup>[840]</sup> in a diagram.

To use this dialog, follow the steps below:

1. The **Set Operation** (or **Set Attribute**) dialog displays, with the model hierarchy opened at the point at which you selected the original operation or attribute.



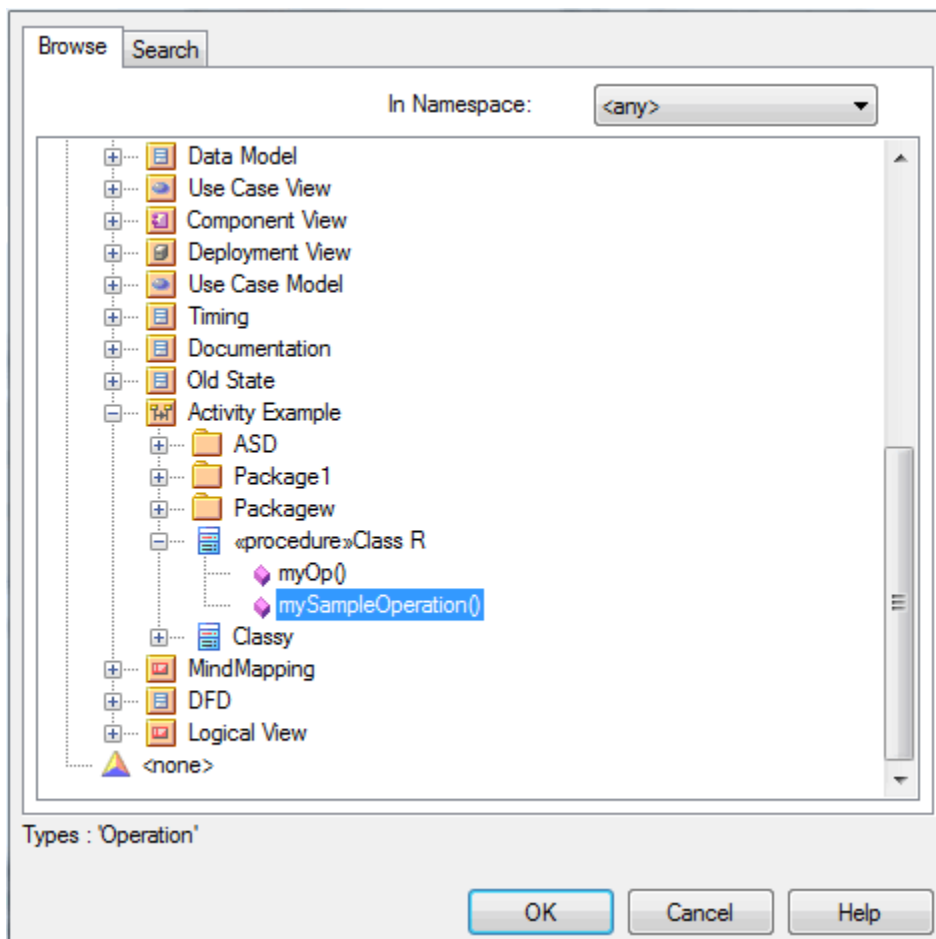

2. If required, in the **In Namespace** field, click on the drop-down arrow and select another model that contains the required operation or attribute. The package hierarchy for that model displays.
3. Browse through the hierarchy, or use the [Search](#) <sup>[515]</sup> tab to locate the required operation or attribute, then double-click on the item to select it.

#### 5.1.2.1.1.2 Action Expansion Node

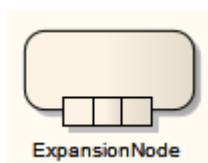

Representing an [Action](#) <sup>[743]</sup> as an *Expansion Node* is a shorthand notation to indicate that the Action comprises an [Expansion Region](#) <sup>[769]</sup>.

To specify an Action as an Expansion Node, right-click on the Action to display the context menu and select the **Embedded Elements | Add Expansion Node** menu option. After designating an Action as an Expansion Node, you can modify or delete it using the **Embedded Elements | Embedded Elements** menu option.

#### 5.1.2.1.1.3 Action Pin



An *Action Pin* is used to define the data values passed out of and into an [Action](#) <sup>[743]</sup>. An *input pin* provides

values to the Action, whereas an *output pin* contains the results from that Action.

Action Pins are used below to connect two Actions:

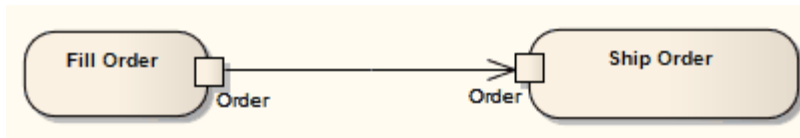

See *UML Superstructure Specification, v2.1.1, Figure 12.110, p. 391.*

Action Pins can be further characterized as defining exception parameters, streams, or states. Associating a state with a Pin defines the state of input or output values. For instance, the Pin could be called *Orders*, but the state could be *Validated* or *Canceled*.

To *add* an Action Pin to an Action, right-click on the Action to display the context menu and select the **Embedded Elements | Add Action Pin** menu option. (You can also [assign](#) <sup>[75]</sup> Action Pins, to define specific properties of the Action.)

The **Properties** dialog of an Action Pin has a **Pin** tab on which you define the specific actions of the Pin.

A Pin serves as an argument for Call Behavior Actions and Call Operation Actions. When an Action is associated with a valid behavior in the model, the associated behavior's parameters are listed in the **Parameter** field drop-down list to facilitate a one-to-one mapping between the argument and the parameter. The fields in the **Argument** panel are enabled only for Pins belonging to Call Actions, and only when the Action is associated with a valid behavior with valid parameters.

You can also change certain properties of an Action Pin on the **Custom Properties** dialog: right-click on the Pin and select the **Advanced | Custom Properties** context menu option. The following properties can be set:

Properties	
isOrdered	True
isUnique	True
objectState	
kind	input

#### 5.1.2.1.1.4 Assign Action Pins

Apart from *adding* Action Pins to any Action, you can *assign* specialized input or output Action Pins to Actions that have a specific type (that is, those that are not Basic or Atomic Actions). These input/output Pins signify various *properties* of the Action - they are not visible as structures on the diagram unless they have previously been [added](#)<sup>[749]</sup>, but are listed in the [Project Browser](#) as properties of the Action.

You can only assign Pins that have already been added or assigned to the Action, or that are being created specifically to be assigned to the Action.

To assign Pins to an Action, follow the steps below:

1. Right-click on the Action in the diagram, and select the **Advanced | Assign Action Pins** context menu option. The **Assign Action Pins to <ActionName>** dialog displays.

The screenshot shows a dialog box titled "Assign Action Pins to <ActionName>". It contains three sections, each with a text field and two buttons ("Add" and "Del"). The sections are labeled "first", "result", and "second". The text fields contain the following paths: "Model::Test::TestIdentity.first", "Model::Test::TestIdentity.result", and "Model::Test::TestIdentity.second". At the bottom of the dialog are "OK" and "Cancel" buttons.

The format of this dialog depends on the type of Action: for a *SendObject* Action the dialog has two fields (**request** and **target**); for the above *TestIdentity* Action, three; and for a *CallBehavior* Action, one (**result**). The fields are populated in exactly the same way.

2. The mandatory number and type of Pins are automatically selected (if they exist) or created. To change or add a Pin in a field, click on the corresponding **Add** button. The **Select Pins** dialog displays (a variant of the [Select <Item>](#)<sup>[515]</sup> dialog), showing the selected Action and listing all the input Pins currently owned by the Action.
3. Double-click on one of the Pins (or, depending on the multiplicity of the Pin, **[Ctrl]+click** on several Pins). Alternatively, if no suitable Pin exists, click on the **Add New** button and then click on the newly-created Pin. The selected Pin is identified in the field on the **Assign Action Pins to <ActionName>** dialog.
4. Click on the **OK** button.

To check the exact location of an assigned Action Pin, you can right-click on the Pin name in the dialog and select the **Find in Project Browser** context menu option.

### 5.1.2.1.1.5 Local Pre/Post Conditions

[Actions](#) <sup>[743]</sup> can be further defined with *pre-condition* and *post-condition* notes, which constrain an Action's entry and exit. These notes can be added to an Action as defined below.

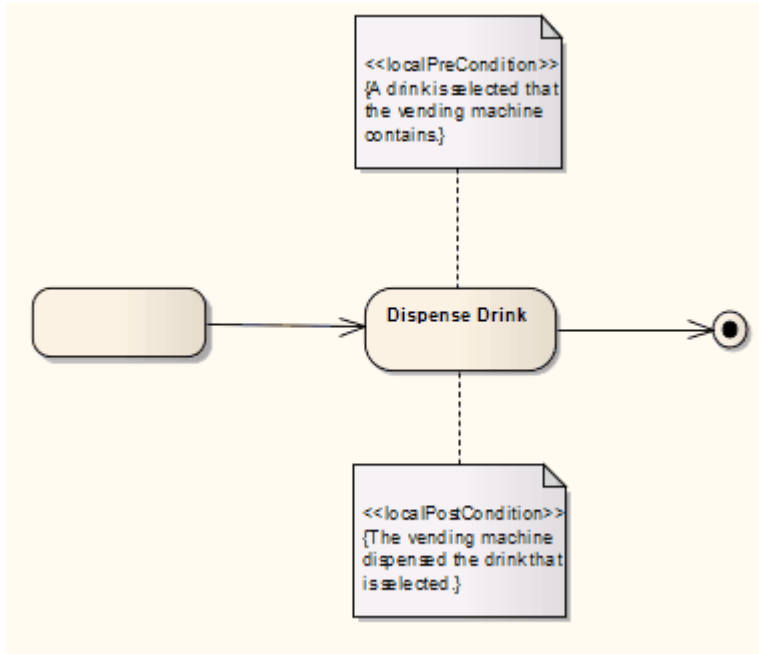

See *UML Superstructure Specification, v2.1.1, Figure 12.32, p. 316.*

### Create a Constraint

To attach a constraint to an Action follow the steps below:

1. Right-click on the Action. The context menu displays:
2. Select the **Add | Constraint** menu option. A *Note* is created on the diagram, connected to the Action.
3. Right-click on the *Note*. The context menu displays.
4. Select the **View Properties** menu option. The **Constraint** dialog displays.

The screenshot shows a dialog box titled 'Constraint'. It has two main sections. The first section is labeled 'Constraint Type:' and contains a drop-down menu with 'localPostCondition' selected. The second section is labeled 'Constraint:' and contains a text area with the text 'The vending machine dispensed the selected drink.' Below the text area are two buttons: 'OK' and 'Cancel'.

5. In the **Constraint Type** field, click on the drop-down arrow and select the required constraint type.
6. In the **Constraint** field, type the text for the constraint.
7. Click on the **OK** button to save the constraint.

### 5.1.2.1.2 Activity



An *Activity* organizes and specifies the participation of subordinate behaviors, such as *sub-Activities* or *Actions*<sup>[743]</sup>, to reflect the control and data flow of a process. Activities are used in *Activity diagrams*<sup>[674]</sup> for various modeling purposes, from procedural-type application development for system design, to business process modeling of organizational structures or work flow.

The following simple diagram of an Activity contains Action elements and includes *input parameters and output parameters*<sup>[755]</sup>.

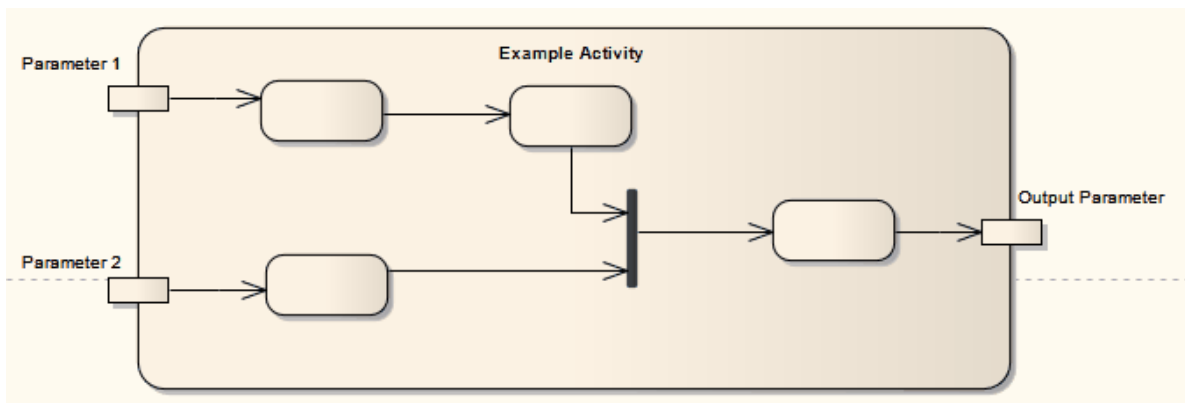

You can define an Activity as a *composite element*<sup>[837]</sup>, either during creation or during later edits. When creating a composite Activity element, it is simpler to apply the mechanism for creating *Structured Activity* elements, which reduces the number of steps to work through. See the *Structured Activity*<sup>[798]</sup> topic. If converting an existing Activity element, right-click on the element and select the **Advanced | Make Composite** context menu option.

Certain properties can be *graphically depicted*<sup>[754]</sup> on an Activity. The Actions in an Activity can be further organized by *Activity Partitions*<sup>[756]</sup>.

### Toolbox Icon



### OMG UML Specification

The OMG UML specification (*UML Superstructure Specification, v2.1.1, p. 318*) states:

*An activity specifies the coordination of executions of subordinate behaviors, using a control and data flow model. The subordinate behaviors coordinated by these models may be initiated because other behaviors in the model finish executing, because objects and data become available, or because events occur external to the flow. The flow of execution is modeled as activity nodes connected by activity edges. A node can be the execution of a subordinate behavior, such as an arithmetic computation, a call to an operation, or manipulation of object contents. Activity nodes also include flow-of-control constructs, such as synchronization, decision, and concurrency control. Activities may form invocation hierarchies invoking other activities, ultimately resolving to individual actions. In an object-oriented model, activities are usually invoked indirectly as methods bound to operations that are directly invoked.*

*Activities may describe procedural computation. In this context, they are the methods corresponding to operations on classes. Activities may be applied to organizational modeling for business process engineering and workflow. In this context, events often originate from inside the system, such as the finishing of a task, but*

also from outside the system, such as a customer call. Activities can also be used for information system modeling to specify system level processes. Activities may contain actions of various kinds:

- Occurrences of primitive functions, such as arithmetic functions.
- Invocations of behavior, such as activities.
- Communication actions, such as sending of signals.
- Manipulations of objects, such as reading or writing attributes or associations.

Actions have no further decomposition in the activity containing them. However, the execution of a single action may induce the execution of many other actions. For example, a call action invokes an operation that is implemented by an activity containing actions that execute before the call action completes.

#### 5.1.2.1.2.1 Activity Notation

Certain properties can be graphically depicted on an [Activity](#)<sup>7531</sup> element, as shown below.

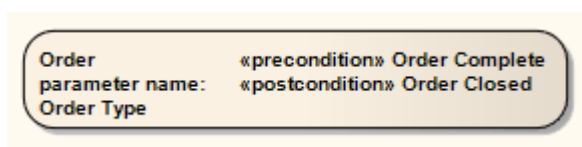

To define these properties, right-click on the Activity and select the **Advanced | Custom Properties** context menu option. The following dialog displays:

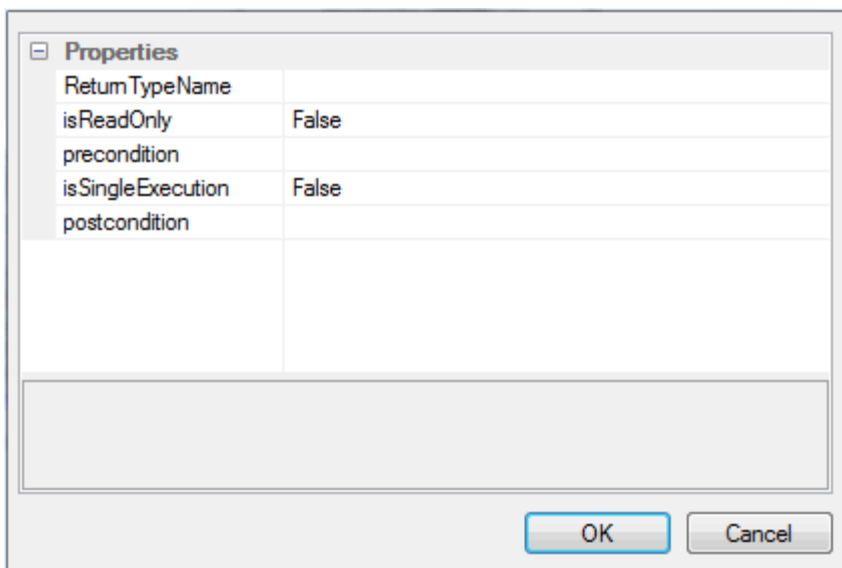

### 5.1.2.1.2.2 Activity Parameter Nodes

An *Activity Parameter Node* accepts input to an [Activity](#)<sup>[753]</sup> or provides output from an Activity.

The following example depicts two entry parameters and one output parameter defined for the Activity.

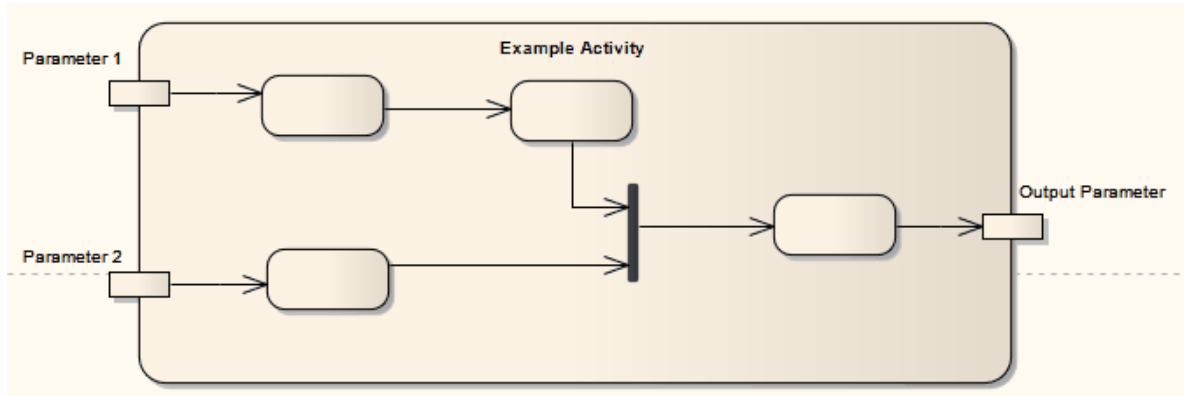

To define an Activity Parameter Node for an Activity, follow the steps below:

1. Right-click on the element and select the **Embedded Elements | Add Activity Parameter** context menu option.
2. The **Properties** dialog displays, which prompts for the **Name** and other properties of the embedded element.
3. After closing this dialog, you can further define the new Activity Parameter; right-click on it and select the **Advanced | Custom Properties** context menu option. The following dialog displays:

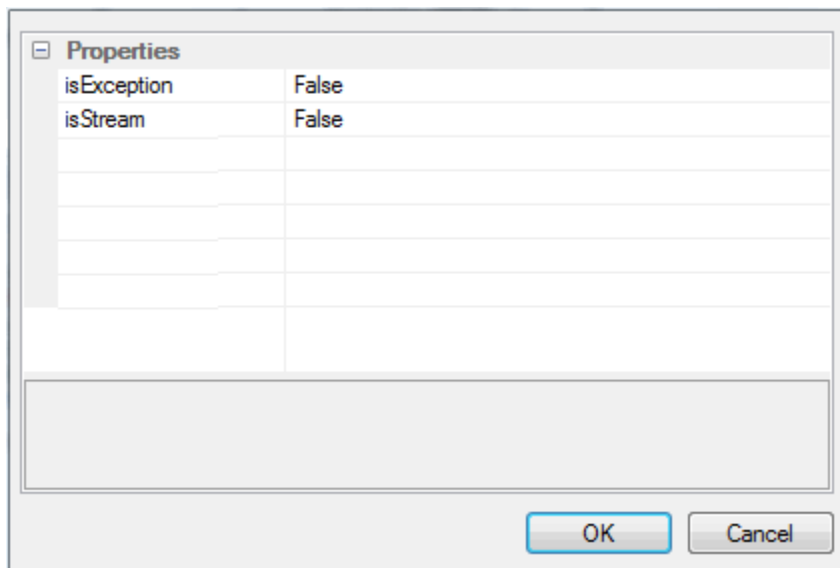

Similar to characterizing [Action Pins](#)<sup>[749]</sup>, Activity Parameter Nodes also have the *isException* and *isStream* options. *isException* indicates that a parameter can emit a value at the exclusion of other outputs, usually because of some error. *isStream* indicates whether or not a parameter can accept or post values during the execution of the Activity.

The following example uses the above settings:

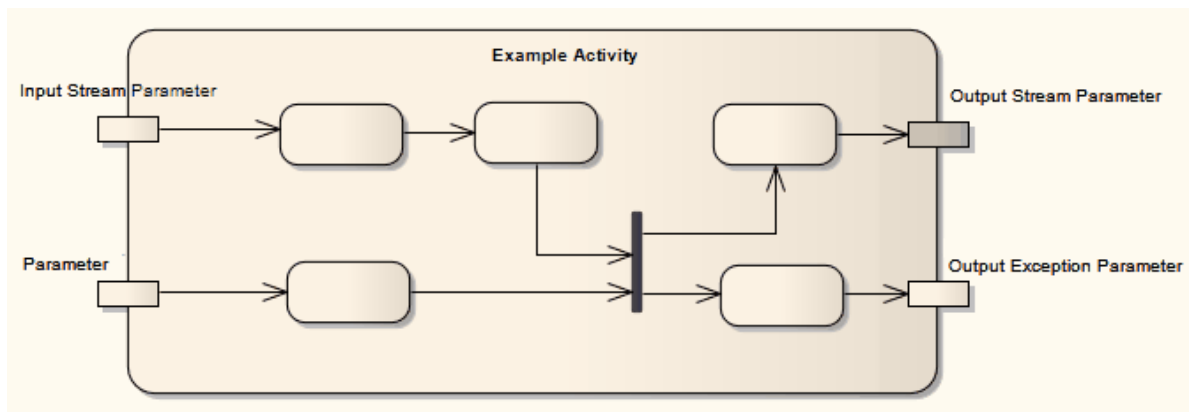

### OMG UML Specification

The OMG UML specification (*UML Superstructure Specification, v2.1.1, p. 338*) states:

*An activity parameter node is an object node for inputs and outputs to activities.*

*... Activity parameter nodes are object nodes at the beginning and end of flows that provide a means to accept inputs to an activity and provide outputs from the activity, through the activity parameters.*

*Activity parameters inherit support for streaming and exceptions from Parameter.*

#### 5.1.2.1.2.3 Activity Partition

Enterprise Architect supports two types of *Activity Partition*:

- The *Activity Partition feature*, described in this topic, which is used to logically organize an [Activity](#) <sup>[753]</sup> *element*
- The [Activity Partition](#) <sup>[786]</sup> *element*, which is used to logically organize an [Activity](#) <sup>[674]</sup> *diagram*.

In effect, these are the same. They partition the Actions of the Activity without affecting the token flow, helping to structure the view or parts of the Activity.

An example of a feature-partitioned Activity is shown below:

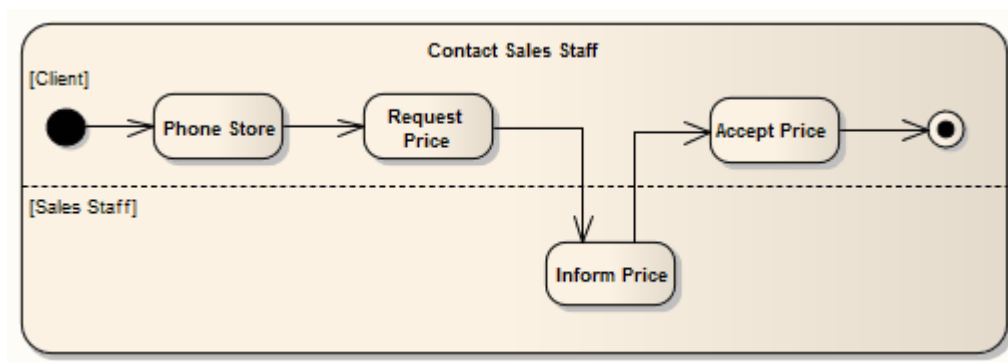

To define Partitions using the feature:

1. Right-click on the Activity element. The context menu displays.
2. Select the **Advanced | Partition Activity** menu option. The **Activity Partitions** dialog displays.



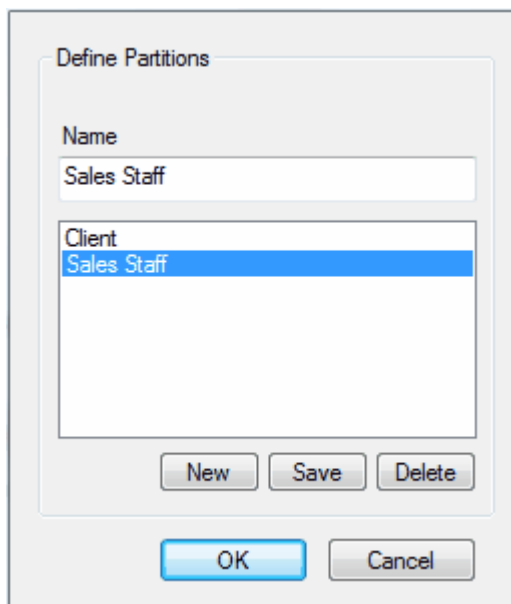

3. In the **Name** field, type the name of a partition. Click on the **Save** button.
4. Repeat step 3 for each partition to be created.

### OMG UML Specification

The OMG UML specification (*UML Superstructure Specification, v2.1.1, p. 341*) states:

*Partitions divide the nodes and edges to constrain and show a view of the contained nodes. Partitions can share contents. They often correspond to organizational units in a business model. They may be used to allocate characteristics or resources among the nodes of an activity.*

The OMG UML specification (*UML Superstructure Specification, v2.1.1, p. 341*) also states:

*An activity partition is a kind of activity group for identifying actions that have some characteristic in common.*

#### 5.1.2.1.3 Actor

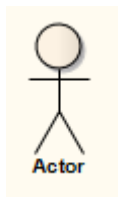

An *Actor* is a user of the system; *user* can mean a human user, a machine, or even another system or subsystem in the model. Anything that interacts with the system from the outside or system boundary is termed an Actor. Actors are typically associated with [Use Cases](#)<sup>[806]</sup>.

Actors can use the system through a graphical user interface, through a batch interface or through some other media. An Actor's interaction with a Use Case is documented in a Use Case scenario, which details the functions a system must provide to satisfy the user requirements.

Actors also represent the role of a user in [Sequence Diagrams](#)<sup>[706]</sup>. Enterprise Architect supports a stereotyped Actor element for [business modeling](#)<sup>[739]</sup>. The business modeling elements also represent Actors as stereotyped Objects.

### Toolbox Icon



## OMG UML Specification

The OMG UML specification (*UML Superstructure Specification, v2.1.1, p. 584*) states:

*An actor models a type of role played by an entity that interacts with the subject (e.g. by exchanging signals and data), but which is external to the subject. ... Actors may represent roles played by human users, external hardware, or other subjects. Note that an actor does not necessarily represent a specific physical entity but merely a particular facet (i.e., "role") of some entity that is relevant to the specification of its associated Use Cases. Thus, a single physical instance may play the role of several different actors and, conversely, a given actor may be played by multiple different instances.*

### 5.1.2.1.4 Central Buffer Node

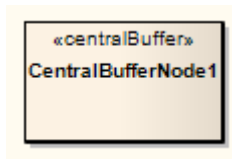

A *Central Buffer Node* is an object node for managing flows from multiple sources and destinations, represented in an [Activity diagram](#)<sup>[674]</sup>. It acts as a buffer for multiple in-flows and out-flows from other object nodes, but does not connect directly to Actions.

## Toolbox Icon

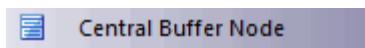

## OMG UML Specification

The OMG UML specification (*UML Superstructure Specification, v2.1.1, p. 352*) states:

*A central buffer node is an object node for managing flows from multiple sources and destinations. ... A central buffer node accepts tokens from upstream object nodes and passes them along to downstream object nodes.*

### 5.1.2.1.5 Choice



The *Choice pseudo-state*<sup>[682]</sup> is used to compose complex transitional paths in, for example, a [State Machine diagram](#)<sup>[678]</sup>, where the outgoing transition path is decided by dynamic, run-time conditions. The run-time conditions are determined by the actions performed by the [State Machine](#)<sup>[789]</sup> on the path leading to the choice.

The following example depicts the Choice element. Upon reaching the *Filter* pseudo-state, a transition fires to the appropriate state based on the run-time value passed to the Filter. Very similar in form to a [Junction](#)<sup>[782]</sup> pseudo-state, the Choice pseudo-state's distinction is in deciding transition paths at run-time.

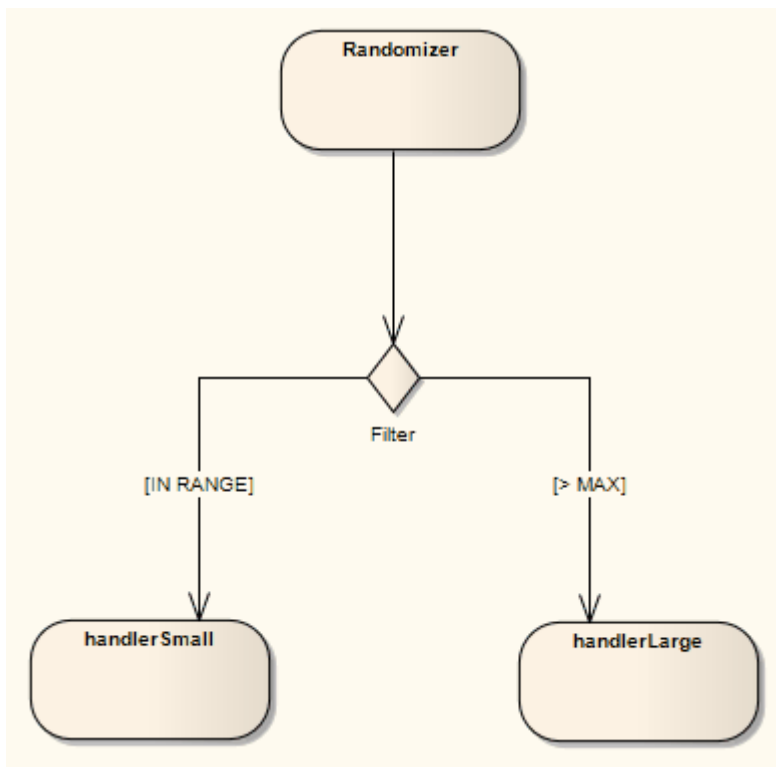

### Toolbox Icon



### OMG UML Specification

The OMG UML specification (*UML Superstructure Specification*, v2.1.1, p. 538) states:

*...choice vertices which, when reached, result in the dynamic evaluation of the guards of the triggers of its outgoing transitions. This realizes a dynamic conditional branch. It enables splitting of transitions into multiple outgoing paths such that the decision on which path to take may be a function of the results of prior actions performed in the same run-to-completion step. If more than one of the guards evaluates to true, an arbitrary one is selected. If none of the guards evaluates to true, then the model is considered ill-formed. (To avoid this, it is recommended to define one outgoing transition with the predefined "else" guard for every choice vertex.) Choice vertices should be distinguished from static branch points that are based on junction points.*

#### 5.1.2.1.6 Combined Fragment

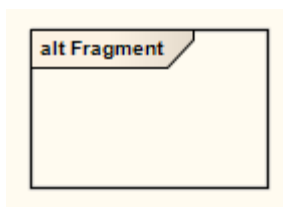

A *Combined Fragment* reflects a piece or pieces of interaction (called *interaction operands*) controlled by an [interaction operator](#)<sup>[762]</sup>, whose corresponding boolean conditions are known as *interaction constraints*. It displays as a transparent window, divided by horizontal dashed lines for each operand.

The following diagram illustrates the use of Combined Fragments, with a [Sequence diagram](#)<sup>[706]</sup> modeling a simplified purchasing process. A loop fragment is created to iterate through an unknown number of items for purchase, after which the cashier requests payment. At this point, two payment options are considered and an

alternative fragment is [created](#)<sup>[76†]</sup>, divided to show the two operands: cash and credit card. After the fragment completes its trace, the cashier gives a receipt to the customer, under the fulfilled condition that payment requirements were met.

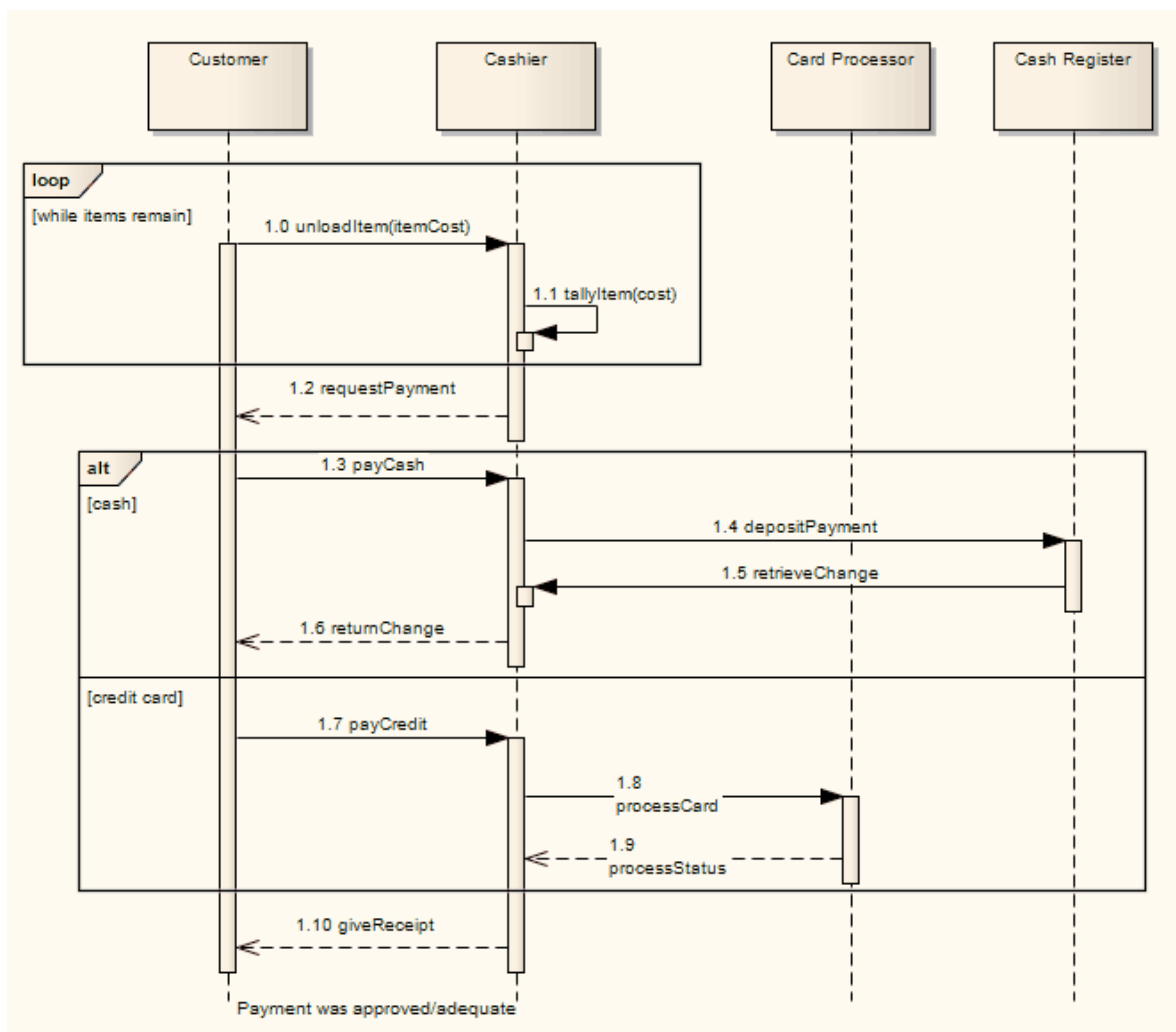

The order of interaction fragment conditions can be changed directly on the diagram. Select an interaction fragment with more than one condition defined. Up and down arrows appear on the right hand side of the each condition. Just click on the arrow to change the order.

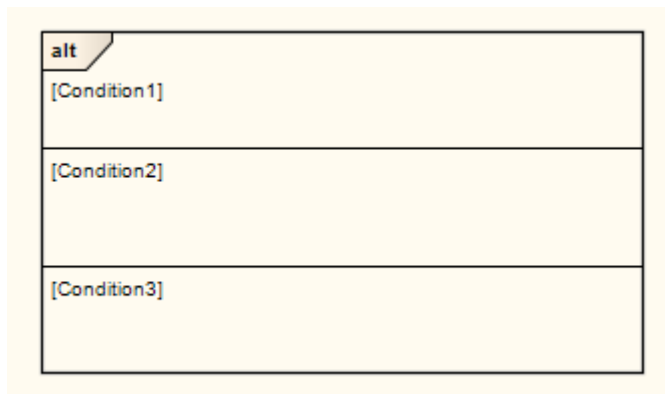

**Note:**

In order to select an interaction fragment, you must click near the inside edge or drag a selection rectangle around the fragment. This prevents accidental selection when moving connectors inside the interaction fragment.

**Tip:**

Press and hold **[Alt]** to move a combined fragment independently of its contents.

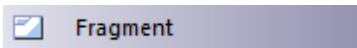
**Toolbox Icon****OMG UML Specification**

The OMG UML specification (*UML Superstructure Specification, v2.1.1, p. 467*) states:

*A combined fragment defines an expression of interaction fragments. A combined fragment is defined by an interaction operator and corresponding interaction operands. Through the use of CombinedFragments the user will be able to describe a number of traces in a compact and concise manner.*

**5.1.2.1.6.1 Create a Combined Fragment**

Use the following guidelines to create a [Combined Fragment](#)<sup>[759]</sup> in Enterprise Architect.

1. Drag the *Fragment* element from the **Interaction Elements** page of the **Toolbox**. The following dialog displays:

A dialog box for creating a Combined Fragment. It has a "Type:" dropdown menu with "alt" selected. Below it is a "Name:" text field. A section titled "Interaction Operands" contains a "Condition" text field with "else" entered. Below the condition field is a large empty rectangular area for operands. At the bottom are buttons for "Delete", "New", "Save", "OK", and "Cancel".

2. In the **Type** field, click on the drop-down arrow and select the interaction operator. See the [Interaction Operators](#)<sup>[762]</sup> topic for an explanation of the various types of Combined Fragments.
3. In the **Condition** field, specify a condition or interaction constraint for each operand.
4. A rectangular frame displays, partitioned by dashed lines into segments for each operand.
5. Adjust the frame to encompass the required event occurrences for each operand.

### 5.1.2.1.6.2 Interaction Operators

When creating [Combined Fragments](#)<sup>[759]</sup>, you must apply an appropriate interaction operator to characterize the fragment. The following table provides guidance on the various operators, and their corresponding descriptions.

Interaction Operator	Use to
<b>alt</b>	Divide up interaction fragments based on Boolean conditions.
<b>opt</b>	Enclose an optional fragment of interaction.
<b>par</b>	Indicate that operands operate in parallel.
<b>loop</b>	Indicate that the operand repeats a number of times, as specified by interaction constraints.
<b>critical</b>	Indicate a sequence that cannot be interrupted by other processing.
<b>neg</b>	Assert that a fragment is invalid, and implies that all other interaction is valid.
<b>assert</b>	Specify the only valid fragment to occur. Often enclosed within a <i>consider</i> or <i>ignore</i> operand.
<b>strict</b>	Indicate that the behaviors of the operands must be processed in strict sequence.
<b>seq</b>	Indicate that the Combined Fragment is weakly sequenced. This means that the ordering within operands is maintained, but the ordering between operands is undefined, so long as an event occurrence of the first operand precedes that of the second operand, if the event occurrences are on the same lifeline.
<b>ignore</b>	Indicate which messages should be ignored during execution, or can appear anywhere in the execution trace.
<b>consider</b>	Specify which messages should be considered in the trace. This is often used to specify the resulting event occurrences with the use of an <b>assert</b> operator.
<b>ref</b>	Provide a reference to another diagram.  <b>Note:</b> The ref fragment is not created using the method described in the <a href="#">Create a Combined Fragment</a> <sup>[761]</sup> topic. To create a ref fragment, simply drag an existing diagram from the <a href="#">Project Browser</a> onto the current diagram.

## OMG UML Specification

The OMG UML specification (*UML Superstructure Specification, v2.1.1, p. 468-471*) states:

*The semantics of a CombinedFragment is dependent upon the interactionOperator as explained below.*

### Alternatives

*The interactionOperator **alt** designates that the CombinedFragment represents a choice of behavior. At most one of the operands will be chosen. The chosen operand must have an explicit or implicit guard expression that evaluates to true at this point in the interaction. An implicit true guard is implied if the operand has no guard.*

*The set of traces that defines a choice is the union of the (guarded) traces of the operands.*

*An operand guarded by **else** designates a guard that is the negation of the disjunction of all other guards in the enclosing CombinedFragment.*

*If none of the operands has a guard that evaluates to true, none of the operands are executed and the remainder of the enclosing InteractionFragment is executed.*

### Option

The interactionOperator **opt** designates that the CombinedFragment represents a choice of behavior where either the (sole) operand happens or nothing happens. An option is semantically equivalent to an alternative CombinedFragment where there is one operand with non-empty content and the second operand is empty.

### Break

The interactionOperator **break** designates that the CombinedFragment represents a breaking scenario in the sense that the operand is a scenario that is performed instead of the remainder of the enclosing InteractionFragment. A **break** operator with a guard is chosen when the guard is true and the rest of the enclosing Interaction Fragment is ignored. When the guard of the **break** operand is false, the **break** operand is ignored and the rest of the enclosing InteractionFragment is chosen. The choice between a **break** operand without a guard and the rest of the enclosing InteractionFragment is done non-deterministically.

A CombinedFragment with interactionOperator **break** should cover all Lifelines of the enclosing InteractionFragment.

### Parallel

The interactionOperator **par** designates that the CombinedFragment represents a parallel merge between the behaviors of the operands. The OccurrenceSpecifications of the different operands can be interleaved in any way as long as the ordering imposed by each operand as such is preserved.

A parallel merge defines a set of traces that describes all the ways that OccurrenceSpecifications of the operands may be interleaved without obstructing the order of the OccurrenceSpecifications within the operand.

### Weak Sequencing

The interactionOperator **seq** designates that the CombinedFragment represents a weak sequencing between the behaviors of the operands.

Weak sequencing is defined by the set of traces with these properties:

1. The ordering of OccurrenceSpecifications within each of the operands is maintained in the result.
2. OccurrenceSpecifications on different lifelines from different operands may come in any order.
3. OccurrenceSpecifications on the same lifeline from different operands are ordered such that an OccurrenceSpecification of the first operand comes before that of the second operand.

Thus weak sequencing reduces to a parallel merge when the operands are on disjunct sets of participants. Weak sequencing reduces to strict sequencing when the operands work on only one participant.

### Strict Sequencing

The interactionOperator **strict** designates that the CombinedFragment represents a strict sequencing between the behaviors of the operands. The semantics of strict sequencing defines a strict ordering of the operands on the first level within the CombinedIFragment with interactionOperator **strict**. Therefore OccurrenceSpecifications within contained CombinedFragment will not directly be compared with other OccurrenceSpecifications of the enclosing CombinedFragment.

### Negative

The interactionOperator **neg** designates that the CombinedFragment represents traces that are defined to be invalid.

The set of traces that defined a CombinedFragment with interactionOperator negative is equal to the set of traces given by its (sole) operand, only that this set is a set of invalid rather than valid traces. All InteractionFragments that are different from Negative are considered positive meaning that they describe traces that are valid and should be possible.

### Critical Region

The interactionOperator **critical** designates that the CombinedFragment represents a critical region. A critical region means that the traces of the region cannot be interleaved by other OccurrenceSpecifications (on those Lifelines covered by the region). This means that the region is treated atomically by the enclosing fragment when determining the set of valid traces. Even though enclosing CombinedFragments may imply that some OccurrenceSpecifications may interleave into the region, such as with **par**-operator, this is prevented by defining a region.

Thus the set of traces of enclosing constructs are restricted by critical regions.

### Ignore / Consider

(p. 473) The interactionOperator **ignore** designates that there are some message types that are not shown within this combined fragment. These message types can be considered insignificant and are implicitly ignored if they appear in a corresponding execution. Alternatively one can understand **ignore** to mean that the messages that are ignored can appear anywhere in the traces.

Conversely the interactionOperator **consider** designates which messages should be considered within this CombinedFragment. This is equivalent to defining every other message to be ignored.

### Assertion

The interactionOperator **assert** designates that the CombinedFragment represents an assertion. The sequences of the operand of the assertion are the only valid continuations. All other continuations result in an invalid trace. Assertions are often combined with Ignore or Consider.

### Loop

The interactionOperator **loop** designates that the CombinedFragment represents a loop. The **loop** operand will be repeated a number of times.

The Guard may include a lower and an upper number of iterations of the loop as well as a Boolean expression. The semantics is such that a loop will iterate minimum the 'minint' number of times (given by the iteration expression in the guard) and at most the 'maxint' number of times. After the minimum number of iterations have executed, and the boolean expression is false the loop will terminate. The loop construct represent a recursive application of the **seq** operator where the **loop** operand is sequenced after the result of earlier iterations.

### The Semantics of Gates

The gates of a CombinedFragment represent the syntactic interface between the CombinedFragment and its surroundings, which means the interface towards other InteractionFragments.

The only purpose of gates is to define the source and the target of messages.

#### 5.1.2.1.7 Datastore



A *Datastore* is an element used to define permanently stored data. A token of data that enters into a Datastore is stored permanently, updating tokens for data that already exists. A token of data that comes out of a Datastore is a copy of the original data.

Use [Object Flow](#)<sup>[886]</sup> connectors to connect elements (such as [Activities](#)<sup>[753]</sup>) to Datastores, as values and information are being passed between nodes. Selection and transformation behavior, together composing a sort of query, can be specified as to the nature of data access. For instance, selection behavior determines which objects are affected by the connection to the Datastore. Transformation behavior might then further specify the value of an attribute pertaining to a selected object.

To define the behavior of access to a Datastore, attach a note to the *Object Flow* connector. To do this, right-click on the Object Flow and select the **Attach Note or Constraint** context menu option. A dialog indicates other flows in the [Activity diagram](#)<sup>[674]</sup>, to which you can attach the note (if the behavior applies to multiple flows). To comply with UML 2, preface behavior with the notation «*selection*» or «*transformation*».

### Toolbox Icon

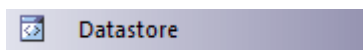

### OMG UML Specification

The OMG UML specification (*UML Superstructure Specification, v2.1.1, p. 360*) states:

*A data store node is a central buffer node for non-transient information... A data store keeps all tokens that enter it, copying them when they are chosen to move downstream. Incoming tokens containing a particular object replace any tokens in the object node containing that object.*



### 5.1.2.1.8 Decision



A *Decision* is an element of an [Activity diagram](#)<sup>[674]</sup> or [Interaction Overview diagram](#)<sup>[717]</sup> that indicates a point of conditional progression: if a condition is true, then processing continues one way; if not, then another.

This can also be used as a [Merge node](#)<sup>[784]</sup> in that multiple alternative flows can be merged (but not synchronized) to form one flow. The following examples show both of these modes of using the decision element.

**Used as a decision:**

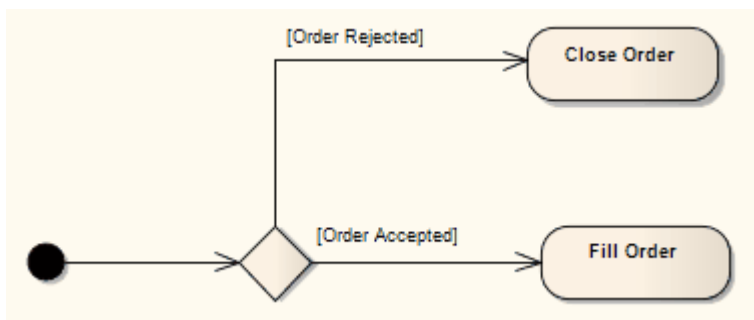

See *UML Superstructure Specification, v2.1.1, figure 12.77, p. 363.*

**Used as a merge:**

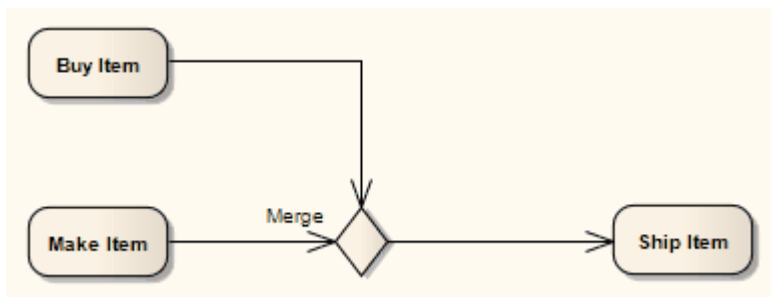

See *UML Superstructure Specification, v2.1.1, figure 12.106, p. 388.*

#### Note:

Moving a diagram generally does not affect the location of elements in packages. If you move a diagram out of one package into another, all the elements in the diagram remain in the original package. However, Decision elements are used only within one diagram, have no meaning outside that diagram, and are never re-used in any other diagram. Therefore, if you move a diagram containing these elements, they **are** moved to the new parent package with the diagram.

#### Toolbox Icon

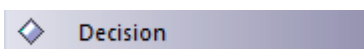

#### OMG UML Specification

The OMG UML specification (*UML Superstructure Specification, v2.1.1, p. 361 (Decision symbol)*) states:

A decision node is a control node that chooses between outgoing flows. A decision node has one incoming edge and multiple outgoing activity edges.

The OMG UML specification (*UML Superstructure Specification, v2.1.1, p. 387 (Merge symbol)*) also states:

*A merge node is a control node that brings together multiple alternate flows. It is not used to synchronize concurrent flows but to accept one among several alternate flows... A merge node has multiple incoming edges and a single outgoing edge.*

### 5.1.2.1.9 Diagram Frame

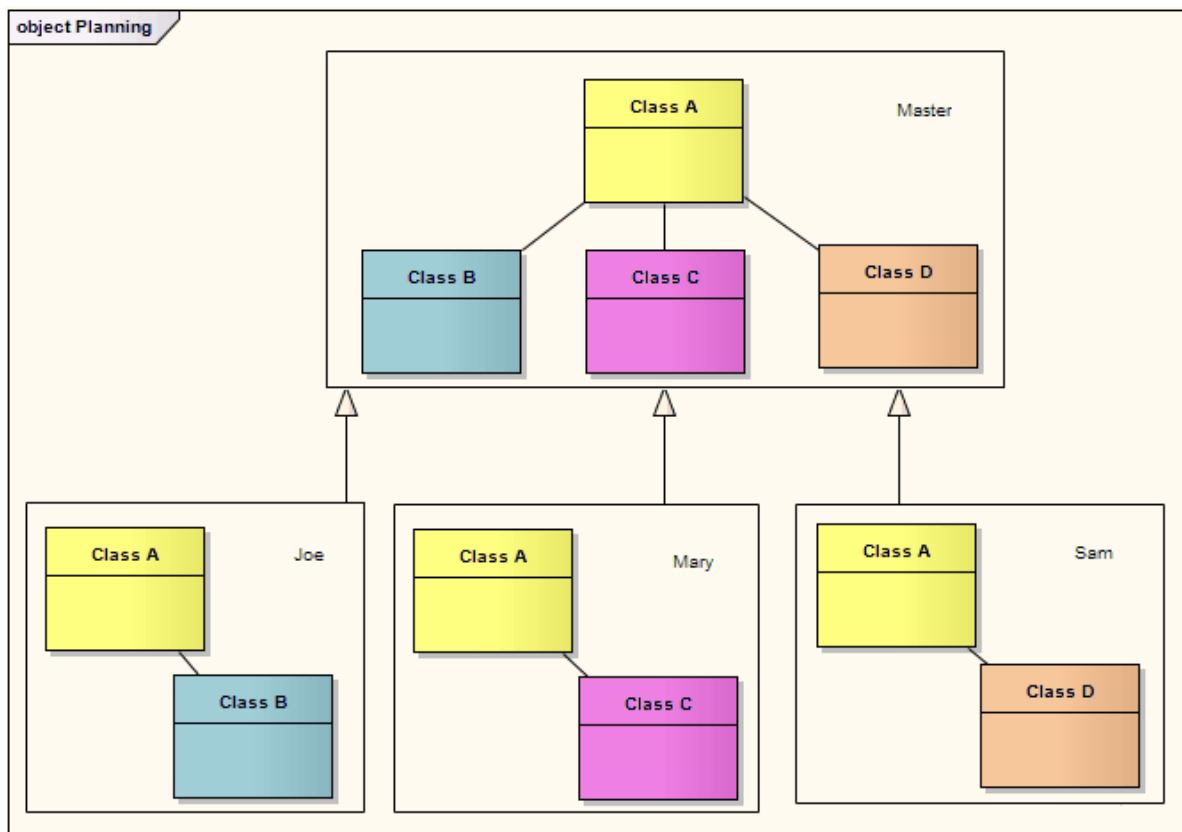

A *Diagram Frame* element is a rendition of a diagram dropped from the **Project Browser** into another diagram. It is a type of **Combined Fragment** <sup>[759]</sup> with the **Interaction Operator** <sup>[762]</sup> ref. However, it can be created on any type of diagram, and is not created in the same way as other Combined Fragments.

When you drop the diagram from the **Project Browser** onto the open diagram, the following prompt displays:

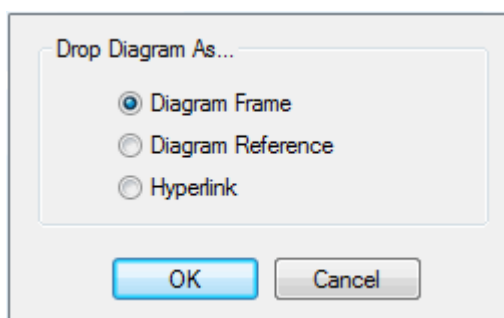

If you click on the **Diagram Frame** radio button, a Diagram Frame is inserted into the diagram, containing an image of the dropped diagram.

If you select the **Diagram Reference** option, an empty frame is inserted with the name of the dropped diagram

in the frame label. If you select the **Hyperlink** radio button, a diagram icon is inserted with no frame, and with the parent package and diagram name next to it.

In all three cases, the object acts as a hyperlink to the real referenced diagram. You can also define properties for the objects, as for other elements, by right-clicking on the object and selecting the element **Properties** context menu option.

#### Notes:

- You can change the size of all three objects, but you cannot reduce a Diagram Frame to less than the size of the enclosed diagram.
- You cannot change the diagram within a Diagram Frame. To edit the diagram, double-click within the frame and edit the original diagram.
- The Diagram Frame element looks identical to but is **not the same** as a diagram frame *border*, which you can set automatically on new *images* of diagrams using the **Tools | Options | Diagram** option, and selecting the appropriate checkboxes in the **Diagram Frames** panel. These options set frames on print-outs of diagrams, images of diagrams copied to file, and images of diagrams copied to the clipboard. If you paste the image from the clipboard into another diagram, the image initially looks the same as the Diagram Frame element but it is actually a discreet unit that you manipulate using the [Image Manager](#)<sup>[447]</sup>.

#### 5.1.2.1.10 Diagram Gate

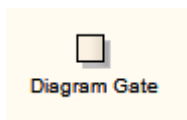

A *Diagram Gate* is a simple graphical way to indicate the point at which messages can be transmitted into and out of interaction fragments. A fragment might be required to receive or deliver a message; internally, an ordered message reflects this requirement, with a gate indicated on the boundary of the fragment's frame. Any external messages 'synching' with this internal message must correspond appropriately. Gates can appear on Interaction diagrams ([Sequence](#)<sup>[706]</sup>, [Timing](#)<sup>[690]</sup>, [Communication](#)<sup>[715]</sup> or [Interaction Overview](#)<sup>[717]</sup>), [interaction occurrences](#)<sup>[780]</sup> and [combined fragments](#)<sup>[759]</sup> (to specify the expression).

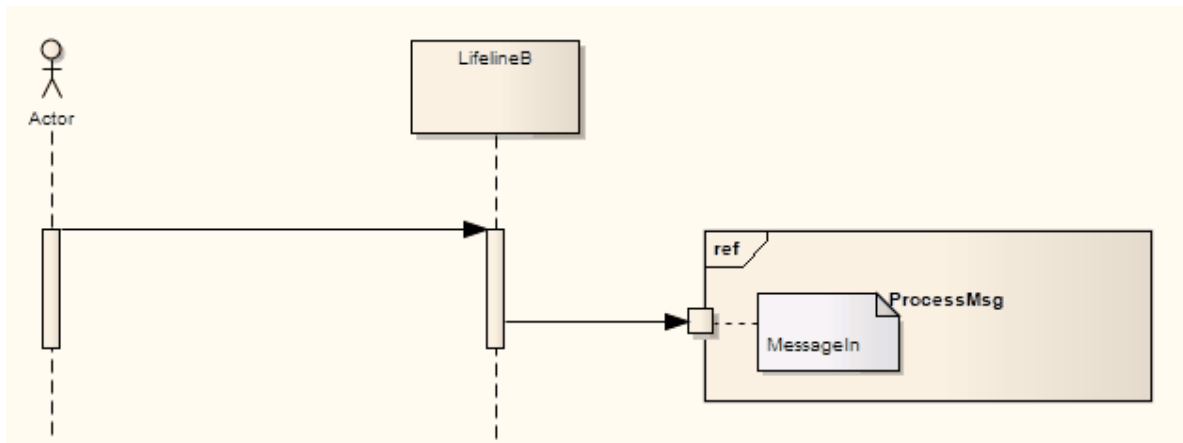

#### Toolbox Icon

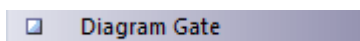

#### OMG UML Specification

The OMG UML specification (*UML Superstructure Specification, v2.1.1, p. 480*) states:

*A Gate is a connection point for relating a Message outside an InteractionFragment with a Message inside the InteractionFragment ... Gates are connected through Messages. A Gate is actually a representative of an*

*OccurrenceSpecification that is not in the same scope as the Gate. Gates play different roles: we have formal gates on Interactions, actual gates on InteractionUses, expression gates on CombinedFragments.*

### 5.1.2.1.11 Endpoint

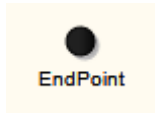

An *Endpoint* is used in Interaction diagrams ([Sequence](#)<sup>[706]</sup>, [Timing](#)<sup>[690]</sup>, [Communication](#)<sup>[715]</sup> or [Interaction Overview](#)<sup>[717]</sup>) to reflect a lost or found message in sequence. To model this, drag an *Endpoint* element onto the workspace.

With Sequence diagrams, drag a message from the appropriate lifeline to the Endpoint. With Timing diagrams, the message connecting the lifeline to the Endpoint requires some timing specifications to draw the connection.

The following example depicts a lost message in a Sequence diagram.

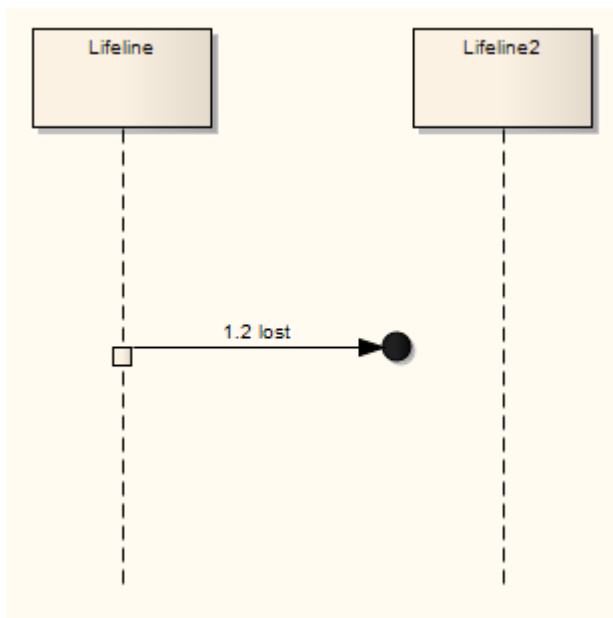

#### Toolbox Icon

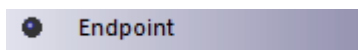

#### OMG UML Specification

The OMG UML specification (*UML Superstructure Specification, v2.1.1, p. 492*) states:

*A lost message is a message where the sending event occurrence is known, but there is no receiving event occurrence. We interpret this to be because the message never reached its destination.*

*A found message is a message where the receiving event occurrence is known, but there is no (known) sending event occurrence. We interpret this to be because the origin of the message is outside the scope of the description. This may, for example, be noise or other activity that we do not want to describe in detail.*

### 5.1.2.1.12 Entry Point

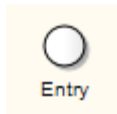

*Entry Point* [pseudo-states](#)<sup>[682]</sup> are used to define the beginning of a [State Machine](#)<sup>[678]</sup>. An Entry Point exists for each region, directing the initial concurrent state configuration.

#### Toolbox Icon



#### OMG UML Specification

The OMG UML specification (*UML Superstructure Specification, v2.1.1, p. 471*) states:

*An entry point pseudostate is an entry point of a state machine or composite state. In each region of the state machine or composite state it has a single transition to a vertex within the same region.*

### 5.1.2.1.13 Exception

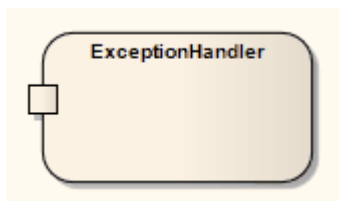

The *Exception Handler* element defines the group of operations to carry out when an exception occurs. In an [Activity diagram](#)<sup>[674]</sup>, the protected element can contain a set of operations and is connected to the exception handler via an [Interrupt Flow](#)<sup>[867]</sup> connector. Any defined error contained within an element's parts can trigger the flow to move to an exception.

#### Toolbox Icon

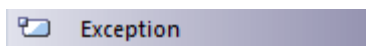

#### OMG UML Specification

The OMG UML specification (*UML Superstructure Specification, v2.1.1, p. 364*) states:

*An exception handler is an element that specifies a body to execute in case the specified exception occurs during the execution of the protected node.*

### 5.1.2.1.14 Expansion Region

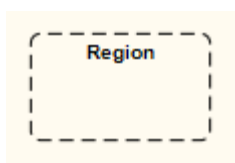

You [create](#)<sup>[771]</sup> an *Expansion Region* as one variant of a [Region](#)<sup>[788]</sup> (the other is an [Interruptible Activity Region](#)<sup>[781]</sup>).

On an [Activity diagram](#)<sup>[674]</sup>, an Expansion Region surrounds a process to be imposed multiple times on the

incoming data, once for every element in the input collection. If there are multiple inputs, the collection sizes must match, and the elements within each collection must be of the same type. Similarly, any outputs must be in the form of a collection matching the size of the inputs.

The concurrency of the Expansion Region's multiple executions can be specified as type *parallel*, *iterative*, or *stream*. Parallel reflects that the elements in the incoming collections can be processed at the same time or overlapping, whereas an iterative concurrency type specifies that execution must occur sequentially. A stream-type Expansion Region indicates that the input and output come in and exit as streams, and that the Expansion Region's process must have some method to support streams.

To modify the mode of an Expansion Region, right-click on it and select the **Advanced | Custom Properties** context menu option.

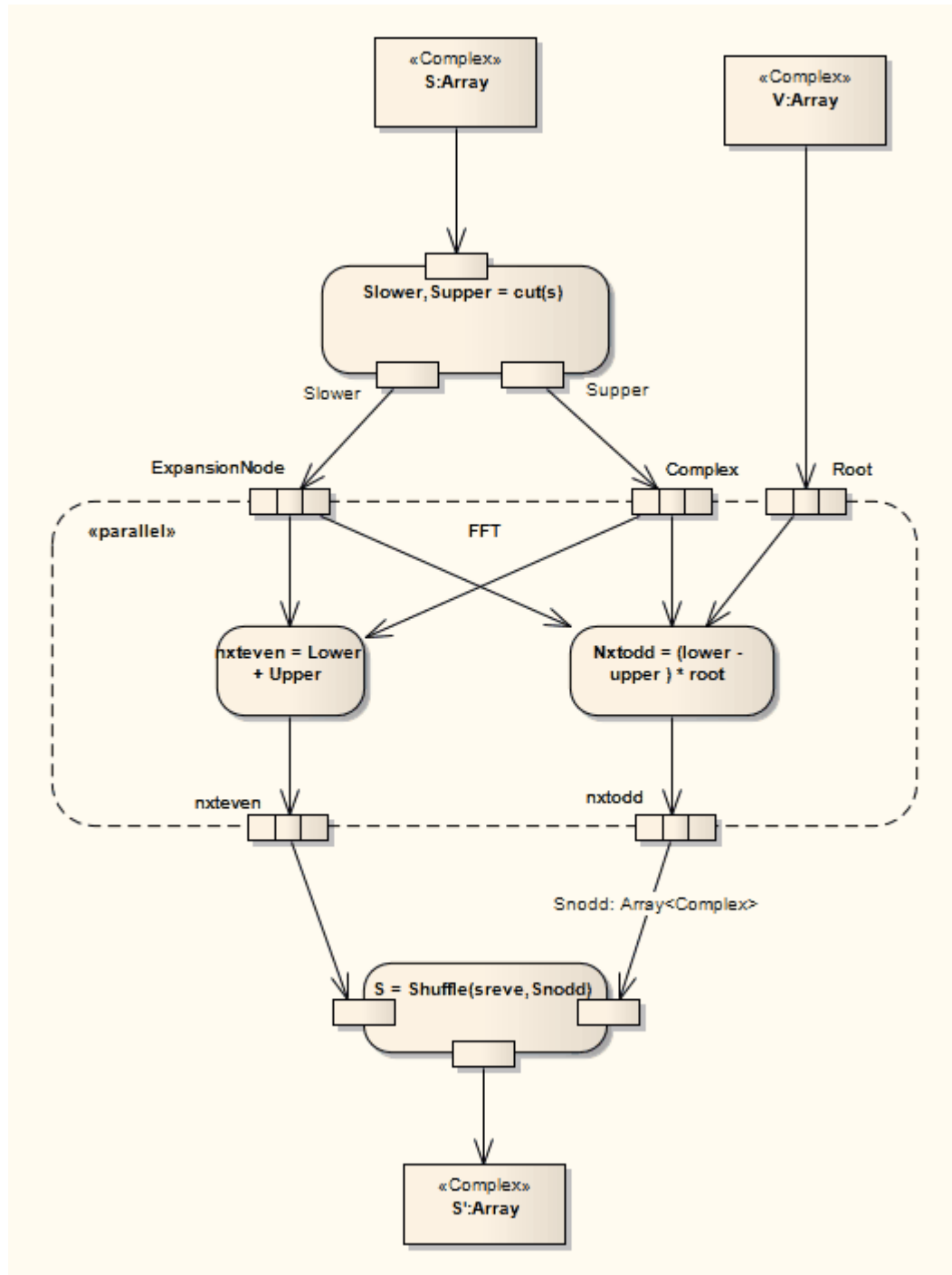

See *UML Superstructure Specification, v2.1.1*, figure 12.87, p. 372.

## Toolbox Icon



## OMG UML Specification

The OMG UML specification (*UML Superstructure Specification, v2.1.1, p. 367*) states:

*An expansion region is a structured activity region that executes multiple times corresponding to elements of an input collection.*

### 5.1.2.1.14 Add Expansion Region

When you add a [Region](#)<sup>[788]</sup> element to a diagram, the following prompt displays:

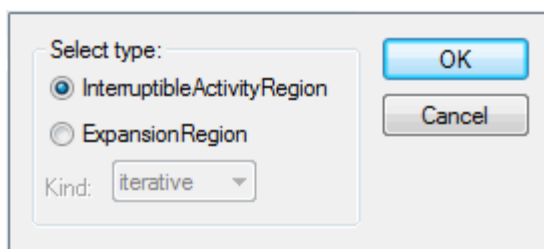

The **Select type** defaults to **InterruptibleActivityRegion**.

1. Select the type [ExpansionRegion](#)<sup>[769]</sup>.
2. In the **Kind** field, click on the drop-down arrow and select the concurrency attribute.

### 5.1.2.1.15 Exit Point

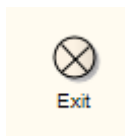

*Exit Points* are used in [Submachine states](#)<sup>[796]</sup> and [State Machines](#)<sup>[789]</sup> to denote the point where the machine is exited and the transition sourcing this exit point, for Submachines, is triggered. Exit points are a type of [pseudo-state](#)<sup>[682]</sup> used in the [State Machine](#)<sup>[678]</sup> diagram.

## Toolbox Icon



## OMG UML Specification

The OMG UML specification (*UML Superstructure Specification, v2.1.1 p. 538*) states:

*An exit point pseudostate is an exit point of a state machine or composite state. Entering an exit point within any region of the composite state or state machine referenced by a submachine state implies the exit of this composite state or submachine state and the triggering of the transition that has this exit point as source in the state machine enclosing the submachine or composite state.*

### 5.1.2.1.16 Final

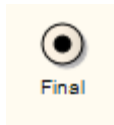

There are two nodes used to define a *Final* state in an [Activity](#)<sup>[753]</sup>, both defined in UML 2.3 as of type *Final Node*. The *Activity Final* element, shown above, indicates the completion of an Activity; upon reaching the Final, all execution in the [Activity diagram](#)<sup>[674]</sup> is aborted. The other type of final node, [Flow Final](#)<sup>[772]</sup>, depicts an exit from the system that has no effect on other executing flows in the Activity.

The following example illustrates the development of an application. The process comes to a Flow Final node when there are no more components to be built; note that the [Fork](#)<sup>[775]</sup> element indicates a concurrent process with the building of new components and installation of completed components. The Flow Final terminates only the sub-process building components. Similarly, only those tokens entering the decision branch for the installation of further components terminate with the connecting Flow Final (that is, stop installing this component, but keep on installing other components). It is only after the *Deliver Application* activity is completed, after the control flow reaches the Final node, that all flows stop.

The node that initiates a flow is the [Initial](#)<sup>[778]</sup> node.

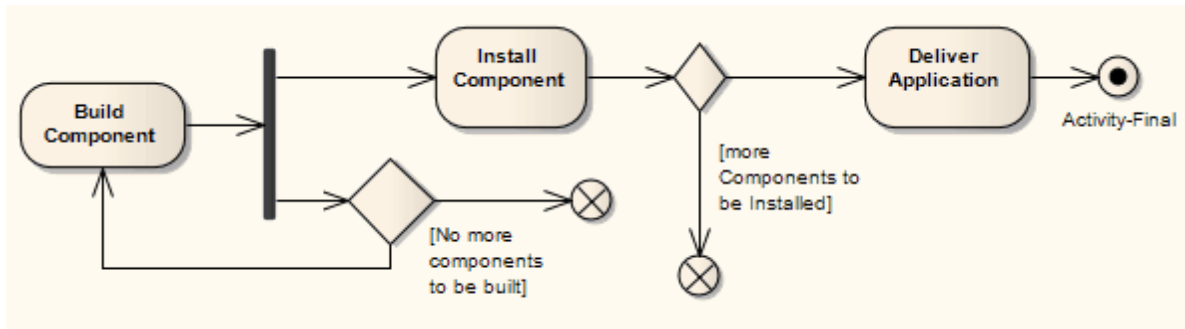

See *UML Superstructure Specification, v2.1.1, figure 12.91, p. 374*.

#### Note:

Moving a diagram generally does not affect the location of elements in packages. If you move a diagram out of one package into another, all the elements in the diagram remain in the original package. However, Final elements are used only within one diagram, have no meaning outside that diagram, and are never re-used in any other diagram. Therefore, if you move a diagram containing these elements, they **are** moved to the new parent package with the diagram.

### Toolbox Icon



### OMG UML Specification

The OMG UML specification (*UML Superstructure Specification, v2.1.1, p. 332*) states:

*An activity may have more than one activity final node. The first one reached stops all flows in the activity.*

### 5.1.2.1.17 Flow Final

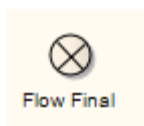



There are two nodes used to define a final state in an Activity, both defined in UML 2.3 as of type *Final Node*. The *Flow Final* element depicts an exit from the system, as opposed to the *Activity Final*<sup>[772]</sup>, which represents the completion of the Activity. Only the flow entering the Flow Final node exits the Activity; other flows continue undisturbed.

The following example *Activity Diagram*<sup>[674]</sup> illustrates the development of an application. The process comes to a Flow Final node when there are no more components to be built; note that the *Fork*<sup>[775]</sup> element indicates a concurrent process with the building of new components and installation of completed components. The Flow Final terminates only the sub-process building components. Similarly, only those tokens entering the decision branch for the installation of further components terminate with the connecting Flow Final (that is, stop installing this component, but keep on installing other components). It is only after the *Deliver Application* activity is completed, after the control flow reaches the Final node, that all flows stop.

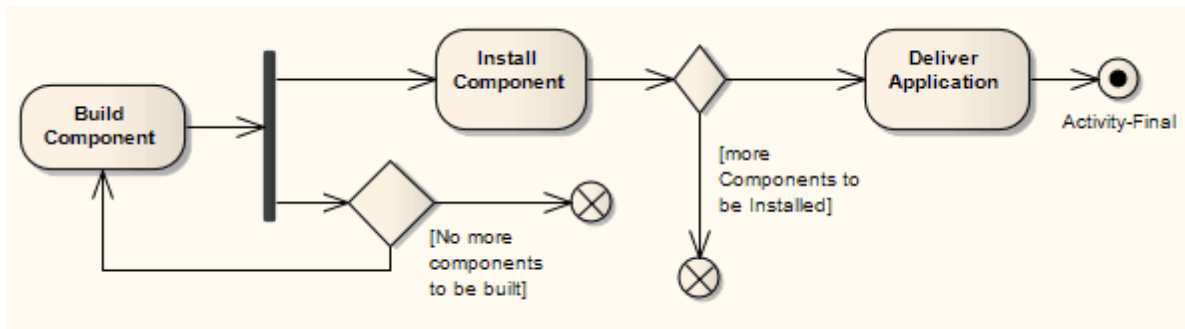

See *UML Superstructure Specification, v2.1.1, figure 12.91, p. 374*.

#### Note:

Moving a diagram generally does not affect the location of elements in packages. If you move a diagram out of one package into another, all the elements in the diagram remain in the original package. However, Flow Final elements are used only within one diagram, have no meaning outside that diagram, and are never re-used in any other diagram. Therefore, if you move a diagram containing these elements, they **are** moved to the new parent package with the diagram.

### Toolbox Icon

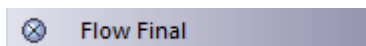

### OMG UML Specification

The OMG UML specification (*UML Superstructure Specification, v2.1.1, p. 375*) states:

*A flow final destroys all tokens that arrive at it. It has no effect on other flows in the activity.*

#### 5.1.2.1.18 Fork/Join

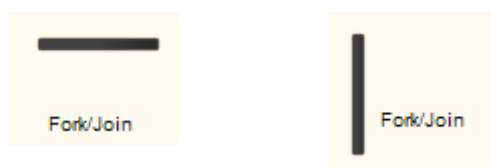

The *Fork/Join* elements have different modes of use, as follows:

- To fork or split the flow into a number of concurrent flows.
- To join the flow of a number of concurrent flows.
- To both join and fork a number of incoming flows to a number of outgoing flows.

These elements are used in both *Activity*<sup>[674]</sup> and *State Machine*<sup>[678]</sup> diagrams. With respect to State Machine diagrams, *Forks*<sup>[775]</sup> and *Joins*<sup>[776]</sup> are used as *pseudo-states*<sup>[682]</sup>. Other pseudo-states include *history states*

[777], [entry points](#) [769] and [exit points](#) [771]. Forks are used to split an incoming transition into concurrent multiple transitions leading to different target states. Joins are used to merge concurrent multiple transitions into a single transition leading to a single target. They are semantic inverses. To learn more about these individual elements see their specific topics.

Some examples of Fork/Join nodes include:

**Fork or split the flow into a number of concurrent flows:**

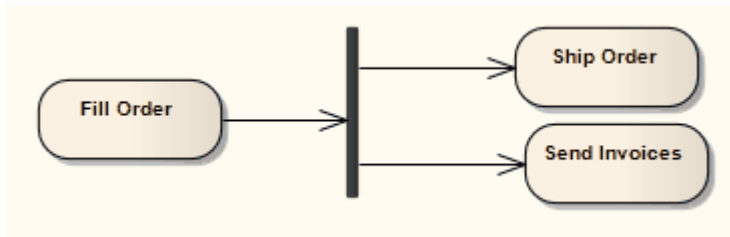

See *UML Superstructure Specification, v2.1.1, figure 12.95 p. 377.*

**Join the flow of a number of concurrent flows:**

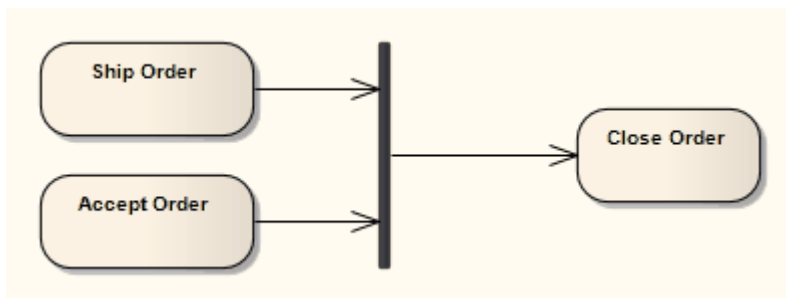

See *UML Superstructure Specification, v2.1.1, figure 12.103, p. 384.*

**Join and Fork a number of incoming flows to a number of outgoing flows:**

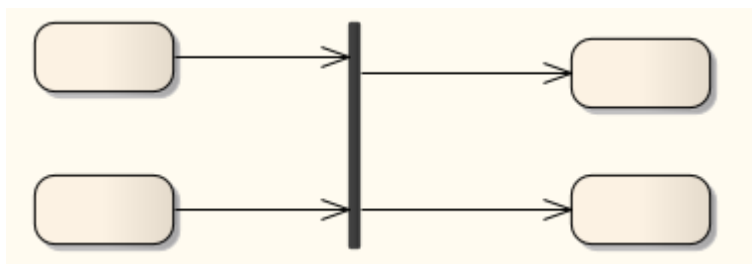

### Toolbox Icon

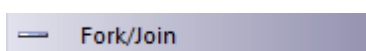

### OMG UML Specification

#### Fork

The OMG UML specification (*UML Superstructure Specification, v2.1.1, p. 376*) states:

*A fork node is a control node that splits a flow into multiple concurrent flows... A fork node has one incoming edge and multiple outgoing edges.*

#### Join

The OMG UML specification (*UML Superstructure Specification, v2.1.1, p. 381-382*) states:

A join node is a control node that synchronizes multiple flows... A join node has multiple incoming edges and one outgoing edge.

#### 5.1.2.1.18.1 Fork

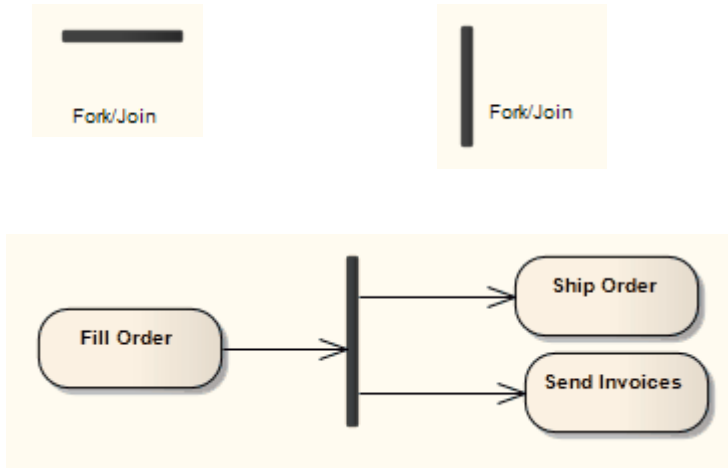

See *UML Superstructure Specification, v2.1.1, figure 12.95 p. 377.*

These elements are used in both [Activity](#)<sup>[674]</sup> and [State Machine](#)<sup>[678]</sup> diagrams. With respect to State Machine diagrams, a [Fork pseudo-state](#)<sup>[682]</sup> signifies that its incoming transition comes from a single state, and it has multiple outgoing transitions. These transitions must occur concurrently, requiring the use of concurrent [regions](#)<sup>[786]</sup>, as depicted below in the [Composite State](#)<sup>[790]</sup>. Unlike [Choice](#)<sup>[758]</sup> or [Junction](#)<sup>[782]</sup> pseudo-states, Forks must not have triggers or guards. The following diagram demonstrates a Fork pseudo-state dividing into two concurrent regions, which then return to the *End State* via the [Join](#)<sup>[776]</sup> pseudo-state.

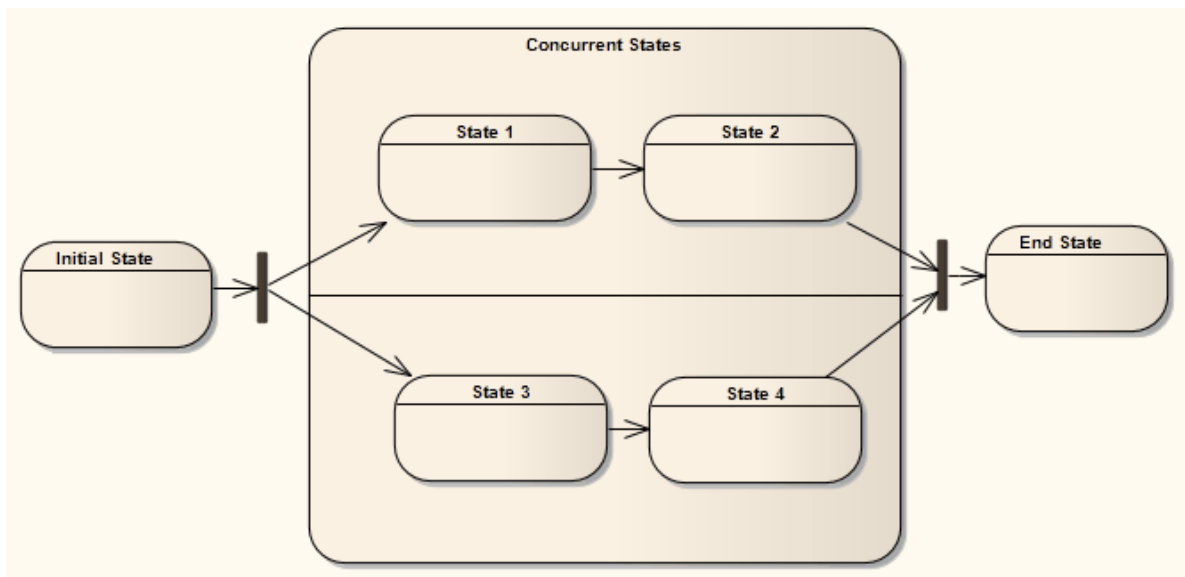

### OMG UML Specification

The OMG UML specification (*UML Superstructure Specification, v2.1.1, p. 538*) states:

*Fork vertices serve to split an incoming transition into two or more transitions terminating on orthogonal target vertices (i.e. vertices in different regions of a composite state). The segments outgoing from a fork vertex must not have guards or triggers.*

### 5.1.2.1.18.2 Join

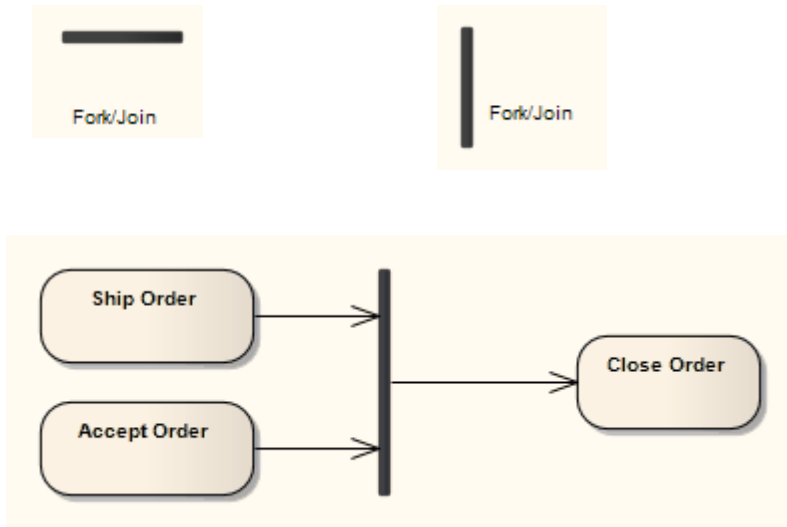

See *UML Superstructure Specification, v2.1.1, figure 12.103, p. 384.*

The *Join* element is used by [Activity](#) [674] and [State Machine](#) [678] diagrams. The above example illustrates a Join transition between Activities. With respect to State Machine diagrams, a Join [pseudo-state](#) [682] indicates multiple [States](#) [789] concurrently transitioning into the Join and onto a single State. Unlike [Choice](#) [758] or [Junction](#) [782] pseudo-states, Joins must not have triggers or guards. The following diagram demonstrates a [Fork](#) [775] pseudo-state dividing into two concurrent [Regions](#) [788], which then return to the *End State* via the Join.

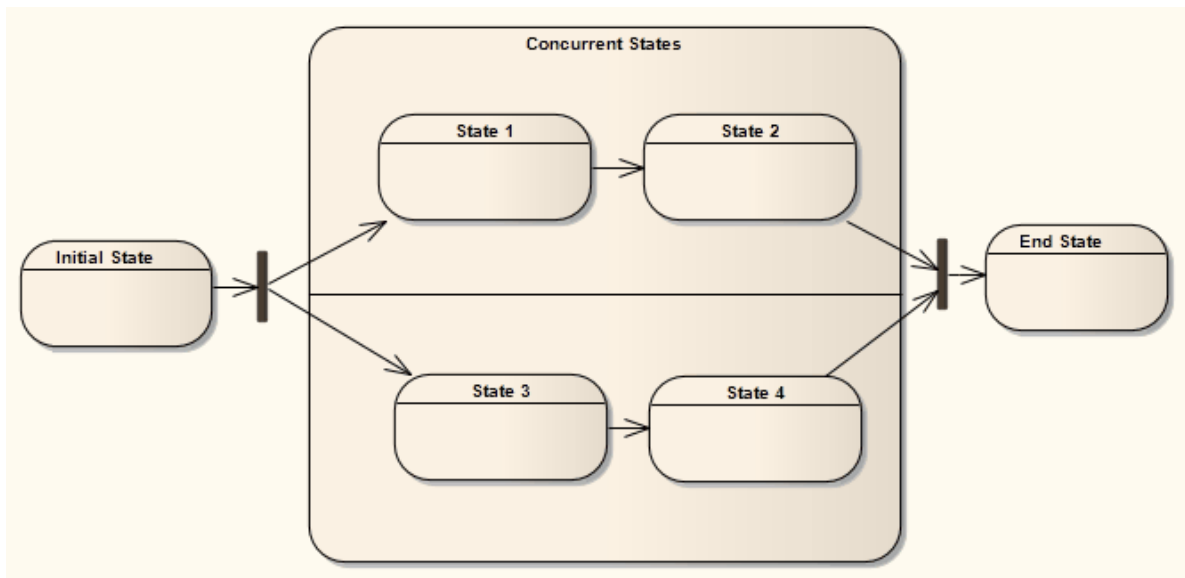

### OMG UML Specification

The OMG UML specification (*UML Superstructure Specification, v2.1.1, p. 538*) states:

*Join vertices serve to merge several transitions emanating from source vertices in different orthogonal regions. The transitions entering a join vertex cannot have guards or triggers.*

## 5.1.2.1.19 History



There are two types of *History pseudo-state* <sup>[682]</sup> defined in UML: *shallow* and *deep History*. A shallow History sub-state is used to represent the most recently active sub-state of a *Composite State* <sup>[790]</sup>; this pseudo-state does not recurse into this sub-state's active configuration, should one exist. A single connector can be used to depict the default shallow History state, in case the Composite State has never been entered.

A deep History sub-state, in contrast, reflects the most recent active configuration of the Composite State. This includes active sub-states of all regions, and recurses into those sub-states' active sub-states, should they exist. At most one deep History and one shallow History can dwell within a composite state. You can convert a shallow History pseudostate to a deep History pseudostate using the *Advanced* <sup>[550]</sup> element context menu.

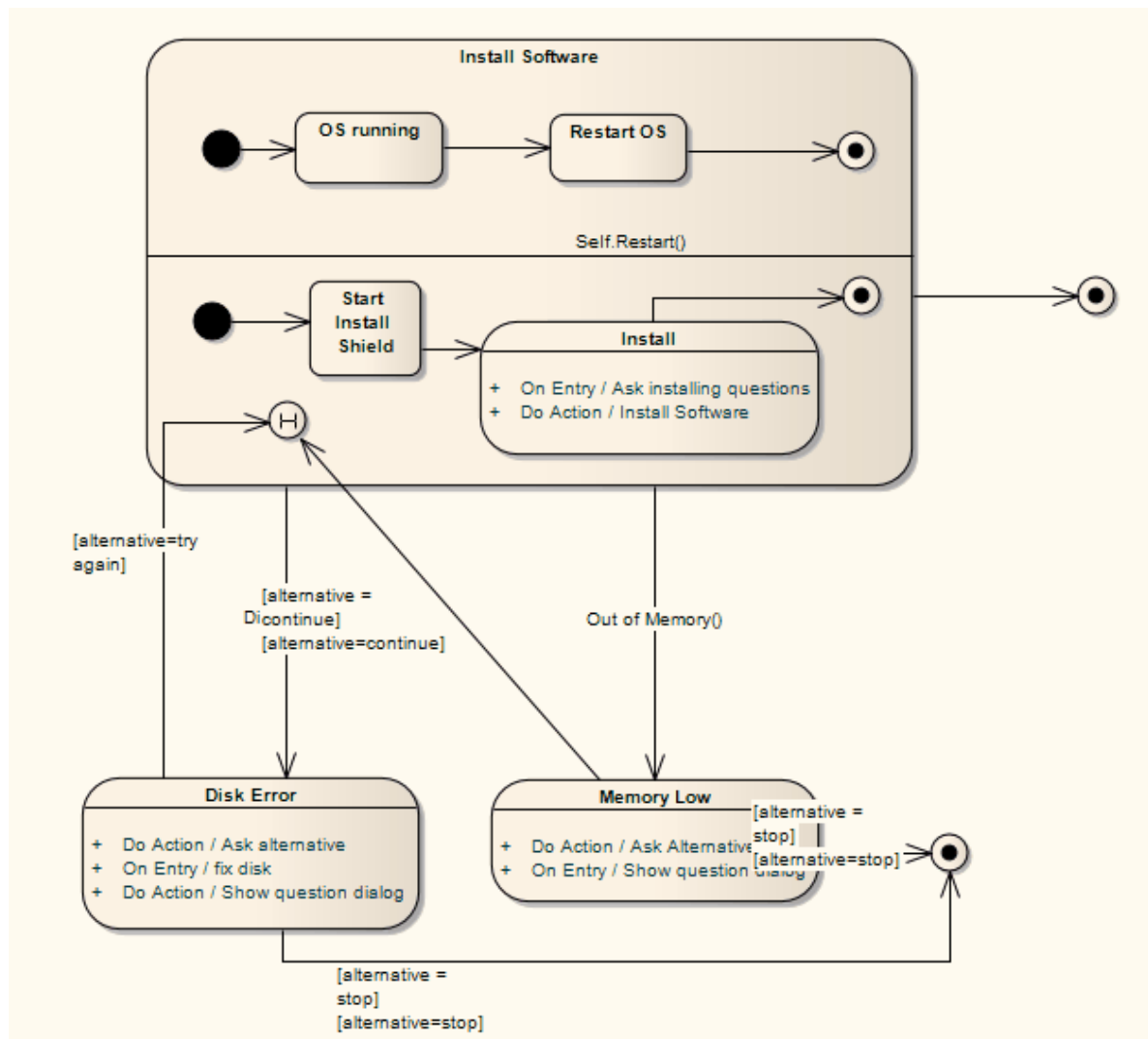

## Toolbox Icon



## OMG UML Specification

The OMG UML specification (*UML Superstructure Specification*, v2.1.1, p. 537) states:

... *deepHistory* represents the most recent active configuration of the composite state that directly contains this pseudostate (e.g., the state configuration that was active when the composite state was last exited). A composite state can have at most one deep history vertex. At most one transition may originate from the history connector to the default deep history state. This transition is taken in case the composite state had never been active before. Entry actions of states entered on the path to the state represented by a deep history are performed.

... *shallowHistory* represents the most recent active substate of its containing state (but not the substates of that substate). A composite state can have at most one shallow history vertex. A transition coming into the shallow history vertex is equivalent to a transition coming into the most recent active substate of a state. At most one transition may originate from the history connector to the default shallow history state. This transition is taken in case the composite state had never been active before. Entry actions of states entered on the path to the state represented by a shallow history are performed.

### 5.1.2.1.20 Initial



The *Initial* element is used by [Activity](#)<sup>[674]</sup> and [State Machine](#)<sup>[678]</sup> diagrams. In Activity diagrams, it defines the start of a flow when an [Activity](#)<sup>[753]</sup> is invoked. With State Machines, the Initial element is a [pseudo-state](#)<sup>[682]</sup> used to denote the default state of a [Composite State](#)<sup>[790]</sup>; there can be one Initial vertex in each [Region](#)<sup>[788]</sup> of the Composite State.

This simple example shows the start of a flow to receive an order.

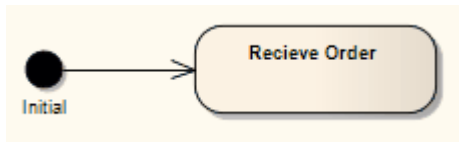

See *UML Superstructure Specification*, v2.1.1, Figure 12.97, p. 378.

The activity flow is completed by a [Final](#)<sup>[772]</sup> or [Flow Final](#)<sup>[772]</sup> node.

#### Note:

Moving a diagram generally does not affect the location of elements in packages. If you move a diagram out of one package into another, all the elements in the diagram remain in the original package. However, Initial elements are used only within one diagram, have no meaning outside that diagram, and are never re-used in any other diagram. Therefore, if you move a diagram containing these elements, they **are** moved to the new parent package with the diagram.

## Toolbox Icon



## OMG UML Specification

The OMG UML specification (*UML Superstructure Specification*, v2.1.1, p. 537) states:

An *initial pseudostate* represents a default vertex that is the source for a single transition to the default state of a composite state. There can be at most one initial vertex in a region. The outgoing transition from the initial vertex may have a behavior, but not a trigger or guard.

The OMG UML specification (*UML Superstructure Specification*, v2.1.1, p. 378) also states:

An initial node is a control node at which flow starts when the activity is invoked.

### 5.1.2.121 Interaction

An *Interaction* element is used to describe a system, representing its interactions at varying levels of detail, for review not only by design professionals but also by end users and stakeholders. An Interaction element can contain the following types of diagram:

- [Sequence](#) <sup>[706]</sup>
- [Interaction Overview](#) <sup>[717]</sup>
- [Communication](#) <sup>[715]</sup>
- [Timing](#) <sup>[690]</sup>.

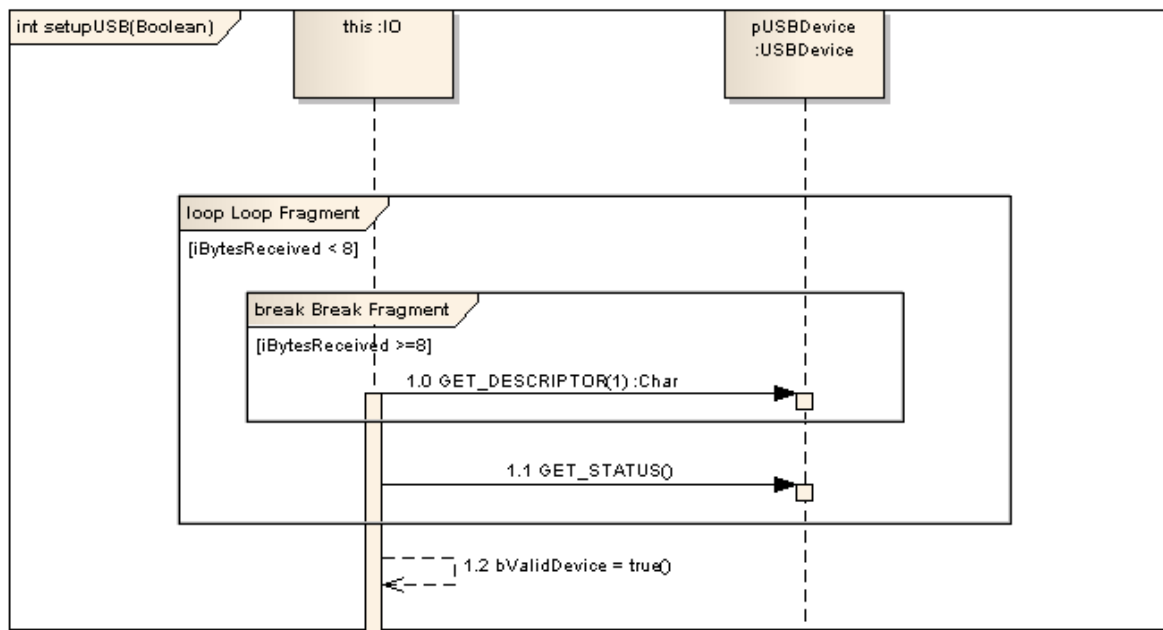

An Interaction element in Enterprise Architect is treated as a behavior of the classifier it is encapsulated within. It can have parameters and return types, which are modeled using the **Behavior** tab of the Interaction element's **Properties** dialog. The element is interpreted as a method of the containing Class in the generated code (see the [Generate Code From Behavioral Model](#) <sup>[1314]</sup> topic).

An Interaction element can also be set as the classifier for an [Interaction Occurrence](#) <sup>[780]</sup> in a Sequence diagram, or for a [Call Behavior Action](#) <sup>[745]</sup> in an Activity diagram. Establishing such an association (between a [behavior](#) <sup>[582]</sup> and a [behavior call](#) <sup>[582]</sup>) facilitates adding [arguments](#) <sup>[582]</sup> that can be individually mapped to the associated behavior's parameters.

#### Note:

The behavioral code generation engine expects the Sequence diagram and all its associated messages and interaction fragments to be encapsulated within an Interaction element (such as *setupUSB* in the example below).

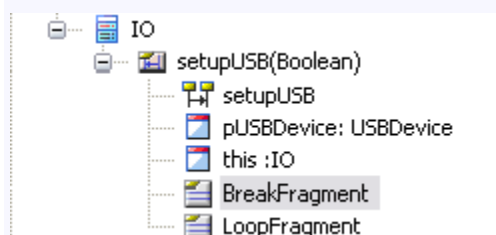

(The IO Class shown above is available in the EAExample model, under *Systems Engineering Model | Implementation Model | Software*.)

### 5.1.2.1.22 Interaction Occurrence



An *Interaction Occurrence* (or *InteractionUse*) is a reference to an existing *Interaction* ([Sequence](#)<sup>[706]</sup>) diagram. Interaction Occurrences are visually represented by a frame, with **ref** in the frame's title space. The diagram name is indicated in the frame contents. To create an Interaction Occurrence, simply open a Sequence diagram (preferably contained within an *Interaction element*<sup>[779]</sup>) and drag another Sequence diagram (also preferably contained within an Interaction element) into its workspace. A dialog displays, providing configuration options. The resulting Interaction Occurrence acts as an invocation of the original Interaction. You use the [Call](#)<sup>[581]</sup> tab of the element **Properties** dialog to set up the actual [arguments](#)<sup>[582]</sup> of the Interaction and also to change to a different associated Interaction element.

The following figure illustrates the use of an Interaction Occurrence in another Interaction (Sequence) diagram. You can display the sequence represented by the Interaction Occurrence by double-clicking on the element.

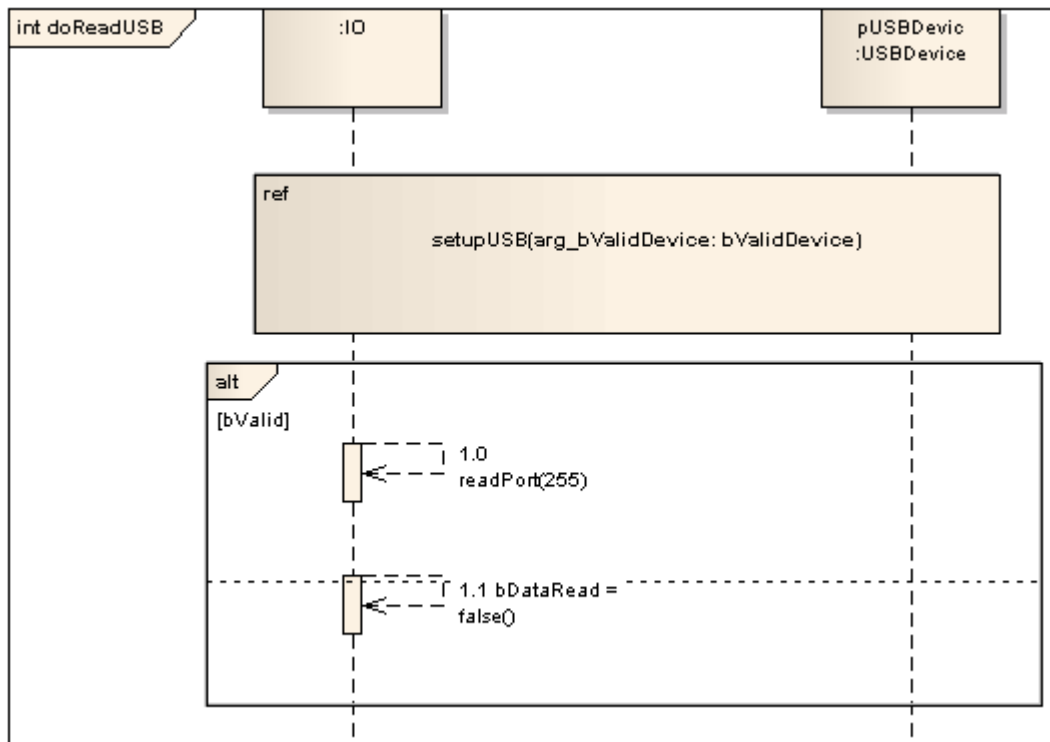



**Note:**

The behavioral code generation engine expects the Sequence diagram and all its associated messages and interaction fragments to be encapsulated within an Interaction element (such as *doReadUSB* in the example below).

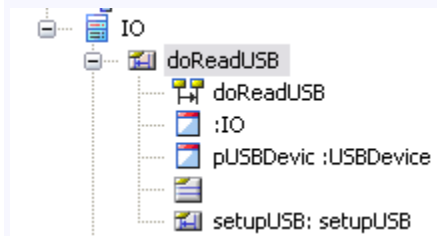
**OMG UML Specification**

The OMG UML specification (*UML Superstructure Specification, v2.1.1, p. 423*) refers to an Interaction Occurrence as an **InteractionUse**, and states:

*An InteractionUse refers to an Interaction. The InteractionUse is a shorthand for copying the contents of the referred Interaction where the InteractionUse is. To be accurate the copying must take into account substituting parameters with arguments and connect the formal gates with the actual ones.*

*It is common to want to share portions of an interaction between several other interactions. An InteractionUse allows multiple interactions to reference an interaction that represents a common portion of their specification.*

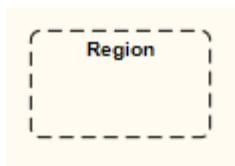
**5.1.2.1.23 Interruptible Activity Region**

You [create](#)<sup>[782]</sup> an *Interruptible Activity Region* as one variant of a [Region](#)<sup>[788]</sup> (the other is an [Expansion Region](#)<sup>[769]</sup>).

In an [Activity diagram](#)<sup>[674]</sup>, an Interruptible Activity Region surrounds a group of [Activity](#)<sup>[753]</sup> elements, all affected by certain interrupts in such a way that all tokens passing within the region are terminated should the interruption(s) be raised. Any processing occurring within the bounds of an Interruptible Activity Region is terminated when a flow is instigated across an interrupt flow to an external element.

The example below illustrates that an order cancellation kills any processing of the order at the receipt, filling or shipping stage.

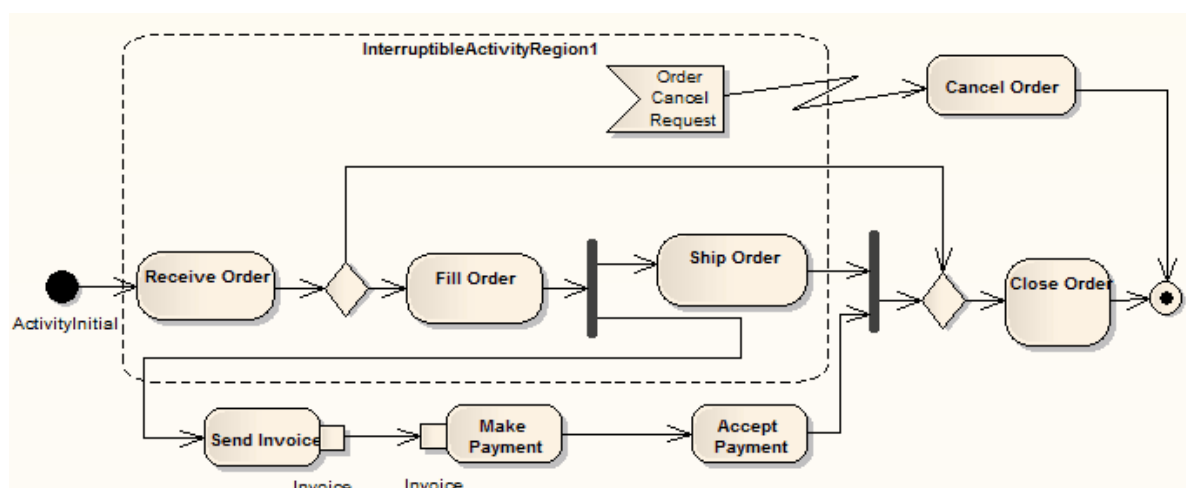

See *UML Superstructure Specification, v2.1.1, figure 12.100, p. 381*.

To create an Interruptible Activity Region, click on this [Add an Interruptible Activity Region](#)<sup>[782]</sup> link.

## Toolbox Icon



## OMG UML Specification

The OMG UML specification (*UML Superstructure Specification, v2.1.1, p. 380*) states:

*An interruptible region contains activity nodes. When a token leaves an interruptible region via edges designated by the region as interrupting edges, all tokens and behaviors in the region are terminated.*

### 5.1.2.1.23.1 Add Interruptible Activity Region

When you add a *Region* element to an Activity diagram, the following prompt displays:

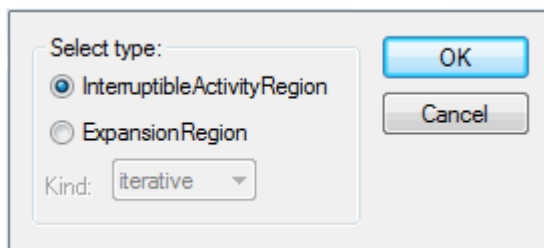

The **Select type** panel defaults to [InterruptibleActivityRegion](#)<sup>[781]</sup> and the **Kind** field is disabled. Click on the **OK** button.

### 5.1.2.1.24 Junction



*Junction pseudo-states*<sup>[682]</sup> are used to design complex transitional paths in *State Machine*<sup>[678]</sup> diagrams. A Junction can be used to combine or merge multiple paths into a shared transition path. Alternatively, a Junction can split an incoming path into multiple paths, similar to a [Fork](#)<sup>[775]</sup> pseudostate. Unlike Forks or [Joins](#)<sup>[776]</sup>, Junctions can apply guards to each incoming or outgoing transition, such that if the guard expression is false, the transition is disabled.

The following example illustrates how guards can be applied to transitions coming into or out of a Junction pseudo-state.

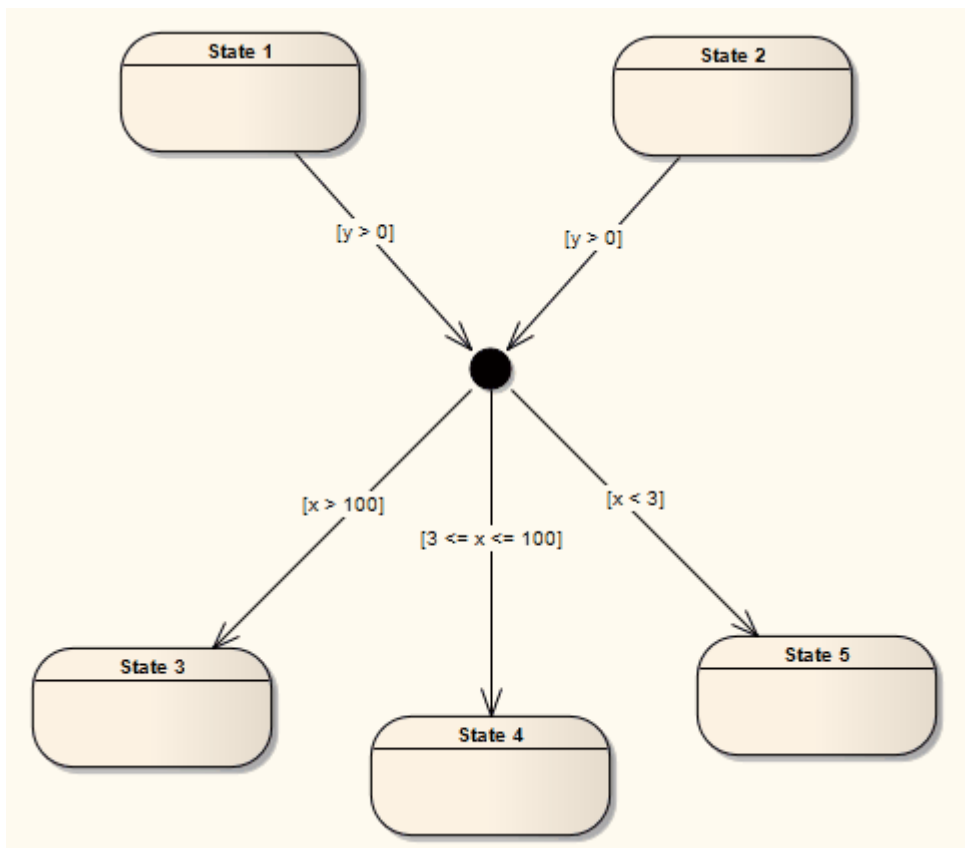

### Toolbox Icon

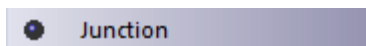

### OMG UML Specification

The OMG UML specification (*UML Superstructure Specification, v2.1.1, p. 538*) states:

*... junction vertices are semantic-free vertices that are used to chain together multiple transitions. They are used to construct compound transition paths between states. For example, a junction can be used to converge multiple incoming transitions into a single outgoing transition representing a shared transition path (this is known as a merge). Conversely, they can be used to split an incoming transition into multiple outgoing transition segments with different guard conditions. This realizes a static conditional branch. (In the latter case, outgoing transitions whose guard conditions evaluate to false are disabled. A predefined guard denoted "else" may be defined for at most one outgoing transition. This transition is enabled if all the guards labeling the other transitions are false.) Static conditional branches are distinct from dynamic conditional branches that are realized by choice vertices.*

#### 5.1.2.1.25 Lifeline

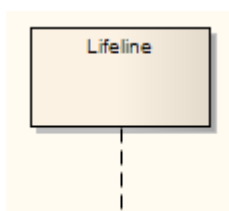

A *Lifeline* is an individual participant in an interaction (that is, Lifelines cannot have multiplicity). A Lifeline represents a distinct connectable element. To specify that representation within Enterprise Architect, right-click

on the Lifeline and select the **Advanced | Instance Classifier** context menu option. The [Select <Item>](#)<sup>[515]</sup> dialog displays which you use to locate the required project classifiers.

Lifelines are available in [Sequence](#)<sup>[706]</sup> diagrams. There are different Lifeline elements for [Timing diagrams](#)<sup>[690]</sup> ([State Lifeline](#)<sup>[794]</sup> and [Value Lifeline](#)<sup>[808]</sup>); however, although the representation differs between the two diagram types, the meaning of the Lifeline is the same.

## Toolbox Icon



## OMG UML Specification

The OMG UML specification (*UML Superstructure Specification, v2.1.1, p.489*) states:

*A lifeline represents an individual participant in the Interaction. While Parts and StructuralFeatures may have multiplicity greater than 1, Lifelines represent only one interacting entity.*

*Lifeline is a specialization of NamedElement.*

*If the referenced ConnectableElement is multivalued (i.e. has a multiplicity > 1), then the Lifeline may have an expression (the 'selector') that specifies which particular part is represented by this Lifeline. If the selector is omitted this means that an arbitrary representative of the multivalued ConnectableElement is chosen.*

### 5.1.2.1.26 Merge



A *Merge Node* brings together a number of alternative flow paths in [Activity](#)<sup>[674]</sup>, [Analysis](#)<sup>[733]</sup> and [Interaction Overview](#)<sup>[717]</sup> diagrams. For example, if a [Decision](#)<sup>[765]</sup> is used after a [Fork](#)<sup>[775]</sup>, the two flows coming out of the Decision must be merged into one before going to a [Join](#)<sup>[776]</sup>; otherwise, the Join waits for both flows, only one of which arrives.

A Merge Node has multiple incoming edges and a single outgoing edge. The edges coming into and out of a Merge Node must be either all [object flows](#)<sup>[886]</sup> or all [control flows](#)<sup>[860]</sup>.

## Toolbox Icon



## OMG UML Specification

The OMG UML specification (*UML Superstructure Specification, v2.1.1, p. 387*) states:

*A merge node is a control node that brings together multiple alternate flows. It is not used to synchronize concurrent flows but to accept one among several alternate flows.*

### 5.1.2.1.27 Message Endpoint

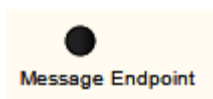

A *Message Endpoint* element defines the termination of a [State](#)<sup>[794]</sup> or [Value](#)<sup>[808]</sup> Lifeline in a [Timing diagram](#)<sup>[690]</sup>.

## Toolbox Icon

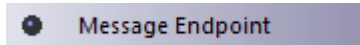

### 5.1.2.1.28 Message Label

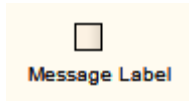

A *Message Label* is an alternative way of denoting [Messages](#)<sup>[882]</sup> between Lifelines, which is useful for 'uncluttering' [Timing diagrams](#)<sup>[690]</sup> strewn with messages. To indicate a Message between Lifelines, draw a connector from the source Lifeline into a Message Label. Next, draw a connector from another Message Label to the target Lifeline. Note that the label names must match to reflect that the message occurs between the two Message Labels.

The following diagram illustrates how Message Labels are used to construct a message between Lifelines.

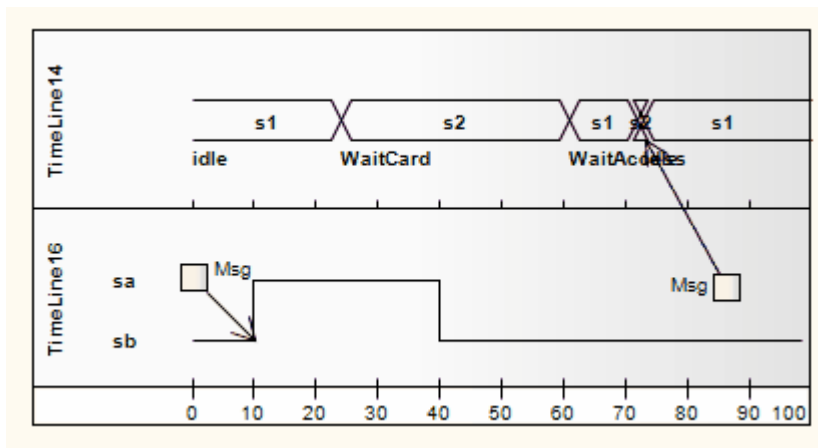

## Toolbox Icon

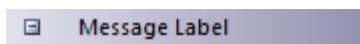

## OMG UML Specification

The OMG UML specification (*UML Superstructure Specification, v2.1.1, p. 518*) states:

*Labels are only notational shorthands used to prevent cluttering of the diagrams with a number of messages crisscrossing the diagram between Lifelines that are far apart. The labels denote that a Message may be disrupted by introducing labels with the same name.*

### 5.1.2.1.29 Note

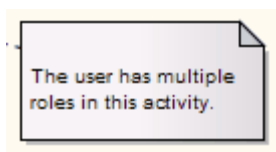

A *Note* element is a textual annotation that can be attached to a set of elements of any other type. The attachment is created separately, using a [Notelink](#)<sup>[886]</sup> connector. Both Note and Notelink are available in any Enterprise Architect diagram, through the [Common](#)<sup>[405]</sup> pages of the [Toolbox](#).

A Note is also called a *Comment*.

A *Constraint* is a form of Note, identifying a constraint on other elements. As for a Note, you can connect the Constraint element to other elements using a Notelink connector. This element is just a means of documenting the fact that there are constraints; it has no impact on the other elements. You define the types of constraint in the project [reference data](#)<sup>[655]</sup>, apply them to the element in the element [Properties](#)<sup>[488]</sup> dialog, and manage them through the [Scenarios & Requirements](#)<sup>[514]</sup> window.

### Toolbox Icon

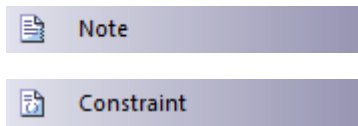

### OMG UML Specification

The OMG UML specification (*UML Superstructure Specification, v2.1.1, p. 59*) states:

*A comment gives the ability to attach various remarks to elements. A comment carries no semantic force, but may contain information that is useful to a modeler.*

*A comment can be owned by any element.*

#### 5.1.2.1.30 Partition

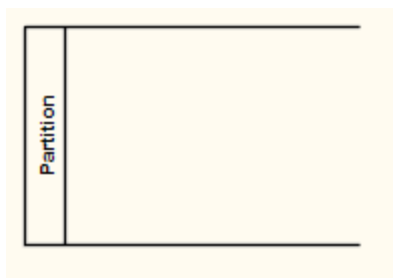

Enterprise Architect supports two types of *Activity Partition*:

- The [Activity Partition feature](#)<sup>[756]</sup>, which is used to logically organize an [Activity](#)<sup>[753]</sup> *element*
- The *Activity Partition element*, described in this topic, which is used to logically organize an [Activity](#)<sup>[674]</sup> *diagram*.

In effect, these are the same. They partition the Actions of the Activity without affecting the token flow, helping to structure the view or parts of the Activity.

The following example depicts the partitioning between the Classes *Process Payment* and *Order Processor*.

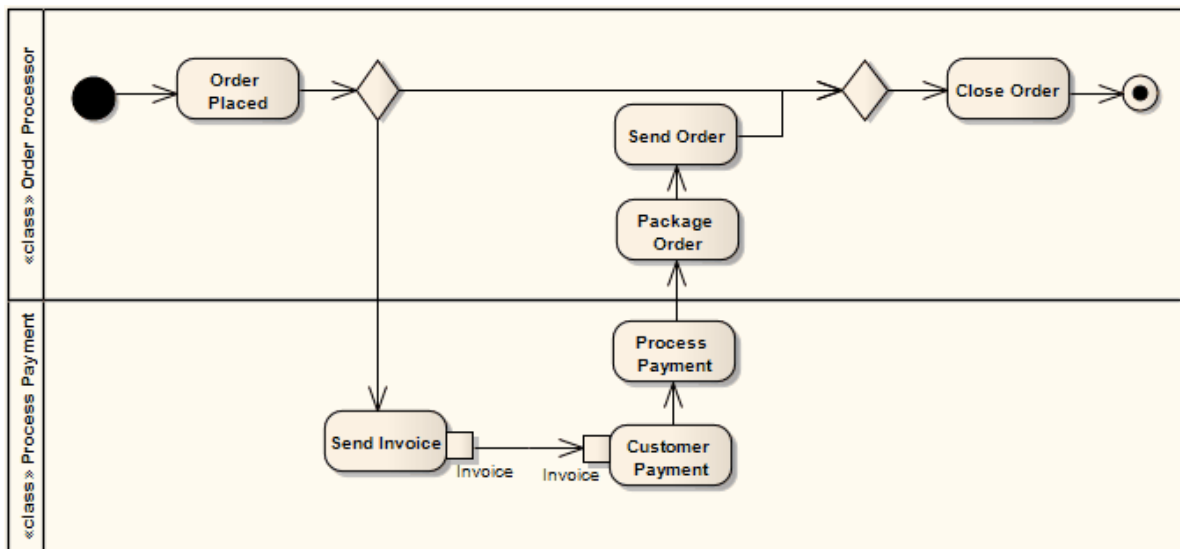

The Partition orientation defaults to horizontal. To turn it into a vertical Partition, right-click on it and select the **Advanced | Vertical Partition** context menu option.

You can neatly align and join the Activity Partitions on a diagram using the element context menu [Dockable](#) [555] option. For Partitions, the option defaults to selected.

### Toolbox Icon

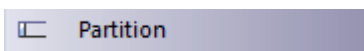

### OMG UML Specification

The OMG UML specification (*UML Superstructure Specification, v2.1.1, p. 341*) states:

*Partitions divide the nodes and edges to constrain and show a view of the contained nodes. Partitions can share contents. They often correspond to organizational units in a business model. They may be used to allocate characteristics or resources among the nodes of an activity.*

The OMG UML specification (*UML Superstructure Specification, v2.1.1, p. 341*) also states:

*An activity partition is a kind of activity group for identifying actions that have some characteristic in common.*

#### 5.1.2.1.31 Receive

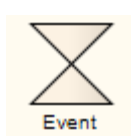

A *Receive* element is used to define the acceptance or receipt of a request, in an [Activity diagram](#) [674]. Movement from a *Receive* element occurs only once receipt is fulfilled according to its specification. The *Receive* element comes in two forms:

- *Accept Event Action* element (pennant shape)
- *Accept Time Event Action* element (hourglass shape)

The following example reflects a payment process on an order. Upon receiving the payment (from *Request Payments*, a [Send](#) [789] element), the payment is confirmed and the flow continues to ship the order.

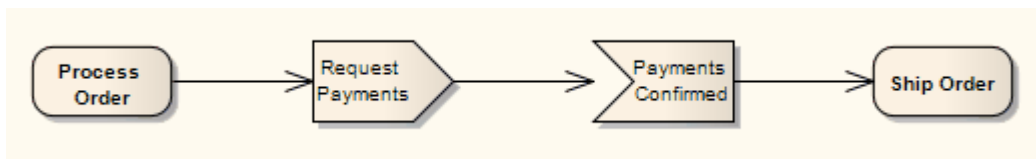

See *UML Superstructure Specification, v2.1.1, figure 12.26, p. 312.*

To depict an Accept Time Event, use the standard Receive element from the **Toolbox**. Right-click on this element, and select the **Advanced | Accept Time Event context** menu option. The following example shows the hourglass-shaped Accept Time Event Action:

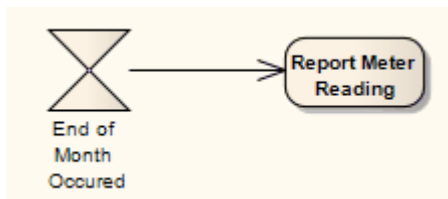

See *UML Superstructure Specification, v2.1.1, figure 12.27, p. 312.*

### Toolbox Icon



### OMG UML Specification

The OMG UML specification (*UML Superstructure Specification, v2.1.1, p. 239*) states:

*AcceptEventAction is an action that waits for the occurrence of an event meeting specified conditions.*

#### 5.1.2.1.32 Region

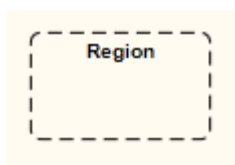

Enterprise Architect supports two types of *Region* element:

- [Expansion Region](#)<sup>[769]</sup>
- [Interruptible Activity Region](#)<sup>[781]</sup>

When you add a Region element to an [Activity diagram](#)<sup>[674]</sup>, the following prompt appears. You use this to specify the Region type.

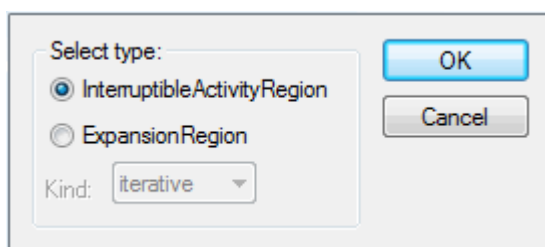



## Toolbox Icon



### 5.1.2.1.33 Send



The *Send* element is used to depict the action of sending a signal, in an [Activity diagram](#)<sup>[674]</sup>. It is the opposite of a [Receive](#)<sup>[787]</sup> element.

The following example shows an order being processed, where a signal is sent to fill the processed order and, upon creation of the resulting invoice, a notification is sent to the customer.

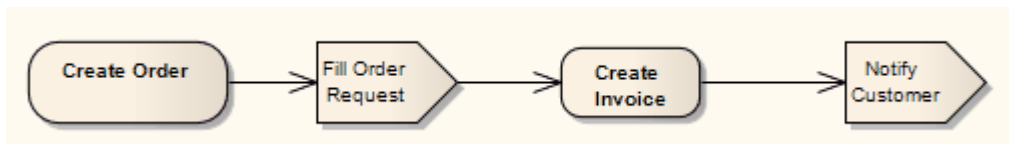

See *UML Superstructure Specification, v2.1.1, figure 12.132, p. 408.*

## Toolbox Icon



## OMG UML Specification

The OMG UML specification (*UML Superstructure Specification, v2.1.1, p. 285*) states:

*SendObjectAction is an action that transmits an object to the target object, where it may invoke behavior such as the firing of state machine transitions or the execution of an activity. The value of the object is available to the execution of invoked behaviors. The requestor continues execution immediately. Any reply message is ignored and is not transmitted to the requestor.*

### 5.1.2.1.34 State



A *State* represents a situation where some invariant condition holds; this condition can be static (waiting for an event) or dynamic (performing a set of activities). State modeling is usually related to [Classes](#)<sup>[817]</sup>, and describes the enableable states a Class or element can be in and the transitions that enable the element to move there. There are two types of State: *Simple States* and [Composite States](#)<sup>[790]</sup>, both created from the State element from the [Toolbox](#).

Furthermore, there are [pseudo-states](#)<sup>[682]</sup>, resembling some aspect of a State but with a pre-defined implication. Pseudo-states model complex transitional paths, and classify common [State Machine](#)<sup>[678]</sup> behavior.

You can define entry, internal and exit actions for a State using [operations](#)<sup>[570]</sup>.

If a State element has features such as attributes or operations, the depiction of the element in a diagram has

a line under the element name. This line persists if the features are hidden. The line also displays if the **Show State Compartment** checkbox is selected on the **Objects** page of the **Options** dialog (**Tools | Options | Objects**).

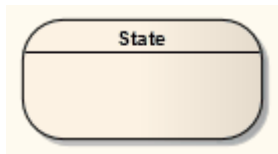

### Toolbox Icon



### OMG UML Specification

The OMG UML specification (*UML Superstructure Specification, v2.1.1, p. 546*) states:

*A state models a situation during which some (usually implicit) invariant condition holds. The invariant may represent a static situation such as an object waiting for some external event to occur. However, it can also model dynamic conditions such as the process of performing some activity (i.e., the model element under consideration enters the state when the activity commences and leaves it as soon as the activity is completed).*

#### 5.1.2.1.34.1 Composite State

*Composite States* are composed *within* the [State Machine diagram](#)<sup>[678]</sup> by expanding a [State](#)<sup>[789]</sup> element, adding [Regions](#)<sup>[687]</sup> if applicable, and dragging further State elements, related elements and connectors within its boundaries. The internal State elements are then referred to as *Sub-states*.

(You can also define a State element, as with many other types of element, as a [composite element](#)<sup>[837]</sup>; this then has a hyperlink to a child diagram that can be another State Machine diagram or other type of diagram elsewhere in the model.)

Composite States can be orthogonal, if Regions are created. If a Composite State is orthogonal, its entry denotes that a single Sub-state is concurrently active in all Regions. The hierarchical nesting of Composite States, coupled with Region use, generates a situation of multiple States concurrently active; this situation is referred to as the *active State configuration*.

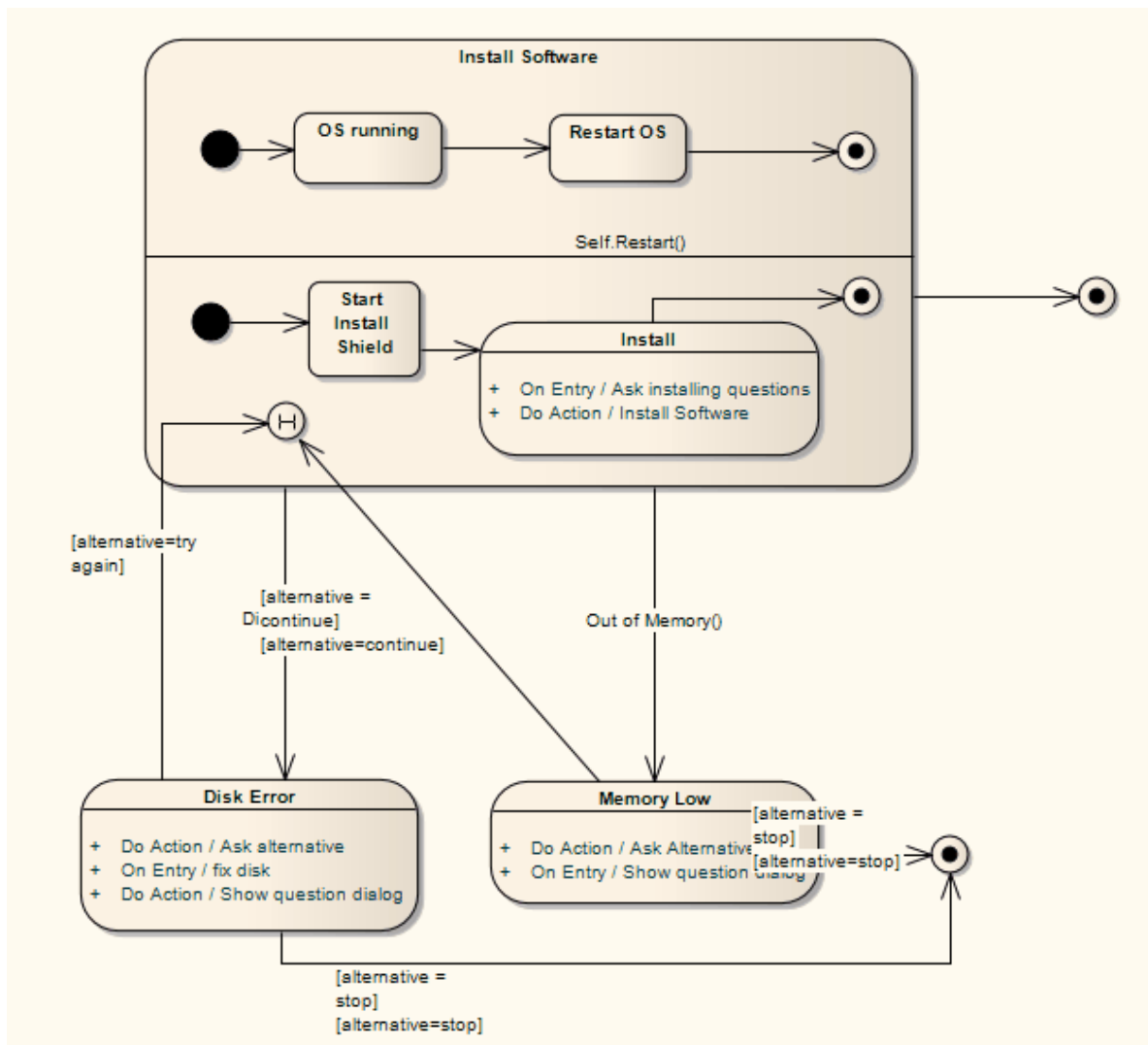

## OMG UML Specification

The OMG UML specification (*UML Superstructure Specification, v2.1.1, p. 478*) states:

*A composite state either contains one region or is decomposed into two or more orthogonal regions. Each region has a set of mutually exclusive disjoint subvertices and a set of transitions. A given state may only be decomposed in one of these two ways.*

*Any state enclosed within a region of a composite state is called a substate of that composite state. It is called a direct substate when it is not contained by any other state; otherwise it is referred to as an indirect substate.*

*Each region of a composite state may have an initial pseudostate and a final state. A transition to the enclosing state represents a transition to the initial pseudostate in each region. A newly-created object takes its topmost default transitions, originating from the topmost initial pseudostates of each region.*

*A transition to a final state represents the completion of activity in the enclosing region. Completion of activity in all orthogonal regions represents completion of activity by the enclosing state and triggers a completion event on the enclosing state. Completion of the topmost regions of an object corresponds to its termination.*

### 5.1.2.1.35 State/Continuation

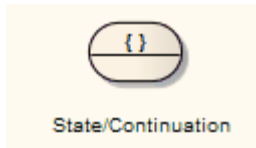

The *State/Continuation* element serves two different purposes for Interaction ([Sequence](#)<sup>[706]</sup>) diagrams, as [State Invariants](#)<sup>[793]</sup> and [Continuations](#)<sup>[792]</sup>. Enterprise Architect prompts you to identify the purpose when you create the element.

#### Toolbox Icon

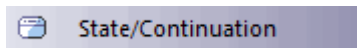

#### 5.1.2.1.35.1 Continuation

A *Continuation* is used in *seq* and *alt* [Combined Fragments](#)<sup>[759]</sup>, to indicate the branches of continuation an operand follows. To indicate a continuation, end an operand with a Continuation, and indicate the continuation branch with a matching Continuation (same name) preceding the *Interaction Fragment*.

You create a Continuation by dragging the [State/Continuation](#)<sup>[792]</sup> element onto the diagram from the [Interaction Elements](#) page of the [Toolbox](#).

For the following continuation example, an *alt* Combined Fragment has Continuations *pathSucc* and *pathFail*. These Continuations are located within the [Interaction Occurrence](#)<sup>[780]</sup> *ConnHandler*, which has subsequent events based on the continuation.

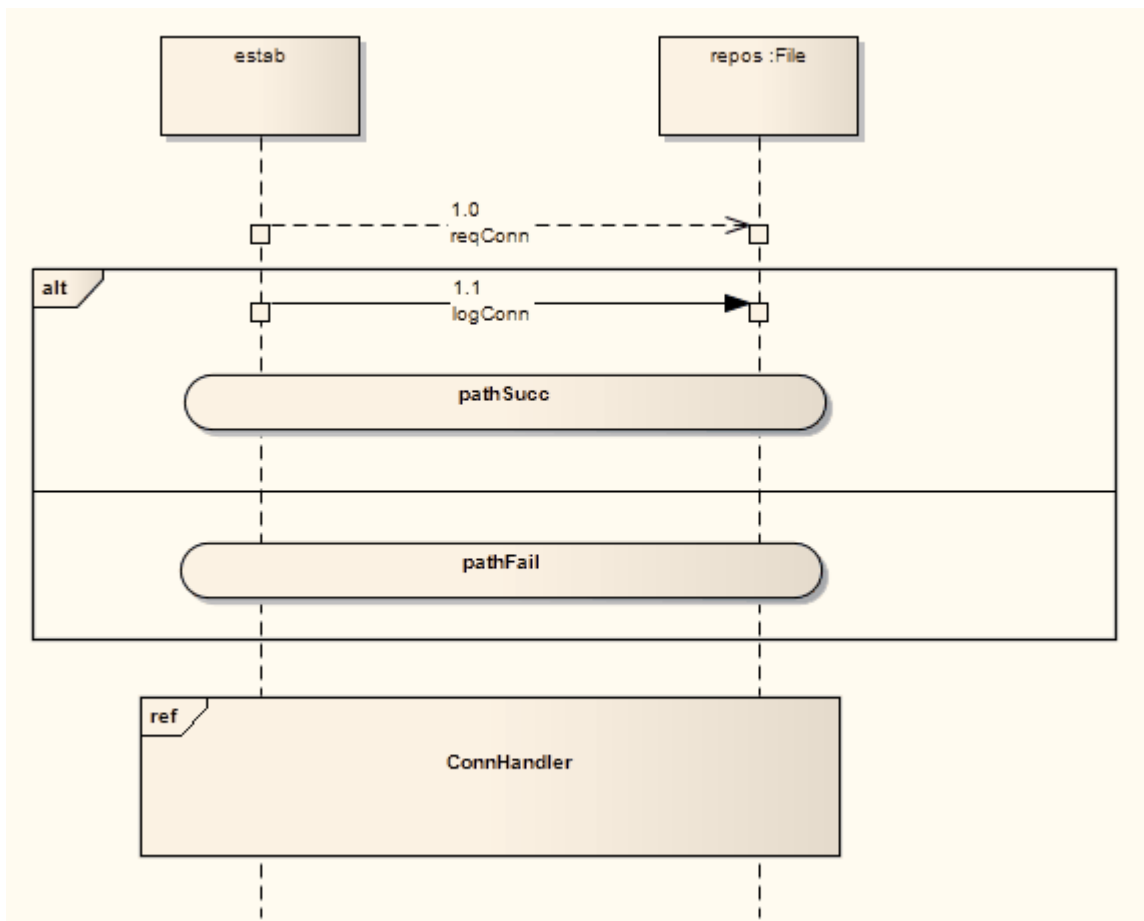

The following diagram shows the interaction referenced by the *Interaction Occurrence*.

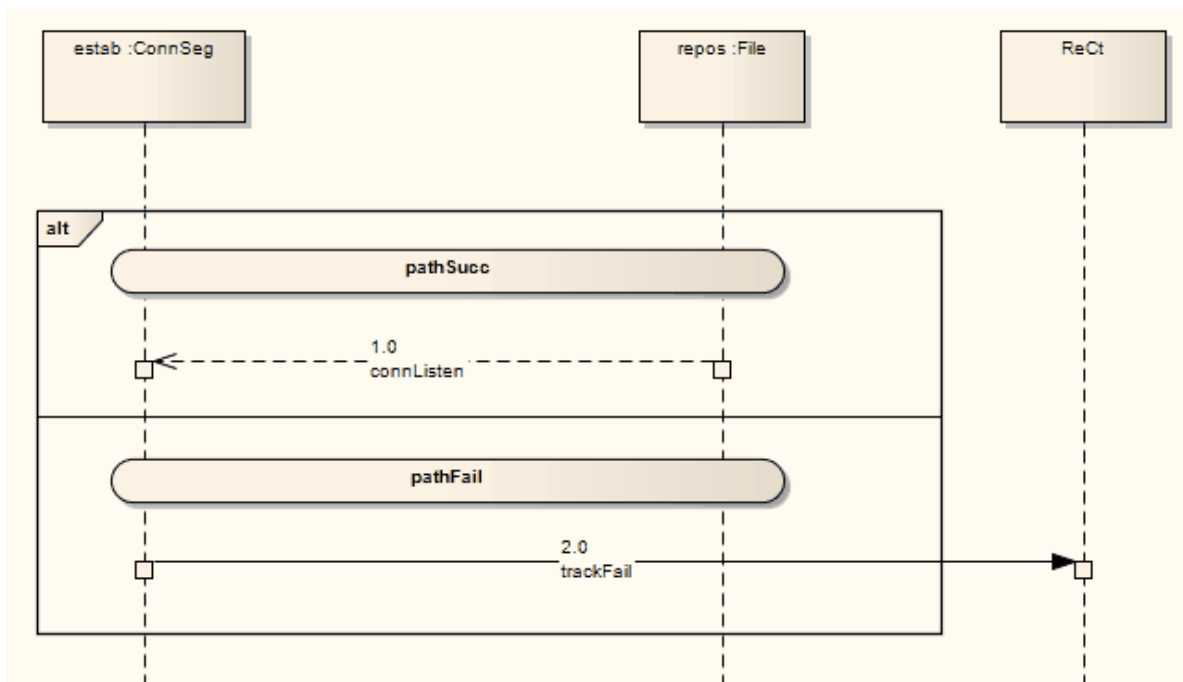

### OMG UML Specification

The OMG UML specification (*UML Superstructure Specification, v2.1.1, p. 474*) states:

*A Continuation is a syntactic way to define continuations of different branches of an Alternative CombinedFragment. Continuation is intuitively similar to labels representing intermediate points in a flow of control.*

The OMG UML specification (*UML Superstructure Specification, v2.1.1, p. 474*) also states:

*Continuations have semantics only in connection with Alternative CombinedFragments and (weak) sequencing.*

*If an InteractionOperand of an Alternative CombinedFragment ends in a Continuation with name (say) X, only InteractionFragments starting with the Continuation X (or no continuation at all) can be appended.*

#### 5.1.2.1.35.2 State Invariant

A *State Invariant* is a condition applied to a [Lifeline](#)<sup>[783]</sup>, which must be fulfilled for the Lifeline to exist. You create a State Invariant by dragging the [State/Continuation](#)<sup>[792]</sup> element onto the diagram from the **Interaction Elements** page of the **Toolbox**.

The following diagram illustrates a State Invariant.

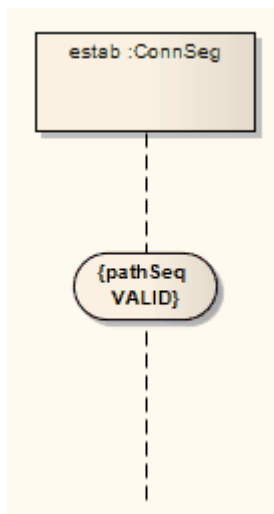

When a State Invariant is moved near to a Lifeline, it snaps to the center. If the sequence object is dragged left or right, the State Invariant moves with it.

### OMG UML Specification

The OMG UML specification (*UML Superstructure Specification, v2.1.1, p. 502*) states:

*A StateInvariant is a runtime constraint on the participants of the interaction. It may be used to specify a variety of different kinds of constraints, such as values of attributes or variables, internal or external states, and so on.*

*A StateInvariant is an InteractionFragment and it is placed on a Lifeline.*

#### 5.1.2.1.36 State Lifeline

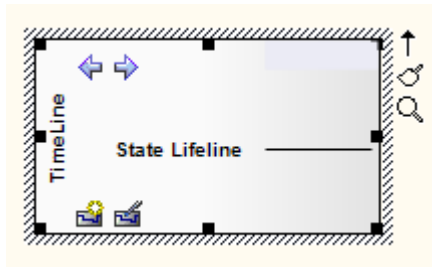

A *Lifeline* is the path an object takes across a measure of time, as indicated by the x-axis. There are two sorts: *State Lifelines* (defined here) and *Value Lifelines* <sup>[808]</sup>, both used in *Timing diagrams* <sup>[690]</sup>.

A *State Lifeline* follows discrete transitions between states, which are defined along the y-axis of the timeline. Any transition has optional attributes of timing constraints, duration constraints and observations. An example of a State Lifeline is shown below:

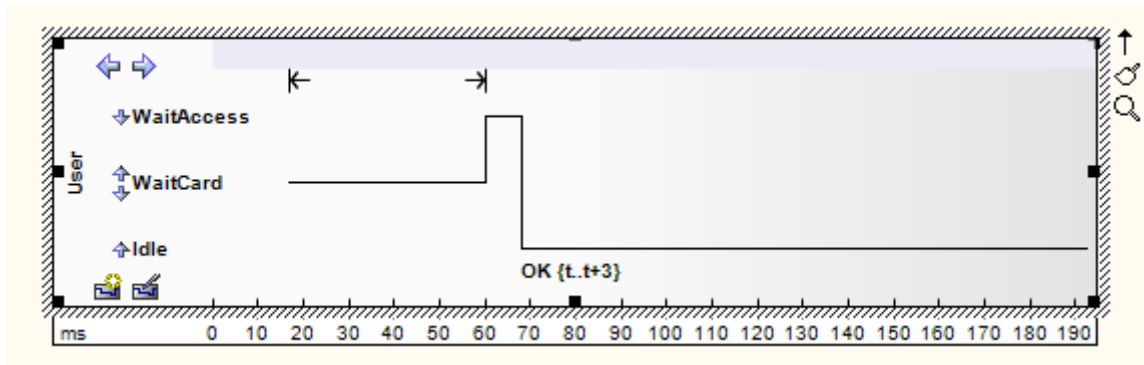

See *UML Superstructure Specification, v2.1.1, figure 14.29, p. 519.*

A State Lifeline consists of a set of transition points. Each transition point can be defined with the following properties:

Property	Description
<b>At time</b>	Specifies the starting time for a change of state.
<b>Transition to</b>	Indicates the state to which the lifeline changes.
<b>Event</b>	Describes the occurring event.
<b>Timing constraints</b>	Refers to the time taken for a state to change within a lifeline, or the time taken to transmit a message (e.g. t..t+3).
<b>Timing observations</b>	Provides information on the time of a state change or sent message.
<b>Duration constraints</b>	Pertains to a lifeline's period at a particular state. The constraint could be instigated by a change of state within a lifeline, or that lifeline's receipt of a message.
<b>Duration observations</b>	Indicates the interval of a lifeline at a particular state, begun from a change in state or message receipt.

In the example diagram above, the **OK** transition point has these properties:

Property	Value
<b>At Time</b>	18 ms
<b>Transition to</b>	Idle
<b>Event</b>	OK
<b>Timing constraints</b>	t..t+3
<b>Timing observations</b>	–
<b>Duration constraints</b>	–
<b>Duration observations</b>	–

## Toolbox Icon

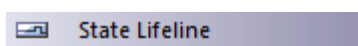

## OMG UML Specification

The OMG UML specification (*UML Superstructure Specification, v2.1.1, p. 518*) states:

*This is the state of the classifier or attribute, or some testable condition, such as an discrete enumerable value.*

*It is also permissible to let the state-dimension be continuous as well as discrete. This is illustrative for scenarios where certain entities undergo continuous state changes, such as temperature or density.*

### 5.1.2.1.37 State Machine

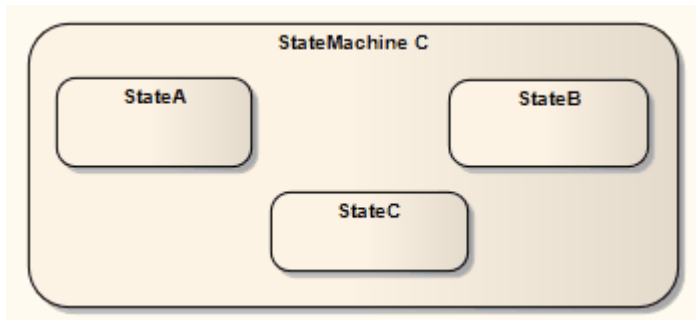

A State Machine element is a container for groups of related State elements. You can create sections of a State Machine diagram, showing the organization of the inter-related State elements, and enclose each section in a State Machine element. You can also create [Regions](#) <sup>[687]</sup> on a State Machine element.

## Toolbox Icon

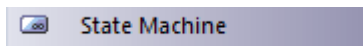

### 5.1.2.1.38 Structured Activity

*Structured Activity* elements are used in [Activity diagrams](#) <sup>[674]</sup>. A Structured Activity is an activity node that can have subordinate nodes as an independent *Activity Group*. No other Activities or their side effects should interfere with this Activity's processing.

Enterprise Architect provides two forms of Structured Activity - basic and specialized. It also applies the mechanism for creating Structured Activities to creating composite [Activity](#) <sup>[753]</sup> elements quickly and simply.

The two basic Structured Activities are:

- [Structured Activity Node](#) <sup>[798]</sup> - represents an ordered arrangement of executable Activity nodes (Actions, Decisions, Merges and so on) that can include branched and nested nodes; this is the base element from which the other types of Structured Activity are derived
- [Sequential Node](#) <sup>[798]</sup> - represents a sequential arrangement of executable Activity nodes.

The two specialized Structured Activities are used to effectively model discreet patterns within an activity graph, defined in Clauses or Partitions:

- [Conditional node](#) <sup>[798]</sup> - represents an arrangement of Actions and Activities where choice determines which Activities are performed
- [Loop node](#) <sup>[798]</sup> - represents a sequence of Actions and Activities that are - or can be - repeated on the same object.



**Note:**

All four Structured Activity Nodes are created as [composite elements](#)<sup>[837]</sup>. However, for the Loop Node and Conditional Node elements you must create the child element structure on the parent diagram within the node element itself, as for a [Composite State](#)<sup>[790]</sup>. You cannot develop the partitioned structure of the nodes on a child diagram.

For this reason, the **Show Composite Diagram** facility is not available for the Loop Node and Conditional Node. It is also not available on the Structured Activity Node, as this is the base element for the Loop and Conditional Nodes. You can, however, use the two basic nodes as composite elements, and display the child diagram structure on the parent Sequential node.

When you create a Structured Activity, by selecting the icon from the **Activity** page of the **Toolbox**, the following context menu displays:

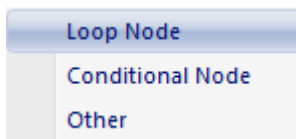

The first two options specifically create a Loop or Conditional Node. The **Other** option displays the **New Structured Activity** dialog, on which you can select to create any of the four nodes, or a simple Composite Activity element.

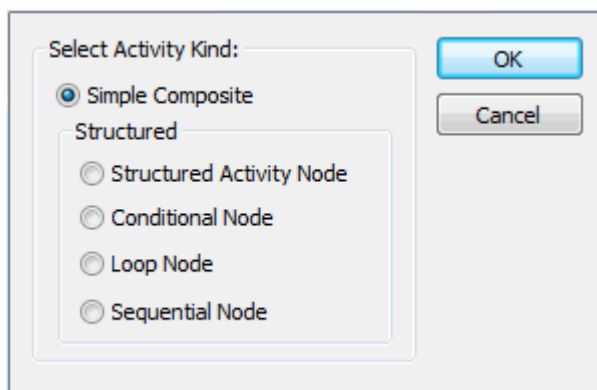

## Toolbox Icon

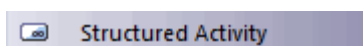

## OMG UML Specification

### Structured Activity Node

The OMG UML specification (*UML Superstructure Specification, v2.1.1, p. 409*) states:

*A structured activity node is an executable activity node that may have an expansion into subordinate nodes as an ActivityGroup. The subordinate nodes must belong to only one structured activity node, although they may be nested.*

*A structured activity node represents a structured portion of the activity that is not shared with any other structured node, except for nesting.*

### Sequential Node

The OMG UML specification (*UML Superstructure Specification, v2.1.1, p. 408*) states:

*A sequence node is a structured activity node that executes its actions in order.*

### Loop Node

The OMG UML specification (*UML Superstructure Specification, v2.1.1, pp. 384-385*) states:

*A loop node is a structured activity node that represents a loop with setup, test, and body sections.*

*Each section is a well-nested subregion of the activity whose nodes follow any predecessors of the loop and precede any successors of the loop. The test section may precede or follow the body section. The setup section is executed once on entry to the loop, and the test and body sections are executed repeatedly until the test produces a false value. The results of the final execution of the test or body are available after completion of execution of the loop.*

### Conditional Node

The OMG UML specification (*UML Superstructure Specification, v2.1.1, p.355*) states:

*A conditional node is a structured activity node that represents an exclusive choice among some number of alternatives.*

*A conditional node consists of one or more clauses. Each clause consists of a test section and a body section. When the conditional node begins execution, the test sections of the clauses are executed. If one or more test sections yield a true value, one of the corresponding body sections will be executed. If more than one test section yields a true value, only one body section will be executed. The choice is nondeterministic unless the test sequence of clauses is specified. If no test section yields a true value, then no body section is executed; this may be a semantic error if output values are expected from the conditional node.*

#### 5.1.2.1.38.1 Structured and Sequential Nodes

On a diagram, *Structured* and *Sequential* Activity Nodes have broken borders and composite diagram icons, as shown below:

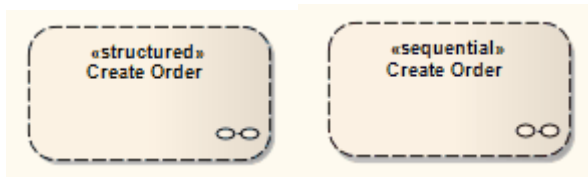

To display the Activity diagram represented by a Structured or Sequential Activity Node element, double-click on the element.

Structured Activity Node elements can point to child diagrams that themselves contain or consist of Structured Activity elements; that is, the Structured Activity elements are nested, as shown in the section of [Project Browser](#) below.

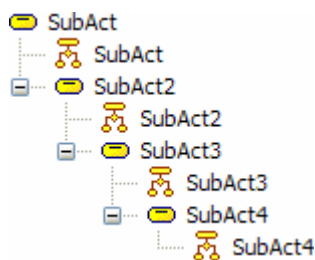

#### 5.1.2.1.38.2 Loop and Conditional Nodes

A *Loop* Structured Activity Node by default has *Setup*, *Test* and *Body* partitions. The Setup partition is executed once on entry to the Loop, and the Test and Body partitions are executed repeatedly until the Test produces a false value. The results of the final execution of the Test or Body are available after execution of the Loop is complete.

A *Conditional* Structured Activity Node has a default *Clause* containing *Test* and *Body* partitions. Further Clauses can be added if required.

The two elements are depicted on an Activity diagram as shown below:

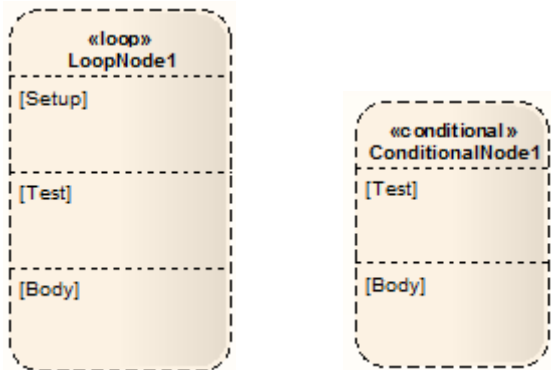

You define the Loop or Condition nodes by dragging other Activity diagram elements from the [Toolbox](#) page into the appropriate partition of the element, and linking and organizing the structure as required. The elements are aligned on the top left of the partition, so that resizing the node maintains the organization of the structure within and between the partitions. If you try to shrink the node below the structure size, the node automatically defaults to the 'best fit' size.

### Conditional Node

When you [create](#)<sup>[796]</sup> a Conditional Node, the element [Properties](#) dialog displays. Much of this you can [complete](#)<sup>[481]</sup> as for any other element. However, for the Conditional Node the dialog also has a [Condition](#) tab, as shown below:

General Condition Requirements Constraints Links Scenarios Files T

Must Isolate  Is Assured  Is Determinate

Result

::Activity Example::ConditionalNode3.OutputPin8 Add Del

Clause(s)

Clause Name	Predecessor	Successor
Clause1		Clause2
Clause2	Clause1	Clause3
Clause3	Clause2	

Add Delete Save

Decider Development Model::Activity Example::ConditionalNode3.OutputPin9 ...

Body Output

::Activity Example::ConditionalNode3.OutputPin10 Add Del

Nodes

Test  Body

::Activity Example::ConditionalNode3.Action2

OK Cancel Apply Help

Add an [Action Pin](#)<sup>[749]</sup> as the **Result** for the node, clicking on the **Add** button to display the **Select Pins** dialog (a version of the [Select <Item>](#)<sup>[515]</sup> dialog).

On creation, the Conditional Node automatically has one *Clause* containing a **Decider** and **Body Output**, and a **Test** partition and a **Body** partition. You can add further *Clauses* as required. For each *Clause* you also add an **Action Pin** for the **Decider** and for the **Body Output**. Click on the **Save** button to save the *Clause* definition.

The **Select Pin** dialog reveals only **Output pins** as appropriate to the context. If the required **Action Pin** does not already exist, you can click on the **Add New** button on the dialog to automatically create an **Output pin** under the appropriate parent node.

For the **Result** and **Body Output** entries, you can check on the exact location of each **Action Pin** by right-clicking on the entry and selecting the **Find in Project Browser** context menu option.

The **Nodes** panel, by default, lists the **Actions** and **Activities** contained in the **Test** partition. Click on the **Body** radio button to list the elements contained in the **Body** partition. An element must be completely contained in the **Body** partition to be listed there - if it overlaps with the **Test** partition in any way, it is treated as being part of the **Test** partition.

### Add or Remove Clauses

To add another *Clause*, click on the **Add** button underneath the **Clause(s)** list. This inserts a new *Clause* in the list, and identifies which is the preceding, or **Predecessor**, *Clause* and (if appropriate) which is the following, or **Successor**, *Clause*. The remaining fields in the **Clause(s)** panel are cleared to enable you to add **Decider** and

**Body Output** Action Pins. New Test and Body partitions are immediately added to the element on the diagram, and you can populate these partitions with Activity elements, which are then identified in the **Nodes** panel.

To remove a Clause, highlight it in the list and click on the **Delete** button. This immediately removes the Clause's corresponding partitions from the diagram, along with all their contained Activity elements. Removing a Clause from between two other Clauses adjusts the numerical order; for example, if Clause 2 is removed from between Clause 1 and Clause 3, Clause 3 is renamed as Clause 2, and any further Clauses are also moved up one place.

## Loop Node

When you [create](#)<sup>[796]</sup> a Loop Node, the element **Properties** dialog displays. Much of this you can [complete](#)<sup>[487]</sup> as for any other element. However, for the Loop Node the dialog also has a **Loop** tab, as shown below:

The screenshot shows the 'Properties' dialog for a Loop Node, with the 'Loop' tab selected. The dialog is divided into several sections:

- Options:** 'Must Isolate' is unchecked, and 'Tested First' is checked.
- Decider:** A text field containing 'Development Model::Activity Example::LoopNode2.OutputPin4' with a dropdown arrow.
- Loop Variable Input:** A text field containing '::Activity Example::LoopNode2.InputPin1' with 'Add' and 'Del' buttons.
- Loop Variable:** A text field containing '::Activity Example::LoopNode2.OutputPin5' with 'Add' and 'Del' buttons.
- Body Output:** A text field containing '::Activity Example::LoopNode2.OutputPin6' with 'Add' and 'Del' buttons.
- Result:** A text field containing '::Activity Example::LoopNode2.OutputPin7' with 'Add' and 'Del' buttons.
- Nodes:** Radio buttons for 'Setup' (selected), 'Body', and 'Test'. Below is a list of nodes:
  - ::Activity Example::LoopNode2.Action24
  - ::Activity Example::LoopNode2.Action23

At the bottom of the dialog are buttons for 'OK', 'Cancel', 'Apply', and 'Help'.

Add an [Action Pin](#)<sup>[749]</sup> for each of the **Decider**, **Loop Variable Input**, **Loop Variable**, **Body Output** and **Result** fields for the node, in each case clicking on the **Browse** or **Add** button to display the **Select Pins** dialog (a version of the [Select <Item>](#)<sup>[515]</sup> dialog). The **Select ActionPin** dialog reveals only Input pins (**Loop Variable Input**) or Output pins as appropriate to the context. If the required Action Pin does not already exist, you can click on the **Add New** button on the dialog to automatically create the Input pin or an Output pin under the appropriate parent node.

You can also check on the exact location of an existing Action Pin by right-clicking on the pin name and

selecting the **Find in Project Browser** context menu option.

The **Nodes** panel, by default, lists the Actions and Activities contained in the **Setup** partition. Click on the **Body** or **Test** radio buttons to list the elements contained in the corresponding partitions. An element must be completely contained in a partition to be listed there - if it overlaps with the partition above in any way, it is treated as being part of that partition.

### 5.1.2.1.39 Synch



A *Synch* state is useful for indicating that concurrent paths of a [State Machine](#)<sup>[678]</sup> are synchronized. After bringing the paths to a synch state, the emerging transition indicates unison.

#### Toolbox Icon



### 5.1.2.1.40 System Boundary

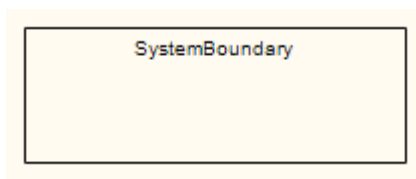

A *System Boundary* element is a non-UML element used to define *conceptual* boundaries. You can use System Boundaries to help group logically related elements (from a visual perspective, not as part of the UML model).

In the *UML Superstructure Specification, v2.1.1*, System Boundaries are described in the sections on [Use Cases](#)<sup>[806]</sup>, because the System Boundary is often used to indicate the *application* of a Use Case to another entity. In this context, the System Boundary:

- encloses the Use Case, and
- is [associated with a classifier](#)<sup>[515]</sup> such as a [Class](#)<sup>[817]</sup>, [Component](#)<sup>[816]</sup> or Sub-system ([Actor](#)<sup>[757]</sup>) through the **Select <Item>** dialog.

By associating the System Boundary - and not the Use Case - with the classifier, the classifier is linked to the Use Case as a *user*, but not as an *owner*.

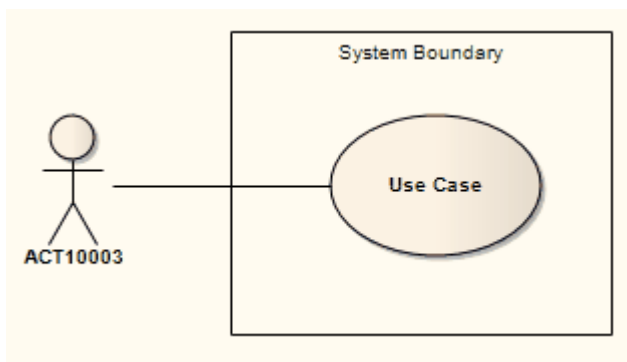

You can also define a Use Case as the classifier of a System Boundary element, to link the elements enclosed in the System Boundary (such as parts of an Activity diagram) to their representation in a logical Use Case. See [http://www.sparxsystems.com.au/resources/map\\_uc.html](http://www.sparxsystems.com.au/resources/map_uc.html).

The following properties of a System Boundary can be set: the name, [the border style](#)<sup>[803]</sup>, and the number of horizontal or vertical swim lanes.

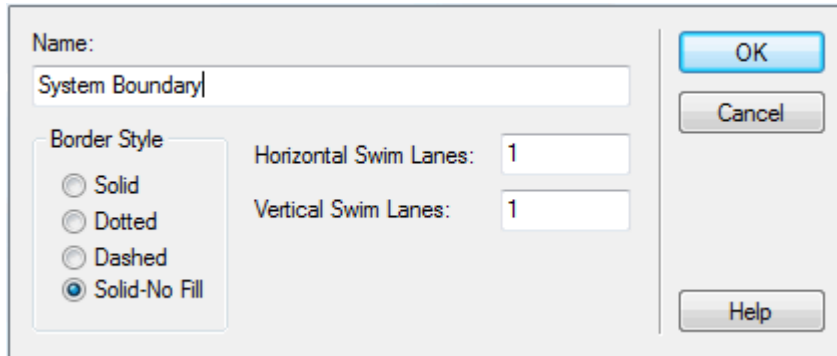

A System Boundary element can be marked as *Selectable*, using the element's context menu. When not selectable, you can click within the System Boundary space without activating or selecting the Boundary itself. This is useful when you have many elements within the Boundary and the Boundary makes their selection difficult.

**Note:**

A System Boundary can have an associated image that it displays instead of its default format. Use the [Appearance | Alternate Image](#)<sup>[448]</sup> menu option to select an image.

## Toolbox Icon

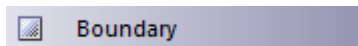

## OMG UML Specification

The OMG UML specification (*UML Superstructure Specification, v2.1.1, p. 594*) states:

*If a subject (or system boundary) is displayed, the Use Case ellipse is visually located inside the system boundary rectangle. Note that this does not necessarily mean that the subject classifier owns the contained Use Cases, but merely that the Use Case applies to that classifier.*

### 5.1.2.1.40.1 Boundary Element Settings

## Configure Boundary Elements

Boundary elements can be configured to display in different ways. The main differences are:

- Solid border
- Dotted border
- With horizontal or vertical 'swim lanes'; swim lanes are used to group elements in a vertical or horizontal context (for example, Client, Application and Database tiers could be represented in swim lanes).

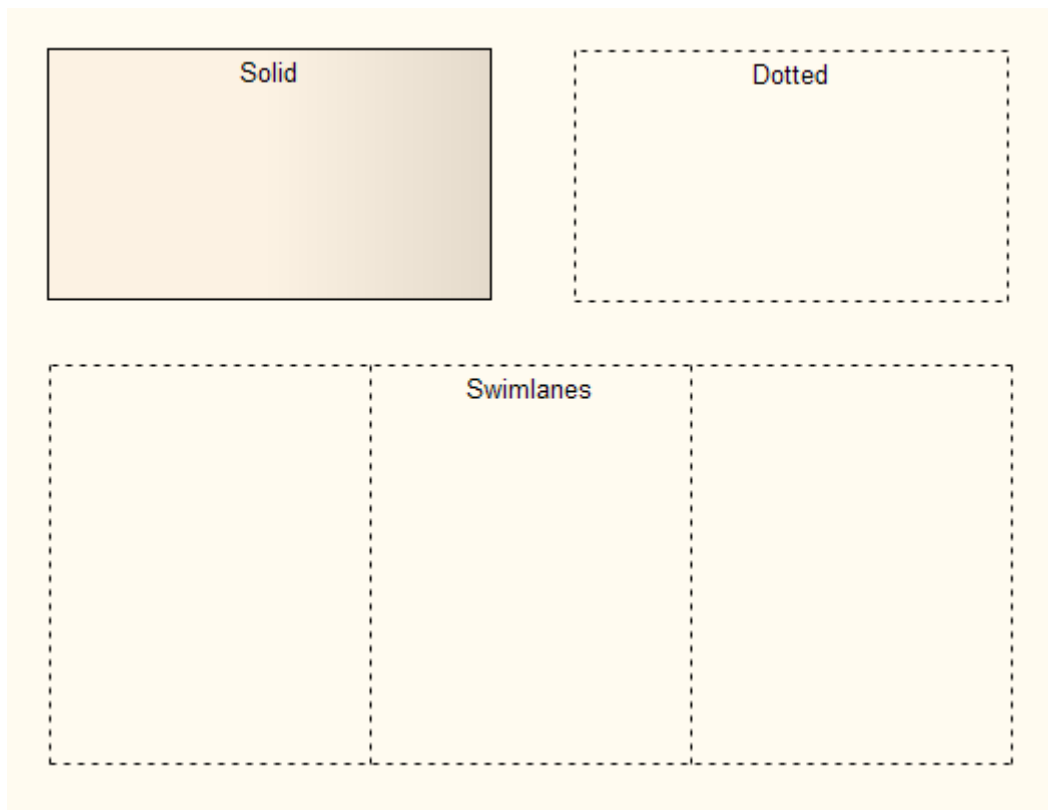

#### 5.1.2.1.41 Terminate



The *Terminate pseudo-state*<sup>[682]</sup> indicates that upon entry of its pseudo-state, the *State Machine's*<sup>[678]</sup> execution ends.

#### Toolbox Icon

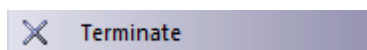

#### 5.1.2.1.42 Trigger



A *Trigger* indicates an event that initiates an action (and might arise from completion of a previous action). You initially define a Trigger in one of four ways:

- As a property of a *Transition*<sup>[892]</sup> relationship
- As a property of an Accept Event *Action*<sup>[743]</sup> (on the *Triggers* tab of the element *Properties* dialog)
- As an event in a *State Machine Table*<sup>[688]</sup>
- Directly, as a Trigger element, through the *New Element*<sup>[524]</sup> dialog.



When you save the Trigger, it is added to the list of elements for the parent package in the [Project Browser](#). You can then right-click on it and select the **Properties** context menu option to view and, if required, edit its properties as *an element* rather than as a property itself. Triggers created as events remain as Event elements, whilst Triggers created in other ways are Trigger elements, with a [Trigger](#) tab in the [Properties](#) dialog.

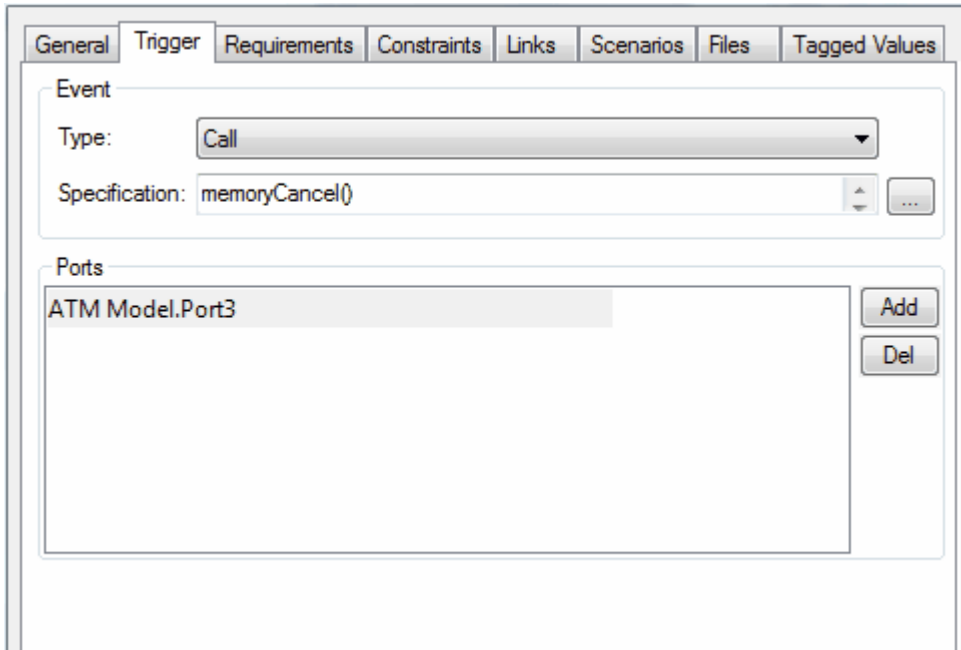

Option	Use to
<b>Type</b>	If necessary, edit the type of trigger: <ul style="list-style-type: none"> <li>• <b>Call</b> - specifies that the event is a CallEvent, which sends a message to the associated object by invoking an operation.</li> <li>• <b>Change</b> - specifies that the event is a ChangeEvent, which indicates that the transition is the result of a change in value of an attribute.</li> <li>• <b>Signal</b> - specifies that the event is a SignalEvent, which corresponds to the receipt of an asynchronous signal instance.</li> <li>• <b>Time</b> - corresponds to a TimeEvent; which specifies a moment in time.</li> </ul>
<b>Specification</b>	Either type in the event instigating the Trigger, or click on the [ ... ] button and select the event (depending on the <b>Type</b> value).
<b>Ports</b>	Click on the <b>Add</b> button and select the appropriate Port from the <a href="#">Select Port</a> <sup>515</sup> dialog.  <b>Notes:</b> <ul style="list-style-type: none"> <li>• To create <i>new</i> Ports using the <a href="#">Select Port</a> dialog, the Trigger should be created as a child of a Class or Component element.</li> <li>• To add several Ports at once, press <b>[Ctrl]</b> as you select each Port.</li> <li>• To check the exact location of a Port, right-click on the Port name and select the <b>Find in Project Browser</b> context menu option.</li> </ul>

You can also drag the Trigger element onto another diagram, although there are limited uses for the element in that context.

This element is not the same as a [Trigger Operation](#) <sup>1033</sup>, which is an operation automatically executed as a result of the modification of data in a database.

## OMG UML Specification

The OMG UML specification (*UML Superstructure Specification, v2.1.1, p. 456*) states:

*Events may cause execution of behavior (e.g., the execution of the effect activity of a transition in a state machine). A trigger specifies the event that may trigger a behavior execution as well as any constraints on the event to filter out events not of interest.*

### 5.1.2.1.43 Use Case



A *Use Case* is a UML modeling element that describes how a user of the proposed system interacts with the system to perform a discrete unit of work. It describes and signifies a single interaction over time that has meaning for the end user (person, machine or other system), and is required to leave the system in a complete state: the interaction either completed or rolled back to the initial state. A Use Case:

- Typically has requirements and constraints that describe the essential features and rules under which it operates
- Can have an associated [Sequence diagram](#) <sup>[706]</sup> illustrating behavior over time; who does what to whom, and when
- Typically has scenarios associated with it that describe the work flow over time that produces the end result; alternative work flows (for example, to capture exceptions) are also enabled.

#### Note:

Use a Use Case diagram and model to build up the functional requirements and implementation details of the system.

The following is an example Use Case model:

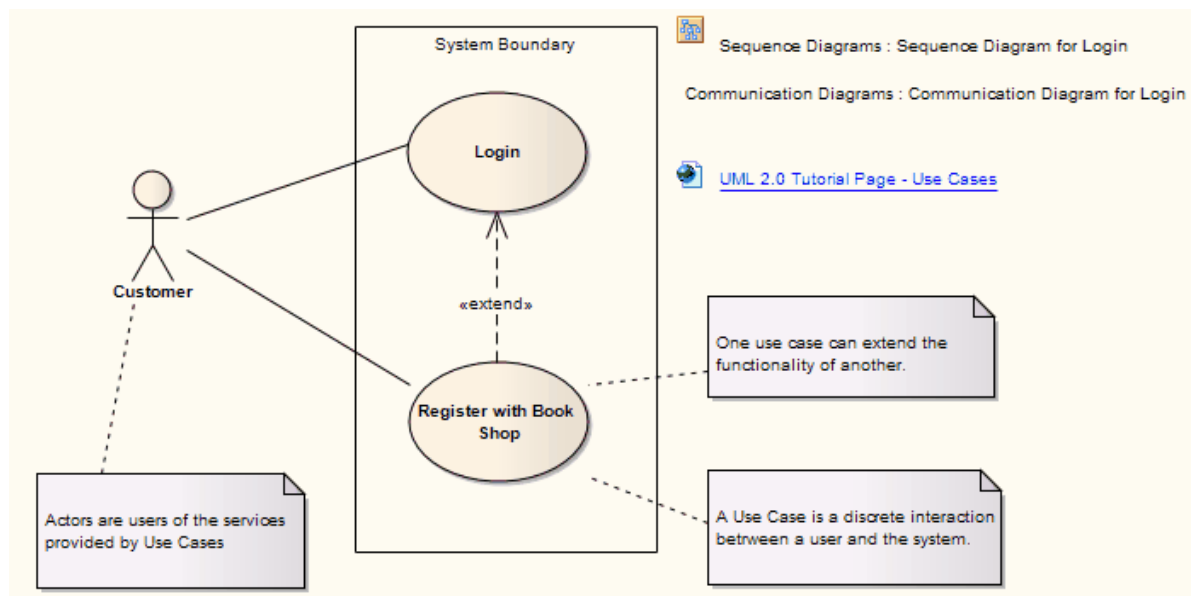

If extending a Use Case, you can specify the points of extension with [Use Case Extension Points](#) <sup>[807]</sup>. To display the attributes, operations or constraints of a Use Case on a diagram, use [Rectangle Notation](#) <sup>[808]</sup>.

Enterprise Architect also provides two stereotyped Use Cases - the [Test Case](#) <sup>[848]</sup> and the [Business Use Case](#) <sup>[739]</sup>.

## Toolbox Icon

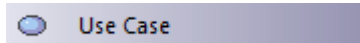

## OMG UML Specification

The OMG UML specification (*UML Superstructure Specification*, v2.1.1, p. 592) states:

*A UseCase is a kind of behavioed classifier that represents a declaration of an offered behavior. Each Use Case specifies some behavior, possibly including variants, that the subject can perform in collaboration with one or more actors.*

### 5.1.2.1.43.1 Use Case Extension Points

Use *extension points* to specify the point of an extended [Use Case](#) <sup>[806]</sup> where an extending Use Case's behavior should be inserted. The specification text can be informal or precise to define the location of the extension point.

#### Note:

Conditions to apply the extending Use Case, and the extension point to use, should be attached as a note to the *extend* relationship.

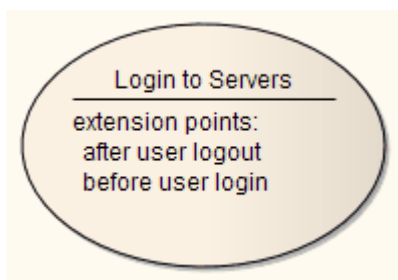

To work with extension points, follow the steps below:

1. Right-click on the Use Case element. The context menu displays.
2. Select the **Advanced | Edit Extension Points...** menu option. The **Use Case Extension Points** dialog displays, listing defined points for that Use Case.

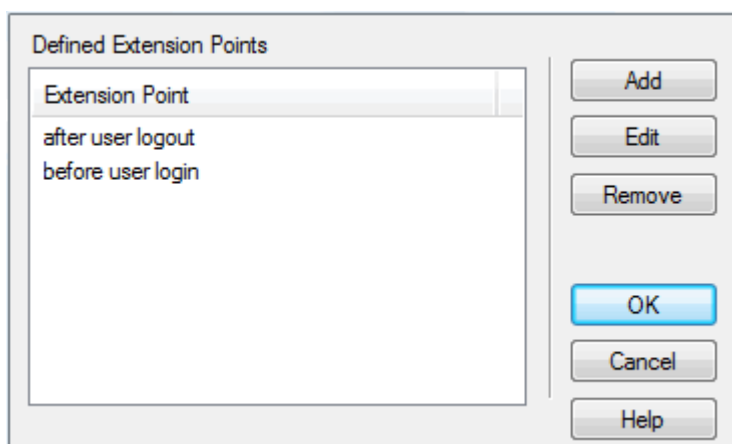

3. Select an extension point in the list and click on the appropriate button to edit or remove the extension point, or to add a new one.

### 5.1.2.1.43.2 Rectangle Notation

You can display a [Use Case](#) <sup>[806]</sup> using *rectangle notation*. This displays the Use Case in a rectangle, with an oval in the top right-hand corner. Any attributes, operations or constraints belonging to the Use Case are shown, in the same style as a [Class](#) <sup>[811]</sup>.

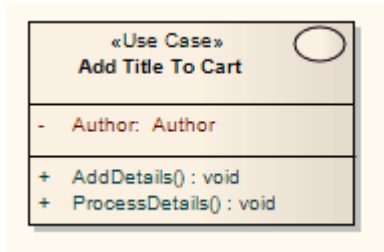

To show a Use Case using rectangle notation, right-click on the Use Case object on the diagram and select the **Advanced | Use Rectangle Notation** context menu option. This setting only applies to the selected Use Case, and can be toggled on and off.

#### Note:

[Actor](#) <sup>[757]</sup> elements can also be displayed using rectangle notation.

### 5.1.2.1.44 Value Lifeline

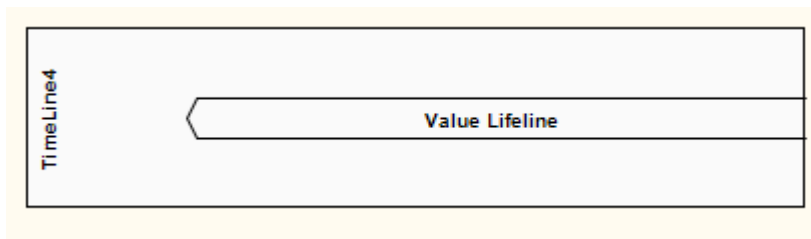

A *Lifeline* is the path an object takes across a measure of time, indicated by the x-axis. There are two sorts: *Value Lifelines* (defined here) and [State Lifelines](#) <sup>[794]</sup>, both used in [Timing diagrams](#) <sup>[690]</sup>.

A *Value Lifeline* shows the Lifeline's state across the diagram, with parallel lines indicating a steady state. A cross between the lines indicates a transition or change in state.

An example of a Value Lifeline is shown below:

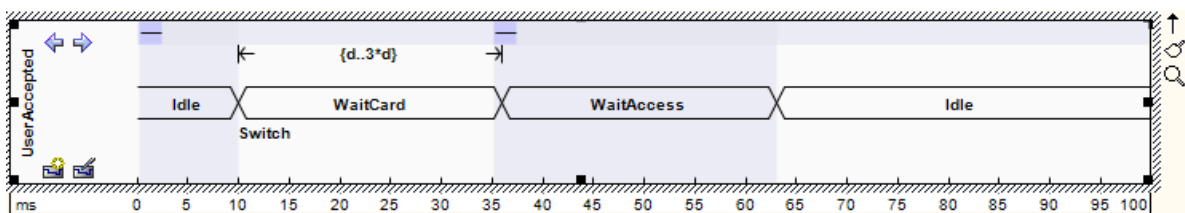

See *UML Superstructure Specification, v2.1.1, Figure 14.30, p. 520*.

A Value Lifeline consists of a set of transition points. Each transition point can be defined with the following properties:

Property	Description
At time	Specifies the starting time for a change of state.
Transition to	Indicates the state to which the Lifeline will change.

Property	Description
Event	Describes the occurring event.
Timing constraints	Refers to the time taken for a state to change within a Lifeline, or the time taken to transmit a message.
Timing observations	Provides information on the time of a state change or sent message.
Duration constraints	Pertains to a Lifeline's period at a particular state. The constraint could be instigated by a change of state within a Lifeline, or that Lifeline's receipt of a message.
Duration observations	Indicates the interval of a Lifeline at a particular state, begun from a change in state or message receipt.

In the example diagram above, the **10ms** transition point has these properties:

Property	Text
At Time	10ms
Transition to	Waitcard
Event	Switch
Timing constraints	–
Timing observations	–
Duration constraints	d..3*d
Duration observations	–

## Toolbox Icon

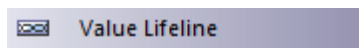

## OMG UML Specification

The OMG UML specification (*UML Superstructure Specification, v2.1.1, p. 518*) states:

*Shows the value of the connectable element as a function of time. Value is explicitly denoted as text. Crossing reflects the event where the value changed.*

### 5.1.2.2 Structural Diagram Elements

The following figure illustrates the main [UML elements](#)<sup>[74]</sup> that are used in [Structural Diagrams](#)<sup>[719]</sup>. For more information on using each element, click on the element name in this list:

- [Actor](#)<sup>[757]</sup>, [Artifact](#)<sup>[810]</sup>
- [Class](#)<sup>[811]</sup>, [Collaboration](#)<sup>[814]</sup>, [Collaboration Occurrence](#)<sup>[815]</sup>, [Component](#)<sup>[816]</sup>
- [Data Type](#)<sup>[817]</sup>, [Deployment Specification](#)<sup>[818]</sup>, [Document Artifact](#)<sup>[819]</sup>
- [Enumeration](#)<sup>[819]</sup>, [Execution Environment](#)<sup>[820]</sup>, [Expose Interface](#)<sup>[820]</sup>
- [Information Item](#)<sup>[821]</sup>, [Interface](#)<sup>[821]</sup>
- [Node](#)<sup>[822]</sup>, [Note](#)<sup>[785]</sup>
- [Object](#)<sup>[823]</sup>
- [Package](#)<sup>[825]</sup>, [Part](#)<sup>[825]</sup>, [Port](#)<sup>[826]</sup>, [Primitive](#)<sup>[829]</sup>
- [Qualifiers](#)<sup>[830]</sup>
- [Signal](#)<sup>[834]</sup>

**Note:**

Actor, Collaboration, Note, Object and Package elements are used in both Behavioral diagrams and Structural diagrams.

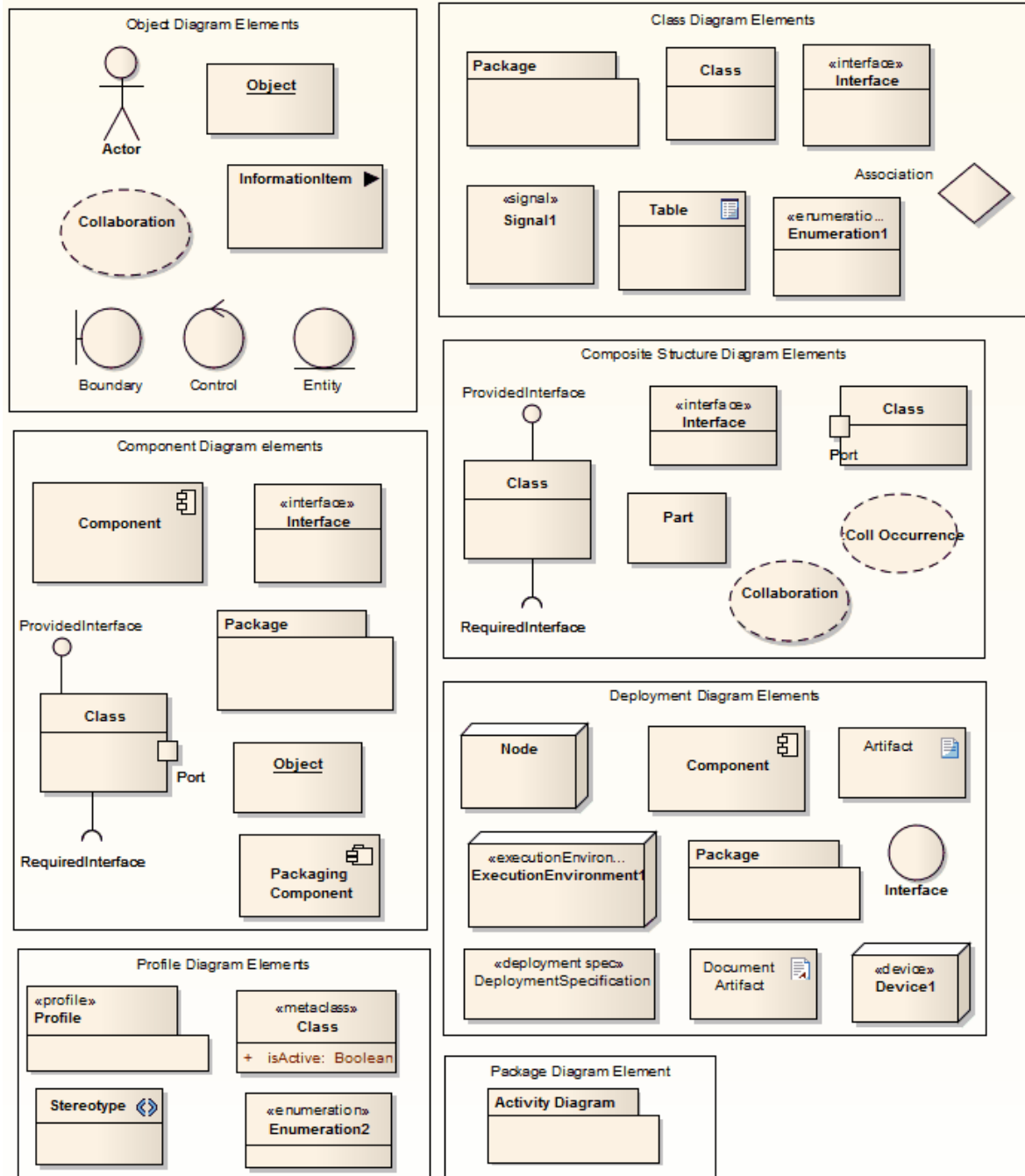
**5.1.2.2.1 Artifact**

An *Artifact* is any physical piece of information used or produced by a system, represented in a [Deployment Diagram](#) <sup>[727]</sup>.

Artifacts can have associated properties or operations, and can be instantiated or associated with other Artifacts. Examples of Artifacts include model files, source files, database tables, development deliverables or support documents. The files represented by the Artifact are listed on the **Files** tab of the element **Properties** dialog.

To open the files represented by the Artifact, click on the element on the diagram and press **[Ctrl]+[E]**. Each file is opened either on a separate tab in the **Diagram View** workspace (if the file can be opened within Enterprise Architect) or in the default Windows viewer/editor for the file type (if the file cannot be opened within Enterprise Architect).

Files can also be launched individually from the **Files** tab (opening in the Windows default editor), as for elements of any other type that have [associated files](#) <sup>[507]</sup>.

## Toolbox Icon



## Create Artifact For External File

You can also create an Artifact element on a diagram for an external file, by clicking on the file in a file list (such as Windows Explorer) or on your Desktop and dragging it onto the diagram. A short context menu displays with two options - **Hyperlink** and **Artifact**.

Click on the **Artifact** option to create the element on the diagram. The **Properties** dialog displays, and you can define the name or other properties as required. Click on the **OK** button, and then open the **Properties** dialog again and click on the **Files** tab. The file pathname is listed in the **Files** panel.

## OMG UML Specification

The OMG UML specification (*UML Superstructure Specification, v2.1.1, p. 201*) states:

*An Artifact defined by the user represents a concrete element in the physical world. A particular instance (or 'copy') of an artifact is deployed to a node instance. Artifacts may have composition associations to other artifacts that are nested within it. For instance, a deployment descriptor artifact for a component may be contained within the artifact that implements that component. In that way, the component and its descriptor are deployed to a node instance as one artifact instance.*

### 5.1.2.2 Class

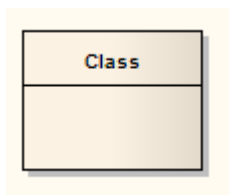

A *Class* is a representation of objects that reflects their structure and behavior within the system. It is a template from which actual running instances are created, although a Class can be defined either to [control its own execution](#) <sup>[812]</sup> or as a *template* or [parameterized Class](#) <sup>[813]</sup> that specifies parameters that must be defined by any binding Class.

A Class can have [attributes](#) <sup>[558]</sup> (data) and *methods* ([operations](#) <sup>[569]</sup> or behavior). Classes can inherit characteristics from parent Classes and delegate behavior to other Classes. Class models usually describe the logical structure of the system and are the building blocks from which components are built.

The top section of a Class, as illustrated below, shows the attributes (or data elements) associated with the Class. These hold the 'state' of an object at run-time. If the information is saved to a data store and can be reloaded, it is termed 'persistent'. The lower section contains the Class operations (or methods at run-time). Operations describe the behavior a Class offers to other Classes, and the internal behavior it has (private methods).

Class elements are generally used in [Class diagrams](#) <sup>[727]</sup> and [Composite Structure diagrams](#) <sup>[724]</sup>.

Enterprise Architect also supports a number of stereotyped Class elements to represent various entities in [web-page modeling](#)<sup>[854]</sup>. A Class can also be integrated with an [Associate](#)<sup>[855]</sup> connector to form an [Association Class](#)<sup>[856]</sup>, to allow the Associate connector to have operations and attributes that define certain types of UML relationship.

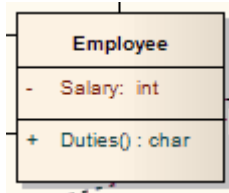

### Toolbox Icon



### OMG UML Specification

The OMG UML specification (*UML Superstructure Specification, v2.1.1, pp. 52-53*) states:

*The purpose of a class is to specify a classification of objects and to specify the features that characterize the structure and behavior of those objects.*

*Objects of a class must contain values for each attribute that is a member of that class, in accordance with the characteristics of the attribute, for example its type and multiplicity.*

*When an object is instantiated in a class, for every attribute of the class that has a specified default, if an initial value of the attribute is not specified explicitly for the instantiation, then the default value specification is evaluated to set the initial value of the attribute for the object.*

*Operations of a class can be invoked on an object, given a particular set of substitutions for the parameters of the operation. An operation invocation may cause changes to the values of the attributes of that object. It may also return a value as a result, where a result type for the operation has been defined. Operation invocations may also cause changes in value to the attributes of other objects that can be navigated to, directly or indirectly, from the object on which the operation is invoked, to its output parameters, to objects navigable from its parameters, or to other objects in the scope of the operation's execution. Operation invocations may also cause the creation and deletion of objects.*

#### 5.1.2.2.1 Active Classes

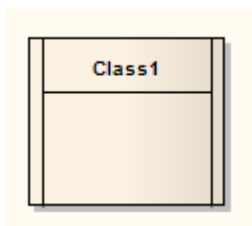

An *Active Class* indicates that, when instantiated, the Class controls its own execution. Rather than being invoked or activated by other objects, it can operate standalone and define its own thread of behavior.

To define an Active Class in Enterprise Architect, follow the steps below:

1. Highlight a Class, and display its **Properties** dialog.
2. Click on the **Advanced** button.
3. Select the **Is Active** checkbox.
4. Click on the **OK** button to save the details.

### OMG UML Specification

The OMG UML specification (*UML Superstructure Specification, v2.1.1, p. 438*) states:



An active object is an object that, as a direct consequence of its creation, commences to execute its classifier behavior, and does not cease until either the complete behavior is executed or the object is terminated by some external object. (This is sometimes referred to as "the object having its own thread of control.") The points at which an active object responds to communications from other objects is determined solely by the behavior of the active object and not by the invoking object. If the classifier behavior of an active object completes, the object is terminated.

#### 5.1.2.2.2 Parameterized Classes (Templates)

Enterprise Architect supports *template* or *parameterized* Classes, which specify parameters that must be defined by any binding Class. A template Class enables its functionality to be reused by any bound Class. If a default value is specified for a parameter, and a binding Class doesn't provide a value for that parameter, the default is used. Parameterized Classes are commonly implemented in C++.

Enterprise Architect imports and generates templated Classes for C++. Template Classes are shown with the parameters in a dashed outline box in the upper right corner of a Class.

To create a parameterized Class, follow the steps below:

1. Display the **Properties** dialog for a Class.
2. Select the **Details** tab.

The screenshot shows the 'Details' tab of the Properties dialog. The 'Cardinality' is set to '0..\*' and 'Visibility' is set to 'Private'. There are buttons for 'Attributes...', 'Operations...', 'Concurrency' (with radio buttons for Sequential, Guarded, Active, Synchronous), and 'Collection Classes...'. The 'Templates' section has a 'Type' dropdown set to 'Parameterised' and buttons for 'Add', 'Edit', and 'Delete'. Below this is a table with columns 'Parameter', 'Type', and 'Default'. The table contains one row: 'bind type' with 'Class' in the 'Type' column. At the bottom, there is an 'Arguments' text box and 'OK', 'Cancel', 'Apply', and 'Help' buttons.

Parameter	Type	Default
bind type	Class	

3. In the **Type** field, click on the drop-down arrow and select **Parameterized**.

For an instantiated template, select **Instantiated** and add the arguments in the **Arguments** field.

4. Click on the **Add** button and define the required parameters in the **Class Parameter** dialog.

### Notation Example

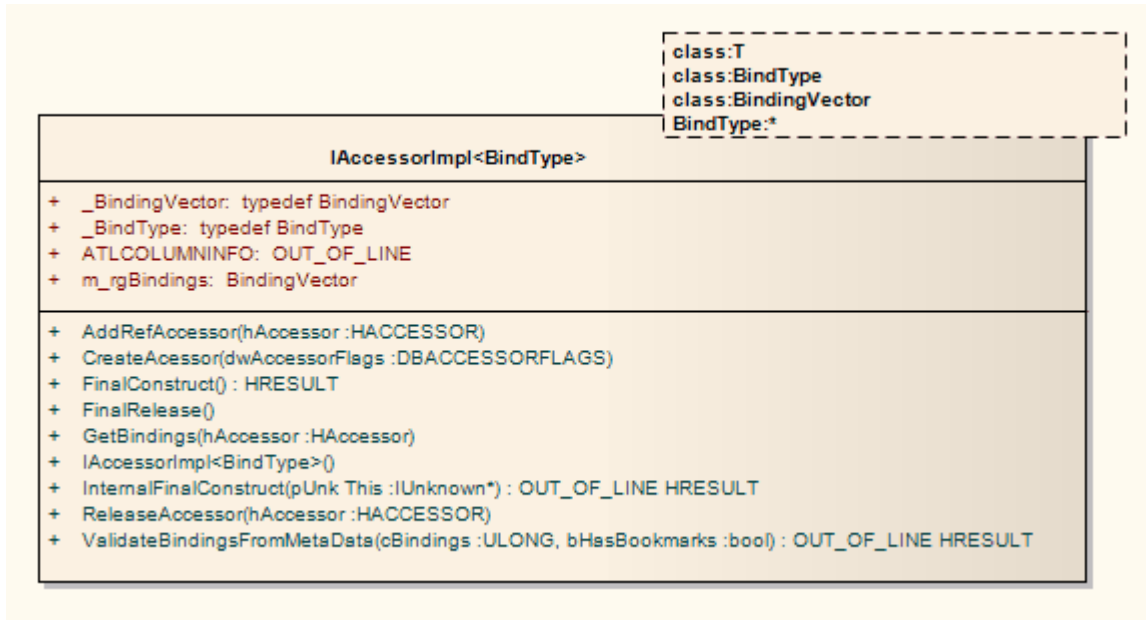

### OMG UML Specification

The OMG UML specification (*UML Superstructure Specification, v2.1.1, p. 622*) states:

*A template is a parameterized element that can be used to generate other model elements using TemplateBinding relationships. The template parameters for the template signature specify the formal parameters that will be substituted by actual parameters (or the default) in a binding.*

#### 5.1.2.2.3 Collaboration



A *Collaboration* defines a set of cooperating roles and their connectors. These are used to collectively illustrate a specific functionality, in a [Composite Structure diagram](#) <sup>[724]</sup>. A Collaboration should specify only the roles and attributes required to accomplish a specific task or function. Although in practice a behavior and its roles could involve many tangential attributes and properties, isolating the primary roles and their requisites simplifies and clarifies the behavior, as well as providing for reuse. A Collaboration often implements a pattern to apply to various situations.

The following example illustrates an *Install* Collaboration, with three roles ([Objects](#) <sup>[823]</sup>) connected as shown. The process for this Collaboration can be demonstrated by attaching an Interaction diagram ([Sequence](#) <sup>[706]</sup>, [Timing](#) <sup>[690]</sup>, [Communication](#) <sup>[713]</sup> or [Interaction Overview](#) <sup>[717]</sup>).

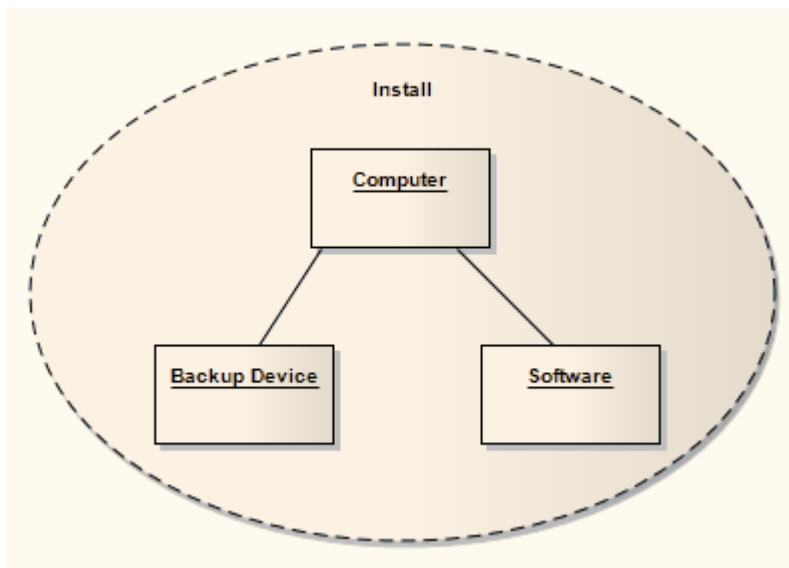

To understand referencing a Collaboration in a specific situation, see the [Collaboration Occurrence](#)<sup>[815]</sup> topic.

Enterprise Architect supports a stereotyped Collaboration to represent a [Business Use Case Realization](#)<sup>[739]</sup> in business modeling.

### Toolbox Icon

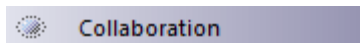

### OMG UML Specification

The OMG UML specification (*UML Superstructure Specification*, v2.1.1, p. 171) states:

*A collaboration describes a structure of collaborating elements (roles), each performing a specialized function, which collectively accomplish some desired functionality. Its primary purpose is to explain how a system works and, therefore, it typically only incorporates those aspects of reality that are deemed relevant to the explanation.*

#### 5.1.2.2.4 Collaboration Occurrence

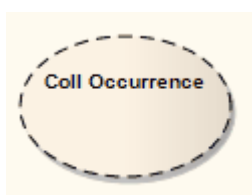

Use a *Collaboration Occurrence* to apply a pattern defined by a Collaboration to a specific situation, in a [Composite Structure diagram](#)<sup>[724]</sup>.

The following example uses an occurrence, *NWServer*, of the Collaboration *Install*, to define the installation process of a network scanner. This process can be defined by an interaction attached to the Collaboration. (See the [Collaboration](#)<sup>[814]</sup> topic for a representation of the *Install* Collaboration.)

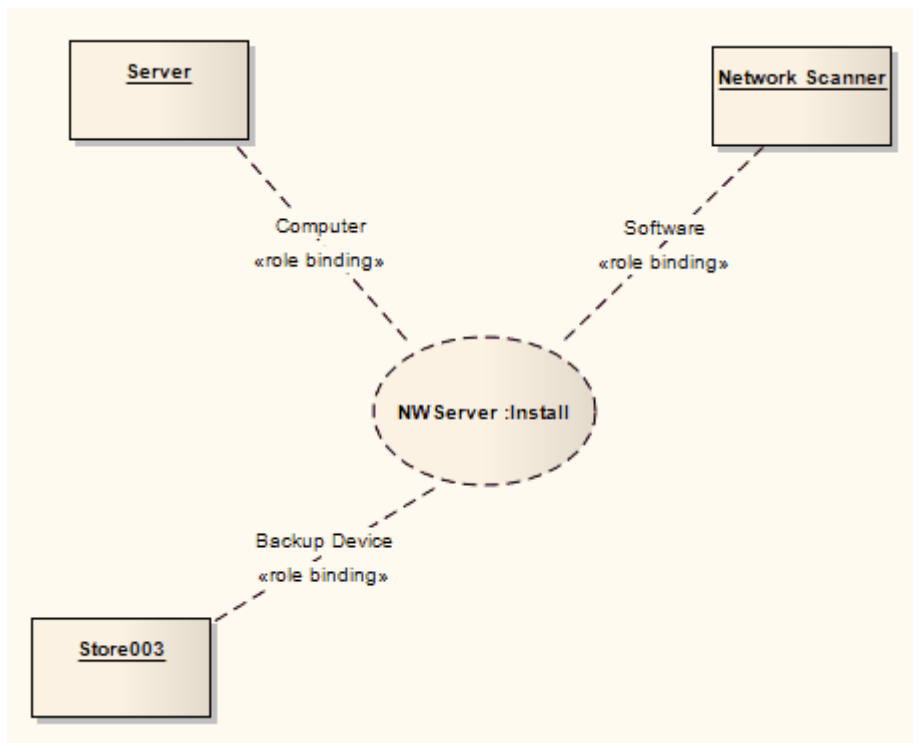

To create a Collaboration Occurrence, drag the required Collaboration from the **Project Browser** onto the diagram and, on the **Paste Element** dialog, select the **Paste as Link** radio button.

### OMG UML Specification

The OMG UML specification (*UML Superstructure Specification, v2.1.1, p. 173*) refers to a Collaboration Occurrence as a **Collaboration Use**, and states:

*A collaboration use represents one particular use of a collaboration to explain the relationships between the properties of a classifier. A collaboration use shows how the pattern described by a collaboration is applied in a given context, by binding specific entities from that context to the roles of the collaboration. Depending on the context, these entities could be structural features of a classifier, instance specifications, or even roles in some containing collaboration. There may be multiple occurrences of a given collaboration within a classifier, each involving a different set of roles and connectors. A given role or connector may be involved in multiple occurrences of the same or different collaborations.*

#### 5.1.2.2.5 Component



A *Component* is a modular part of a system, whose behavior is defined by its provided and required interfaces; the internal workings of the Component should be invisible and its usage environment-independent. Source code files, DLLs, Java beans and other artifacts defining the system can be manifested in Components.

A Component can be composed of multiple [Classes](#) <sup>[81†]</sup>, or Components pieced together. As smaller Components come together to create bigger Components, the eventual system can be modeled, building-block style, in [Component diagrams](#) <sup>[730]</sup>. By building the system in discrete Components, localization of data and behavior enables decreased dependency between Classes and [Objects](#) <sup>[823]</sup>, providing a more robust and maintainable design.

## Toolbox Icon

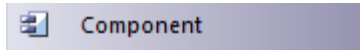

## OMG UML Specification

The OMG UML specification (*UML Superstructure Specification, v2.1.1, p. 148*) states:

*A component represents a modular part of a system that encapsulates its contents and whose manifestation is replaceable within its environment.*

*A component defines its behavior in terms of provided and required interfaces. As such, a component serves as a type whose conformance is defined by these provided and required interfaces (encompassing both their static as well as dynamic semantics).*

### 5.1.2.2.6 Data Type

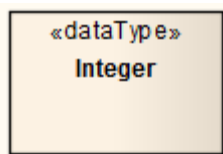

A *Data Type* is a specific kind of classifier, similar to a [Class](#) [817] except that a Data Type cannot own sub Data Types, and instances of a Data Type are identified only by their value. For example, an instance of a *Person* Class is a *Helen* object, but an instance of an *Integer* Data Type is *12*.

All copies of an instance of a Data Type, and any instances of that Data Type with the same value, are considered to be the same instance. That is, instances of *Helen* are not necessarily the same *Helen*, but all *12*s are the same *12*. For example, the *12* on a watch face is exactly the same integer as the number of months in a year.

Instances of a Data Type that have attributes (that is, are instances of a structured Data Type) are considered to be the same if the structure is the same and the values of the corresponding attributes are the same. If a Data Type has attributes, instances of that Data Type contain attribute values matching the attributes.

A typical use of Data Types would be to represent programming language primitive types or CORBA basic types. For example, integer and string types are often treated as Data Types.

A Data Type is denoted by a rectangle with the keyword «*dataType*», as above or, when it is referenced by (for example) an attribute, by a string containing the name of the Data Type, as below:

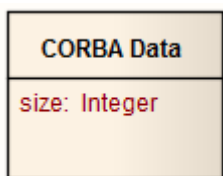

## Toolbox Icon

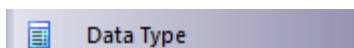

### 5.1.2.2.7 Deployment Spec

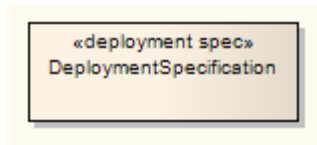

A *Deployment Specification (spec)* specifies parameters guiding deployment of an artifact, as is necessary with most hardware and software technologies. A specification lists those properties that must be defined for deployment to occur, as represented in a [Deployment diagram](#) <sup>[727]</sup>. An instance of this specification specifies the values for the parameters; a single specification can be instantiated for multiple artifacts.

These specifications can be extended by certain component profiles. Examples of standard Tagged Values that a profile might add to a Deployment Specification are «*concurrencyMode*» with Tagged Values {*thread*, *process*, *none*} or «*transactionMode*» with Tagged Values {*transaction*, *nestedTransaction*, *none*}.

The following example depicts the artifact *RepositoryApp* deployed on the server node, as per the specifications of *RepositoryApp*, instantiated from the Deployment Specification *SystemSpec*.

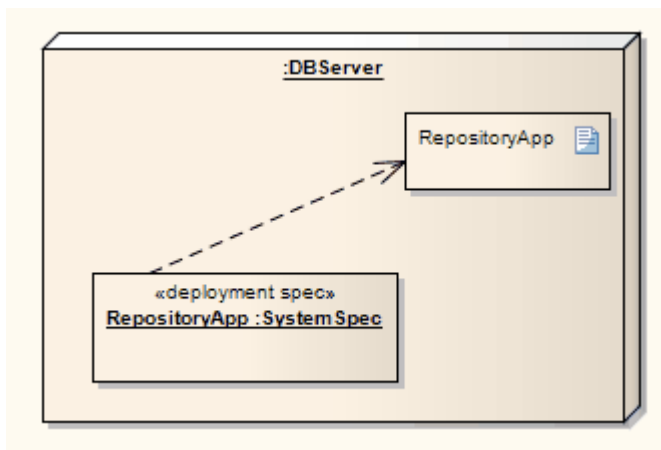

#### Toolbox Icon

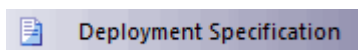

#### OMG UML Specification

The OMG UML specification (*UML Superstructure Specification, v2.1.1, p. 206*) states:

*A deployment specification specifies a set of properties that determine execution parameters of a component artifact that is deployed on a node. A deployment specification can be aimed at a specific type of container. An artifact that reifies or implements deployment specification properties is a deployment descriptor.*

### 5.1.2.2.8 Device

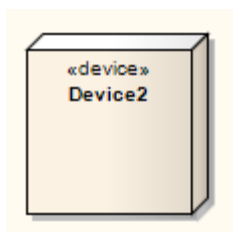

A *Device* is a physical electronic resource with processing capability upon which [Artifacts](#) <sup>[810]</sup> can be deployed

for execution, as represented in a [Deployment diagram](#)<sup>[727]</sup>. Complex Devices can consist of other devices; that is, a Device can be a nested element, where a physical machine is decomposed into its elements either through namespace ownership or through attributes that are typed by Devices.

### Toolbox Icon



### OMG UML Specification

The OMG UML specification (*UML Superstructure Specification, 10.3.7, v2.1.1, p. 207*) states:

*In the metamodel, a Device is a subclass of Node.*

#### 5.1.2.2.9 Document Artifact



A *Document Artifact* is an [artifact](#)<sup>[810]</sup> having a *stereotype* of «*document*». You create the Document Artifact on a Component, Documentation or Deployment diagram, and associate it with an RTF document. Double-click on the element to display the [Linked Document Editor](#). See the [Linked Documents](#)<sup>[597]</sup> topic. When you have created the linked document, the Document Artifact element on the diagram shows an *A* symbol in the bottom right corner.

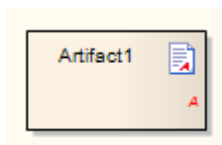

### Toolbox Icon

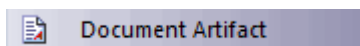

#### 5.1.2.2.10 Enumeration

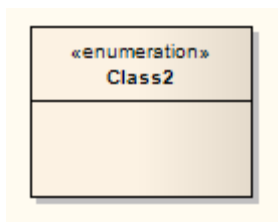

An *Enumeration* is a data type, whose instances can be any of a number of user-defined enumeration literals. It is possible to extend the set of applicable enumeration literals in other packages or profiles. You create Enumerations in [Class](#)<sup>[721]</sup> or [Package diagrams](#)<sup>[720]</sup>, and in diagrams developed from the [Metamodel](#)<sup>[415]</sup> and [Profile](#)<sup>[414]</sup> pages of the [Toolbox](#).

### Toolbox Icon

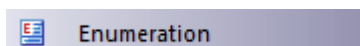

## OMG UML Specification

The OMG UML specification (*UML Superstructure Specification, v2.1.1, p. 69*) states:

*An enumeration is a data type whose values are enumerated in the model as enumeration literals.*

### 5.1.2.2.11 Execution Environment

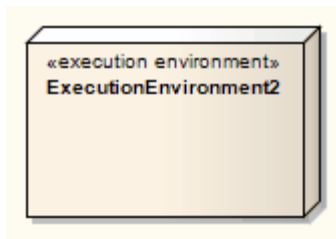

An *Execution Environment* is a [node](#)<sup>[822]</sup> that offers an execution environment for specific types of [components](#)<sup>[816]</sup> that are deployed on it in the form of executable [artifacts](#)<sup>[810]</sup>. This is depicted in a [Deployment diagram](#)<sup>[727]</sup>.

Execution Environments can be nested; for example, a database Execution Environment can be nested in an operating system Execution Environment. Components of the appropriate type are then deployed to specific Execution Environment nodes.

### Toolbox Icon

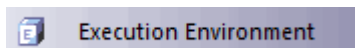

## OMG UML Specification

The OMG UML specification (*UML Superstructure Specification, v2.1.1, p. 210*) states:

*... an ExecutionEnvironment is ... usually part of a general Node, representing the physical hardware environment on which the ExecutionEnvironment resides. In that environment, the ExecutionEnvironment implements a standard set of services that Components require at execution time (at the modeling level these services are usually implicit). For each component Deployment, aspects of these services may be determined by properties in a DeploymentSpecification for a particular kind of ExecutionEnvironment.*

### 5.1.2.2.12 Expose Interface

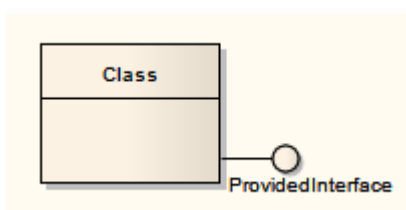
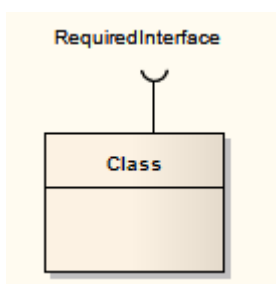



The *Expose Interface* element is a graphical method of depicting the required or supplied [interfaces](#)<sup>[821]</sup> of a [Component](#)<sup>[816]</sup>, [Class](#)<sup>[817]</sup> or [Part](#)<sup>[825]</sup>, in a [Component](#)<sup>[730]</sup> or [Composite Structure](#)<sup>[724]</sup> diagram. It just identifies the fact that the element provides or requires an interface; to depict the fact that the provided interface is used, or the required interface provided, by another element use the [Assembly](#)<sup>[855]</sup> connector.

The Expose Interface element must be attached to the Class or Component element, and it becomes a child element of that Class or Component; it cannot exist independently. You can attach more than one Expose Element to another element.

When you create the Expose Interface element, a dialog displays in which you enter a name for the element and specify whether it represents a required interface or a provided interface.

### Toolbox Icon

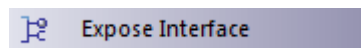

#### 5.1.2.2.13 Information Item

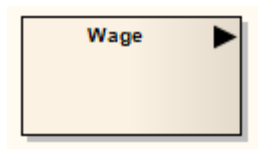

An *Information Item* represents an abstraction of data. It is used in [Activity](#)<sup>[674]</sup>, [Analysis](#)<sup>[733]</sup> and [Object](#)<sup>[723]</sup> diagrams. An Information Item is also represented by an [Information Flow](#)<sup>[864]</sup> connector.

### Toolbox Icon

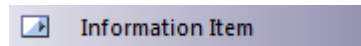

### OMG UML Specification

The OMG UML specification (*UML Superstructure Specification, v2.1.1, p. 608*) states:

*An information item is an abstraction of all kinds of information that can be exchanged between objects. It is a kind of classifier intended for representing information at a very abstract way, one which cannot be instantiated.*

*One purpose of information items is to be able to define preliminary models, before having made detailed modeling decisions on types or structures. One other purpose of information items and information flows is to abstract complex models by a less precise but more general representation of the information exchanged between entities of a system.*

#### 5.1.2.2.14 Interface

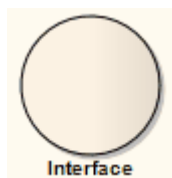

An *Interface* is a specification of behavior (or contract) that implementers agree to meet. By implementing an Interface, [Classes](#)<sup>[721]</sup> are guaranteed to support a required behavior, which enables the system to treat non-related elements in the same way; that is, through the common interface. You also use Interfaces in a [Composite Structure](#)<sup>[724]</sup> diagram.

Interfaces are drawn in a similar way to a Class, with operations specified, as shown below. They can also be drawn as a circle with no explicit operations detailed. Right-click on the element and select the **Use Circle Notation** context menu option to switch between styles. [Realize](#)<sup>[889]</sup> connectors to an Interface drawn as a

circle are drawn as a solid line without target arrows.

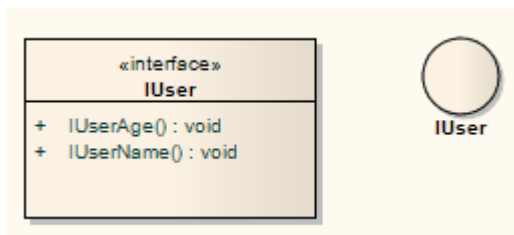

#### Note:

An Interface cannot be instantiated (that is, you cannot create an object from an Interface). You must create a Class that 'implements' the Interface specification, and in the Class body place operations for each of the Interface operations. You can then instantiate the Class.

### Toolbox Icon

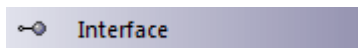

### OMG UML Specification

The OMG UML specification (*UML Superstructure Specification, v2.1.1, p. 88*) states:

*An interface is a kind of classifier that represents a declaration of a set of coherent public features and obligations. An interface specifies a contract; any instance of a classifier that realizes the interface must fulfill that contract. The obligations that may be associated with an interface are in the form of various kinds of constraints (such as pre- and post-conditions) or protocol specifications, which may impose ordering restrictions on interactions through the interface.*

*Since interfaces are declarations, they are not instantiable. Instead, an interface specification is implemented by an instance of an instantiable classifier, which means that the instantiable classifier presents a public facade that conforms to the interface specification. Note that a given classifier may implement more than one interface and that an interface may be implemented by a number of different classifiers.*

#### 5.1.2.2.15 Node

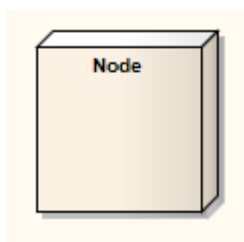

A *Node* is a physical piece of equipment on which the system is deployed, such as a workgroup server or workstation. A Node usually hosts components and other executable pieces of code, which again can be connected to particular processes or execution spaces. Typical Nodes are client workstations, application servers, mainframes, routers and terminal servers.

Nodes are used in [Deployment diagrams](#)<sup>[727]</sup> to model the deployment of a system, and to illustrate the physical allocation of implemented artifacts. They are also used in web modeling, from dedicated web modeling pages in the [Toolbox](#)<sup>[399]</sup>.

### Toolbox Icon



## OMG UML Specification

The OMG UML specification (*UML Superstructure Specification, v2.1.1, p. 213*) states:

*In the metamodel, a Node is a subclass of Class. It is associated with a Deployment of an Artifact. It is also associated with a set of Elements that are deployed on it. This is a derived association in that these PackageableElements are involved in a Manifestation of an Artifact that is deployed on the Node. Nodes may have an internal structure defined in terms of parts and connectors associated with them for advanced modeling applications.*

### 5.1.2.2.16 Object

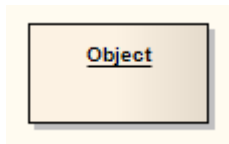

An *Object* is a particular *instance* of a [Class](#)<sup>[819]</sup> at run time. For example a car with the license plate **AAA-001** is an instance of the general class of cars with a license plate number attribute. Objects are often used in analysis to represent the numerous artifacts and items that exist in any business, such as pieces of paper, faxes and information. To model the varying behavior of Objects at run-time, use [run-time states](#)<sup>[823]</sup>.

Early in analysis, Objects can be used to quickly capture all the things that are of relevance within the system domain, in an [Object](#)<sup>[723]</sup>, [Composite Structure](#)<sup>[724]</sup> or [Communication](#)<sup>[715]</sup> diagram. As the model progresses these analysis Objects are refined into generic Classes from which instances can be derived to represent common business items. Once Classes are defined, Objects can be typed; that is they can have a classifier set that indicates their base type. See the [Object Classifiers](#)<sup>[519]</sup> topic.

Enterprise Architect also supports a number of [stereotyped Object](#)<sup>[739]</sup> elements to represent various entities in business modeling.

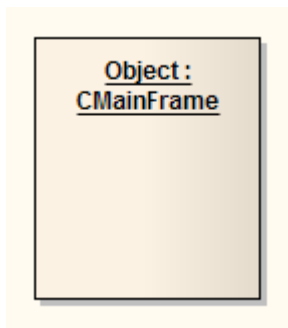

## Toolbox Icon



### 5.1.2.2.16.1 Run-time State

At run-time, an [Object](#)<sup>[823]</sup> instance can have specific values for its attributes, or exist in a particular state. To model the varying behavior of Objects at run-time, use instance values selected from the [Select <Item>](#)<sup>[515]</sup> dialog and *run-time states* or *run-states*.

Typically there is interest in the run-time behavior of Objects that already have a classifier set. You can select from the classifier's attribute list and apply specific values for your Object instance. If the classifier has a child [State Machine](#)<sup>[678]</sup>, its [States](#)<sup>[789]</sup> propagate to a list where the run-time state for the Object can be defined. To do this, see the following topics:

- [Define a Run-Time Variable](#)<sup>[824]</sup>
- [Remove a Defined Variable](#)<sup>[824]</sup>
- [Object State](#)<sup>[824]</sup>

The following example defines run-time values for the listed variables, which are attributes of the instances' classifier *AccountItem*.



To add [run-time state](#) <sup>[823]</sup> instance variables to an Object, follow the steps below:

1. Right-click on the Object. The context menu displays.
2. If Instance Variables are supported, select the **Advanced | Set Run State** menu option (or press **[Ctrl]+[Shift]+[R]**). The **Set Run State** dialog displays.

3. In the **Variable** field, click on the drop-down arrow and select the variable, or type in the new variable name.
4. Set the **Operator**, the **Value** and optionally type in a **Note**.
5. Click on the **OK** button to save the variable.

To delete a [run-time state](#) <sup>[823]</sup> variable for an Object, follow the steps below:

1. Right-click on the required Object. The context menu displays.
2. Select the **Set Run State** option. The **Run State** dialog displays.
3. In the **Variable** field, click on the drop-down arrow and select the variable to delete.
4. Clear the **Value** field.
5. Click on the **OK** button.

#### 5.1.2.2.16.2 Object State

To set the Object state for a Class instance, follow the steps below:

1. Right-click on the required Object and select the **Advanced | Set Object State** context menu option. The **Set Instance State** dialog displays.

2. In the **State** field, either type the required State (such as **Awaiting Approval**) or select a State from the drop-down list.

**Note:**

The drop-down list for the **State** field is populated with:

1. Any States owned by the object's classifier.
  2. Any States owned by any superclasses of the object's classifier.
  3. Any States owned by State Machines owned by the object's classifier.
  4. Any States owned by State Machines owned by any superclasses of the object's classifier.
3. Click on the **OK** button to apply the State. The object now shows the run-time state in square brackets below the object name.

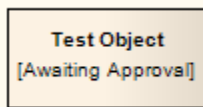
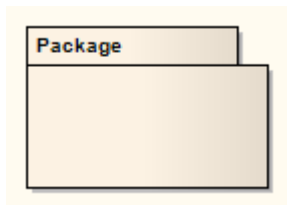
**5.1.2.2.17 Package**

A *Package* is a namespace as well as an element that can be contained in other Package's namespaces. A Package can own or merge with other Packages, and its elements can be imported into a Package's namespace. In addition to using Packages in the **Project Browser** to organize your project contents, you can drag these Packages onto a diagram workspace (most diagram types, both standard and extended) for structural or relational depictions, including Package imports or merges.

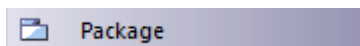
**Toolbox Icon****OMG UML Specification**

The OMG UML specification (*UML Superstructure Specification, v2.1.1, p. 109*) states:

*A package is a namespace for its members, and may contain other packages. Only packageable elements can be owned members of a package. By virtue of being a namespace, a package can import either individual members of other packages, or all the members of other packages. In addition a package can be merged with other packages.*

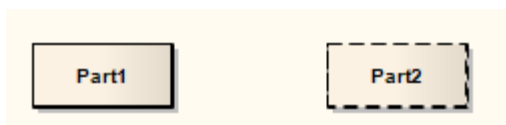
**5.1.2.2.18 Part**

*Parts* are run-time instances of [Classes](#)<sup>[81]</sup> or [Interfaces](#)<sup>[82]</sup>. Multiplicity can be specified for a Part, using the notation:

[x{...}y]

where *x* specifies the initial or set amount of instances when the composite structure is created, and *y* indicates the maximum amount of instances at any time.

Parts are used to express [composite structures](#)<sup>[724]</sup>, or modeling patterns that can be invoked by various objects to accomplish a specific purpose. When illustrating the composition of structures, Parts can be embedded as properties of other Parts. When embedded as [properties](#)<sup>[726]</sup>, Parts can be bordered by a solid outline, indicating the surrounding Part owns the Part by composition. Alternatively, a dashed outline indicates that the property is referenced and used by the surrounding Part, but is not composed within it.

You can also set [properties](#)<sup>[829]</sup> and [property values](#)<sup>[826]</sup> for Parts.

### Toolbox Icon



#### 5.1.2.2.18.1 Add Property Value

To add property value variables to a Part, follow the steps below:

1. Right-click on the Part. The context menu displays.
2. Select the **Advanced | Set Property Values** menu option (or press **[Ctrl]+[Shift]+[R]**). The **Set Property Values** dialog displays.

The dialog box has the following fields and buttons:

- Variable:** A text field with a drop-down arrow.
- Operator:** A text field with a drop-down arrow.
- Value:** A text field.
- Note:** A larger text area.
- Buttons:** OK, Apply, Cancel, and Help.

3. In the **Variable** field, click on the drop-down arrow and select the variable, or type in the new variable name.
4. Set the **Operator**, the **Value** and optionally type in a **Note**.
5. Click on the **OK** button to save the variable.

A Part with a property value resembles the following figure.

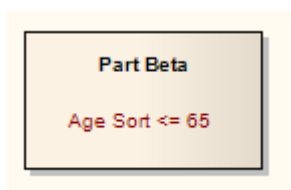

#### 5.1.2.2.19 Port

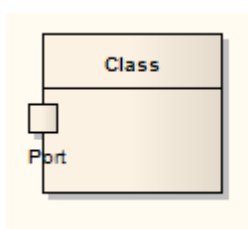

*Ports* define the interaction between a classifier and its environment. *Interfaces* controlling this interaction can be depicted using the [Interface element](#)<sup>[821]</sup>. Any connector to a Port must provide the required interface, if

defined. Ports can appear on a contained [Part](#)<sup>[825]</sup>, a [Class](#)<sup>[811]</sup>, or the boundary of a [Composite element](#)<sup>[837]</sup>.

A Port is a *typed* structural feature or property of its containing classifier. Ports are typically [created](#)<sup>[827]</sup> in [Class diagrams](#)<sup>[721]</sup>, [Object diagrams](#)<sup>[723]</sup> and [Composite Structure diagrams](#)<sup>[724]</sup>.

You can [expose an inherited Port, or redefine a Port](#)<sup>[827]</sup>. You also define specific [properties](#)<sup>[829]</sup> for a Port element.

## Toolbox Icon



## OMG UML Specification

The OMG UML specification (*UML Superstructure Specification, v2.1.1, p. 182*) states:

*A port is a property of a classifier that specifies a distinct interaction point between that classifier and its environment or between the (behavior of the) classifier and its internal parts. Ports are connected to properties of the classifier by connectors through which requests can be made to invoke the behavioral features of a classifier. A Port may specify the services a classifier provides (offers) to its environment as well as the services that a classifier expects (requires) of its environment.*

### 5.1.2.2.19.1 Add a Port to an Element

To add a new [Port](#)<sup>[826]</sup> to an element, use one of the following steps:

1. Click on the **Port** symbol in the **Composite Elements** page of the **Toolbox** and drag it to (or click on) the target host element. This creates an untyped, simple Port on the boundary, near the cursor position.
2. On the context menu of a suitable Class, Part or [Composite element](#)<sup>[837]</sup>, select the **Embedded Elements | Add Port** menu option to add a new Port at the cursor position.
3. Drag a suitable classifier from the **Project Browser** onto a Class or Part. Enterprise Architect prompts you to add a typed Port or Part at the cursor position. The new Port is typed by the original dragged classifier.
4. Use the [Embedded Elements](#)<sup>[827]</sup> window to add a new Port to the currently selected element.

### 5.1.2.2.19.2 Inherited and Redefined Ports

A [Port](#)<sup>[826]</sup> is a *redefinable* and *re-useable* property of a composite classifier. So, as for attributes, any Class can inherit Ports from its parent and realized interfaces. If you have an inheritance hierarchy with Ports defined in the parent Classes, when you open the **Embedded Elements** window the inherited Ports and their named owners are listed there.

It is possible to expose, for design purposes, an inherited Port (that is, the child Class is re-using the parent Port). In this case, Enterprise Architect creates a clone of the re-used Port and marks it as read-only in the child Class. This is convenient for modeling Port interactions in child Classes where the Ports are defined in the parent elements.

It is also possible to redefine a Port in a child Class, so that the name is the same but the child is a modifiable clone of the original. This is useful where a child Class places additional restrictions or behavior on the Port. The **Embedded Elements** window enables you to highlight an inherited Port and mark it as *redefined*; this creates a new Port on the child Class, which is editable but still logically related to the initial Port.

The **Embedded Elements** window below illustrates Port inheritance. The Port *removableHD* is owned by the child Class. The Ports *eth0* and *USB* are owned by the *Computer* Class. The Port *firewire* has been added to *PC*. If any of the inherited Ports are made visible, they are considered re-use Ports and appear on the child in read-only format. Using the **Redefine** button, the inherited Port can be copied down and made writeable.

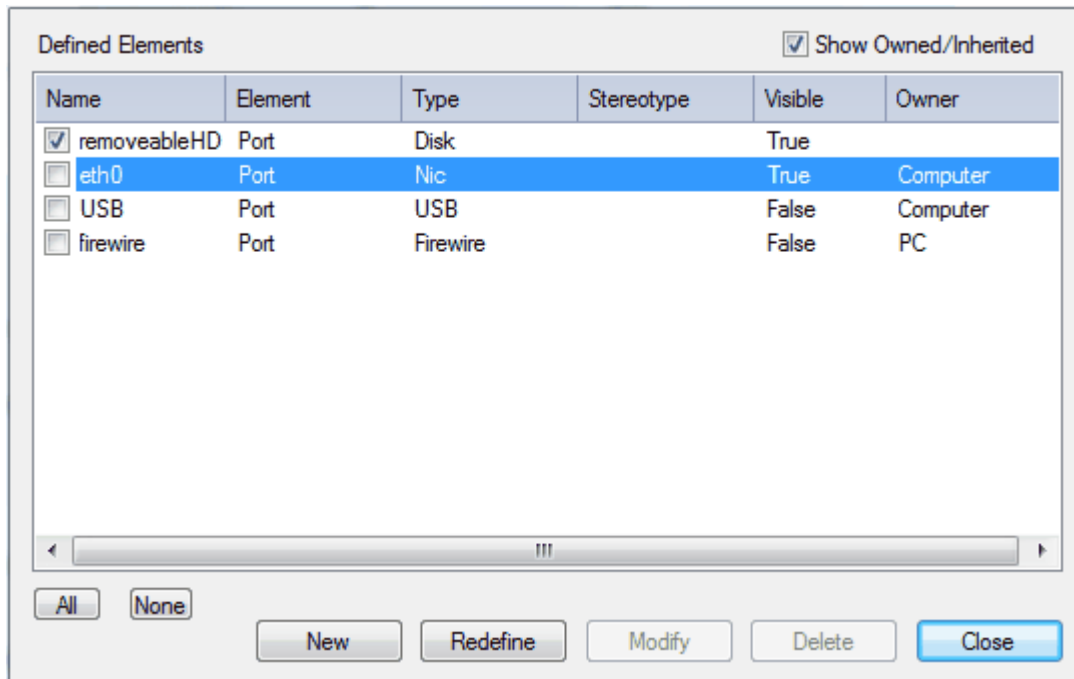



### 5.1.2.2.19.3 The Property Tab

The element [Properties](#)<sup>[48]</sup> dialog for Ports and Parts has a **Property** tab in place of the Class element **Details** tab.

This tab defines the type, initial value, [Qualifiers](#)<sup>[830]</sup>, multiplicity, and redefined and subsetted properties of the Port or Part.

You set the Qualifiers by clicking on the **Qualifiers** button, to display the [Qualifiers](#)<sup>[832]</sup> dialog.

You add **Redefined** and **Subsetted Properties** by clicking on the appropriate **Add** button, to display the [Select Property](#)<sup>[517]</sup> dialog.

### 5.1.2.2.20 Primitive

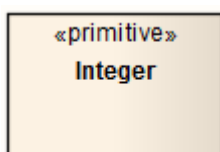

A *Primitive* element identifies a predefined data type, without any relevant substructure (that is, it has no parts in the context of UML). It could be regarded as a conceptual [Data Type](#) <sup>[817]</sup>.

## Toolbox Icon



## OMG UML Specification

The OMG UML specification (*UML Superstructure Specification, v2.1.1, p. 124*) states:

*A primitive data type may have an algebra and operations defined outside of UML, for example, mathematically ... The run-time instances of a primitive type are data values. The values are in many-to-one correspondence to mathematical elements defined outside of UML (for example, the various integers). Instances of primitive types do not have identity. If two instances have the same representation, then they are indistinguishable.*

### 5.1.2.21 Qualifiers

*Qualifiers* are ordered sets of properties of an [Association end point](#) <sup>[629]</sup>, a [Part](#) <sup>[825]</sup>, a [Port](#) <sup>[826]</sup>, or an [Attribute](#) <sup>[558]</sup>, that limit the nature of the relationship between two classifiers or objects. You define a qualifier on the [Qualifiers](#) <sup>[832]</sup> dialog, which you display by clicking on the [ ... ] button at the end of the **Qualifiers** field on the Association, Part, Port or Attribute **Properties** dialog.

Some examples of qualified Associations are shown in the following diagram:

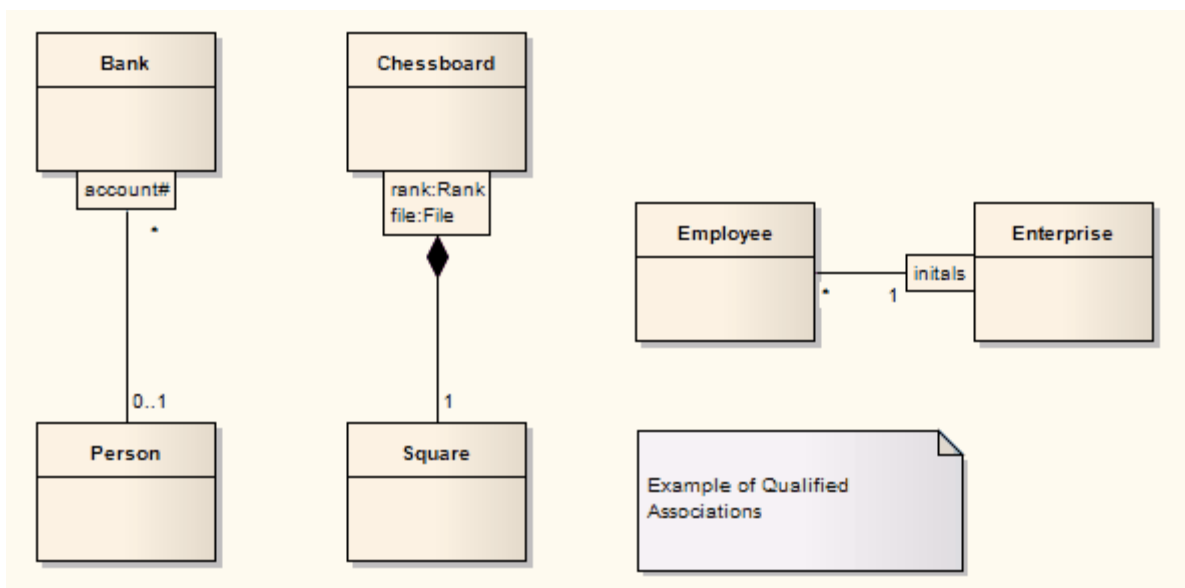

#### Notes:

- When typing multiple Qualifiers into the **Qualifier(s)** field on a **Properties** dialog, separate them with a semi-colon; each Qualifier then displays on a separate line. For example, in the diagram the Qualifier '*rank:Rank;file:File*' has been rendered in two lines, with a line break at the ; character.
- You can enable or disable Qualifier rectangles in the **Diagram** page of the **Options** dialog (select the **Tools | Options | Diagram** menu option). If disabled, the old style text Qualifiers are used. It is not recommended that you disable Qualifiers as they are an integral part of the UML.
- You can enable or disable a mild shading on the Qualifier rectangles in the **Links** page of the **Options** dialog.

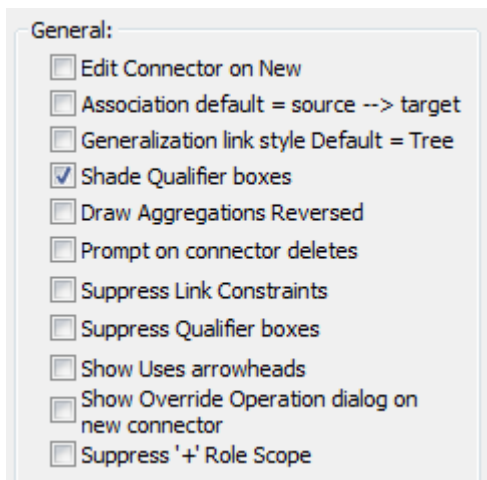

## OMG UML Specification

The OMG UML specification (*UML Superstructure Specification*, v2.1.1, p. 129) states:

*A qualifier declares a partition of the set of associated instances with respect to an instance at the qualified end (the qualified instance is at the end to which the qualifier is attached). A qualifier instance comprises one value for each qualifier attribute. Given a qualified object and a qualifier instance, the number of objects at the other end of the association is constrained by the declared multiplicity. In the common case in which the multiplicity is 0..1, the qualifier value is unique with respect to the qualified object, and designates at most one associated object. In the general case of multiplicity 0..\*, the set of associated instances is partitioned into subsets, each selected by a given qualifier instance. In the case of multiplicity 1 or 0..1, the qualifier has both semantic and implementation consequences. In the case of multiplicity 0..\*, it has no real semantic consequences but suggests an implementation that facilitates easy access of sets of associated instances linked by a given qualifier value.*

### 5.1.2.21.1 Qualifiers Dialog

The **Qualifiers** dialog is used to define the **Qualifiers** of an **Association connector end**, **Port**, **Part** or **Attribute**.

The screenshot shows the Qualifiers dialog box with the following details:

- General Tab:**
  - Name: aqua1
  - Alias: a\_qualifier
  - Type: UnlimitedNatural
  - Scope: Public
  - Stereotype: (empty)
  - Initial: 101
  - Notes: Notes on aqua1.
  - Options:  Derived,  Static,  Const
- Qualifiers Table:**

Name	Type	Initial Value
aqua1	UnlimitedNatural	101
aqua2	UnlimitedNatural	10

### General Tab

Review, edit or complete the fields as indicated in the following table.

Field	Use to
<b>Name</b>	Display the name of the Qualifier. For a new Qualifier, type the name (with no spaces).
<b>Alias</b>	Display an optional alias for the Qualifier. If necessary, type in a new alias.
<b>Type</b>	<p>Display the Qualifier type.</p> <p>The type can be defined by the code language (data type) or by a classifier element. When you click on the drop-down arrow, the set of values in the list provides the appropriate data types.</p> <p>To select or define possible classifiers, either click on the <b>Select Type</b> option in the list, or click on the [ ... ] (Select) button to display the <b>Select &lt;Item&gt;</b> dialog.</p> <p>To add new code language data types that can be displayed in this list, see the <b>Data Types</b> topic.</p>
<b>Scope</b>	Define the Qualifier as <b>Public</b> , <b>Protected</b> , <b>Private</b> or <b>Package</b> . If necessary, click on the

Field	Use to
	drop-down arrow and select a different scope.
<b>Stereotype</b>	Define the optional stereotype of the Qualifier. If necessary, either type a different stereotype name or click on the drop-down arrow and select a stereotype.
<b>Derived</b>	Indicate that the Qualifier is a calculated value. If you select this checkbox, the Qualifier name on the element has the derived symbol ( <i>/</i> ) as a prefix.
<b>Static</b>	Indicate that the Qualifier is a static member.
<b>Const</b>	Indicate that the Qualifier is a constant.
<b>Initial</b>	Display an optional initial value. If necessary, type in a new initial value.
<b>Notes</b>	Enter any free text notes associated with the Qualifier. You can format the notes text using the <a href="#">Notes</a> <sup>[642]</sup> toolbar at the top of the field.

To change the position of a Qualifier in the list in the **Qualifiers** panel, click on the **Scroll Up** or **Scroll Down** (hand) buttons.

### Detail Tab

Use the **Detail** tab to model additional properties of a selected Qualifier, such as its multiplicity, redefined properties and subsetted properties.

The screenshot shows the 'Detail' tab of a dialog box for configuring a Qualifier. It includes the following elements:

- Multiplicity:**
  - Lower bound: 1
  - Upper bound: 10
  - Allow Duplicates
  - Multiplicity is Ordered
- Redefined Property:**
  - List box containing: Property
  - Buttons: Add..., Delete
- Subsetted Property:**
  - List box containing: Property, «column.»Development Model::Class Model::ClassLibrary2::Account.DeliveryAddress
  - Buttons: Add..., Delete
- Bottom Buttons:** OK, Cancel, Help

Select a Qualifier on the **General** tab, then review, edit or complete the **Detail** tab fields as indicated in the

following table.

Field	Use to
Multiplicity	
Lower bound	Define a lower limit to the number of elements allowed in the collection.
Upper bound	Define an upper limit to the number of elements allowed in the collection.
Allow Duplicates	Indicate that duplicates are allowed. Maps to the UML property <i>isUnique</i> , value <i>FALSE</i> .
Multiplicity is Ordered	Indicate that the collection is ordered.
Redefined Property	Review the redefined properties for the Qualifier. Add redefined properties by clicking on the <b>Add</b> button to display the <a href="#">Select Property</a> <sup>[517]</sup> dialog.
Subsetted Property	Review the subsetted properties for the qualifier. Add subsetted properties by clicking on the <b>Add</b> button to display the <a href="#">Select Property</a> <sup>[517]</sup> dialog.

#### 5.1.2.22 Signal

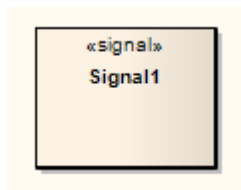

A *Signal* is a specification of [Send](#)<sup>[789]</sup> request instances communicated between objects, typically in a [Class](#)<sup>[721]</sup> or [Package](#)<sup>[720]</sup> diagram. The receiving object handles the [Received](#)<sup>[787]</sup> request instances as specified by its *receptions*. The data carried by a Send request is represented as attributes of the Signal. A Signal is defined independently of the classifiers handling the signal occurrence.

To define a reception, create an operation in the receiving object and assign the stereotype <<signal>> to it. The reception has the same name as the signal that the object can receive.

#### Toolbox Icon



#### OMG UML Specification

The OMG UML specification (*UML Superstructure Specification, v2.1.1, p. 450*) states:

*A signal triggers a reaction in the receiver in an asynchronous way and without a reply. The sender of a signal will not block waiting for a reply but continue execution immediately. By declaring a reception associated to a given signal, a classifier specifies that its instances will be able to receive that signal, or a subtype thereof, and will respond to it with the designated behavior.*

And (*UML Superstructure Specification, v2.1.1, p. 447 - 448*):

*A reception is a declaration stating that a classifier is prepared to react to the receipt of a signal. A reception designates a signal and specifies the expected behavioral response. The details of handling a signal are specified by the behavior associated with the reception or the classifier itself. ...Receptions are shown using the same notation as for operations with the keyword <signal>*

### 5.1.2.3 Inbuilt and Extension Stereotypes

There are many other UML elements that you can also work with in Enterprise Architect, most of which are basic elements extended by the use of stereotypes. This topic gives a brief introduction to some of these elements.

- [Analysis Stereotypes](#)<sup>[835]</sup>
- [Boundary Element](#)<sup>[836]</sup>
- [Composite Elements](#)<sup>[837]</sup>
- [Control Element](#)<sup>[838]</sup>
- [Entity Element](#)<sup>[839]</sup>
- [Event Elements](#)<sup>[839]</sup>
- [Hyperlinks](#)<sup>[840]</sup>
- [N-Ary Association](#)<sup>[844]</sup>
- [Process](#)<sup>[846]</sup>
- [Requirements](#)<sup>[846]</sup>
- [Screen](#)<sup>[847]</sup>
- [Table](#)<sup>[849]</sup>
- [UI Control Element](#)<sup>[849]</sup>
- [Web Stereotypes](#)<sup>[851]</sup>

For more information on the use of stereotypes in Enterprise Architecture, see the [UML Stereotypes](#)<sup>[895]</sup> topic.

#### 5.1.2.3.1 Analysis Stereotypes

Enterprise Architect has some built in stereotypes that you can assign to an element during analysis. The effect of these stereotypes is to display a different icon from the normal element icon, providing a visual key to the element purpose. The *Robustness* diagram below illustrates the main types of inbuilt icons for elements:

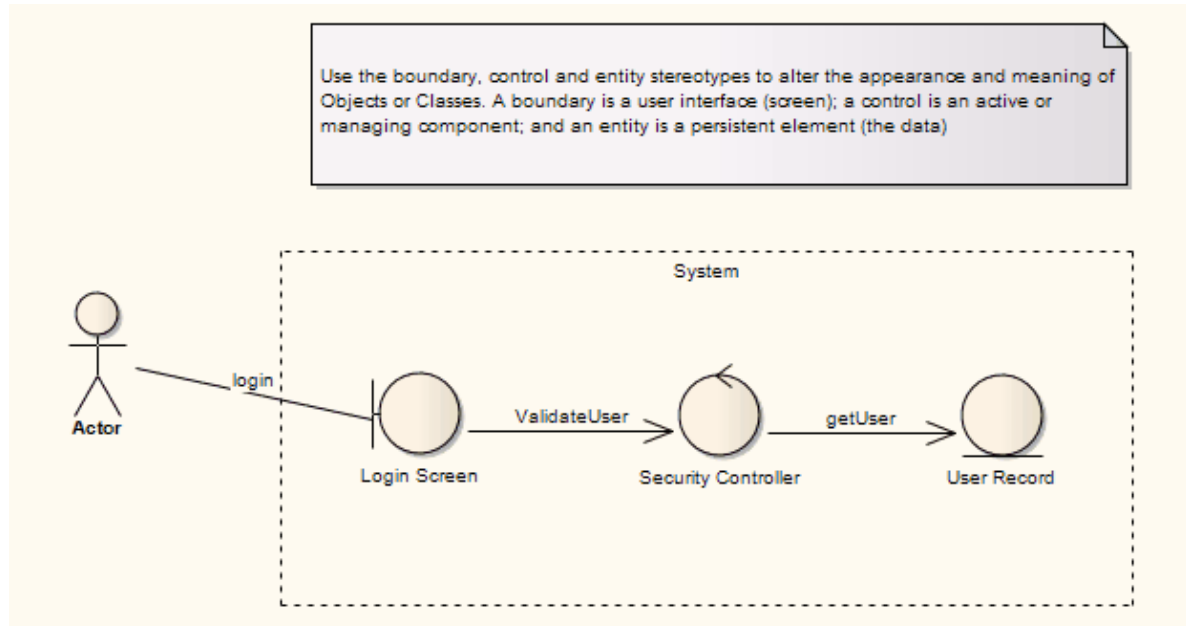

The stereotypes used are:

- [Boundary](#)<sup>[836]</sup> - for a system boundary (for example, a Login screen)
- [Control](#)<sup>[838]</sup> - to specify an element is a controller of some process (as in the Model-View-Controller pattern)
- [Entity](#)<sup>[839]</sup> - the element is a persistent or data element

Also see the [Business Modeling](#)<sup>[739]</sup> elements, used in Business Modeling and Business Interaction diagrams.

### 5.1.2.3.2 Boundary

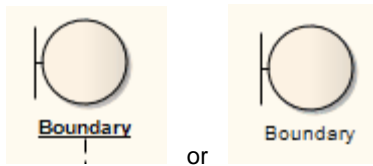

A *Boundary* is a stereotyped [Object](#) [823] that models some system boundary, typically a user interface screen. You can also create a *Boundary* as a stereotyped [Class](#) [811]. See the [Create a Boundary](#) [836] topic.

A *Boundary* is used in the conceptual phase to capture users interacting with the system at a screen level (or some other boundary interface type). It is often used in [Sequence](#) [706] and [Robustness \(Analysis\)](#) [733] diagrams. It is the *View* in the [Model-View-Controller](#) [836] pattern.

#### Tip:

Use *Boundary* elements in analysis to capture user interactions, screen flows and element interactions (or 'collaborations').

#### Toolbox Icon

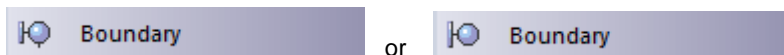

#### 5.1.2.3.2.1 Create a Boundary

##### Create As An Object

To create a [Boundary](#) [836] element on a diagram as an Object, follow the steps below:

1. In the **Toolbox**, select the **More Tools | Analysis** menu option.
2. From the **Analysis Elements** page, drag the *Boundary* element onto the diagram.

##### Create As A Class

To create a *Boundary* element as a stereotyped Class, using the Class **Properties** dialog, follow the steps below:

1. Insert a new Class.
2. Right-click on the element and select the **Properties** context menu option; the **Properties** dialog displays.
3. In the **Stereotype** field, type the value **boundary**.
4. Click on the **Apply** and **OK** buttons.
5. Save the diagram ([**Ctrl**]+[**S**]).

The following illustration shows an [Actor](#) [757] interacting with a *Boundary* (in this case, a Login screen).

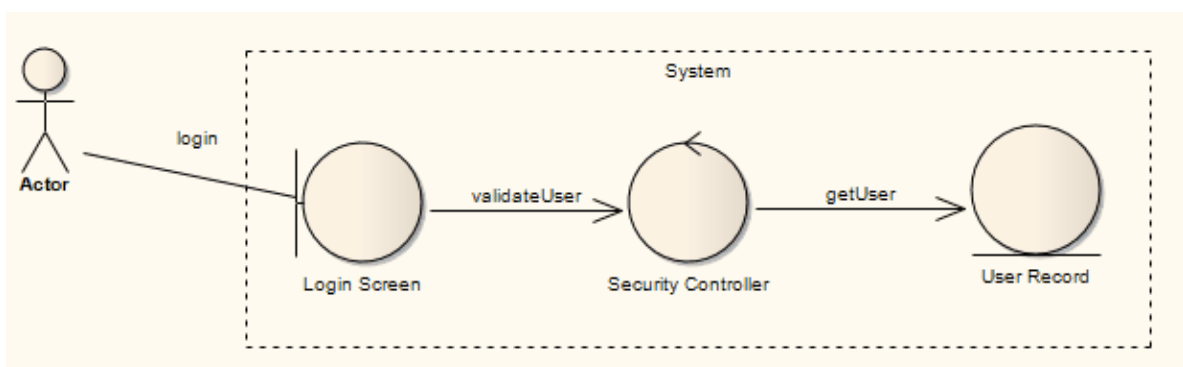



**Note:**

The Model-View-Controller (MVC) pattern is a design pattern for building a wide range of applications that have a user interface, business or application logic and persistent data.

### 5.1.2.3.3 Composite Elements

Enterprise Architect supports *Composite elements* for Classes, Objects, Use Cases and such. A Composite element is a pointer to a child diagram.

#### Create a Composite Element

To set Composite elements from the element context menu, follow the steps below:

1. Create the element to set as a Composite element.
2. Right-click on the element in the diagram and select the **Advanced | Make Composite** context menu option.

**Note:**

If the **Make Composite** option is not listed in the context menu, the option is not available for the type of element you have selected.

The element displays as follows:

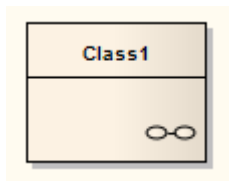

Note the small icon in the bottom right hand corner indicating that this is now a Composite element.

3. Double-click on the Composite element to access the child diagram that it points to.

The Composite element and its child diagram are represented in the **Project Browser** as follows:

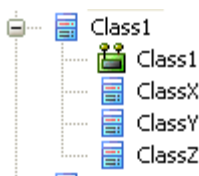

Note that *ClassX*, *ClassY* and *ClassZ* are elements in the child diagram.

#### Alternative Notation

Composite elements can show their contents instead of their usual notation. To enable this, right-click on the element to open the context menu, then select the **Advanced | Show Composite Diagram** option.

#### The Automation Interface

[Automation support](#)<sup>[1666]</sup> is available for Composite elements. *Element* has an *Elements* collection and a *Diagrams* collection.

### 5.1.2.3.4 Control

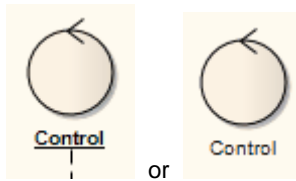

A *Control* is a stereotyped [Object](#) [823] that models a controlling entity or manager. A Control organizes and schedules other activities and elements, typically in [Analysis](#) [733] (including Robustness), [Sequence](#) [706] and [Communication](#) [715] diagrams. It is the *controller* of the [Model-View-Controller](#) [838] pattern.

You can also create a Control as a stereotyped [Class](#) [811]. See the [Create a Control Element](#) [838] topic.

#### Toolbox Icon

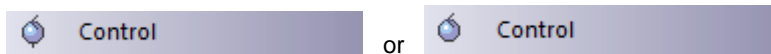

#### 5.1.2.3.4.1 Create a Control Element

##### Create As An Object

To create a [Control](#) [838] element on a diagram as an Object, follow the steps below:

1. In the **Toolbox**, select the **More Tools | Analysis** menu option.
2. From the **Analysis Elements** page, drag the *Control* element onto the diagram.

##### Create As A Class

To create a Control element as a stereotyped Class, using the Class **Properties** dialog, follow the steps below:

1. Insert a new Class.
2. Right-click on the element and select the **Properties** context menu option; the **Properties** dialog displays.
3. In the **Stereotype** field, type the value **control**.
4. Click on the **Apply** and **OK** buttons.
5. Save the diagram (**[Ctrl]+[S]**).

The appearance changes as illustrated in the following diagram (for the *Security Controller* element):

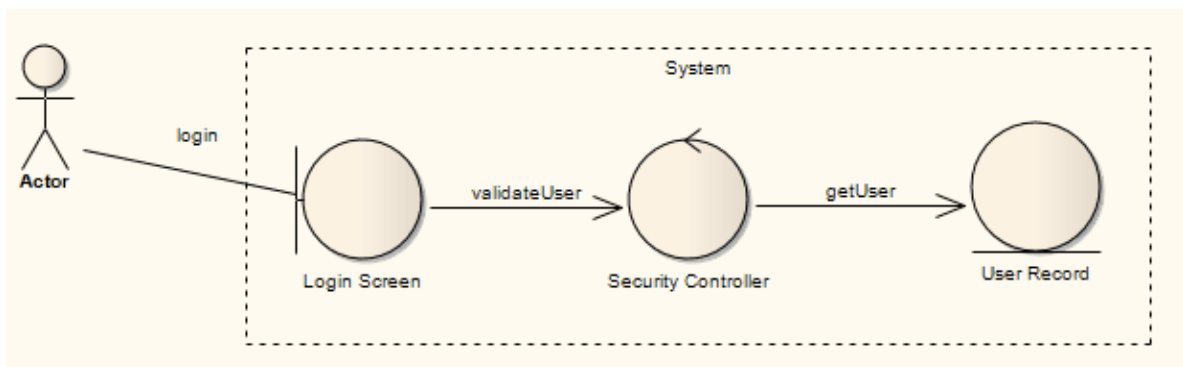

#### Note:

The *Model-View-Controller (MVC)* pattern is a design pattern for building a wide range of applications that have a user interface, business or application logic and persistent data.

### 5.1.2.3.5 Entity

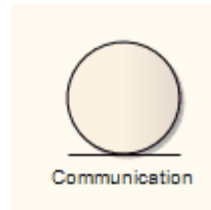

**From:** [Sequence Diagram](#) <sup>[706]</sup>

[Communication](#) <sup>[715]</sup>, [Object](#) <sup>[723]</sup>, [Analysis](#) <sup>[733]</sup>  
(including Robustness) Diagrams

An *Entity* is a stereotyped [Object](#) <sup>[823]</sup> that models a store or persistence mechanism that captures the information or knowledge in a system. It is the *Model* in the [Model-View-Controller](#) <sup>[836]</sup> pattern.

You can also create an Entity as a stereotyped [Class](#) <sup>[811]</sup>. See the [Create an Entity](#) <sup>[839]</sup> topic.

#### Toolbox Icon

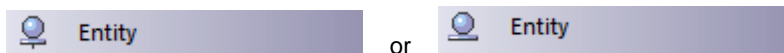

#### 5.1.2.3.5.1 Create an Entity

##### Create As An Object

To create an [Entity](#) <sup>[839]</sup> element on a diagram as an Object, follow the steps below:

1. In the **Toolbox**, select the **More Tools | Analysis** menu option.
2. From the **Analysis Elements** page, drag the *Entity* element onto the diagram.

##### Create As A Class

To create an Entity element as a stereotyped Class, using the Class **Properties** dialog, follow the steps below:

1. Insert a new Class.
2. Right-click on the element and select the **Properties** context menu option; the **Properties** dialog displays.
3. In the **Stereotype** field, type the value **entity**.
4. Click on the **Apply** and **OK** buttons.
5. Save the diagram (**[Ctrl]+[S]**).

#### 5.1.2.3.6 Event

UML includes two elements that are used to model *Events*. The first element is the *Send Event*. This element models the generation of a stimulus in the system and the passing of that stimulus to other elements, either within the system or external to the system.

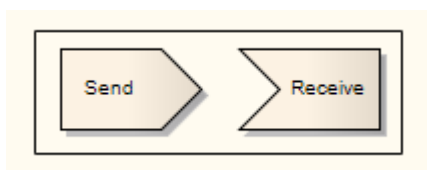

The second element is the *Receive Event*, which is depicted as a rectangle with a recessed 'V' on the left side. This element indicates that an event occurs in the system due to some external or internal stimulus. Typically this invokes further activities and processing.

Send and Receive Events can be added from the [Analysis](#)<sup>[416]</sup> and [Activity](#)<sup>[412]</sup> **Element** pages of the **Toolbox**.

If you should select the wrong type of event, or otherwise want to change the type, right-click on the Event and select the **Advanced | Make Sender** or **Advanced | Make Receiver** context menu option, as appropriate.

## Toolbox Icons



### 5.1.2.3.7 Feature

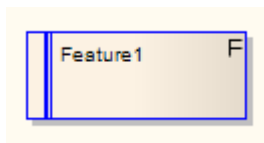

A *Feature* is a small, granular function or characteristic expressed in client-valued terms as a satisfaction of a requirement; for example: 'context-sensitive Help', or 'ability to reverse-engineer VB.Net'.

Features are the primary requirements-gathering artifact of the [Feature-Driven Design \(FDD\) methodology](#). They define the product feature that satisfies what a [Requirement](#)<sup>[846]</sup> element has formalized as a contractual, testable, expected deliverable (for example: requirement - 'every element must provide context-sensitive Help'; feature - 'every element provides context-sensitive Help'). One Feature might realize one or more Requirements, and one Requirement might be realized by more than one Feature.

Features also have relationships with [Use Cases](#)<sup>[806]</sup>. A Use Case defines the interaction a user has with the system in order to satisfy one or more Requirements. The Feature identifies the facility that provides the means for that interaction.

Feature elements are non-UML and are not related to UML-defined features, which are either *BehavioralFeatures* ([operations](#)<sup>[569]</sup>, or methods) or *StructuralFeatures* ([Ports](#)<sup>[826]</sup>, [Parts](#)<sup>[825]</sup> and [attributes](#)<sup>[558]</sup>).

Feature elements are available from the **Requirements** page of the **Toolbox**.

#### Note:

Feature elements can be created with or without an identifying **F** in the top right corner of the element. To toggle the display of this letter, select or deselect the **Show stereotype icon for requirements** checkbox on the **Options** dialog, [Objects](#)<sup>[362]</sup> page.

## Toolbox Icon



### 5.1.2.3.8 Hyperlinks



You can place a *Hyperlink* element onto a diagram. This element is a type of text element, but one that can contain a pointer to a range of objects such as associated document files, web pages, Help, model features and even other Enterprise Architect model files. When you double-click on the element, Enterprise Architect executes the link. To add a Hyperlink element, drag the *Hyperlink* icon from the **Common** page of the **Toolbox** onto the diagram.

(Alternatively, click on the **Hyperlink** icon in the **UML Elements** toolbar and then click on the diagram.)



## Configure the Hyperlink

When you add the Hyperlink to the diagram, the **Hyperlink Details** dialog displays. If you want to display the information in a more readable layout, you can resize the dialog.

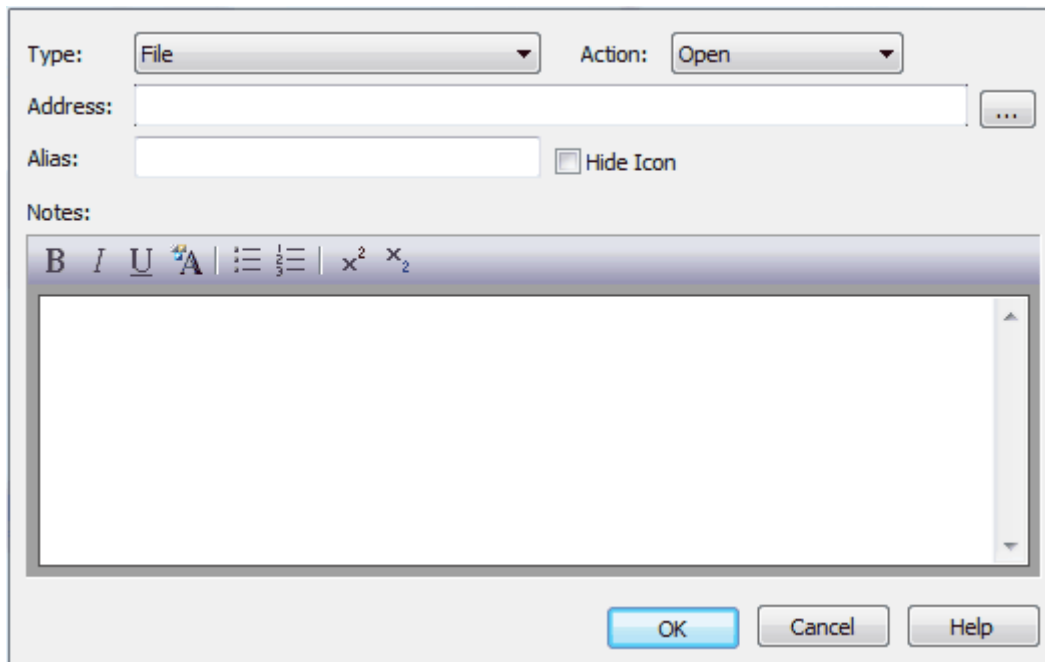

You first select the type of object to link to, by clicking on the drop-down arrow in the **Hyperlink Type** field. The **Hyperlink Details** dialog displays the appropriate fields, prompts or dialog to enable you to specify the object to link to. For example, if you intend to hyperlink to:

- an attribute, the [Set Attribute dialog](#)<sup>[748]</sup> displays to enable you to select that attribute
- a file, the **Action** field displays to enable you to specify whether to **Open** the file in read only mode, or **Edit** the file; in either case the file is opened within Enterprise Architect if possible, or, if not possible, with the Windows default viewer/editor for the file type. For example, if you hyperlink to a .rtf file, you can *view* it in whichever viewer is appropriate; however, you cannot *edit* .rtf files in Enterprise Architect, so the file always opens in the *Windows* default .rtf editor.
- a diagram, the **Select a Diagram** dialog displays, which enables you to select the diagram from anywhere in the project; you can filter the selection to diagrams of certain types.

If you select **EA Command**, the **Hyperlink Address** field changes to a drop-down list of Enterprise Architect commands. You can select **LocalPath** and click on the [ ... ] (Browse) button to display the [Local Paths](#)<sup>[1343]</sup> dialog, which you complete as required. Subsequently, when you click on the hyperlink the **Local Paths** dialog immediately displays and you can apply, switch, expand or update the current path.

Once you have defined the object and its location, you can change the location either by overtyping the **Hyperlink Address** field or by clicking on the [ ... ] (Browse) button.

In the **Alias** field, type the text to display in the hyperlink. If you do not provide an alias, either the text defaults to the link itself, or (for certain link targets such as a matrix profile) the dialog generates a simple text instruction.

If you prefer to display only the hyperlink text, without the icon, select the **Hide Icon** checkbox.

**Notes:**

- If required, you can create a number of empty hyperlinks to complete later. If you then double-click on an empty hyperlink, the **Hyperlink Details** dialog displays and you can enter the details.
- Once you have created the hyperlink, you can also edit the hyperlink text by clicking once on the field and once on the text, then right-clicking and selecting the **Edit Selected** context menu option.

Note that you can add notes to the hyperlink, which display in the **Hyperlink Details** dialog when you right-click on the hyperlink and select the **Properties** context menu option. You can format these notes using the **Notes** toolbar.

You can also create:

- [A hyperlink to a file](#)
- [A hyperlink to a script](#)
- [An Action as a hyperlink](#)
- [A hyperlink between diagrams.](#)

#### 5.1.2.3.8.1 Hyperlinks To Files

To create a hyperlink on a diagram to an external file, simply click on the file in a file list (such as Windows Explorer) or on your Desktop and drag it onto the diagram.

A short context menu displays with two options - **Hyperlink** and **Artifact**. Click on the **Hyperlink** option to create the hyperlink on the diagram.

The link is effective immediately, and you can right-click on it to add or change properties as described above.

#### 5.1.2.3.8.2 Script Hyperlinks

You can create a hyperlink on a diagram to execute a script. Simply open the **Debug** window and drag the required script onto the diagram. A context menu displays, from which you select whether the script to be executed is a Build, Test, Run, Debug or Deploy script. The hyperlink is effective immediately; when you click on it, the script executes.

#### 5.1.2.3.8.3 Add Action As Hyperlink

You can create an **Action** element to represent a wide range of behaviors and actions, including a hyperlink. To do this, follow the steps below:

1. Drag an Action element from the **Activity** page of the **Toolbox** onto the diagram. A context menu immediately displays.
2. Select the **Other** menu option. The **New Action** dialog displays, with the **Other** radio button selected.
3. Click on the drop down arrow on the field in the **Select kind** panel, and click on **Hyperlink**.
4. Click on the **OK** button. The **Hyperlink Action** element displays on the diagram.
5. Right click on the element and select the **Advanced | Set Hyperlink** menu option. The **Hyperlink Details** dialog displays.
6. Set the hyperlink's properties as described above.

#### 5.1.2.3.8.4 Hyperlinks Between Diagrams

To create a hyperlink between diagrams, follow the steps below.

**Note:**

If the hyperlink appears as a Sub Activity, select the **Tools | Options | Diagram | Behavior** menu option and deselect the **Use Automatic SubActivities** checkbox.

1. Open the diagram in which to display the hyperlink to another diagram. From the **Project Browser** select the diagram you want to create a hyperlink to.

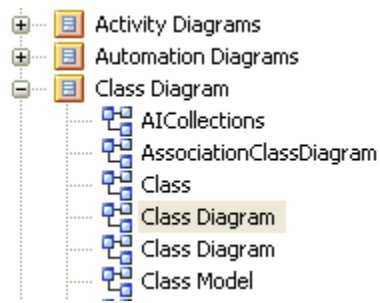

2. Drag the diagram on to the current diagram. The **Select Type** dialog displays.

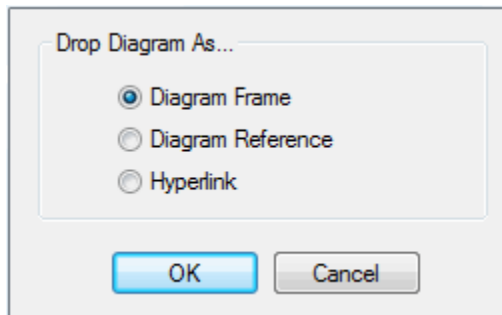

3. Select the **Hyperlink** option and click on the **OK** button. The final hyperlinked diagram should resemble the diagram below, where the *Class* diagram is the diagram to which the *Product Order* diagram hyperlinks (notice that the hyperlink icon is different).

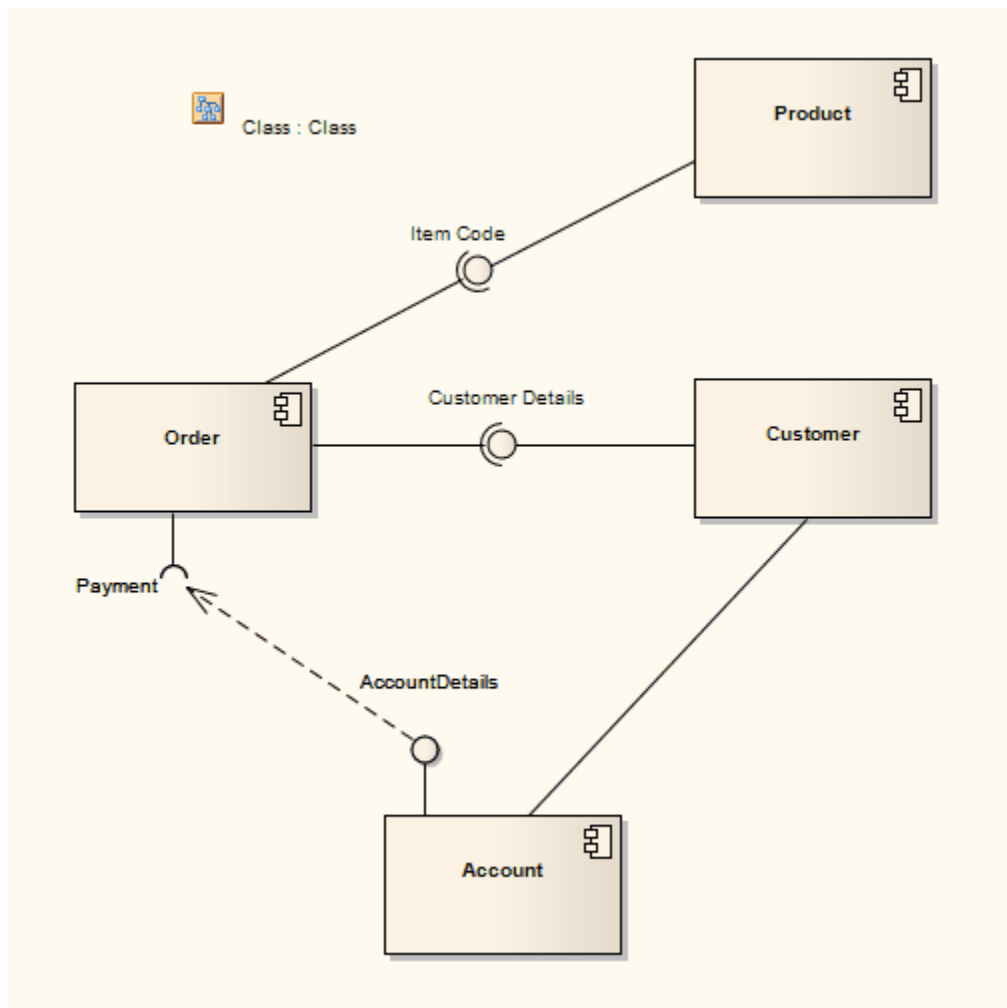

### 5.1.2.3.9 N-Ary Association



An *n*-Ary Association element is used to model complex relationships between three or more elements, typically in a [Class diagram](#) <sup>[72]</sup>. It is not a commonly-employed device, but can be used to good effect where there is a dependant relationship between several elements. It is generally used with the [Associate](#) <sup>[85]</sup> connector, but the relationships can include other types of connector.



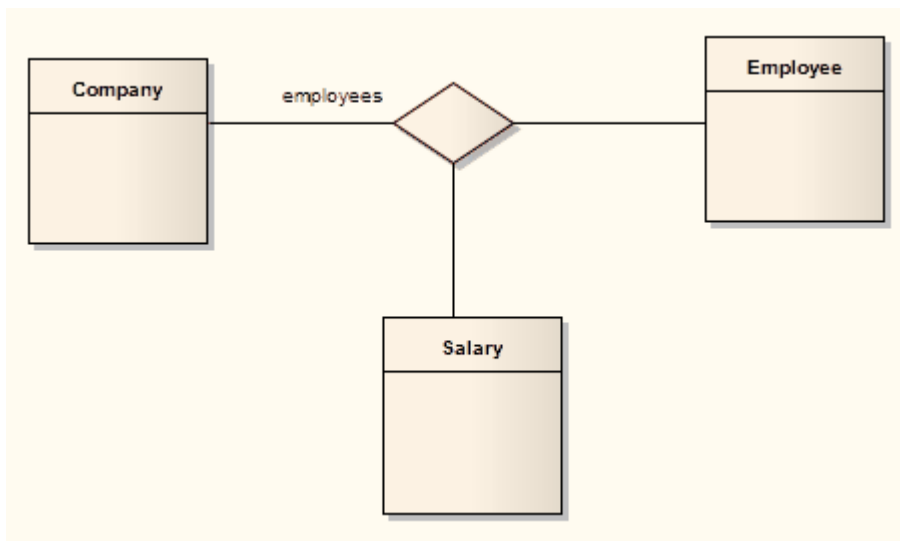

In the example above there is a relationship between a *Company*, an *Employee* and a *Salary*.

### Toolbox Icon

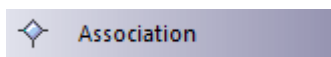

#### 5.1.2.3.10 Packaging Component

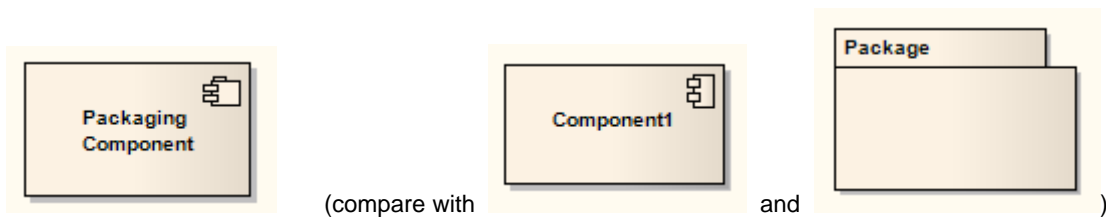

A *Packaging Component* is an element that appears very similar to a [Component](#)<sup>[816]</sup> in a diagram but behaves as a [Package](#)<sup>[825]</sup> in the **Project Browser** (that is, it can be version controlled and can contain other Packages and elements). It is typically used in [Component diagrams](#)<sup>[730]</sup>.

In the **Project Browser**, the three elements display as shown below:

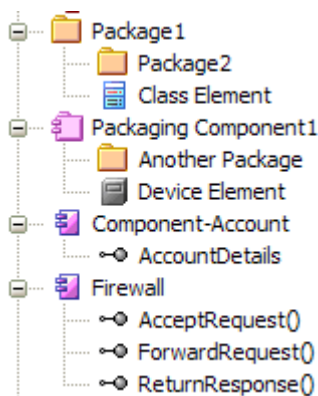

The Component element cannot contain child Packages or Packaging Components.

## Toolbox Icon

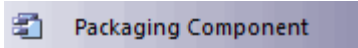

### 5.1.2.3.11 Process

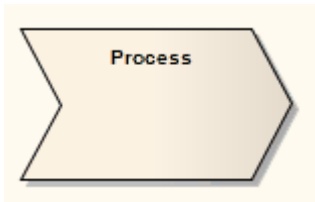

A *Process* is an [Activity](#)<sup>[753]</sup> element with the stereotype **process**, which expresses the concept of a business process. Typically this involves inputs, outputs, work flows, goals and connections with other Processes. The Process element is typically used in [Analysis diagrams](#)<sup>[735]</sup>.

Business processes typically range across many parts of the organization and span one or more systems.

## Toolbox Icon



### 5.1.2.3.12 Requirements

As an analysis step, often it is desirable to capture simple *system requirements*. These are eventually realized by [Use Cases](#)<sup>[806]</sup>.

In the initial requirement gathering phase, cataloging requirements can be achieved using the *Requirement* extension on a [Custom diagram](#)<sup>[734]</sup>.

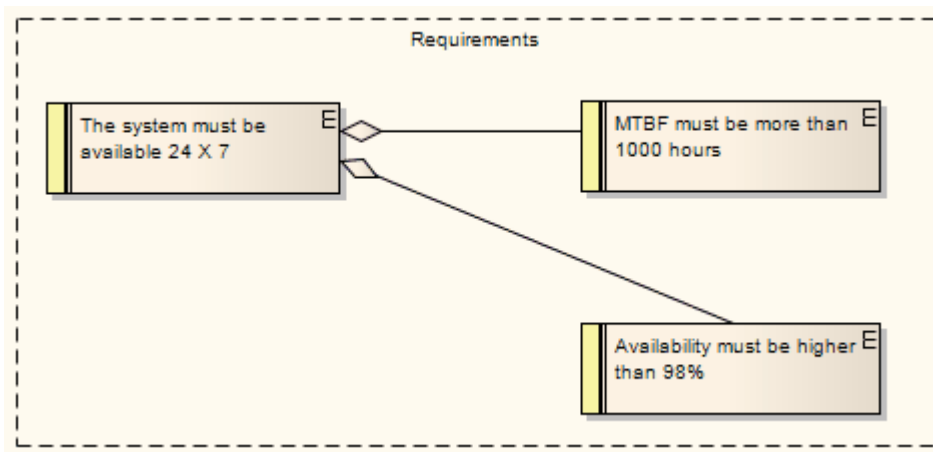

Requirements can also be aggregated to create a hierarchy. The diagram below illustrates how this might be done.

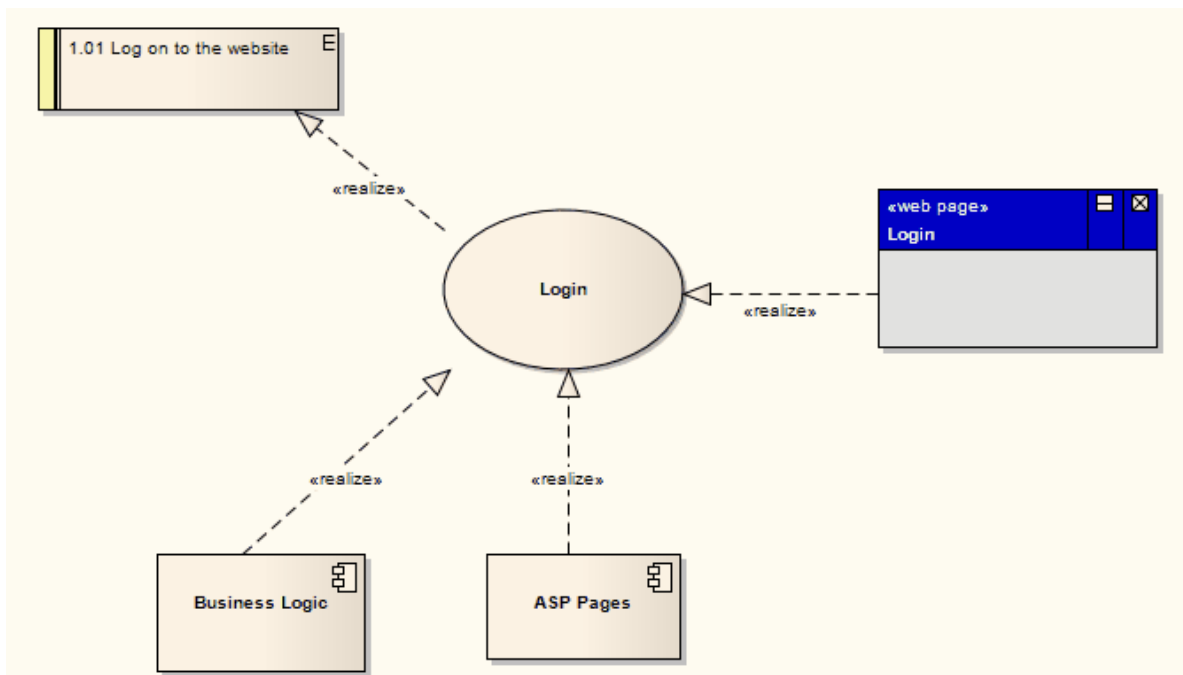

A requirement that a user can log into a website is implemented by the *Login* Use Case, which in turn is implemented by the *Business Logic*, *ASP Pages* and *Login Web Page*. Using this approach, you can easily model quite detailed and complex dependencies and implementation relationships.

#### Notes:

- External requirements can be created with or without an identifying **E** in the top right corner of the element. To toggle the display of this letter, select or deselect the **Show stereotype icon for requirements** checkbox on the **Options** dialog, [Objects](#)<sup>[362]</sup> page.
- The colors on Requirement elements identify the status of the requirement. You change the status - and hence color - on the element [Properties](#)<sup>[919]</sup> dialog. You set the color for each status on the [Status Types](#)<sup>[653]</sup> dialog.

### Toolbox Icon

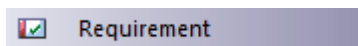

#### 5.1.2.3.13 Screen

A *Screen* is used to prototype User Interface screen flow. By using UML features such as requirements, constraints and scenarios against [User Interface](#)<sup>[738]</sup> diagram elements, you can build up a solid and detailed understanding of user interface behavior without having to use code. This becomes an excellent means of establishing the precise behavior the system has from a user perspective, and in conjunction with the [Use Case](#)<sup>[378]</sup> model, defines exactly how a user gets work done.

Web pages can also be prototyped and specified rigorously using Enterprise Architect's custom interface extensions.

The example diagram below illustrates some features of Enterprise Architect's screen modeling extensions that support web page prototyping. By adding requirements, rules, scenarios and notes to each element, a detailed model is built up of the form or web page, without having to resort to GUI builders or HTML.

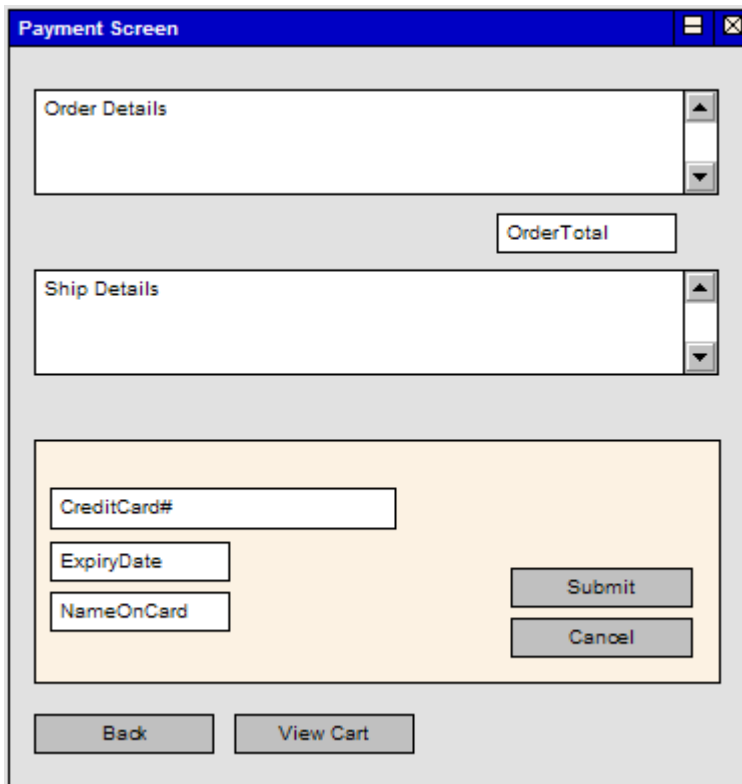
**Note:**

Enterprise Architect displays [UI Controls](#) <sup>[849]</sup> as a range of special icons, depending on the stereotype used; for example, a Control stereotyped as a «list» displays with a vertical scroll bar.

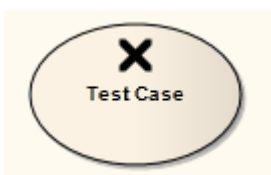
**Toolbox Icon****5.1.2.3.14 Test Case**

A *Test Case* is a stereotyped [Use Case](#) <sup>[806]</sup> element. You might use it to extend the facilities of the [Testing](#) <sup>[1537]</sup> window, by applying element properties and capabilities to the tests of a feature represented by another element or - more appropriately - set of elements. That is, you can define in one go - in the [Testing](#) window for the *Test Case* element - the details of the tests that apply to each of several elements, instead of recording the details separately in each element.

Within the *Test Case* element properties you can define test requirements and constraints, and associate the test with test files. You can also link the element to Document Artifacts or (in the Corporate, Business and Software Engineering, System Engineering and Ultimate editions) directly to linked documents, such as a Test Plan.

The *Test Case* element enables you to give greater visibility to tests, in the [Project Browser](#), [Element List](#), [Model Search](#), [Relationship Matrix](#), [Traceability](#) window and reports.

The *Test Case* element is available through the [Use Case](#) and [Maintenance](#) pages of the [Toolbox](#).

### 5.1.2.3.15 Table



A *Table* is a stereotyped [Class](#)<sup>[81†]</sup>. It is drawn with a small table icon in the upper right corner. You typically use this element in [Data Modeling](#)<sup>[739†]</sup> and [Class](#)<sup>[72†]</sup> diagrams.

A Table element has a special **Properties** dialog, with settings for database type and the ability to set column information and data-related operations such as triggers and indexes. When setting up a Table, make sure you [set the default database type](#)<sup>[1014†]</sup> for that Table, otherwise you do not have any data types to choose from when creating columns.

### Toolbox Icon



### 5.1.2.3.16 UI Control Element

A *UI Control element* represents a user interface control element (such as an edit box). It is used for capturing the components of a [screen](#)<sup>[847†]</sup> layout and requirements in a [Custom](#)<sup>[734†]</sup> or [User Interface](#)<sup>[738†]</sup> diagram.

There are a number of UI Control elements available in the [User Interface](#)<sup>[419†]</sup> page of the **Toolbox**. These include:

- List
- Table
- Text Box
- Label
- Form
- Panel
- Button
- Combobox
- Checkbox
- Checkbox (left hand side)
- Radio button
- Radio button (left hand side)
- Vertical Line
- Horizontal Line.

The icons can be combined on a Screen icon to represent the appearance of a user interface screen, as shown:

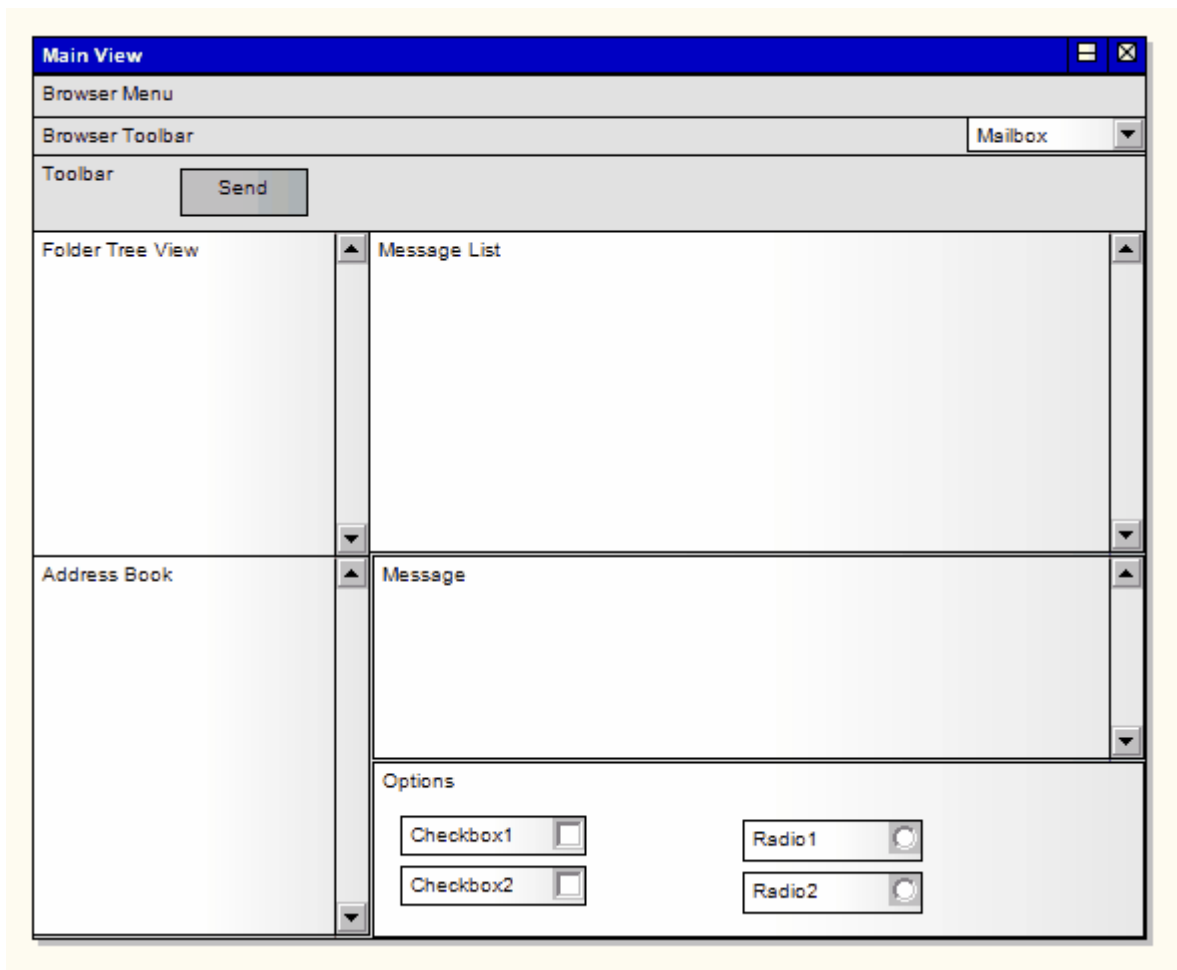

You can also extend the available icons by selecting other stereotypes in the UI Control Element **Properties** dialog. The full set of available stereotypes is shown below; type or select the text in the **Stereotype** field to create the corresponding icon.

ui User Interface

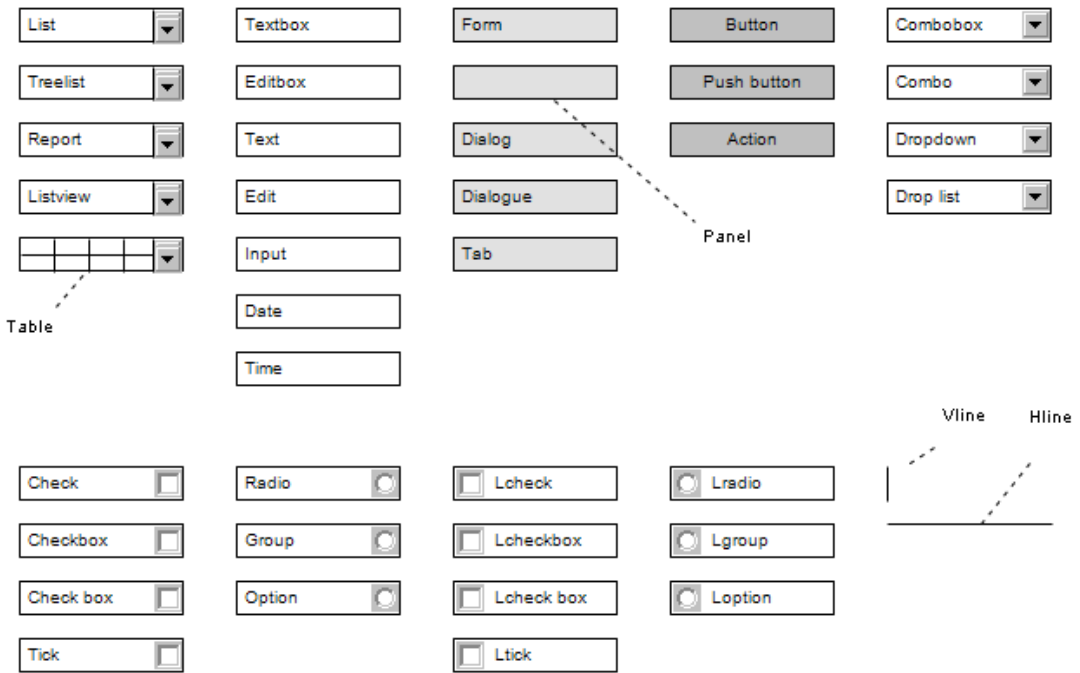

Toolbox Icon



5.1.2.3.17 Web Stereotypes

Enterprise Architect supports a number of stereotypes for web page modeling, the graphical elements for which display with a **graphical icon** instead of the usual «stereotype» format. These stereotypes are only supported for [Class](#)<sup>[811]</sup> elements. The image below indicates the various graphical icons and their associated stereotypes.

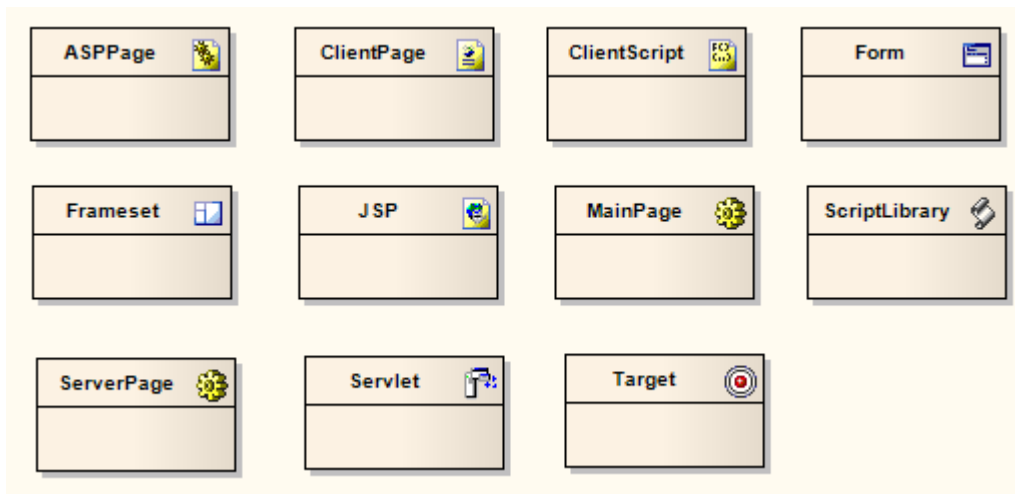

A similar set of web modeling elements and their relationships are also available through dedicated **Web Modeling** pages in the [Toolbox](#)<sup>[399]</sup>.

## Set a Web Icon

To set a web icon, follow the steps below:

1. Create a new Class element in a diagram.
2. Display the Class **Properties** dialog.
3. In the **Stereotype** field, either type in the required stereotype name or click on the drop-down arrow and select the required stereotype (as named above).
4. Click on the **OK** button. The Class displays as in one of the examples above.

### 5.1.3 UML Connectors



















#### What is a Connector?

A *connector* is a logical or functional relationship between model elements. There are several different connector types, each having a particular purpose and syntax. Enterprise Architect supports all of the UML connectors as well as various custom connectors. Together with the [UML Elements](#)<sup>[74]</sup>, these form the basis of UML models.

For more information on using these connectors, consult the appropriate topic by clicking on the required connector icon in the table below.

#### Notes:

- *Invokes* and *Precedes* relationships are defined by the Open Modeling Language (OML). They are stereotyped *Dependency* relationships; *Invokes* indicates that Use Case A, at some point, causes Use Case B to happen, whilst *Precedes* indicates that Use Case C must complete before Use Case D can begin.
- An *Extension* relationship shows that a stereotype extends one or more metaclasses. All stereotypes must extend either one or more Metaclasses, or another stereotype that extends a stereotype (that itself extends a stereotype, and so on).
- A *Tagged Value* relationship defines a reference-type (that is, RefGUID) Tagged Value owned by the source stereotype. The Tagged Value is named for the target role of this association, and is limited to referencing elements with the stereotype by the association target element.
- The *Application* and *Redefinition* relationships are **deprecated**.

Behavioral Diagram Connectors	Structural Diagram Connectors	Inbuilt and Extended Connectors
<b>Activity Diagrams</b>  Control Flow  Object Flow  Interrupt Flow	<b>Composite Structure Diagrams</b>  Connector  Assembly  Delegate  Role Binding  Represents  Occurrence	<b>Analysis Diagrams</b>  Information Flow  Object Flow  Associate  Realize  Representation
<b>Use Case Diagrams</b>  Use  Associate  Generalize	<b>Package and Class Diagrams</b>	<b>Common Connectors</b>  Dependency



Behavioral Diagram Connectors	Structural Diagram Connectors	Inbuilt and Extended Connectors
Include	Associate	Realize
Extend	Generalize	Trace
Realize	Compose	Information Flow
Invokes	Aggregate	Note Link
Precedes	Association Class	
	Assembly	<a href="#">Profile</a> <sup>[906]</sup>
<b>State Diagrams</b>	Realize	Extension
Transition	Nesting	Generalize
Object Flow	Package Merge	Application
	Package Import	Tagged Value
<b>Timing Diagrams</b>		Redefinition
Message	<b>Component Diagrams</b>	
	Assembly	<a href="#">Metamodel</a> <sup>[1380]</sup>
<b>Sequence Diagrams</b>	Delegate	Generalize
Message	Associate	Associate
Self-Message	Realize	Compose
Recursion	Generalize	Aggregate
Call		
	<b>Deployment Diagrams</b>	<b>Custom</b>
<b>Communication Diagrams</b>	Associate	Associate
Associate	Communication Path	Aggregate
Realize	Association Class	Generalize
Nesting	Generalize	Realize
	Realize	Nesting
<b>Interaction Overview Diagrams</b>	Deployment	

Behavioral Diagram Connectors	Structural Diagram Connectors	Inbuilt and Extended Connectors
<ul style="list-style-type: none"> <li>Control Flow</li> <li>Object Flow</li> <li>Interrupt Flow</li> </ul>	<ul style="list-style-type: none"> <li>Manifest</li> <li>Nesting</li> </ul> <p><b>User Interface</b></p> <ul style="list-style-type: none"> <li>Associate</li> <li>Aggregate</li> <li>Generalize</li> <li>Realize</li> </ul> <p><b>Object</b></p> <ul style="list-style-type: none"> <li>Information Flow</li> <li>Associate</li> <li>Dependency</li> </ul>	<p><b>Requirements</b></p> <ul style="list-style-type: none"> <li>Aggregate</li> <li>Inheritance</li> <li>Associate</li> <li>Implements</li> </ul> <p><b>WSDL</b></p> <p>No special connectors</p> <p><b>Documentation</b></p> <p>No special connectors</p>
<p><b>Maintenance</b></p> <ul style="list-style-type: none"> <li>Aggregate</li> </ul>		
<p><b>XML Schema</b></p> <ul style="list-style-type: none"> <li>Generalize</li> <li>Associate</li> </ul>		
<p><b>Data Modeling</b></p> <ul style="list-style-type: none"> <li>Associate</li> </ul>		

### 5.1.3.1 Aggregate

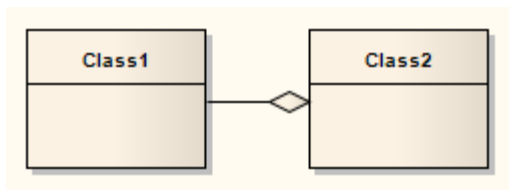

An *Aggregation* connector is a type of association that shows that an element contains or is composed of other elements. It is used in [Class models](#)<sup>[721]</sup>, [Package models](#)<sup>[720]</sup> and [Object models](#)<sup>[723]</sup> to show how more complex elements (aggregates) are built from a collection of simpler elements (component parts; for example, a car from wheels, tires, motor and so on).

A stronger form of aggregation, known as Composite Aggregation, is used to indicate ownership of the whole over its parts. The part can belong to only one Composite Aggregation at a time. If the composite is deleted, all of its parts are deleted with it.

After drawing an Aggregation association, its [form can be changed](#)<sup>[855]</sup>.

#### Toolbox Icon

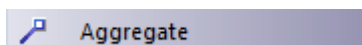

### 5.1.3.1.1 Change Aggregation Connector Form

In Enterprise Architect, the default [Aggregation relationship](#)<sup>[854]</sup> is the weak form of the relationship, represented by a hollow diamond. To change the form of an Aggregation connector from weak to strong, follow the steps below.

1. Right-click on an Aggregation connector to display the context menu.
2. Select **Set Aggregation to Composite**. The diamond is shown as filled.

#### Note:

If the connector is already a Strong (Composition) connector, the context menu option changes to **Set Aggregation to Shared**.

### 5.1.3.2 Assembly

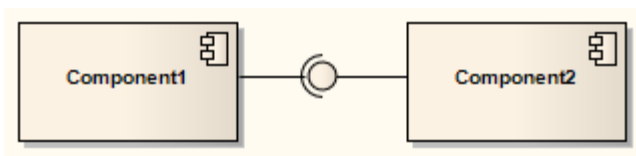

An *Assembly* connector bridges a component's required [interface](#)<sup>[820]</sup> (Component1) with the provided interface of another component (Component2), typically in a [Component diagram](#)<sup>[730]</sup>.

#### Toolbox Icon

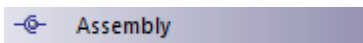

#### OMG UML Specification

The OMG UML specification (*UML Superstructure Specification, v2.1.1, p. 156*) states:

*An assembly connector is a connector between two components that defines that one component provides the services that another component requires. An assembly connector is a connector that is defined from a required interface or port to a provided interface or port.*

### 5.1.3.3 Associate

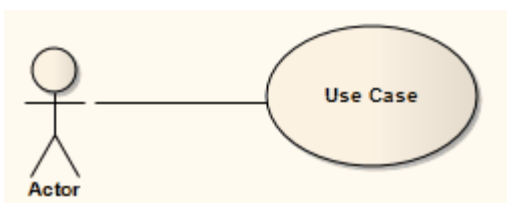
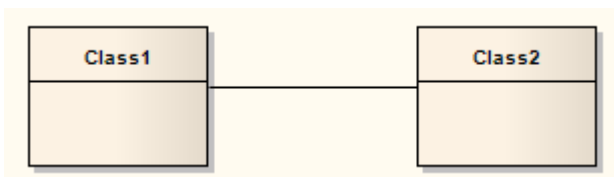

An *Association* implies two model elements have a relationship, usually implemented as an instance variable in one [Class](#)<sup>[811]</sup>. This connector can include named roles at each end, multiplicity, direction and constraints. Association is the general relationship type between elements. To connect more than two elements in an association, you can use the [N-Ary Association](#)<sup>[844]</sup> element.

When code is generated for [Class diagrams](#)<sup>[721]</sup>, Associations become instance variables in the target Class.

The relationship is also used in [Package](#), [Object](#), [Communication](#), [Data Modeling](#) and [Deployment](#) diagrams.

An Associate connector can also be integrated with a Class element to form an [Association Class](#), to allow the Associate connector to have operations and attributes that define certain types of UML relationship.

## Toolbox Icon

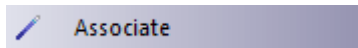

## OMG UML Specification

The OMG UML specification (*UML Superstructure Specification, v2.1.1, p. 41*) states:

*An association specifies a semantic relationship that can occur between typed instances. It has at least two ends represented by properties, each of which is connected to the type of the end. More than one end of the association may have the same type.*

*An end property of an association that is owned by an end class or that is a navigable owned end of the association indicates that the association is navigable from the opposite ends; otherwise, the association is not navigable from the opposite ends.*

### 5.1.3.4 Association Class

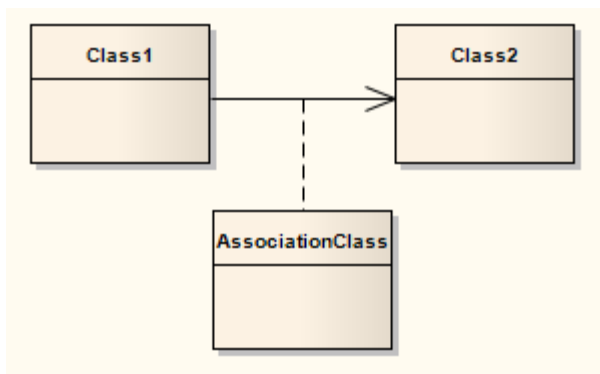

An *Association Class* connector is a UML construct that enables an [Associate](#) connector to have [attributes](#) and [operations](#) (*features*). This results in a hybrid relation with the characteristics of a connection and a [Class](#). It is used to model particular types of connections in UML (see the [OMG UML Specification](#) for more details).

When you add an Association Class connection, Enterprise Architect also creates a Class that is automatically connected to the Association. When you hide or delete the Association, the Class is also hidden or deleted.

To add an Association Class to a [Class](#) or [Deployment](#) diagram, click on the *Association Class* icon in the **Toolbox**. Click and hold on the source object in the diagram while you drag the line to the target element, then release the mouse button. Enterprise Architect draws the connector and adds the Class, then prompts you to add the Class name. Note that the names of the Class and the connector are the same. You can also [connect a new Class to an existing Association](#).

The following diagram illustrates an Association Class between model elements. Note the dotted line from the Class to the Association. You cannot move or delete this line.

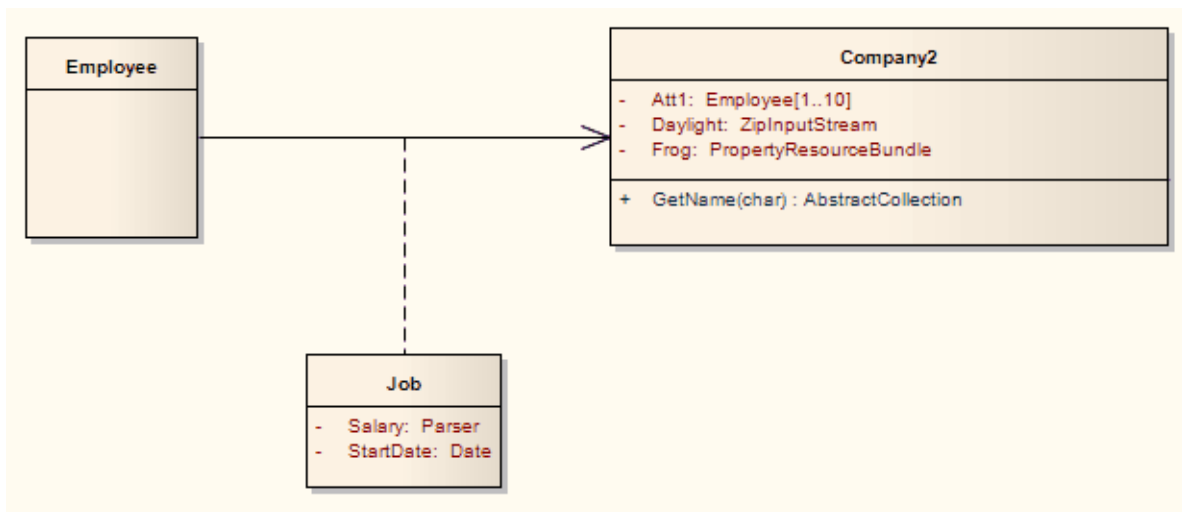
**Note:**

If you are applying a stereotype with a [Shape Script](#) <sup>[1104]</sup> to an Association Class, be aware that the Shape Script is applied to both the Class part and the Association part. Therefore, you might have to include logic in the *shape main* that tests the type of the element so that you can give separate drawing instructions for Class and for Association. Such logic is not necessary in the:

- *shape source* or *shape target*, which are ignored by Classes, or the
- *decoration* shapes, which are ignored by Associate connectors.

If you dis-associate the Class from the Associate connector, both parts keep their Shape Scripts until the stereotypes are removed.

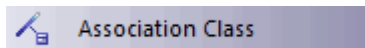
**Toolbox Icon****OMG UML Specification**

The OMG UML specification (*UML Superstructure Specification, v2.1.1, p. 49*) states:

*A model element that has both association and class properties. An AssociationClass can be seen as an association that also has class properties, or as a class that also has association properties. It not only connects a set of classifiers but also defines a set of features that belong to the relationship itself and not to any of the classifiers.*

**5.1.3.4.1 Connect New Class to Association**

To connect a new Class to an existing Association, follow the steps below:

1. Create a Class in the diagram containing the Association to connect.
2. Right-click on the new Class. The context menu displays.
3. Select the **Advanced** | [Association Class](#) <sup>[856]</sup> menu option. The **Create Association Class** dialog displays.

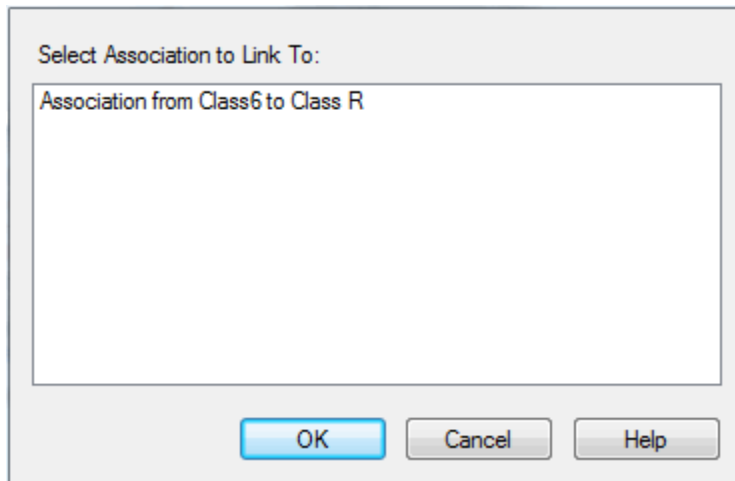

4. Select the connector to connect to.
5. Click on the **OK** button.

### 5.1.3.5 Communication Path

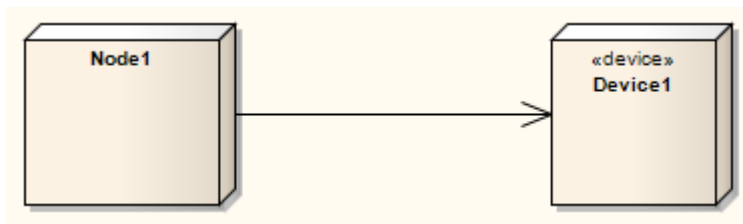

A *Communication Path* defines the path through which two *DeploymentTargets* are able to exchange signals and messages. Communication Path is a specialization of [Association](#)<sup>[855]</sup>. A *DeploymentTarget* is the target for a deployed [Artifact](#)<sup>[810]</sup> and can be a [Node](#)<sup>[822]</sup>, [Property](#) or [InstanceSpecification](#)<sup>[818]</sup> in a [Deployment diagram](#)<sup>[727]</sup>.

#### Toolbox Icon

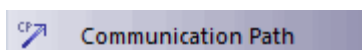

### 5.1.3.6 Compose

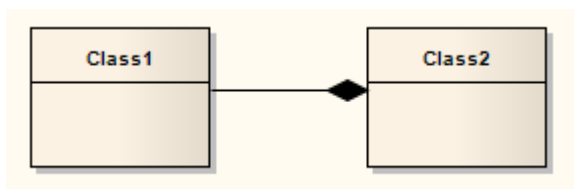

A *Composite Aggregation*<sup>[854]</sup> is used to depict an element that is made up of smaller components, typically in a [Class](#)<sup>[721]</sup> or [Package](#)<sup>[720]</sup> diagram. A component - or part instance - can be included in a maximum of one composition at a time. If a composition is deleted, usually all of its parts are deleted with it; however, a part can be individually removed from a composition without having to delete the entire composition. Compositions are transitive, asymmetric relationships and can be recursive.

See the example below.

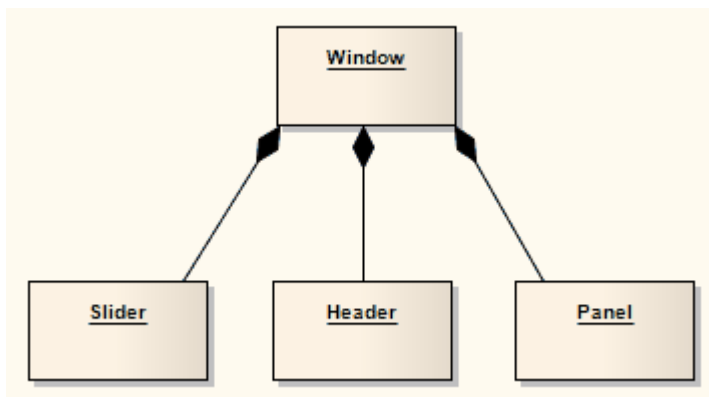

### Toolbox Icon

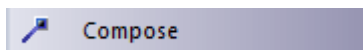

### OMG UML Specification

The OMG UML specification (*UML Superstructure Specification, v2.1.1, p. 43*) states:

*Composite aggregation is a strong form of aggregation that requires a part instance be included in at most one composite at a time. If a composite is deleted, all of its parts are normally deleted with it.*

#### 5.1.3.7 Connector

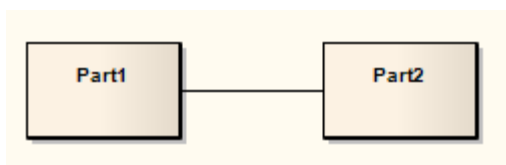

*Connectors* illustrate communication links between parts to fulfill the structure's purpose, typically in a [Composite Structure](#) diagram. Each Connector end is distinct, controlling the communication pertaining to its connecting element. These elements can define constraints specifying this behavior. Connectors can have multiplicity.

### Toolbox Icon

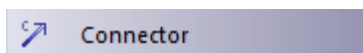

### OMG UML Specification

The OMG UML specification (*UML Superstructure Specification, v2.1.1, p. 177*) states:

*Specifies a link that enables communication between two or more instances. This link may be an instance of an association, or it may represent the possibility of the instances being able to communicate because their identities are known by virtue of being passed in as parameters, held in variables or slots, or because the communicating instances are the same instance. The link may be realized by something as simple as a pointer or by something as complex as a network connection. In contrast to associations, which specify links between any instance of the associated classifiers, connectors specify links between instances playing the connected parts only.*

### 5.1.3.8 Control Flow

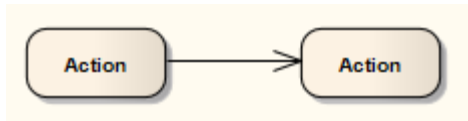

The *Control Flow* is a connector connecting two nodes in an [Activity diagram](#)<sup>[674]</sup>. Control Flow connectors bridge the flow between Activity nodes, by directing the flow to the target node once the source node's activity is completed.

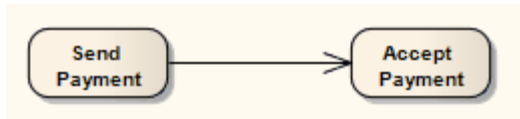

Control Flows and *Object Flows* can define a *Guard* and a *Weight* condition.

A *Guard* defines a condition that must be true before control passes along that activity edge. A practical example of this is where two or more activity edges (Control Flows) exit from a [Decision](#)<sup>[765]</sup> element. Each flow should have a Guard condition that is exclusive of the other and defines which edge is taken under what conditions. The Control Flow **Properties** dialog enables you to set up Guard conditions on Control Flows and on Object Flows.

A *Weight* defines the number of tokens that can flow along a Control or Object Flow connection when that edge is traversed. Weight can also be defined on the Control Flow and Object Flow **Properties** dialogs.

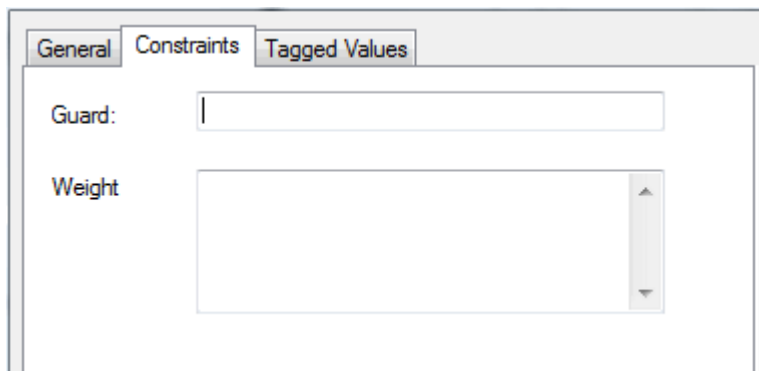

#### Toolbox Icon

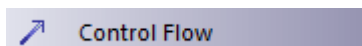

#### OMG UML specification:

The OMG UML specification (*UML Superstructure Specification, v2.1.1, p. 356*) states:

*A control flow is an edge that starts an activity node after the previous one is finished.*



### 5.1.3.9 Delegate

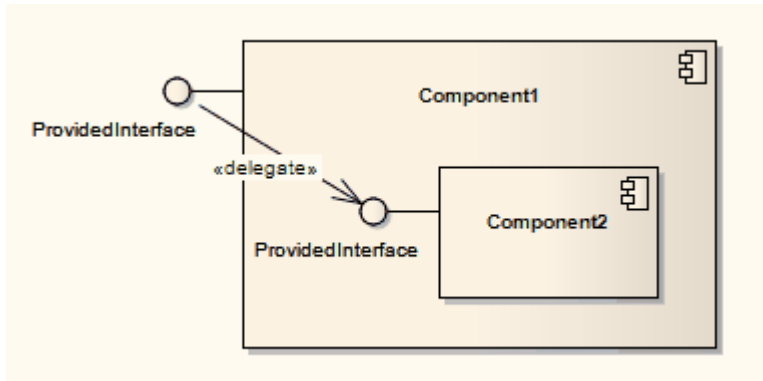

A *Delegate* connector defines the internal assembly of a component's external [Ports](#)<sup>[826]</sup> and [Interfaces](#)<sup>[821]</sup>, on a [Component diagram](#)<sup>[730]</sup>. Using a Delegate connector wires the internal workings of the system to the outside world, by a delegation of the external interfaces' connections.

#### Toolbox Icon

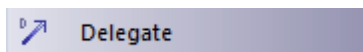

#### OMG UML Specification

The OMG UML specification (*UML Superstructure Specification, v2.1.1, p. 156*) states:

*A delegation connector is a connector that links the external contract of a component (as specified by its ports) to the internal realization of that behavior by the component's parts. It represents the forwarding of signals (operation requests and events): a signal that arrives at a port that has a delegation connector to a port or to another port will be passed on to that target for handling.*

### 5.1.3.10 Dependency

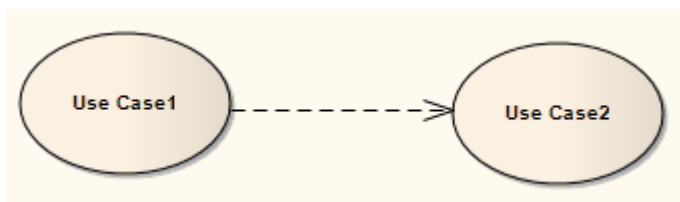
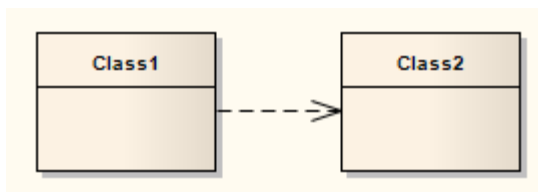

*Dependency relationships* are used to model a wide range of dependent relationships between model elements in [Use Case](#)<sup>[676]</sup>, [Activity](#)<sup>[753]</sup> and [Structural](#)<sup>[719]</sup> diagrams, and even between models themselves. You can create the Dependency from the [Common](#)<sup>[405]</sup> page of the [Toolbox](#). The Dependencies package as defined in UML 2.3 has many derivatives, such as [Realize](#)<sup>[889]</sup>, [Deployment](#)<sup>[862]</sup> and [Use](#)<sup>[894]</sup>. Once you create a Dependency you can further refine its meaning by [applying a specialized stereotype](#)<sup>[862]</sup>.

## Toolbox Icon

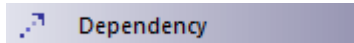

## OMG UML Specification

The OMG UML specification (*UML Superstructure Specification, v2.1.1, p. 64*) states:

*A dependency is a relationship that signifies that a single or a set of model elements requires other model elements for their specification or implementation. This means that the complete semantics of the depending elements is either semantically or structurally dependent on the definition of the supplier element(s).*

### 5.1.3.10.1 Apply a Stereotype

To apply a stereotype to a [Dependency](#)<sup>[86†]</sup> relationship, follow the steps below:

1. Select the Dependency relationship to change.
2. Right-click on the connector and, from the context menu, select the **Dependency Properties** option. The **Dependency Properties** dialog displays.
3. In the **Stereotype** field, either type in the required stereotype name or click on the drop-down arrow and select the stereotype from the list.
4. Click on the **OK** button.

Alternatively, you can right-click on the Dependency relationship and select the **Advanced | Dependency Stereotypes** context menu option, then select from a shorter list of standard stereotypes.

### 5.1.3.11 Deployment

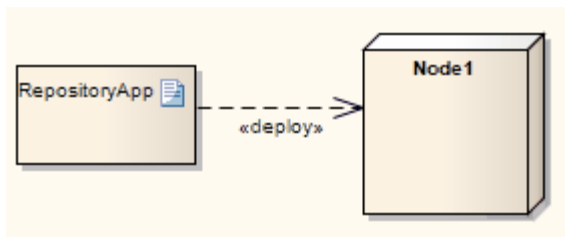

A *Deployment* is a type of [Dependency](#)<sup>[86†]</sup> relationship that indicates the deployment of an artifact onto a node or executable target, typically in a [Deployment diagram](#)<sup>[72†]</sup>. A Deployment can be made at type and instance levels. At the type level, a Deployment would be made for every instance of the node. Deployment can also be specified for an instance of a node, so that a node's instances can have varied deployed artifacts. With composite structures modeled with nodes defined as [Parts](#)<sup>[825†]</sup>, Parts can also serve as targets of a Deployment relationship.

## Toolbox Icon

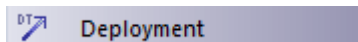

### 5.1.3.12 Extend

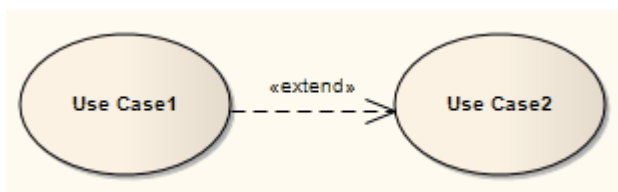

An *Extend* connection is used to indicate that an element extends the behavior of another. Extensions are

used in [Use Case models](#)<sup>[676]</sup> to indicate that one [Use Case](#)<sup>[806]</sup> (optionally) extends the behavior of another. An extending Use Case often expresses alternative flows.

### Toolbox Icon



### OMG UML Specification

The OMG UML specification (*UML Superstructure Specification, v2.1.1, p. 587*) states:

*This relationship specifies that the behavior of a Use Case may be extended by the behavior of another (usually supplementary) Use Case. The extension takes place at one or more specific extension points defined in the extended Use Case. Note, however, that the extended Use Case is defined independently of the extending Use Case and is meaningful independently of the extending Use Case. On the other hand, the extending Use Case typically defines behavior that may not necessarily be meaningful by itself. Instead, the extending Use Case defines a set of modular behavior increments that augment an execution of the extended Use Case under specific conditions.*

*Note that the same extending Use Case can extend more than one Use Case. Furthermore, an extending Use Case may itself be extended.*

#### 5.1.3.13 Generalize

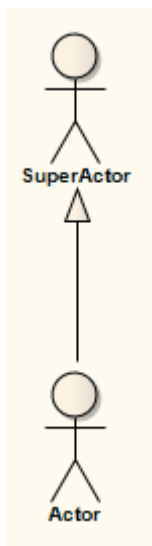

A *Generalize* is used to indicate inheritance. Drawn from the specific classifier to a general classifier, the generalize implication is that the source inherits the target's characteristics. It is used typically in [Class](#)<sup>[721]</sup>, [Component](#)<sup>[730]</sup>, [Object](#)<sup>[723]</sup>, [Package](#)<sup>[720]</sup>, [Use Case](#)<sup>[676]</sup> and [Requirements](#)<sup>[736]</sup> diagrams.

### Toolbox Icon

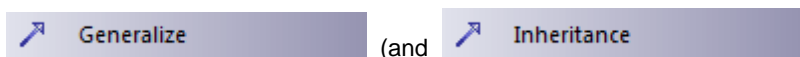

### OMG UML Specification

The OMG UML specification (*UML Superstructure Specification, v2.1.1, p. 73*) states:

*A generalization is a taxonomic relationship between a more general classifier and a more specific classifier. Each instance of the specific classifier is also an indirect instance of the general classifier. Thus, the specific classifier inherits the features of the more general classifier.*

### 5.1.3.14 Include

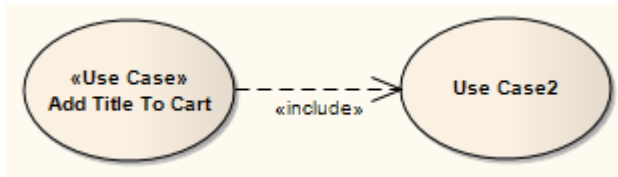

An *Include* connection indicates that the source element includes the functionality of the target element. Include connections are used in [Use Case models](#) [676] to reflect that one [Use Case](#) [806] includes the behavior of another. Use an Include relationship to avoid having the same subset of behavior in many Use Cases; this is similar to [delegation](#) [861] used in [Class models](#) [721].

#### Toolbox Icon



#### OMG UML Specification

The OMG UML specification (*UML Superstructure Specification, v2.1.1, p. 591*) states:

*Include is a DirectedRelationship between two Use Cases, implying that the behavior of the included Use Case is inserted into the behavior of the including Use Case. It is also a kind of NamedElement so that it can have a name in the context of its owning Use Case. The including Use Case may only depend on the result (value) of the included Use Case. This value is obtained as a result of the execution of the included Use Case.*

### 5.1.3.15 Information Flow

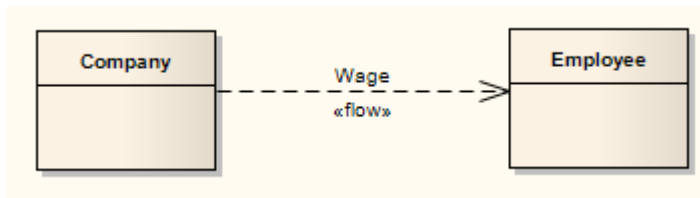

An *Information Flow* represents [information items](#) [821] or classifiers flowing between two elements in any diagram. The connector is available from the **Common** page of the **Toolbox** and from every Quick Link menu.

You can have more than one Information Flow connector between the same two elements, identifying which items flow between the two under differing conditions.

#### Example of Use

1. Open a diagram and add two elements (for example, Nodes on a Deployment diagram).
2. Click on the *Information Flow* connector in the **Common** page of the **Toolbox** and drag between the two elements. The [Information Items Conveyed](#) [865] dialog displays.
3. Add the classifier or information item element(s) to the Information Flow. The diagram now resembles the following.

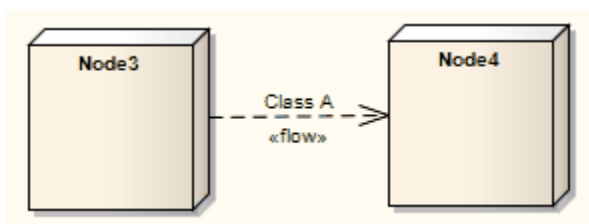

4. Add another connector between the same two elements (for example, a *Communication Path* connector).

5. Right-click the connector and select the **Advanced | Information Flows Realized** context menu option. The [Information Flows Realized](#)<sup>[866]</sup> dialog displays.
6. Tick the checkbox against the required classifier element and click on the **OK** button. The combined connector now resembles the following:

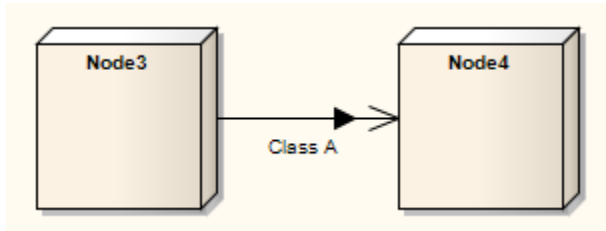
**Notes:**

- Once the connectors are combined, you cannot access the **Information Items Conveyed** dialog directly. You add or delete information items on the connector using the **Information Items Realized** dialog. If you have more than one Information Flow connector between the elements, they form part of the same combined connector; you can again work on them separately through the **Information Items Realized** dialog.
- If you have information flows in a diagram that you use as the source for a Pattern, the Information Items Conveyed and Information Flows Realized data is not copied into the Pattern.

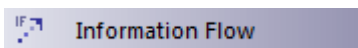
**Toolbox Icon****OMG UML Specification**

The OMG UML specification (*UML Superstructure Specification, v2.1.1, p. 606*) states:

*An InformationFlow specifies that one or more information items circulates from its sources to its targets.*

The OMG UML specification (*UML Superstructure Specification, v2.1.1, p. 607*) also states:

*An information flow is an abstraction of the communication of an information item from its sources to its targets. It is used to abstract the communication of information between entities of a system. Sources or targets of an information flow designate sets of objects that can send or receive the conveyed information item.*

**5.1.3.15.1 Convey Information on a Flow**

As you create an [Information Flow](#)<sup>[864]</sup> connector between two elements, you can specify which [Information Items](#)<sup>[821]</sup> or classifiers are conveyed on this flow.

To specify these Information Items or classifiers, right-click on the connection and select the **Advanced | Information Item Conveyed** context menu option. The **Information Items Conveyed** dialog displays.

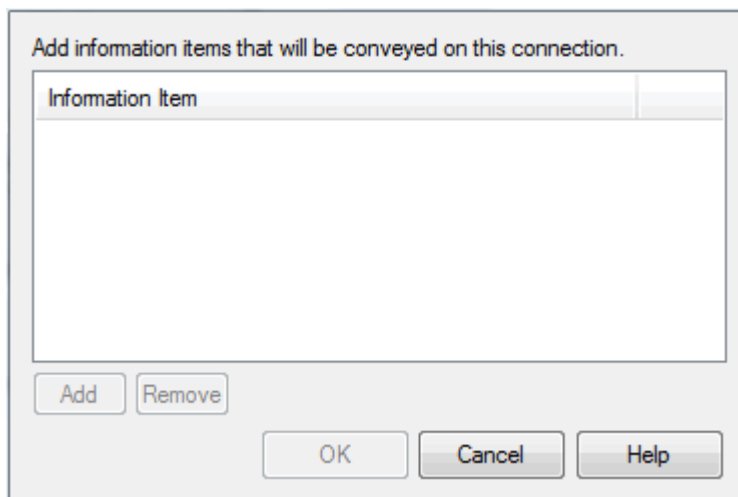

Button	Use to
<b>Add</b>	Display the <a href="#">Select &lt;Item&gt;</a> <sup>[515]</sup> dialog, from which you select the required Information or Classifier element(s).
<b>Remove</b>	Remove the selected item.

**Note:**

If you select more than one element, they are listed in one entry for the Information Flow connector.

### 5.1.3.15.2 Realize an Information Flow

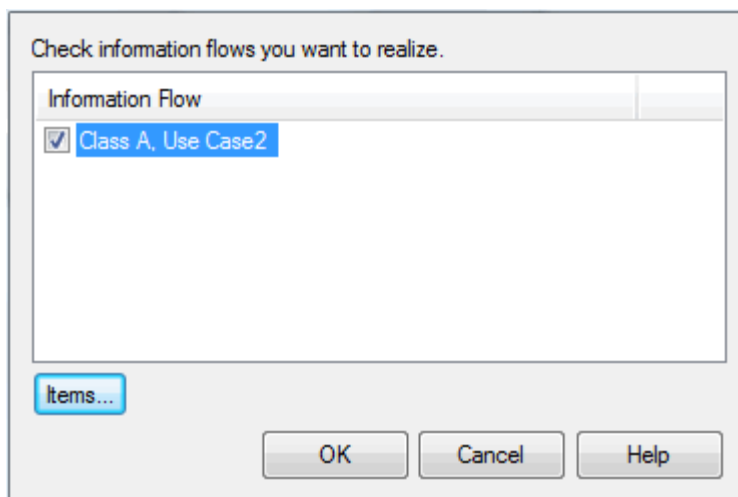

The **Information Flows Realized** dialog displays all flows that can be realized on the selected connector. To realize an [Information Flow](#) <sup>[864]</sup> on this connector, select the corresponding checkbox and click on the **OK** button.

If you want to change the information items conveyed on an information flow, click on the flow *text* and click on the **Items** button. The [Information Items Conveyed](#) <sup>[865]</sup> dialog displays, and you can add or remove items as required. When you click on the **OK** button, the **Information Items Realized** dialog redisplay and you can realize the selected flow or flows as above.

### 5.1.3.16 Interrupt Flow

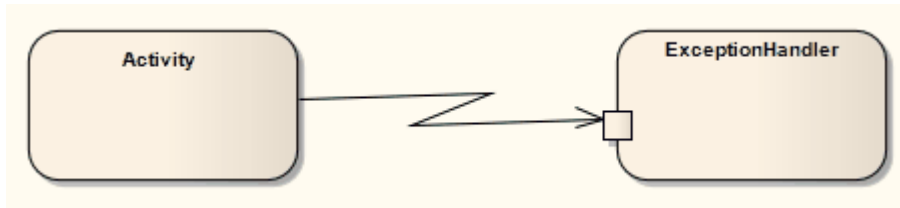

The *Interrupt Flow* is a connection used to define the two UML concepts of connectors for [Exception Handler](#) [769] and [Interruptible Activity Region](#) [781]. An Interrupt Flow is also known as an *activity edge*. It is typically used in an [Activity diagram](#) [674].

#### Toolbox Icon

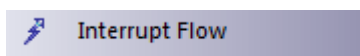

#### OMG UML Specification

The OMG UML specification (*UML Superstructure Specification, v2.1.1, p. 327*) states:

*An activity edge is an abstract class for directed connections between two activity nodes.*

### 5.1.3.17 Manifest

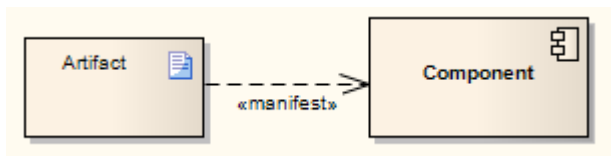

A *Manifest* relationship indicates that the [Artifact](#) [810] source embodies the target model element, typically in [Component](#) [730] and [Deployment](#) [727] diagrams. [Stereotypes](#) [895] can be added to Enterprise Architect to classify the type of manifestation of the model element.

#### Toolbox Icon

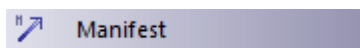

#### OMG UML Specification

The OMG UML specification (*UML Superstructure Specification, v2.1.1, p. 212*) states:

*An artifact embodies or manifests a number of model elements. The artifact owns the manifestations, each representing the utilization of a packageable element.*

*Specific profiles are expected to stereotype the manifestation relationship to indicate particular forms of manifestation, e.g. «tool generated» and «custom code» might be two manifestations for different classes embodied in an artifact.*

### 5.1.3.18 Message

Messages indicate a flow of information or transition of control between elements. Messages can be used by [Timing Diagrams](#) [882], [Sequence Diagrams](#) [868] and [Communication Diagrams](#) [879] (but not [Interaction Overview](#) [717] diagrams) to reflect system behavior. If between [Classes](#) [811] or classifier instances, the associated list of operations is available to specify the event.

Moving a Message can disrupt the organization of other features on the diagram. To avoid this, and move *only* the Message, press **[Alt]** while you move the Message.

## Toolbox Icon

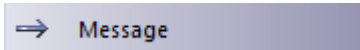

## OMG UML Specification

The OMG UML specification (*UML Superstructure Specification, v2.1.1, p. 491*) states:

*A Message defines a particular communication between Lifelines of an Interaction.*

*A Message is a NamedElement that defines one specific kind of communication in an Interaction. A communication can be, for example, raising a signal, invoking an Operation, creating or destroying an Instance. The Message specifies not only the kind of communication given by the dispatching ExecutionSpecification, but also the sender and the receiver.*

*A Message associates normally two OccurrenceSpecifications - one sending OccurrenceSpecification and one receiving OccurrenceSpecification.*

### Note:

Communication diagrams were known as Collaboration diagrams in UML 1.4.

### 5.1.3.18.1 Message (Sequence Diagram)

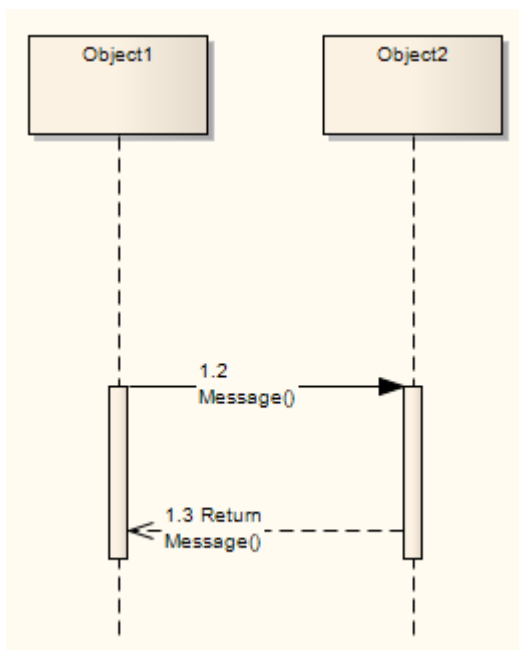

[Sequence diagrams](#)<sup>[706]</sup> depict work flow or activity over time using Messages passed from element to element. These Messages correspond in the software model to Class operations and behavior. They are semantically similar to the Messages passed between elements in a Communication diagram, and can be of many different [types](#)<sup>[873]</sup>.

To create a Message on a Sequence diagram, follow the steps below:

1. Access the Sequence diagram. The **Interaction** pages of the **Toolbox** display.
2. In the **Interaction Relationships** page, click on the **Message** icon, click on the source object and drag the cursor to the destination (target) object. The **Message Properties** dialog displays (if not, right-click on the Message and select the **Message Properties** context menu option).



- In the **Message** field, type the Message name.

#### Notes:

- If the Message flow is *towards* a [Class](#) <sup>[811]</sup> element (dropped in from a Class diagram) or a [Lifeline](#) <sup>[783]</sup> element having a classifier, and the *destination* Class has defined *operations*, you can click on the drop-down arrow and select an appropriate operation name. The Message then reflects the destination Class operations.
- If the available operations are not appropriate, you can click on the **Operations** button and define a new operation in the target element, using the [Operations](#) <sup>[570]</sup> dialog.
- If you create a Message without making reference to the target Class operations, no new operation is added to the target Class.

- In the **Parameters** field, type any parameters that the Message has, as a comma-separated list. If required, in the **Parameter Values** field type the actual value for each parameter, again as a comma-separated list.
- If the Message is a return message, in the **Return Value** field enter the returned value or type.

#### Note:

It is possible to depict returns from a [Self Message](#) <sup>[871]</sup>. Simply create a second Self Message at the end of execution and select the **Is Return** checkbox in the **Control Flow Type** panel.

- If the Message flow is *from* a Class element or Lifeline element with classifier that has defined *attributes*

, click on the drop-down arrow in the **Assign to** field and select an appropriate attribute name. The Message reflects the attributes from the *source* Class. You cannot add further attributes to the source Class here - if no appropriate attribute is listed, open the element **Properties** dialog and add the required attribute.

Otherwise, if required, type the name of the object to assign the message flow to.

7. In the **Stereotype** field, type or select an optional stereotype for the connector (this is displayed on the diagram, if entered).
8. If required, in the **Alias** field type an alias for the name of the Message.

#### Note:

On the diagram, the alias displays if the **Use Alias if Available** checkbox is selected on the **Diagram** tab of the **Diagram Properties** dialog. The Alias displays instead of or as well as the Message name, depending on the setting selected in the **Alias Usage** panel of the **Diagram Behavior**<sup>[359]</sup> page of the **Options** dialog.

9. In the **Condition** field, type any conditions that must be true in order for the message to be sent.
10. In the **Synch:** field in the **Control Flow Type** panel, select **Synchronous** or **Asynchronous**<sup>[877]</sup> as appropriate.
11. In the **Lifecycle** field, select **New** to create a new element at the end of the Message, or **Delete** to terminate the message flow at the end of the Message. If neither case applies, leave the field at the default of **<none>**.
12. If required, in the **Notes** field type any explanatory notes. You can format the notes using the **Notes**<sup>[642]</sup> toolbar at the top of the field.
13. Click on the **OK** button to save the Message definition.

#### Notes:

- You can [change the timing details](#)<sup>[874]</sup> of a message on the **Timing Details** dialog, and emphasize the sequence of closely-ordered messages using [General Ordering](#)<sup>[876]</sup>.
- To toggle the numbering of messages on a Sequence diagram, select or deselect the **Show Sequence Numbering**<sup>[360]</sup> checkbox on the **Options** dialog.

## Co-Region Notation

*Co-Region notation* can be used as a short hand for parallel combined fragments. To access the **Co-Region** submenu, right-click on a connector in a Sequence diagram and select the **Co-Region** context menu option. There are four sub-options available:

- **Start at head**
- **End at head**
- **Start at tail**
- **End at tail.**

## Toolbox Icon

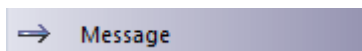

### 5.1.3.18.1.1 Self-Message

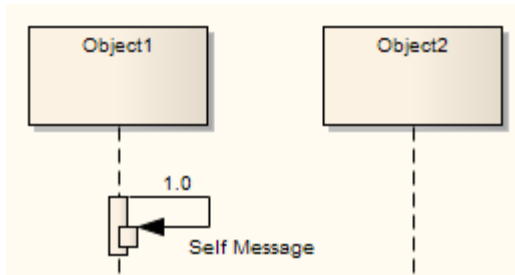

A *Self-Message* reflects a new process or method invoked within the calling lifeline's operation. It is a specification of a [Message](#)<sup>[867]</sup>, typically in a [Sequence diagram](#)<sup>[706]</sup>.

### Self-Message as Return

It is possible to depict a return from a Self Message call.

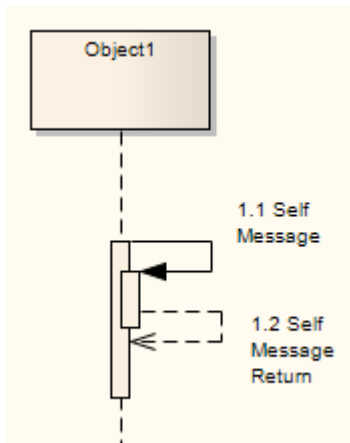

To create a Self Message return:

1. Create a second Self Message at the end of execution.
2. Double-click on the Message name to open the **Message Properties** dialog.
3. Select the **Is Return** checkbox.
4. [Raise the Activation level](#)<sup>[712]</sup> of the return.

Self-Message [Calls](#)<sup>[872]</sup> indicate a nested invocation; new activation levels are added with each Call.

### Toolbox Icon

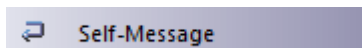

### 5.1.3.18.1.2 Call

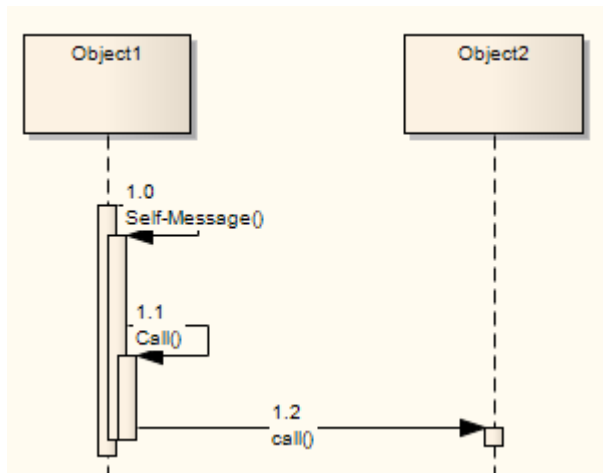

A *Call* is a type of [Message](#) connector that extends the level of activation from the previous Message. All [Self-Messages](#) create a new activation level, but this focus of control usually ends with the next Message (unless [activation levels](#) are manually adjusted). Self-Message Calls, as depicted above by the first Call, indicate a nested invocation; new activation levels are added with each Call. Unlike a regular Message between elements, a Call between elements continues the existing activation in the source element, implying that the Call was initiated within the previous Message's activation scope.

#### Toolbox Icon



### 5.1.3.18.1.3 Message Examples

The following are different types of [Messages](#) <sup>[868]</sup> available on [Sequence Diagrams](#) <sup>[706]</sup>. Note that Messages on Sequence diagrams can also be modified with [Shape Scripts](#) <sup>[1147]</sup>.

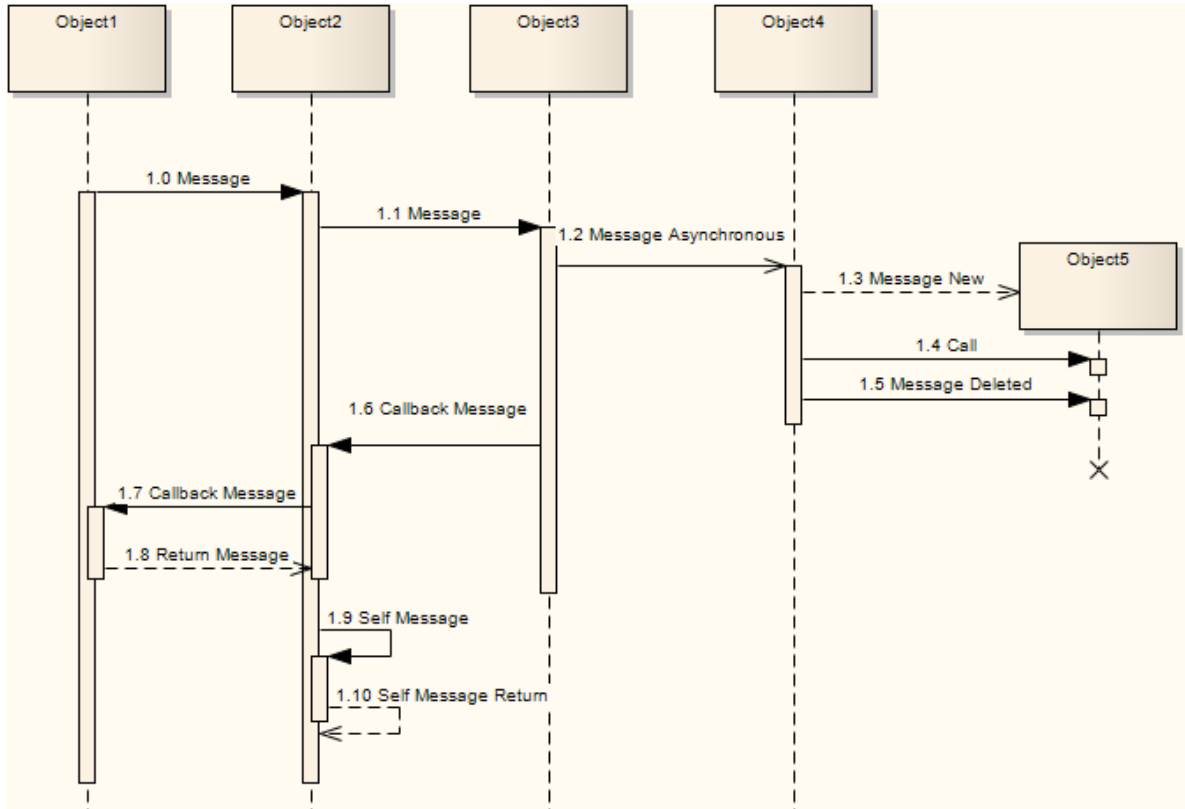

### Other Sequence Messages

The following are examples of Messages that are not part of the sequence described by the diagram.

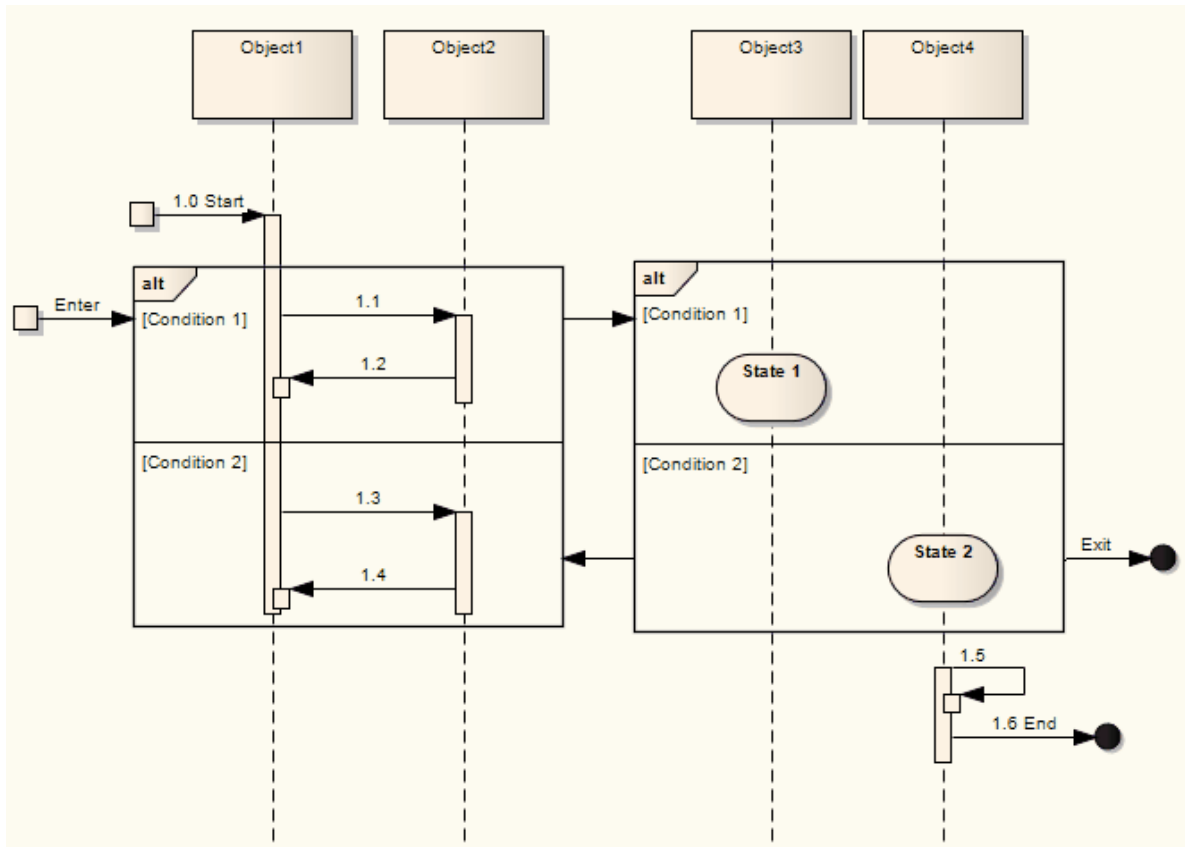

**5.1.3.18.1.4 Change the Timing Details**

It is possible to change the timing details of a Message in a [Sequence diagram](#) <sup>[706]</sup> by right-clicking on the [Message](#) <sup>[867]</sup> connector and selecting the **Timing Details** context menu option. The **Timing Details** dialog displays.

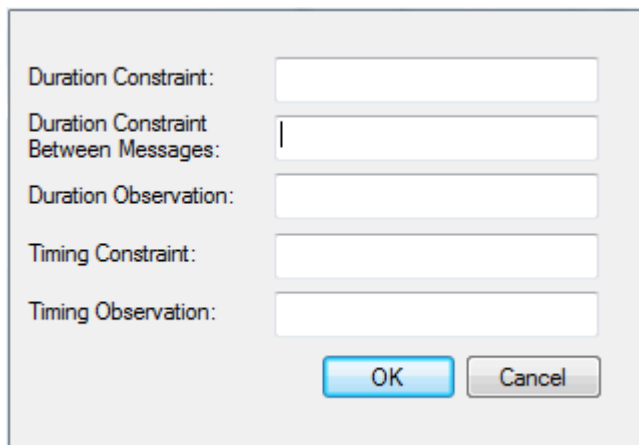

Complete the fields on this dialog as follows:

Option	Use to
<b>Duration Constraint</b>	Indicate the minimum and maximum limits on how long a message can last.
<b>Duration Constraint Between Messages</b>	Indicate the minimum and maximum interval between sending or receipt of the previous message at the current message's source Lifeline, and sending the current

Option	Use to
	message.
<b>Duration Observation</b>	Capture the duration of a message.
<b>Timing Constraint</b>	Indicate the minimum and maximum time at which the message should arrive at the target.
<b>Timing Observation</b>	Capture the point at which the message was sent.

See the OMG UML specification (*UML Superstructure Specification, v2.1.1, p. 511*).

In the diagram below, on the *Open Order* Message:

- **Duration Constraint** has been set to **0...13**.

On the *Get Cart* Message:

- **Duration Constraint Between Messages** has been set to **d...d\*3**
- **Duration Observation** has been set to **d=duration**
- **Timing Constraint** has been set to **t...t+3**
- **Timing Observation** has been set to **t=now**.

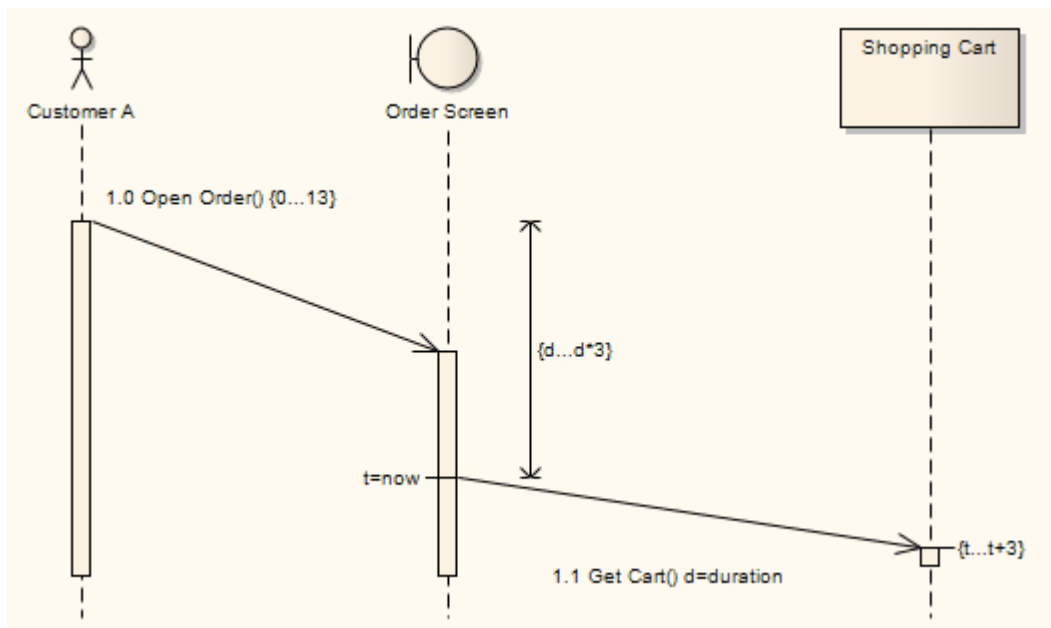

By typing a value in the **Duration Constraint** field, you enable the Message angle to be adjusted. After clicking on the **OK** button on the **Timing Details** dialog, click on the head of the Message connector and drag the connector up or down to change the angle. You cannot extend the angle beyond the life line of the connecting sequence object or create an angle of less than 5 degrees.

You can also create the **Duration Constraint Between Messages** line by dragging the **General Ordering** <sup>876</sup> arrow up to the point at which the previous message joins the source Lifeline for the current message. A dialog displays on which you enter the value for the constraint. Having created the line, you can move it to any point within half way along the current message and half way along the previous message, to avoid overlap with other message timing details. You can edit or delete the value either through the **Timing Details** dialog or by right-clicking on the line itself and selecting the appropriate context menu option.

### 5.1.3.18.1.5 General Ordering

In a [Sequence diagram](#) <sup>[706]</sup>, the workflow is represented by the sequence of Messages down the diagram. Messages near the top of the diagram are passed before Messages lower down the diagram.

Consider the following diagram.

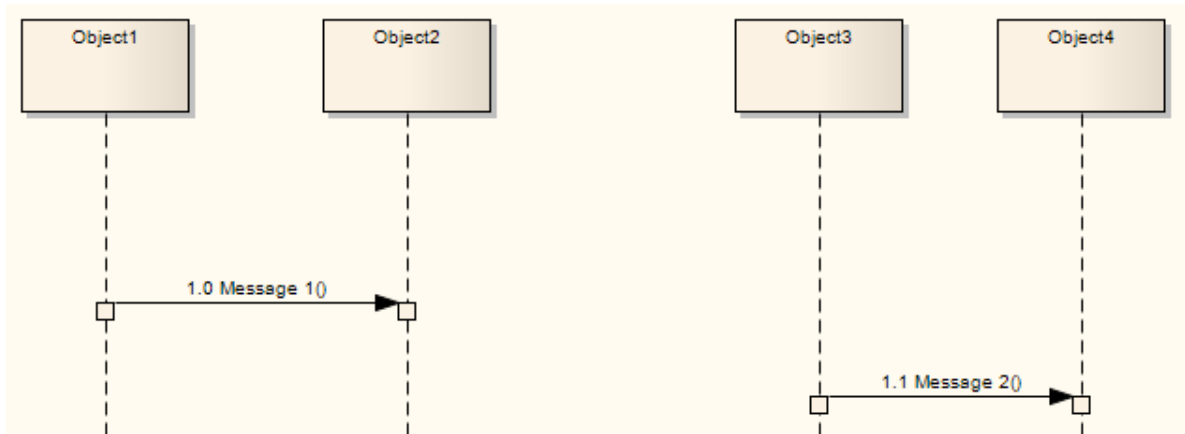

Message 1 is earlier than Message 2. However, in a complex diagram, or when representing finely timed operations or parallel processing, this might not be apparent. You can reinforce the sequence using a *General Ordering* arrow.

Click on the Message arrow. A small arrow displays at the source anchor point.



Click on this arrow and drag it to the start of the next Message in sequence (Message 2 in the example). The General Ordering arrow displays, indicating that the second Message follows the first.

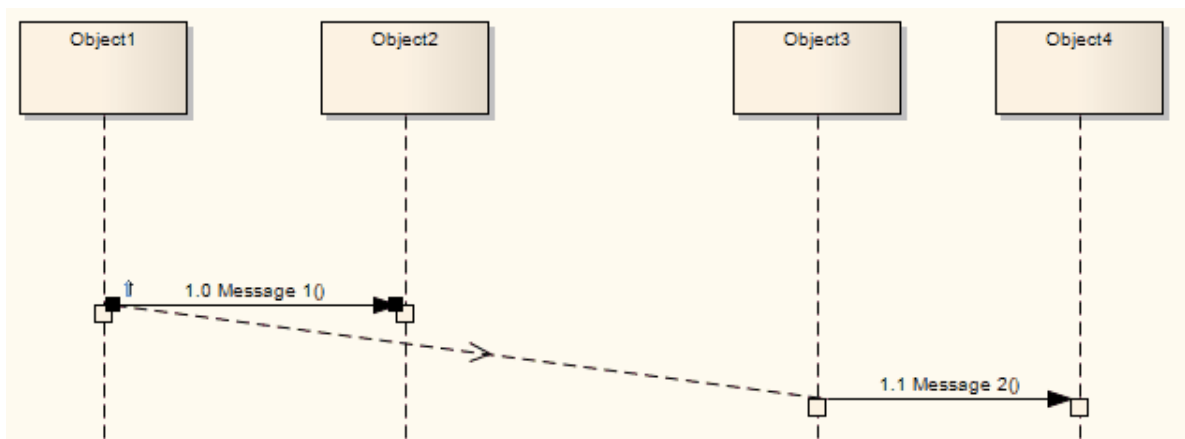

The General Ordering arrow is exaggerated in the above figure. You would normally have the arrow running almost horizontal across the diagram.



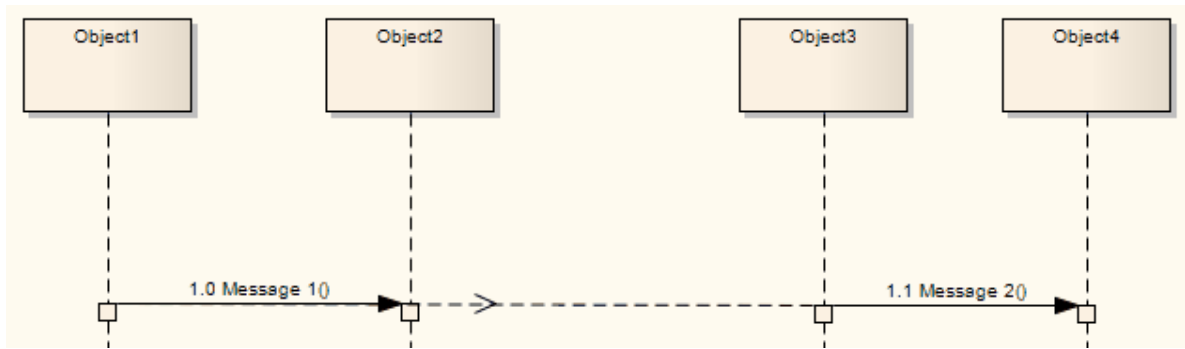

You can have more than one General Ordering arrow issuing from or targeting a Message, if necessary.

#### 5.1.3.18.1.6 Asynchronous Signal Message

You define a Message as an asynchronous signal message by displaying the [Message Properties](#) dialog and setting the **Synch** field to **Asynchronous** and the **Kind** field to **Signal**. (A *synchronous* message cannot be used to convey signals, so setting the **Synch** field to **Synchronous** disables the **Kind** field.)

##### Note:

**Return Value**, **Assign To** and the **Operations** button, which are not applicable to asynchronous *signals*, are disabled.

The **Operations** button changes to a **Signal** button, which you click on to associate the asynchronous signal message with a Signal element in the model. You can type the arguments corresponding to the Signal attributes into the **Argument(s)** field.

**Signature**

Message:

Attributes:

Argument(s):

Return Value:   Show Inherited Methods

Assign To:

Stereotype:

Alias:

**Sequence Expression**

Condition:

Constraint:

Is Iteration

**Control Flow Type:**

Synch:  Lifecycle:

Kind:   Is Return

**Notes:**

**B I U A** | |

When you click on the **Signal** button, the **Select \*Signal** dialog displays, through which you locate and select the required Signal element. (The **Select \*Signal** dialog is a variation of the [Select <Item>](#) <sup>[515]</sup> dialog.)

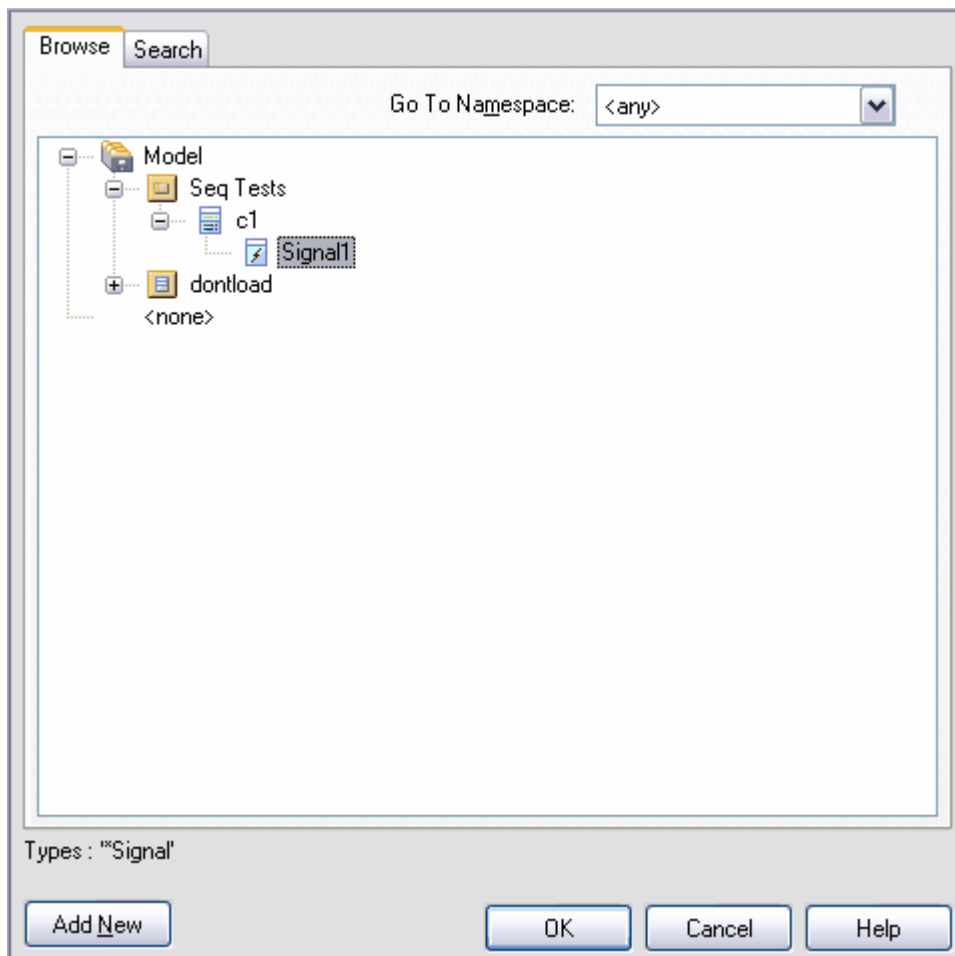

### 5.1.3.18.2 Message (Communication Diagram)

A Message in a [Communication diagram](#)<sup>[715]</sup> is equivalent in meaning to a Message in a Sequence diagram. It implies that one object uses the services of another object, or sends a message to that object. Communication Messages in Enterprise Architect are always associated with an [Associate](#)<sup>[855]</sup> connector between object instances. Always create the Associate connector first, then [add a Message to the connector](#)<sup>[880]</sup>.

Messages can be dragged into a suitable position by clicking and dragging on the message text.

Communication Messages are ordered to reflect the sequencing of the diagram. The numbering scheme should reflect the nesting of each event. A sequencing scheme could be:

- 1
- 2, 2.1, 2.2, 2.3
- 3.

This would indicate the single sequence of events 2.1, 2.2 and 2.3 occurs within an operation initiated by event 2. This is the default pattern applied by Enterprise architect

Alternatively, the sequence could be:

- 1
- 2, 2.1, 2.1.1, 2.1.1.1  
2.2, 2.2.1, 2.2.1.1
- 3

This would indicate that two sequences of events can be initiated by event 2, and 2.1 and 2.2 are separate sequences, not consecutive events in one sequence. You can set the sequence [pattern and order](#)<sup>[880]</sup> using the **Message Properties** dialog and the **Sequence Communications** dialog.

If the target object is a Class or has its instance classifier set, the drop-down list of possible message names

includes the exposed operations for the base type.

### 5.1.3.18.2.1 Create a Communication Message

To create a [Communication Message](#)<sup>[879]</sup>, follow the steps below:

1. Open a diagram (one of: Communication, Analysis, Interaction Overview, Object, Activity or State Machine).
2. Add the required objects.
3. Add an [Associate](#)<sup>[855]</sup> relationship between each pair of objects that communicate.
4. Right-click on an *Associate* to display the context menu.
5. Select the option to add a Message from one object to the other.
6. When the [Message Properties](#)<sup>[868]</sup> dialog displays, type in a name and any other required details.
7. Click on the **OK** button. The Message is added, connected to the Association and Object instances.
8. Move the Message to the required position.

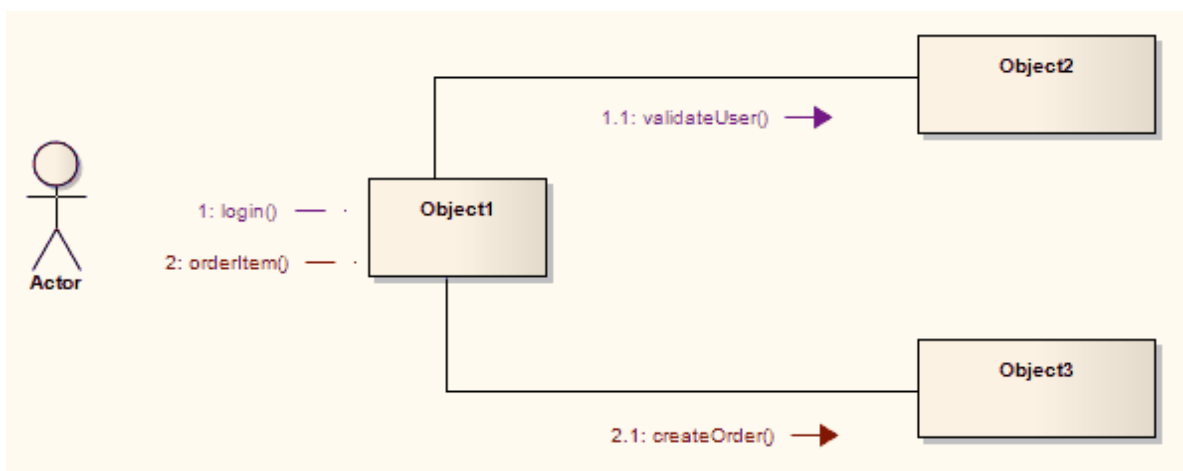

### 5.1.3.18.2.2 Re-Order Messages

When constructing your Communication diagram, it is frequently necessary to create or delete Message 'groups' and to re-order the sequence of Messages. There are two dialogs that help you perform these tasks: the [Message Properties](#) dialog and the [Sequence Communications](#) dialog.

#### Organize Message Groups

If you have several [Messages](#)<sup>[879]</sup> in the form 1.1, 1.2, 1.3, 1.4, for example, but would like to start a new numbering group on, say, the third Message (that is, 1.1, 1.2, **2.1**, 2.2, 2.3), you can change a Message in the series to a *Start Group* message.

To reorganize *message groups*, follow the steps below:

1. Double-click on a Message *name*. The [Message Properties](#) dialog displays.

The dialog box is titled 'Signature' and contains the following fields and controls:

- Message:** A dropdown menu with 'Update' selected. A button labeled 'Operations' is to its right.
- Parameters:** A text input field containing 'cart'.
- Parameter Values:** An empty text input field.
- Return Value:** A dropdown menu with 'void' selected. A checked checkbox labeled 'Show Inherited Methods' is to its right.
- Assign To:** A dropdown menu with 'order' selected.
- Stereotype:** A dropdown menu with an empty field and a button with three dots to its right.
- Alias:** An empty text input field.

The **Sequence Expression** section contains:

- Condition:** An empty text input field.
- Constraint:** An empty text input field.
- Two checkboxes:  Is Iteration and  Start New Group.

The **Control Flow Type** section contains:

- Synch:** A dropdown menu with 'Synchronous' selected.
- Lifecycle:** A dropdown menu with '<none>' selected.
- Kind:** A dropdown menu with 'Call' selected.
- Is Return checkbox.

The **Notes** section features a rich text editor with a toolbar containing icons for Bold (B), Italic (I), Underline (U), Text Color (A), Bulleted List, Numbered List, Indent, Decrease Indent, Text Color, Text Background Color, and a globe icon. Below the toolbar is a large empty text area.

At the bottom of the dialog are three buttons: OK, Cancel, and Help.

2. To make the selected Message the start of a new group, select the **Start New Group** checkbox.
3. If required, in the **Notes** field, type an explanatory note. You can format the text using the [Notes](#) <sup>[642]</sup> toolbar at the top of the field.
4. Click on the **OK** button to save changes.

## Sequence Messages

In larger and more complex diagrams, you might have to use deeper levels of Messages in a group; for example, 1, 1.2, 1.2.1, 1.2.1.1. You might also have to change the sequence of Messages, making Message 1.3, for example, into Message 1.1.

To change the sequence or level of Messages, follow the steps below:

1. Either:
  - Select the **Diagram | Sequence Messages** menu option
  - Click on the diagram background and select the **Sequence Communication Messages** context menu option or
  - Right-click on a Message and select the **Sequence Communication Messages** context menu option.

The **Communication Messages** dialog displays.

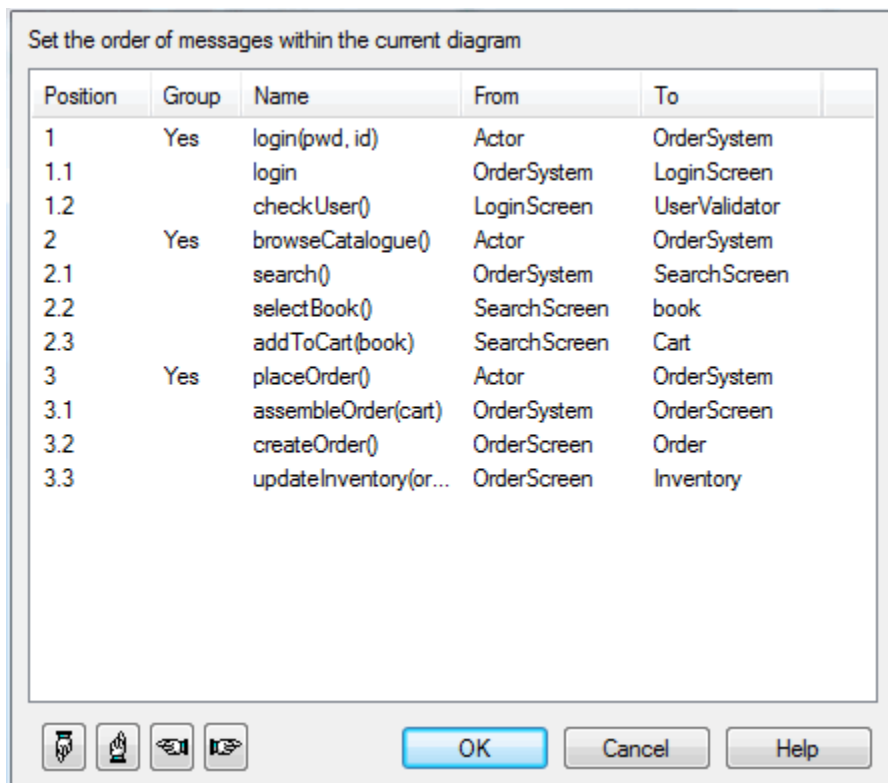

2. Click on the Message to adjust and, at the bottom of the dialog, click on the:
  - 'Up Hand' or 'Down Hand' buttons to move the Message up or down the sequence (e.g. Message 1.2 to Message 1.1 or 1.3)
  - 'Left Hand' or 'Right Hand' buttons to move the Message up or down a level (e.g. Message 1.2.1 to Message 1.2 or Message 1.2.1.1).
3. Repeat step 2 until the Message sequence and levels match your requirements. You might have to adjust other Message numbers (in group, sequence or level) to accommodate the changes you have made.
4. Click on the **OK** button to save changes.

**Note:**

Communication diagrams were known as Collaboration diagrams in UML 1.4.

### 5.1.3.18.3 Message (Timing Diagram)

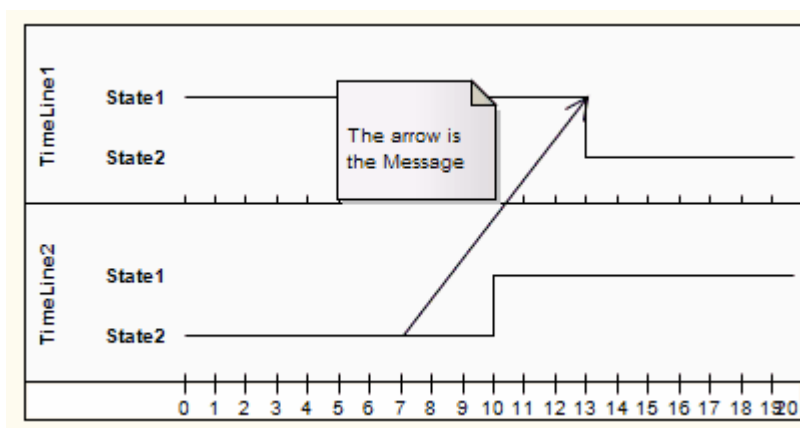

Messages are the communication links between [Lifelines](#)<sup>[783]</sup> in a [Timing diagram](#)<sup>[690]</sup>. In the case of a Timeline, a Message is a connection between two Timeline objects.

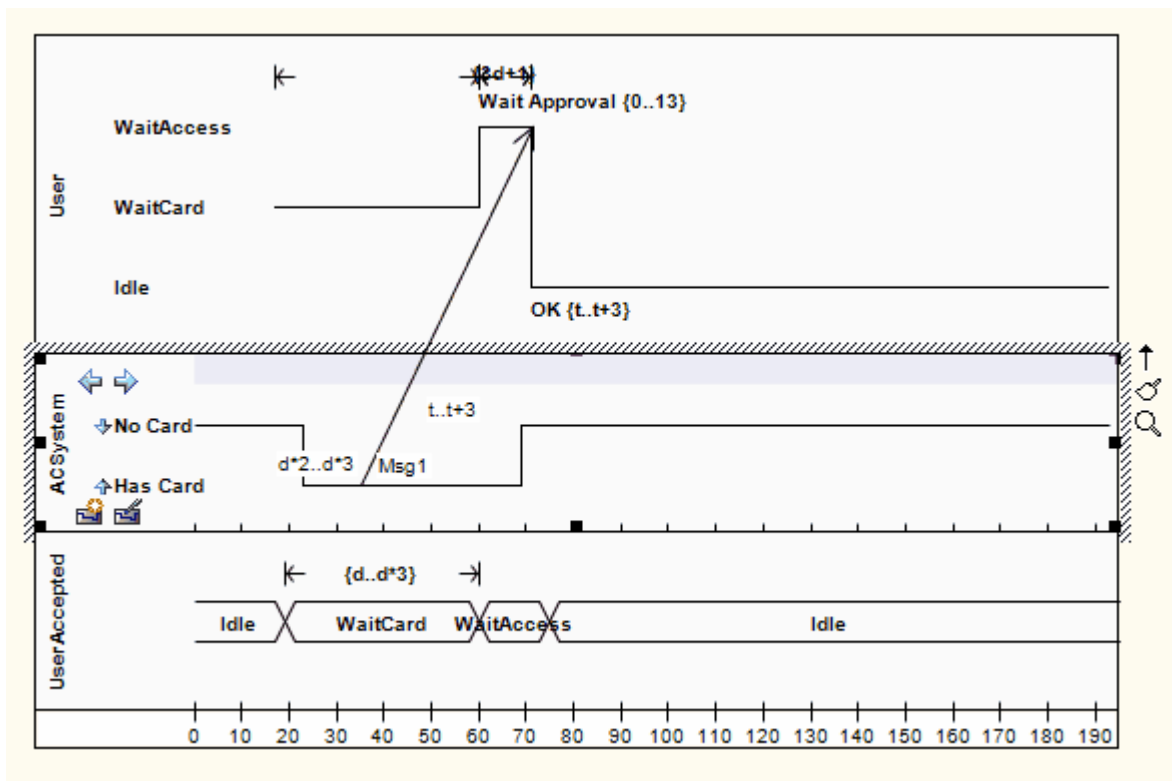

See UML Superstructure Specification, v2.1.1, figures 14.30 and 14.31, p. 520.

### Toolbox Icon

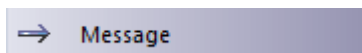

#### 5.1.3.18.3.1 Create a Timing Message

To create a [Message](#)<sup>[882]</sup> in a [Timing diagram](#)<sup>[690]</sup>, at least two Lifeline objects ([State](#)<sup>[794]</sup> or [Value](#)<sup>[808]</sup>) must be created first, each with existing transition points. To create a Message between Lifelines, follow the steps below:

1. Click on one of the Lifelines in the Timing diagram.
2. Select the **Message** icon from the **Timing Relationships** page of the **Toolbox (More tools | Timing)**.
3. Drag the cursor onto the Lifeline at the point at which the Message originates. The **Timing Message** dialog displays. (If not, double-click on the Message.)

The dialog box is titled 'Message Details' and is used for configuring message properties. It is organized into three main sections:

- Scope:** Contains two dropdown menus for 'Start' (set to 'ACSystem') and 'End' (set to 'User').
- Message Details:** Contains input fields for 'Start Time' (35), 'End Time' (71), 'Name' (Msg1), 'Time Observation' (t..t+3), and 'Duration Observation' (d\*2..d\*3).
- Transition To Detail:** Contains a dropdown for 'Transition To' (Idle), an input field for 'Event' (OK), an input field for 'Time Constraint' (t..t+3), and an empty input field for 'Duration Constraint'.

At the bottom right, there are 'OK' and 'Cancel' buttons.

The dialog consists of a set of transition points. Each transition point can be defined with the following properties:

Property	Description
<b>Start</b>	Defines the lifeline where the message originates.
<b>End</b>	Defines the lifeline where the message terminates.

These are set by default when a Message is created by dragging the cursor between two Lifelines.

Property	Description
<b>Start Time</b>	Specifies the start time for a message.
<b>End Time</b>	Specifies the end time for a message.
<b>Name</b>	The name of the message.
<b>Time Observation</b>	Provides information on the time of a sent message.
<b>Duration Observation</b>	Indicates the interval of a Lifeline at a particular state, begun from a message receipt.
<b>Transition To</b>	The state in the target Lifeline that the Message points to.
<b>Event</b>	The occurring event.
<b>Time Constraint</b>	The time taken to transmit a message.
<b>Duration Constraint</b>	Pertains to a lifeline's period at a particular state. The constraint could be instigated by that Lifeline's receipt of a message.



The following diagram shows the Message configured by the above dialog snapshot.

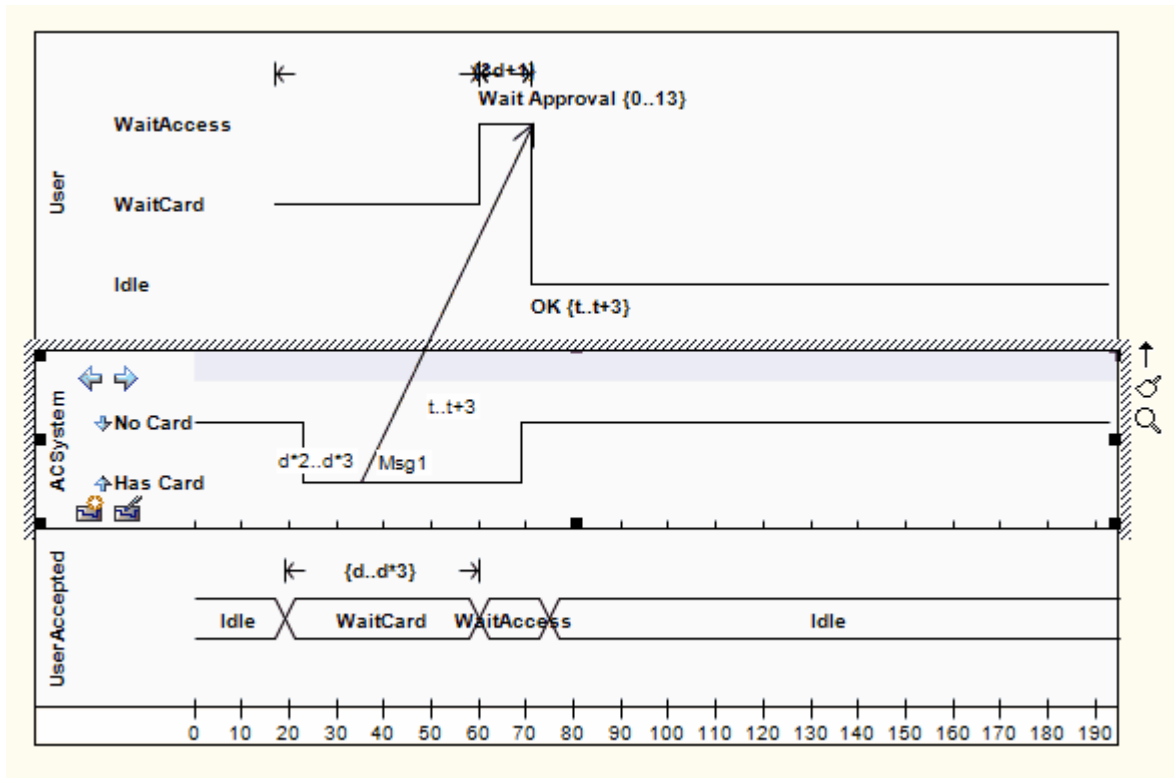

See *UML Superstructure Specification, v2.1.1, figures 14.30 and 14.31, p. 520.*

**Note:**

You can move the source end of the Message freely along the source timeline. However, the target end (arrow head) must attach to a transition. If you create a new Message and do not give it a target transition, it automatically finds and attaches to the nearest transition. If you move the target end, it drags the transition with it.

**5.1.3.19 Nesting**

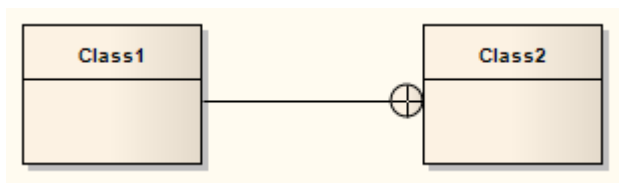

The *Nesting Connector* is an alternative graphical notation for expressing containment or nesting of elements within other elements. It is most appropriately used for displaying [Package](#) [825] nesting in a [Package diagram](#) [72b].

**Toolbox Icon**



### 5.1.3.20 Notelink

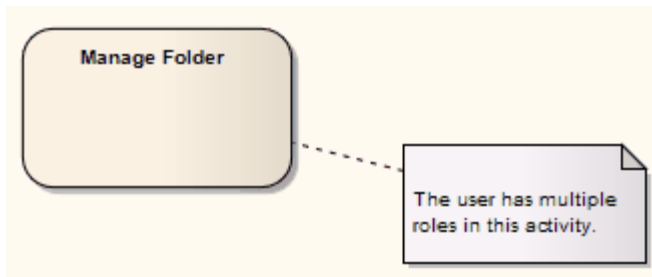

A *Notelink* connector connects a [Note](#)<sup>[785]</sup> to one or more other elements of any other type.

Both Note and Notelink are available in any category of the **Toolbox**, in the [Common](#)<sup>[405]</sup> page. You can also select them from the [UML Elements](#)<sup>[83]</sup> toolbar.

#### Toolbox Icon

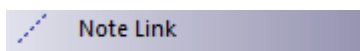

### 5.1.3.21 Object Flow

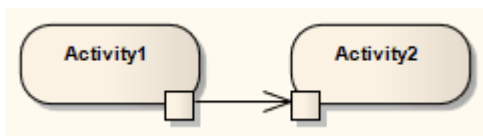

*Object Flows* are used in [Activity diagrams](#)<sup>[674]</sup> and [State Machine diagrams](#)<sup>[678]</sup>. When used in an Activity diagram, an Object Flow connects two elements, with specific data passing through it. To view sample Activity diagrams using Object Flows, see the [Object Flows in Activity Diagrams](#)<sup>[886]</sup> topic.

In State Machine diagrams, an Object Flow is a specification of a state flow or transition. It implies the passing of an [Object](#)<sup>[823]</sup> instance between elements at run-time.

You can insert an Object Flow from the **State** or **Activity** pages of the **Toolbox**, or from the drop-down list of all relationships located in the header toolbar. You can also modify a transition connection to an Object Flow by selecting the **ObjectFlow** checkbox on the connection **Properties** dialog.

See the [Control Flow](#)<sup>[860]</sup> topic for information on setting up Guards and Weights on Object Flows.

#### Toolbox Icon

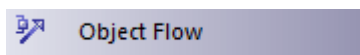

### OMG UML Specification

The OMG UML specification (*UML Superstructure Specification, v2.1.1, p. 389*) states:

*An object flow is an activity edge that only passes object and data tokens.*

#### 5.1.3.21.1 Object Flows in Activity Diagrams

In [Activity diagrams](#)<sup>[674]</sup>, there are several ways to define the flow of data between objects.

The following diagram depicts a simple [Object Flow](#)<sup>[886]</sup> between two actions, *Fill Order* and *Ship Order*, both accessing order information.

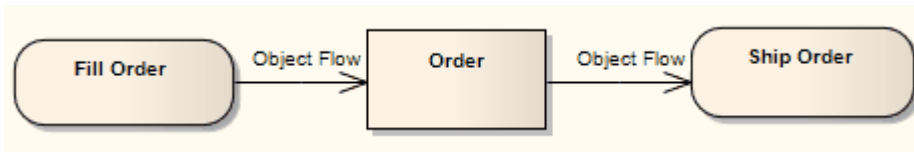

See *UML Superstructure Specification, v2.1.1, figure 12.110, p. 391.*

This explicit portrayal of the data object *Order*, connected to the Activities by two Object Flows, can be refined by using the following format. Here, [Action Pins](#)<sup>[749]</sup> are used to reflect the order.

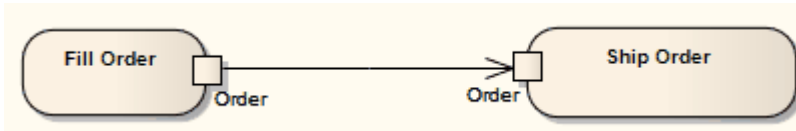

See *UML Superstructure Specification, v2.1.1, figure 12.110, p. 391.*

The following diagram is an example of multiple Object Flows exchanging data between two actions.



See *UML Superstructure Specification, v2.1.1, figure 12.111, p. 391.*

Selection and transformation behavior, together composing a sort of query, can specify the nature of the Object Flow's data access. Selection behavior determines which objects are affected by the connection. Transformation behavior might then further specify the value of an attribute pertaining to a selected object.

Selection and transformation behaviors can be defined by attaching a note to the Object Flow. To do this, right-click on the Object Flow and select the **Attach Note or Constraint** context menu option. A dialog lists other flows in the diagram, to which you can select to attach the note, if the behavior applies to multiple flows. To comply with UML 2, preface the behavior with the notation «selection» or «transformation».

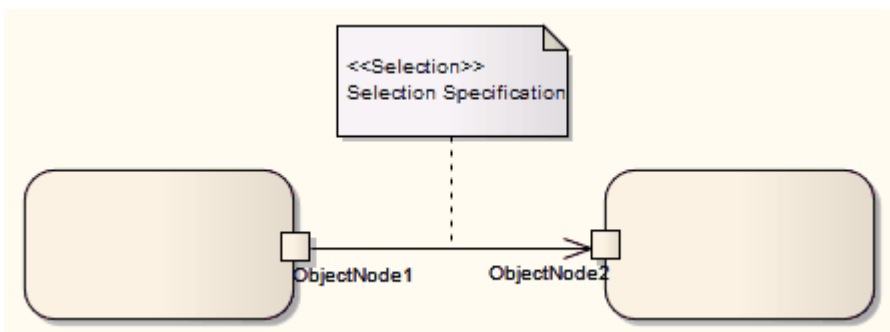

See *UML Superstructure Specification, v2.1.1, figure 12.112, p. 392.*

### 5.1.3.22 Occurrence

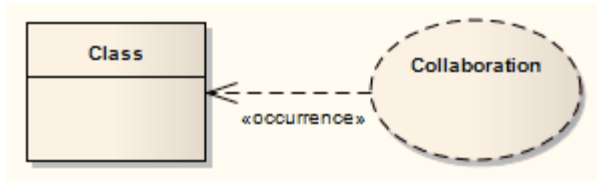

An *Occurrence* relationship indicates that a [Collaboration](#)<sup>[814]</sup> represents a classifier, in a [Composite Structure diagram](#)<sup>[724]</sup>. An Occurrence connector is drawn from the Collaboration to the classifier.

#### Toolbox Icon

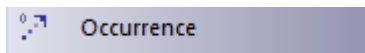

### 5.1.3.23 Package Import

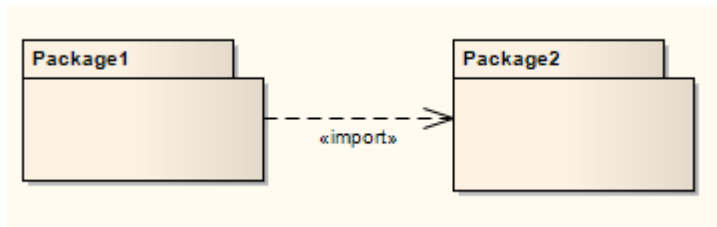

A *Package Import* relationship is drawn from a source [Package](#)<sup>[825]</sup> to a Package whose contents are to be imported. Private members of a target Package cannot be imported. The relationship is typically used in a [Package diagram](#)<sup>[720]</sup>.

#### Toolbox Icon

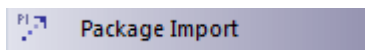

### OMG UML Specification

The OMG UML specification (*UML Superstructure Specification, v2.1.1, p. 112*) states:

*A package import is a relationship between an importing namespace and a package, indicating that the importing namespace adds the names of the members of the package to its own namespace. Conceptually, a package import is equivalent to having an element import to each individual member of the imported namespace, unless there is already a separately-defined element import.*

### 5.1.3.24 Package Merge

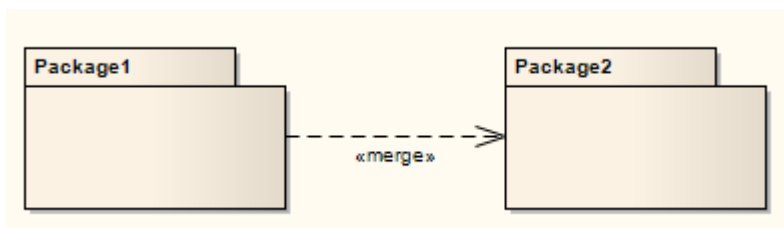

In a [Package diagram](#)<sup>[720]</sup>, a *Package Merge* indicates a relationship between two [Packages](#)<sup>[825]</sup> whereby the contents of the target Package are merged with those of the source Package. Private contents of a target Package are not merged. The applicability of a Package Merge addresses any situation where multiple

packages contain identically-named elements, representing the same thing. A Package Merge merges all matching elements across its merged Packages, along with their relationships and behaviors. Note that a Package Merge essentially performs generalizations and redefinitions of all matching elements, but the merged Packages and their independent element representations still exist and are not affected.

The Package Merge serves a graphical purpose in Enterprise Architect, but creates an ordered Package relationship applied to related Packages (which can be seen under the **Link** tab in the Package's **Properties** dialog). Such relationships can be reflected in XMI exports or Enterprise Architect Automation Interface scripts for code generation or other Model Driven Architecture (MDA) interests.

Package Merge relationships are useful to reflect situations where existing architectures contain functionalities involving like elements, which are merged in a developing architecture. Merging doesn't affect the merged objects, and supports the common situation of product progression.

## Toolbox Icon

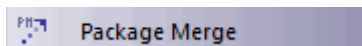

## OMG UML Specification

The OMG UML specification (*UML Superstructure Specification, v2.1.1, p. 113-114*) states:

*A package merge is a directed relationship between two packages that indicates that the contents of the two packages are to be combined. It is very similar to Generalization in the sense that the source element conceptually adds the characteristics of the target element to its own characteristics resulting in an element that combines the characteristics of both.*

*This mechanism should be used when elements defined in different packages have the same name and are intended to represent the same concept. Most often it is used to provide different definitions of a given concept for different purposes, starting from a common base definition. A given base concept is extended in increments, with each increment defined in a separate merged package. By selecting which increments to merge, it is possible to obtain a custom definition of a concept for a specific end. Package merge is particularly useful in meta-modeling and is extensively used in the definition of the UML metamodel.*

*Conceptually, a package merge can be viewed as an operation that takes the contents of two packages and produces a new package that combines the contents of the packages involved in the merge. In terms of model semantics, there is no difference between a model with explicit package merges, and a model in which all the merges have been performed.*

### 5.1.3.25 Realize

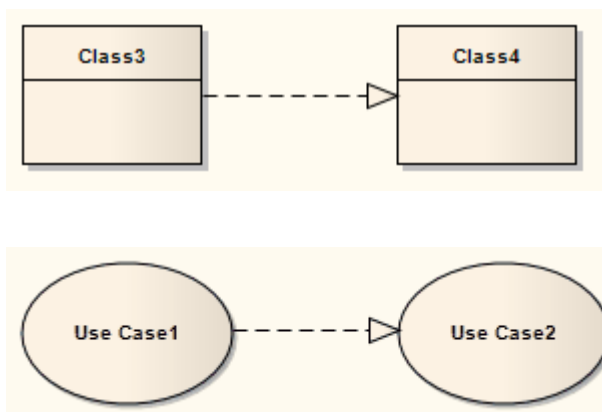

A source object implements or *Realizes* its destination object. Realize connectors are used in a [Use Case](#)<sup>[676]</sup>, [Component](#)<sup>[730]</sup> or [Requirements](#)<sup>[736]</sup> diagram to express [traceability](#)<sup>[1245]</sup> and completeness in the model. A business process or [Requirement](#)<sup>[846]</sup> is realized by one or more [Use Cases](#)<sup>[806]</sup>, which in turn are realized by some [Classes](#)<sup>[817]</sup>, which in turn are realized by a [Component](#)<sup>[816]</sup>, and so on. Mapping Requirements, Classes and such across the design of your system, up through the levels of modeling abstraction, ensures the big picture of your system remembers and reflects all the little pictures and details that constrain and define it.

## Toolbox Icon

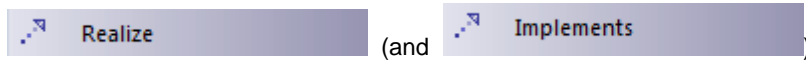

## OMG UML Specification

The OMG UML specification (*UML Superstructure Specification, v2.1.1, p. 131*) states:

*A Realization signifies that the client set of elements are an implementation of the supplier set, which serves as the specification. The meaning of 'implementation' is not strictly defined, but rather implies a more refined or elaborate form in respect to a certain modeling context. It is possible to specify a mapping between the specification and implementation elements, although it is not necessarily computable.*

### 5.1.3.26 Recursion

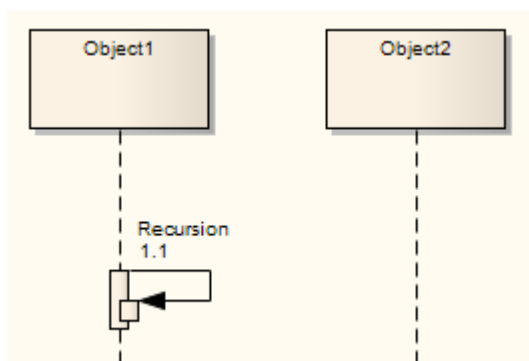

A *Recursion* is a type of [Message](#) <sup>[868]</sup> used in [Sequence diagrams](#) <sup>[706]</sup> to indicate a recursive function.

## Toolbox Icon

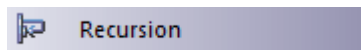

### 5.1.3.27 Role Binding

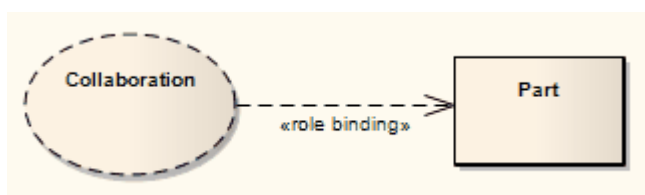

*Role Binding* is the mapping between a [Collaboration Occurrence's](#) <sup>[815]</sup> internal roles and the respective [Parts](#) <sup>[825]</sup> required to implement a specific situation, typically in a [Composite Structure diagram](#) <sup>[724]</sup>. The associated Parts can have properties defined to enable the binding to occur, and the Collaboration to take place.

A Role Binding connector is drawn between a [Collaboration](#) <sup>[814]</sup> and the classifier's fulfilling roles, with the Collaboration's internal binding roles labeled on the classifier end of the connector.

## Toolbox Icon

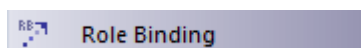

## OMG UML Specification

The OMG UML specification (*UML Superstructure Specification, v2.1.1, p. 174*) states:

*A mapping between features of the collaboration type and features of the classifier or operation. This mapping indicates which connectable element of the classifier or operation plays which role(s) in the collaboration. A connectable element may be bound to multiple roles in the same collaboration occurrence (that is, it may play multiple roles).*

### 5.1.3.28 Represents

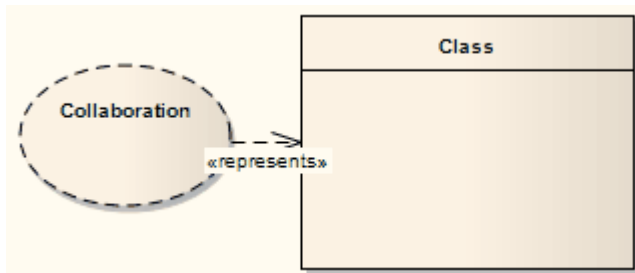

The *Represents* connector indicates that a [Collaboration](#)<sup>[814]</sup> is used in a classifier, typically in a [Composite Structure diagram](#)<sup>[724]</sup>. The connector is drawn from the Collaboration to its owning classifier.

### Toolbox Icon

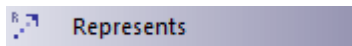

### 5.1.3.29 Representation

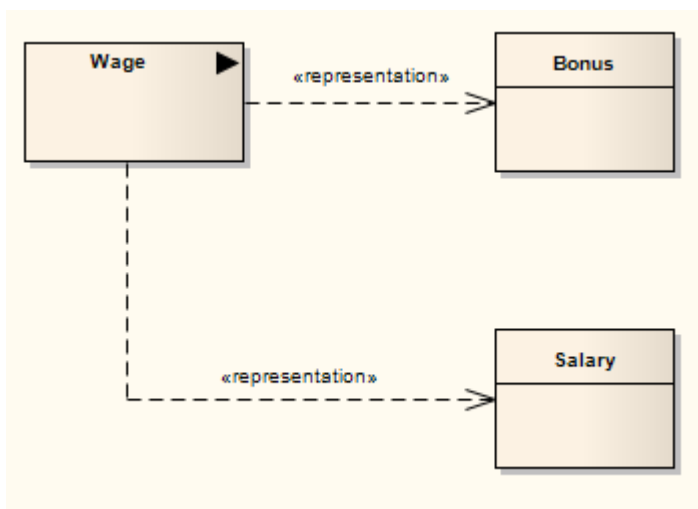

The *Representation* relationship is a specialization of a [Dependency](#)<sup>[861]</sup>, connecting [Information Item](#)<sup>[821]</sup> elements that represent the same idea across models, typically in an [Analysis diagram](#)<sup>[733]</sup>. For example, *Bonus* and *Salary* are both a representation of the Information Item *Wage*.

### Toolbox Icon

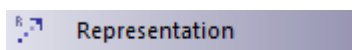

### 5.1.3.30 Trace

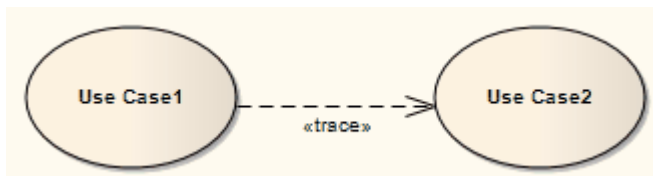
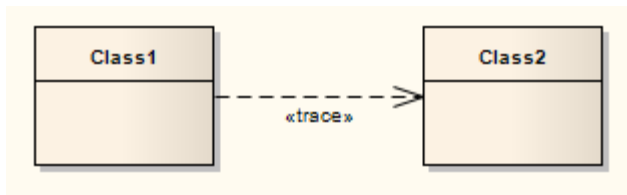

The *Trace* relationship is a specialization of a [Dependency](#)<sup>[86†]</sup>, connecting model elements or sets of elements that represent the same concept across models. Traces are often used to track requirements and model changes, typically in a [Traceability](#)<sup>[125†]</sup> diagram, or in a [Class](#)<sup>[72†]</sup>, [Use Case](#)<sup>[67†]</sup>, [Object](#)<sup>[72†]</sup> or [Composite Structure](#)<sup>[72†]</sup> diagram.

As changes can occur in both directions, the order of this Dependency is usually ignored. The relationship's properties can specify the trace mapping, but the trace is usually bi-directional, informal and rarely computable.

#### Toolbox Icon



### 5.1.3.31 Transition

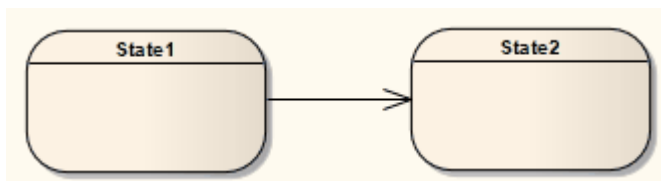

A *Transition* defines the logical movement from one [State](#)<sup>[78†]</sup> to another, in a [State Machine diagram](#)<sup>[67†]</sup>. The Transition can be controlled through the following connector **Properties** dialog:



Option	Use to
<b>Guard</b>	Type in an expression that is evaluated after an Event is dispatched, but before the corresponding Transition is triggered. If the guard is true at that time, the Transition is enabled; otherwise, it is disabled.
<b>Effect is a Behavior</b>	Convert the <b>Effect</b> field from a free-text field to the definition of a specific Activity or behavior.  Enterprise Architect displays the <a href="#">Select &lt;Item&gt;</a> dialog to prompt you to select the Activity or behavior element from the model.
<b>Effect</b>	Either: <ul style="list-style-type: none"> <li>Type a description of the effect of the Transition, or</li> <li>If you have selected the <b>Effect is a Behavior</b> check box, select an Activity or behavior to be performed during the Transition (to change this subsequently, click on the [ ... ] button to redisplay the <a href="#">Select &lt;Item&gt;</a> dialog).</li> </ul>
<b>Trigger</b>	
<b>Name</b>	Specify the name of the trigger.
<b>Type</b>	Specify the type of trigger: <b>Call</b> , <b>Change</b> , <b>Signal</b> or <b>Time</b> . <ul style="list-style-type: none"> <li><b>Call</b> - specifies that the event is a CallEvent, which sends a message to the associated object by invoking an operation.</li> <li><b>Change</b> - specifies that the event is a ChangeEvent, which indicates that the transition is the result of a change in value of an attribute.</li> <li><b>Signal</b> - specifies that the event is a SignalEvent, which corresponds to the receipt of an asynchronous signal instance.</li> <li><b>Time</b> - corresponds to a TimeEvent; which specifies a moment in time.</li> </ul>

Option	Use to
	<p><b>Note:</b></p> <p>Code generation for State Machines currently supports Change and Time trigger events only, and expects a specification value.</p>
<b>Specification</b>	Specify the event instigating the Transition.
<b>Save</b>	Save the current trigger.
<b>Add</b>	<p>Select triggers from the model using the <a href="#">Select Trigger</a><sup>[515]</sup> dialog.</p> <p><b>Note:</b></p> <p>To add multiple triggers, press <b>[Ctrl]</b> while selecting each trigger.</p>
<b>Delete</b>	Remove the selected trigger from the list.
<b>Triggers</b>	List the current triggers for the Transition.

**Note:**

Fork and Join segments can have neither triggers nor guards.

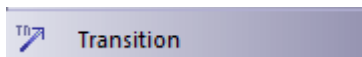
**Toolbox Icon****OMG UML Specification**

The OMG UML specification (*UML Superstructure Specification, v2.1.1, p. 568*) states:

*A transition is a directed relationship between a source vertex and a target vertex. It may be part of a compound transition, which takes the state machine from one state configuration to another, representing the complete response of the state machine to an occurrence of an event of a particular type.*

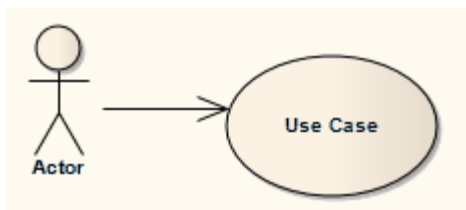
**5.1.3.32 Use**

A *Use* relationship indicates that one element requires another to perform some interaction. The *Use* (or *Usage*) relationship does not specify how the target supplier is used, other than that the source client uses it in definition or implementation. A *Use* relationship is a sub-typed [Dependency](#)<sup>[867]</sup> relationship.

You typically use the *Use* relationship in [Use Case diagrams](#)<sup>[676]</sup> to model how [Actors](#)<sup>[757]</sup> use system functionality ([Use Cases](#)<sup>[806]</sup>), or to illustrate usage dependencies between [Classes](#)<sup>[817]</sup> or [Components](#)<sup>[816]</sup>.

**Notes:**

- It is more usual (and correct UML) to have an [Associate connector](#)<sup>[855]</sup> between an Actor and a Use Case.
- To depict a usage dependency on a [Class](#)<sup>[727]</sup> or [Component](#)<sup>[730]</sup> diagram, draw a *Dependency* connector. Right-click on the Dependency, and select the **Dependency Stereotypes | Use** context menu option.

## Toolbox Icon



## OMG UML Specification

The OMG UML specification (*UML Superstructure Specification, v2.1.1, p. 138*) states:

*A usage is a relationship in which one element requires another element (or set of elements) for its full implementation or operation. In the metamodel, a Usage is a Dependency in which the client requires the presence of the supplier.*

### 5.1.4 UML Stereotypes

UML supports a large number of *stereotypes*, which are an inbuilt mechanism for logically extending or altering the meaning, display and syntax of a model element. Different model elements have different [standard stereotypes](#) <sup>[899]</sup> associated with them.

For further definition of stereotypes, see the OMG UML specification (*UML Superstructure Specification, v2.1.1, section 18.3.8, pp. 667-672*).

A stereotype is generally displayed as in the example below (where «myStereotype2» is the stereotype).

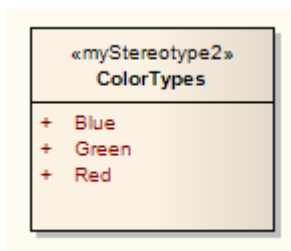

In some cases the stereotype causes the element to be [drawn differently](#) <sup>[900]</sup>, as below:

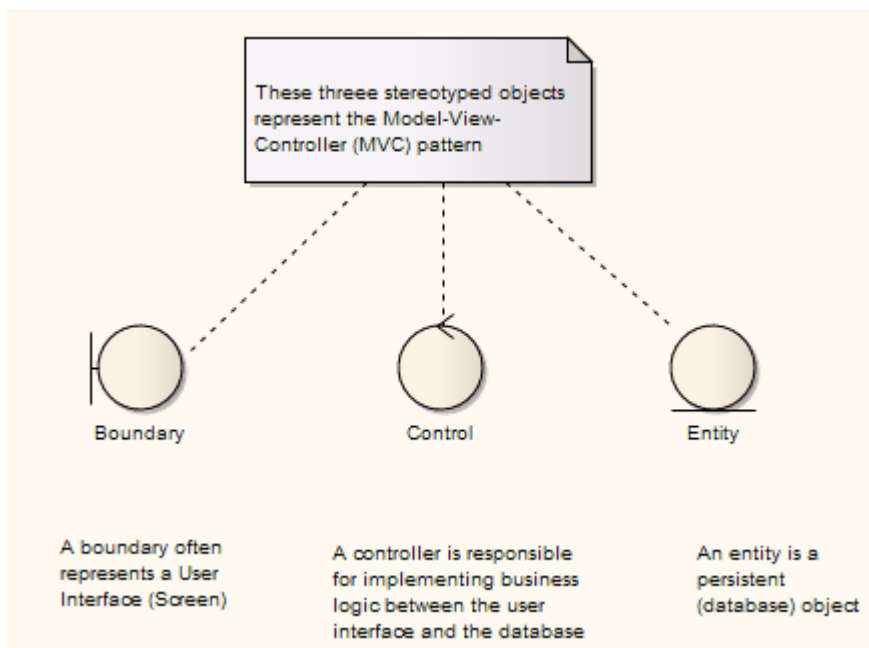

A metafile can be associated with the applied stereotype, as in the example below:

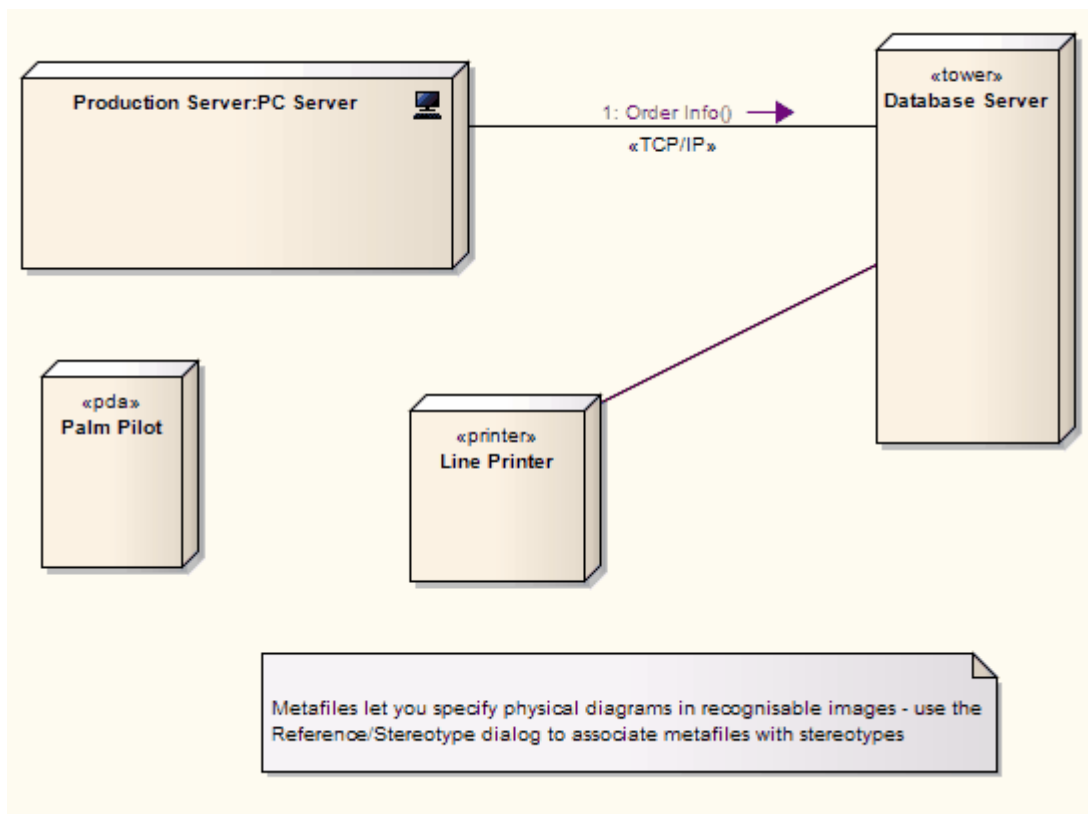

New, or customized, stereotypes can be created. Stereotypes can also be associated with new shapes, using either metafiles (image files) and colors or *Shape Scripts*, to apply non-UML shapes to elements and connectors. For further information on [customizing stereotypes](#)<sup>[1093]</sup> and applying [Shape Scripts](#)<sup>[1147]</sup>, see the [MDG Technology SDK](#)<sup>[1092]</sup> topic.



#### 5.1.4.1 Apply Stereotypes

Enterprise Architect enables you to apply one or more stereotypes to any UML construct, including:

- Elements (such as Classes and Objects)
- Relationships (such as Dependencies and Associations)
- Association Ends
- Attributes and Operations
- Operation Parameters.

To apply a stereotype to any UML construct, using the **Properties dialog**, select any one of the following steps:

1. In the **Stereotype** field, type the stereotype(s) to apply as a comma-separated list.
2. Click on the drop-down arrow and select the required stereotype from the list.
3. Click on the [ ... ] button to use the [Stereotype Selector](#)<sup>[897]</sup> dialog.

Stereotype:   

To apply a stereotype to an element using the **Properties window**, select any of the following steps:

1. In the **Stereotype** field, type the stereotype(s) to apply as a comma-separated list.
2. Click on the drop-down arrow and select the required stereotype from the list.

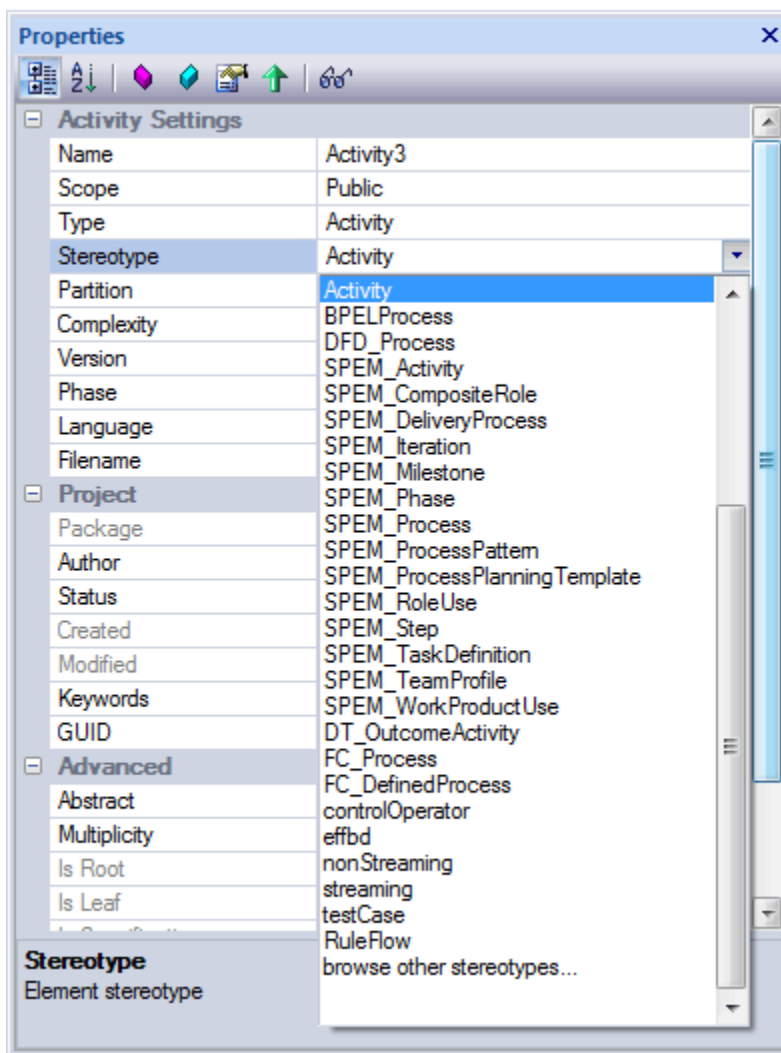

3. Select the **browse other stereotypes...** option in the drop-down list to use the [Stereotype Selector](#) <sup>[897]</sup> dialog.

#### 5.1.4.2 Stereotype Selector

The [Stereotype Selector](#) dialog enables you to [apply one or more stereotypes](#) <sup>[896]</sup> to a UML construct, from multiple stereotype sources such as Profiles or the [Custom Stereotypes](#) list. The appearance of the stereotype is influenced by the [stereotype visibility](#) <sup>[898]</sup> settings on the [Diagram Properties](#) dialog.

#### Select Stereotypes to Apply/Remove

1. On the element or connector [Properties](#) dialog, click on the [ ... ] button near the **Stereotype** field. The [Stereotype for:<object type>](#) dialog displays.

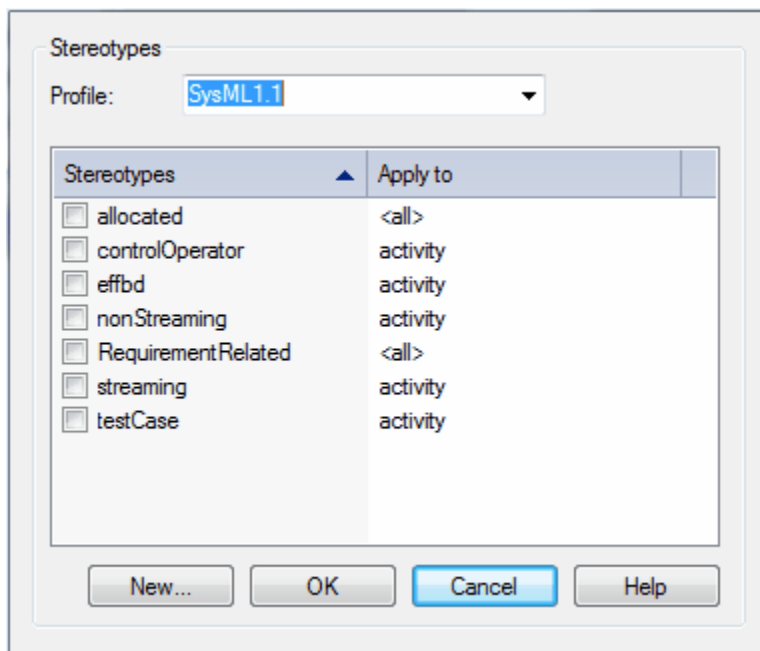

2. Click on the **Profile** drop-down arrow and choose the required stereotype source.
3. In the **Stereotypes** list, enable or disable the required stereotype by selecting or deselecting the checkbox against it.
4. Click on the **OK** button to apply the selection.

You can also define a new stereotype to apply to the required construct by clicking on the **New...** button and entering the name of the new stereotype when prompted.

### 5.1.4.3 Stereotype Visibility

You control the visibility of applied stereotypes using three options in the diagram [Properties](#) dialog. Select:

- The **Show Element Stereotypes** checkbox to show or hide all element stereotypes in the current diagram
- The **Show Feature Stereotypes** checkbox to show or hide all attribute and operation stereotypes in the current diagram
- The **Use Stereotype Icons** checkbox to display icons, instead of strings, for those stereotypes that have icons defined.

The example below shows how a Class would appear having multiple stereotypes applied to it:

**Use Stereotype Icons** disabled: displays all the applied stereotypes in a comma-separated string within gullimets.

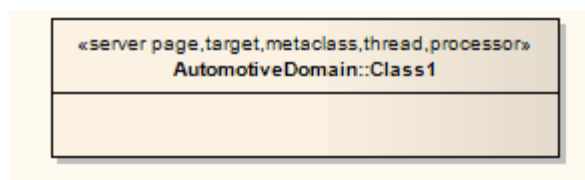

**Use Stereotype Icons** enabled: displays icons for those stereotypes with icons defined. Stereotypes without icons defined are still displayed in the comma-separated string.

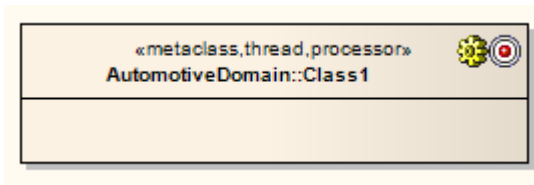

#### 5.1.4.4 Standard Stereotypes

Below is a list of standard element stereotypes (as provided in the *EABase.eap* base model), each enclosed by guillemets (« »):

Stereotype	Base Class
«access»	Permission
«become»	Flow
«call»	Usage
«copy»	Flow
«create»	Message
«derive»	Abstraction
«destroy»	Message
«document»	Abstraction
«executable»	Abstraction
«facade»	Package
«file»	Abstraction
«framework»	Package
«friend»	Permission
«global»	AssociationEnd
«implementation»	Class
«implementation»	Generalization
«import»	Permission
«instantiate»	Usage
«invariant»	Constraint
«library»	Abstraction
«local»	AssociationEnd
«metaclass»	Class
«parameter»	AssociationEnd
«postcondition»	Constraint
«powertype»	Class
«precondition»	Constraint

Stereotype	Base Class
«process»	Classifier
«refine»	Abstraction
«requirement»	Comment
«responsibility»	Comment
«self»	AssociationEnd
«send»	Usage
«stub»	Package
«table»	Abstraction
«thread»	Classifier
«trace»	Abstraction
«type»	Class
«utility»	Classifier

#### 5.1.4.5 Stereotypes with Alternative Images

You can alter the appearance of elements using stereotypes. This does not apply to elements that include Lifelines, such as those in Sequence diagrams.

If the stereotype has an associated metafile, when the stereotype is applied to a Class or other element that supports alternative graphical format, Enterprise Architect then draws the alternative image instead of the standard one.

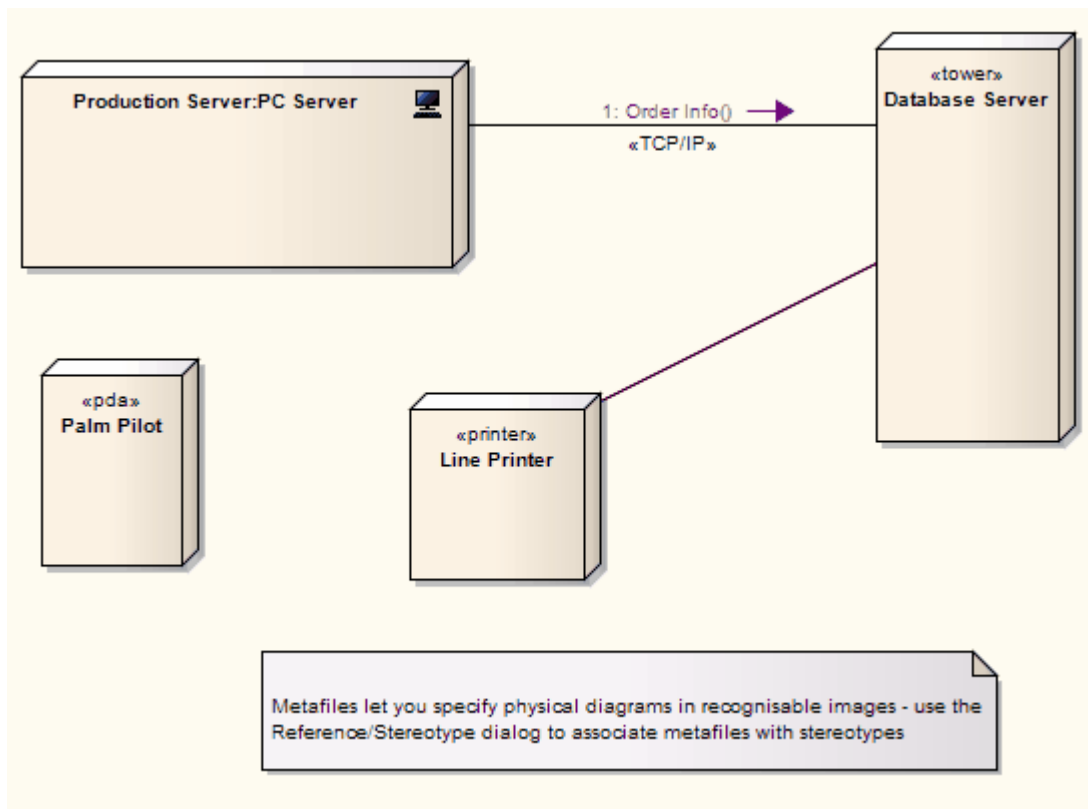



## 5.1.5 UML Patterns

### What is a Pattern?

Patterns are a group of collaborating Objects/Classes that can be abstracted from a general set of modeling scenarios. They are also known as parameterized collaborations.

Patterns are an excellent means of achieving re-use and building in robustness. As patterns are discovered in any new project, the basic pattern template from previous engagements can be re-used with the appropriate variable names modified for the current project.

Patterns generally describe how to solve an abstract problem, and it is the task of the pattern user to modify the pattern elements to meet the demands of the current engagement.

Before using a pattern it must first be [created](#)<sup>[902]</sup> as a standard UML diagram and then saved as an XML pattern file. This XML file can then be [imported](#)<sup>[904]</sup> as a UML resource that can be [used](#)<sup>[904]</sup> in any model.

### Sparx-Created GoF Patterns

To get you started with design patterns in Enterprise Architect, Sparx Systems provides you with an [MDG technology](#)<sup>[1083]</sup> for the patterns described in the book *Design Patterns - Elements of Reusable Object-Oriented Software* by Gamma et al., referred to as the 'Gang of Four' or GoF. These patterns are made available through a set of [Toolbox](#)<sup>[399]</sup> pages.

The pattern elements are drawn from the EABase.eap file, through the **Resources** window hierarchy. Therefore, if you are developing your model in a DBMS repository (or you inadvertently delete the GoF patterns from your .eap file) you can download them as a 'zip' file from [www.sparxsystems.com/uml\\_patterns.html](http://www.sparxsystems.com/uml_patterns.html).

Because the patterns are drawn from the **Resources** window, if you delete a pattern in the **Resources** window the equivalent **Toolbox** item cannot work. Therefore, if you cannot drop a pattern element from the **Toolbox**, check that it is still available in the **Resources** window.

### 5.1.5.1 Create a Pattern

To create a Pattern you first must model the Pattern as a standard UML diagram within Enterprise Architect. The following diagram was created from an example in the GoF book *Design Patterns - Elements of Reusable Object-Oriented Software* by Gamma et al.

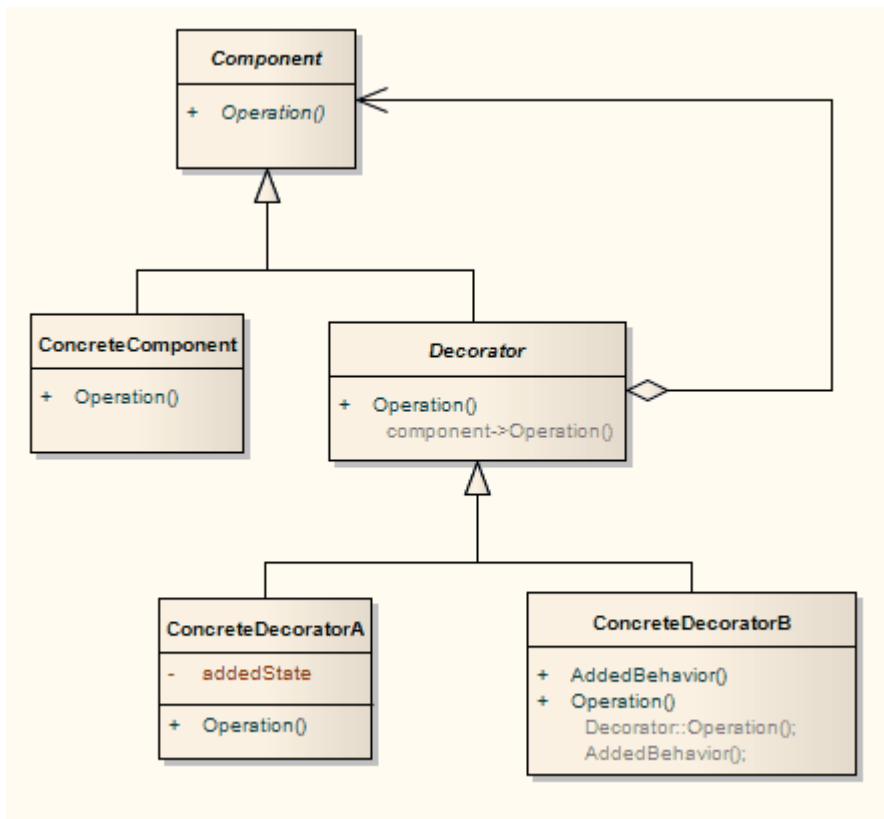

#### Notes:

- In the Corporate, Business and Software Engineering, System Engineering and Ultimate editions of Enterprise Architect, if security is enabled you must have [Manage Diagrams](#) <sup>198</sup> permission to save a diagram as a Pattern.
- If your source diagram contains information flows, the Information Items Conveyed and Information Flows Realized data is not copied into the Pattern.

### Save a Diagram as a Pattern

To save a diagram as a Pattern, follow the steps below:

1. Select the **Diagram | Save UML Pattern** menu option. The **Save Diagram as UML Pattern** dialog displays.

Pattern Name:

Filename:  ...

Category:  Version:

Notes:

Name	Type	Create	Merge	Instance	Type	Default	Comment
Client	Class	<input checked="" type="checkbox"/>	<input type="checkbox"/>	<input type="checkbox"/>	<input type="checkbox"/>	Client	This class uses onl...
ProductB1	Class	<input checked="" type="checkbox"/>	<input type="checkbox"/>	<input type="checkbox"/>	<input type="checkbox"/>	ProductB1	This class (a defin...
ProductB2	Class	<input checked="" type="checkbox"/>	<input type="checkbox"/>	<input type="checkbox"/>	<input type="checkbox"/>	ProductB2	This class (a defin...
AbstractProd...	Class	<input checked="" type="checkbox"/>	<input type="checkbox"/>	<input type="checkbox"/>	<input type="checkbox"/>	AbstractProductB	This class declares...
ProductA1	Class	<input checked="" type="checkbox"/>	<input type="checkbox"/>	<input type="checkbox"/>	<input type="checkbox"/>	ProductA1	This class (a defin...
ProductA2	Class	<input checked="" type="checkbox"/>	<input type="checkbox"/>	<input type="checkbox"/>	<input type="checkbox"/>	ProductA2	This class (a defin...
AbstractProd...	Class	<input checked="" type="checkbox"/>	<input type="checkbox"/>	<input type="checkbox"/>	<input type="checkbox"/>	AbstractProductA	This class declares...
ConcreteFact...	Class	<input checked="" type="checkbox"/>	<input type="checkbox"/>	<input type="checkbox"/>	<input type="checkbox"/>	ConcreteFactory2	This class impleme...
ConcreteFact...	Class	<input checked="" type="checkbox"/>	<input type="checkbox"/>	<input type="checkbox"/>	<input type="checkbox"/>	ConcreteFactory1	This class impleme...
AbstractFactory	Class	<input checked="" type="checkbox"/>	<input type="checkbox"/>	<input type="checkbox"/>	<input type="checkbox"/>	AbstractFactory	This class declares...

OK Cancel Help

2. In the **Pattern Name** field, type the Pattern name.
  3. In the **Filename** field, type a directory path and .XML filename into which to save the Pattern.
  4. In the **Category** field, type the Category under which the Pattern should be listed in **UML Patterns** (required).
  5. In the **Version** field, type the Pattern version number, and in the **Notes** field type any notes on the Pattern.
  6. Select the actions for the elements that are contained in the Pattern by selecting the appropriate checkboxes. These actions are performed when the Pattern is used (for more detail refer to the [Use a Pattern](#)<sup>[904]</sup> topic). The available actions are:
    - **Create**: Creates the Pattern element directly without modification
    - **Merge**: Merges the Pattern element with an existing element, enabling the existing element to take on the role of the selected Pattern element
    - **Instance**: Creates the Pattern element as an instance of an existing element
    - **Type**: Creates the Pattern element types as an existing element.
- Notes:**
- If your Pattern includes an Object element, you would use **Instance** to set the classifier of the Object to one of the Classes in the diagram onto which you are dropping the Pattern.
  - If your Pattern includes a Property (Port or Part) you would use **Type** to set the type of the Property to one of the Classes in the diagram onto which you are dropping the Pattern.
7. To change the name of one of the elements, double-click on the element to display the **Edit** dialog. From this dialog you can also add comments detailing the element's purpose.

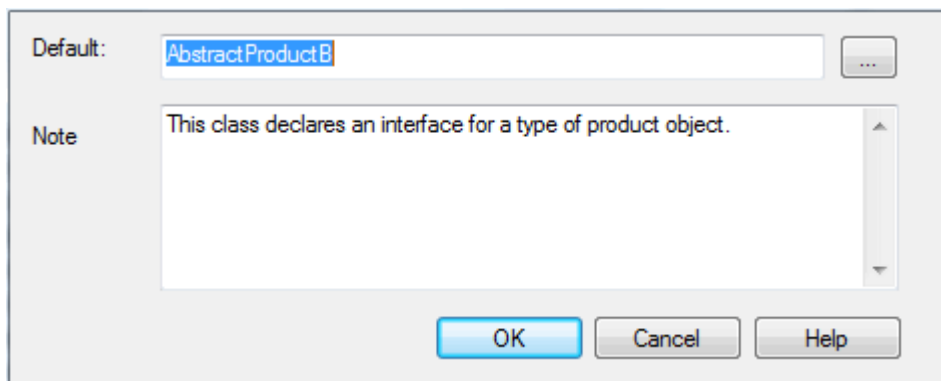

8. Click on the **OK** button twice to save the Pattern. Once saved you can [load it](#) into Enterprise Architect as a Pattern in the [Resources](#) window.

### 5.1.5.2 Import a Pattern

Before using a previously [created Pattern](#) file in a UML model, you must first import it into the model; it is then available from the [Resources](#) window and optionally from the [Toolbox](#). To import a UML Pattern you have previously saved, follow the steps outlined below:

1. Select the [Resources](#) window.
2. Right-click on the *UML Patterns* node. The context menu displays.
3. Select the **Import UML Pattern** menu option. The [Select UML Pattern Import Filename](#) dialog displays.
4. Locate the XML file to import.
5. Click on the **Open** button to import the Pattern.

The imported Pattern is placed in the appropriate category as defined in the XML file. If the category does not already exist under UML Patterns, a new one is created.

Gang of Four patterns are integrated with Enterprise Architect in the *EABase.eap* file. However, if you create your model in a DBMS repository (or you inadvertently delete the patterns from your model *.eap* file) you can use the above procedure to download examples of the Gang of Four patterns from the [GoF Patterns zip file](#) on the Sparx Systems website.

### 5.1.5.3 Use a Pattern

Using a Pattern enables you to use items defined in the Pattern with the UML model. Using Patterns enables you to rapidly create template solutions for code structures that perform the same type of task in other situations.

To use a Pattern that you have [previously imported](#) into the model, follow the steps below:

1. Open the diagram into which to add the UML Pattern.
2. Select the [Resources](#) window.
3. Expand the *UML Pattern* folder and find the Pattern to add.
4. Either:
  - Right-click on the Pattern and select the **Add Pattern to Diagram** context menu option or
  - Drag and drop the Pattern from the [Resources](#) window onto the diagram.
 (You can also view the Pattern details in read-only mode by selecting the **View Pattern Details** context menu option.)

The [Add Pattern](#) dialog displays.

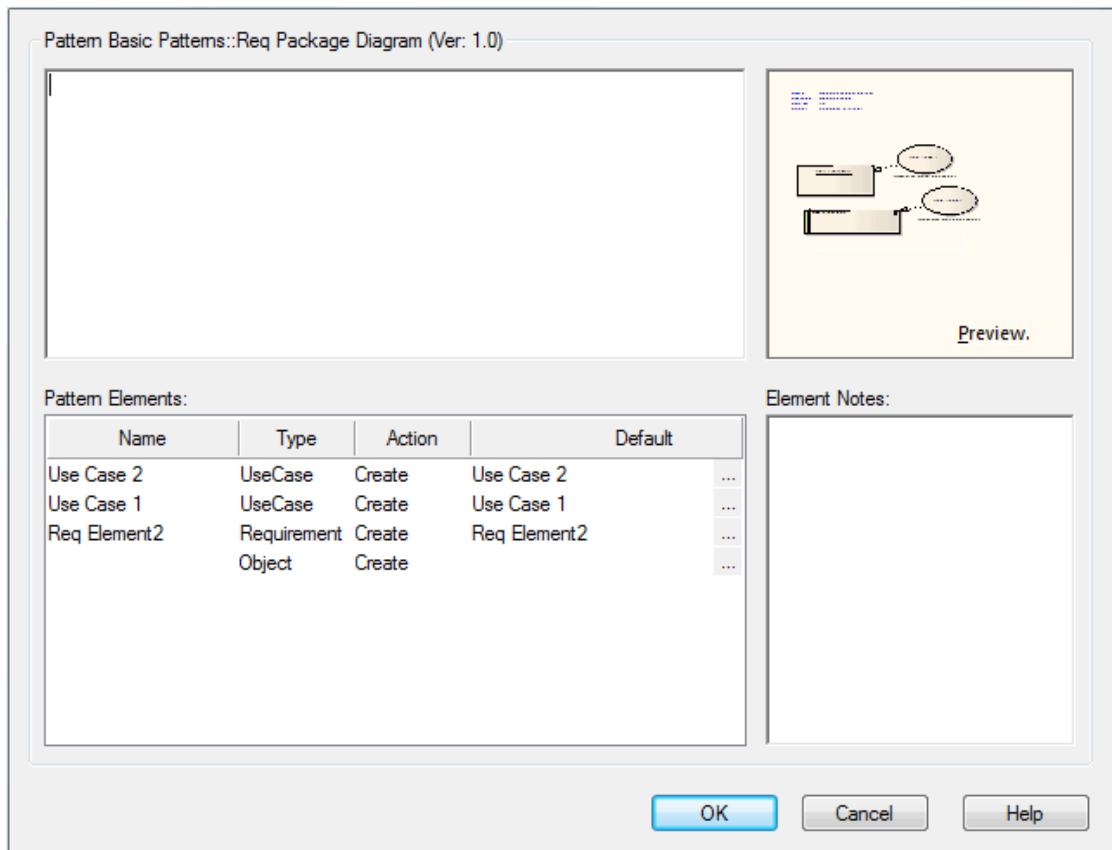

Panel	Use to
Preview	Display a preview of the Pattern; click on the <b>Preview</b> link to open a view of the Pattern and drag the sides into as large a picture as you require.
Pattern Elements	<p>Access the individual elements contained in the Pattern.</p> <p>From here you can:</p> <ul style="list-style-type: none"> <li>select the action for the individual element (<i>Create</i>, <i>Merge</i>, <i>Instance</i> or <i>Type</i>, as applicable for each element) by clicking on the drop-down arrow, or</li> <li>modify the default of the Pattern element (see below) or - for a merged element - choose the namespace, by clicking on the [ ... ] button on the right of the <b>Default</b> entry.</li> </ul>
Element Notes	Display the comments that describe the element in the Pattern. Highlight an element in the <b>Pattern Elements</b> panel to view the notes.

- Once the appropriate selections have been made, click on the **OK** button to import the Pattern into the model, recreating the original diagram with new GUIDs.

### Modify Pattern Element Default

To change the default of the Pattern element, follow the steps below:

- From the **Add Pattern** dialog select the individual element in the **Pattern Element** panel.
- Click on the [ ... ] button to display the **Edit** dialog. The specific method for changing the element name is dependant upon the entry in the **Action** column of the **Pattern Elements** panel.
- If the **Action** entry is **Create**, then in the **Default** field in the **Edit** dialog delete the existing value and type your own, user-defined value. Click on the **OK** button. The element default is updated on the **Add Pattern** dialog.
- If the **Action** entry for the element is **Merge**, in the **Edit** dialog click on the [ ... ] button to browse to an

existing element classifier. The [Select <Item>](#)<sup>[515]</sup> dialog displays.

5. Locate and select an existing element classifier. You can restrict the number of choices by selecting the elements from a specific namespace; to do this, click on the **In Namespace** drop-down arrow and select a namespace. For more information regarding setting element classifiers see the [Using Classifiers](#)<sup>[520]</sup> topic.

## 5.1.6 UML Profiles

### What are UML Profiles?

UML Profiles provide a means of extending UML, which enables you to build UML models in particular domains. They are based on additional [stereotypes and Tagged Values](#)<sup>[912]</sup> that are applied to elements, attributes, methods, connectors, connector ends and so on. A Profile is a collection of such extensions that together describe some particular modeling problem and facilitate modeling constructs in that domain. For example, the UML Profile for XML describes a set of extensions to basic UML model elements to enable accurate modeling of XSD Schemas (see *Modeling XML Applications with UML*, David Carlson, p. 310).

Enterprise Architect has a generic UML Profile [mechanism](#)<sup>[907]</sup> for loading and working with different Profiles. UML Profiles for Enterprise Architect are specified in XML files, with a specific format; see the [examples](#)<sup>[915]</sup> in this section. You can [import](#)<sup>[908]</sup> these XML files into Enterprise Architect as part of an [MDG Technology](#)<sup>[1066]</sup> or through the **Resources** window. Once imported, you can drag and drop Profile elements onto the current diagram. Enterprise Architect attaches the stereotype, Tagged Values and default values, notes and even metafile if one is specified, to the new element. You can also drag and drop attributes and operations onto existing Classes and have them immediately added with the specified stereotype and values.

The imported Profile also automatically generates a page of elements and relationships in the **Toolbox**.

#### Note:

To control the appearance of elements, you can also set a default element template. For more information, see the [Set Element Templates Package](#)<sup>[542]</sup> topic.

### Profiles in the Resources Window

The **Resources** window contains a tree structure with entries for items such as MDG Technologies, Documents, Stylesheets, Matrix profiles and UML Profiles. The *UML Profiles* node initially contains no entries; to be able to use Profiles you must import them into Enterprise Architect from supplied XML files.

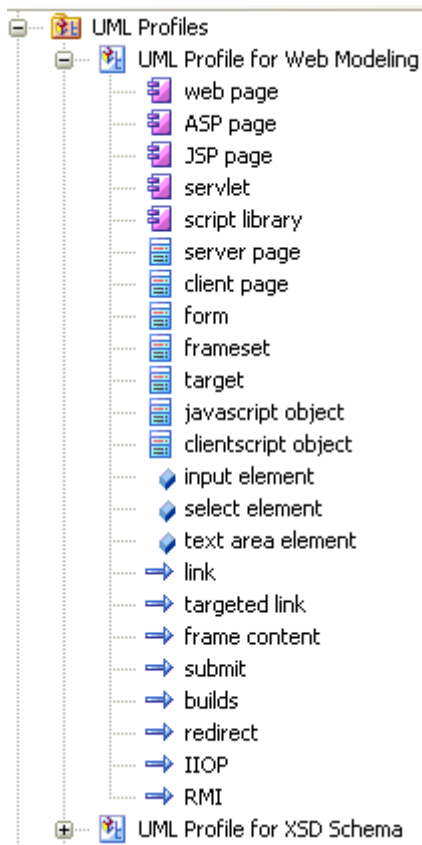

Items in the Profile represent stereotypes. These can be applied to UML elements in the following ways:

- Stereotypes that apply to elements such as *Classes* and *interfaces* can be dragged directly from the **Resources** window to the current diagram, automatically creating a stereotyped element. Alternatively, they can be dragged onto existing elements, automatically applying them to the element.
- Stereotypes that apply to *attributes* can be drag-and-dropped onto a host element (such as a Class); a stereotyped attribute is automatically added to the element's feature list.
- Stereotypes that apply to *operations* are like those that apply to attributes; drag-and-drop onto a host element to add the stereotyped operation.
- Stereotypes that apply to *connectors* such as *associations*, *generalizations*, *messages* and *dependencies* are added by selecting them in the **Project Browser**, then clicking on the start element in a diagram and dragging to the end element (in the same manner as adding normal connectors). A stereotyped connector is added.
- Stereotypes that apply to *association ends* can be added by dragging the connector end element over the end of an Association in the diagram.

To get you started, some Profiles are supplied on the Sparx Systems website at [www.sparxsystems.com/uml\\_profiles.htm](http://www.sparxsystems.com/uml_profiles.htm). You can download these and import them into Enterprise Architect. Over time Sparx Systems intend to expand the range of Profiles, the content of each Profile and the degree of customization possible in each Profile.

You can also create your own Profiles to describe modeling scenarios specific to your development environment. For more information see the [MDG Technology SDK<sup>\[1092\]</sup>](#) topic.

### 5.1.6.1 Use Profiles

This topic describes the use of Profiles for UML modeling, including the following tasks:

- [How to import a UML Profile<sup>\[908\]</sup>](#) for use in a model
- [How to add Profile Objects and Features to a diagram<sup>\[909\]</sup>](#)
- [Use of Tagged Values in Profiles<sup>\[910\]</sup>](#)
- [How to synchronize stereotyped Tagged Values and constraints<sup>\[910\]</sup>](#)

A Technology Developer might create a new Profile, which they can save (export) to disk for future UML

models. The processes of [creating](#) and [exporting](#) a new UML Profile are described in the [MDG Technology SDK](#) topic.

### 5.1.6.1.1 Import a UML Profile

#### Note:

This topic describes importing a stand-alone Profile. You can also embed Profiles in an [MDG Technology](#) and [import](#) the Technology file into the Enterprise Architect installation directory.

To import a Profile you must have a suitable Profile XML file, such as the Profiles supplied on the Sparx Systems website at [www.sparxsystems.com/uml\\_profiles.htm](http://www.sparxsystems.com/uml_profiles.htm). If the Profile includes references to any metafiles, they should be in the same directory as the Profile XML file.

## Import a Profile

To import a Profile, follow the steps below:

1. Open the **Resources** window (**View | Other Project Tools | Resources**).
2. Right-click on the *UML Profiles* tree node and select the **Import Profile** context menu option. The **Import UML Profile** dialog displays.

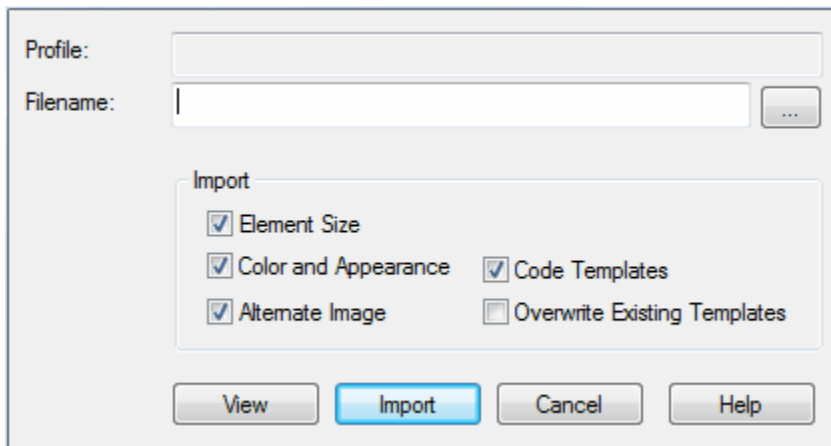

3. Locate the XML Profile file to import using the [ ... ] (Browse) button.
4. Set the required import option checkboxes for all stereotypes defined in the Profile; you can select:
  - **Element Size** - to import the element size attributes
  - **Color and Appearance** - to import the color (background, border and font) and appearance (border thickness) attributes
  - **Alternate Image** - to import the metafile image
  - **Code Templates** - to import the code templates if they exist
  - **Overwrite Existing Templates** - to overwrite any existing code templates defined in the current project.
5. Click on the **Import** button. The Profile is added to the *UML Profiles* folder.



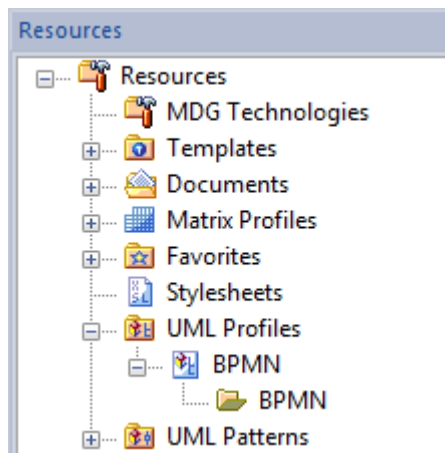

If the Profile already exists, Enterprise Architect prompts you to overwrite the existing version and import the new one (or cancel). Once the import is complete, the Profile is ready to [use](#)<sup>[909]</sup>.

#### 5.1.6.1.2 Add Profile Objects and Features to a Diagram

After you have imported a Profile into the **Resources** window, the profiled objects (elements and connectors) and features (attributes and operations) are available from the expanded Profile folder in the window and from the appropriate pages of the [Toolbox](#)<sup>[399]</sup> (click on the **More tools** option at the top of the **Toolbox**).

Similarly, when you import an [MDG Technology](#)<sup>[1066]</sup>, it adds the appropriate pages of profiled elements and connectors to the **Toolbox**.

**To add a Profile-based element** to a diagram, click on the element in the **Toolbox** page or the **Resources** window, and drag it onto the diagram.

**To add a Profile-based connector** to a diagram, click on the connector in the **Toolbox** page or **Resources** window, then click on the source element in the diagram and drag it to the target.

You can also drag the connector from the **Resources** window to the source, which automatically displays the following list box. Select a target element from the list to create the connector to that target.

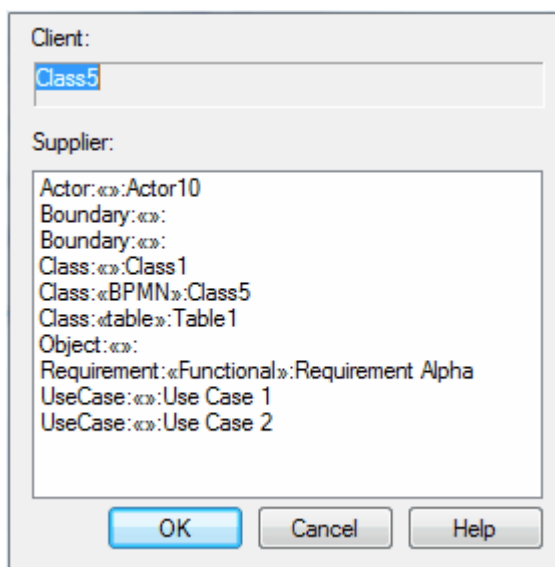

**To add a profile-based attribute or operation** to a diagram, click on it in either the **Toolbox** page or the **Resources** window, and drag it onto the host element on the diagram. The system prompts you to enter a name for the feature.

### 5.1.6.1.3 Tagged Values in Profiles

Stereotypes within a UML Profile can have one or more associated Tagged Values. When you create an element based on a UML Profile Stereotype by dragging from the **Resources** window to a diagram, any associated Tagged Values are added to the element as well. Tagged Values and Profiles are an excellent way to extend the use of Enterprise Architect and the power of UML modeling.

For example, in the UML Profile for XSD, there is an *XSDComplexType* stereotype, which has the following Tagged Value declaration:

```
<TaggedValues>
<Tag name="mixed" description="Determines whether this element can contain mixed element and character content. See the W3C XML Schema recommendation"/>
<Tag name="modelGroup" description="Overrides the package-level default model group" values="all | sequence | choice" default="choice"/>
<Tag name="memberNames" description="Overrides the package-level default for naming complexType definitions"/>
</TaggedValues>
```

When you create an element from the *XSDComplexType* stereotype (by dragging from the **Profile Elements** page of the **Toolbox** onto a diagram), the Tagged Values are added automatically.

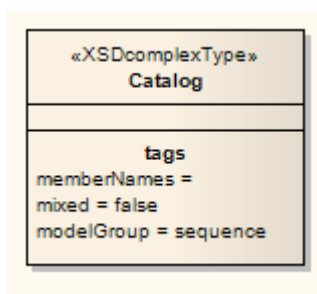

Tagged Values that have default values are automatically set and displayed in the element *tags* section, if applicable. When you select the element, the **Tagged Values** window displays all the associated tags, including ones that have no value set. Also note that Tagged Values in the Profile that have a *Values* section (for example, *values="element | attribute | both" default="both"*) enable you to select the non-default values from a drop-down list. (See the *enum* Tagged Value Type in the [Predefined Structured Types](#) <sup>[1166]</sup> topic.) Where no *Value* list exists, the tag accepts free text.

### 5.1.6.1.4 Synchronize Tagged Values and Constraints

When you create an element, attribute, operation or link from a UML Profile item, you add the Tagged Values and constraints from the Profile. Over time you might modify the constraints or the notes and tags of the Tagged Values of a particular profiled item, so the items already created might be missing additional Tagged Value tags and notes, or constraints.

Similarly, you might have manually set the stereotype on a set of elements and now want them to receive the Tagged Values and constraints associated with that stereotype.

To make sure you have all the related Tagged Values and constraints, use the **Synch Tagged Values and Constraints** function. This operates in two ways:

- If the Profile was created in an MDG Technology File and is not held in the **Resources** window
- If the Profile is held in the **Resources** window.

### Synchronize Items In MDG Technology File

When an MDG Technology file is deployed in Enterprise Architect, the Profile is accessed through the **Toolbox** pages also defined in the file. The profiled elements in these **Toolbox** pages automatically trigger an additional context menu option, **Synchronize Stereotype**.

The MDG Technology can be an in-house customized Add-In, or an external technology such as those provided with Enterprise Architect; for example, BPMN 1.1.

To synchronize elements created using the MDG Technology pages of the **Toolbox**, follow the steps below:

1. Open a diagram containing elements to be synchronized. Ensure that the **Toolbox** displays pages containing the stereotyped profile elements from the MDG Technology.

**Note:**

The diagram does not necessarily have to contain profiled elements. The function operates from the **Toolbox**. However, you might prefer to see the immediate effect of the synchronization on element properties and Tagged Values, by opening an appropriate diagram at the start.

2. Right-click on the element profile in the **Toolbox** (for example, the BPMN 1.1 *Activity* element). The **Toolbox** context menu displays.
3. Click on the **Synchronize Stereotype** menu option. The **Synch Profiled Elements** dialog displays.

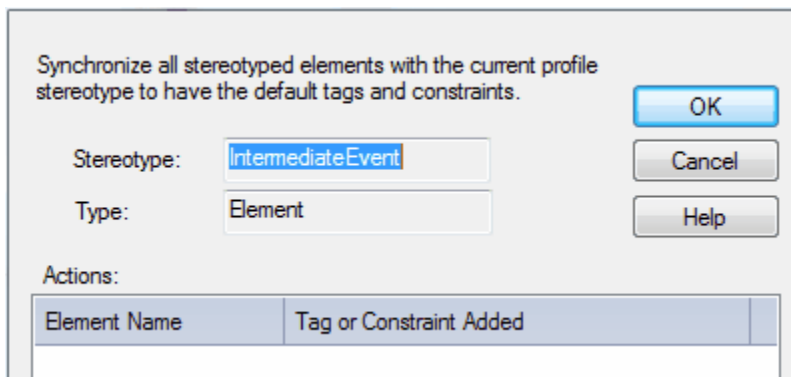

4. Click on the **OK** button to proceed. The **Actions** list is populated with the items that have been modified and the changes that were made.

You can review any changes by displaying the element **Properties** dialog and by opening the **Tagged Values** window and clicking on an appropriate profiled element.

You can also quickly synchronize the tags and constraints of a single element in a diagram by dragging the updated profile element from the **Toolbox** page onto the element in the diagram. Select the **Apply «stereotype»** context menu option.

### Synchronize Items In Resources Window

To synchronize elements created using a Profile in the **Resources** window, follow the steps below:

1. Locate the required UML Profile in the **Resources** window.
2. Locate the stereotyped profile element.
3. Right-click on it to display the context menu, and select the **Synch Tagged Values and Constraints** option. The **Synch Profiled Elements** dialog displays.

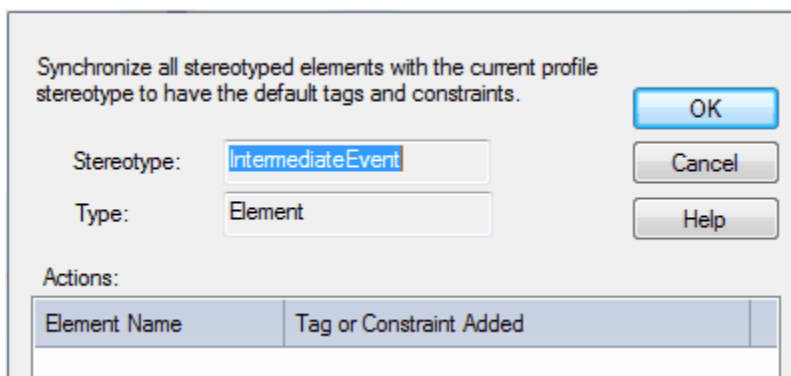

4. Click on the **OK** button to proceed. The **Actions** list is populated with the items that have been modified and the changes that were made.

### 5.1.6.2 Profile References

#### UML Profile XML File Format Information

Enterprise Architect provides a facility to import pre-defined elements, operations, attributes and connectors as a source of re-useable components that meet common modeling requirements (such as profiles for XML schema and for business process modeling). This topic provides a quick list of the types of data that can be pre-defined and the characteristics of each type.

This topic gives you a reference to:

- [Supported Types](#)<sup>[912]</sup> of stereotype with Tagged Values and/or constraints
- [Profile Structure](#)<sup>[913]</sup>
- [Supported Attributes](#)<sup>[914]</sup>
- [Example of the XML file that constitutes a Profile](#)<sup>[915]</sup>

#### 5.1.6.2.1 Supported Types

A UML profile is made up of one or more stereotypes that might have Tagged Values and constraints. The table below and the [Supported Attributes](#)<sup>[914]</sup> table define what can be stereotyped and what information must be supplied.

##### List of All Supported Types in AppliesTo/Apply Node

AppliesTo / Apply	Type	Tags	Constraint	Metafile
"actor"	Element	Yes	Yes	Yes
"package"	Package	Yes	Yes	Yes
"usecase"	Element	Yes	Yes	Yes
"collaboration"	Element	Yes	Yes	Yes
"class"	Element	Yes	Yes	Yes
"table"	Element	Yes	Yes	Yes
"component"	Element	Yes	Yes	Yes
"node"	Element	Yes	Yes	Yes
"object"	Element	Yes	Yes	Yes
"sequence"	Element	Yes	Yes	Yes
"entity"	Element	Yes	Yes	Yes
"screen"	Element	Yes	Yes	Yes
"GUIElement"	Element	Yes	Yes	Yes
"requirement"	Element	Yes	Yes	
"state"	Element	Yes	Yes	
"activity"	Element	Yes	Yes	Yes
"interface"	Element	Yes	Yes	Yes
"event"	Element	Yes	Yes	
"issue"	Element	Yes	Yes	
"change"	Element	Yes	Yes	
"hyperlink"	Element		Yes	

AppliesTo / Apply	Type	Tags	Constraint	Metafile
"attribute"	Attribute	Yes	Yes	
"operation"	Operation	Yes	Yes	
"association"	Connector	Yes	Yes	
"associationEnd"	AssociationEnd			
"generalization"	Connector	Yes	Yes	
"dependency"	Connector	Yes	Yes	
"transition"	Connector	Yes	Yes	
"objectflow"	Connector	Yes	Yes	
"startnode"	Element	Yes	Yes	
"stopnode"	Element	Yes	Yes	
"note"	Element	Yes	Yes	
"decision"	Element	Yes	Yes	
"aggregation"	Connector	Yes	Yes	

### 5.1.6.2.2 Profile Structure

UML Profiles for Enterprise Architect are distributed in XML format. The file has the following format:

#### General Header Details

```
<?xml version="1.0" encoding="utf-8" ?>
<UMLProfile profiletype="uml2">
  <!--Profile name, version number and general notes -->
  <Documentation id="XSDSchema" name="UML Profile for XSD Schema" version="1.0" notes="Defines a set of
stereotypes and tagged values for XSD Schemas"/>
  <!-- The profile content -->
  <Content>
  <!-- List of stereotypes used in this profile. Can also include tagged values, constraints, metafile and descriptive
comments-->
  <Stereotypes>
```

#### Stereotype Definitions

The header is followed by one or more Stereotype definitions; for example:

```
<!-- «XSDComplexType» -->
<Stereotype name="XSDComplexType" notes="ComplexType definition generated in XML Schema">
  <AppliesTo>
  <Apply type="class"/>
  </AppliesTo>
  <TaggedValues>
  <Tag name="mixed" description="URI to unique target namespace"/>
  <Tag name="modelGroup" description="Default model group used when generating complexType definitions for this
Schema" values="all | sequence | choice" default="choice"/>
  <Tag name="attributeMapping" description="Default for generating UML attributes as elements, attributes or both
within complexTypes" values="element | attribute | both" default="both"/>
  <Tag name="roleMapping" description="Prefix associated with namespace"/>
  <Tag name="memberNames" description="Schema version"/>
  </TaggedValues>

  <Constraints>
  <Constraint name="" type="" notes=""/>
  </Constraints>
</Stereotype>
```

Note the specification of Stereotype name and notes. Also note the use of Tagged Values to set properties for the Profile element. The Tagged Values can have a default value, can be empty and can specify enableable

values. Tagged Values are edited in the **Properties** window of an element, method, attribute or connector.

You can also specify the default size, default comment and Metafile for drawing an element; see the fragment below:

```
<Stereotype name="Router" cx="130" cy="100" notes="" metafile="router.emf">
```

In the above example, the metafile shape for this element is specified as 'router.emf'; when you load this Profile, the .emf file must be in the same directory as the Profile, otherwise the load fails.

Also note how to specify a default comment for an element. All white space between lines is ignored. To force a line break, use the \n character. To force tabs, use \t.

```
<Comment>
  Some text here about how this works\n\t
  with comments being imported from the XML description
  in one long row.
</Comment>
```

The example above would import like this:

```
Some text here about how this works
with comments being imported from the XML description in one long row.
```

### 5.1.6.2.3 Attributes Supported in XML Profile

The table below lists the three main types of object you can define for the main XML element nodes in an XML Profile document. These are the:

- Stereotype, which creates a visible entry in the *UML Profile* folder in the **Resources** window
- Tagged Values, which are additional properties that an element or connector support
- Constraints that apply to the model element.

Type	Attribute	Optional	Notes
stereotype	cx	Yes	<b>Deprecated.</b> Initial x coordinate of element.
	cy	Yes	<b>Deprecated.</b> Initial y coordinate of element.
	_image	Yes	Shape script definition.
	_imageFile	Yes	<b>Deprecated.</b> Location of image file (.wmf).
	metafile	Yes	Filename of associated metafile; this <b>MUST</b> be in the same directory as the Profile XML.
	name	No	Stereotype name.
	notes	Yes	Notes visible in browser.
	_sizeX	Yes	Initial width of the element, in pixels at 100% zoom.
	_sizeY	Yes	Initial height of the element, in pixels at 100% zoom.
tag	default	Yes	A default value; for example, 'true'.
	description	Yes	A description of the tag; appears in the tag tab and for elements in the <b>Properties</b> window setting notes.
	name	No	Tag name.
	values	Yes	List of possible values; values separated by '   ' (<space> <space>); for example, 'true   false'. For elements, populates the drop combo in the tag section of the docked <b>Properties</b> window.
constraint	name	Yes	Constraint name.
	notes	No	Additional explanatory notes.
	type	Yes	Constraint type (for example, 'pre' for precondition, 'post' for postcondition).

### 5.1.6.2.4 Example Profile

Below is an example UML Profile showing the structure and use of the file:

```

<?xml version="1.0" encoding="UTF-8"?>
<UMLProfile>
  <Documentation id="EAExample" name="UML Profile for Example" version="1" notes="An example set of
stereotypes and tagged values"/>
  <!-- The profile content -->
  <Content>
    <!-- List of stereotypes used in this profile-->
    <Stereotypes>
      <!--A profile is a list of stereotypes, that apply to elements, connectors and features in a UML
model. Stereotypes can have set tagged values, constraints,
Valid targets, default dimensions. The examples below are a good starting point -->
      <Stereotype name="SimpleStereotype" notes="Place notes about stereotype here"
metafile="router.emf">
        <!-- Place a list of types that this will apply to ...
valid types are any UML element (class, interface, component,
aggregation, generalization, association, transition, operation and attribute. Make sure
you use lowercase names, XML is case sensitive-->
        <AppliesTo>
          <Apply type="class"/>
          <Apply type="interface"/>
          <Apply type="node"/>
        </AppliesTo>
        <!--Add one or more tagged values for this stereotype. These are automatically added
to the target element when created
Note that you can specify a default value using "default=" and a pick list of values for
example " true | false" note the use of a " | " to separate values -->
        <TaggedValues>
          <Tag name="hasNamespace" description="Indicates element is bound to
Namespace" default="true" values="true | false"/>
          <Tag name="targetNamespacePrefix" description="Prefix associated with
namespace"/>
        </TaggedValues>
        <!-- Zero or more constraints to apply to element - specify name, type and notes -->
        <Constraints>
          <Constraint name="constraint1" type="pre" notes="My Notes"/>
        </Constraints>
      </Stereotype>
      <!-- End of stereotype. When writing your own, you can duplicate a stereotype selection as
above and
change it to start work on a new stereotype-->
      <!-- «AnotherExample» -->
      <Stereotype name="AnotherExample" cx="130" cy="100" notes="This element has a default
height and width specified">
        <AppliesTo>
          <Apply type="class"/>
          <Apply type="operation"/>
          <Apply type="attribute"/>
        </AppliesTo>
        <TaggedValues>
          <Tag name="memberNames" description="Schema version"/>
        </TaggedValues>
        <Constraints>
          <Constraint name="constraint1" type="pre" notes="My Notes"/>
        </Constraints>
      </Stereotype>
      <!-- «Aggregation» -->
      <Stereotype name="aggregationLink" type="weak" notes="">
        <AppliesTo>
          <Apply type="aggregation"/>
        </AppliesTo>
      </Stereotype>
      <!-- «Composition» -->
      <Stereotype name="compositionLink" type="strong" notes="">
        <AppliesTo>
          <Apply type="aggregation"/>
        </AppliesTo>
      </Stereotype>
      <!-- «IndexKey» -->
      <Stereotype name="UniqueID" notes="">
        <AppliesTo>
          <Apply type="operation"/>

```

```

        </AppliesTo>
        <TaggedValues>
            <Tag name="indexed" description="indicates if indexed or not" values="true
| false" default="true"/>
        </TaggedValues>
        <Constraints>
            <Constraint name="constraint1" type="pre" opType="pre" notes="My Notes"/
>
            <Constraint name="constraint2" type="pre" opType="post" notes="My
Notes"/>
        </Constraints>
    </Stereotype>
    <!-- «Attribute» -->
    <Stereotype name="atname" notes="">
        <AppliesTo>
            <Apply type="attribute"/>
        </AppliesTo>
        <Constraints>
            <Constraint name="constraint1" type="pre" notes="My Notes"/>
        </Constraints>
    </Stereotype>
    <!-- «Association» -->
    <Stereotype name="assocname" notes="">
        <AppliesTo>
            <Apply type="association"/>
        </AppliesTo>
        <Constraints>
            <Constraint name="constraint1" type="pre" notes="My Notes"/>
        </Constraints>
    </Stereotype>
</Stereotypes>
</Content>
</UMLProfile>

```



## 5.2 Specialized UML Models

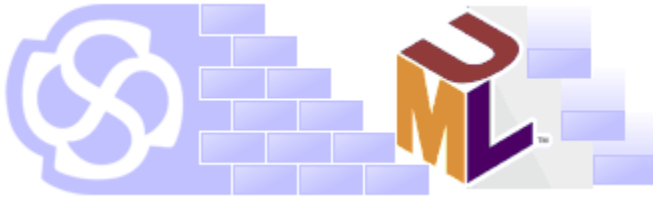

Enterprise Architect provides specific modeling tools for a range of specialized model types, supporting:

- [Requirements modeling](#) <sup>[917]</sup>
- [Business modeling](#) <sup>[930]</sup>
- [Business Rule modeling](#) <sup>[934]</sup>
- [BPMN modeling](#) <sup>[952]</sup>
- [BPEL modeling](#) <sup>[958]</sup>
- [Systems engineering](#) <sup>[986]</sup> (with SysML)
- [Data modeling](#) <sup>[1011]</sup>
- [XML Schema modeling \(XSD\)](#) <sup>[1039]</sup>
- [Web Service modeling \(WSDL\)](#) <sup>[1049]</sup>
- [SPEM](#) <sup>[1061]</sup>
- Various other modeling languages such as Archimate, SoaML and ICONIX, as [MDG Technologies](#) <sup>[1068]</sup> available in the Enterprise Architect install directory
- [The use of other technologies from file or internet sites.](#) <sup>[1070]</sup>

### 5.2.1 Requirements

#### Introduction

This section describes the Enterprise Architect *Requirements Management* facilities, and discusses:

- What requirements are
- How requirements are generated and organized
- How Enterprise Architect supports and simplifies Requirements Management.

Additional discussion of the management of requirements in Enterprise Architect can be found in the *Requirements Management with Enterprise Architect* [white paper](#) on the Sparx Systems website.

#### What is a Requirement?

Requirements are essentially what the system, application or business process *is required* to do. A requirement can be broad and high level, defining - for example - a need for a process to update a particular database. A requirement can also be more specialized and detailed, recording the expectation that - for example - a system call must always be acknowledged by return. Detailed requirements can be organized into a hierarchy culminating in a high-level requirement, so that satisfying each of the detailed requirements results in meeting the higher-level requirements and ultimately the top-level requirement. This hierarchical structure helps manage the complexity of large systems with thousands of requirements and many processes being developed to implement the requirements.

#### Gathering Requirements

Gathering requirements is typically the first step in developing a solution, be it for developing a system or a process. Requirements are gathered from all parties expected to use, maintain or benefit from the solution, and are organized into groups, functional areas and hierarchies as necessary. They can be transcribed into a spreadsheet or a requirements gathering or management tool, or they can be created in an integrated modeling tool such as Enterprise Architect.

#### Requirements Management and Enterprise Architect

The management of requirements is one of the more problematic disciplines in software development, for reasons such as:

- Diverse group input into the requirements
- Organizational boundary divisions

- Tool boundary divisions
- Volatility of requirements
- Imprecision and ambiguity in natural languages.

These can cause issues with:

- Traceability and
- Integration with change and configuration management systems.

Enterprise Architect can reduce or eliminate these problems in Requirements Management; it is one of the few UML tools that integrate Requirements Management with other software development disciplines in the core product, by defining requirements within the model. Within Enterprise Architect, you can:

- [Create](#) [918] and [view](#) [928] requirements as entities and properties directly in the model
- Collate the requirements in an external CSV file and then [import](#) [922] them into your model
- Detail [use cases](#) [924] and scenarios directly in the model
- Enter [standard attributes](#) [919] (properties) for each requirement, such as difficulty, status and type, and [define your own attributes](#) [920] (properties)
- [Trace](#) [928] requirements to Use Cases, business rules, test cases and analysis artifacts (using, for example, the [Relationship Matrix](#) [1261])
- Trace and view the impact of [changes](#) [928] on requirements (through, for example, the [Traceability](#) [1253] window) and [review the changes](#) [928] themselves
- Create customer-quality MS Word and HTML [reports](#) [929] on requirements.

#### Note:

All of these features are illustrated by examples in the *EAExample.eap* model, provided as part of your Enterprise Architect installation in the Enterprise Architect Program Files directory:

```
..\Program Files\Sparx Systems\EA
```

### 5.2.1.1 Create Requirements

Within Enterprise Architect you can create external Requirement elements in a number of ways, such as:

- Dragging a *Requirement* icon from the **Toolbox** into a specific diagram (which also adds the Requirement to the diagram's parent package - see below)
- Generating an element within a specific package in the **Project Browser** - see below
- Importing requirements from a spreadsheet application such as Excel, via [CSV](#) [922]
- Creating Requirement elements on the [Element List](#) [1258] for the selected package or diagram
- [Converting an internal responsibility](#) [926] into an external element, in a selected target package
- Importing requirements from another requirements management tool, such as Telelogic DOORS (in this case via the [Sparx Systems MDG Link For DOORS](#) integration tool).

#### Notes:

- The Requirement element name can be simply descriptive text, with or without a manually-typed reference number. However, as requirements often have to have a unique reference for external checking, you can use the Enterprise Architect [auto-numbering](#) [525] facility to automatically apply a numbering system with or without prefixes and suffixes. Set the element type to **Requirement**.
- External Requirement elements can be displayed with or without an identifying **E** in the top right corner. To toggle display of this letter, select or deselect the **Show stereotype icon for requirements** checkbox on the **Options** dialog, [Objects](#) [362] page (**Tools | Options | Objects**).
- Requirement elements can be color coded to indicate their status; see the [Color Code External Requirements](#) [920] topic.

### Create Requirement Elements Within a Diagram

To create Requirement elements in a diagram, follow the steps below:

1. Open the [Custom](#) [417] pages on the **Toolbox**.
2. Drag the *Requirement* element onto the current diagram.
3. Enter the **Name** and other [details](#) [919] for the requirement.

Enterprise Architect creates a Requirement element in the current diagram and in the diagram's parent package.

### Create Requirement Elements in Project Browser

To create a requirement directly in the **Project Browser**, follow the steps below:

1. Right-click on the required parent package to open the context menu.
2. Select the **Insert | New Element** menu option. Alternatively, press **[Ctrl]+[M]**.
3. In the **New Element** dialog select the **Requirement** type.
4. Enter the **Name** (or select **Auto**) and click on the **OK** button.

Enterprise Architect creates a requirement in the current package.

#### 5.2.1.1.1 Requirement Properties

##### Note:

In Requirement Management tools and texts, the characteristics of a requirement are commonly called *attributes*. However, in UML the term *attribute*<sup>[558]</sup> refers to a different type of feature, and the requirement characteristics are defined as *properties*. In this Enterprise Architect documentation, the term *properties* is used.

Requirement properties differ slightly from the *properties of other elements*<sup>[481]</sup>; they are mainly focused on the type, status, difficulty and priority of the Requirement. The **Notes** field is also important, as it describes precisely what requirement the element represents.

To edit the properties of a Requirement, double-click on the element in a diagram or right-click on it in the **Project Browser** and select the **Properties** context menu option. The Requirement **Properties** dialog displays.

The screenshot shows the 'Requirement Properties' dialog box. It has four tabs: 'Properties', 'Links', 'Files', and 'Tagged Values'. The 'Properties' tab is selected. The dialog contains the following fields and controls:

- Short Description:** A text box containing 'Requirement009 - Store User Details'.
- Alias:** An empty text box.
- Status:** A dropdown menu set to 'Proposed'.
- Type:** A dropdown menu set to 'Functional'.
- Difficulty:** A dropdown menu set to 'Medium'.
- Phase:** A text box containing '1.0'.
- Priority:** A dropdown menu set to 'Medium'.
- Version:** A text box containing '1.0'.
- Author:** A dropdown menu set to 'Frederick Walter'.
- Last Update:** A text box containing '21/08/2008'.
- Key Words:** An empty text box.
- Created:** A text box containing '4/12/2007'.
- Notes:** A rich text editor area containing the text: 'A facility is required to securely store user details separately from the customer database.' The text editor has a toolbar with icons for Bold (B), Italic (I), Underline (U), Font Color (A), Bulleted List, Numbered List, Indent, Outdent, Text Color, and Undo.

At the bottom of the dialog are three buttons: 'OK', 'Cancel', and 'Help'.

If necessary, edit the name (**Short Description**) of the Requirement element, then type a detailed explanation of the requirement in the **Notes** field at the bottom of the dialog. Set the Status, Difficulty, Priority and Type, and other parameters as required.

You can add and delete **Status** field values, and assign a color to each value to indicate the status of the Requirement on a diagram; for more information, see the [Color Code External Requirements](#)<sup>[920]</sup> topic.

When you have finished entering the Requirement properties, click on the **OK** button.

In a project, it might be necessary to define more information in a requirement than is provided by the standard properties. For more information on extending the requirement properties, see the [Extend Requirement Properties](#)<sup>[920]</sup> topic.

#### 5.2.1.1.1 Color Code External Requirements

External requirements can be color coded to provide quick visual cues indicating the status of a requirement. To enable color coded external requirements follow the steps below:

1. Select the **Tools | Options** menu option. The **Options** dialog displays.
2. From the hierarchical tree select **Objects**, and select the **Show status colors on diagrams** checkbox to enable the status of external requirements to be represented by color coding.

The color code requirements use the following default conventions:

- Yellow for Proposed
- Blue for Approved
- Green for Validated
- Orange for Mandatory
- Black for Implemented.

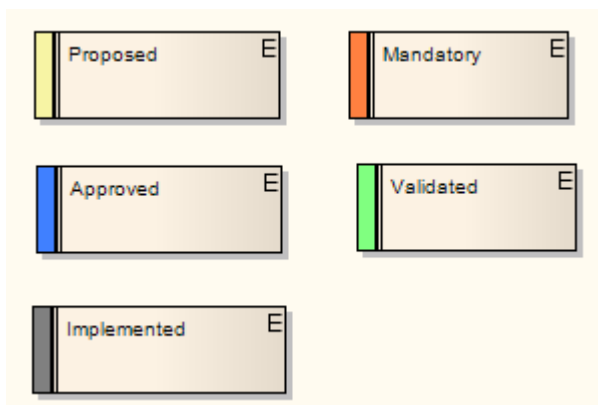

You can change these colors, and add or remove status types, using the [Status Types](#)<sup>[653]</sup> dialog.

#### 5.2.1.1.2 Extend Requirement Properties

A project might apply further properties to a requirement, such as cost, lateness penalty or risk to the business if not met. You can add these properties to specific Requirement elements, or configure them to be automatically available in all Requirement elements on creation, using [Tagged Values](#)<sup>[632]</sup>. (These are sometimes referred to as *User-defined attributes*.)

Extended element properties are not visible unless you open the **Tagged Values** window for the element. Alternatively, you can display the additional properties [on the element image on its diagrams](#)<sup>[921]</sup>.

#### Add Tagged Values to Existing Requirements

To add a property to a single Requirement as a Tagged Value, simply click on the Requirement, display the **Tagged Values** window (**[Ctrl]+[Shift]+[6]**), and [enter](#)<sup>[635]</sup> the name of the property as the tag name and the value of the property as the tag value.

It is likely that any property you add to one Requirement would also apply to others. You might therefore use a *predefined Tagged Value Type* to identify your Requirement property, so that you can select it whenever required. The predefined Tagged Value Type also enables you to define specific *values* for the Tagged Value.

If the appropriate predefined Tagged Value Type does not exist, a Technology Developer can create it to add to the [structured tags](#)<sup>[1168]</sup>, [reference tags](#)<sup>[1170]</sup>, or [customized tags](#)<sup>[1171]</sup> collections.

### Configure Requirements to be Created With Extended Properties

If it is necessary to create all Requirements with the same extended set of properties, you can create a *Requirement Template* diagram and either create a special Requirement that defines those properties (as Tagged Values), or drag an existing Requirement with those properties onto the diagram. You then [set the Requirement Template diagram](#)<sup>[542]</sup> as the template for all new Requirement elements, so that those new Requirements automatically have all of the properties you need.

However, this then excludes other Requirement element formats, including the standard Requirement format. If you want to use another Requirement format, you have to replace or cancel the current Template. Alternatively, you can create a *Profile*.

A Profile also defines exactly what a new Requirement element should contain, and how it should display in diagrams. However, a Profile is a collection of *alternative* element definitions, so it does not override the default Requirement format, nor does it prevent you from defining several different types of Requirement element. You can therefore have separate and parallel definitions of elements for business requirements, system requirements, project requirements, or any other category of requirement you decide to work with.

For information on importing and using existing Profile files, see the [UML Profiles](#)<sup>[906]</sup> topic. For information on creating new Profiles, see the [Developing Profiles](#)<sup>[1093]</sup> topic.

#### 5.2.1.1.2.1 Display Tagged Values On Diagrams

If you have extended the properties of a Requirement, you might want to make those properties visible in the Requirement elements in your diagrams, by switching on display of the element *tags* compartment. You can do this in one of two ways:

- To display the *tags* compartment on all elements on a diagram, double-click on the diagram background and select the [Elements](#)<sup>[426]</sup> tab of the **Diagram Properties** dialog; select the **Tags** checkbox and click on the **OK** button.
- To display the *tags* compartment on a specific element on a diagram, right-click on the element and select the [Feature Visibility](#)<sup>[438]</sup> context menu option; select the **Tags** checkbox in the **Show Element Compartments** panel of the **Feature Visibility** dialog, and click on the **OK** button.

The Tagged Values are then displayed in the Requirement element on the diagram.

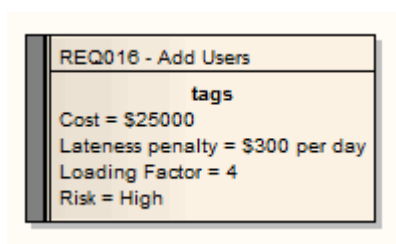

#### 5.2.1.1.3 Connect Requirements

A Requirement element can be connected to other Requirements, most commonly using [Aggregate relationships](#)<sup>[854]</sup> to form a hierarchy of requirements.

Requirements are also connected to other types of element, most commonly Use Cases, by [Realize or Implements](#)<sup>[889]</sup> relationships.

These relationships are very important, both in identifying how the Requirements are organized and used in the model, and in [tracing](#)<sup>[928]</sup> the development from the Requirements throughout the model. Both of these tasks are very simple in Enterprise Architect, because once a connector on a Requirement exists, Enterprise Architect automatically lists the Requirement in the:

- Requirements [Traceability](#)<sup>[1253]</sup> window (an important tool in examining the role of Requirements in the model)
- [Requirements](#)<sup>[486]</sup> tab of the target element **Properties** dialog
- [Scenarios & Requirements](#)<sup>[514]</sup> window
- [Relationships Window](#)<sup>[1269]</sup>

- [Dependency](#) <sup>[1624]</sup> and [Implementation reports](#) <sup>[1626]</sup>
- [Standard RTF output](#) <sup>[1569]</sup>.

The connector itself is also listed in the [Links](#) <sup>[489]</sup> tab of the target element **Properties** dialog, and in the [Relationship Matrix](#) <sup>[1267]</sup>. There are, therefore, many ways to locate, view and track Requirement relationships.

## Connect On Diagram

Relationships can be created on a diagram by clicking on the appropriate connector icon from the [Requirement](#) <sup>[418]</sup> and [Common](#) <sup>[405]</sup> pages of the **Toolbox**, clicking on the source (originating) element, and dragging to the target element.

If you are connecting elements in different packages, you can drag elements from the **Project Browser** onto a common diagram and set up the relationships there. Alternatively, you can quickly generate a *Realize* connector by dragging an existing Requirement element from the **Project Browser** over the element that implements the Requirement. Enterprise Architect interprets this as a request to create the Realize connector and does so automatically. The Requirement element is not added to the diagram. However, if you subsequently drag the Requirement onto the diagram the connector is already in place.

## Connect Off Diagram

You can also connect a Requirement element to other elements without necessarily having the elements on the same diagram, or having a diagram open.

Use the **Relationship Matrix** to [create relationships](#) <sup>[1265]</sup> for requirements; this is a convenient way of quickly building up complex relationships and hierarchies.

### 5.2.1.1.4 Import Requirements and Hierarchies in CSV

You can import Requirements from a spreadsheet application in [CSV](#) <sup>[305]</sup> format. Before doing this you must create a [CSV import file specification](#) <sup>[300]</sup> that:

- In the **Default Types** field has the value **requirement,package** to import requirements and a package structure to contain them
- Has the **Preserve Hierarchy** checkbox selected
- Identifies the data fields on the spreadsheet that are to be translated into Enterprise Architect, in the order in which they are plotted across the spreadsheet
- Is to operate on a spreadsheet containing the **CSV\_KEY** and **CSV\_PARENT\_KEY fields** <sup>[302]</sup> (which, if not generated by a CSV export from Enterprise Architect, you have added and populated yourself).

This enables you to import the individual and grouped requirements from the spreadsheet into Enterprise Architect, and to reconstruct the hierarchies of Requirements in the target package in the **Project Browser**.

### 5.2.1.2 Model Requirements

#### Represent Requirements

In Enterprise Architect, a requirement can be modeled as an:

- [External Requirement](#) <sup>[846]</sup> - an expectation of the system or process, what the system or process must provide, modeled as an *element*; for example, a business requirement or a stakeholder request - Requirements at this level have their own properties and are reported on separately in RTF reports

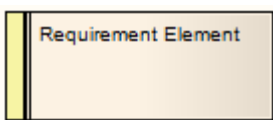

- [Internal requirement](#) <sup>[925]</sup> - a responsibility of an existing element, what the element must do or accomplish, defined as a *property* of the element.

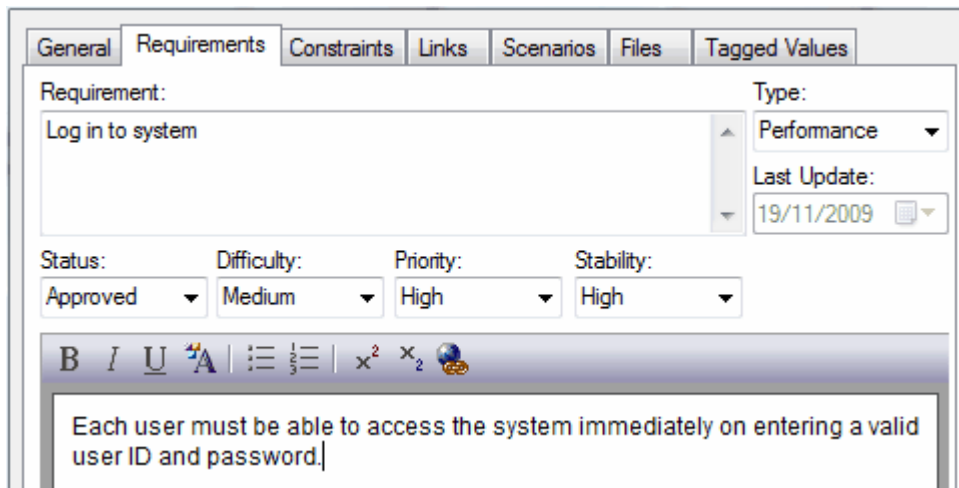

Requirements Management in Enterprise Architect is primarily concerned with *external* Requirement elements and the elements that implement or *realize* them.

### Requirements in the Model

Requirement elements can be grouped and organized within [Requirements diagrams](#)<sup>[736]</sup>. The Requirement elements are connected to each other by *Aggregate* relationships to form a hierarchy:

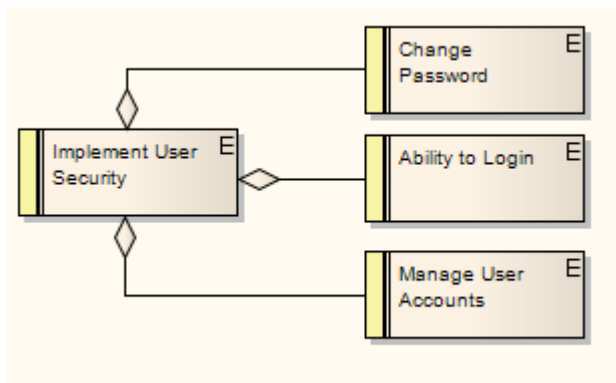

It is quite usual to develop a package of many hundreds of Requirement elements, arranged individually and in hierarchies of varying complexity. In the [Project Browser](#) you can use the [Turn On Level Numbering](#)<sup>[1215]</sup> facility to highlight the order and arrangement of the Requirements quickly and easily. The following illustration shows a number of Requirements in a package, where Level Numbering makes the order and arrangement clear:

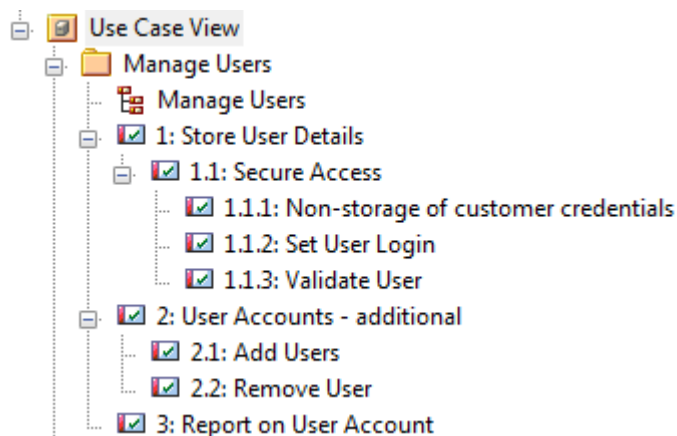

If elements are added, moved or deleted from the package, the numbering automatically adjusts.

**Note:**

This numbering can also be applied in the [RTF report generator](#)<sup>[1578]</sup> using the **LevelNumber** field in the **Element** section – *{Element.LevelNumber}*.

## Use Cases

Requirements are implemented (realized) by model elements such as Use Cases, Classes, Interfaces and Components. There are many ways to [trace](#)<sup>[1243]</sup> either the Requirement for the feature or service modeled by the elements, or the elements that develop the requirement, most visibly in [Traceability](#)<sup>[1250]</sup> diagrams that depict the Requirements and the model elements [connected](#)<sup>[921]</sup> by *Realize* relationships. The Realize connector enables members of the project team to keep design objectives and development in tandem, and the development path and purpose clear.

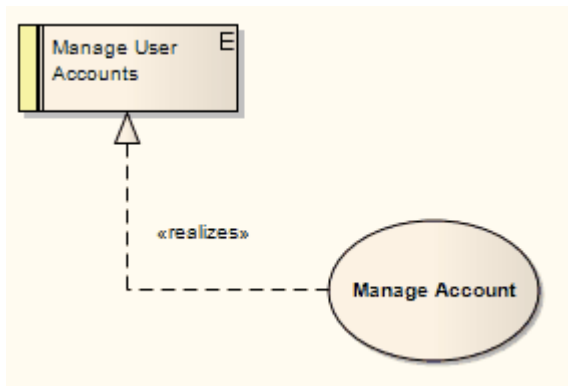

The more usual realization relationship is between a Requirement and a Use Case. A Requirement can be realized by one or more Use Cases, and a Use Case can realize one or more Requirements.

Whilst a Requirement defines a condition that must be met, the [Use Case](#)<sup>[806]</sup> is the key to defining and visualizing *how* that condition is met. A [Use Case diagram](#)<sup>[676]</sup> depicts the logical grouping of actions, processes and components to achieve a required result, and through the use of [Actor](#)<sup>[757]</sup> elements also defines the user and/or system roles participating in the process.

Each Use Case (as a [composite element](#)<sup>[837]</sup>) can contain a combination of child diagrams that define in greater detail how a particular activity or facility might be implemented - such diagrams include [Sequence](#)<sup>[706]</sup>, [Communication](#)<sup>[715]</sup>, [Activity](#)<sup>[674]</sup>, [State Machine](#)<sup>[678]</sup> and [Business Rule Flow](#)<sup>[939]</sup> diagrams. The actual implementation of each Use Case is realized by Class, Component and Interface elements organized in their own diagrams. These realizations can also be captured and viewed in Traceability diagrams, depicting the full development pathway from initial requirement through to testing and production.



### 5.2.1.2.1 Internal Requirements

Internal requirements in Enterprise Architect are element responsibilities. They are defined on the [Requirements](#) <sup>[485]</sup> tab of the element **Properties** dialog.

The screenshot shows the 'Requirements' tab of the 'Properties' dialog. The 'Requirement' field contains 'Log in to system'. The 'Type' dropdown is set to 'Performance'. The 'Last Update' field shows '15/05/2009'. The 'Status' is 'Approved', 'Difficulty' is 'Medium', 'Priority' is 'High', and 'Stability' is 'High'. The requirement text area contains: 'Each user must be able to access the system immediately on entering a valid user ID and password.' Below this are buttons for 'Move External', 'New', 'Save', and 'Delete'. A table lists defined requirements:

Requirement	Type	External
Log in to system	Performa...	
Password Protection	Functional	
Report on User Account	Functional	Yes
Req 00126	Functional	Yes

At the bottom of the dialog are buttons for 'OK', 'Cancel', 'Apply', and 'Help'.

Internal requirements form the functional requirements of the system to be built. The meaning of the requirement can vary depending on which element is the host; for example, a business process requirement might mean something different to a Use Case requirement, which again might mean something different to a Class requirement. In the example above, an internal responsibility to enable the user to login to the system has been defined for the *Login* Use Case. This is a responsibility of the Use Case - an action it is responsible for carrying out - and it applies only to this Use Case.

The significant parameters (or, in Requirement Management terms, *attributes*) are the Type, Status, Difficulty and Priority. Whilst you can provide a detailed description of the responsibility in the **Notes** field, there is more scope in the name (**Requirement** field) to define the nature of the responsibility. An additional field, **Stability**, indicates the probability of the requirement changing; high stability means a low probability of change.

The example Use Case above also has connections to two external requirements, which are system functions that the Use Case implements either in full or in part. You can [convert](#) <sup>[926]</sup> an internal responsibility into an external requirement.

You can also create internal responsibilities for an element using the [Scenarios & Requirements](#) <sup>[514]</sup> window. A responsibility created in the window displays in the element **Properties** dialog, and vice versa.

### 5.2.1.2.1.1 Make Internal Requirement External

Elements in Enterprise Architect have internal requirements, or responsibilities (what they must do or accomplish). These often overlap or duplicate more formal requirements that the system in general must meet. You can move internal requirements to external requirements in one go using the **Move External** function.

#### Procedure

If you have defined an internal requirement for an element and want to move it out (where it can perhaps be implemented by multiple elements), follow the steps below:

1. Double-click on the element in a diagram or in the **Project Browser** to open the element **Properties** dialog.
2. Click on the **Requirements** tab.
3. Locate and highlight the requirement.
4. Click on the **Move External** button. The **Browse Project** dialog displays.

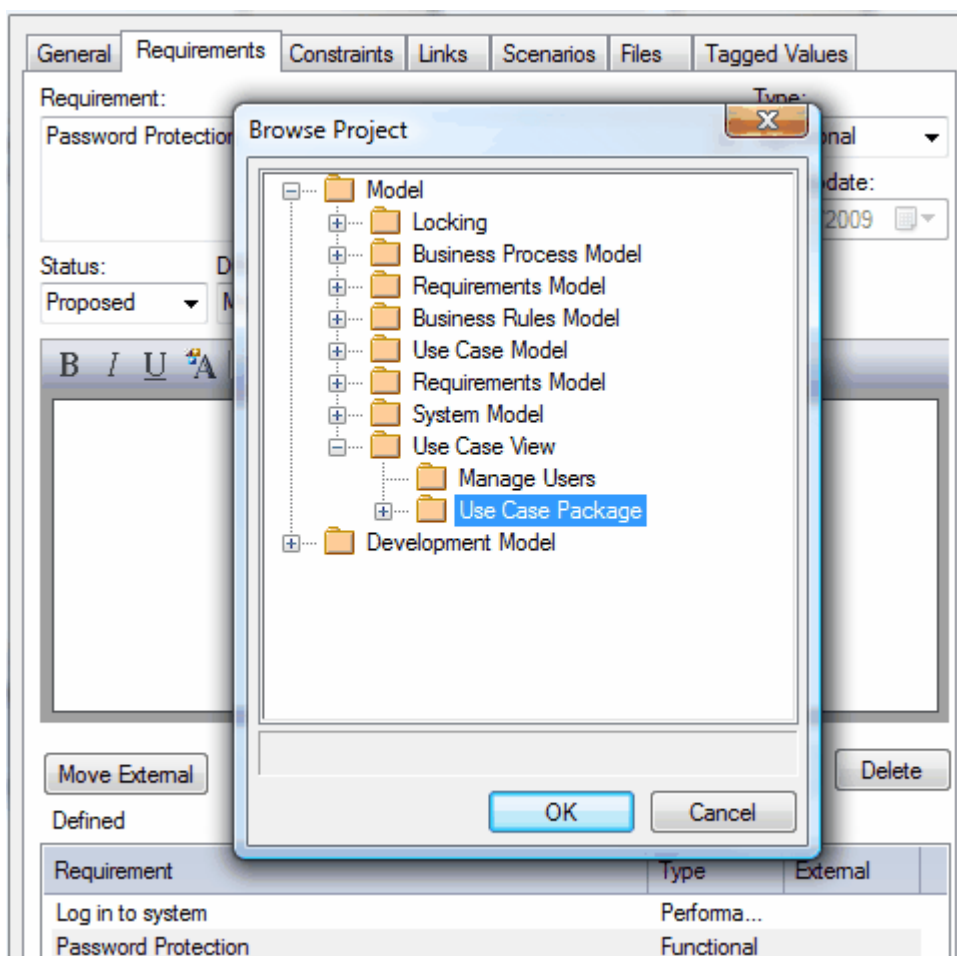

5. Select the package to place the new requirement in.
6. Click on the **OK** button.

Enterprise Architect creates a new Requirement element in the target package and automatically generates a Realization connector from the element to the Requirement.

Requirement	Type	External
Log on to application	Performance	Yes

Notice the requirement is now marked external and the dialog fields grayed out. To [edit its details](#)<sup>[919]</sup>, double-click on the requirement.

Also notice that a Requirement element has been created in the target package.

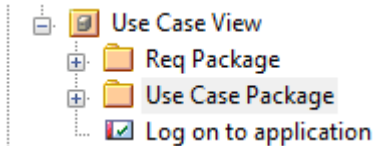

### 5.2.1.3 Manage Requirements

One of the main advantages of managing Requirements in Enterprise Architect is that you can display many different aspects of information on the Requirements, from overall organization and location through lists, current status, general properties, detailed individual notes and specific properties, to relationships and dependencies with other elements in the model.

As most of these aspects are displayed in dockable windows, you can review the Requirements from several different perspectives simultaneously in the Enterprise Architect work area, as shown below:

The screenshot displays the Enterprise Architect interface with three dockable windows:

- Element List:** Shows a table of requirements. The first requirement is 'Store User Details' with status 'Proposed', complexity 'Easy', author 'Frederick Walter', difficulty 'Medium', and dates '8/05/2009' and '27/05/2009'. Below the table is a text note: 'A facility is required to securely store user details separately from the customer database.'
- Project Browser:** Shows a hierarchical tree of the model. The path is: Model > Use Case View > Manage Users > 1: Store User Details > 1.1: Secure Access > 1.1.1: Non-storage of cust details.
- Tagged Values:** Shows a table of properties for the selected requirement:
 

Property	Value
Required by	05 June 2009
Review Complete	04 June 2009
Review Status	Not Reviewed
Reviewer	Kim Paxman

This display shows the position of the *Store User Details* Requirement element in the model, and how it relates to other Requirements (**Project Browser**); the default characteristics of the Requirement (**Element List**) and the extended characteristics (**Tagged Values** window), and a detailed description of the Requirement (**Notes** window). You can configure some of these windows to display more information, and/or use other windows and facilities.

Brief descriptions of appropriate screens and their use are provided in the following topics:

- [View Requirements](#)<sup>[928]</sup>
- [Trace Use of Requirements](#)<sup>[928]</sup>
- [Manage Requirement Changes](#)<sup>[928]</sup>
- [Report on Requirements](#)<sup>[929]</sup>

### 5.2.1.3.1 View Requirements

Use the following windows and facilities to: locate and list Requirement elements in the model; add, move and delete the elements; display and edit the properties and characteristics of individual elements; and generate reports on packages or specific elements.

- [Project Browser](#)<sup>[1209]</sup> - shows the content and structure of your model.
- [Element List](#)<sup>[1253]</sup> - lists the elements in a diagram or package, filtered and sorted according to the settings you define; shows all or selected default properties of each element.
- [\(Requirements\)](#)<sup>[736]</sup> [Diagram](#)<sup>[396]</sup> - shows the arrangement of a group of Requirements, and can show whether the elements are in the same package or different packages.
- [Model Search](#)<sup>[1231]</sup> - enables you to locate Requirements in general in the model, or specific Requirement elements, according to the search criteria you use.
- [Model Views](#)<sup>[1221]</sup> - enables you to maintain links to commonly-used elements, and to rapidly show developments and changes in (Requirement) package contents through either reports or slide shows of selected diagrams.
- [Properties](#)<sup>[508]</sup> - shows every *standard* property of a selected element, whether updated by the user or maintained automatically by the system.
- [Tagged Values](#)<sup>[632]</sup> - shows *extended* properties of a selected Requirement element.
- [Element Browser](#)<sup>[510]</sup> - shows every *added-on* property, such as attributes, operations, Tagged Values and constraints.
- [Notes](#)<sup>[641]</sup> - displays the detailed description of a requirement, and any other additional information recorded on the requirement.

### 5.2.1.3.2 Trace Use of Requirements

Having investigated the representation of requirements in your model, you might review either how they have been used to direct development through the model, or how a particular development was initiated. This is discussed in greater detail in the [Traceability](#)<sup>[1245]</sup> topics, but the windows and facilities you might use to follow development from Requirements are briefly described below. The significant feature in tracing Requirements and development is the [connectors](#)<sup>[921]</sup> between the elements.

- [Relationships](#)<sup>[1269]</sup> window - quickly identifies every relationship of which a selected Requirement element is a member, and the partner element in that relationship, whether or not the relationship is visible in the current diagram. If the partner element is not in the diagram, you have the option of adding it.
- [Traceability](#)<sup>[1253]</sup> [window](#)<sup>[1253]</sup> - a very useful tool in showing chains of relationships that include the selected element. The window can show, for example, that a Requirement A is realized by a Use Case X, but Use Case X *also* realizes Requirement B, which in turn is *also realized by* Use Case Y. You can control the type and extent of these relationship chains, but as the system checks the connectors and partner elements of every relationship within the limits you impose, the system can take some time to produce the final results.
- [Relationship Matrix](#)<sup>[1261]</sup> - a significant tool in mapping the relationships between the Requirements elements in a package and other elements in either that package or a different package. Where a relationship is missing, you can add it; if an existing relationship is misplaced, you can delete it.
- [Properties](#)<sup>[481]</sup> dialog, [Requirements](#)<sup>[485]</sup> tab - for elements *other than* Requirements (particularly Use Cases), shows all internal responsibilities and external requirement elements attached to the element.
- [Scenarios & Requirements](#)<sup>[514]</sup> window - as for the [Properties](#) dialog, shows the Requirements and responsibilities of the selected element, and the scenarios and constraints under which the Requirements are being realized.

### 5.2.1.3.3 Manage Requirement Changes

Because requirements are statements of what a system or process must do or provide, they have a great impact on the modeling and development of the system. A new requirement might initiate an extensive program of work, and changes to or removal of that requirement can therefore have a major effect on the model. Issues concerning requirements, and changes to Requirements, must both be carefully managed.

The first steps in managing changes to requirements would be to raise *specific Issue and Change* request items against the Requirement element. You could monitor the appearance of these items using the filtered searches of the *Model Views*. You might then [review](#)<sup>[928]</sup> the Requirement properties and/or its relationship hierarchies. During model development, you might capture periodic *Baselines* and use these to review the changes and, if necessary, roll them back to a previous point. You might also use the *Auditing* facility to monitor changes as they are made, and to ensure that no unauthorized or potentially risky changes are being made in the model.

These facilities are briefly discussed below.

## Changes and Issues

A change is, very broadly, an item defining an addition or alteration to a requirement. An issue identifies either a failure to meet a requirement, or a risk in meeting the requirement.

Changes and issues can arise in development at a number of levels, being raised for problems that apply system-wide down to within a specific element. There are two mechanisms that can be used to identify a change or issue, and the work required to resolve it:

- [Change](#) <sup>[1564]</sup> and [Issue](#) <sup>[1563]</sup> (or Defect) elements - structured comments that identify a problem at system-level, although they can also be attached to a specific element from which a problem arises. Both types of element resemble the Requirement element, and can be linked to one or more other elements that have to be reviewed, with relationships such as Association, Dependency and Realize. The two types of element can also form hierarchies or groups, where complex problems arise.
- [Maintenance items](#) <sup>[1558]</sup> raised against a specific element, and recorded for that element in the [Maintenance](#) <sup>[1558]</sup> window. Maintenance items enable the distinction between *Defects* (a failure to meet a requirement) and *Issues* (a risk factor that might affect satisfying the requirement). They also include *Tasks*, which record work items associated with the element.

Maintenance items are very specific, but if there is a possibility of an item having a wider impact on other elements or the system in general, you can [translate the item](#) <sup>[1561]</sup> into a Change or Issue element, or any other type of element that best identifies the problem and its solution.

## Model Views

[Model Views](#) <sup>[122]</sup> are very useful for trapping changes and issues in the model, especially on Requirements. You can set up searches to identify the appearance of new Change or Issue elements, or to detect changes in the properties of the Requirement elements themselves.

## Baselines

A [Baseline](#) <sup>[280]</sup> is a snapshot of a package or a model branch at a particular point in time, which you determine. You can use the Baseline as a distribution mechanism for changes to the model, but the main use is to enable you to compare the current model with a previous stage, and detect what changes have been made since the Baseline was captured. If you do not want a change to remain in the model, you can roll the affected elements back to the state they had in the Baseline. Therefore, if you maintain your requirements in a specific package or branch, you can capture Baselines of the package and ensure that changes conform to your change management process or, if not, can be reversed.

## Auditing

The [Auditing](#) <sup>[270]</sup> facility enables you to capture any changes made to your model within the selection criteria that you define. You can, for example, configure the Auditing facility to specifically record [changes to Requirement](#) <sup>[273]</sup> elements. As auditing is continuously monitoring, you can detect changes as they are made, and verify that they are acceptable. You can also store the log of changes, and review it later on. Note that you cannot reverse the changes automatically, as you can with Baselines. You might therefore use Auditing to identify changes that you will investigate more fully and - if necessary - reverse in a Baseline comparison.

### 5.2.1.3.4 Report on Requirements

Enterprise Architect provides two report generation facilities that enable you to output RTF reports and HTML reports on your model structure and components. The [RTF reporting facility](#) <sup>[1569]</sup> is especially comprehensive, and contains a number of features that provide particular support to Requirements Management:

- A [requirements report template](#) <sup>[1575]</sup> that extracts details of external requirements in the model; you can copy and tailor this template for your particular needs.
- Options in the [Element List](#) <sup>[1258]</sup> and [Model Search](#) <sup>[1231]</sup> to generate RTF reports on selected (Requirement) items from the collected information.
- The [Implementation Report](#) <sup>[1626]</sup>, which lists for a selected package the elements that require implementers, together with any source elements in [Realize](#) <sup>[889]</sup> (Implements) relationships with those elements.
- The [Dependency Report](#) <sup>[1624]</sup>, which lists for a selected package any elements that are dependent on another element for their specification. For example, a Use Case derives its specification from the Requirement that it realizes.

## 5.2.2 Business Models

### Modeling the Business Process

Modeling the business process is an essential part of any software development process. It enables the analyst to capture the broad outline and procedures that govern what it is a business does. This [analysis model](#) <sup>[93]</sup> provides an overview of where the proposed software system being considered fits into the organizational structure and daily activities. It can also provide the justification for building the system by capturing the current manual and automated procedures that are to be rolled up into a new system, and the associated cost benefit.

As an early model of business activity, it enables the analyst to capture the significant events, inputs, resources and outputs associated with business process. By connecting later design elements (such as Use Cases) back to the business process model through Implementation connectors, it is possible to build up a fully traceable model from the broad process outlines to the functional requirements and eventually to the software artefacts actually being constructed.

As the Business Process Model typically has a broader and more inclusive range than just the software system being considered, it also enables the analyst to clearly map what is in the scope of the proposed system and what is to be implemented in other ways (such as a manual process).

### An Example

The example below demonstrates the kind of model that can be built up to represent a business process. In this model, the goal of the business process is to take customer orders and to ship those orders out. A user starts the process with an inquiry, which leads to the involvement of the Book Catalogue, Shopping Cart, on-line pages and warehouse inventory. The output of significance to the business is a customer order.

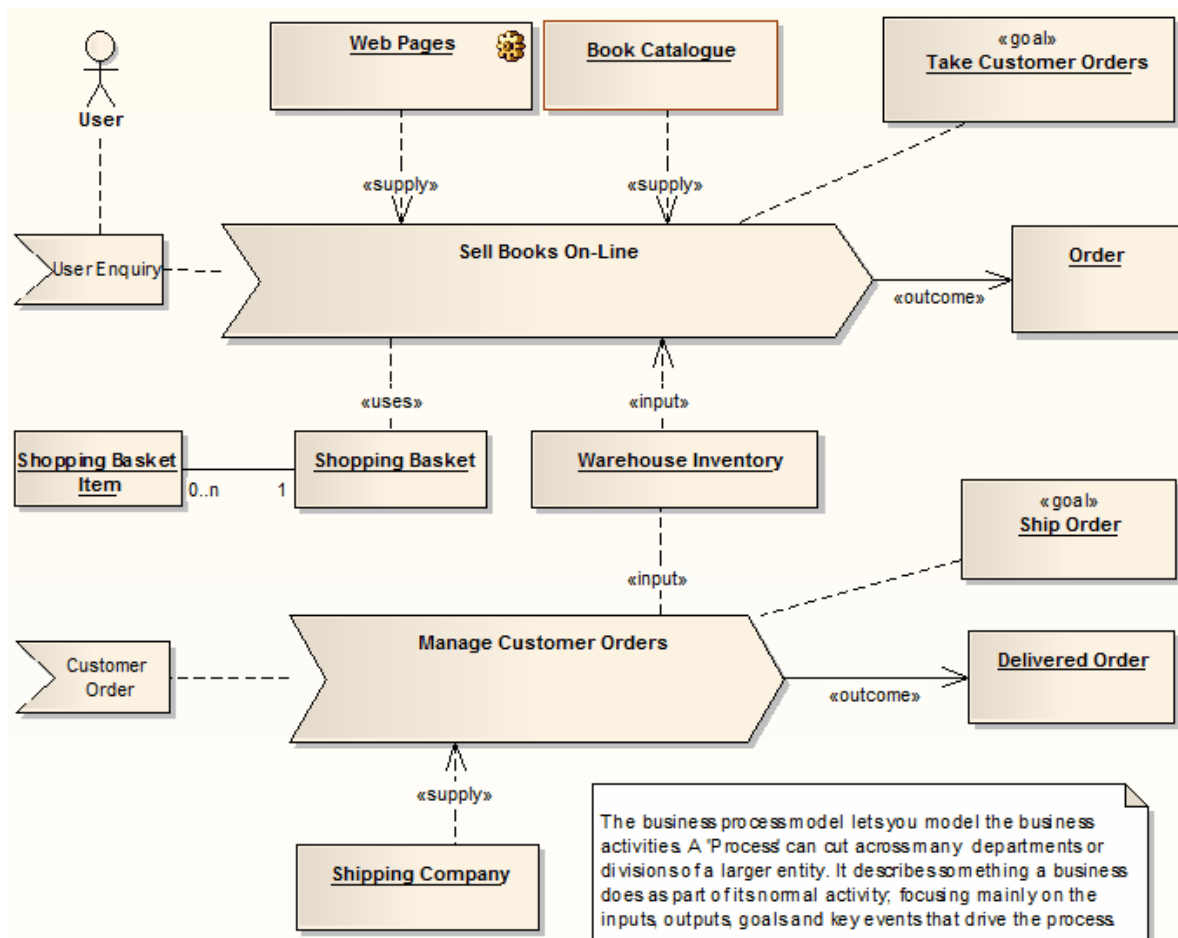

The second half of the process model is to respond to a customer order and ship the required items. The second process involves the warehouse inventory and shipping company, and completes when an order is delivered to the customer.

### See Also

- [Business Modeling and Business Interaction Diagrams](#)<sup>[739]</sup>
- [Web Stereotypes](#)<sup>[851]</sup>

## 5.2.2.1 Analysis Models

This section discusses the development of analysis models to construct business processes. It describes:

- [Process Modeling Notation](#)<sup>[931]</sup>
- [Inputs, Resources and Information](#)<sup>[931]</sup>
- [Events](#)<sup>[932]</sup>
- [Outputs](#)<sup>[932]</sup>
- [Goals](#)<sup>[933]</sup>
- [A Complete Business Process](#)<sup>[933]</sup>

### 5.2.2.1.1 Process Modeling Notation

A business process model typically defines the following elements:

- The goal or reason for the process
- Specific inputs
- Specific outputs
- Resources consumed
- Activities that are performed in some order, and
- Events that drive the process.

The business process:

- Can affect more than one organizational unit
- Can have a horizontal organizational impact
- Creates value of some kind for the customer; customers can be internal or external.

A business process is a collection of activities designed to produce a specific output for a particular customer or market. It implies a strong emphasis on how the work is done within an organization, in contrast to a product's focus on what. A process is thus a specific ordering of work activities across time and place, with a beginning, an end, and clearly defined inputs and outputs: a structure for action. The notation used to depict a business process is illustrated below.

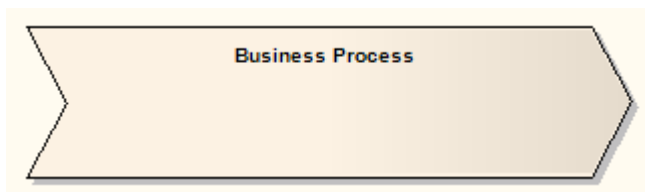

The [process notation](#)<sup>[846]</sup> implies a flow of activities from left to right. Typically an [Event](#)<sup>[932]</sup> element is placed to the left of the process and the output to the right. To specifically notate the internal activities, [Activity elements](#)<sup>[753]</sup> can be placed inside the process element.

### The BPMN Profile

One popular notation and approach to business modeling is the Business Process Modeling Notation (BPMN). This notation is specifically targeted at the business modeling community and has a relatively direct mapping to UML through a BPMN Profile. Sparx Systems provides a built-in [profile for BPMN](#)<sup>[952]</sup> modeling in Enterprise Architect.

### 5.2.2.1.2 Inputs, Resources and Information

Business processes use information to tailor or complete their activities. Information, unlike resources, is not consumed in the process; rather it is used as part of the transformation process. Information can come from external sources, from customers, from internal organizational units and could even be the product of other processes. A resource is an input to a business process and, unlike information, is typically consumed during the processing. For example, as each daily train service is run and actuals recorded, the service resource is

'used up' as far as the process of recording actual train times is concerned.

The notation to illustrate information and resources is shown below.

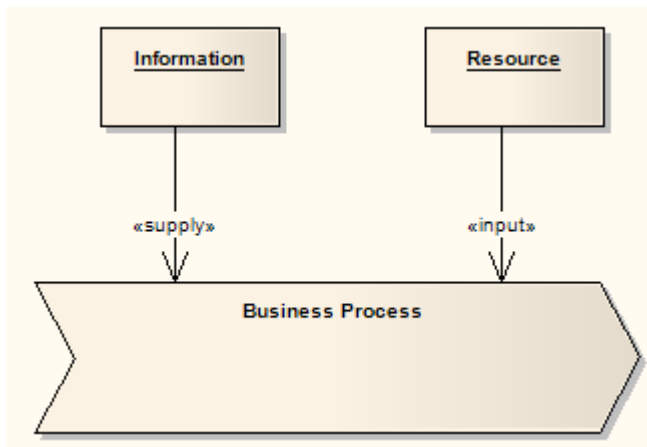

A *Supply* connector indicates that the information or object linked to the process is not used up in the processing phase. For example, order templates can be used over and over to provide new orders of a certain style; the templates are not altered or exhausted as part of this activity.

An *Input* connector indicates that the attached object or resource is consumed in the processing procedure. As an example, as customer orders are processed they are completed and signed off, and typically are used only once per unique resource (order).

#### 5.2.2.1.3 Events

An [event](#)<sup>[839]</sup> is the receipt of some object, a time or date reached, a notification or some other trigger that initiates the business process. The event might be consumed and transformed (for example a customer order) or simply act as a catalyst (for example, nightly batch job).

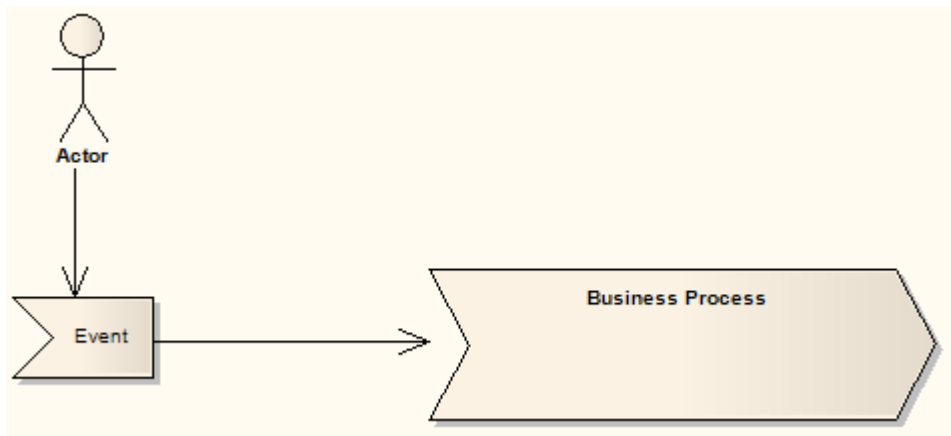

#### 5.2.2.1.4 Outputs

A business process typically produces one or more outputs of value to the business, either for internal use or to satisfy external requirements. An output might be a physical object (such as a report or invoice), a transformation of raw resources into a new arrangement (a daily schedule or roster) or an overall business result such as completing a customer order.

An output of one business process might feed into another process, either as a requested item or a trigger to initiate new activities.



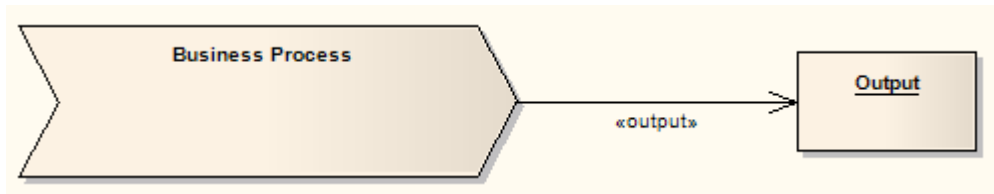

An Output connector indicates that the business process produces some object (either physical or logical) that is of value to the organization, either as an externally visible item or as an internal product (possibly feeding another process).

### 5.2.2.1.5 Goals

A business process has some well defined goal. This is the reason the organization does this work, and should be defined in terms of the benefits this process has for the organization as a whole and in satisfying the business requirements.

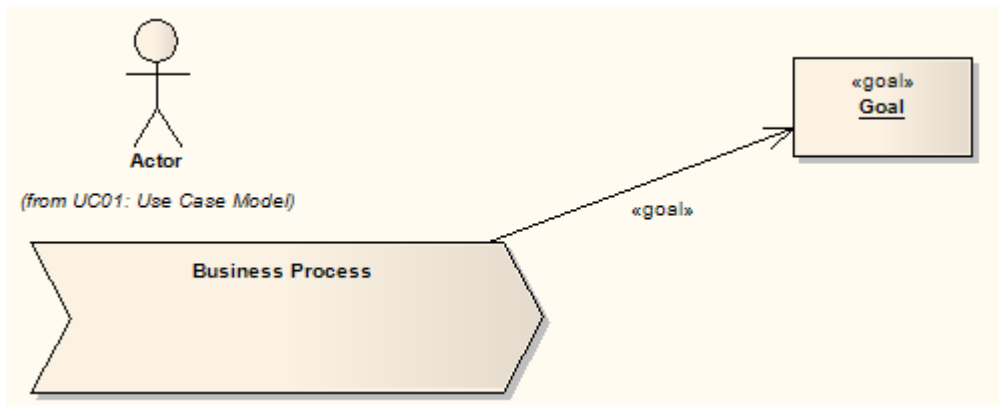

A Goal connector indicates that the attached object to the business process describes the goal of the process. A goal is the business justification for performing the activity.

### 5.2.2.1.6 A Complete Business Process

The diagram below illustrates how the various model elements can be grouped together to produce a coherent picture of a named business process. Included are the inputs, outputs, events, goals and other resources that are of significance.

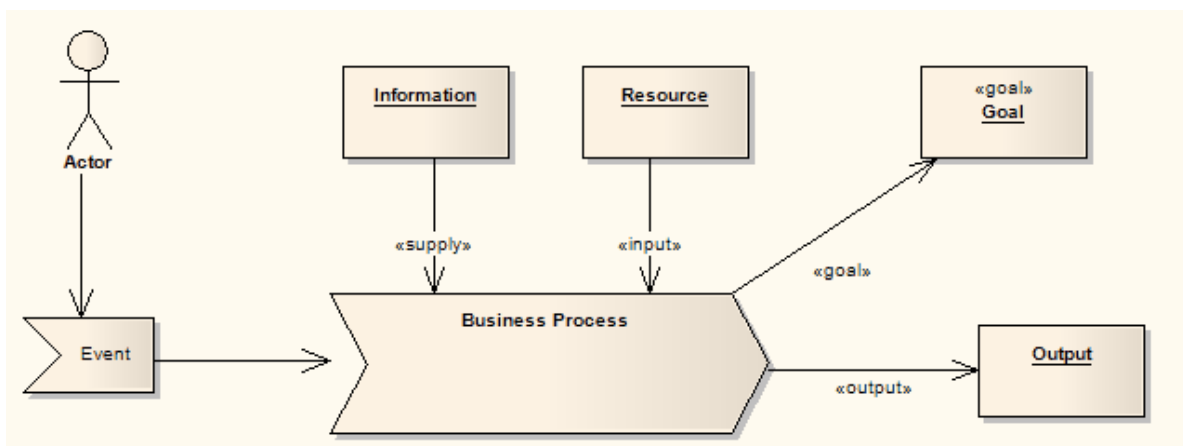

### 5.2.3 Business Rules

**Note:**

Business Rule Modeling is available in the Business and Software Engineering edition and Ultimate edition of Enterprise Architect.

To model Business Rules in Enterprise Architect, you work through the following steps:

- [Create a Rule model](#)<sup>[935]</sup> to define business rules.
- [Create a Business Domain model](#)<sup>[938]</sup>, which provides the business vocabulary for defining business rules.
- [Create a Rule Flow model](#)<sup>[939]</sup>, which groups the rules for a specific task under a Rule Task, and provides the order in which the business rules are executed.
- Model the rules in the [Rule Composer](#)<sup>[945]</sup>, which enables the rules to be transformed to a logical level of detail.
- [Validate](#)<sup>[950]</sup> the rules in the [Rule Composer](#).
- [Generate code for the business rules](#)<sup>[951]</sup> using Enterprise Architect's general code generation methods.

These steps are represented graphically in the following flow:

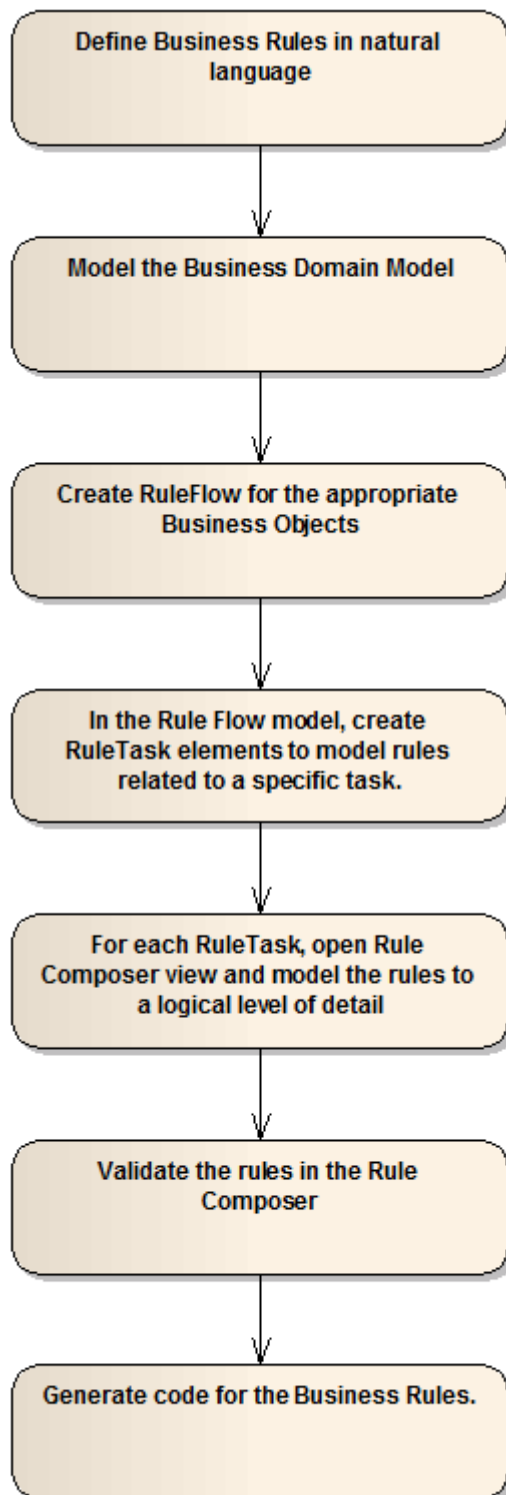

### Create a Business Rule Model

You can create a Business Rule Model from a template provided with Enterprise Architect. To do this, follow the steps below:

1. In the **Project Browser**, either:
  - Click on the **New Model From Pattern** icon in the toolbar
  - Right-click on a model root node and select the **Add a New Model using Wizard** context menu

option, or

- Right-click on a package and select the **Add | Add a New Model using Wizard** context menu option.

The **Select Model(s)** dialog displays.

2. In the **Select From** field, click on the drop-down arrow and select **Business Rule Model**. Alternatively, if it is listed in the **Technology** panel, select the **Business Rule Model** item.
3. In the **Name** panel, select the checkbox next to the **Business Rule Model** icon.
4. Click on the **OK** button.

The following model structure is created in the **Project Browser**:

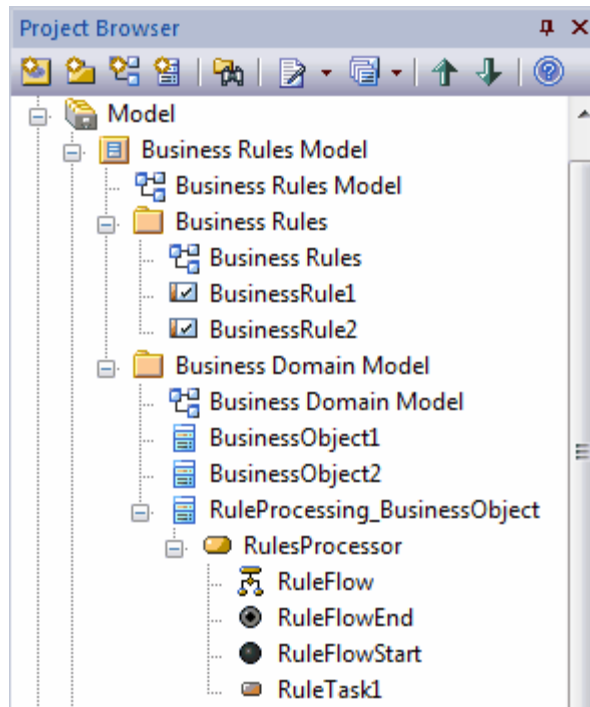

The *Business Rules Model* diagram, shown below, encapsulates the components of the Business Rules model.

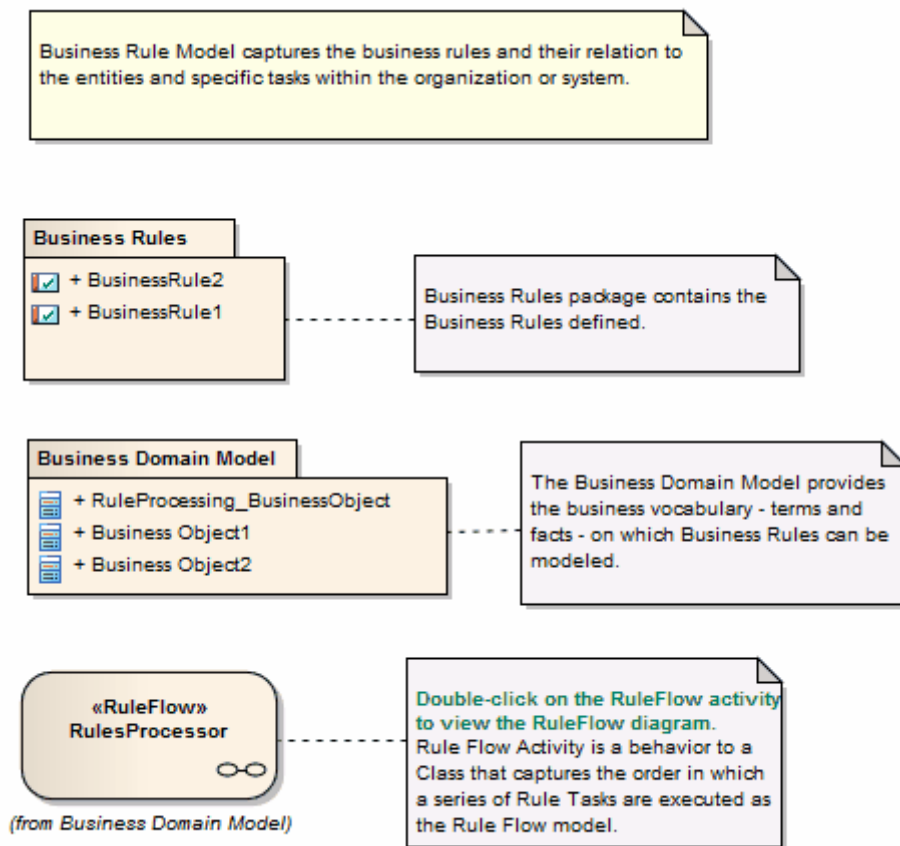

### 5.2.3.1 Model Business Rules For RuleTasks

The *Rule Model* enables you to define *Business Rule* elements and associate them with a Rule Task. In the example, you might define a set of rules to perform an eligibility check for a customer, to determine if the customer is eligible to rent a car.

To do this, follow the steps below:

1. Create a diagram of type *Rule Model*. The **Rule Model** pages display in the **Toolbox**.

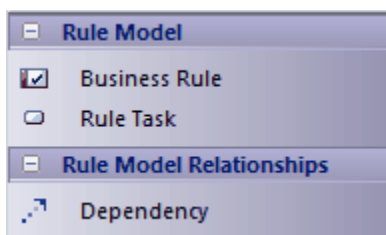

2. Drag and drop a Rule Task element (*Eligibility* in the example) from the Rule Flow Activity diagram package onto the Rule Model diagram.
3. Drag as many Business Rule elements as necessary from the **Toolbox** (or **Project Browser** if they exist already) onto the diagram. You type the rule as the element name here, then define the parameters of the rules using the [Rule Composer](#)<sup>[945]</sup>.
4. Create a Dependency relationship between each Business Rule element and the Rule Task element.

**Note:**

However, when you bring the rule into the **Rule Composer**, it automatically creates the Dependency relationship anyway.

5. Repeat steps 2 - 4 for the next Rule Task element.

The resulting Rule Model resembles the following diagram:

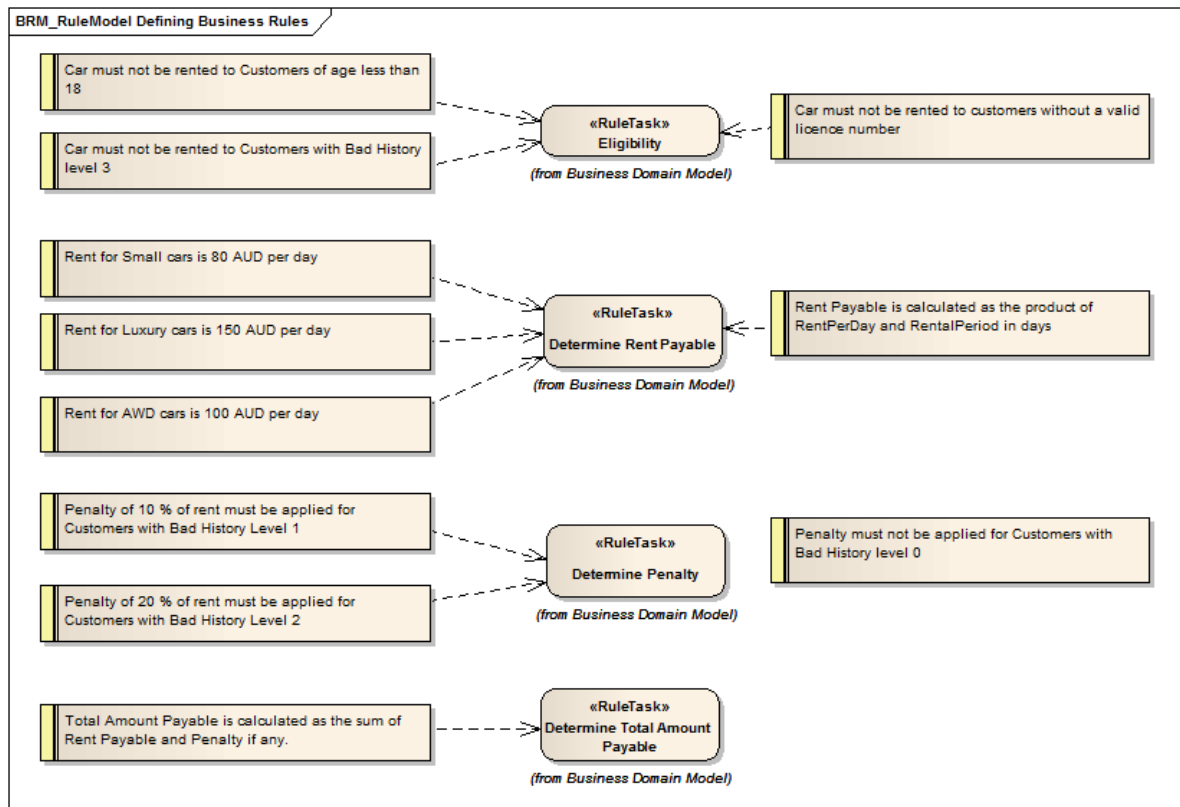

After you have modeled rules for all the Rule Task elements in the Rule Flow diagram, the Business Domain model is ready for [code transformation](#)<sup>[95]</sup>. The code templates for generating technology-specific rule code work hand-in-hand with the [EASL code templates](#)<sup>[1193]</sup> to generate the code for the Rule Flow diagram.

### 5.2.3.2 Create a Business Domain Model

The *Business Domain Model* provides the business vocabulary - terms and facts - on which Business Rules can be modeled. In Enterprise Architect a Business Domain model is created as a conceptual Class diagram.

#### Note:

When you create Classes in the Business Domain model, select the correct language for code generation to ensure that the correct data type is set for attributes and operation parameters.

Business Rules code generation is supported for the following languages:

- C++
- C#
- Java
- VB.Net.

The following diagram shows an example Business Domain model, for a Car Rental system.

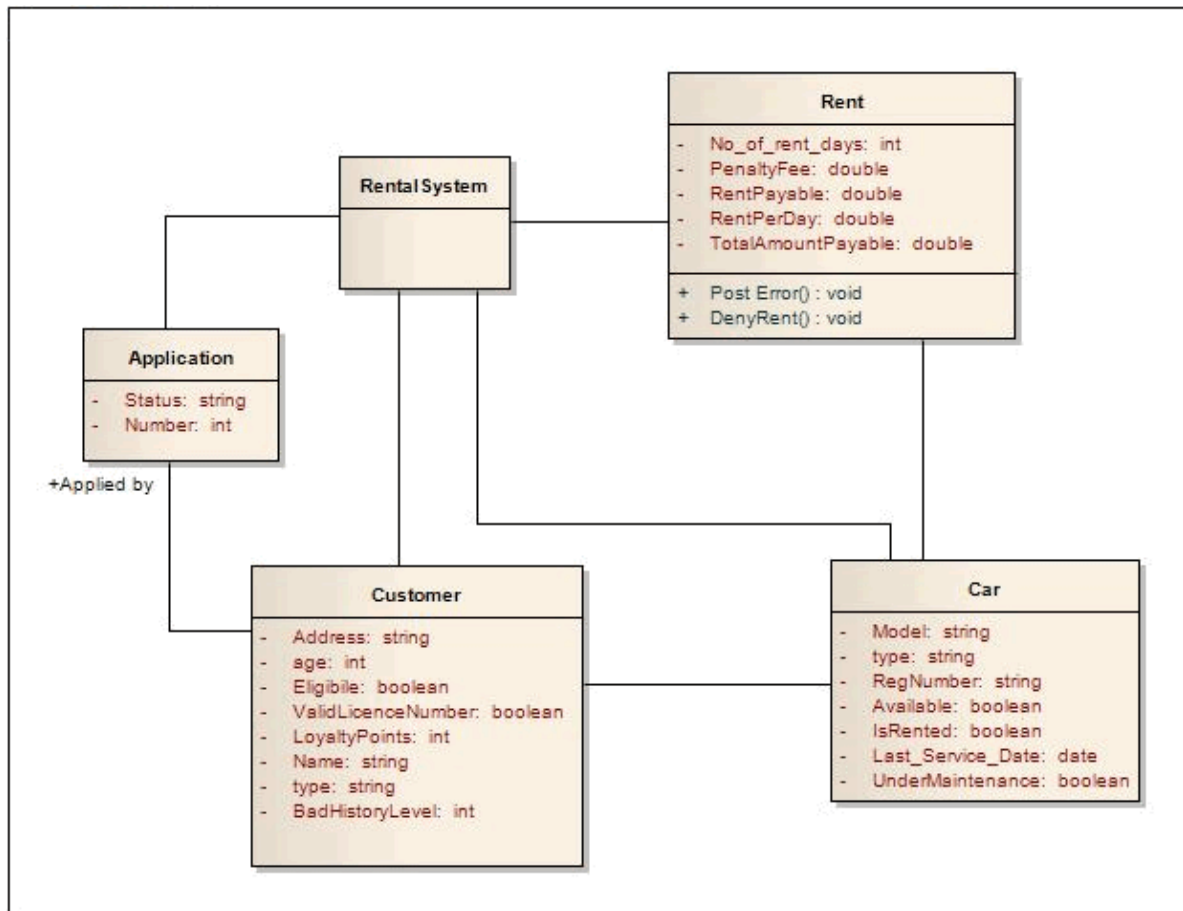

In the example Business Domain model, the Classes *Rent*, *Customer*, *Car* and *Application*, together with their attributes and operations, provide the terms for the business vocabulary. The Class *Rental System* processes the rules. To make *Rental System* process the rules, you add a [Rule Flow Activity](#)<sup>[939]</sup> as a behavior for this Class.

When you create a Rule Flow behavior (Activity) under a Class you can model the rules as *Rule Tasks* (Actions). When code is generated the rule flow behavior is rendered as a method inside the corresponding Class.

Alternatively, if you have existing operations in the Class that already suit the purpose, you can [model business rules in those operations](#)<sup>[943]</sup>. When code is generated for the Class the rules logic is generated as the method body for the corresponding operation.

### 5.2.3.3 Create a Rule Flow Model

You create a *Rule Flow Activity* as a behavior for a Class, to enable that Class to process a set of rules.

To add a Rule Flow Activity to a Class, follow the steps below:

1. On the Business Domain model diagram, right-click on the Class that processes the rules (in the example, *Rental System*).
2. From the context menu select the **Add | RuleFlow Activity** menu option.

A new Rule Flow Activity with a *Rule Flow diagram* is created as a behavior for the selected Class. The Rule Flow diagram models the sequence in which a series of *Rule Tasks* are executed.

Code generation for a Rule Flow model renders each RuleFlow Activity as a set of operations or methods. Depending on what you want these methods to do, you might want to pass in some parameters to be used within the Rule Flow Activity. See the [Pass Parameters to Rule Flow Activity](#)<sup>[942]</sup> topic.

### Add a Rule Task

A Rule Task is a stereotyped Action that groups Business Rules for a specific task. You create Rule Task

elements in a Rule Flow diagram using the associated **Rule Flow** pages of the **Toolbox**.



The following illustration is of a possible Rule Flow diagram for the car rental example.



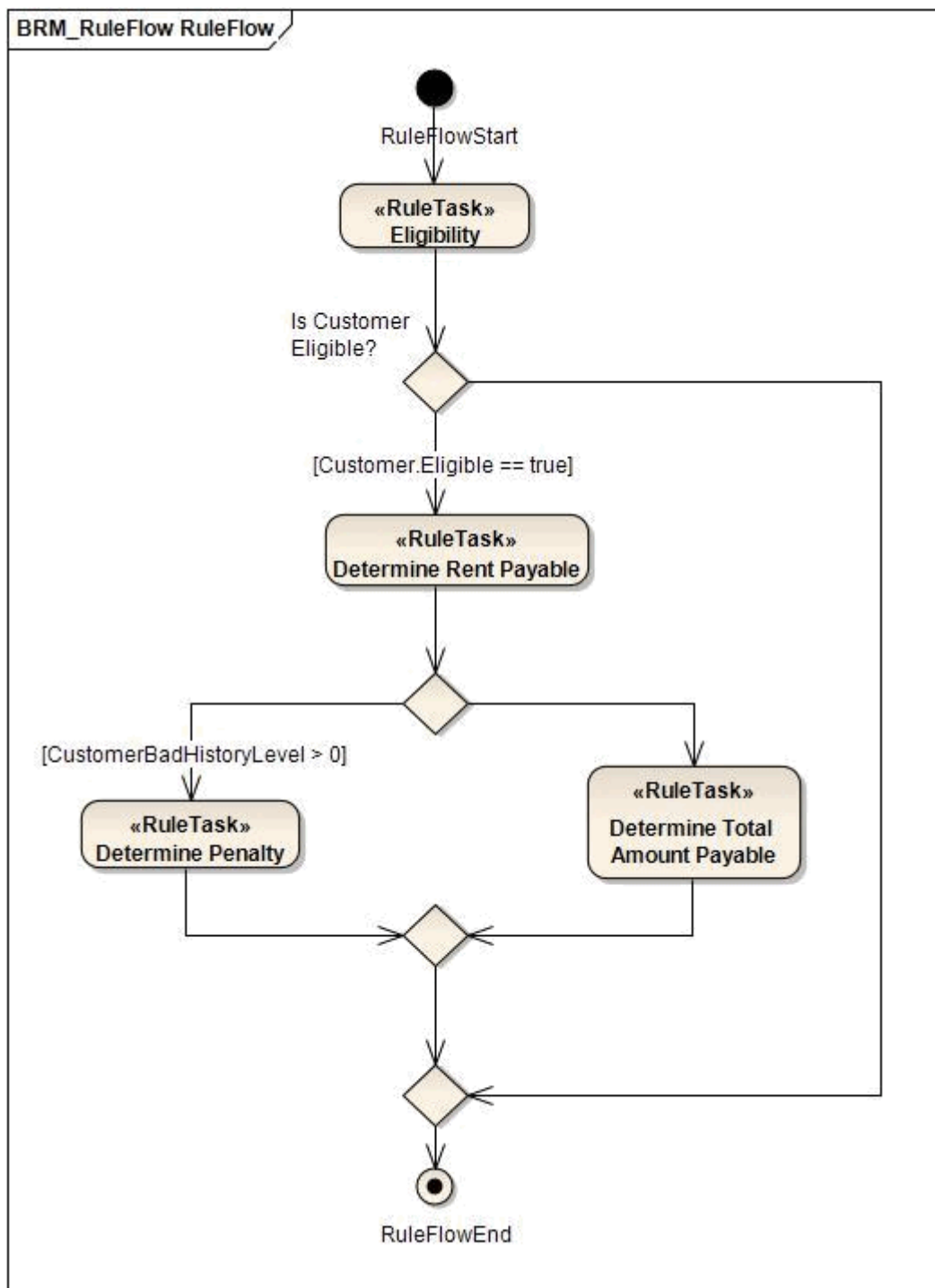

The Rule Task elements *Eligibility*, *Determine Rent Payable*, *Determine Penalty* and *Determine Total Amount Payable* group the business rules for the specific task indicated by the element name. You then [identify the business rules](#) <sup>(937)</sup> for each group.

#### Notes:

- In a Rule Flow diagram, every *Decision Node* has a matching *Merge Node* to ensure proper code generation.
- For code generation, the Rule Task elements must be grouped inside the appropriate Rule Flow Activity in the **Project Browser**. However, Rule elements can be defined anywhere in the model, as they can be used in more than one Rule Task.

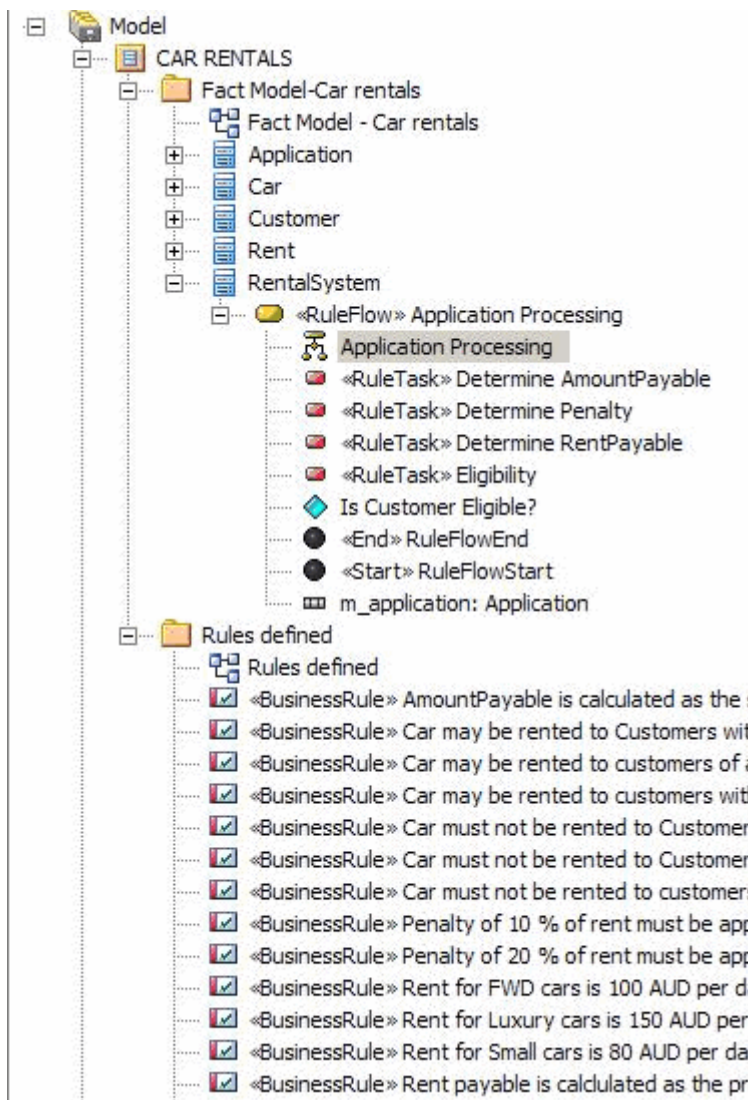

#### 5.2.3.3.1 Pass Parameters to Rule Flow Activity

To pass in parameters to be used within a Rule Flow Activity, follow the steps below:

1. In the **Project Browser**, double-click on the Rule Flow Activity. The element **Properties** dialog displays.
2. Click on the **Behavior** tab.
3. Click on the **Edit Parameters** button. The **Parameters** dialog displays.
4. **Create and define** <sup>583</sup> each parameter, setting Type and Default values.
5. Save each parameter and, when you have finished setting the parameters, close both dialogs.

The Rule Flow Activity parameters can be accessed by the Rule Tasks within the parent Rule Flow Activity. In the following hierarchy, the parameters *m\_rent* and *m\_application* can be used by any of the Rule Tasks under the *ProcessApplication* Rule Flow Activity.

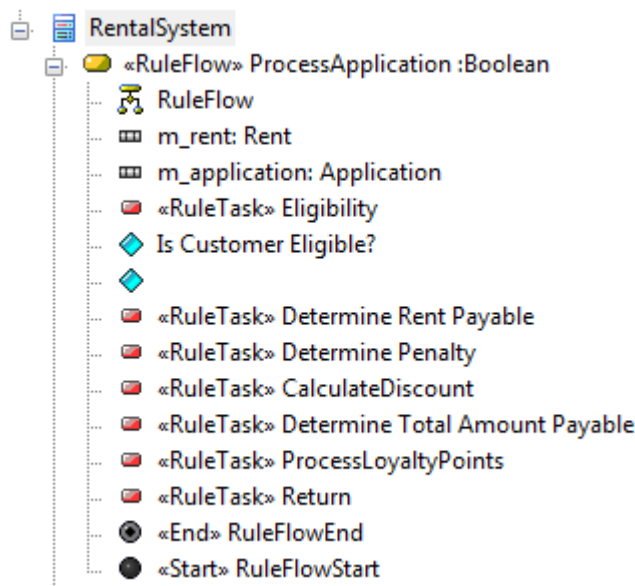

You can use the parameters as condition variables or action variables in the Business Rule [Decision Table](#)<sup>[945]</sup>, or as rule variables in the [Computation Table](#)<sup>[945]</sup> for any of the Rule Tasks. If the Activity parameter is not accessible to a Rule Task, Enterprise Architect displays an error message.

### 5.2.3.3.2 Model Rules In an Operation

You can model business rules either in the [Business Rule](#)<sup>[937]</sup> elements attached to the Rule Task element in a [RuleFlow Activity](#)<sup>[939]</sup> diagram, or in the operations of the rule Class in the [Business Domain model](#)<sup>[938]</sup>.

To model business rules for an operation:

1. Open the **Properties** dialog for the operation and, in the **Stereotype** field on the **General** tab, type the value **RuleTask**.
2. In the **Project Browser**, right-click on the operation and select the **Rule Composer** option to open the **Rule Composer**.
3. [Model the rules for the operation](#)<sup>[945]</sup>.

The operations appear in the **Project Browser** as shown below:

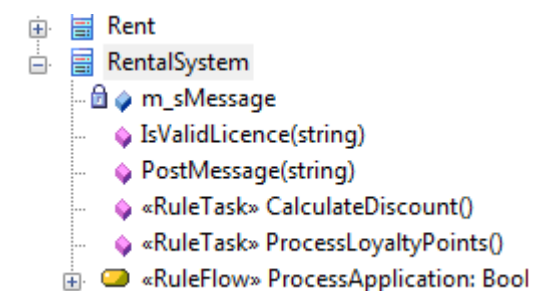

On code generation, the code for rules logic is generated in the method body.

When you drag and drop a RuleTask operation onto a Rule Flow diagram, an [operation call behavior action](#)<sup>[587]</sup> is created. To pass the parameters for this operation call, open the **Properties** dialog and select the **Call** tab. Set the **Behavior** field to the operation to be called. Under the **Arguments** field, click on the **Edit Arguments** button and [edit the argument values](#)<sup>[582]</sup> to be passed.

On the diagram, the call behavior actions for the RuleTask operations are indicated as shown below:

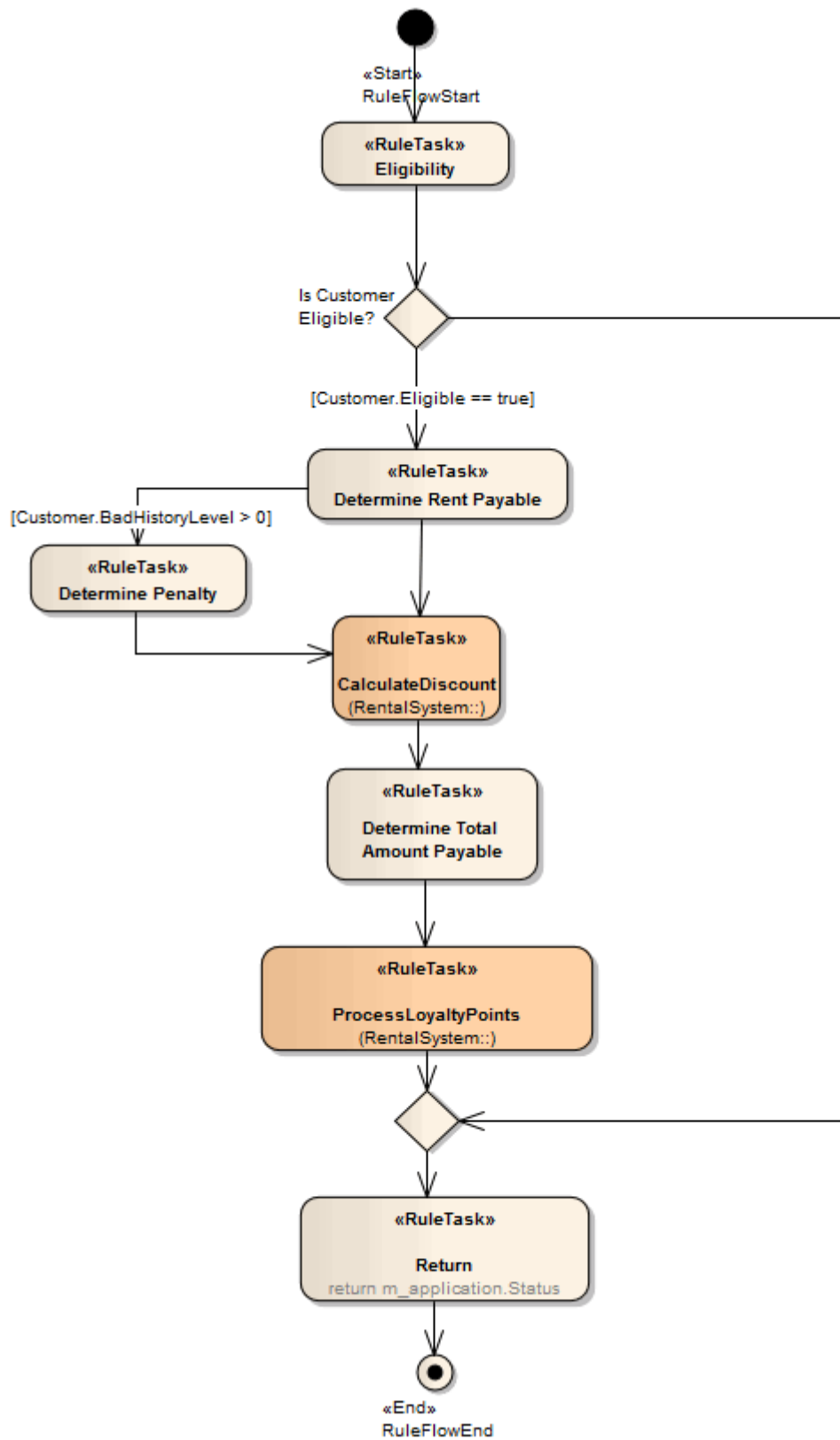

### 5.2.3.4 Compose Business Rules

You use the *Rule Composer* to define a business rule written in plain text within a Business Rule element or Class operation. The *Rule Composer* enables you to model conceptual-level business rules at a logical level in tabulated format, which assists in transforming the rules to technology-specific rules ([code](#)<sup>[95†]</sup>).

You can also [download](#)<sup>[95†]</sup> the contents of the *Rule Composer* to a spreadsheet application such as Microsoft Excel, via a [CSV](#)<sup>[30†]</sup> file.

### Access The Rule Composer

To access the *Rule Composer*, right click on a Rule Task element and select the **Rule Composer** context menu option. The *Rule Composer* displays in the central work area on its own tab.

Rule Composer: "Eligibility" Rule Task

No	Rule Statements				
1	Car must not be rented to customers without a valid licence number				
2	Car must not be rented to Customers of age less than 18				
3	Car must not be rented to Customers with Bad History level 3				

Decision Table    Computation Rule Table

>	Rule Bindings	1	2	3

No	Rule Conditions	Allowable Values	Value1	Value2	Value3
1	Customer.age	>18 and <50 , <18 , >50 , -	-	<18	-
2	Customer.BadHistoryLevel	0 , 1 , 2 , 3 , -	-	-	3
3	Customer.ValidLicenceNumber	Yes , No , -	No	-	-
4					

No	Rule Actions (Outcome)	Allowable Values/Parameters	Result1	Result2	Result3
1	Application.Status	Accept , Reject	Reject	Reject	Reject
2	Customer.Eligible	Yes , No , -	No	No	No
3					

The *Rule Composer* consists of:

- a *Rule Statements* list
- a *Decision Table* and
- a *Computation Rule Table*.

To assist with traceability, as the *Rule Composer* is completed, selections in one table automatically highlight the corresponding rows and columns of the other tables. For example, If a Rule Statement is selected, the related rule column in the *Decision Table* and row in the *Computation Rule Table* are highlighted. Similarly, if a Computational Rule is selected, the corresponding column in the *Decision Table* and row in the *Rule Statements* list are highlighted.

### Rule Statements Table

The *Rule Statements* table lists the rules associated with the selected Rule Task. You add a rule to the table by dragging an existing Business Rule element from the *Project Browser* onto an empty row in the *Rule Statements* table. You cannot create new rules within the table.

To define a business rule associated with the selected Rule Task, follow the steps below:

1. For the first rule, select the text within the Business Rule element and drag it onto the empty row.
2. For a subsequent rule, click on the **No** column and select the **Add Row** context menu option. An empty

row is added to the **Rule Statements** table.

No	Rule Statements
1	Car must not be rented to customers without a valid licence number
2	Car must not be rented to Customers of age less than 18
3	Car must not be rented to Customers with Bad History level 3
4	

Add Row...  
 Remove Rule...

3. Drag the required Business Rule element from the **Project Browser** onto the new row. If the Business Rule element is not already on the diagram, this adds the element to the diagram and creates a Dependency relationship between the Business Rule and Rule Task elements.

To remove a rule that is no longer required in the **Rule Composer**, right-click on the appropriate **No** field and select the **Remove Rule** context menu option.

#### Note:

This removes the rule from the **Rule Composer** and deletes the Dependency relationship with the Rule Task element. However, it does not remove the Business Rule element from either the diagram or the **Project Browser** (where, in either case, it might be in use with other Rule Task elements).

## Decision Table

The **Decision Table** enables you to model *conditional* rules (for example: *Cars must not be rented to customers of age less than 18*).

The table has three sections:

- **Rule Conditions** – to model condition variables
- **Rule Actions** – to model action variables
- **Rule Bindings** – to link the rule in the rule table.

Decision Table		Computation Rule Table			
Rule Bindings		3	2	1	
No	Rule Conditions	Allowable Values	Value1	Value2	Value3
1	Customer.age	<18 , >18 and <50 , >55	<18		
2					
No	Rule Actions (Outcome)	Allowable Values/Parameters	Result1	Result2	Result3
1	Customer.Eligible	Yes , No	No	Yes	Yes
2	Application.Status	Accept , Reject	Reject	Accept	Accept
3					

### Rule Conditions Section

To model Rule Conditions, follow the steps below:

1. The Business Domain model defines the business terms (such as *Customer*) and their associated attributes. From the appropriate Class element in the **Project Browser**, drag and drop the required condition attribute (such as *age*) or operation (such as *IsValidLicense()*) onto the **Rule Conditions** column.

**Notes:**

- The **Rule Condition** field enables you to use intellisense to display a list of possible entries for the field. Press **[Ctrl]+[Spacebar]** in the field to display the list of entries.
- If the Rule Condition is of type *enum*, the **Allowable Values** fields are automatically set with the enum literals. The procedure then ends here.

2. Define a range of accepted values for the Rule Condition.
3. Right-click on the **Allowable Values** column and select the **Edit Allowable Values** context menu option. The **Edit Allowable Values** dialog displays.

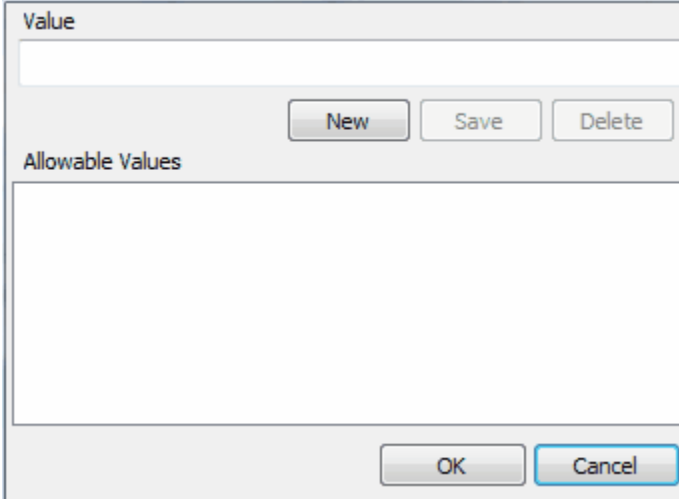

Type each required value or range of values in the **Value** field, and click on the **Save** button to display the value in the **Allowable Values** list box; for example:

age could have the values:

**<18**  
**>18 and <50**  
**>50**

IsValidLicense() could return:

**True**  
**False**

4. Click on the **OK** button to save the values and close the dialog. A new constraint *AllowableValues* is created for the attribute.

**Notes:**

- You can check this constraint by opening the **Properties** dialog for the attribute and selecting the **Constraints** tab.
- If the Rule Condition references an enumeration, the enum literals are not editable in the **Edit Allowable Values** dialog.

5. If the Rule Condition is an operation, you can pass parameters to it. Right click on the **Allowable Values** field, and select the **Edit Parameters** context menu option. The **Edit Parameters** dialog displays. Select the parameters and type their values into the **Value** text box. Click on the **OK** button to cancel the dialog.

Name	Type	Default	Value
LicNumber	string		Customer.L...

**Note:**

You can add an operation as a Rule Condition more than once, to allow calling the operation with different sets of parameters.

To add another Rule Condition, right-click on the **No** column and select the **Add Row** context menu option. An empty row is added to the table.

To remove a Rule Condition from the table, right-click on the appropriate **No** field and select the **Delete Row** context menu option. This does not affect the original attribute *or the new constraint* in the model. You can either re-use the attribute with its constraint, or use the attribute **Properties** dialog to remove the constraint.

**Rule Actions Section**

In the **Rule Actions** section, when a specific value of a Rule Condition calls an operation (such as *post error*) or decision attribute (such as *Eligible - Yes/No*), you assign the operation or attribute as an action. To model Rule Actions, follow the steps below:

1. From a business term Class element in the **Project Browser**, drag and drop the required attribute or operation onto the **Rule Actions** field.

**Note:**

The **Rule Actions** field enables you to use intellisense to display a list of possible entries for the field. Press **[Ctrl]+[Spacebar]** in the field to display the list of entries.

2. For an attribute, double-click on the **Allowable Values/Parameters** field. The **Edit Allowable Values** dialog displays; type the range of values in the text box (such as **Yes, No**; or **Accept, Reject**), click on the **Save** button and close the dialog. Select the appropriate response in the **Result** column fields.

**Note:**

If the dropped action variable is of type *enum*, the **Allowable Values/Parameters** fields are automatically set with the enum literals.

3. For an operation, a checkbox displays in each of the **Result** column fields. To call the operation, select the checkbox in the appropriate column.

To pass parameters to the operation, double-click on the **Allowable Values/Parameters** field. The **Edit Parameters** dialog displays. Select the parameters and type the values into the **Value** text box. Click on the **Save** button and close the dialog.

**Note:**

You can add an operation as a Rule Action more than once, to allow calling the operation with different sets of parameters.

4. Click on the **Save** button in the **Rule Composer** toolbar to save the values.



**Note:**

Alternatively, you can *right-click* on an **Allowable Values/Parameters** field to display a context menu with two options:

- If the Rule Action is an attribute, the **Edit Allowable Values** option is enabled and this displays the **Edit Allowable Values** dialog
- If the Rule Action is an operation, the **Edit Parameters** option is enabled and this displays the **Edit Parameters** dialog.

To add another Rule Action, right-click on the **No** column and select the **Add Row** context menu option. An empty row is added to the table.

To remove a Rule Action from the table, right-click on the appropriate **No** field and select the **Delete Row** context menu option. This does not affect the original attribute or operation in the model.

### Rule Bindings Section

The **Rule Bindings** section lies on top of the **Rule Conditions** section. It binds the Rule Condition and Rule Action values to the appropriate rule in the **Rule Table**. To bind a rule, follow the steps below.

1. Select the rule number in the **Rule Bindings** field over one of the **Value<n>** or **Result<n>** columns.
2. Ensure that the values set in the **Value<n>** or **Result<n>** field for the Rule Condition or Rule Action, underneath the rule number, all satisfy the rule.
3. Click on the **Save** icon in the **Rule Composer** toolbar.

For example, (referring to the screen diagram at the top of this *Rule Composer* topic) if rule 2 is *Car must not be rented to Customers of age less than 18*:

- Select **2** in the **Rule** field over the **Value1** column
- Select **< 18** against *Customer.age* in the **Value1** column in the Rule Conditions table
- Select **No** against *Customer.Eligible* in the **Result1** column in the Rule Action table
- Select **Reject** against *Application.Status* in the **Result1** column in the Rule Action table.

### Computation Rule Table

The **Computation Rule** table enables you to model rules involving computations.

No	Computation Rule Actions	Expression	Rule Bindings	Rule Dependency
1	Rent.TotalAmountPayable	Rent.RentPerDay + Rent.PenaltyFee	1	
2				

The table has the following columns:

- **Computation Rule Actions**
- **Expression**
- **Rule Bindings**
- **Rule Dependency**.

To define a computation rule, follow the steps below:

1. From the **Project Browser**, drag and drop the appropriate attribute from a Class in the *Fact* model into the **Computation Rule Actions** field.

**Note:**

Both the **Computation Rule Actions** field and the **Expression** field enable you to use intellisense to display a list of possible entries for the fields. Press **[Ctrl]+[Spacebar]** in the field to display the list of entries.

2. In the **Expression** field, type the expression to be evaluated.
3. In the **Rule Bindings** field, type the rule number from the **Rule** table of the rule being modeled, to link the table data to the rule.
4. If the rule depends on another rule being satisfied first, type the number of that rule in the **Rule Dependency** field.
5. Click on the **Save** icon in the **Rule Composer** toolbar to save the computation rule.

If the computation rule is also a Rule Conditions rule, add the condition variable in the **Decision** table and bind the appropriate rule in the **Rule Bind** section.

### Export Rules To CSV File

To export the contents of the **Rule Composer** to a CSV file, follow the steps below:

1. Click on the **Export to CSV** icon () in the **Rule Composer** toolbar. The Windows **Browser** dialog displays.
2. Browse to the required file location and type in a .CSV filename to export to.
3. Click on the **Save** button to export the data.

#### 5.2.3.5 Validate Business Rules

It is recommended practice to validate the business rules in the **Rule Composer** before you generate code for the Rule Task elements. To do this, click on the **Validation** (green tick) icon in the **Rule Composer** toolbar.



The business rules on the **Rule Composer** are parsed and any errors or warnings that might indicate incomplete or unfavorable code generation are displayed on a **Rule Composer Validation** tab on the **Output** screen. For example:

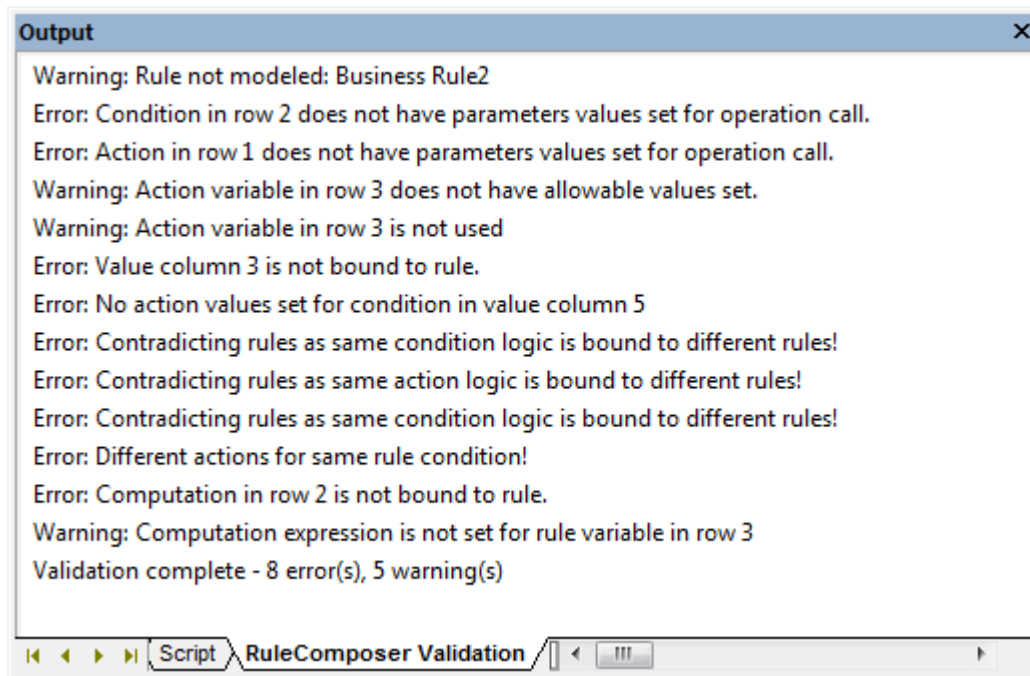

To highlight and investigate the faulty data in the **Rule Composer**, double-click on the appropriate warning or error message.

### 5.2.3.6 Code Generation For Business Rules

After you have modeled the business rules for all the Rule Task elements in the Rule Flow diagram, you can generate code from the Rule Flow behavior.

To return a value from the Rule Flow behavior:

1. Double-click on the last Rule Task element before the end node of the Rule Flow diagram. The element's **Properties** dialog displays.
2. Click on the **Effect** tab.
3. In the **Effect** field, type the *return* statement; for example, *return true*.
4. Click on the **Save** button, and on the **OK** button to close the dialog.

[Generate code for the Class](#)<sup>[1309]</sup> containing the rule flow behavior (in our initial example, [Rental System](#)<sup>[938]</sup>). The code for business rules logic is generated, with the rule statements expressed in natural language as comments.

The following code snippet was generated from the *Rental System* Class element in our example:

```

////////////////////////////////////
// RentalSystem.cs
// Implementation of the Class RentalSystem
// Generated by Enterprise Architect
// Created on: 08-May-2009 2:39:23 PM
////////////////////////////////////

public class RentalSystem {

    public Customer m_Customer;
    public Car m_Car;
    public Rent m_Rent;

    public RentalSystem(){

    }

    ~RentalSystem(){

    }

    public virtual void Dispose(){

    }

    /* Begin - EA generated code for Activities and Interactions */

    public bool ProcessApplication(Rent m_rent,Application m_application)
    {
        // behavior is an Activity

        /*CAR MUST NOT BE RENTED TO CUSTOMERS WITHOUT A VALID LICENCE NUMBER*/
        if( m_Customer.ValidLicenceNumber == "FALSE" )
        {
            m_application.Status = "Reject";
            m_Customer.Eligibile = false;
        }
        /*CAR MUST NOT BE RENTED TO CUSTOMERS OF AGE LESS THAN 18*/
        if( m_Customer.age < 18 )
        {
            m_application.Status = "Reject";
            m_Customer.Eligibile = false;
        }
        /*CAR MUST NOT BE RENTED TO CUSTOMERS WITH BAD HISTORY LEVEL 3*/
        if( m_Customer.BadHistoryLevel == 3 )
        {
            m_application.Status = "Reject";
            m_Customer.Eligibile = false;
        }
        if (Customer.Eligibile == true)
        {

            /*RENT FOR SMALL CARS IS 80 AUD PER DAY*/

```

```

        if( m_Car.type == Small )
        {
            m_rent.RentPerDay = 80;
        }
        /*RENT FOR AWD CARS IS 100 AUD PER DAY*/
        if( m_Car.type == AWD )
        {
            m_rent.RentPerDay = 100;
        }
        /*RENT FOR LUXURY CARS IS 150 AUD PER DAY*/
        if( m_Car.type == Luxury )
        {
            m_rent.RentPerDay = 150;
        }
        /*RENT PAYABLE IS CALCULATED AS THE PRODUCT OF RENTPERDAY AND
RENTALPERIOD IN DAYS*/
        m_rent.RentPayable = m_rent.RentPerDay * m_rent.No_of_rent_days;
        if (CustomerBadHistoryLevel > 0)
        {
            /*PENALTY OF 20 % OF RENT MUST BE APPLIED FOR CUSTOMERS
WITH BAD HISTORY LEVEL 2*/
            if( m_Customer.BadHistoryLevel == 2 )
            {
                m_rent.PenaltyFee = m_rent.RentPayable * 0.2;
            }
            /*PENALTY OF 10 % OF RENT MUST BE APPLIED FOR CUSTOMERS
WITH BAD HISTORY LEVEL 1*/
            if( m_Customer.BadHistoryLevel == 1 )
            {
                m_rent.PenaltyFee = m_rent.RentPayable * 0.1;
            }
        }
        else
        {
        }
        }
        /*TOTAL AMOUNT PAYABLE IS CALCULATED AS THE SUM OF RENT PAYABLE
AND PENALTY IF ANY.*/
        m_rent.TotalAmountPayable = m_rent.RentPerDay + m_rent.PenaltyFee;
        }
        else
        {
        }
        }
        return m_application.Status;
    }

    /* End - EA generated code for Activities and Interactions */

} //end RentalSystem

```

## 5.2.4 BPMN Models

The following text is derived from the [Business Process Modeling Notation](#) entry in the online Wikipedia.

*The Business Process Modeling Notation (BPMN) is a standardized graphical notation for drawing business processes in a workflow. BPMN was developed by Business Process Management Initiative (BPMI), and is now being maintained by the Object Management Group since the two organizations merged in 2005.*

*The primary goal of BPMN is to provide a standard notation that is readily understandable by all business stakeholders. These business stakeholders include the business analysts who create and refine the processes, the technical developers responsible for implementing the processes, and the business managers who monitor and manage the processes. Consequently BPMN is intended to serve as common language to bridge the communication gap that frequently occurs between business process design and implementation.*

*... The adoption of BPMN standard notation will help unify the expression of basic business process concepts (e.g. public and private processes, choreographies) as well as advanced modeling concepts (e.g. exception handling, transaction compensation).*

*BPMN ... supports only the concepts of modeling that are applicable to business processes ... other types of modeling done by organizations for non-business purposes [are] out of scope for BPMN. For*

example, ... modeling ... the following is not a part of BPMN:

- Organizational structures
- Functional breakdowns
- Data models

In addition, while BPMN shows the flow of data (messages) and the association of data artifacts to activities, it is not a data flow diagram.

For further information on the concepts of BPMN, refer to the [Wikipedia](#) item and its linked sources.

#### Note:

The Enterprise Architect installer for releases later than 7.1 provides you with version 1.5 of MDG Technology for BPMN, which supports BPMN version 1.1 and BPEL. This enables you to create and maintain diagrams in the BPMN 1.1 and BPEL formats.

The installer also provides version 1.4.4 of MDG Technology for BPMN, which supports BPMN 1.0. This enables you to maintain existing diagrams created in BPMN 1.0 format, and to create new diagrams in BPMN 1.0 if you want to maintain consistency through your project.

Enterprise Architect also enables you to [migrate a BPMN 1.0 model \(or part of a model\) to BPMN 1.1](#)<sup>[957]</sup>.

## BPMN in Enterprise Architect

The BPMN notation is specifically targeted at the business modeling community and has a relatively direct mapping to UML through BPMN Profiles integrated with the Enterprise Architect installer. Through use of these profiles, Enterprise Architect enables you to develop BPMN diagrams quickly and simply. The BPMN facilities are provided in the form of:

- A BPMN diagram type, accessed through the [New Diagram](#)<sup>[422]</sup> dialog
- **BPMN** pages in the **Toolbox**
- BPMN element and relationship entries in the [Toolbox Shortcut](#)<sup>[403]</sup> menu and [Quick Linker](#)<sup>[474]</sup>.

### BPMN Toolbox Pages

You can access the **BPMN** pages of the **Toolbox** through the **More tools | BPMN 1.0** and **BPMN 1.1** menu options. These pages provide the graphical (Core) and non-graphical (Types) BPMN elements for use on business process diagrams.

Specifications of these elements and relationships are defined by Tagged Values (for example, to define the *Message*, *Timer* and *Default Path (/)* symbols in the diagram below).

For further information on BPMN and Tagged Values, see the [Change BPMN Element Appearance](#)<sup>[956]</sup> topic.

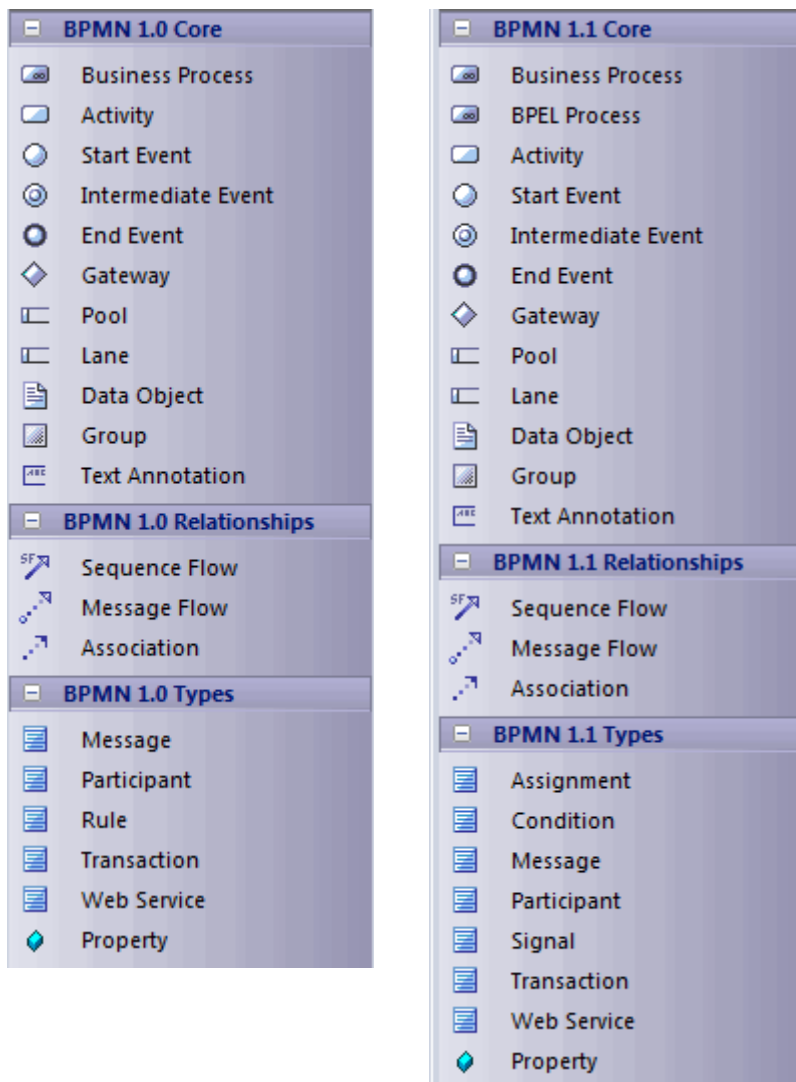

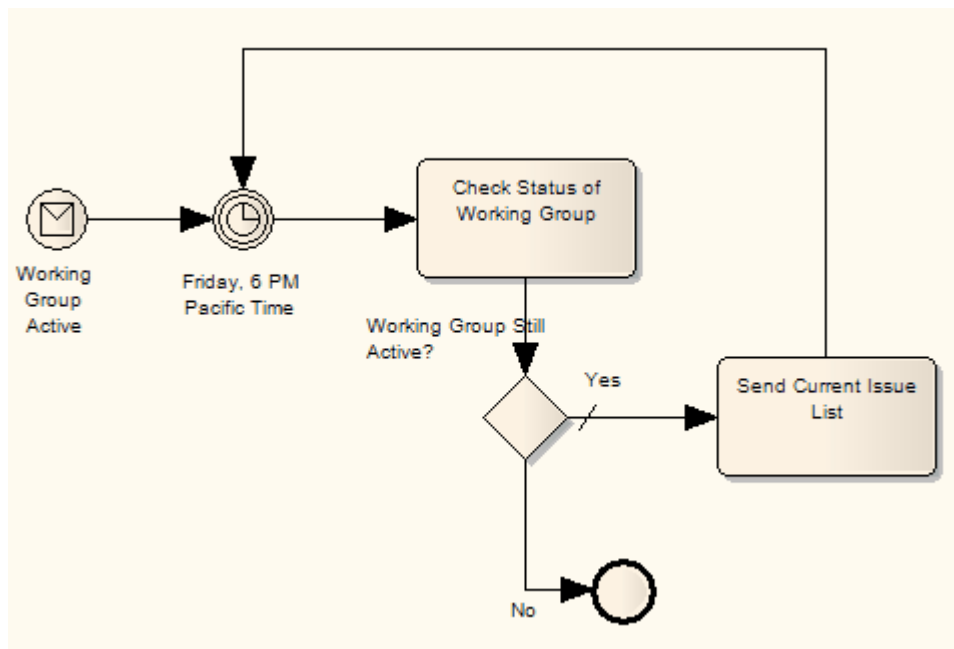

Page	Item	Use to
Core	<b>Business Process</b>	Extend a <i>composite Activity</i> that defines a business process.
	<b>BPEL Process</b>	Define the behavior of an executable or abstract business process.
	<b>Activity</b>	Define an activity within a business process
	<b>Start Event</b>	Define the initiating event in a process.
	<b>Intermediate Event</b>	Define an intermediate event in a process.
	<b>End Event</b>	Define the terminating event in a process.
	<b>Gateway</b>	Define a decision point in a business process. If a condition is true, then processing continues one way; if not, then another.
	<b>Pool</b>	Extend a <i>Partition</i> element to logically organize an Activity.
	<b>Lane</b>	Extend a <i>Partition</i> element to subdivide a Pool.
	<b>Data Object</b>	Extend an <i>Artifact</i> element to define a physical piece of information used or produced by a system.
	<b>Group</b>	Extend a <i>Boundary</i> element to group other elements.
	<b>Text Annotation</b>	Create a comment.
	Relationships	<b>Sequence Flow</b>
<b>Message Flow</b>		Extend a <i>Control Flow</i> relationship to define the flow of communications in the process.
<b>Association</b>		Associate information and artifacts with flow objects.
Types	<b>Assignment</b>	

Page	Item	Use to
	Condition	Define the <i>properties</i> (Tagged Values) of the Core BPMN 1.1 elements such as Activities, Events and Gates.
	Message	
	Participant	
	Signal	
	Rule	
	Transaction	
	Web Service	
	Property	

## Disable BPMN

If you prefer not to use BPMN in Enterprise Architect, you can disable it (and subsequently re-enable it) using the [MDG Technologies](#)  dialog (**Settings | MDG Technologies**).

### 5.2.4.1 Change BPMN Element Appearance

To define the specifications of BPMN elements and relationships, open the **Tagged Values** window and select the required element or relationship in a diagram. The **Tagged Values** window shows the appropriate Tagged Values and provides a list of values to assign to each one.

Some Tagged Values directly affect the appearance of the elements they apply to, as described in the following examples:

- Events - to change the decoration of a Start Event or Intermediate Event, set the *Trigger* Tagged Value; to change the decoration of an End Event, set the *Result* Tagged Value. For example, to create a BPMN 'off-page' connector, set the *Trigger* or *Result* Tagged Value to **Link** to depict flow onto the diagram, into a branch diagram or off the diagram for the Start, Intermediate and End events respectively.
- Gateways - to create the different varieties of Gateway, set the *GatewayType* Tagged Value; other display options are available for XOR gateways - you can set the *XORType* Tagged Value to create Event-based or Data-based XOR gateways, and for Data-based XOR gateways you can set the *MarkerVisible* Tagged Value to **false** to hide the decoration.
- Activities - there is a wide variety of appearance options for Activities:
  - The *ActivityType* Tagged Value can be set to **Task** or **Sub-Process**; the latter option displays the 'plus-in-a-box' decoration on the bottom edge of the shape
  - An Ad-hoc Activity is shown by setting the *AdHoc* Tagged Value to **true**; this displays the 'tilde' decoration on the bottom edge of the shape
  - A Compensation Activity is shown by setting the *IsCompensation* Tagged Value to **true**; this displays the 'rewind' icon on the bottom edge of the shape
  - A Multiple Instance Activity is shown by setting the *LoopType* Tagged Value to **MultInstance**; this displays the 'pause' icon on the bottom edge of the shape
  - A Loop Activity is shown by setting the *LoopType* Tagged Value to either **Standard** or **MultInstance**, this displays the 'loop' icon on the bottom edge of the shape.
  - Transactions - to denote a Transaction with a double-lined border, set the *IsATransaction* Tagged Value to **true**.
- Sequence Flows - to put a diagonal slash across the line at the source end, set the *ConditionType* Tagged Value to **Default**; to put an unfilled diamond-shaped decoration at the source end, set the Tagged Value to **Expression**.

### Version Differences

Some BPMN elements have changed in appearance between BPMN version 1.0 and BPMN version 1.1.

In Enterprise Architect releases later than 7.1, if you work on a model created in an earlier release, using BPMN 1.0, existing elements default to their version 1.0 appearance. New elements assume the BPMN



version 1.1 appearance and automatically have a Tagged Value *BPMNVersion* set to **1.1**

If you want a new element to revert to the BPMN version 1.0 appearance, set the Tagged Value to **1.0**. Conversely, if you want an older element to assume the BPMN version 1.1 appearance, assign the *BPMNVersion* Tagged Value to it, with the value **1.1**.

#### 5.2.4.2 Migrate BPMN 1.0 Model to BPMN 1.1

##### Note:

This facility is available from Release 7.5 of Enterprise Architect.

Enterprise Architect enables you to migrate a BPMN 1.0 model (or part of a model) to BPMN 1.1, using the Automation Interface function [MigrateToBPMN11\(\)](#)<sup>[1762]</sup>. This function updates the Tagged Values and, if required, stereotypes to BPMN 1.1 for all elements, attributes, connectors and diagrams under the selected package or element.

##### Warning:

In BPMN 1.0, various tags have free-text direct-entry value fields, and you can provide *additional* information on these tags in the **Tagged Value Note** dialog for display at the bottom of the **Tagged Values**<sup>[632]</sup> window.

In BPMN 1.1, some of these tags (such as the *Categories* tag on a BusinessProcess stereotyped element) have been changed to **memo** type, and you use the **Tagged Value Note** dialog to enter the value; therefore, you cannot have additional notes for these tags, all information must be within the tag's value.

For such tags, when migrating from BPMN 1.0 to BPMN 1.1, the BPMN 1.0 tag *value* is moved into the BPMN 1.1 tag *notes* field and the BPMN 1.0 tag notes are discarded. If you want to preserve the tag notes text, take a copy of the BPMN 1.0 model *before* migration to enable you to copy the tag notes text into the tag value *after* migration.

The following VB script calls the *MigrateToBPMN11()* function to migrate the Tagged Values to BPMN 1.1:

```
Sub MigrateElement (sGUID, lngPackageID)
    Dim proj as EA.Project
    set proj = Repository.GetProjectInterface
    proj.MigrateToBPMN11 sGUID, "BPMN"

    'refresh the model
    If lngPackageID <> 0 Then
        Repository.RefreshModelView (lngPackageID)
    End If
End Sub

Sub MigrateSelectedItem
    Dim selType
    Dim selElement as EA.Element
    Dim selPackage as EA.Package

    selType = GetTreeSelectedItemType

    If selType = 4 Then 'means Element
        set selElement = GetTreeSelectedObject
        MigrateElement selElement.ElementGUID, selElement.PackageID
        MsgBox "Complete",0,"BPMN 1.1 Migration"

    ElseIf selType = 5 Then 'means Package
        set selPackage = GetTreeSelectedObject
        MigrateElement selPackage.PackageGUID, selPackage.PackageID
        MsgBox "Complete",0,"BPMN 1.1 Migration"

    Else
        MsgBox "Select a Package or Element in the Project Browser to initiate migration",0,"BPMN 1.1 Migration"
    End If
End Sub
```

End Sub

Sub Main

MigrateSelectedItem

End Sub

Main

## 5.2.5 BPEL Models

### Note:

Business Process Execution Language (BPEL) is supported in the Business and Software Engineering and Ultimate editions of Enterprise Architect.

The following text is derived from the [BPEL](#) entry in the online Wikipedia :

*Business Process Execution Language (BPEL), short for Web Services Business Process Execution Language (WS-BPEL), is an executable language for specifying interactions with Web Services. Processes in Business Process Execution Language export and import information by using Web Service interfaces exclusively.*

*Web service interactions can be described in two ways :*

1. *Executable business processes, which model the actual behavior of a participant in a business interaction.*
2. *Abstract business processes, which are partially specified processes that are not intended to be executed. An Abstract Process may hide some of the required concrete operational details.*

*BPEL is an [Orchestration](#) language, serialized in XML, which specifies an executable process that involves message exchanges with other systems. This messaging facility depends on the use of the Web Services Description Language (WSDL) 1.1 to describe outgoing and incoming messages.*

Although there is no standard graphical notation for WS-BPEL, Enterprise Architect uses BPMN version 1.1 as a graphical front-end to capture BPEL 1.1 process descriptions. The BPMN specification includes an informal and partial mapping from BPMN to BPEL 1.1.

For further information on the concepts of BPEL, refer to the [Wikipedia](#) item and its linked sources.

## BPEL in Enterprise Architect

Enterprise Architect currently supports generating BPEL from executable processes. With the help of the BPMN version 1.1 Profile, Enterprise Architect enables you to develop BPEL diagrams quickly and simply. The BPEL facilities are provided in the form of:

- A BPEL Model Template in the [Select Models](#)<sup>[372]</sup> dialog
- A BPEL diagram type, accessed through the [New Diagram](#)<sup>[422]</sup> dialog
- A *BPEL Process* element in the [BPMN 1.1 Core](#)<sup>[952]</sup> [Toolbox](#) pages, which acts as a container from which BPEL can be generated
- Custom dialogs for BPMN elements, highlighting the BPMN Tagged Values relevant to BPEL generation.

## BPEL Example Generation

The Enterprise Architect Example file (*EAExample.EAP*) has a sample BPMN 1.1 model from which BPEL can be generated. If you have installed Enterprise Architect at the default location, open this file:

C:\Program Files\Sparx Systems\EA\EAExample.EAP

The BPMN model package, within *EAExample.EAP*, is in: **System Model -> Implementation Model (PSM) -> BPEL Example.**

## Modeling Restrictions

- Use the elements from the BPMN 1.1 [Toolbox](#) pages for BPEL modeling.
- Every BPEL Process and Sub-Process should start with a StartEvent and end with an EndEvent.
- A StartEvent or an EndEvent should not be attached to the boundary of a Sub-Process.
- SequenceFlow Looping is not supported - only Activity looping is supported. All SequenceFlows should

flow downstream and not upstream.

- Mapping of an IntermediateEvent with multiple triggers to BPEL is not supported.
- Mapping of multi-instance parallel While loops to BPEL is not supported.
- Mapping of Independent sub-processes to BPEL is not supported.

#### See Also

- [Create a BPEL Model](#)<sup>[959]</sup>
- [Model a BPEL Process](#)<sup>[961]</sup>
- [Model a Sequence Flow Connector](#)<sup>[980]</sup>
- [Create Assignments](#)<sup>[981]</sup>
- [Generate BPEL](#)<sup>[983]</sup>
- [Create a BPEL Web Service](#)<sup>[983]</sup>
- [BPEL Model Validation](#)<sup>[984]</sup>

### 5.2.5.1 Create a BPEL Model

You can create a BPEL model from the **Project Browser**, using the [Select Model\(s\)](#)<sup>[372]</sup> (Model Wizard) dialog.

To display the dialog, use one of the following methods:

- Click on the **New Model from Pattern** icon in the **Project Browser** toolbar
- Right-click on a model root node and select the **Add a New Model using Wizard** context menu option
- Right-click on a package and select the **Add | Add a New Model using Wizard** context menu option.

The BPEL model pattern is available in the Common catalog (in the **Select From** field, select **Common**).

### BPEL Package Structure

Notice the BPEL Process (*LoanApproval\_Process*) itself and the supporting components (*SupportingElements* and *Participant Pools*).

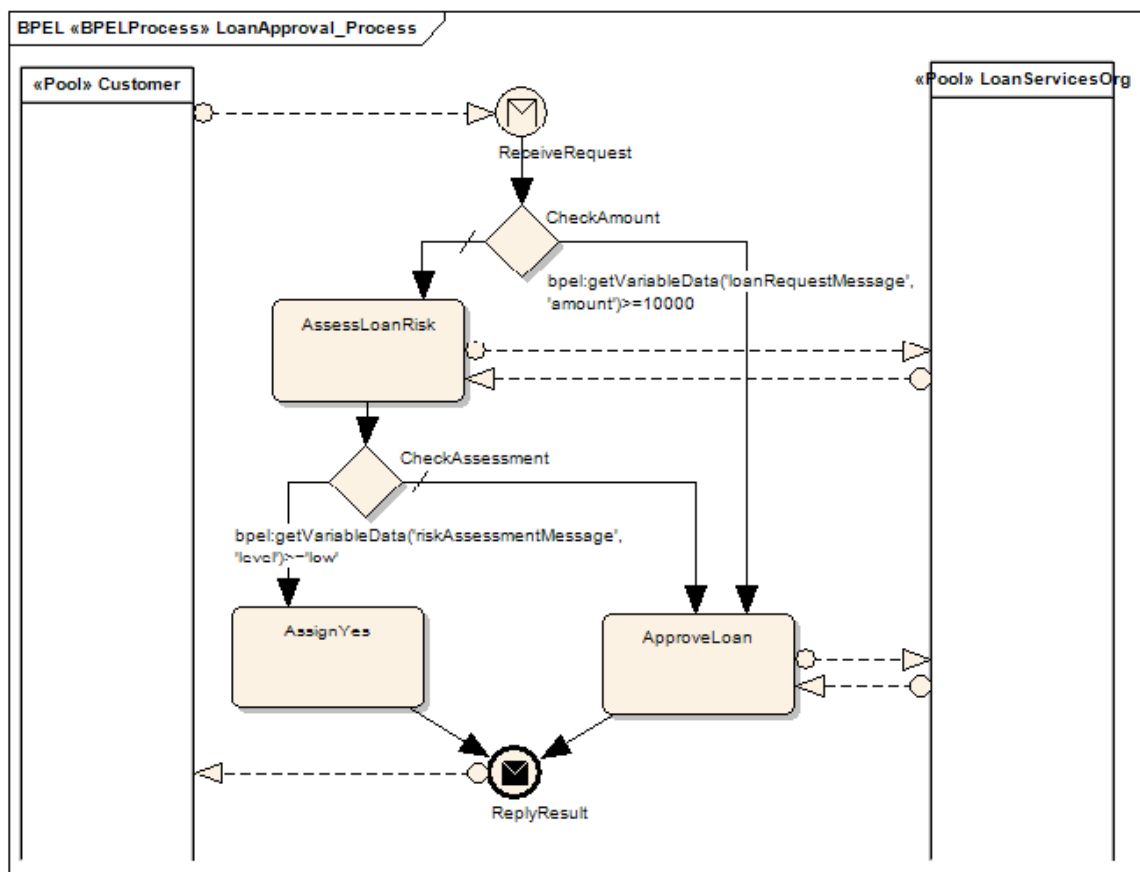
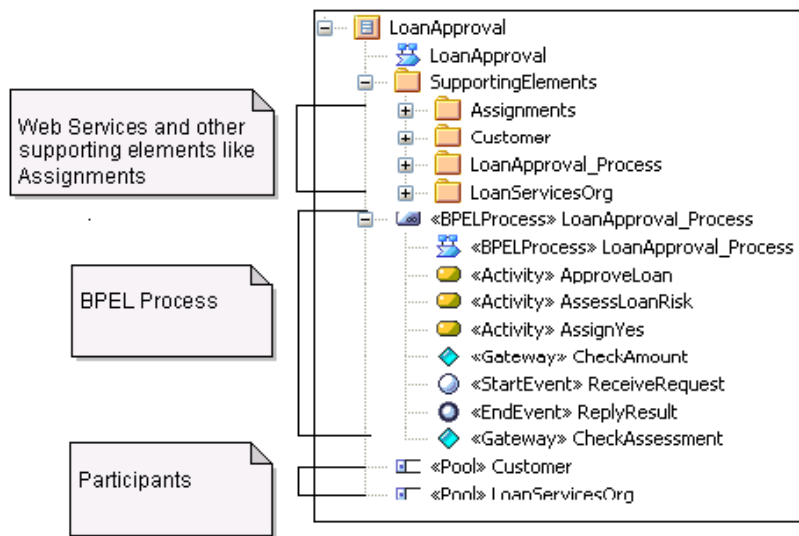

**See Also**

- [Model a BPEL Process](#) <sup>[96]</sup>
- [Model a Sequence Flow Connector](#) <sup>[980]</sup>
- [Create Assignments](#) <sup>[981]</sup>
- [Generate BPEL](#) <sup>[983]</sup>
- [Create a BPEL Web Service](#) <sup>[983]</sup>

- [BPEL Model Validation](#)<sup>[984]</sup>

### 5.2.5.2 Model a BPEL Process

The *BPEL Process* in Enterprise Architect represents the top-level container for the BPEL elements, from which BPEL can be generated. Conceptually it maps to the BPEL *process* element.

To create a BPEL Process in your BPEL model, follow the steps below:

1. Open or create a BPEL diagram.
2. Open the **BPMN 1.1** pages of the **Toolbox (More tools | BPMN 1.1)**.
3. Drag a *BPEL Process* element from the **Toolbox** onto the diagram. The **BPEL Properties** dialog displays.

The screenshot shows the 'BPEL Properties' dialog box. It has a 'Name' field with the text 'BPELProcess2'. Below it is a 'Type' dropdown menu showing 'BPEL Process'. Underneath is a 'Process Type' dropdown menu which is currently empty. A 'Details' section is expanded, showing three fields: 'Query Language' with the value 'XPath 1.0', 'Process Type' with the value 'Private', and 'Ad Hoc' with the value 'False'. At the bottom of the dialog are four buttons: 'UML', 'OK', 'Cancel', and 'Help'.

4. In the **Name** field, type a name for the BPEL Process.
5. The **Query Language** field defaults to **XPath 1.0**. The **Process Type** field is pre-set to **Private** (Enterprise Architect can generate BPEL from private processes only) and the **Ad Hoc** field is pre-set to **False**.

#### Note:

Click on the **UML** button if you need to define further properties of the BPEL Process, using the normal element [Properties](#)<sup>[481]</sup> dialog and [Behavior](#)<sup>[581]</sup> tab.

6. Click on the **OK** button to close the dialog.

To return to the **BPEL Properties** dialog for subsequent editing:

- Double-click on the element in the **Project Browser** (the [Shows Properties](#)<sup>[351]</sup> option must be selected in the **Double click on browser** panel of the **Options** dialog) or
- Right-click on the element in the diagram or **Project Browser** and select the **BPEL | BPEL Properties** context menu option.

The BPEL Process element is a stereotyped Activity that, when created, has a child diagram. Double-click on the element to display the diagram, and use further elements from the **BPMN 1.1 Core** page of the **Toolbox** to model the process; specifically:

- [Start Event](#)<sup>[962]</sup>
- [End Event](#)<sup>[965]</sup>
- [Intermediate Event](#)<sup>[966]</sup>
- [Gateway](#)<sup>[972]</sup>

- [Activity](#)<sup>[974]</sup>
- [Pool](#)<sup>[979]</sup>

**Note:**

On the [BPMN 1.1 Core](#) page, the following elements are not mappable to BPEL:

- Pool
- Lane
- Data Object
- Group
- Text Annotation.

**See Also**

- [Create a BPEL Model](#)<sup>[959]</sup>
- [Model a Sequence Flow Connector](#)<sup>[980]</sup>
- [Create Assignments](#)<sup>[981]</sup>
- [Generate BPEL](#)<sup>[983]</sup>
- [Create a BPEL Web Service](#)<sup>[983]</sup>
- [BPEL Model Validation](#)<sup>[984]</sup>

### 5.2.5.2.1 Model Start Event

A *Start Event* indicates where a particular Process begins. Every Process in Enterprise Architect must begin with a Start Event.

A Process can start in several ways, depending on the Trigger Type. The *OMG BPMN 1.1 Specification* defines six types of Trigger:

- None
- Message
- Timer
- Conditional
- Signal
- Multiple

In Enterprise Architect, four of these Trigger types can be mapped to BPEL as per the *OMG BPMN 1.1 Specification*:

- Message
- Timer
- Conditional
- Multiple

To create a new Start Event in your model, follow the steps below:

1. Open a BPEL diagram [created under a BPEL Process](#)<sup>[961]</sup>.
2. Drag the *Start Event* element from the [BPMN 1.1 Core](#) page of the **Toolbox** onto the diagram. A prompt displays to select either an *edge-mounted* event (on an element border) or a *standalone* event.
3. Click on either option. The BPEL **Properties** dialog displays.

Name: StartEvent1  
Type: Start Event  
Trigger Type: None

Details Assignments

'None' Trigger Type cannot be mapped to BPEL

UML OK Cancel Help

4. In the **Name** field, type a name for the Event.
5. Click on the drop-down arrow in the **Trigger Type** field and select the required type. Depending on the trigger type you select, further details might be required.

If you select **Timer**:

6. The **Details** tab changes as below:

Details Assignments

Time Cycle: 1  
Time Date:  5/02/2009

7. In the **Time Cycle** field, type the value of the time cycle.
8. The **Time Date** field defaults to today's date. If it is necessary to change the date, click on the checkbox and the drop-down arrow and select a new date from the calendar.

**Note:**

The **Time Cycle** and **Time Date** fields are mutually exclusive, so you can only set one of them.

9. Go to step 10.
- If you select **Message**:

6. The **Details** tab changes, as below.

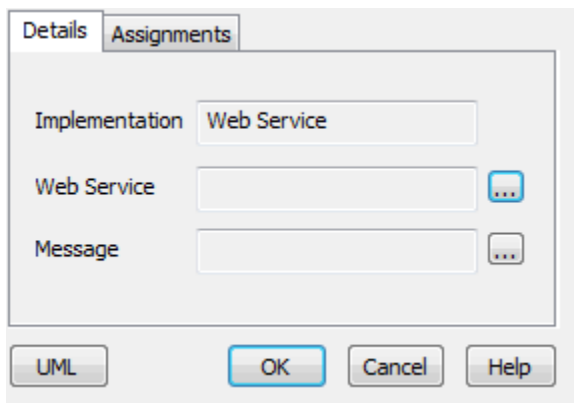

7. To the right of the **Web Service** field, click on the [ ... ] button and select a [BPEL web service](#)<sup>[983]</sup> from the list.
8. To the right of the **Message** field, click on the [ ... ] button and select a message from the list of all messages in the selected web service.
9. Go to step 10.

If you select **Conditional**:

6. The **Details** tab changes, as below.

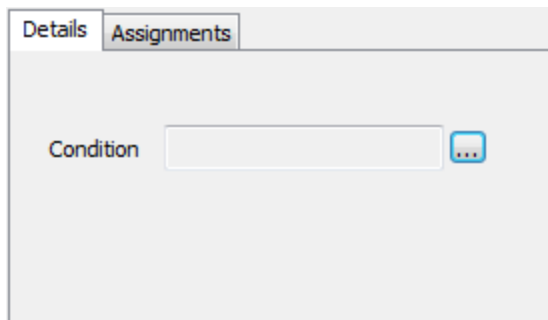

7. To the right of the **Condition** field, click on the [ ... ] button and select a Condition element from the list of Condition elements created in the [Supporting Elements package](#)<sup>[959]</sup>.
8. Go to step 10.

If you select **Multiple**:

6. The **Details** tab changes, as below.

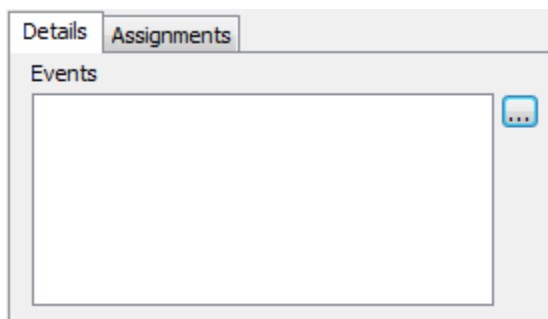

7. To the right of the **Events** field, click on the [ ... ] button and select further Start Events from the list of events in this process that might trigger the process.
8. Go to step 10.

**Resume the procedure:**

10. Click on the **Assignments** tab.



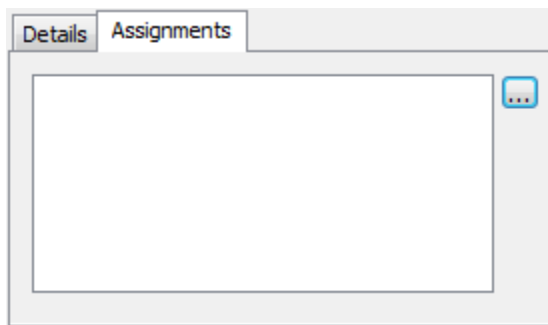

11. (Optional) To the right of the field, click on the [ ... ] button and select one or more Assignment elements from the list of [Assignments created](#)<sup>[98†]</sup> in the [Supporting Elements package](#)<sup>[959†]</sup>.

**Note:**

Click on the **UML** button if you need to define further properties of the Start Event, using the normal element [Properties](#)<sup>[48†]</sup> dialog.

Alternatively, right-click on the element and select the **Properties** context menu option.

12. Click on the **OK** button to close the dialog.

To return to the BPEL **Properties** dialog for subsequent editing:

- Double-click on the element in the diagram or **Project Browser** (the [Shows Properties](#)<sup>[35†]</sup> option must be selected in the **Double click on browser** panel of the **Options** dialog) or
- Right-click on the element in the diagram or **Project Browser** and select the **BPEL | BPEL Properties** context menu option.

### 5.2.5.2.2 Model End Event

An *End Event* indicates, where a particular Process ends. A Process can start in many ways, depending on the Trigger Type, but every Process in Enterprise Architect must terminate with an End Event.

The *OMG BPMN 1.1 Specification* defines eight types of End Event (or Result), which determine the consequence of reaching the End Event. These are:

- None
- Message
- Error
- Cancel
- Compensation
- Signal
- Terminate
- Multiple

In Enterprise Architect, five of these Result types can be mapped to BPEL, as per the *OMG BPMN 1.1 Specification*:

- Message
- Error
- Compensation
- Terminate
- Multiple

To create a new End Event in your model, follow the steps below:

1. Open a BPEL diagram [created under a BPEL Process](#)<sup>[96†]</sup>.
2. Drag the *End Event* element from the **BPMN 1.1 Core** page of the **Toolbox** onto the diagram. A prompt displays to select either an *edge-mounted* event (on an element border) or a *standalone* event.
3. Click on either option. The BPEL **Properties** dialog displays.

4. In the **Name** field, type a name for the Event.
5. Click on the drop-down arrow in the **Result Type** field and select the required type. Depending on the result type you select, further details might be required.

If you select **Message**:

6. The **Details** tab changes, as below.

7. To the right of the **Web Service** field, click on the [ ... ] button and select a [BPEL web service](#)<sup>[983]</sup> from the list.
8. To the right of the **Message** field, click on the [ ... ] button and select a message from the list of all messages in the selected web service.
9. Go to step 10.

If you select **Error**:

6. The **Details** tab changes, as below.

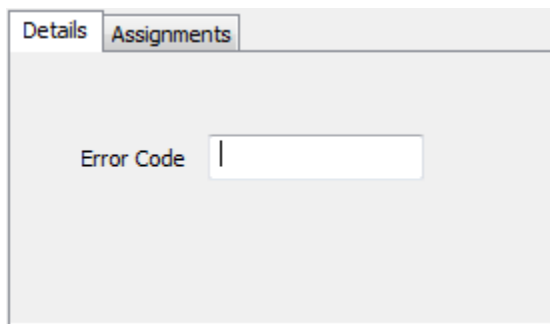

The screenshot shows a window with two tabs: 'Details' and 'Assignments'. The 'Details' tab is active. Inside the window, there is a label 'Error Code' followed by an empty text input field.

7. In the **Error Code** field, type the required error code.

8. Go to step 10.

If you select **Compensation**:

6. The **Details** tab changes, as below.

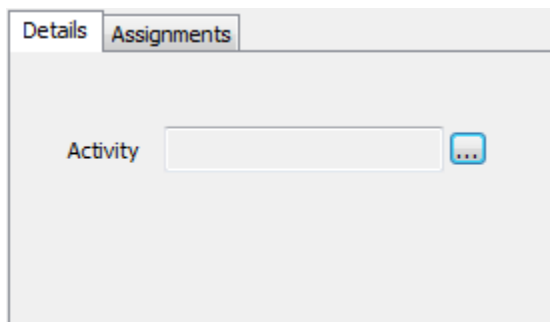

The screenshot shows a window with two tabs: 'Details' and 'Assignments'. The 'Details' tab is active. Inside the window, there is a label 'Activity' followed by an empty text input field and a small blue button with three dots (a dropdown menu icon).

7. To the right of the **Activity** field, click on the [ ... ] button and select an Activity from the list of all Activities in the process.

8. Go to step 10.

If you select **Terminate**:

6. No action is required on the **Details** tab. Go to step 10.

If you select **Multiple**:

6. The **Details** tab changes, as below.

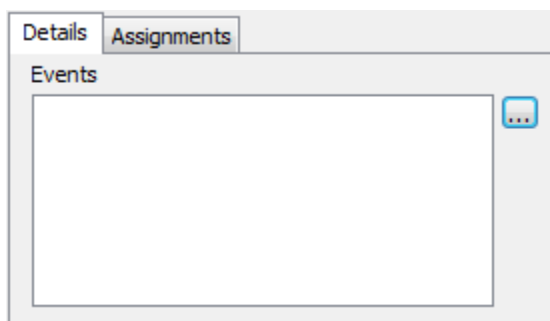

The screenshot shows a window with two tabs: 'Details' and 'Assignments'. The 'Details' tab is active. Inside the window, there is a label 'Events' followed by an empty rectangular area and a small blue button with three dots (a dropdown menu icon).

7. To the right of the **Events** field, click on the [ ... ] button and select further events from the list of events in this process that might terminate the process.

8. Go to step 10.

**Resume the procedure:**

10. Click on the **Assignments** tab.

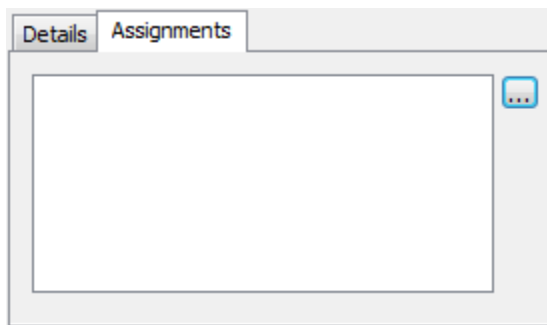

11. (Optional) To the right of the field, click on the [ ... ] button and select one or more Assignment elements from the list of [Assignments created](#) in the [Supporting Elements package](#).

**Note:**

Click on the **UML** button if you need to define further properties of the End Event, using the normal element [Properties](#) dialog.

Alternatively, right-click on the element and select the **Properties** context menu option.

12. Click on the **OK** button to close the dialog.

To return to the BPEL **Properties** dialog for subsequent editing:

- Double-click on the element in the diagram or **Project Browser** (the [Shows Properties](#) option must be selected in the **Double click on browser** panel of the **Options** dialog) or
- Right-click on the element in the diagram or **Project Browser** and select the **BPEL | BPEL Properties** context menu option.

### 5.2.5.2.3 Model Intermediate Event

An *Intermediate Event* indicates where an event occurs somewhere between the start and end of a process.

The *OMG BPMN 1.1 Specification* defines ten types of Intermediate Event (or Trigger). These are:

- None
- Message
- Timer
- Error
- Cancel
- Compensation
- Conditional
- Link
- Signal
- Multiple

In Enterprise Architect, six of these Trigger types can be mapped to BPEL.

- Message
- Timer
- Error
- Compensation
- Conditional
- Link (but not if the Intermediate Event is edge-mounted on an Activity).

To create a new Intermediate Event in your model, follow the steps below:

1. Open a BPEL diagram [created under a BPEL Process](#).
2. Drag the *Intermediate Event* element from the **BPMN 1.1 Core** page of the **Toolbox** onto the diagram. A prompt displays to select either an *edge-mounted* event (on an element border) or a *standalone* event.

**Note:**

When an Intermediate Event is created as a standalone event, it must have one incoming and one outgoing SequenceFlow (except for a [Link](#)<sup>[97]</sup> Intermediate Event, which can have either incoming or outgoing SequenceFlows, but not both).

- Click on either option. The BPEL **Properties** dialog displays.

- In the **Name** field, type a name for the Event.
- Click on the drop-down arrow in the **Trigger Type** field and select the required type.

Depending on the trigger type you select, further details might be required.

If you select **Message**:

- To the right of the **Web Service** field, click on the [ ... ] button and select a [BPEL web service](#)<sup>[98]</sup> from the list.
- To the right of the **Message** field, click on the [ ... ] button and select a message from the list of all messages in the selected web service.
- Go to step 11.

If you select **Error**:

- The **Details** tab changes, as below.

- In the **Error Code** field, type the required error code.
- Go to step 11.

If you select **Compensation**:

- The **Details** tab changes, as below.

- To the right of the **Activity** field, click on the [ ... ] button and select an Activity from the list of all Activities in the process.

**Note:**

If the Compensation Intermediate Event is edge-mounted on an Activity, create a BPMN 1.1 Association connector from this Intermediate Event Activity to a Compensation Activity. Ensure that the *IsCompensation* tag for the Activity is set to **true**.

- Go to step 11.
- If you select **Timer**:

- The **Details** tab changes, as below:

- In the **Time Cycle** field, type the value of the time cycle.
- The **Time Date** field defaults to today's date. If it is necessary to change the date, click on the checkbox and the drop-down arrow and select a new date from the calendar.

**Note:**

The **Time Cycle** and **Time Date** fields are mutually exclusive, so you can only set one of them.

- Go to step 11.
- If you select **Conditional**:

- The **Details** tab changes, as below.

7. To the right of the **Condition** field, click on the [ ... ] button and select an element from the list of Condition elements created in the [Supporting Elements package](#)<sup>[959]</sup>.
8. Go to step 11.

If you select **Link**:

6. The **Details** tab changes, as below.

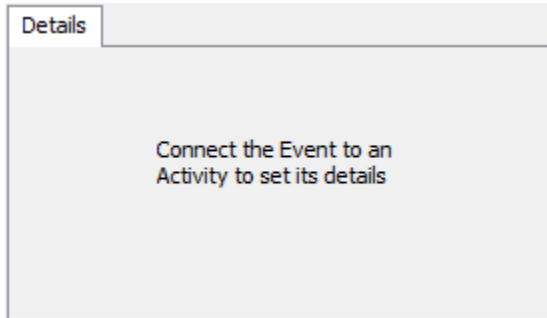

**Note:**

A Link Intermediate Event can be used as either a *GoTo* or an *Off-page* connector. Therefore this Event can have either incoming or outgoing Sequence Flows, but not both.

7. Close the dialog, and drag a Sequence Flow connector from the **Toolbox** to create a connector either from or to the appropriate Activity element.
8. If you have created an outgoing Sequence Flow *from* the Event *to* an Activity, no further details are required.
9. If you have created an incoming Sequence Flow *to* the Event *from* an Activity, right-click on the Event and select the **BPEL | BPEL Properties** context menu option. The BPEL dialog redisplay as shown below:

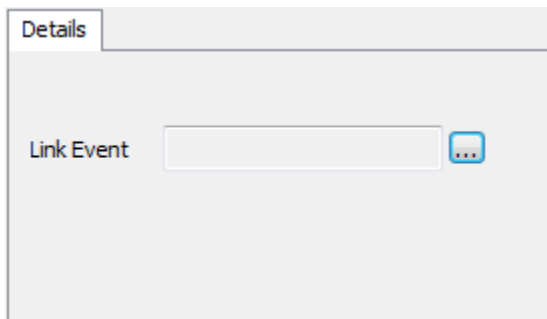

10. To the right of the **Link Event** field, click on the [ ... ] button and select the target Link Intermediate Event from the list.

**Resume the procedure:**

**Note:**

Click on the **UML** button if you have to define further properties of the Intermediate Event, using the normal element [Properties](#)<sup>[487]</sup> dialog.

Alternatively, right-click on the element and select the **Properties** context menu option.

11. Click on the **OK** button to close the dialog.

To return to the BPEL **Properties** dialog for subsequent editing:

- Double-click on the element in the diagram or **Project Browser** (the [Shows Properties](#)<sup>[357]</sup> option must be selected in the **Double click on browser** panel of the **Options** dialog) or

- Right-click on the element in the diagram or **Project Browser** and select the **BPEL | BPEL Properties** context menu option.

#### 5.2.5.2.4 Model Gateway

Gateways control the way in which [Sequence Flows](#)<sup>[980]</sup> converge and diverge within a Process. They provide a gating mechanism that either allows or blocks a Sequence Flow.

The *OMG BPMN 1.1 Specification* describes four types of Gateways:

- Exclusive (XOR)
- Inclusive (OR)
- Complex
- Parallel (AND)

In Enterprise Architect, three of these Gateway types can be mapped to BPEL, as per the *OMG BPMN 1.1 Specification*:

- Exclusive (XOR)
- Inclusive (OR)
- Parallel (AND)

### Exclusive Gateway

An Exclusive Gateway represents a 'fork in the road'; that is, there can be two or more alternative paths but only one can be taken. Therefore, each path is mutually exclusive (XOR). Exclusive Gateways can be one of two types:

- Data-Based
- Event-Based

#### Data-Based Exclusive Gateway

This is the commonest type of Exclusive Gateway, where the boolean expression set in the *ConditionExpression* Tagged Value of the outgoing Sequence Flow is evaluated to determine the flow path. In Enterprise Architect:

- One of the outgoing Sequence Flows from the Gateway must have the *ConditionType* tag set to **Default** and the *ConditionExpression* tag set to empty
- All other Sequence Flows must have the *ConditionType* tag set to *Expression* and the *ConditionExpression* tag set to a boolean expression.

The *Default* condition on an outgoing Sequence Flow ensures that at least this path is taken if all others evaluate to **false**.

#### Event-Based Exclusive Gateway

On this Gateway, the branching is based on the events (such as receiving a message) that occur at that point in the Process, rather than the evaluation of an expression. As an example (from the *OMG BPMN 1.1 Specification*), when a company receives a response from a customer, they perform one set of activities if the customer responds *Yes* and another set of activities if the customer responds *No*. The customer's response determines which path is taken. This Gateway maps to a BPEL *Pick* element. When modeling this Gateway:

- The outgoing Sequence Flow must have its *ConditionType* tag set to **None**
- The target of the outgoing Sequence Flow must be either an:
  - Activity with *TaskType* tag set to **Receive**, or
  - Intermediate Event with Trigger set to **Message** or **Timer**.

#### Note:

If an Activity is the target of one outgoing Sequence Flow, then the Intermediate Event with a **Message** trigger must not be used.

### Inclusive Gateway (OR)

With this type of Gateway, all the outgoing Sequence Flows with a condition that evaluates to **true** are taken. In Enterprise Architect:

- One of the outgoing Sequence Flows from the Gateway must have the *ConditionType* tag set to **default** and the *ConditionExpression* tag set to empty



- All other Sequence Flows must have the *ConditionType* tag set to *Expression* and the *ConditionExpression* tag set to a boolean expression.

The *Default* condition on an outgoing Sequence Flow ensures that at least this path is taken if all others evaluate to **false**.

## Parallel Gateway (AND)

This Gateway provides a mechanism to create parallel flows. In Enterprise Architect, the *ConditionType* tag on all the outgoing Sequence Flows from this Gateway must be set to **None**.

## Create Gateway

To create a new Gateway element in your model, follow the steps below.

1. Open a BPEL diagram [created under a BPEL Process](#)<sup>[96]</sup>.
2. Drag the *Gateway* element from the [BPMN 1.1 Core](#) page of the [Toolbox](#) onto the diagram. The [BPEL Properties](#) dialog displays.

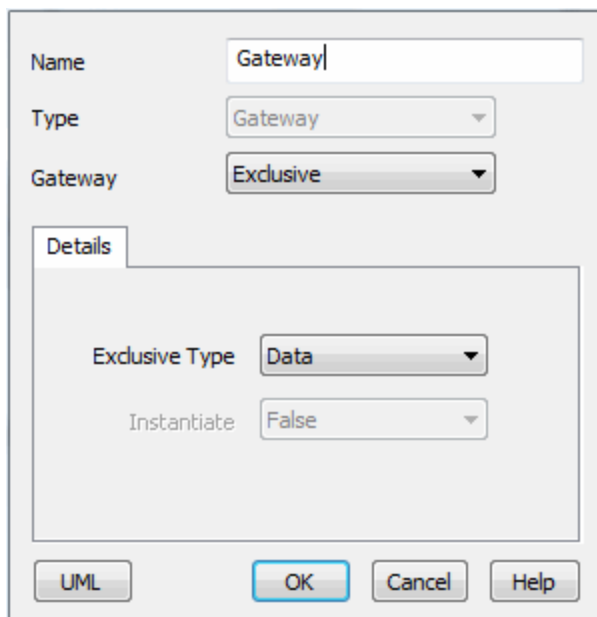

3. In the **Name** field, type a name for the Gateway.
4. Click on the drop-down arrow in the **Gateway** field and select the required type.
5. If you have selected **Inclusive** or **Parallel**, no further details are required.
6. If you have selected **Exclusive**, in the **Exclusive Type** field click on the drop-down arrow and select the sub-type - **Data** or **Event**.
7. If you have selected the sub-type **Event**, in the **Instantiate** field click on the drop-down arrow and select either **True** or **False**.

### Note:

Click on the **UML** button if you need to define further properties of the Gateway, using the normal element [Properties](#)<sup>[48]</sup> dialog.

Alternatively, right-click on the element and select the **Properties** context menu option.

8. Click on the **OK** button to close the dialog.

To return to the [BPEL Properties](#) dialog for subsequent editing:

- Double-click on the element in the diagram or [Project Browser](#) (the [Shows Properties](#)<sup>[35]</sup> option must be selected in the [Double click on browser](#) panel of the [Options](#) dialog) or
- Right-click on the element in the diagram or [Project Browser](#) and select the **BPEL | BPEL Properties** context menu option.

### 5.2.5.2.5 Model Activity

An *Activity* represents work that is performed within a *Process*. An *Activity* can be modeled as a:

- *Sub-Process* - a compound *Activity* that is defined as a flow of other BPMN elements or
- [Task](#)<sup>[975]</sup> - an atomic *Activity* that cannot be broken down into a smaller unit.

*Activities* - both *Tasks* and *Sub-Processes* - can also act as *Looping constructs*. The *OMG BPMN 1.1 Specification* defines two types of *Looping construct*:

- *Standard Loops* (*while* or *until*)
- *Multi-Instance Loops* (*for each*).

A *Standard Loop* has a boolean *Condition* that is evaluated after each cycle of the loop. If the evaluation is **True**, then the loop continues. If *Test Time* is set to **After**, the loop is equivalent to a *while* loop. If *Test Time* is set to **Before**, the loop is equivalent to an *until* loop.

A *Multi-Instance Loop* is equivalent to a *for each* loop and has a numeric expression as a *Condition* that is evaluated only once before the *Activity* is performed. The result of the evaluation specifies the number of times the loop is repeated.

### Sub-Process

The BPMN Specification defines three types of *Sub-Process*:

- Embedded
- References
- Reusable.

In *Enterprise Architect*, two of these *Sub-Process* types can be mapped to *BPEL*:

- Embedded
- References.

To create a new *Sub-Process Activity* in your model, follow the steps below.

1. Open a *BPEL* diagram [created under a BPEL Process](#)<sup>[967]</sup>.
2. Drag the *Activity* element from the **BPMN 1.1 Core** page of the **Toolbox** onto the diagram. The **BPEL Properties** dialog displays.

3. In the **Name** field, type a name for the *Activity*.
4. In the **Type** field click on the drop-down arrow and select the **Sub-Process** option.
5. In the **Task Type** field click on the drop-down arrow and select the *Sub Process* type - **Embedded** or **References**.

6. If you select **Embedded**, you do not have to set any other properties.
7. If you select **References**, the **Details** tab displays as follows:

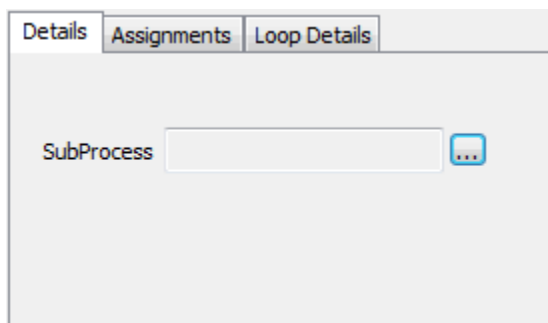

8. To the right of the **SubProcess** field, click on the [ ... ] button and select a Sub-Process from the list of all Sub-Processes in the BPEL process.

**Note:**

Click on the **UML** button if you need to define further properties of the Activity, using the normal element [Properties](#) dialog.

Alternatively, right-click on the element and select the **Properties** context menu option.

9. Click on the **OK** button to close the dialog.

To return to the BPEL **Properties** dialog for subsequent editing:

- Double-click on the element in the diagram or **Project Browser** (the [Shows Properties](#) option must be selected in the **Double click on browser** panel of the **Options** dialog) or
- Right-click on the element in the diagram or **Project Browser** and select the **BPEL | BPEL Properties** context menu option.

## Task

The *OMG BPMN 1.1 Specification* defines eight types of Task:

- Service
- User
- Receive
- Send
- Script
- Manual
- Reference
- None.

In Enterprise Architect, six of these Task types can be mapped to BPEL, as per the *OMG BPMN 1.1 Specification*:

- Service
- User
- Receive
- Send
- Reference
- None.

To create a new Task Activity in your model, follow the steps below.

1. Open a BPEL diagram [generated under a BPEL Process](#).
2. Drag the *Activity* element from the **BPMN 1.1 Core** page of the **Toolbox** onto the diagram. The **BPEL Properties** dialog displays.

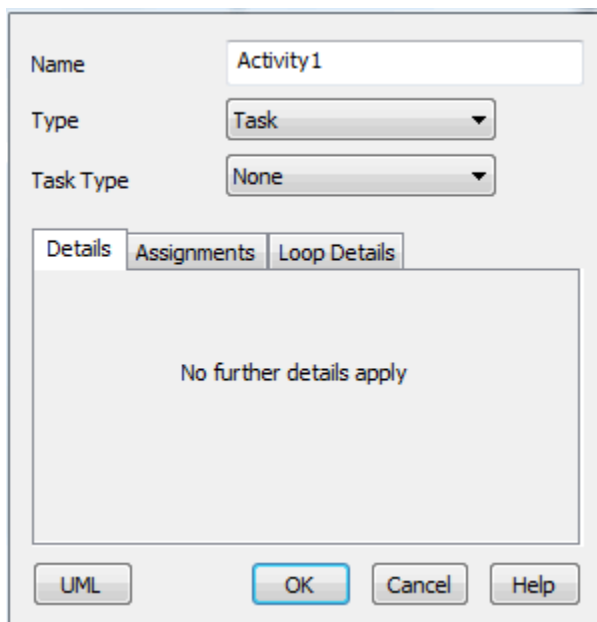

The screenshot shows a dialog box for creating a UML Activity. It has three input fields: 'Name' with the text 'Activity1', 'Type' with a dropdown menu showing 'Task', and 'Task Type' with a dropdown menu showing 'None'. Below these fields are three tabs: 'Details', 'Assignments', and 'Loop Details'. The 'Details' tab is active, and its content area displays the text 'No further details apply'. At the bottom of the dialog are four buttons: 'UML', 'OK', 'Cancel', and 'Help'.

3. In the **Name** field, type a name for the Activity.
  4. In the **Type** field click on the drop-down arrow and select the **Task** option.
  5. In the **Task Type** field click on the drop-down arrow and select the Task type.
- Depending on the Task type you select, further details might be required.

If you select **None**:

6. No further details are required. Go to step 11

If you select **Reference**:

6. The **Details** tab changes, as below.

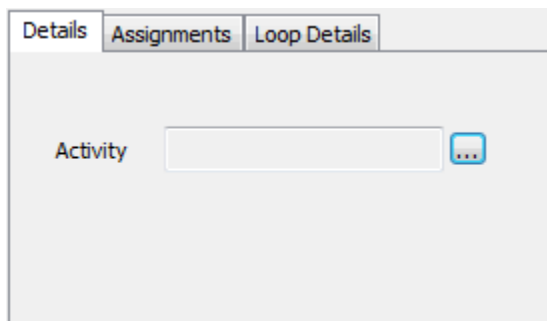

The screenshot shows the 'Details' tab of the UML Activity dialog box. The 'Activity' field is empty, and a button with three dots is visible to its right. The 'Assignments' and 'Loop Details' tabs are also visible but not selected.

7. To the right of the **Activity** field, click on the [ ... ] button and select an Activity from the list of all Tasks in the process.
  8. Go to step 11.
- If you select **Send**:
6. The **Details** tab changes, as below.

Details Assignments Loop Details

Implementation Web Service

Web Service [ ... ]

Message [ ... ]

7. To the right of the **Web Service** field, click on the [ ... ] button and select a [BPEL web service](#)<sup>[983]</sup> from the list.
  8. To the right of the **Message** field, click on the [ ... ] button and select a message from the list of all messages in the selected web service.
  9. Go to step 11.
- If you select **Receive**:

6. The **Details** tab changes, as below.

Details Assignments Loop Details

Implementation Web Service

Web Service [ ... ]

Message [ ... ]

Instantiate False

7. To the right of the **Web Service** field, click on the [ ... ] button and select a [BPEL web service](#)<sup>[983]</sup> from the list.
  8. To the right of the **Message** field, click on the [ ... ] button and select a message from the list of all messages in the selected web service.
  9. In the **Instantiate** field click on the drop-down arrow and select **True** if this is the first Activity after the [Start Event](#)<sup>[962]</sup>, otherwise select **False**.
  10. Go to step 11.
- If you select **Service** or **User**:

6. The **Details** tab changes, as below.

Details Assignments Loop Details

Implementation Web Service

Web Service [ ... ]

Input Message [ ... ]

Output Message [ ... ]

7. To the right of the **Web Service** field, click on the [ ... ] button and select a [BPEL web service](#)<sup>[983]</sup> from the list.
8. To the right of the **Input Message** field, click on the [ ... ] button and select a message from the list of all messages in the selected web service.

9. To the right of the **Output Message** field, click on the [ ... ] button and select a message from the list of all messages in the selected web service.
10. Go to step 11.

**Resume the procedure:**

11. (Optional) Click on the **Assignments** tab.

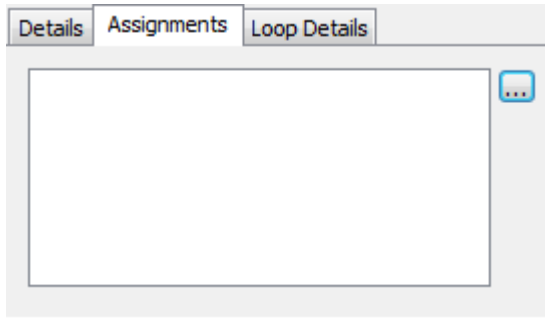

12. To the right of the field, click on the [ ... ] button and select one or more Assignment elements from the list of [Assignments created](#)<sup>[987]</sup> in the [Supporting Elements package](#)<sup>[959]</sup>.
13. (Optional) Click on the **Loop Details** tab.

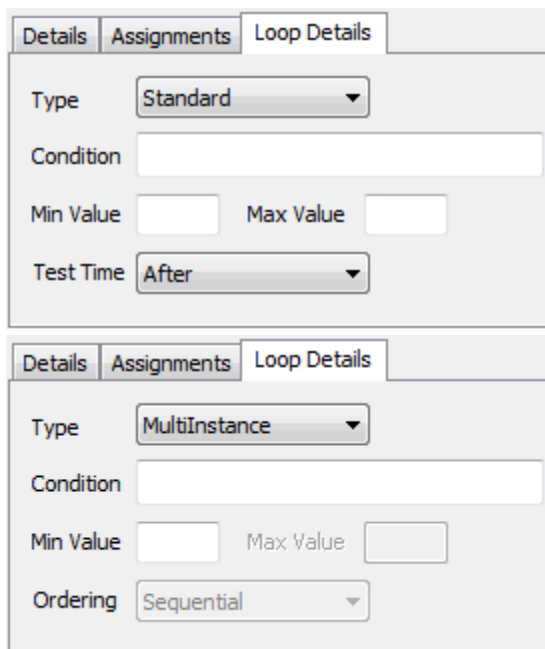

14. In the **Type** field click on the drop-down arrow and select the loop type - **Standard** or **MultiInstance** (the field defaults to **None**).
15. In the **Condition** field, type the condition to be evaluated (boolean for a Standard loop, numeric expression for a MultiInstance loop).
16. In the **Min Value** field, type the minimum value for the evaluation.
17. (Standard loop) In the **Max Value** field type the maximum value for the evaluation.
18. (Standard loop) In the **Test Time** field click on the drop-down arrow and select **After** to define a *while* loop or **Before** to define an *until* loop.

**Note:**

Click on the **UML** button if you need to define further properties of the Activity, using the normal element [Properties](#) dialog.

Alternatively, right-click on the element and select the **Properties** context menu option.

19. Click on the **OK** button to close the dialog.

To return to the BPEL **Properties** dialog for subsequent editing:

- Double-click on the element in the diagram or **Project Browser** (the [Shows Properties](#) option must be selected in the **Double click on browser** panel of the **Options** dialog) or
- Right-click on the element in the diagram or **Project Browser** and select the **BPEL | BPEL Properties** context menu option.

### 5.2.5.2.6 Model Pool

A Pool represents a [Participant](#) in a Process and does not map to any specific BPEL element. Enterprise Architect uses Pools to represent external Participants, with which the BPEL Process communicates. These are 'black box' pools; that is, they are abstract and do not expose any details (they do not contain any BPMN elements inside them).

To create a new Pool in your model, follow the steps below.

1. Open a BPEL diagram [created under a BPEL Process](#).
2. Drag the *Pool* element from the **BPMN 1.1 Core** page of the **Toolbox** onto the diagram. The BPEL **Properties** dialog displays.

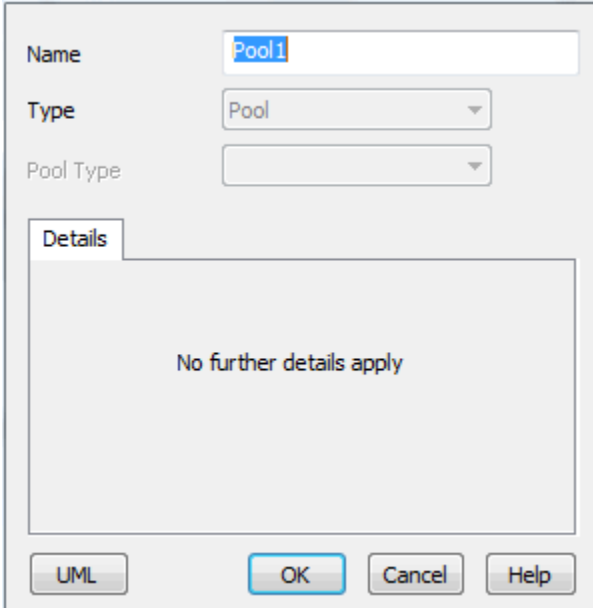

3. In the **Name** field, type a name for the Pool element.

**Note:**

Click on the **UML** button if you need to define further properties of the Activity, using the normal element [Properties](#) dialog.

Alternatively, right-click on the element and select the **Properties** context menu option.

4. Click on the **OK** button to close the dialog.

To return to the BPEL **Properties** dialog for subsequent editing:

- Double-click on the element in the diagram or **Project Browser** (the [Shows Properties](#) option must be

- selected in the **Double click on browser** panel of the **Options** dialog) or
- Right-click on the element in the diagram or **Project Browser** and select the **BPEL | BPEL Properties** context menu option.

### 5.2.5.3 Model a Sequence Flow Connector

A Sequence Flow connector shows the order in which the activities (Tasks and Events) are performed in a BPEL Process.

#### Create Sequence Flow

To create a new Sequence Flow connector in your model, follow the steps below.

1. Open a BPEL diagram [created under a BPEL Process](#)<sup>[96†]</sup>.
2. Click on the Sequence Flow connector from the **BPMN 1.1 Relationships** page of the **Toolbox**, then click on the start element and drag across to the target element on the diagram. Double-click on the connector to display the **Properties** dialog.

If the Sequence Flow connector has a *non*-Gateway element as the start element, the **Properties** dialog displays as shown below:

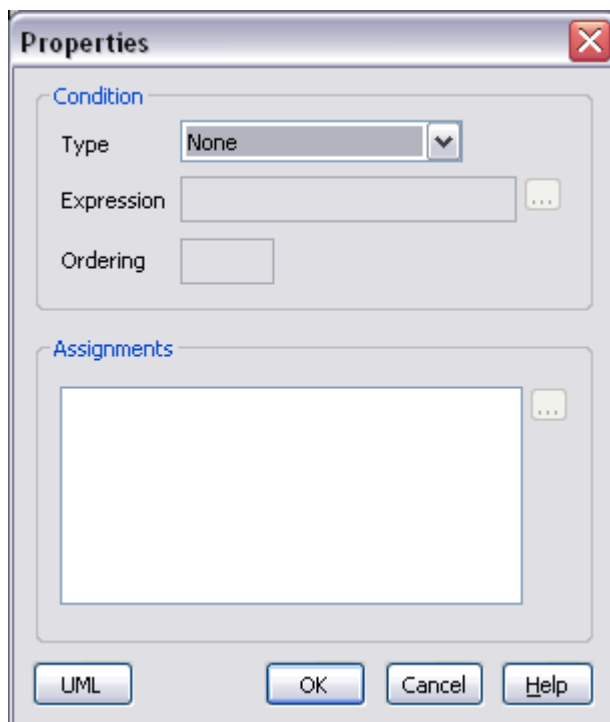

You cannot change anything on this dialog; go to step 5.

If the Sequence Flow connector has a [Gateway](#)<sup>[972†]</sup> as the start element, the **Properties** dialog initially displays as above but with the **Assignments** field enabled. An [Activity](#)<sup>[974†]</sup> behaves as a Gateway if it is the source for more than one Sequence Flow.

3. In the **Condition** group-box, in the **Type** field, either leave the value as **None** for the condition on the connector, or click on the drop-down arrow and select **Default** (the ELSE in an IF...THEN...ELSE statement) or **Expression**.



**Note:**

If you select **Expression**: all fields are enabled and:

- You must type or browse for ([ ... ]) an expression value in the **Expression** field.
- (Optional) In the **Ordering** field, type a numerical value; for an Exclusive or Inclusive Gateway, the order of outgoing flows is based on the value of this field.

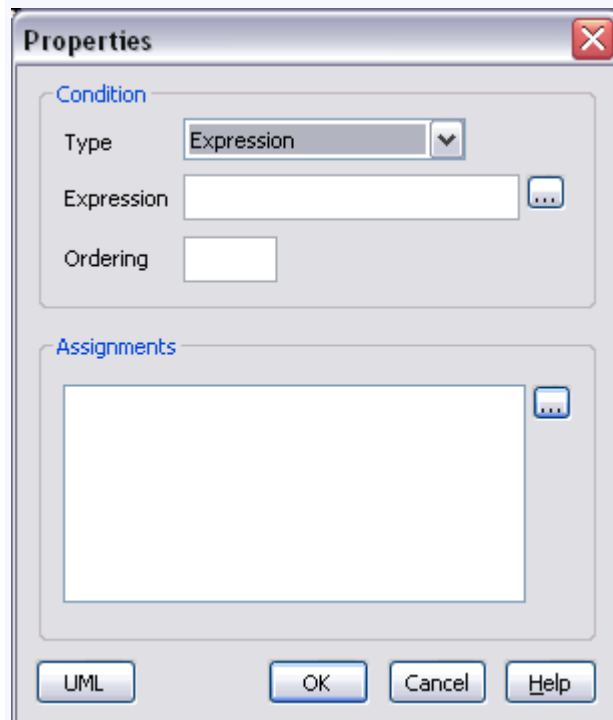

4. (Optional) In the **Assignments** panel, click on the [ ... ] button and select one or more Assignment elements from the list of [Assignments created](#)<sup>[987]</sup> in the [Supporting Elements package](#)<sup>[959]</sup>.

**Note:**

Click on the **UML** button if you need to define further properties of the connector, using the normal Control Flow connector [Properties](#)<sup>[860]</sup> dialog.

Alternatively, right-click on the connector and select the **ControlFlow Properties** context menu option.

5. Click on the **OK** button to close the dialog.

To return to the BPEL **Properties** dialog for subsequent editing:

- Double-click on the connector in the diagram or
- Right-click on the connector in the diagram and select the **BPEL | BPEL Properties** context menu option.

#### 5.2.5.4 Create Assignments

A BPMN *Assignment* element enables data to be copied between messages, and new data to be inserted, using expressions within a BPEL Process. A BPMN Assignment element maps to a BPEL *assign* activity and copies the specified value from the source to the target.

In Enterprise Architect, Assignment elements should be created in the *Assignments* package in [SupportingElements](#)<sup>[959]</sup>. If they are created elsewhere, they cannot be enacted correctly.

To create a new Assignment in your model, follow the steps below:

1. Navigate to and open (or create, if necessary) the BPEL diagram under the *Assignments* package.
2. Open the **BPMN 1.1 Types** page of the **Toolbox (More tools | BPMN 1.1)**.
3. Drag an *Assignment* element from the **Toolbox** onto the diagram. The BPEL **Properties** dialog displays.

The screenshot shows a dialog box for configuring an assignment. The 'Name' field is 'Assignment1'. The 'Assign Time' dropdown is 'Start'. The 'Copy From' section has 'Type' set to 'Literal', with the 'Literal' text field active and empty. 'Message' and 'Part' fields are disabled. The 'Copy To' section has 'Message' and 'Part' fields disabled. At the bottom are buttons for 'UML', 'OK', 'Cancel', and 'Help'.

4. In the **Name** field, type a name for the Assignment.
5. In the **Assign Time** field, click on the drop-down arrow and select either **Start** or **End**. This determines whether the assignment occurs at the start or end of an Activity.

In the **Copy From** panel:

6. In the **Type** field, click on the drop-down arrow and select either **Literal**, **Expression** or **Message**.
7. If you select **Literal**, the **Literal** field is enabled and the **Message** and **Part** fields are disabled. Type a value in the **Literal** field.
8. If you select **Expression** or **Message**, the **Literal** field is disabled and the **Message** and **Part** fields are enabled.

**Note:**

If you select **Expression**, Enterprise Architect uses the `getVariableData XPath 1.0` function to create the expression from the selected **Message** and **Part**.

9. To the right of the **Message** field, click on the [ ... ] button and select a Message created under the *SupportingElements* package.

**Note:**

Messages are created when you create a [Web Service](#)<sup>[983]</sup>.

10. (Optional) To the right of the **Part** field, click on the [ ... ] button and select a Message Property.

In the **Copy To** panel:

11. To the right of the **Message** field, click on the [ ... ] button and select a Message created under the *SupportingElements* package.
12. To the right of the **Part** field, click on the [ ... ] button and select a Message Property. This field is mandatory if you have entered a value in the **Part** field in the **Copy From** panel.
13. Click on the **OK** button to close the dialog.

To return to the BPEL **Properties** dialog for subsequent editing:

- Double-click on the element in the diagram or **Project Browser** (the [Shows Properties](#)<sup>[35]</sup> option must be selected in the **Double click on browser** panel of the **Options** dialog) or
- Right-click on the element in the diagram or **Project Browser** and select the **BPEL | BPEL Properties** context menu option.

**See Also**

- [Model a BPEL Process](#)<sup>[96]</sup>
- [Generate BPEL](#)<sup>[983]</sup>
- [BPEL Model Validation](#)<sup>[984]</sup>

**5.2.5.5 Generate BPEL**

To generate BPEL, follow the steps below:

1. Right-click on the BPEL *Process* element and select the **BPEL | Generate BPEL** context menu option. The **Generate BPEL** dialog displays.

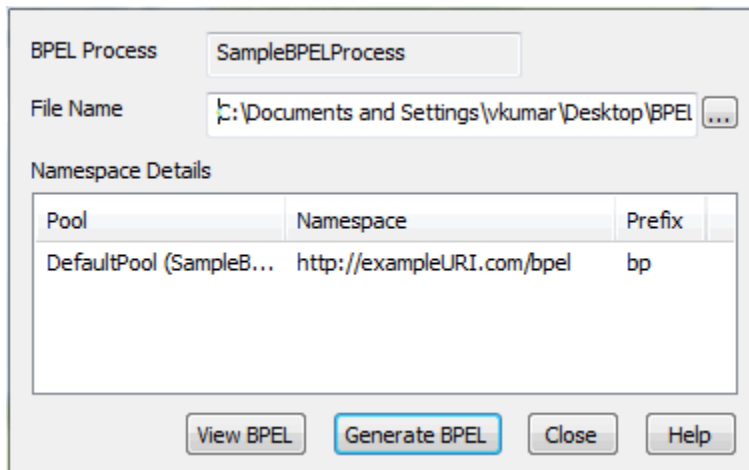

2. The **Namespace Details** panel shows all of the Pools (participants) involved in the BPEL process. Note that *DefaultPool* refers to the BPEL Process itself. Ensure that the **Namespace** and **Prefix** columns have values for all of the Pools; if not, double-click on an entry to bring up the **Namespace Details** dialog for that entry.

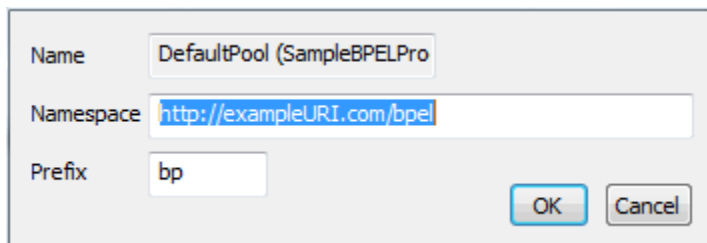

3. Complete the **Namespace** and **Prefix** fields as required.

**See Also**

- [BPEL Models](#)<sup>[958]</sup>
- [Create Assignments](#)<sup>[981]</sup>
- [Create a BPEL Model](#)<sup>[959]</sup>
- [Model a BPEL Process](#)<sup>[961]</sup>
- [Create a BPEL Web Service](#)<sup>[983]</sup>
- [BPEL Model Validation](#)<sup>[984]</sup>

**5.2.5.6 Create a BPEL Web Service**

Enterprise Architect enables you to create, for BPEL *Process* and *Pool* elements, Web Services that support either synchronous (request-response) or asynchronous (one-way) interactions.

To create a web service, follow the steps below:

1. Right-click on the BPEL *Process* or *Pool* element and select the **BPEL | Create Web Service** context menu option. The **Create Web Service** dialog displays.

2. You can create a Web Service:

- From scratch - select the **Create New** option in the **Web Service** field, or
- By importing an existing WSDL into a (for example) *SupportingElements* package and then selecting the **Create from existing WSDL** option in the **Web Service** field.

Once you enter all the required values, the Web Service is created under the *SupportingElements* package.

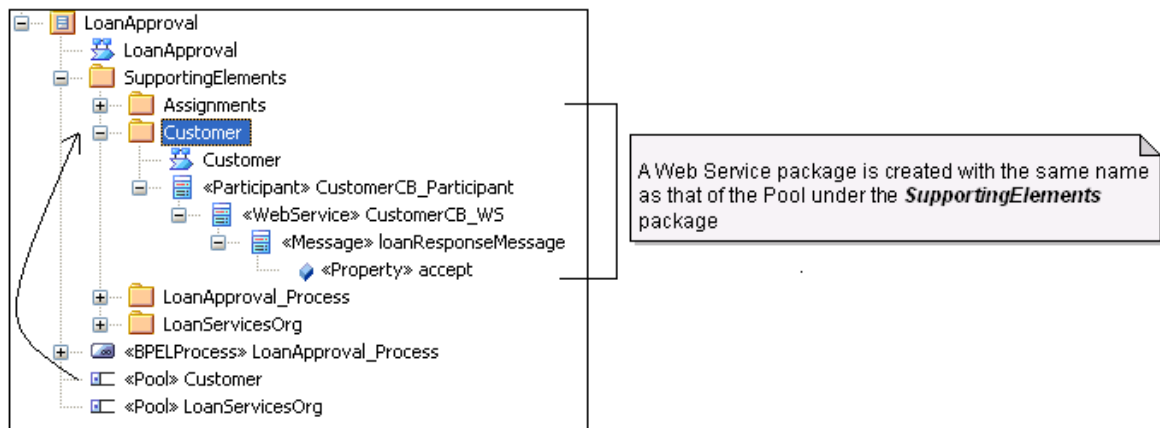

#### See Also

- [BPEL Models](#) <sup>[958]</sup>
- [Create a BPEL Model](#) <sup>[959]</sup>
- [Create Assignments](#) <sup>[981]</sup>
- [Model a BPEL Process](#) <sup>[961]</sup>
- [Generate BPEL](#) <sup>[983]</sup>
- [BPEL Model Validation](#) <sup>[984]</sup>

#### 5.2.5.7 BPEL Model Validation

You can use the Enterprise Architect [Model Validation](#) <sup>[1528]</sup> facility to check the validity of the BPEL model. You can validate an entire BPEL Process or a single BPMN element. Note that Enterprise Architect checks for both the UML and the BPEL rules by default. To enable only BPEL rule validation, select only the **BPEL Rules** checkbox in the [Model Validation Configuration](#) <sup>[1530]</sup> dialog.

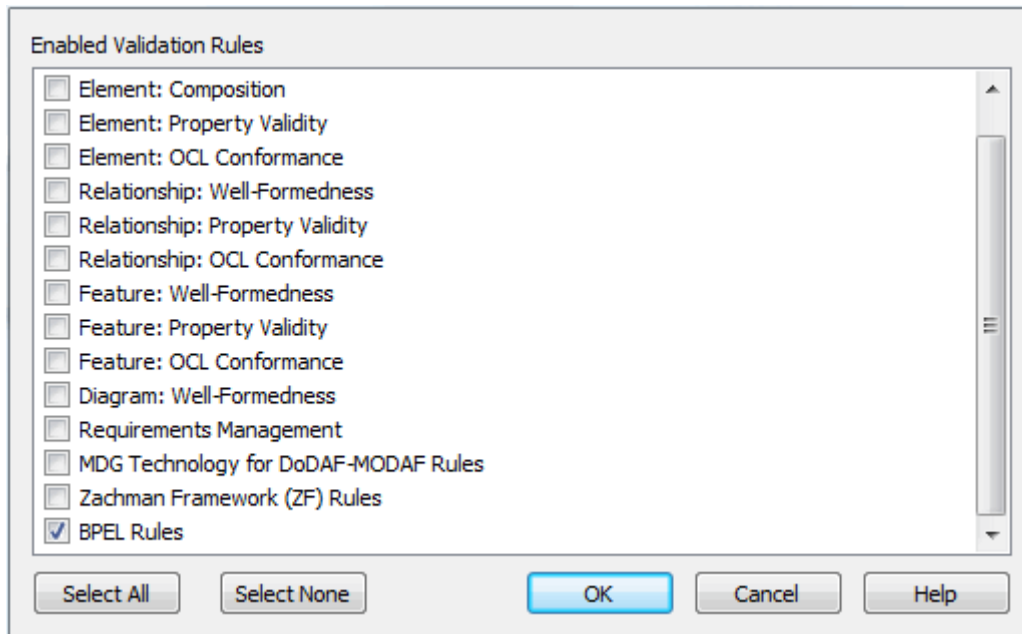

### Example Model Violation

The following model shows several basic BPEL violations:

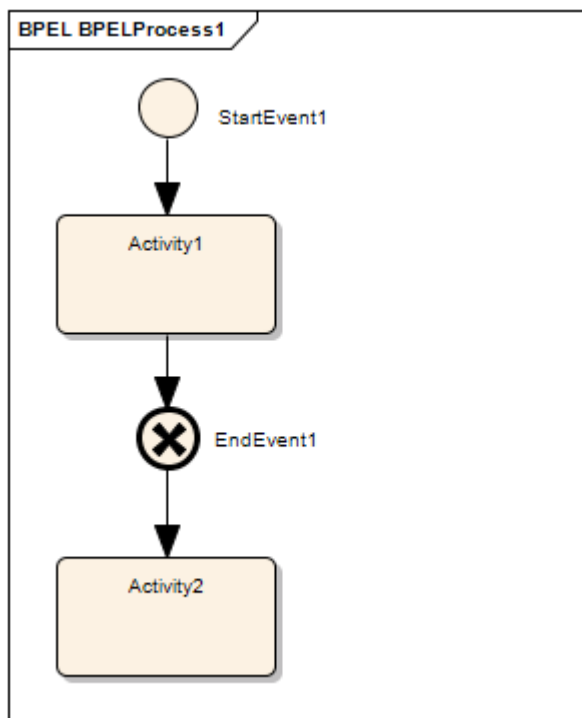

1. *StartEvent1* has its trigger set to **None**, which cannot be mapped to BPEL.
2. *EndEvent1* has its trigger set to **Cancel**, which cannot be mapped to BPEL.
3. *EndEvent1* cannot have any outgoing SequenceFlows, as it represents the end of a process.
4. *Activity2* has no outgoing SequenceFlows. Enterprise Architect expects only an EndEvent to represent the end of a process.

If you run Model Validation on this diagram, Enterprise Architect lists the violations in the **Output** window, as shown:

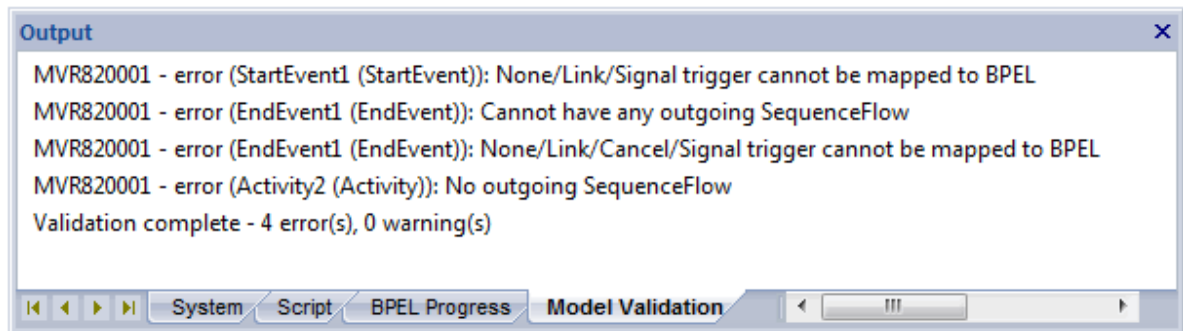

### See Also

- [BPEL Models](#) <sup>[958]</sup>
- [Create a BPEL Model](#) <sup>[959]</sup>
- [Create Assignments](#) <sup>[981]</sup>
- [Model a BPEL Process](#) <sup>[961]</sup>
- [Generate BPEL](#) <sup>[983]</sup>
- [Create a BPEL Web Service](#) <sup>[983]</sup>

## 5.2.6 Systems Engineering

### Note:

Systems Modeling Language (SysML) is available in the Systems Engineering edition and Ultimate edition of Enterprise Architect.

To model Systems using [SysML](#) <sup>[989]</sup> in Enterprise Architect, you work through the following steps:

- [Create a Systems Engineering model](#) <sup>[987]</sup> to develop your system.
- [Create a Requirements model](#) <sup>[1007]</sup> to define the systems requirements and expectations.
- [Create an Operational Domain model](#) <sup>[1007]</sup>, which describes the environment that the system operates within, and the entities it interacts with.
- [Create Constraint models](#) <sup>[1002]</sup> to describe the systems operating characteristics using parametric models.
- [Simulate the parametric models](#) <sup>[1005]</sup> to verify their correctness and obtain the desired characteristic.
- [Design the system's composition](#) <sup>[1009]</sup> using SysML Blocks and Parts.
- [Implement the embedded software](#) <sup>[1314]</sup> using UML Classes and behavioral models.
- [Create a Library of reusable SysML blocks](#) <sup>[1011]</sup>, representing subsystems that can be reused on other projects, and other common Type definitions.

These steps are represented graphically in the following flow:

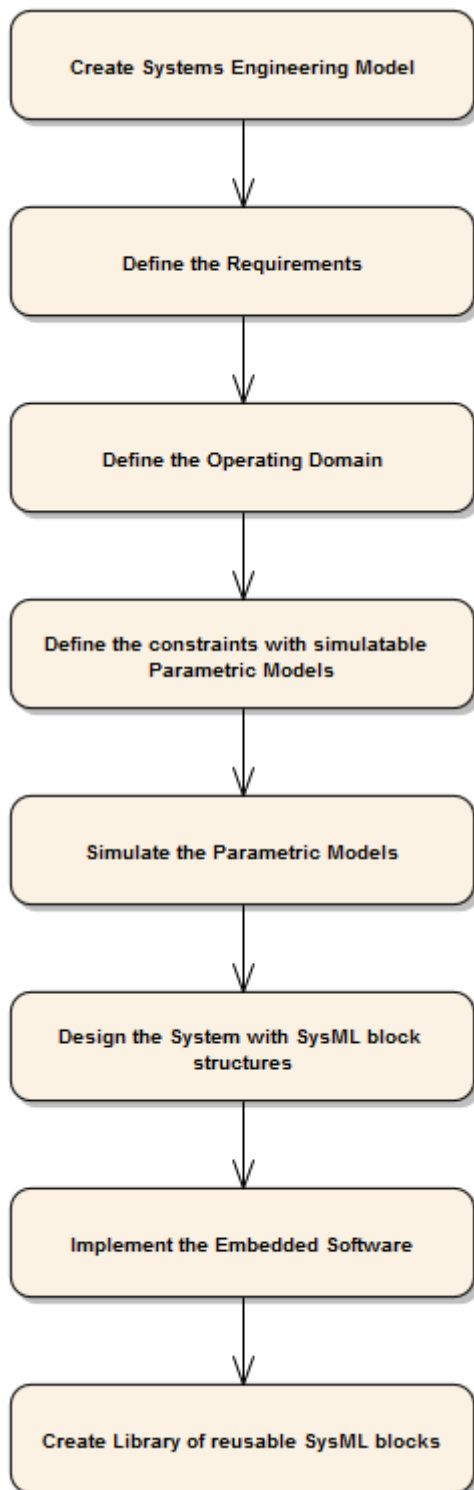

## Create a Systems Engineering Model

You can create a Systems Engineering Model from a template provided with Enterprise Architect. To do this, follow the steps below:

1. In the **Project Browser**, either:
  - Click on the **New Model From Pattern** icon in the toolbar
  - Right-click on a model root node and select the **Add a New Model using Wizard** context menu option, or

- Right-click on a package and select the **Add | Add a New Model using Wizard** context menu option.

The **Select Model(s)** dialog displays.

2. In the **Select From** field, click on the drop-down arrow and select **Systems Engineering Model**. Alternatively, if it is listed in the **Technology** panel, select the **Systems Engineering Model** item.
3. In the **Name** panel, select the checkbox next to the **Systems Engineering Model** icon.
4. Click on the **OK** button.

The following model structure is created in the **Project Browser**:

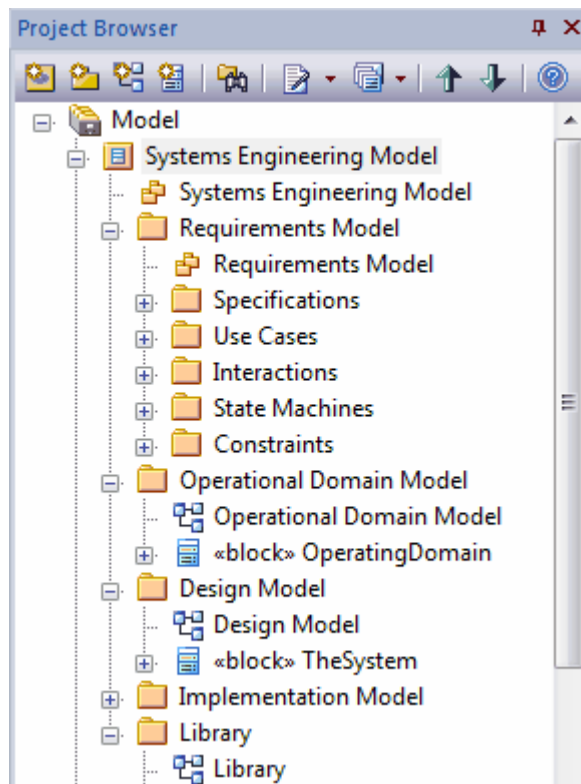

The *Systems Engineering Model* diagram, shown below, encapsulates the key components of the Systems Engineering model.



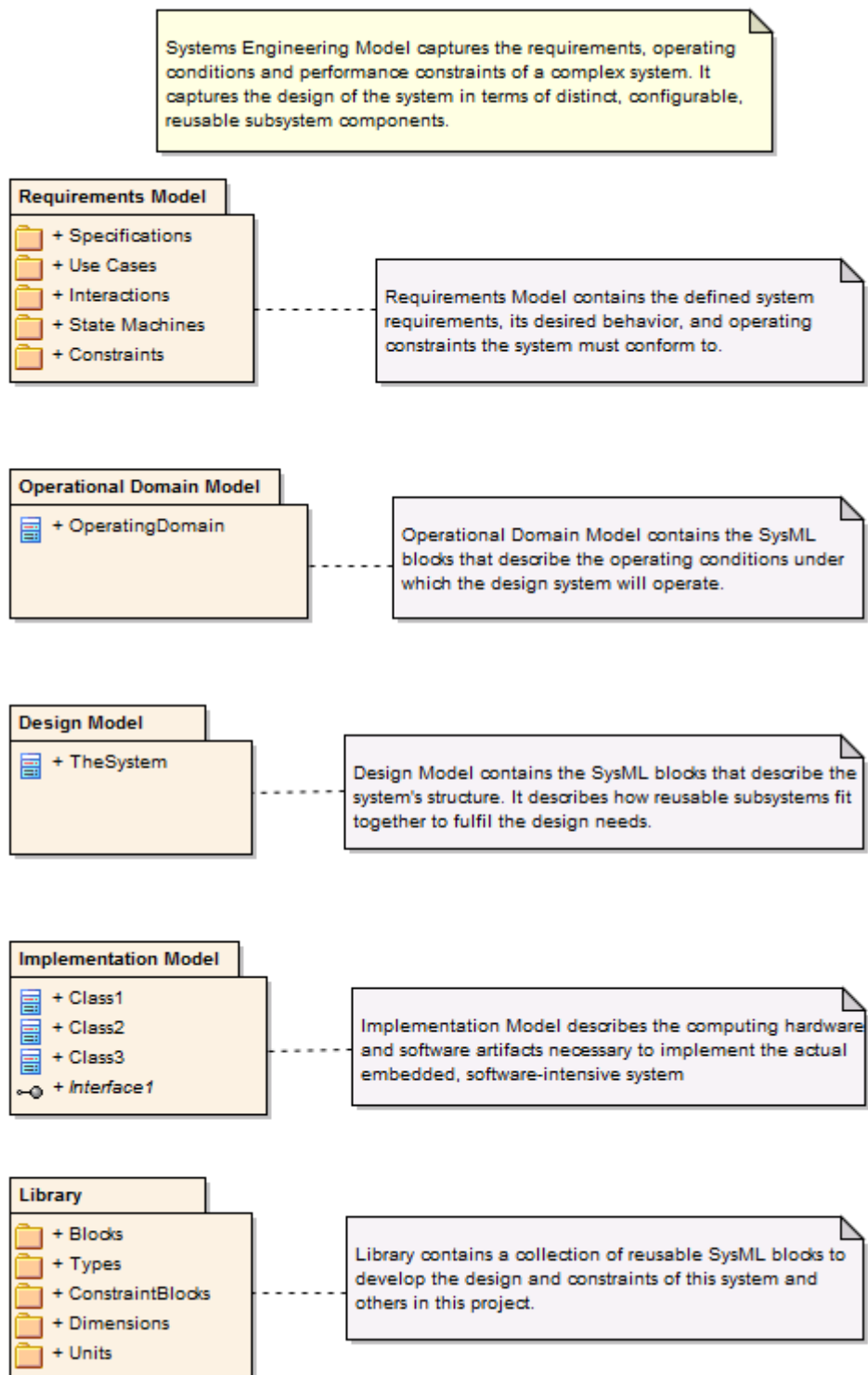

### 5.2.6.1 SysML

#### Note:

Systems Modeling Language (SysML) is supported in the Systems Engineering and Ultimate editions of Enterprise Architect.

The following text is derived from the official [OMG SysML](http://www.omg.org) site of the Object Management Group.

The OMG systems Modeling Language (OMG SysML™) is a general-purpose graphical modeling language for specifying, analyzing, designing, and verifying complex systems that may include hardware, software, information, personnel, procedures, and facilities.

The language provides graphical representations with a semantic foundation for modeling system requirements, behavior, structure, and parametrics, which is used to integrate with other engineering analysis models.

SysML was developed in response to requirements developed jointly by the OMG and the International Council on Systems Engineering (INCOSE) by the diverse group of tool vendors, end users, academia, and government representatives.

For further information on the concepts of SysML, refer to the official [OMG SysML](#) website and its linked sources.

## SysML in Enterprise Architect

Enterprise Architect enables you to develop SysML models quickly and simply, through use of an MDG Technology integrated with the Enterprise Architect installer. The SysML technology provides:

- Each of the nine SysML diagram types, accessed through the [New Diagram](#) <sup>[422]</sup> dialog
- A collection of [SysML](#) pages in the [Toolbox](#) that contain each of the supported SysML elements and relationships
- SysML element and relationship entries in the [Toolbox Shortcut](#) <sup>[403]</sup> Menu and [Quick Linker](#) <sup>[474]</sup>.
- [Simulation of SysML Parametric diagrams](#) <sup>[1005]</sup>, which supports engineering analysis of critical system parameters including the evaluation of key metrics such as performance, reliability and other physical characteristics.

### SysML Toolboxes

You can access the [SysML](#) pages of the [Toolbox](#) through the **More tools | SysML** menu option. You can also enable SysML as the active technology to access the [Toolbox](#) pages directly.

The following sets of [Toolbox](#) pages are available:

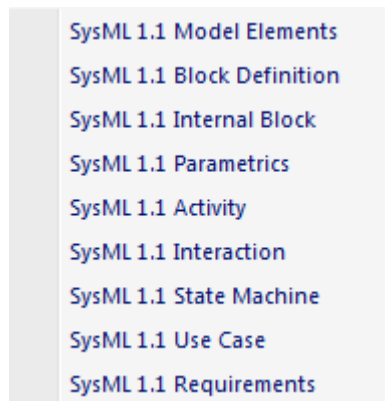

- [Model Elements](#) <sup>[991]</sup> contains the constructs needed to build SysML models, package structures and views
- [Block Definition](#) <sup>[992]</sup> contains the constructs needed to design SysML blocks, constraint blocks, data and value types
- [Internal Block](#) <sup>[994]</sup> contains the constructs needed to design SysML block compositions within Internal Block Diagrams
- [Parametrics](#) <sup>[995]</sup> contains the constructs needed to construct SysML Parametric Diagrams using constraint blocks
- [Activity](#) <sup>[996]</sup> contains the constructs needed to construct SysML Activity models
- [Interaction](#) <sup>[998]</sup> contains the constructs needed to construct SysML interactions and Sequence diagrams
- [State Machine](#) <sup>[999]</sup> contains the constructs needed to build SysML State Machines
- [Use Case](#) <sup>[1000]</sup> contains the constructs needed to build SysML Use Case models
- [Requirements](#) <sup>[1001]</sup> contains the constructs needed to build SysML Requirements models.

## Disable SysML

If you prefer not to use SysML in Enterprise Architect, you can disable it (and subsequently re-enable it) using the [MDG Technologies](#) <sup>[1069]</sup> dialog (**Settings | MDG Technologies**).

### 5.2.6.1.1 SysML Model Elements

You can access the SysML Model elements **Toolbox** page through the **More tools | SysML | SysML Model Elements** menu option. These pages provide the SysML elements to build SysML models, package structures and views.

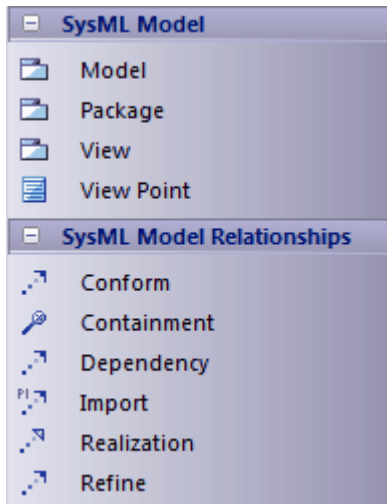

Page	Item	Use to
<b>SysML Model</b>	<b>Model</b>	Create a Package containing a SysML Model.
	<b>Package</b>	Group model constructs together in a single unit of containment.
	<b>View</b>	Create a stereotyped Package that defines a SysML View of a system, from the perspective of a SysML View Point.
	<b>View Point</b>	Create a stereotyped Class that defines a SysML View Point, which specifies the rules and conventions for the construction and use of Views.
<b>SysML Model Relationships</b>	<b>Conform</b>	Establish a conformance dependency of a View to the defining View Point.
	<b>Containment</b>	Graphically display ownership of one element within a parent one.
	<b>Dependency</b>	Establish a traceable relationship describing how one element is dependant upon another.
	<b>Import</b>	Represent a reuse of elements from one model package in another.
	<b>Realization</b>	Identify a design fulfillment of a specification between elements.
	<b>Refine</b>	Represent a refinement of one element by another.

### 5.2.6.1.2 SysML Block Definition

You can access the SysML Block Definition **Toolbox** pages through the **More tools | SysML | SysML Block Definition** menu option. These pages provide the SysML elements to design SysML blocks, constraint blocks, data and value types.

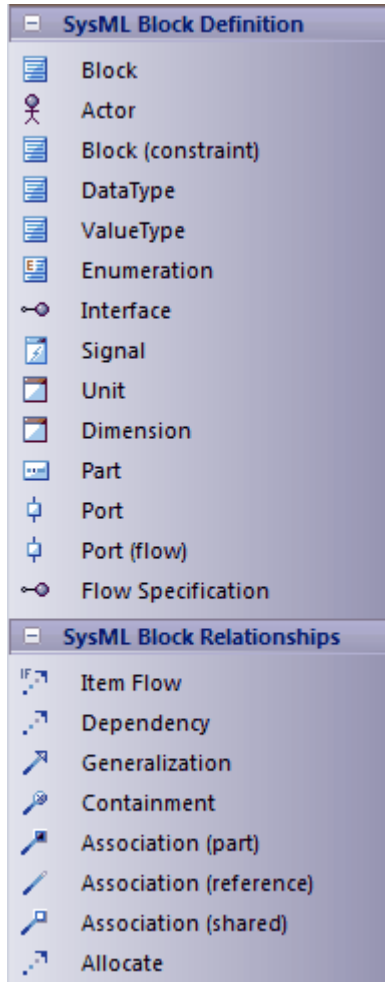

Page	Item	Use to
<b>SysML Block Definition</b>	<b>Block</b>	Define a composite system entity in SysML.
	<b>Actor</b>	Represent a user that interacts with one or more SysML systems.
	<b>Block (constraint)</b>	Define a composite constraint as a system of parametric equations.
	<b>DataType</b>	Define a SysML data type.
	<b>ValueType</b>	Define a SysML quantity, expressed as a measurable dimension with specific units.
	<b>Enumeration</b>	Define a data type as a set of symbols or values.
	<b>Interface</b>	Define an element that describes a specification of an interaction point with properties and methods.

Page	Item	Use to
	<b>Signal</b>	Define a SysML message, containing attributes, exchanged between system blocks in an interaction.
	<b>Unit</b>	Represent a standard unit of measure in SysML.
	<b>Dimension</b>	Identify a measurable quantity in SysML.
	<b>Part</b>	Describe the decomposition of a SysML Block subsystem in the context of its whole using instances of reusable SysML Blocks.
	<b>Port</b>	Describe a structural interaction point of a SysML Block which, in turn, connects between interacting parts of a block.
	<b>Port (flow)</b>	Describe what flows in and out of interacting SysML Blocks.
	<b>Flow Specification</b>	Define a set of flow properties that correspond to individual pieces of a common interaction point.
<b>SysML Block Relationships</b>	<b>Item Flow</b>	Specify the items that flow across a connector in an interaction point.
	<b>Dependency</b>	Establish a traceable relationship describing how one element is dependant upon another.
	<b>Generalization</b>	Describe an element as a specialized descendant of another element, containing additional properties and behavior.
	<b>Containment</b>	Graphically display ownership of one element within a parent element.
	<b>Association (part)</b>	Describe the characteristics of a connection between a SysML Block and its internal parts, such as the multiplicity and type.
	<b>Association (reference)</b>	Describe the characteristics of a connection between separate SysML Blocks, such as the multiplicity and type.
	<b>Association (shared)</b>	Describe the characteristics of a common connection between SysML Blocks, such as the multiplicity and type.
	<b>Allocate</b>	Relate model elements together to formalize a refinement of behavior, structure, constraints or design expectations.

### 5.2.6.1.3 SysML Internal Block

You can access the SysML Internal Block **Toolbox** pages through the **More tools | SysML | SysML Internal Block** menu option. These pages provide the SysML elements to design SysML block compositions within Internal Block Diagrams.

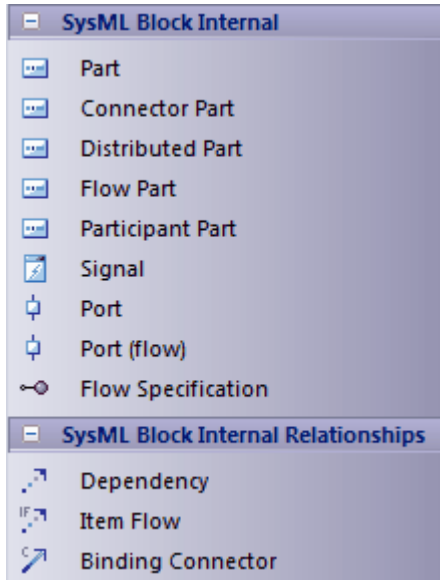

Page	Item	Use to
<b>SysML Block Internal</b>	<b>Part</b>	Describe the decomposition of a SysML Block subsystem in the context of its whole, using instances of reusable SysML Blocks.
	<b>Connector Part</b>	Create a SysML connector part.
	<b>Distributed Part</b>	Create a SysML distributed part.
	<b>Flow Part</b>	Create a SysML flow part.
	<b>Participant Part</b>	Create a SysML participant part.
	<b>Signal</b>	Define a SysML message, containing attributes, exchanged between system blocks in an interaction.
	<b>Port</b>	Describe a structural interaction point of a SysML Block which, in turn, connects between interacting parts of a block.
	<b>Port (flow)</b>	Describe what flows in and out of interacting SysML Blocks.
	<b>Flow Specification</b>	Define a set of flow properties that correspond to individual pieces of a common interaction point.
<b>SysML Block Internal Relationships</b>	<b>Dependency</b>	Establish a traceable relationship describing how one element is dependant upon another.
	<b>Item Flow</b>	Specify the items that flow across a connector in an interaction point.
	<b>Binding Connector</b>	Establish a connection between two parts in a system decomposition.

#### 5.2.6.1.4 SysML Parametrics

You can access the SysML Parametrics **Toolbox** pages through the **More tools | SysML | SysML Parametrics** menu option. These pages provide the SysML elements to construct SysML Parametric Diagrams using constraint blocks.

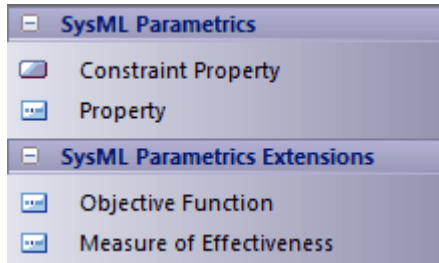

Page	Item	Use to
<b>SysML Parametrics</b>	<b>Constraint Property</b>	Instantiate a Constraint Block for use in a Parametric diagram.
	<b>Property</b>	Define a SysML property typed by a DataType, ValueType or Block.
<b>SysML Parametrics Extensions</b>	<b>Objective Function</b>	Define a SysML Constraint Block for use as an objective function to evaluate Measures of Effectiveness.
	<b>Measure of Effectiveness</b>	Define a SysML property for use as a measure of effectiveness (MOE).

### 5.2.6.1.5 SysML Activity

You can access the SysML Activity **Toolbox** pages through the **More tools | SysML | SysML Activity** menu option. These pages provide the SysML elements to construct SysML Activity models.

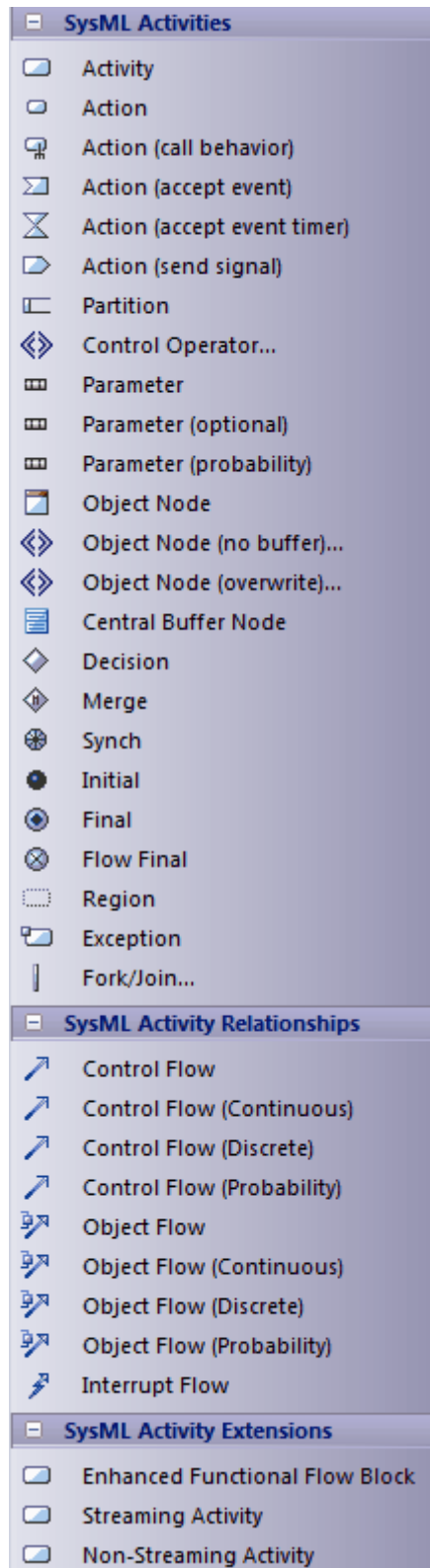



Page	Item	Use to
<b>SysML Activities</b>	<b>Activity</b>	Define a SysML Block of executable behavior as a UML Activity.
	<b>Action</b>	Declare a unit of execution in an Activity as a UML Action.
	<b>Action (call behavior)</b>	Declare a unit of execution that calls another behavior.
	<b>Action (accept event)</b>	Declare a unit of execution that accepts an event raised by the system.
	<b>Action (accept event timer)</b>	Declare a unit of execution that accepts an event raised by a time epoch.
	<b>Action (send signal)</b>	Declare a unit of execution that sends a signal as an event.
	<b>Partition</b>	Create an Activity Partition to group execution elements together by the node responsible for their execution.
	<b>Control Operator</b>	Control the execution of an Activity.
	<b>Parameter</b>	Provide access to input and output objects within the Activity.
	<b>Parameter (optional)</b>	Define a parameter whose contents are optional in the Activity's execution.
	<b>Parameter (probability)</b>	Tag a parameter with probability of the likelihood of the parameter's use in the Activity.
	<b>Object Node</b>	Declare a variable in the Activity, typed by a ValueType, DataType or Block.
	<b>Object Node (no buffer)</b>	Declare an ObjectNode in an Activity which discards unconsumed tokens.
	<b>Object Node (overwrite)</b>	Declare an ObjectNode in an Activity which overwrites tokens.
	<b>Central Buffer Node</b>	Declare an ObjectNode that stores tokens for consumption throughout the Activity.
	<b>Decision</b>	Create a branch of control in an Activity based on a decision.
	<b>Merge</b>	Merge two or more Activity control branches together.
	<b>Synch</b>	Establish a rendezvous point for two or more Activity flows, in order to synchronize their execution in the Activity.
	<b>Initial</b>	Declare the start of Activity's execution.
	<b>Final</b>	Declare the end of an Activity's execution, and the termination of the Activity.
	<b>Flow Final</b>	Declare the end of an Activity's execution path without terminating the Activity.
	<b>Region</b>	Group a subset of an Activity into a common execution context.
	<b>Exception</b>	Declare a node of execution that happens outside the normal flow of execution of an Activity.
	<b>Fork/Join</b>	Simultaneously branch / join a set of Control or Object Flows.

Page	Item	Use to
<b>SysML Activity Relationships</b>	<b>Control Flow</b>	Establish a flow of logic between two Activity nodes.
	<b>Control Flow (Continuous)</b>	Declare a continuous control flow.
	<b>Control Flow (Discrete)</b>	Declare a discrete control flow.
	<b>Control Flow (Probability)</b>	Tag a control flow with a probability of the likelihood of the flow's traversal.
	<b>Object Flow</b>	Establish a flow of objects (data) between two Activity nodes.
	<b>Object Flow (Continuous)</b>	Declare a continuous object flow.
	<b>Object Flow (Discrete)</b>	Declare a discrete object flow.
	<b>Object Flow (Probability)</b>	Tag an object flow with a probability of the likelihood of the flow's traversal.
	<b>Interrupt Flow</b>	Declare a control flow that interrupts flow within a Region.
<b>SysML Activity Extensions</b>	<b>Enhanced Functional Flow Block</b>	Declare an Activity used to contain an Enhanced Functional Flow Block Diagram (EFFBD).
	<b>Streaming Activity</b>	Declare an Activity where the flow of tokens passes through its parameters continuously throughout the Activity's execution.
	<b>Non-Streaming Activity</b>	Declare an Activity where the flow of tokens passes through its parameters at the start of the Activity's execution.

### 5.2.6.1.6 SysML Interaction

You can access the SysML Interaction [Toolbox](#) pages through the **More tools | SysML | SysML Interaction** menu option. These pages provide the SysML elements to construct SysML interactions and Sequence diagrams.

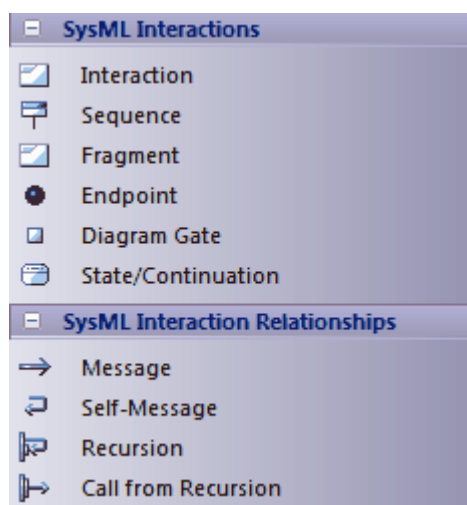

Page	Item	Use to
<b>SysML Interactions</b>	<b>Interaction</b>	Define a SysML Block of executable behavior as a UML Interaction.
	<b>Sequence</b>	Reference an instance of a SysML Block as a Lifeline in the Interaction.
	<b>Fragment</b>	Declare a portion of an interaction as a group with specific behavior semantics.
	<b>Endpoint</b>	Create an exit point for the Interaction.
	<b>Diagram Gate</b>	Create an endpoint for the interaction, which bridges between nested interactions.
	<b>State/Continuation</b>	Constrain the Interaction with assertions of the state that the lifeline is expected to be in.
<b>SysML Interactions Relationships</b>	<b>Message</b>	Describe a message exchange between two lifelines in an Interaction.
	<b>Self-Message</b>	Describe a message exchange between a lifeline and itself in an Interaction.
	<b>Recursion</b>	Describe a recursive message exchange between a lifeline and itself in an Interaction.
	<b>Call from Recursion</b>	Describe a message exchange between two lifelines within a recursive exchange.

### 5.2.6.1.7 SysML State Machine

You can access the SysML State **Toolbox** pages through the **More tools | SysML | SysML State Machine** menu option. These pages provide the SysML elements to build SysML State Machines.

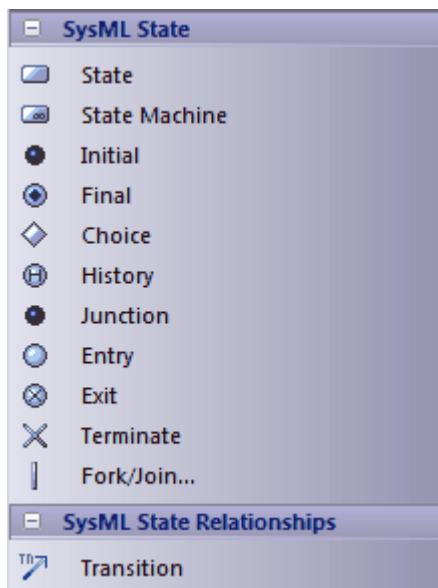

Page	Item	Use to
<b>SysML State</b>	<b>State</b>	Declare a significant condition in the life of a SysML Block within its State Machine.

Page	Item	Use to
	<b>State Machine</b>	Describe the life-cycle behavior of a SysML Block in terms of its states and transitions.
	<b>Initial</b>	Declare the starting state of the State Machine.
	<b>Final</b>	Declare the ending state of the State Machine, and its completion.
	<b>Choice</b>	Declare a Junction with a mandatory 'else' transition.
	<b>History</b>	Represent the last active State of the State Machine prior to its interruption.
	<b>Junction</b>	Declare a decision point at which a Transition branches out into multiple guarded, alternative paths.
	<b>Entry</b>	Declare an Entry point between State Machines, Substate Machines and Regions.
	<b>Exit</b>	Declare an Exit point between State Machines, Substate Machines and Regions.
	<b>Terminate</b>	Declare a termination State in which the State Machine no longer operates.
	<b>Fork/Join</b>	Simultaneously branch / join a set of Transitions.
<b>SysML State Relationships</b>	<b>Transition</b>	Establish a life-cycle path between one State and another, based on its operational conditions.

#### 5.2.6.1.8 SysML Use Case

You can access the SysML Use Case [Toolbox](#) pages through the **More tools | SysML | SysML Use Case** menu option. These pages provide the SysML elements to build SysML Use Case models.

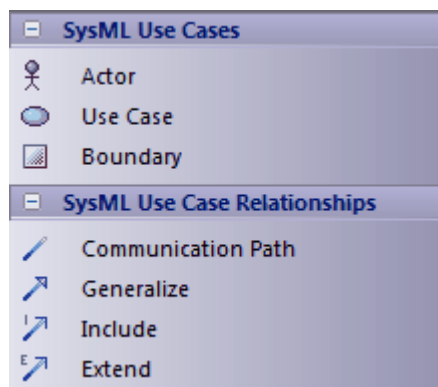

Page	Item	Use to
<b>SysML Use Cases</b>	<b>Actor</b>	Represent a user that interacts with one or more SysML systems.
	<b>Use Case</b>	Describe the expected functionality of a system as a UML Use Case.
	<b>Boundary</b>	Graphically bound elements in a diagram with a border.
<b>SysML Use</b>	<b>Communication Path</b>	Declare which Actors perform in the Use Case.

Page	Item	Use to
<b>Case Relationships</b>		
	<b>Generalize</b>	Describe an element as a specialized descendant of another element, containing additional properties and behavior.
	<b>Include</b>	Describe one Use Case as a subset of another.
	<b>Extend</b>	Describe one Use Case as an extension of another.

### 5.2.6.1.9 SysML Requirements

You can access the SysML Requirements **Toolbox** pages through the **More tools | SysML | SysML Requirements** menu option. These pages provide the SysML elements to build SysML Requirements models.

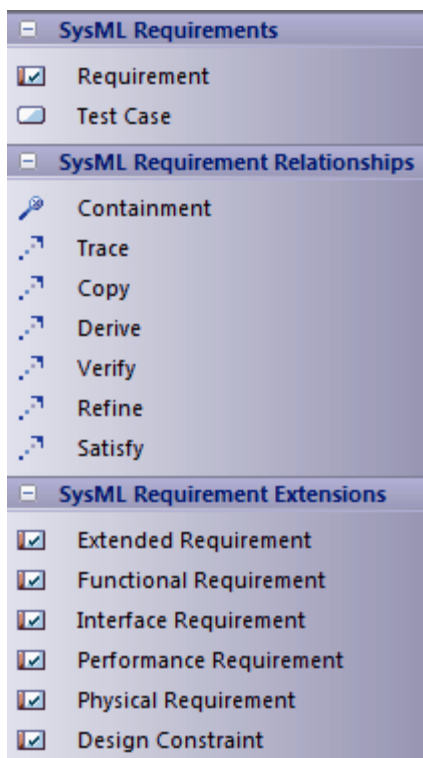

Page	Item	Use to
<b>SysML Requirements</b>	<b>Requirement</b>	Specify the capabilities of the system, or the conditions that it should satisfy.
	<b>Test Case</b>	Describe the verification of a Requirement through methods of inspection, analysis, demonstration or testing.
<b>SysML Requirement Relationships</b>	<b>Containment</b>	Graphically display ownership of one element within a parent element.
	<b>Trace</b>	Declare a trace relationship between a SysML Requirement and another SysML element.
	<b>Copy</b>	Declare a copy of one SysML Requirement by another.

Page	Item	Use to
	<b>Derive</b>	Derive a SysML Requirement from another.
	<b>Verify</b>	Declare a verification of a SysML Requirement by another SysML element.
	<b>Refine</b>	Declare a refinement of a SysML Requirement by another SysML element.
	<b>Satisfy</b>	Declare that the SysML Requirement is satisfied by another SysML element.
<b>SysML Requirement Extensions</b>	<b>Extended Requirement</b>	Extend a SysML Requirement with additional Tag properties.
	<b>Functional Requirement</b>	Declare a SysML Requirement that describes the operation, or behavior, that the system must perform.
	<b>Interface Requirement</b>	Declare a SysML Requirement that describes how the system connects, or interfaces with, other systems.
	<b>Performance Requirement</b>	Declare a SysML Requirement that describes how the system performs against defined capabilities or conditions.
	<b>Physical Requirement</b>	Declare a SysML Requirement that describes the physical characteristics, or physical constraints, of the system.
	<b>Design Requirement</b>	Declare a SysML Requirement that specifies a constraint on the implementation of the system.

### 5.2.6.2 SysML Parametric Models

#### Note:

Systems Modeling Language ([SysML](#)<sup>[989]</sup>) is supported in the Systems Engineering and Ultimate editions of Enterprise Architect.

SysML Parametric models support the engineering analysis of critical system parameters, including the evaluation of key metrics such as performance, reliability and other physical characteristics. They unite requirements models with system design models by capturing executable constraints based on complex mathematical relationships.

The following text is derived from the [SysML](#) entry in the online Wikipedia.

*The advantages of SysML over UML for systems engineering become obvious if you consider a concrete example, such as modeling an automotive system. With SysML you can use Parametric diagrams to precisely define performance and mechanical constraints such as maximum acceleration, curb weight, air conditioning capacity, and interior cabin noise management.*

For further information on the concepts of SysML Parametric models, refer to the official [OMG SysML](#) website and its linked sources.

### Create a Parametric Model

Enterprise Architect enables you to develop SysML Parametric models quickly and simply; these models can also be [simulated](#)<sup>[1005]</sup>. To create a Parametric model, follow the steps below:

1. Create a collection of *SysML Constraint Blocks* that formally describe the function of a constraint in a simulation model. Each Constraint Block contains properties that describe its input and output parameters, as well as *Element Script* that describes the constraint's executable component.

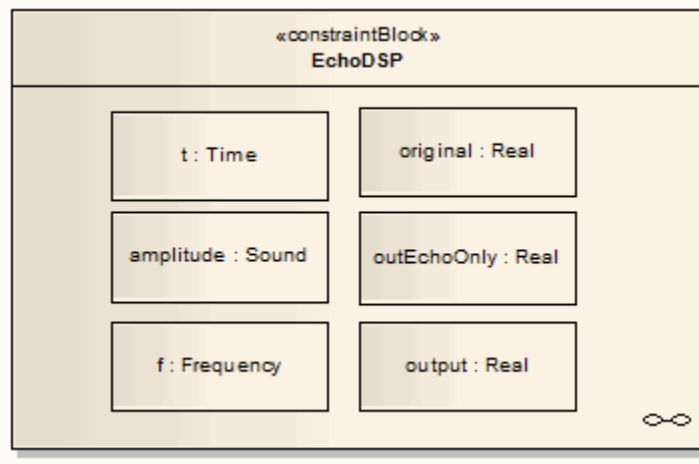

2. Right-click on each of the *constraintBlocks* and select the **SysML | Add Element Script** context menu option to add script to the constraint block. This is where you express the relationship / behavior of the constraint block as an executable script.

A screenshot of a SysML script editor window. The window has a toolbar with icons for file operations and a search icon. The script content is as follows:

```
1 out = a * b
2
```

3. Create a SysML Constraint Block to contain the Parametric model to simulate. The Parametric model contains properties and occurrences of constraint blocks as *Constraint Property* elements, connected in a Parametric Diagram.

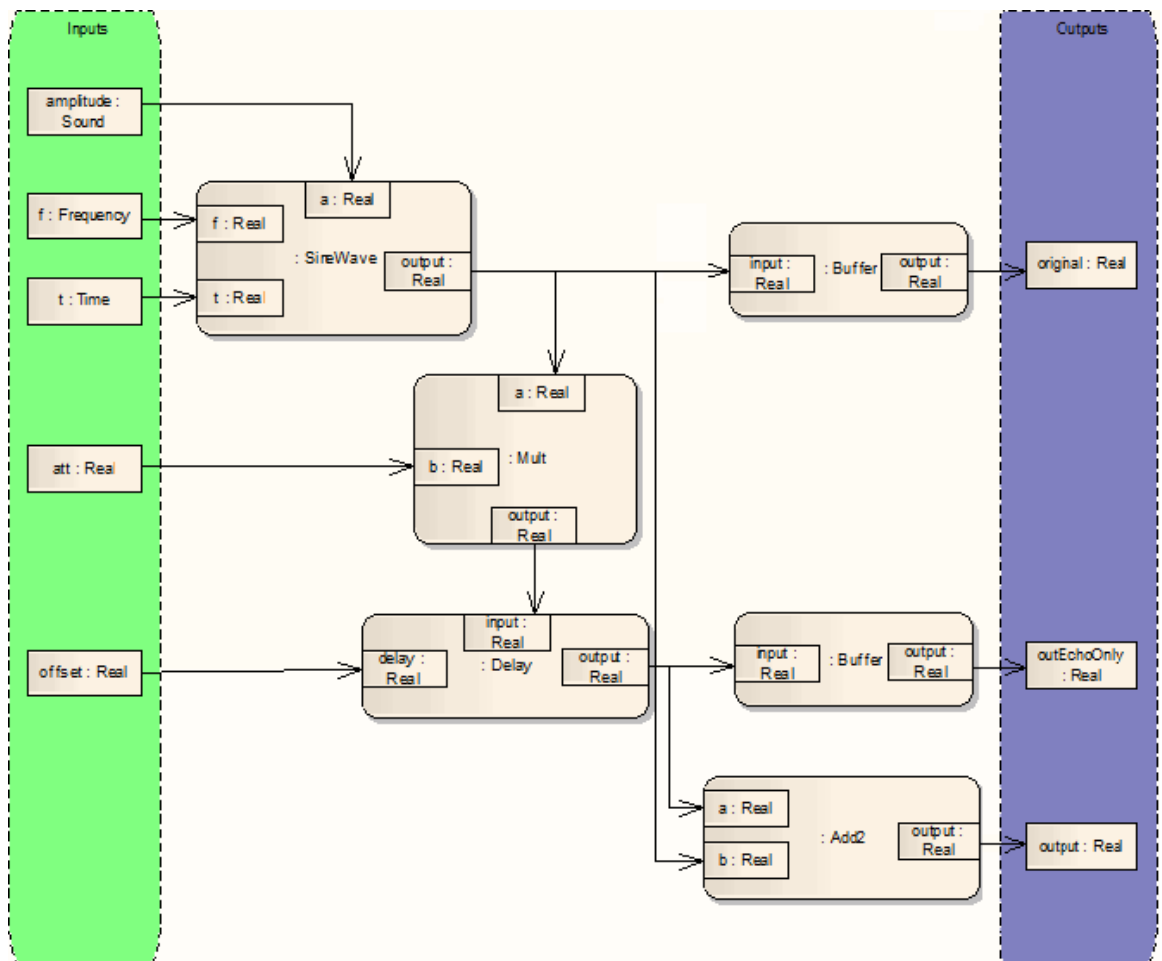

4. Right-click within a Parametric Diagram and select the **SysML | Simulate Diagram...** context menu option.
5. Depending on your [configuration selections](#) <sup>[1005]</sup>, the simulation's results are either written to a comma-separated CSV file or graphed in a 2-dimensional plot.



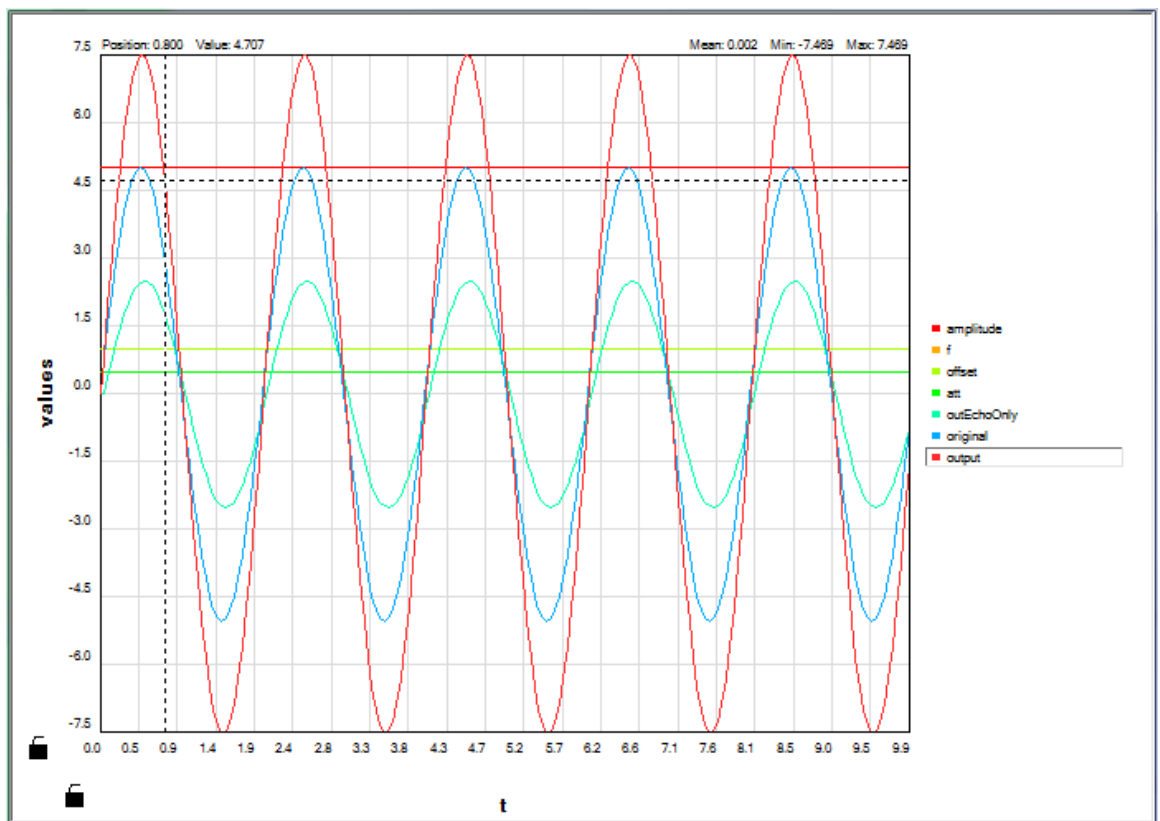

### 5.2.6.2.1 Simulate a SysML Model

**Note:**

Systems Modeling Language (SysML) is supported in the Systems Engineering and Ultimate editions of Enterprise Architect.

To simulate a SysML model, follow the steps below:

1. Right-click within a Parametric Diagram and select the **SysML | Simulate Diagram...** context menu option. The **Simulation Configuration** dialog displays.

2. The **Parameters** panel lists all of the parameters that can be assigned input. Select each of the required parameters and click on the right **Arrow** button to assign them as input. Parameters designated as input parameters are listed in the **Inputs** panel on the right.

**Note:**

There must be at least one input parameter assigned for the simulation to execute.

3. Assign a set of values for each of the designated input parameters. For each input parameter, in the **Input Values** panel select one of the two possible value kinds:
  - **Discrete** - To enter a constant or a comma-separated range of discrete values
  - **Range** - To enter a range of values beginning at the **From** value and ending at the **To** value. The input values are incremented by the **Step** value.
4. Specify the classes of output value:
  - **Parameters** - To output the parameters' data, select the checkbox
  - **Variables** - To output the data generated within each internal variable, select the checkbox. Internal variables are automatically generated by the simulator
5. Specify how the simulation results are to be reported. The **Output Format** panel enables you to choose how the simulation outputs the simulation data.
  - **Plot To Graph**: To plot the results on a 2-dimensional graph, select the checkbox; if you select this option, you must specify an input parameter for the plot's **X Axis**
  - **Title** - To enter a title for the graph, type in the title text
  - **Output to File** - To output the results to a CSV text file, select the checkbox and type or browse ([...]) for the file name.
6. Click on the **OK** button to execute the simulation.

### 5.2.6.3 Create a Requirements Model

The SysML *Requirements Model* provides the system requirements, the expected abstract behavior and the operating constraints that the designed system must conform to.

The following diagram shows an example requirements model for a *Portable Audio Player*.

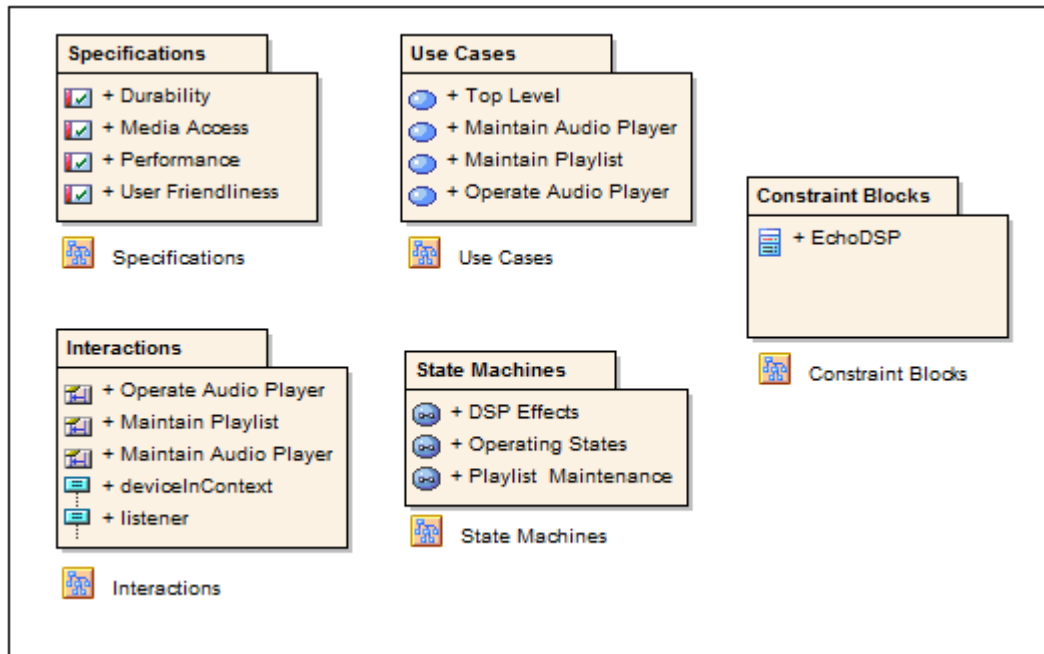

In the example *Requirements Model*, each of the child packages contains child models that capture the following aspects of the system's requirements:

- The *Specifications* package contains SysML Requirements describing the overall expectations of the designed system.
- The *Use Cases* package contains SysML Use Cases that describe the general interaction between the system and its users.
- The *Interactions* package contains SysML Interactions that describe a detailed sequence of interactions between the system and its users.
- The *State Machines* package contains SysML State Machines that describe each of the operational states the designed system has.
- The *Constraint Blocks* package contains SysML ConstraintBlocks that describe the expected performance and operating boundaries of the system.

### 5.2.6.4 Create an Operational Domain Model

The SysML *Operational Domain Model* defines the system's operating environment, which describes the operating conditions that the system is intended to operate within.

The following diagram shows an example Operational Domain model for a *Portable Audio Player*. The SysML Block Definition Diagram describes the Operational Domain (in this example - the *ListeningDomain*) as a system composition.

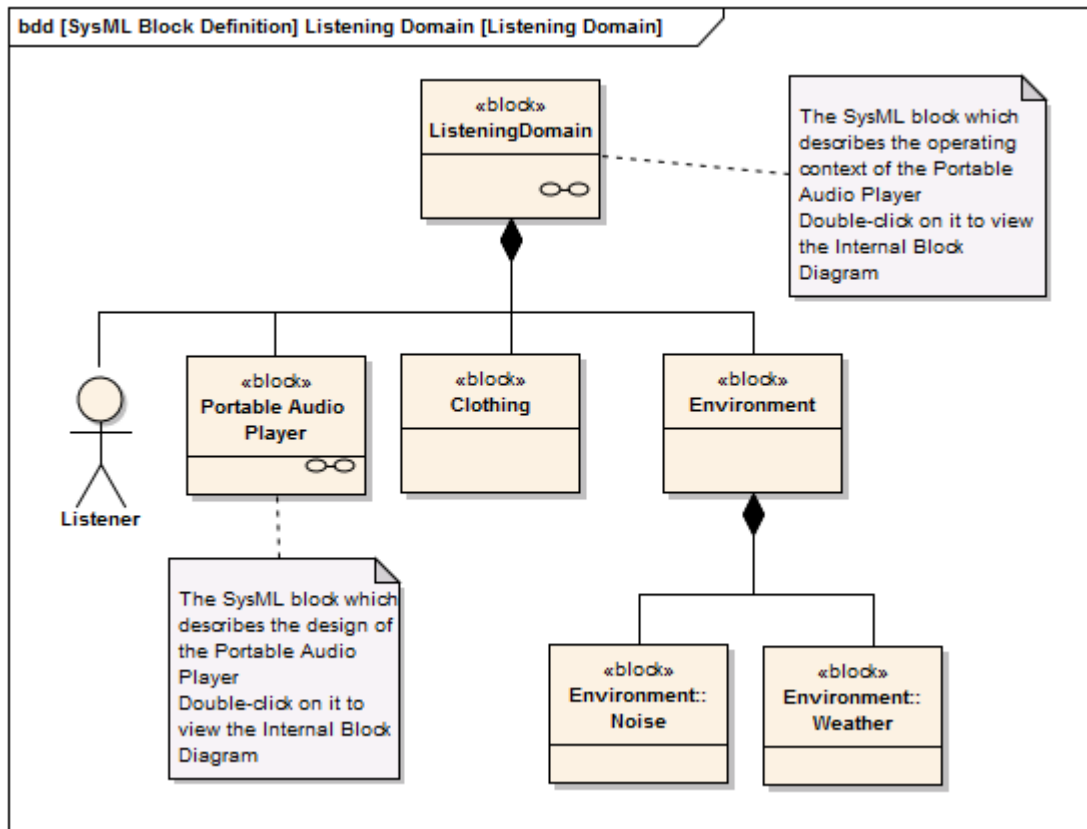

In this example, the *ListeningDomain* is defined as a system containing other subsystems within it. The domain contains subsystems that define the *Listener* (i.e. User), the *Portable Audio Player*, *Clothing* (which the user wears), and the External *Environment*.

Details of the *ListeningDomain* system are further detailed in the *ListeningDomain*'s *Internal Block Diagram*.

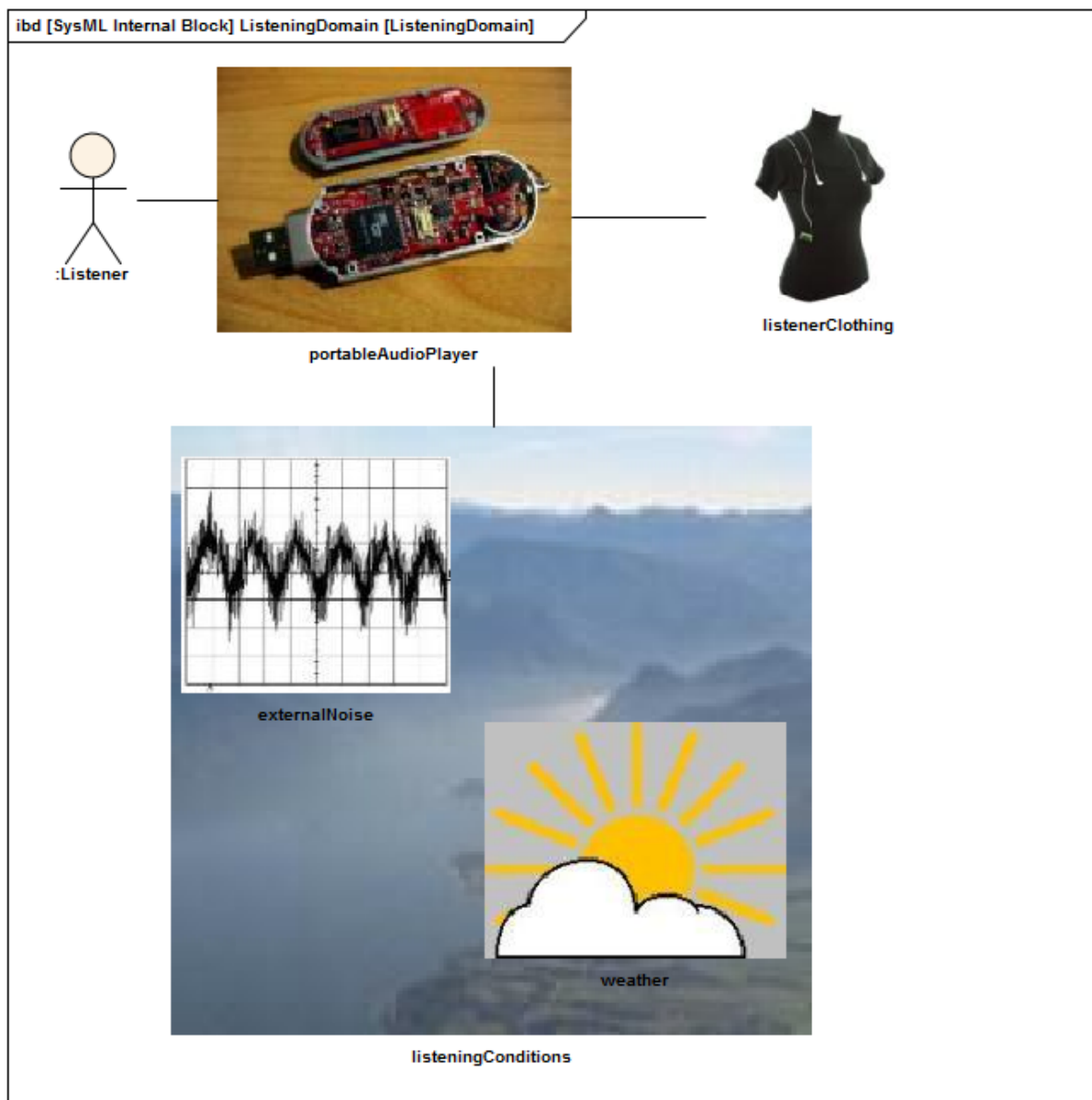

In this example, the *ListeningDomain*'s system's detailed composition shows how the Portable Audio Player and other sub-systems fit together to form the Listening Domain. It also describes the binding relationships between the parts, which describe how they are functionally bound to one another.

### 5.2.6.5 Compose System Design

The SysML *Design Model* contains the blocks that define the system's composition. It describes the manner in which reusable subsystems fit together to fulfill the design requirements.

The following diagram shows an example Design Model for a *Portable Audio Player*. The SysML *Block Definition Diagram* describes the *Portable Audio Player* as a composition of various reusable off-the-shelf subsystems in-house designed ones.

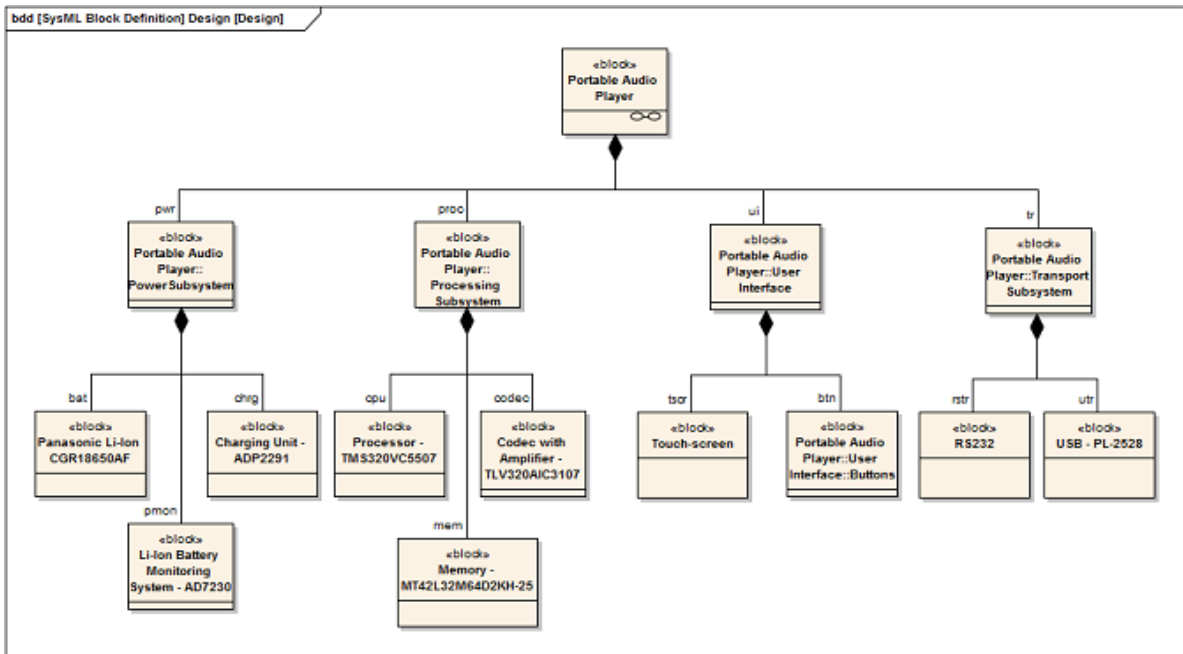

In the example above, the *Portable Audio Player* is defined as a SysML system containing subsystems that perform specific tasks. The design contains subsystems for supplying power, performing playback and audio processing, interfacing with other devices, and the user interface.

Details of the *Portable Audio Player*'s composition are further described in detail within the *Portable Audio Player's Internal Block Diagram*.

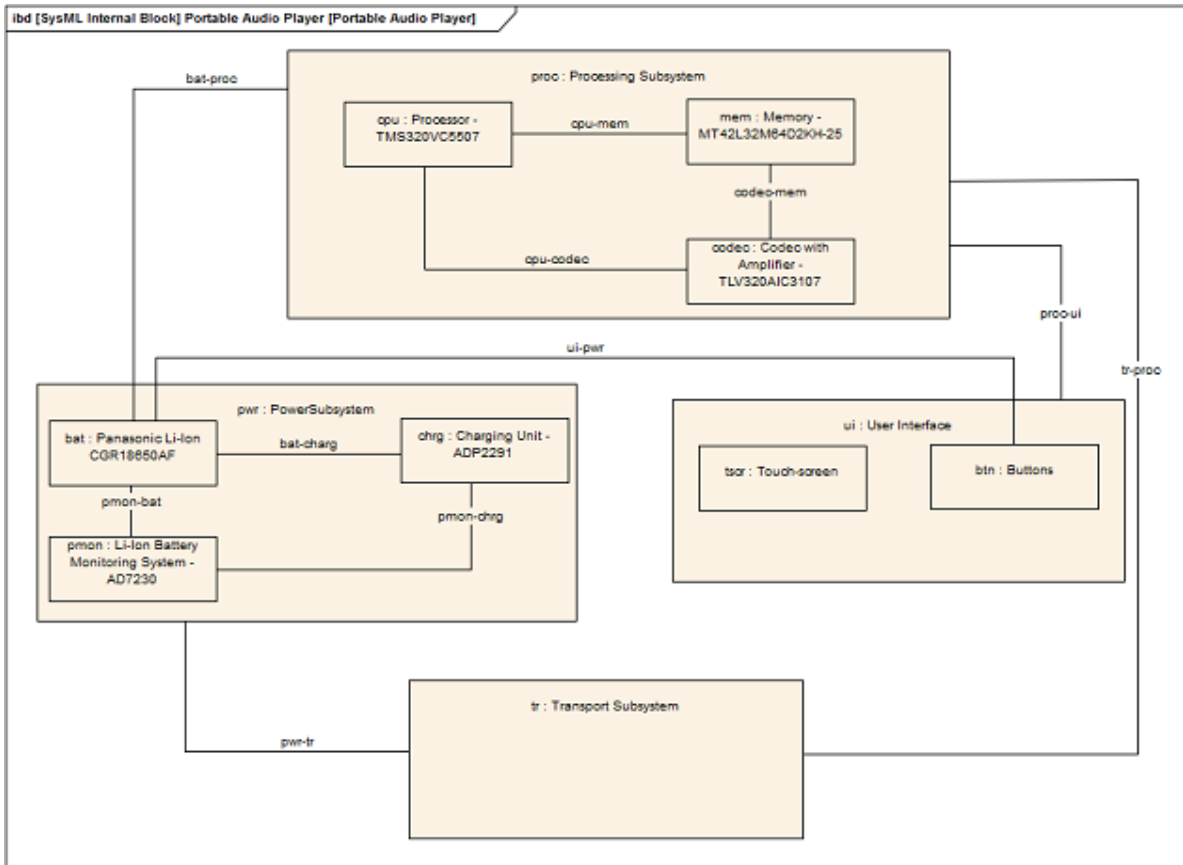

In this example, the Portable Audio Player's composition is described, detailing how each of the sub-systems is structured. It also describes the binding relationships between the parts, which describe how they are functionally bound to one another - for example, the *CPU*, *Memory* and *Codec* are interfaced together in the *Processing Subsystem*.

### 5.2.6.6 Create Reusable Subsystems

Model Based Systems Engineering provides the flexibility and expressiveness to define complex systems quickly effectively by reusing common entities across design projects. A *Library* is a package containing many reusable subsystems, parametric constraints, common data types and common value types, dimensions and units.

The following diagram shows an example library model.

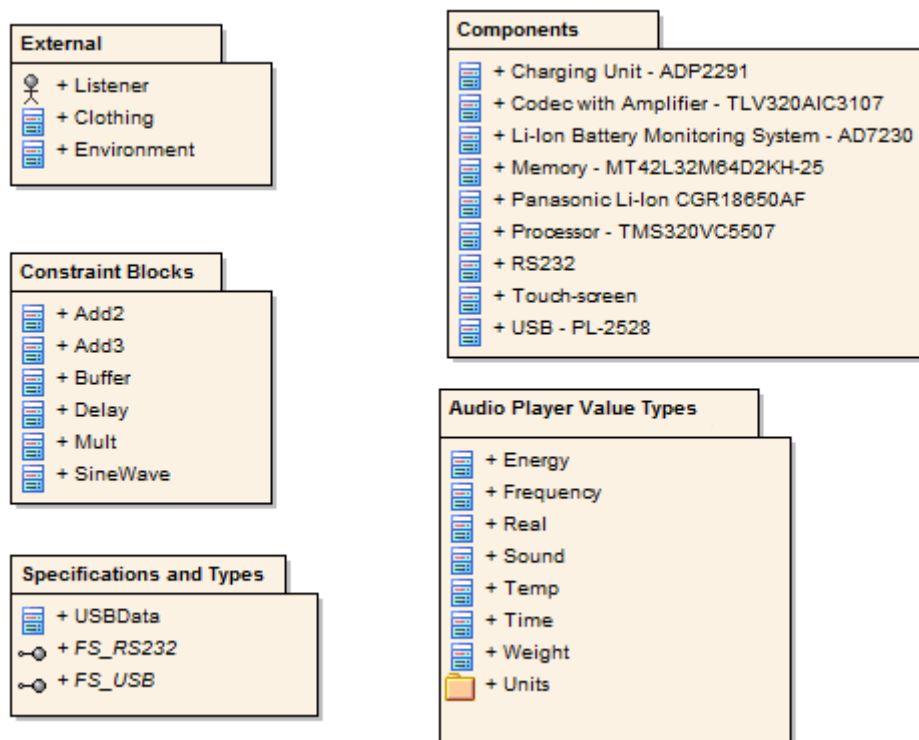

In the example Library, each of the child packages contains child models that capture the following reusable entities:

- *Blocks* defining systems such as those listed in the *Components* package, or those defined in the *External* package.
- *ConstraintBlocks* defining parametric constraints for use in parametric models.
- *Value Types* describing quantities, expressed as measurable dimensions in specific units.
- *Data Types* and *Flow Specifications* describing data structures and *Flows*.

### 5.2.7 Data Models

You perform database modeling and database design in Enterprise Architect using the *UML Data Modeling Profile*. This profile provides easy-to-use and easy-to-understand extensions to the UML standard, mapping the database concepts of tables and relationships onto the UML concepts of Classes and associations. These extensions also enable you to model database keys, triggers, constraints, RI and other relational database features.

#### Note:

The UML Data Modeling Profile is not currently a ratified standard; however it has wide industry support and is a useful method for bridging the gap between the UML and conventional relational database modeling.

Typical data modeling tasks you might perform are listed at the end of this topic.

For information on forward and reverse engineering of your data models, see the [Database Engineering](#)<sup>[1363]</sup> topic.

## Tables and Columns

The basic modeling *structure* of a relational database is the *table*, which represents a set of records, or rows, with the same structure. The basic organizational *element* of a relational database is the *column*. Every individual item of data entered into a relational database is represented by a value in a column of a row in a table.

The UML Data Modeling Profile represents:

- Tables as stereotyped *Classes*; that is, Class elements with a *stereotype* of **table**
- Columns as stereotyped *attributes*; that is, attributes with a *stereotype* of **column**.

Enterprise Architect can generate simple DDL scripts to create the tables in your model. You can also perform [Model Driven Architecture \(MDA\) Transformations](#)<sup>[1385]</sup> to DDL - Enterprise Architect provides a template specifically for [DDL transformations](#)<sup>[1393]</sup>.

To help you map Class attributes to Table fields, you can create connectors between specific attributes in the Class element and the column attributes in the Table element. See the [Connect to Element Feature](#)<sup>[611]</sup> topic.

## Database Keys

Two types of key are used to access tables: *Primary Keys* and *Foreign Keys*. A Primary Key uniquely identifies a record in a table, while a Foreign Key accesses data in some other related table via its Primary Key.

A Primary Key consists of one or more columns; a simple Primary Key (single column) is defined as the attribute of a stereotyped operation. A complex Primary Key (several columns) is defined as the stereotyped operation itself.

A Foreign Key is a collection of columns (attributes) that together have some operational meaning (they enforce a relationship to a Primary Key in another table). Foreign keys are represented in Enterprise Architect as operations with the stereotype **FK**; the operation parameters become the columns involved in the key.

## Supported Databases

Enterprise Architect supports import of database schema from these databases:

- DB2
- Firebird/InterBase
- Informix
- Ingres
- MS Access 97, 2000, 2003
- Access 2007
- MS SQL Server 2000, 2005, 2008
- MySQL
- Oracle 9i, 10g and 11g
- PostgreSQL
- Sybase Adaptive Server Anywhere (Sybase ASA)
- Sybase Adaptive Server Enterprise (Sybase ASE).

### Notes:

- You can download SQL Server 2005 data types and SQL Server 2008 data types from the [Resources](#) page of the Sparx Systems web site.
- Firebird 1.5 database tables can be modeled and generated as InterBase tables. Firebird tables can be imported but are treated as InterBase tables.

## Typical Tasks

Typical tasks you can perform when modeling or designing databases include:

- [Create a Data Model Diagram](#)<sup>[1013]</sup>
- [Create a Table](#)<sup>[1013]</sup>



- [Set Properties of a Table](#) <sup>[1014]</sup>
- [Create Columns](#) <sup>[1019]</sup>
- [Create Oracle Packages](#) <sup>[1022]</sup>
- [Create Primary Keys](#) <sup>[1022]</sup>
- [Create Foreign Keys](#) <sup>[1024]</sup>
- [Create Stored Procedures](#) <sup>[1030]</sup>

You can also perform additional, [advanced](#) <sup>[1031]</sup> procedures such as creating views or indexes and triggers.

### 5.2.7.1 A Data Model Diagram

An example of a *Data Model* diagram is provided below, showing three tables that are linked on *primary to foreign* key pairs with associated multiplicity.

Note the use of stereotyped operations for Primary (PK) and Foreign (FK) keys. Operations could also be added for:

- [Triggers](#) <sup>[1033]</sup>
- [Constraints](#) <sup>[1033]</sup> (**check, unique**)
- [Indexes](#) <sup>[1033]</sup>

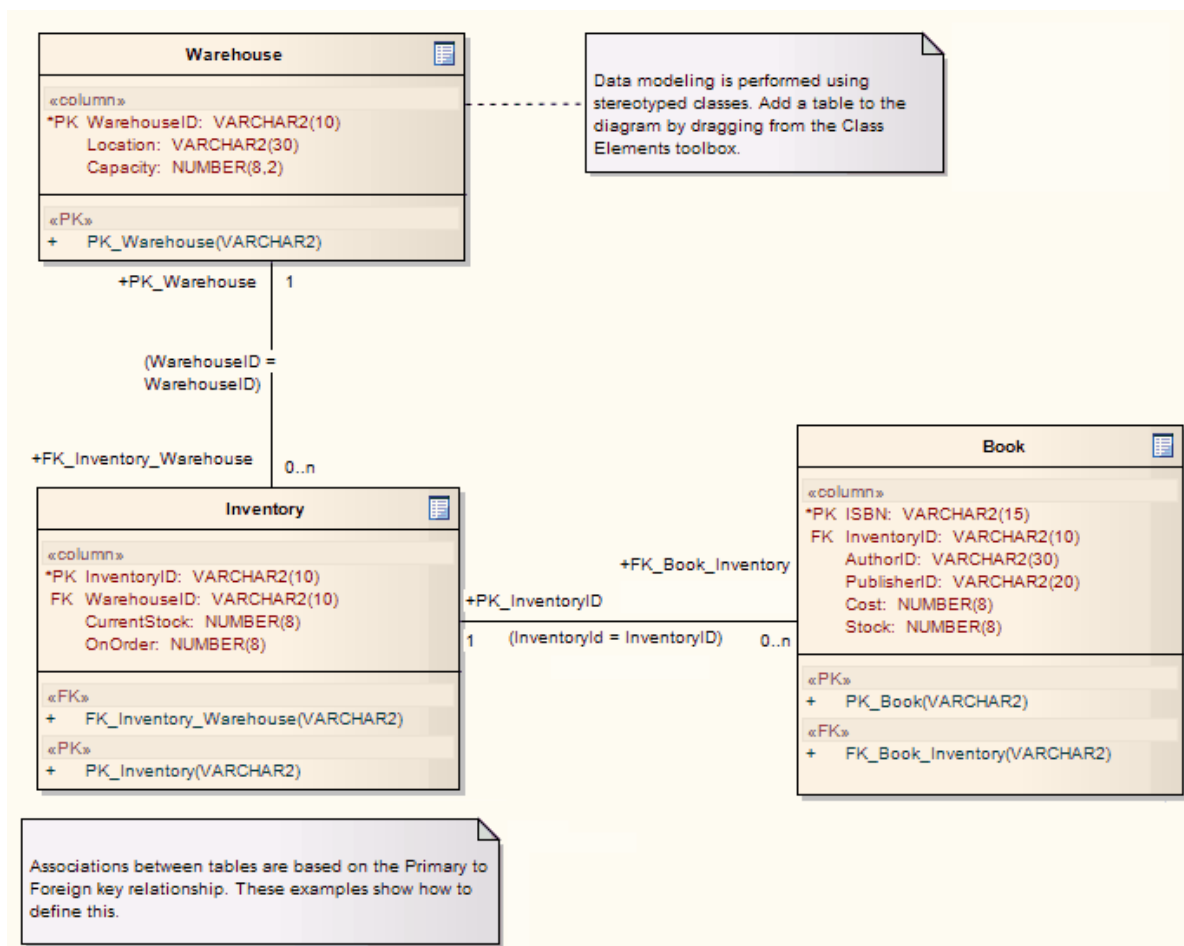

A Data Model diagram is represented in Enterprise Architect as a Class diagram, and is created [in exactly the same way](#) <sup>[422]</sup> as other diagrams.

### 5.2.7.2 Create a Table

#### What is a Table?

The basic modeling structure of a relational database is the *Table*. A Table represents a set of records, or rows, with the same structure.

The *UML Data Modeling Profile* represents a Table as a stereotyped Class; that is, a Class element with a stereotype of **table** applied to it. A table icon is shown in the upper right corner of the image when it is shown on a Data Model diagram.

### Create a Table

To create a Table, follow the steps below:

1. Select a diagram.
2. Select the **More Tools | Data Modeling** menu option on the **Toolbox**.
3. Click on the *Table* element in the list of elements, then click on the diagram. The Table element is displayed on the diagram.



4. If the **Class: Table n Properties** dialog does not display, double-click on the Table to display it.
5. In the **Name** field, type a name for the Table and [set any other properties](#) as required.
6. Click on the **OK** button.

#### 5.2.7.3 Working with Tables

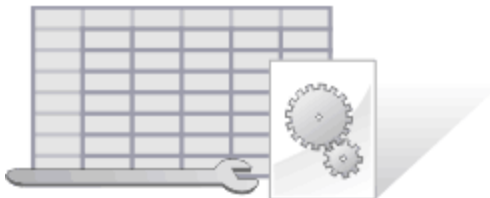

Once you have created your table, you can set its properties. Most table properties can be set from the **Properties** dialog, as described below. However, some properties must be entered as **Tagged Values** as described for setting the value of the **Table Owner** and, for **MySQL** and **Oracle** databases, setting the table options.

#### Set the Database Type

The most important property to set for a table (after its name) is the *database type*. This defines the list of datatypes that are available for defining columns, and also declares which dialect of DDL is generated. Enterprise Architect supports the following databases:

- DB2
- Informix
- Ingres
- InterBase
- MS Access 97, 2000, 2003
- Access 2007
- MySQL
- Oracle 9i, 10g and 11g
- PostgreSQL
- SQL Server 2000, 2005 and 2008

- SQLServer7
- Sybase Adaptive Server Anywhere (Sybase ASA)
- Sybase Adaptive Server Enterprise (Sybase ASE).

To set the database type, follow the steps below:

1. Double-click on the table element in a diagram to open the **Properties** dialog.
2. Select the **General** tab.

The screenshot shows the 'Properties' dialog box for a table element. The 'General' tab is selected. The 'Name' field contains 'Account'. The 'Stereotype' is 'table'. The 'Author' is 'The Administrator'. The 'Scope' is 'Public'. The 'Persistence' field is empty. The 'Phase' is '1.0' and the 'Version' is '1.0'. The 'Database' field is set to 'MySql'. The 'Status' is 'Proposed' and the 'Complexity' is 'Easy'. The 'Keywords' field is empty. There is an 'Advanced' button. The 'Notes' field is empty. The dialog has buttons for 'OK', 'Cancel', 'Apply', and 'Help'.

3. In the **Database** field, click on the drop-down arrow and select the database type.
4. Click on the **Apply** button to save changes.

By clicking on the **Table Detail** tab on this dialog, you can access the [Columns dialog](#) or [Operations dialog](#), or you can [Generate DDL](#) for this table.

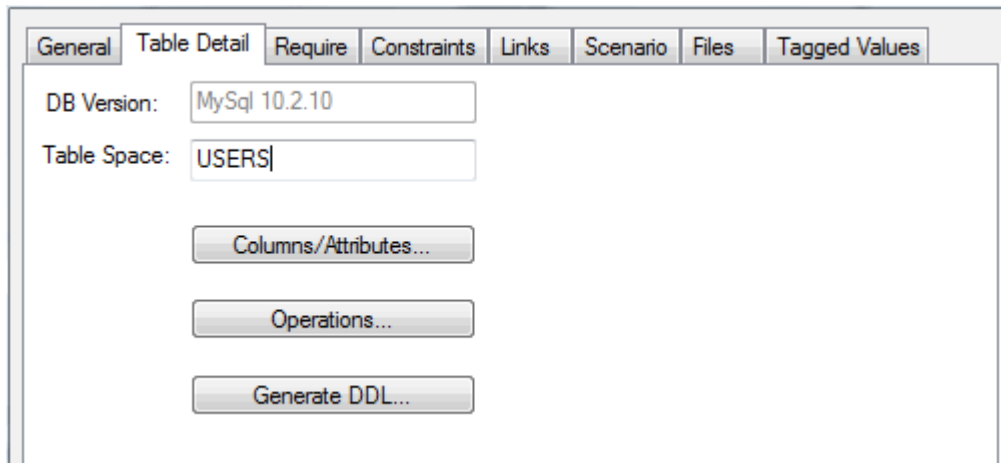

### 5.2.7.3.1 Set Table Owner

To define the owner of a table, follow the steps below:

1. Select the **Tagged Values** tab of the table **Properties** dialog. The **Tagged Values** tab shows the tags for the table.
2. Click on the **New Tag** button . The **Tagged Value** dialog displays.

3. In the **Tag** field, type the tag name **Owner**. In the **Value** field, type a value for the *Owner* tag.

#### Note:

For a PostgreSQL database, to define the owner name:

- In the **Tag** field, type the tag name **OWNER TO**
- In the **Value** field, type **Owner\_Name**.

4. Click on the **OK** button to confirm the operation. Generated DDL includes the table owner in the SQL script.

### 5.2.7.3.2 Set MySQL Options

In MySQL, to make use of foreign keys you must declare the table type as *InnoDB*. To do this, follow the steps below:

1. Select the **Tagged Values** tab of the table **Properties** dialog. The **Tagged Values** tab shows the tags for the table.
2. Click on the **New Tag** button . The **Tagged Value** dialog displays.

A dialog box with a 'Tag' dropdown menu and a 'Value' text input field. Below the fields are three buttons: 'OK', 'Cancel', and 'Help'.

3. In the **Tag** field, type the tag name **Type**. In the **Value** field, type **InnoDB** as the value for the *Type* tag.
4. Click on the **OK** button to confirm the operation. Generated DDL includes the table type in the SQL script.
5. To allow for later versions of MySQL, additional table options that can be added in the same manner include:

Tag	Value (Example)
ENGINE	InnoDB
CHARACTER SET	latin1
CHARSET	latin1
COLLATE	latin1_german2_ci

### 5.2.7.3.3 Set Oracle Table Properties

For Oracle, you can set table properties using the table's Tagged Values. Follow the steps below:

1. Select the **Tagged Values** tab of the table **Properties** dialog. The **Tagged Values** tab shows the tags for the table.
2. Click on the **New Tag** button . The **Tagged Value** dialog displays.
3. Define the table properties as shown in the examples below:

A dialog box with 'Tag' set to 'INITIAL' and 'Value' set to '65536'. Buttons: 'OK', 'Cancel', 'Help'.

A dialog box with 'Tag' set to 'PCTFREE' and 'Value' set to '10'. Buttons: 'OK', 'Cancel', 'Help'.

4. Click on the **OK** button to save the Tagged Value.
- All available properties for an Oracle table are listed below.

**Note:**

The same properties can be added to [indexes and constraints](#)<sup>1033</sup>. Highlight the index or constraint and add the properties as Tagged Values.

Property/Tag	Value
BUFFER_POOL	DEFAULT
CACHE	NOCACHE
DBVERSION	9.0.111
FREELISTS	1
GRANT OWNER1	SELECT
GRANT OWNER2	DELETE, INSERT, SELECT, UPDATE
INITIAL	65536
INITRANS	1
LOGGING	LOGGING
MAXEXTENTS	2147483645
MAXTRANS	255
MINEXTENTS	1
MONITORING	MONITORING
OWNER	OWNER1
PARALLEL	NOPARALLEL
PCTFREE	10
PCTINCREASE	0
PCTUSED	0
SYNONYMS	PUBLIC:TABLE_PUB;OWNER2:TABLE_OWNER2
TABLESPACE	MY_TABLESPACE
TEMPORARY	YES

The properties defined for a given table are listed on the **Tagged Values** tab, as illustrated by the following typical Tagged Value list:

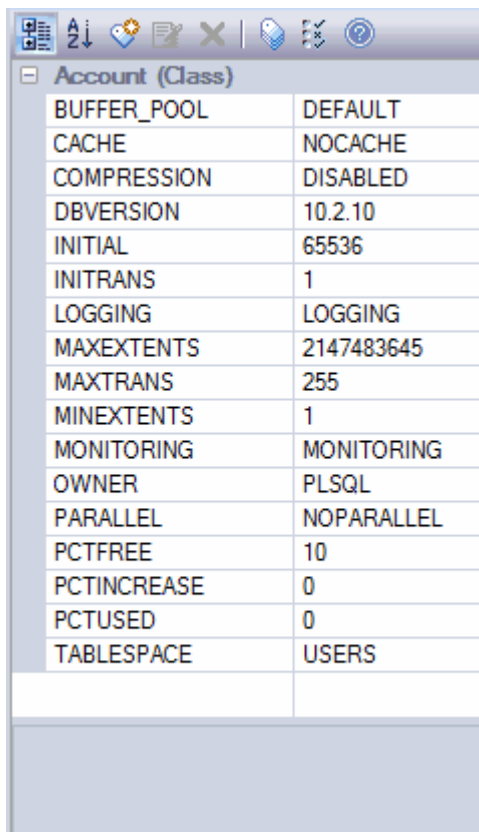

Account (Class)	
BUFFER_POOL	DEFAULT
CACHE	NOCACHE
COMPRESSION	DISABLED
DBVERSION	10.2.10
INITIAL	65536
INITRANS	1
LOGGING	LOGGING
MAXEXTENTS	2147483645
MAXTRANS	255
MINEXTENTS	1
MONITORING	MONITORING
OWNER	PLSQL
PARALLEL	NOPARALLEL
PCTFREE	10
PCTINCREASE	0
PCTUSED	0
TABLESPACE	USERS

#### 5.2.7.3.4 Create Columns

##### What is a Column?

The basic organizational element of a relational database is the *column*. Every individual item of data entered into a relational database is represented as a value in a column of a row in a table. Columns are represented in the UML Data Modeling Profile as a stereotyped attribute; that is, an attribute with the *Column* stereotype.

##### Create Columns

###### Note:

For MySQL, before creating columns first add ENUM and SET datatypes. Select the **Settings | Database Datatypes** menu option and, on the **Database Datatypes** dialog, in the **Product Name** field select **MySQL**. Add the datatypes ENUM and SET.

To create columns, follow the steps below:

1. Right-click on the Table in a diagram to open the context menu, and select the **Attributes** menu option.
2. The **<Tablename> Columns** dialog displays.

The screenshot shows the 'Tagged Values' dialog box for a column named 'm\_delivery'. The dialog is divided into two tabs: 'General' and 'Tagged Values'. The 'Tagged Values' tab is active, showing the following fields and options:

- Name:** m\_delivery
- Data Type:** INTEGER (dropdown menu)
- Stereotype:** input element (dropdown menu)
- Initial:** (empty text field)
- Access:** Private (dropdown menu)
- Alias:** (empty text field)
- Notes:** (Rich text editor with a toolbar containing Bold (B), Italic (I), Underline (U), Text Color (A), Bulleted List, Numbered List, Indent, Outdent, Undo, and Redo icons)
- Options:** Primary Key, Not Null, and Unique (checkboxes)
- Buttons:** Column Properties..., New, Save, Delete, Close, Cancel, Help

At the bottom of the dialog, there is a 'Columns' table with the following data:

PK	Name	Type	Not Null	Unique
	m_delivery	INTEGER	No	No
PK	Order		Yes	No
	BillingAddress	BIGINT	No	No
	Basket	BIGINT	No	No
	DeliveryAddress	BIGINT	No	No

3. In the **Name** field, type the column name.
4. In the **Data Type** field, click on the drop-down arrow and select the data type, and click on the **Save** button.

**Tip:**

If the drop-down list of datatypes is empty, this means that you have not selected a target database for the table. Close the **Columns** dialog and re-open the **Table Properties** dialog to set a database type before continuing. To prevent this recurring, [set the default database type](#) <sup>[1337]</sup>.

5. The following fields for each column are optional:
  - **Primary Key** - select the checkbox if the column represents the [primary key](#) <sup>[1022]</sup> for this table
  - **Not Null** - select the checkbox if empty values are forbidden for this column
  - **Unique** - select the checkbox if it is forbidden for any two values of this column to be identical
  - **Initial** - type a value that can be used as a default value for this column, if required
  - **Access** - click on the drop-down arrow and select a scope of **Private**, **Protected** or **Public** (the field defaults to **Public**)
  - **Alias** - type an alternative name for the field (for display purposes), if any
  - **Notes** - type any other information necessary to document the column; you can format the text using the [Notes toolbar](#) <sup>[642]</sup> at the top of the field.



**Notes:**

- The **unique** characteristic applied to a single column ensures that no two data values in the column can be identical. The **unique** stereotype applied to an [index](#) ensures that no two combinations of values across a set of columns can be identical.
- Some datatypes, such as the Oracle NUMBER type, require a precision and scale. These fields are displayed where required and should be filled in as appropriate. For example, for Oracle:
  - create NUMBER by setting Precision = **0** and Scale = **0**
  - create NUMBER(8) by setting Precision = **8** and Scale = **0**
  - create NUMBER(8,2) by setting Precision = **8** and Scale = **2**.
- Oracle VARCHAR2(15 CHAR) and VARCHAR2(50 BYTE) datatypes can be created by adding the tag *LengthType* with the value **CHAR** or **BYTE**.
- For MySQL ENUM and SET datatypes, in the **Initial** field type the values as a comma-separated list, in the format ('one','two','three') or, if one value is the default, in the format: ('one','two','three') default 'three'.

5. Click on the **Column Properties** button. The **Database Columns Properties** dialog displays.

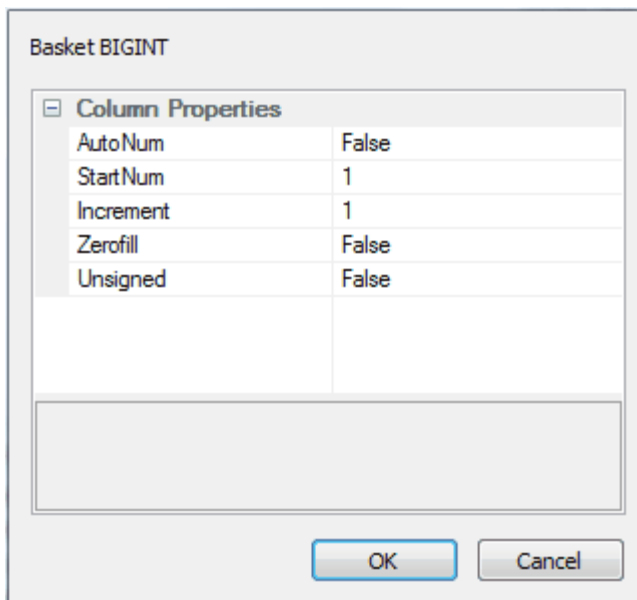



If you require a sequence, such as an Oracle sequence, select the **AutoNum** property, set the value to **True** and, if necessary, define the start number and increment. Click on the **OK** button to return to the **<Tablename> Columns** dialog.

6. Click on the **Save** button and on either the **New** button to define another column or the **Close** button to exit from the dialog.

## Change the Column Order

To change the column order, follow the steps below:

1. On the **Columns** dialog, highlight a column name in the **Columns** panel.
2. Click on the:
  -  button to move the column up one position
  -  button to move the column down one position.

### 5.2.7.3.5 Create Oracle Packages

To create an Oracle package, follow the steps below:

1. Open the project in the **Project Browser** and create an Enterprise Architect package (and, if required, a Class diagram).
2. Add a [Class](#) <sup>[817]</sup> element to either the package or the diagram.
3. Open the [Properties](#) <sup>[487]</sup> dialog for the element and, in the **Stereotype** field, type the value **Package**.
4. For the package specification, create an [Operation](#) <sup>[569]</sup> with the name *Specification* and with no return type.
5. Open the [Properties](#) <sup>[570]</sup> dialog for the *Specification* Operation and, on the **Behavior** tab, type the entire package specification into the [Initial Code](#) <sup>[576]</sup> field.
6. For the package body, create an Operation with the name *Body* and with no return type.
7. Open the **Properties** dialog for the *Body* Operation and, on the **Behavior** tab, type the entire package body into the **Initial Code** field.

### 5.2.7.4 Primary Key

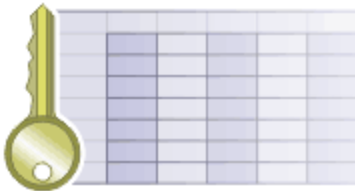

#### What is a Primary Key?

Keys are used to access tables, and come in two varieties: Primary Keys and Foreign Keys. A Primary Key uniquely identifies a record in a table, while a [Foreign Key](#) <sup>[1024]</sup> accesses data in some other related table via its Primary Key.

#### Define a Simple Primary Key

If a Primary Key consists of a single column, it is very easy to define.

1. Right-click on the table in a diagram to display the context menu. Select the **Attributes** menu option.
2. In the **Attributes** dialog, select the column that makes up the Primary Key.
3. Select the **Primary Key** checkbox and click on the **Save** button.

A stereotyped operation is automatically created. It is this operation that defines the Primary Key for the table. To remove a Primary Key, simply delete this operation.

#### Define a Complex Primary Key

Often, a Primary Key consists of more than one column. For example, a column *LastName* might not be unique within a table, so a Primary Key is created from the *LastName*, *FirstName* and *DateOfBirth* columns. Perform the following steps to create a complex Primary Key:

1. Follow the steps above to create a Simple Primary Key. It doesn't matter which column you choose.
2. Right-click on the table in a diagram to open the context menu. Select the **Operations** menu option.
3. Select the Primary Key operation (its name begins with **PK\_**) and then click on the **Column** tab.
4. To add a column to the Primary Key, click on the **New** button, select a column from the **Column Name** list box, and then click on the **Save** button.
5. Click on the **Hand** buttons (up and down arrow) to change the order of columns in the Primary Key, if necessary.

(See also the [SQL Server Non-Clustered Primary Keys](#) <sup>[1024]</sup> topic).

#### Define a Primary Key Name Template

To define the name template for a Primary Key, follow the steps below:

1. Select the **Tools | Options | Source Code Engineering | Code Editors** menu option. The **Code**

Editors page of the Options dialog displays.

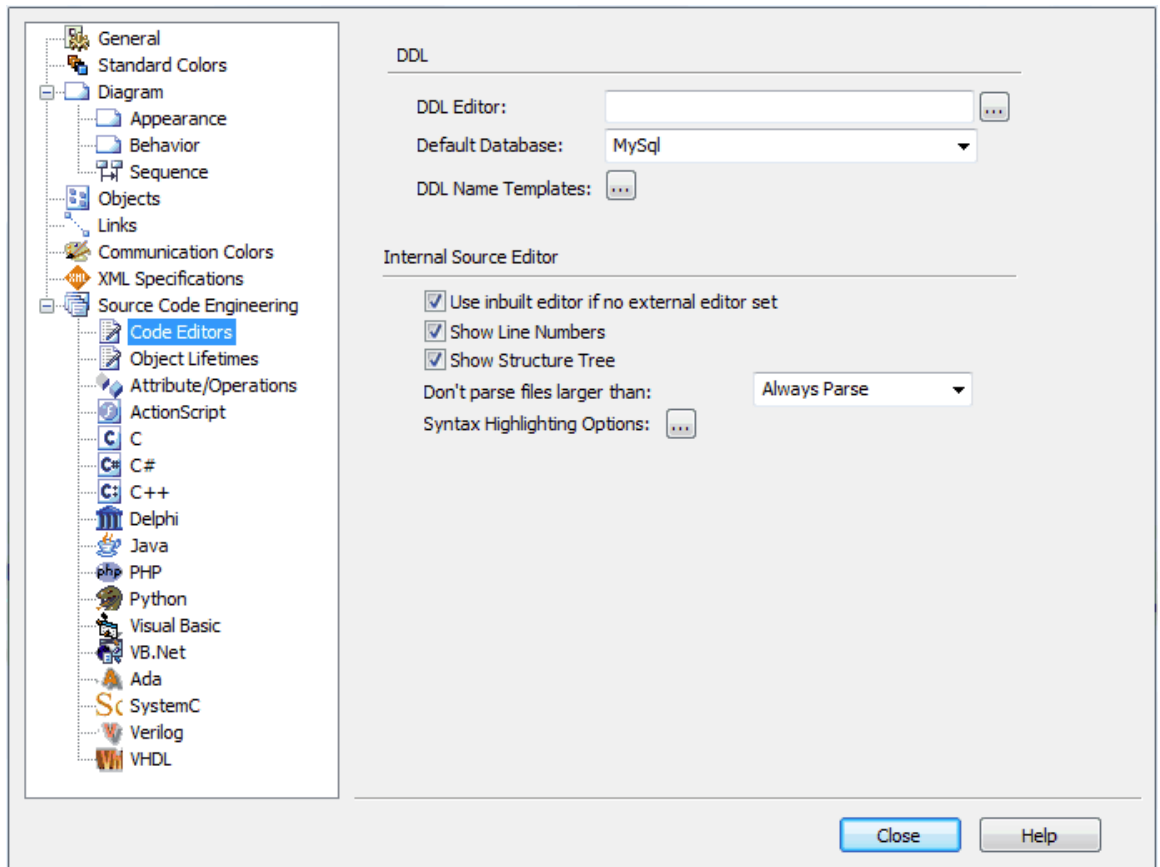

2. Click on the **DDL Name Templates** button. The **DDL Name Template** dialog displays, showing the default name templates.

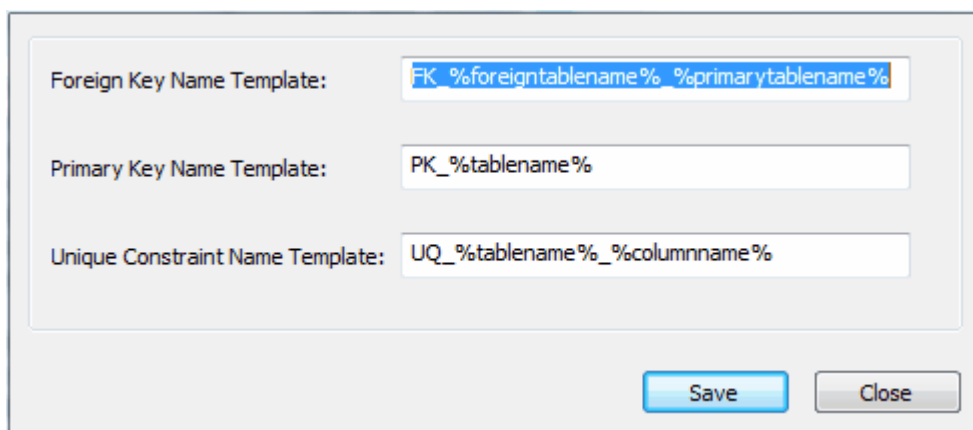

3. Edit or replace the template in the **Primary Key Name Template** field.

**Note:**

If you want to display the Primary Key description as *PK\_tablename\_columnname* then change the **Primary Key Name Template** field to *PK\_%tablename%\_%columnname%*.

4. Click on the **Save** button.

#### 5.2.7.4.1 SQL Server Non Clustered Keys

To define a primary key as non-clustered for a SQL Server table, follow the steps below:

1. Right-click on the table in a diagram to open the context menu.
2. Select the **Operations** menu option. The Table **Operations** dialog displays.
3. Highlight the Primary Key Operation and select **Extended Properties**. The **Database Operation Properties** dialog displays.

4. Select the **SQL Server Non Clustered Primary Key** checkbox.
5. Click on the **Save & Close** button.

#### 5.2.7.5 Foreign Key

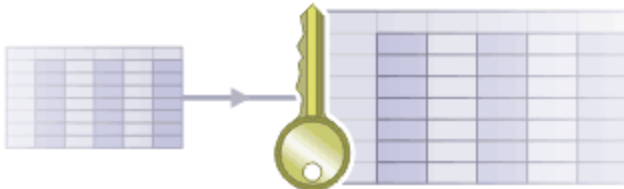

### What is a Foreign Key?

Two types of key are used to access tables: [Primary Keys](#)<sup>[1022]</sup> and Foreign Keys. A Primary Key uniquely identifies a record in a table, while a Foreign Key accesses data in some other related table via its Primary Key.

Foreign keys are represented in Enterprise Architect using stereotyped operations. A Foreign Key is a collection of columns (attributes) that together have some operational meaning (they enforce a relationship to a Primary Key in another table). A Foreign Key is modeled as an operation stereotyped with the *FK* stereotype; the operation parameters become the columns involved in the key.

#### Note:

It isn't necessary to define a Foreign Key in order to access another table through its Primary Key. Foreign Keys are a feature of some database management systems, providing 'extras' such as referential integrity checking that prevents the deletion of a record if its Primary Key value exists in some other table's Foreign Key. The same thing can be achieved programmatically.

To [create a Foreign Key](#)<sup>[1025]</sup>, click on the link.

You might also have to [define a Name Template](#)<sup>[1028]</sup> for Foreign Keys.

### 5.2.7.5.1 Create Foreign Key



To create a Foreign Key, follow the steps below:

1. Locate the required Tables in a diagram. Both tables must have the same [defined database types](#) <sup>[1015]</sup>.
2. Select an *Associate* connector in the **Class Relationships** page of the **Toolbox**.
3. Click on the Table to contain the Foreign Key (source) and draw the connector to the other Table (target).
4. Right-click on the connector to display the context menu, and select the **Foreign Keys** option. The **Foreign Key Constraint** dialog displays.

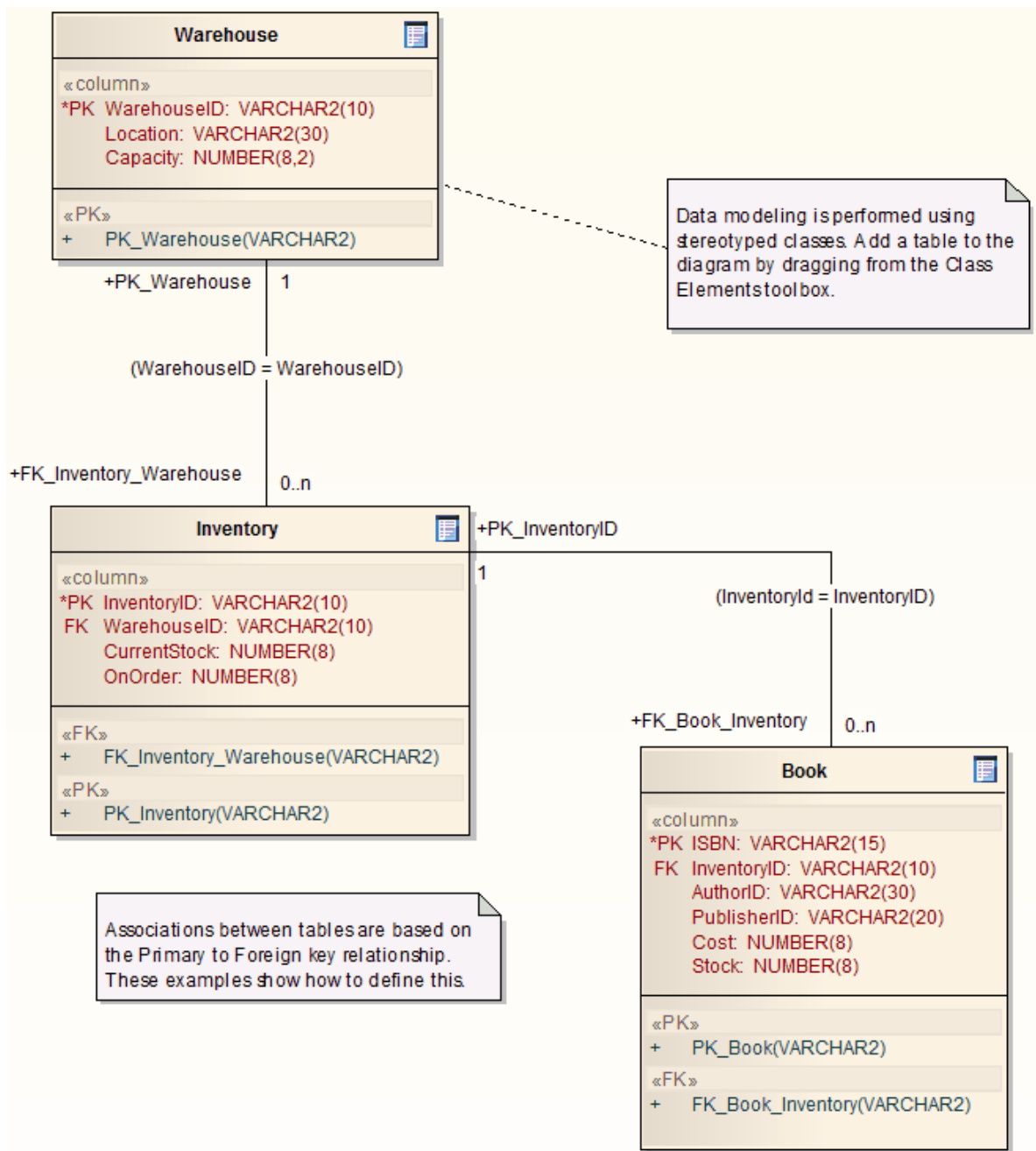
5. The default foreign key name is set by the **Foreign Key Name Template**. To change the name to something other than the default provided by the template, select the **Override Template** checkbox and edit the foreign key name.
  6. In the **Source:** panel and the **Target:** panel, click on the name of each of the two columns involved in the Foreign Key relationship (in the screenshot above, the column name *WarehouseID* in each panel).
  7. Select the appropriate referential integrity constraint from the **On Delete** and/or **On Update** combo boxes.
  8. Click on the **Apply** or **OK** buttons to automatically generate the Foreign Key operations.
- You have created the Foreign Key. The example below shows how this looks in a diagram:



## Composite Foreign Key

To create a composite Foreign Key, select the required columns in each of the **Source:** and **Target:** panels and click on the **OK** button. The Foreign Key columns are sorted according to datatype to match the datatypes of the targeted composite Primary Key. If required, you can change the order of the key columns by clicking on the  and  buttons.

### Tip:

If you are defining a MySQL database and want to use Foreign Keys, you must [set the table type](#) <sup>[1018]</sup> to enable this.

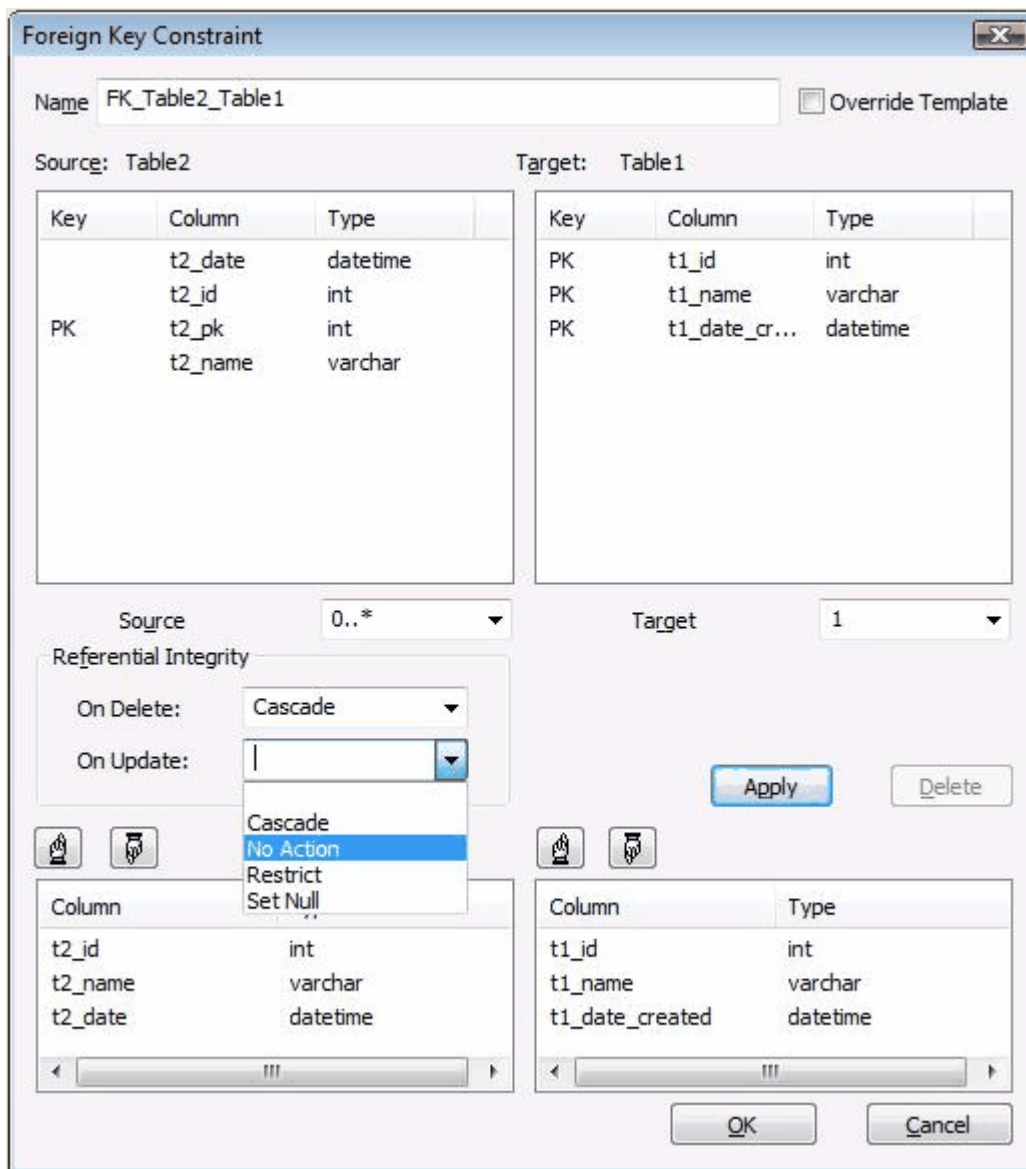

This creates the composite Foreign Key. The example below shows how this looks in a diagram:

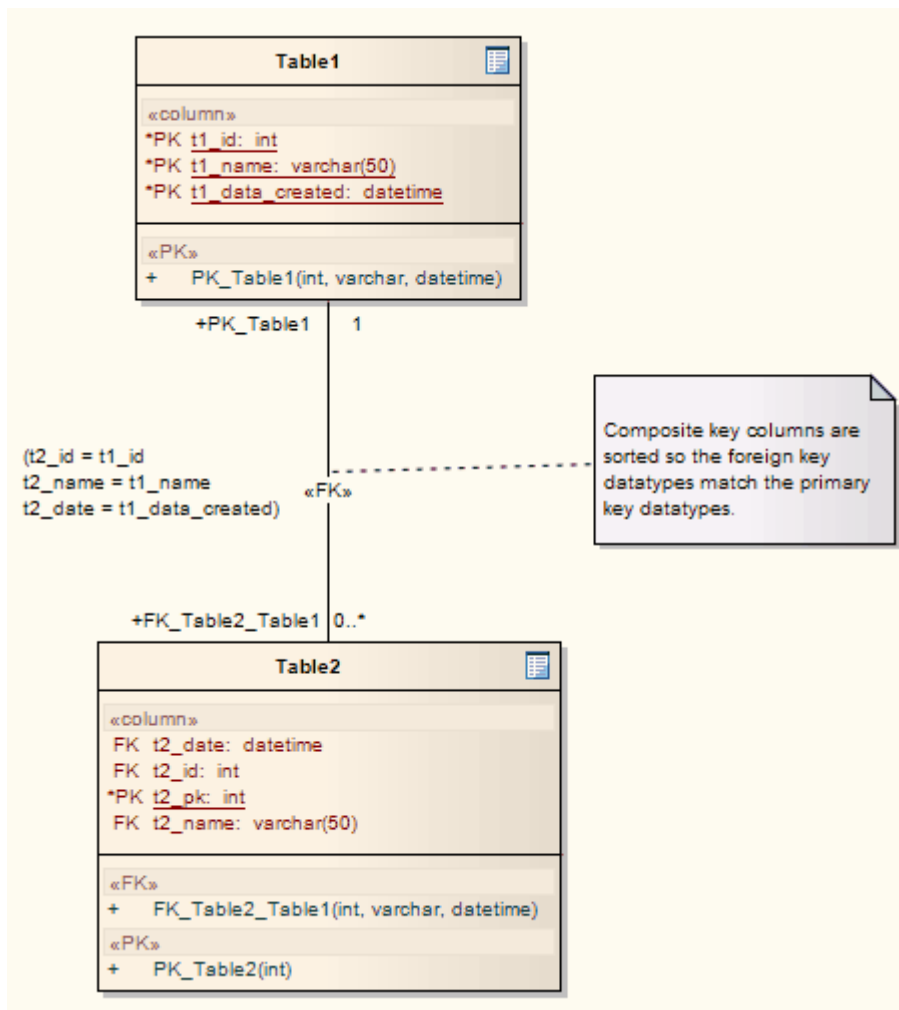

### 5.2.7.5.2 Define Foreign Key Name Template

To define the name template for a Foreign Key, follow the steps below:

1. Select the **Tools | Options | Source Code Engineering | Code Editors** menu option. The **Code Editors** page of the **Options** dialog displays.



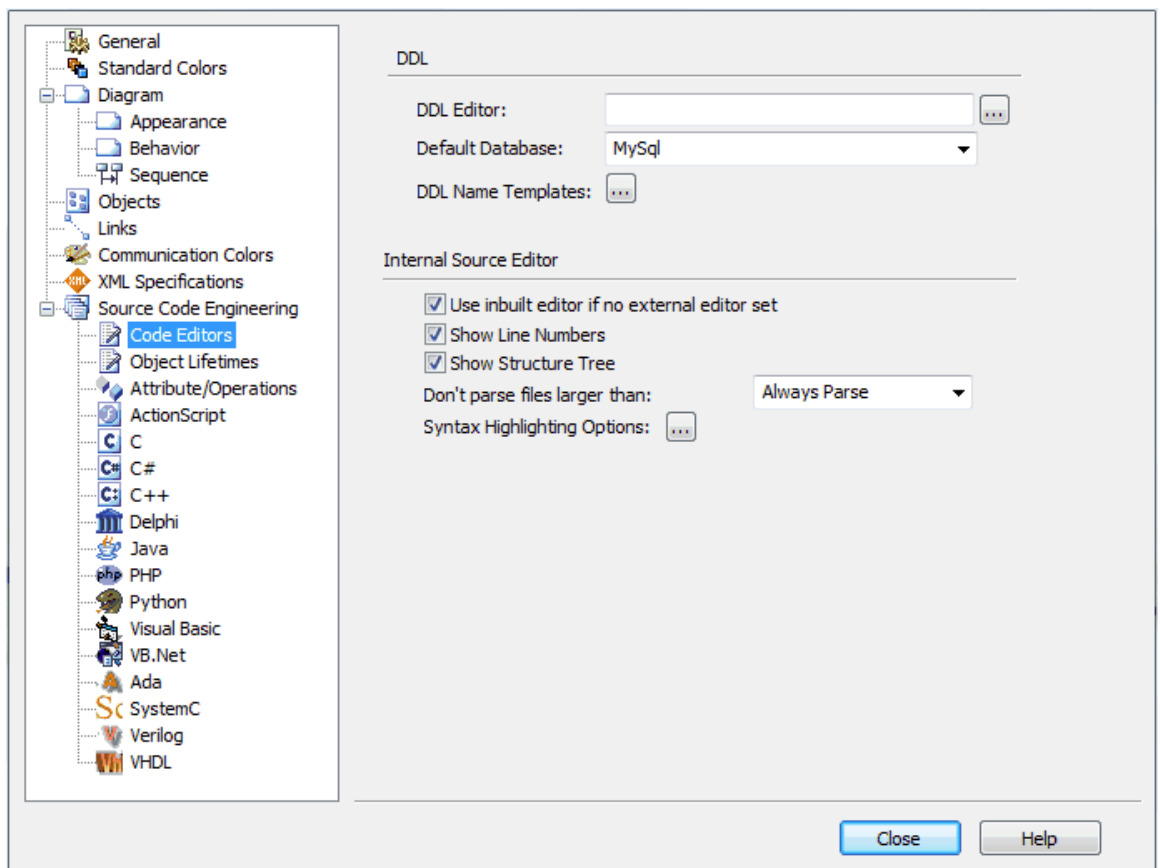

- Click on the **DDL Name Template** button. The **DDL Name Template** dialog displays, showing the default name templates.

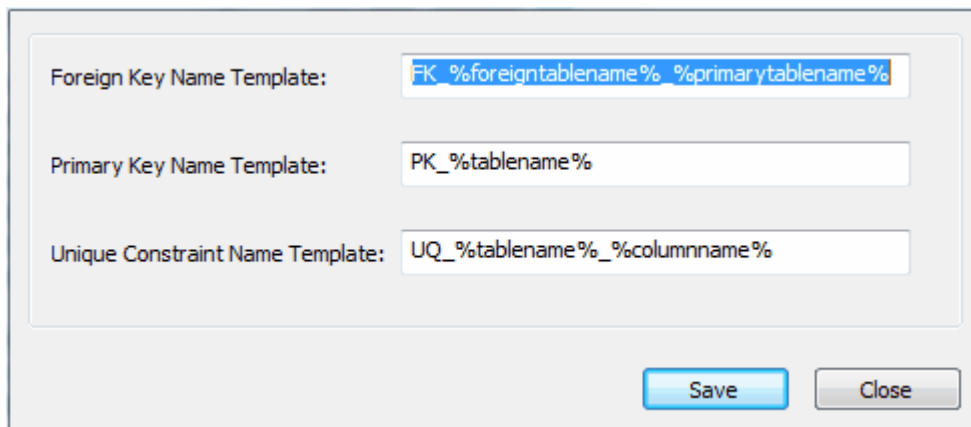

- Edit or replace the name template in the **Foreign Key Name Template** field.

**Note:**

If you want to display the Foreign Key description as *FK\_foreigntablename\_FKcolumnname\_primarytablename\_PKcolumnname* then change the **Foreign Key Name Template** field to *FK\_%foreigntablename%\_%fkcolumnname%\_%primarytablename%\_%pkcolumnname%*.

- Click on the **Save** button.

### 5.2.7.6 Stored Procedures



#### What is a Stored Procedure?

A stored procedure is a group of SQL statements that form a logical unit and perform a particular task. Stored procedures are used to encapsulate a set of operations or queries to execute on a database server. You can compile and execute stored procedures with different parameters and results, and they can have any combination of input, output and input/output parameters.

Enterprise Architect models stored procedures as [individual Classes](#) <sup>1030</sup>.

**Note:**

Stored procedures are currently supported for: DB2; SQL Server; Firebird/Interbase; Informix; Ingres; Oracle 9i, 10g and 11g; MySQL; PostgreSQL; Sybase Adaptive Server Enterprise (ASE) and Sybase Adaptive Server Anywhere (ASA).

#### 5.2.7.6.1 Create Individual Class Procedure

To create a stored procedure as an individual Class, follow the steps below:

1. Open the required diagram.
2. From the **Data Modeling** page of the **Toolbox (More tools | Data Modeling)** drag the **Procedure** icon onto the diagram.
3. If the **Properties** dialog does not automatically display, double-click on the element.

The screenshot shows a dialog box with a 'Database:' dropdown menu currently showing 'MySQL'. Below it is a large text area labeled 'Procedure definition:' which is currently empty. At the bottom right of the dialog are three buttons: 'OK', 'Cancel', and 'Help'.

4. In the **Database** field click on the drop-down arrow and select the target DBMS to model. (The field displays the default database if it has already been set.)
5. In the **Procedure definition** field, type the entire procedure text.
6. Click on the **OK** button.

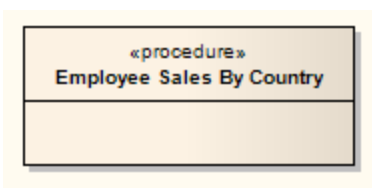

To define a name for the stored procedure, click on the element, click on the name (**Class<n>**) and click again. This [highlights the text for editing](#) <sup>[1035]</sup>. Type in the required name.

### 5.2.7.7 Advanced Topics

In creating a data model, you can perform more advanced modeling such as:

- [Creating Views](#) <sup>[1032]</sup>
- [Creating Indexes, Check Constraints and Triggers](#) <sup>[1035]</sup>
- [Converting Datatypes for a Table](#) <sup>[1035]</sup>
- [Converting Datatypes for a Package](#) <sup>[1036]</sup>
- [Customizing Datatypes for a DBMS](#) <sup>[1037]</sup>

### 5.2.7.7.1 Views

#### Note:

Views are currently supported for: DB2; SQL Server; Firebird/Interbase; Informix; Ingres; Oracle 9i, 10g and 11g; MySQL; PostgreSQL; Sybase Adaptive Server Enterprise (ASE) and Sybase Adaptive Server Anywhere (ASA).

### Create a View

To create a database View, follow the steps below:

1. On the **Data Modeling** page of the **Toolbox (More tools | Data Modeling)**, drag the **View** icon onto your Data Modeling diagram.
2. If the **View Properties** dialog does not immediately display, double-click on the element.

The screenshot shows a dialog box with three main sections: 'Database:' with a dropdown arrow, 'Dependencies:' with an empty list area, and 'View definition:' with a text input field.

3. From the **Database** drop-down list, select the target DBMS to model. The default database displays if it has already been set.
4. Click on the **OK** button.

To define a name for the View, click on the element, click on the name (**Class<n>**) and click again. This [highlights the text for editing](#)<sup>[588]</sup>. Type in the required name.

### Define View Properties

1. Create a Dependency connector from the View to the table or tables on which the View depends.
2. Double-click on the View to display the **Properties** dialog. The tables are now listed in the **Dependencies** field.
3. In the **View definition** field, type the full view definition. (The [code editor](#)<sup>[1428]</sup> provides intellisense for basic SQL keywords and functions).
4. Click on the **OK** button to save your definition.

The View definition and certain other parameters are held as Tagged Values. The View definition is held in the *viewdef* memo Tagged Value, as shown in the following example diagram. You can select and view the *viewdef* Tagged Value in the [Tagged Values](#)<sup>[632]</sup> window, and include it in RTF reports by inserting the [valueOf\(viewdef\)](#)<sup>[1587]</sup> field in the *Package::Element* or *Element::Tagged Values* sections.

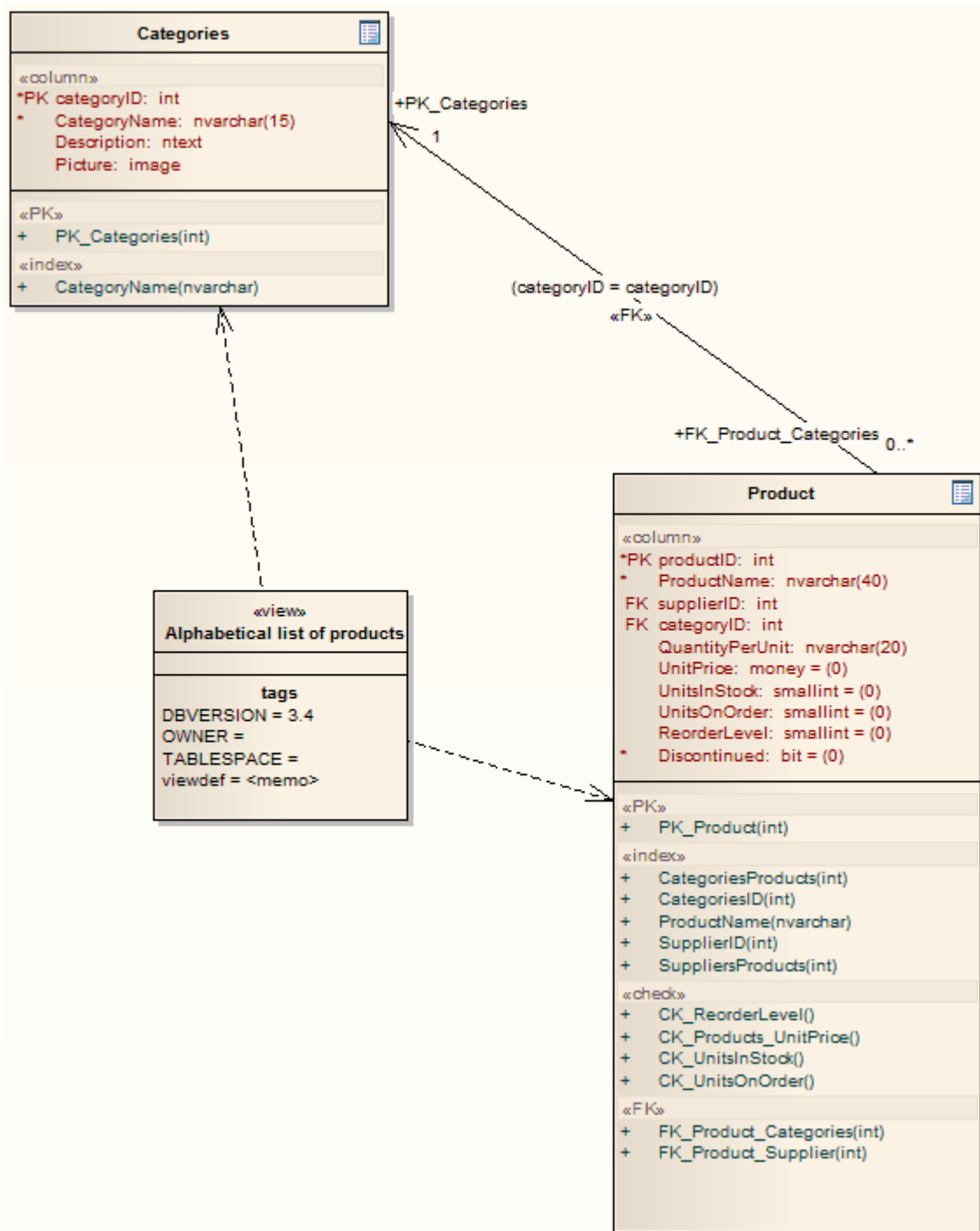

### 5.2.7.7.2 Index, Trigger, Check Constraint

#### What is an Index?

An index is a sorted look-up for a table. When it is known in advance that a table must be sorted in a specific order, it is usually worth the small processing overhead to always maintain a sorted look-up list rather than sort the table every time it is required. In Enterprise Architect, an index is modeled as a stereotyped operation. On generating DDL, the necessary instructions for generating indexes are written to the DDL output.

The **unique** characteristic applied to a single column ensures that no two data values in the column can be identical. The **unique** stereotype applied to an index ensures that no two *combinations* of values across a set of columns can be identical.

## What is a Trigger?

A trigger is an operation automatically executed as a result of the modification of data in the database, and usually ensures consistent behavior of the database. For example, a trigger might be used to define validations that must be performed every time a value is modified, or might perform deletions in a secondary table when a record in the primary table is deleted. In Enterprise Architect, a trigger is modeled as a stereotyped operation.

## What is a Check Constraint?

A *Check Constraint* enforces domain integrity by limiting the values that are accepted by a column.

## Create an Index

Ensure that the column(s) to be used in the index have [already been defined](#) in the table.

1. Right-click on the required table either in a diagram or in the **Project Browser**.
2. Select the **Operations** context menu option. The **Operations** dialog displays.
3. Add an operation (with a name such as *IDX\_CustomerID*; the *IDX\_* prefix is optional but it helps identify the operation).
4. In the **Stereotype** field for the operation, select **index** (**check** and **unique** are also supported).
5. Click on the **Column** tab.
6. Select the required columns from the **Columns** drop-down list in the required order, then click on the **Save** button to save changes.

## Create a Check Constraint or Trigger

1. Locate the required table in either a diagram or the **Project Browser**.
2. Use the context menu to open the **Operations** dialog.
3. Add an operation (such as *CHK\_ColumnName* or *TRG\_OnCustomerUpdate*; the *CHK\_* and *TRG\_* prefixes are optional but help identify the operation).
4. In the **Stereotype** field for the constraint, select **check** or **trigger** as appropriate and click on the **Save** button to save changes.
5. Select the constraint operation, then the **Behavior** tab.
6. Enter the entire check constraint clause (for example, **col1 < 1000**), or the entire trigger code (including the *CREATE\_TRIGGER* statement) in the **Initial Code** field and click on the **Save** button to save changes.

The example below shows how an index looks in a diagram (in the *Order* element):

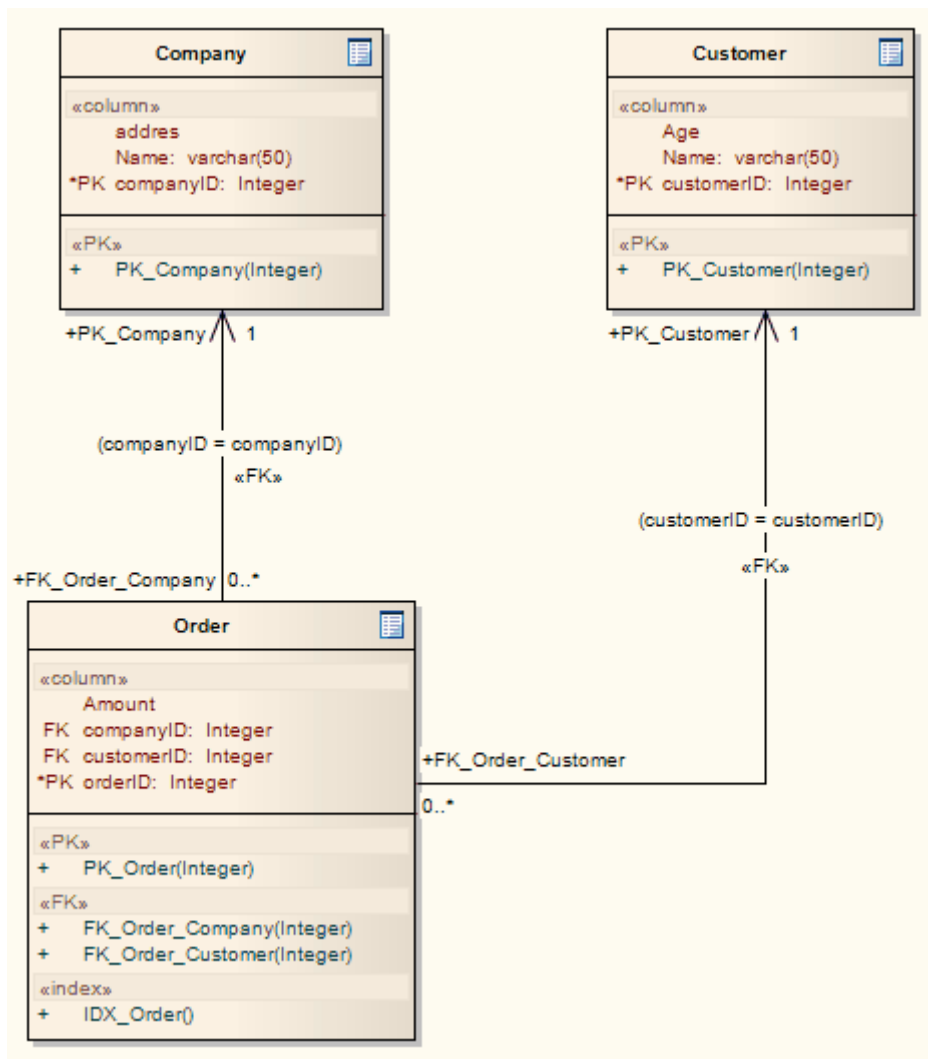

### 5.2.7.7.3 Data Type Conversion Procedure

Once a database schema has been set up on an Enterprise Architect diagram (either by importing through ODBC or manually setting up the tables), the DBMS can be changed to another type and the column datatypes are mapped accordingly.

To map the DBMS type of a table to another DBMS type, follow the steps below:

1. Double-click on the table element in a diagram to open the table **Properties** dialog.
2. The **Database** field shows the current DBMS for this table.
3. To map the column datatypes to another DBMS, select the target from the **Database** drop-down and click on the **Apply** button.
4. The datatypes are converted to match those of the new DBMS, and these are reflected in any DDL generated from this table.

General | **Table Detail** | Requirements | Constraints | Links | Scenarios | Files | Tagged Values

Name: Account

Stereotype: table  Abstract

Author: Suzanne Pearson Status: Proposed

Scope: Public Complexity: Easy

Alias: Database: MySql

Persistence: Keywords:

Phase: 1.0 Version: 1.0

Notes:

B I U A | | x<sup>2</sup> x<sub>2</sub> |

#### 5.2.7.7.4 Data Type Conversion for a Package

The DBMS Package procedure or mapper enables you to convert a package of database tables from one DBMS type to another DBMS type, as well as providing the ability to change the ownership of tables.

To map the DBMS types of a package to another DBMS type, follow the steps below:

1. Right-click on the package in the **Project Browser** to display the context menu.
2. Select the **Code Engineering | Reset DBMS Options** menu option. The **Manage DBMS Options** dialog displays.

Convert DBMS Type

Current DBMS: MSAccess

New DBMS: Oracle

Change Table Owner

Current Owner:

New Owner:

Process Child Packages

3. In the **Current DBMS** field, click on the drop-down arrow and select the current DBMS. In the **New DBMS** field click on the drop-down arrow and select the target DBMS.
4. Select the **Convert DBMS Type** checkbox.
5. If there are child packages that also require changing, select the **Process Child Packages** checkbox.
6. Click on the **OK** button. All tables in the selected packages are mapped to the new DBMS.

To change the owner of the table or all of the tables in a package, follow the steps below:

1. Right-click on the package in the **Project Browser** to display the context menu.



2. Select the **Code Engineering | Reset DBMS Options** menu option. The **Manage DBMS Options** dialog displays.

3. In the **New Owner** field, type the name for the new table owner.
4. In the **Current Owner** field, click on the drop-down arrow and select the current owner to change, or select **<All>** to change the ownership of all tables in the package to the name you typed in the **New Owner** field.
5. Select the **Change Table Owner** checkbox.
6. If there are child packages that also require changing, select the **Process Child Packages** checkbox.
7. Click on the **OK** button. The ownership changes for all Tables in the selected packages with the specified current owner.

For more information on setting the table owner see the [Set Table Owner](#)<sup>[1016]</sup> topic. To display the table owner in the current diagram see the [Diagram Properties](#)<sup>[423]</sup> topic.

#### 5.2.7.7.5 DBMS Datatypes

When setting up your data modeling profile, you can customize the datatypes associated with a particular DBMS using the **Database Datatypes** screen. This screen enables you to add and configure custom data types. For some data types you must add the size and precision, defaults and maximum values.

To access the **Database Datatypes** screen, select the **Settings | Database Datatypes** menu option. You can also add a DBMS product and configure the inbuilt data types.

Product Name:    Set as Default

Datatype:

Common Type:

Size

None      Default:       Max:

Length           

Precision & Scale                 

Defined Datatypes for Databases                 

Product	Datatype	Size Unit	Default	Max
MySQL	BIGINT			
MySQL	BIT			
MySQL	BLOB			
MySQL	BOOL			
MySQL	CHAR	Length	10	255
MySQL	DATE			
MySQL	DATETIME			
MySQL	DECIMAL	Precision and Scale	(10,0)	24
MySQL	DOUBLE	Precision and Scale	(10,2)	53
MySQL	DOUBLE PRE...	Precision and Scale	(10,2)	53

You can also map database datatype sizes between products. To do this, follow the steps below:

1. On the **Database Datatypes** dialog, click on the **Datatype Map** button. The **Database Datatypes Mapping** dialog displays.

Product	Datatype	Size Unit	Default	Max

2. In the **From Product Name** field, click on the drop-down arrow and select the DBMS product to map datatypes *from*. The **Defined Datatypes for Databases** panel displays all the defined datatypes for the product and, where appropriate, their sizes and values.
3. Click on the datatype to map (this must have a defined size unit and value). The **Datatype** and **Common type** fields under the **From Product Name** field display this datatype.
4. In the **To Product Name** field, click on the drop-down arrow and select the DBMS product to map datatypes *to*. The **Datatype** and **Common Type** fields under this field display the corresponding values to those in the fields for the *from* product.
5. In the **Size** panel, click on the radio button for the appropriate size unit and type the default values in the corresponding data fields.
6. Click on the **Save** button to save the mapping.
7. To map further datatypes, repeat this process from step 3.
8. When you have finished mapping datatypes, click on the **Close** button, and again on the **Database Datatypes** dialog.

## 5.2.8 XML Schema - XSD

Enterprise Architect supports rapid modeling, forward engineering and reverse engineering of W3C XML schemas (XSD). The topics in this section explain the support of [XML Technologies](#)<sup>[1039]</sup> and how to use Enterprise Architect to [model](#)<sup>[1040]</sup> XML schemas.

### 5.2.8.1 XML Technologies

Enterprise Architect enables rapid modeling, forward engineering and reverse engineering of [XML Schema](#) (XSD), a key W3C XML technology.

XSD support is critical for the development of a complete *Service Oriented Architecture* (SOA), and the coupling of UML 2.3 and XML provides the natural mechanism for specifying, constructing and deploying XML-based SOA artifacts within an organization.

### 5.2.8.2 Model XSD

XML schemas are modeled using UML [Class](#) <sup>[721]</sup> diagrams. The [XML Schema](#) <sup>[420]</sup> pages of the [Toolbox](#) provide in-built support for the [UML profile for XSD](#) <sup>[1041]</sup>. This enables an abstract UML Class model to be automatically generated as a [W3C XML Schema](#) (XSD) file.

The following Class diagram models simple schema for an example *Employee Details* system, intended to store a company's employee contact information. The Classes shown form the *EmployeeDetails* package. The UML attributes of the Classes map directly to XML elements or attributes. Note that the Classes have no methods, since there is no meaningful correspondence between Class methods and XSD constructs.

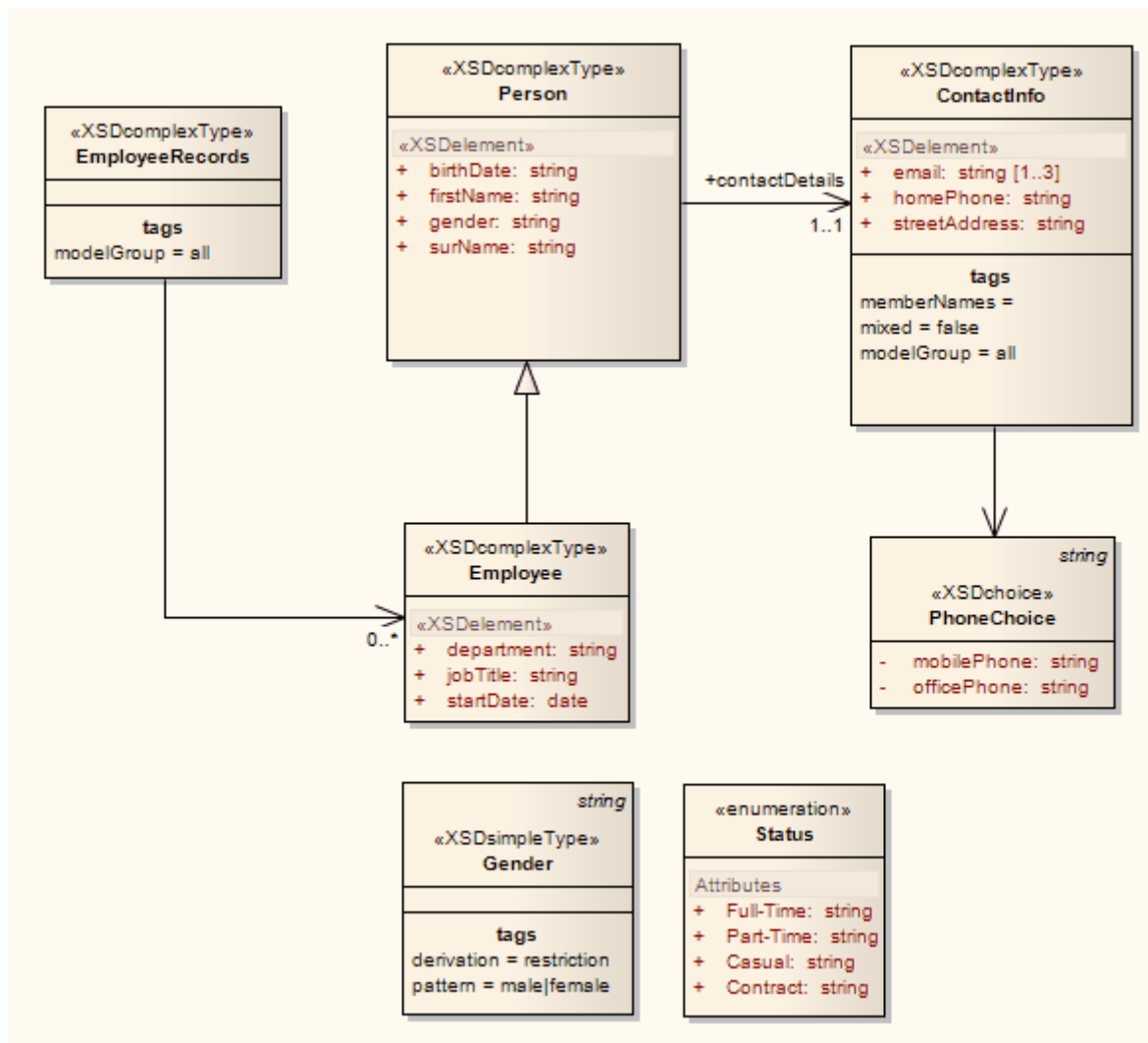

The following code shows the schema generated for the *Employee Details* package by default. Notice how each UML Class corresponds to a *complexType* definition in the schema. The Class attributes are generated as schema elements contained in a Sequence model group within the definition. The *Enumeration* Class is the exception here - it maps directly to an XSD enumeration, contained within a *simpleType* definition.

```
<?xml version="1.0"?>
<xs:schema xmlns:xs="http://www.w3.org/2001/XMLSchema">
  <xs:element name="ContactInfo" type="ContactInfo"/>
  <xs:complexType name="ContactInfo">
    <xs:sequence>
      <xs:element name="ContactInfo.homePhone" type="xs:string" maxOccurs="1"/>
      <xs:element name="ContactInfo.email" type="xs:string"/>
      <xs:element name="ContactInfo.streetAddress" type="xs:string"/>
    </xs:sequence>
  </xs:complexType>
  <xs:simpleType name="Gender" base="string">
    <xs:restriction base="string" pattern="male|female"/>
  </xs:simpleType>
  <xs:enumeration name="Status">
    <xs:attribute name="Full-Time" type="string"/>
    <xs:attribute name="Part-Time" type="string"/>
    <xs:attribute name="Casual" type="string"/>
    <xs:attribute name="Contract" type="string"/>
  </xs:enumeration>
</xs:schema>
```

```

        </xs:sequence>
    </xs:complexType>
    <xs:simpleType name="Gender">
        <xs:restriction base="xs:string">
            <xs:pattern value="male|female"/>
        </xs:restriction>
    </xs:simpleType>
    <xs:element name="Employee" type="Employee"/>
    <xs:complexType name="Employee">
        <xs:complexContent>
            <xs:extension base="Person">
                <xs:sequence>
                    <xs:element name="status" type="Status"/>
                    <xs:element name="jobTitle" type="xs:string"/>
                    <xs:element name="startDate" type="xs:date"/>
                    <xs:element name="department" type="xs:string"/>
                </xs:sequence>
            </xs:extension>
        </xs:complexContent>
    </xs:complexType>
    <xs:element name="Person" type="Person"/>
    <xs:complexType name="Person">
        <xs:sequence>
            <xs:element name="surName" type="xs:string" maxOccurs="1"/>
            <xs:element name="firstName" type="xs:string" maxOccurs="1"/>
            <xs:element name="birthDate" type="xs:string" maxOccurs="1"/>
            <xs:element name="contactDetails" type="ContactInfo"/>
        </xs:sequence>
        <xs:attribute name="gender" use="optional" type="Gender"/>
    </xs:complexType>
    <xs:element name="EmployeeRecords" type="EmployeeRecords"/>
    <xs:complexType name="EmployeeRecords">
        <xs:all>
            <xs:element name="Employee" type="Employee"/>
        </xs:all>
    </xs:complexType>
    <xs:simpleType name="Status">
        <xs:restriction base="xs:string">
            <xs:enumeration value="Full-Time"/>
            <xs:enumeration value="Part-Time"/>
            <xs:enumeration value="Casual"/>
            <xs:enumeration value="Contract"/>
        </xs:restriction>
    </xs:simpleType>
</xs:schema>

```

The following topics provide further explanation:

- [UML Profile for XSD](#)<sup>[1041]</sup>
- [XSD Datatypes Package](#)<sup>[1047]</sup>
- [Abstract XSD Models](#)<sup>[1047]</sup>

### 5.2.8.2.1 UML Profile for XSD

The UML Profile for XSD specifies a set of stereotypes, Tagged Values and constraints that can be applied to the UML model in order to change particular aspects of the resulting schema. For example, you might have to convert certain UML Class attributes to XSD attributes, or use a model group other than the default *Sequence*.

Enterprise Architect provides native support for the UML Profile for XSD via the [XML schema](#)<sup>[420]</sup> pages of the [Toolbox](#). Alternatively, you can use the profile via Enterprise Architect's generic profile mechanism by downloading the [UML Profile for XSD](#). See the [Using Profiles](#)<sup>[906]</sup> topic for details on importing UML profiles into Enterprise Architect. The XSD profile used by Enterprise Architect is an adaptation of the profile defined in *Modeling XML Applications with UML* (David Carlson).

The XSD stereotypes provide an explicit mapping from XSD to UML constructs. The Tagged Values further define aspects of the mapping, such as whether the elements should be qualified. Full information on the Tagged Values can be obtained from the [W3C XML Schema](#) recommendation. The constraints define any conditions that must be satisfied for the stereotype to apply.

The following stereotypes are provided:

- [XSDschema](#)<sup>[1042]</sup>
- [XSDcomplexType](#)<sup>[1043]</sup>

- [XSDsimpleType](#) <sup>[1043]</sup>
- [XSDsequence](#) <sup>[1044]</sup>
- [XSDchoice](#) <sup>[1044]</sup>
- [XSDelement](#) <sup>[1044]</sup>
- [XSDattribute](#) <sup>[1045]</sup>
- [XSDany](#) <sup>[1045]</sup>
- [XSDrestriction](#) <sup>[1045]</sup>
- [XSDgroup](#) <sup>[1046]</sup>
- [XSDtopLevelElement](#) <sup>[1046]</sup>
- [XSDtopLevelAttribute](#) <sup>[1046]</sup>
- [XSDunion](#) <sup>[1047]</sup>
- [XSDattributeGroup](#) <sup>[1047]</sup>

The following tables list the features of the UML Profile for XSD.

#### Notes:

- Tagged Value names are shown in bold followed by the allowed values.
- If a default value is used by Enterprise Architect's schema generator, it is underlined.

#### «XSDschema»

<b>UML Construct</b>		Package
<b>Description</b>		All Classes in a package are defined within one schema. This stereotype can be used to specify schema-wide settings.
<b>Tagged Values</b>	<b>anonymousRole:</b> (true   false)	Specifies if the role name is included in the element declaration for the UML attribute.
	<b>anonymousType:</b> (true   false)	Specifies whether the Class type is anonymous for attributes.
	<b>attributeFormDefault:</b> (qualified   <u>unqualified</u> )	Determines whether attribute instances must be qualified.
	<b>defaultNamespace:</b>	The default namespace used in this schema. This value is used to specify the default namespace attribute ( <i>xmlns=</i> ), in the schema element.
	<b>elementDerivation:</b> ( <u>true</u>   false)	Determines whether inheritances are generated using XSD extension or copy-down inheritance.
	<b>elementFormDefault:</b> (qualified   <u>unqualified</u> )	Determines whether element instances must be qualified.
	<b>memberNames:</b> ( <u>qualified</u>   unqualified)	Determines whether elements generated from Class attributes have their name qualified by the corresponding Class name.
	<b>modelGroup:</b> (all   <u>sequence</u>   choice)	Specifies the default XSD model group used to generate <i>complexType</i> definitions.
	<b>schemaLocation:</b>	The URI that identifies the location of the schema. This value is used in the import and include elements.
	<b>targetNamespace:</b>	The URI that uniquely identifies this schema's namespace.
	<b>targetNamespacePrefix:</b>	The prefix that abbreviates the <i>targetNamespace</i> .
	<b>version:</b>	The version of this schema.

<b>Constraints</b>		None.
--------------------	--	-------

### «XSDcomplexType»

<b>UML Construct</b>		Class
<b>Description</b>		<i>complexType</i> definitions are created for generic UML Classes. This stereotypes helps tailor the generation of a <i>complexType</i> definition.
<b>Tagged Values</b>	<b>memberNames:</b> (qualified   unqualified)	Determines whether elements generated from the UML Class attributes and associations have their name qualified by the corresponding Class name for this <i>complexType</i> definition.
	<b>mixed:</b> (true   <u>false</u> )	Determines whether this element can contain mixed element and character content. See the W3CXML Schema recommendation.
	<b>modelGroup:</b> (all   sequence   choice)	Overrides the default XSD model for generating this <i>complexType</i> definition.
<b>Constraints</b>		None.

### «XSDsimpleType»

<b>UML Construct</b>		Class
<b>Description</b>		An XSD <i>simpleType</i> is generated for Classes with this stereotype.
<b>Tagged Values</b>	<b>derivation:</b> ( <u>restriction</u>   list)	Specifies the derivation of the <i>simpleType</i> . See the W3C XML Schema recommendation.
	<b>length:</b>	See the W3C XML Schema recommendation.
	<b>minLength:</b>	
	<b>maxLength:</b>	
	<b>minInclusive:</b>	
	<b>minExclusive:</b>	
	<b>maxInclusive:</b>	
	<b>maxExclusive:</b>	
	<b>totalDigits:</b>	
	<b>fractionDigits:</b>	
	<b>whiteSpace:</b>	
	<b>pattern:</b>	
<b>Constraints</b>		This Class can only participate in an inheritance relation with another <i>simpleType</i> . It cannot have any attributes or own any associations; they are ignored if present.

## «XSDsequence»

<b>UML Construct</b>		Class
<b>Description</b>		The schema generator creates a sequence model group as the container for the attributes and associations owned by this Class. The model group is in turn added to the model groups of this Class respective owners.  <b>Note:</b> Tagged values specified by owners of this Class persist through to the child elements of this model group. Thus if memberNames are unqualified for a complexType, so are the children of this model group when added to that complexType.
<b>Tagged Values</b>		None.
<b>Constraints</b>		This Class must be the destination of unidirectional associations. If it is not, this Class and its connectors are ignored, possibly invalidating other model group Classes.  Inheritance relations are ignored for this Class.

## «XSDchoice»

<b>UML Construct</b>		Class
<b>Description</b>		Creates an XSD choice element. See <i>XSDsequence</i> for more details.
<b>Tagged Values</b>		None.
<b>Constraints</b>		As for <i>XSDsequence</i> .

## «XSDelement»

<b>UML Construct</b>		Attribute: <i>AssociationEnd</i>
<b>Description</b>		By applying this stereotype to a UML Class attribute or <i>AssociationEnd</i> , the corresponding UML entity is generated as an element within the parent <i>complexType</i> and not as an XSD attribute.
<b>Tagged Values</b>	<b>form:</b> (qualified   unqualified)	Overrides the schema's <i>elementFormDefault</i> value.
	<b>position:</b>	Causes the elements to be ordered within a sequence model group of the containing <i>complexType</i> . Duplicated and invalid position Tagged Values are ignored and result in undefined ordering of the UML attributes. Missing position values cause the defined positions to be allocated as specified, with the remaining elements filling the missing positions in an undefined order.
	<b>anonymousRole:</b> (true   false)	Specifies if the role name is included in the element declaration for the UML attribute.
	<b>anonymousType:</b>	Specifies whether the Class type is anonymous for attributes.



	(true   false)	
	<b>default</b>	See the W3C XML Schema recommendation.
	<b>fixed</b>	
<b>Constraints</b>		None.

## «XSDattribute»

<b>UML Construct</b>		Attribute: <i>AssociationEnd</i>
<b>Description</b>		By applying this stereotype to a UML Class attribute or <i>AssociationEnd</i> , the corresponding UML entity is generated as an XSD attribute within the parent <i>complexType</i> and not as an XSD element.
<b>Tagged Values</b>	<b>form:</b> (qualified   unqualified)	Overrides the schema's <i>attributeFormDefault</i> value.
	<b>use:</b> (prohibited   <u>optional</u>   required)	See the W3C XML Schema recommendation.
	<b>default</b>	
	<b>fixed</b>	
<b>Constraints</b>		The attribute <i>datatype</i> should not see a Class specification, otherwise it is ignored.

## «XSDany»

<b>UML Construct</b>		Class: <i>Attribute</i>
<b>Description</b>		If applied to a UML attribute, an XSD <i>anyAttribute</i> element is generated. If applied to a UML Class, an XSD <i>any</i> element is generated.
<b>Tagged Values</b>	<b>namespace:</b>	See the W3C XML Schema recommendation.
	<b>processContents:</b> (skip   lax   <u>strict</u> )	
<b>Constraints</b>		None.

## «XSDrestriction»

<b>UML Construct</b>		Generalization
<b>Description</b>		Overrides the default use of XSD extension for inheritance and generates the child as a <i>complexType</i> with a restriction element instead.
<b>Tagged Values</b>		None.

<b>Constraints</b>		Applies only to UML Class parent-child relations.
--------------------	--	---

### «XSDgroup»

<b>UML Construct</b>		Class
<b>Description</b>		An <i>XSDgroup</i> is generated for Classes with this stereotype.
<b>Tagged Values</b>	<b>modelGroup:</b> ( <u>sequence</u>   choice   all)	Overrides the default XSD model for generating this group definition.
<b>Constraints</b>		A group Class can only associate itself to other group Classes. A group Class can be associated by another group Class or a <i>complexType</i> Class. The association should be via an Association connector. A group Class cannot be inherited/aggregated.

### «XSDtopLevelElement»

<b>UML Construct</b>		Class
<b>Description</b>		Creates an <i>&lt;xs:element&gt;</i> construct which acts as a container for <i>XSDcomplexType</i> and <i>XSDsimpleType</i> Class.
<b>Tagged Values</b>	<b>default</b>	See the W3C XML Schema recommendation.
	<b>fixed</b>	
<b>Constraints</b>		An <i>XSDtopLevelElement</i> Class can contain either an <i>XSDsimpleType</i> or an <i>XSDcomplexType</i> as its child Class. When such a Class is present as its child, all its inheritance is ignored. This Class cannot be inherited.

### «XSDtopLevelAttribute»

<b>UML Construct</b>		Class
<b>Description</b>		Creates an <i>&lt;xs:attributr&gt;</i> construct which acts as a container for <i>XSDsimpleType</i> Class.
<b>Tagged Values</b>	<b>use:</b> ( <u>optional</u>   required   prohibited)	See the W3C XML Schema recommendation.
	<b>default</b>	
	<b>fixed</b>	
<b>Constraints</b>		An <i>XSDtopLevelAttribute</i> Class can contain only an <i>XSDsimpleType</i> Class as its child Class. When such a Class is present as its child, all its inheritance is ignored. This Class can inherit from only one <i>XSDsimpleType</i> Class.

## «XSDunion»

<b>UML Construct</b>		Class
<b>Description</b>		Creates an <code>&lt;xs:union&gt;</code> construct which can act as a container for <i>XSDsimpleType</i> Class.
<b>Tagged Values</b>		None
<b>Constraints</b>		An <i>XSDunion</i> Class can contain only <i>XSDsimpleType</i> as its child Class and can generalize from other <i>XSDsimpleType</i> Classes only. All the Classes that this Class generalizes become the members of the attribute <i>memberTypes</i> . This Class cannot have any attributes or associations.

## «XSDatatributeGroup»

<b>UML Construct</b>		Class
<b>Description</b>		Creates an <code>&lt;XSDatatributeGroup&gt;</code> construct which can act as a container for a set of elements for stereotype <i>XSDatatribute</i> .
<b>Tagged Values</b>		None
<b>Constraints</b>		An <i>XSDatatributeGroup</i> Class can contain only elements of stereotype <i>XSDatatribute</i> and can be associated only with other <i>XSDatatributeGroup</i> Classes. Only <i>XSDcomplexType</i> Classes can associate with this Class. This Class cannot be inherited.

## 5.2.8.2.2 XSD Datatypes Package

When modeling XSD constructs, it is often useful to have the XSD primitive types represented as UML elements. In this way user-defined types, for example, can reference the datatype elements as part of inheritance or association relationships.

Sparx Systems provides the set of primitive XSD data types as a UML package in the form of an XMI file. Each of the XSD primitive types is represented by a UML Class in a package named *XSDDatatypes*. To import the *XSDDatatypes* package into your model, follow the steps below:

1. Download the *XSDDatatypes* package using the following link: [XSDDatatypes Package](#). The file *XSDDataTypes.xml* is an XMI file.
2. Use Enterprise Architect's [XMI import](#)<sup>[290]</sup> facility, which is available via the **Project | Import/Export | Import Package from XMI** menu option.
3. When the XMI import is complete, you have the UML package named *XSDDatatypes* in your model, from which you can drag and drop the relevant types as required.

## 5.2.8.2.3 Abstract XSD models

XML schemas can be modeled using simple, abstract Class models. This can be useful in enabling an architect to start work at a higher level of abstraction, without concern for the implementation details of a schema. Such an abstract model can be refined further using the [XML Schema](#)<sup>[420]</sup> pages of the **Toolbox**, or it can be generated directly by Enterprise Architect's [schema generator](#)<sup>[1376]</sup>. In this case, a set of [default mappings](#)<sup>[1049]</sup> is assumed by the schema generator to convert the abstract model to an XSD file.

The following is a simplified version of the *Employee Details* example model, which does not use XSD-specific stereotypes or Tagged Values.

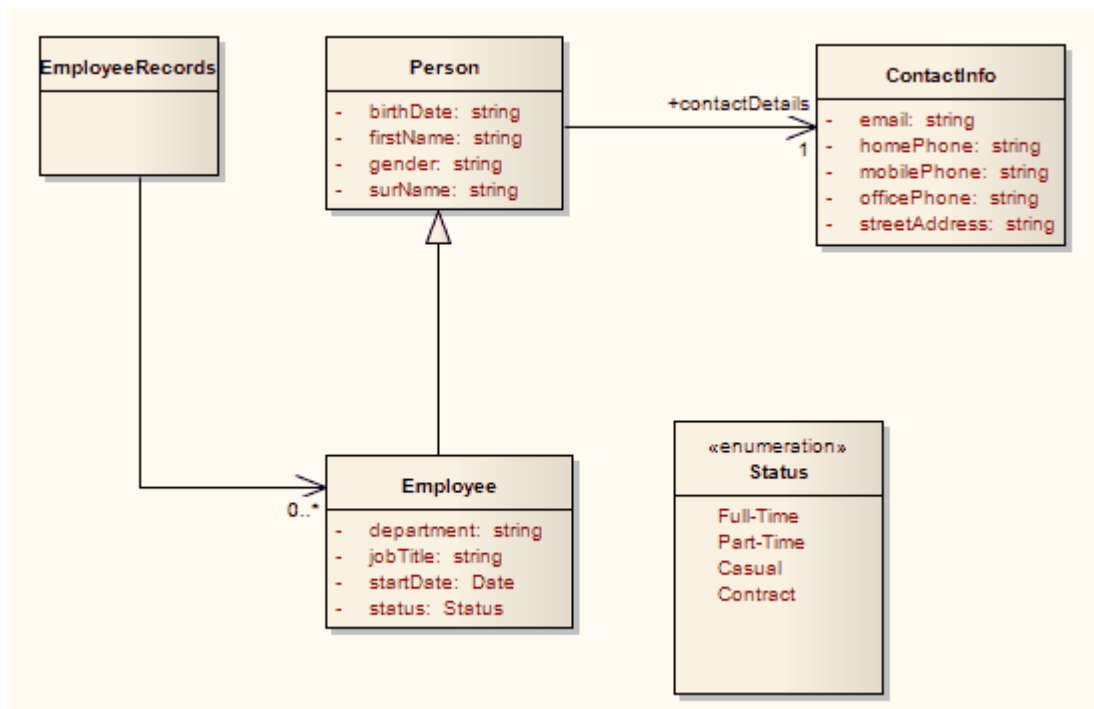

The following schema fragment would be generated by Enterprise Architect, given the above model.

```

<?xml version="1.0"?>
<xs:schema xmlns:xs="http://www.w3.org/2001/XMLSchema">
  <xs:simpleType name="Status">
    <xs:restriction base="xs:string">
      <xs:enumeration value="Full-Time"/>
      <xs:enumeration value="Part-Time"/>
      <xs:enumeration value="Casual"/>
      <xs:enumeration value="Contract"/>
    </xs:restriction>
  </xs:simpleType>
  <xs:element name="Person" type="Person"/>
  <xs:complexType name="Person">
    <xs:sequence>
      <xs:element name="firstName" type="xs:string"/>
      <xs:element name="surName" type="xs:string"/>
      <xs:element name="birthDate" type="xs:string"/>
      <xs:element name="gender" type="xs:string"/>
      <xs:element name="contactDetails" type="ContactInfo"/>
    </xs:sequence>
  </xs:complexType>
  <xs:element name="Employee" type="Employee"/>
  <xs:complexType name="Employee">
    <xs:complexContent>
      <xs:extension base="Person">
        <xs:sequence>
          <xs:element name="status" type="Status"/>
          <xs:element name="jobTitle" type="xs:string"/>
          <xs:element name="startDate" type="xs:date"/>
          <xs:element name="department" type="xs:string"/>
        </xs:sequence>
      </xs:extension>
    </xs:complexContent>
  </xs:complexType>
  <xs:element name="EmployeeRecords" type="EmployeeRecords"/>
  <xs:complexType name="EmployeeRecords">
    <xs:sequence>
      <xs:element name="Employee" type="Employee" minOccurs="0" maxOccurs="unbounded"/>
    </xs:sequence>
  </xs:complexType>
  <xs:element name="ContactInfo" type="ContactInfo"/>
  <xs:complexType name="ContactInfo">
    <xs:sequence>
      <xs:element name="homePhone" type="xs:string"/>
    </xs:sequence>
  </xs:complexType>
</xs:schema>

```

```

        <xs:element name="mobilePhone" type="xs:string"/>
        <xs:element name="officePhone" type="xs:string"/>
        <xs:element name="email" type="xs:string"/>
        <xs:element name="streetAddress" type="xs:string"/>
    </xs:sequence>
</xs:complexType>
</xs:schema>

```

### 5.2.8.2.3.1 Default UML to XSD Mappings

The following table describes the default mapping of UML to XSD constructs. This set of mappings is useful when defining simple schemas from abstract Class models. The defaults are also assumed by the schema generator when generating unsteretyped elements in an abstract model. The [XML Schema](#) pages of the [Toolbox](#) (and UML Profile for XSD) override these default mappings through the use of stereotypes and Tagged Values.

UML Construct	Default XSD Production Rules
<b>Package</b>	<p>A schema element is generated for the target package. If the target package includes Classes from another package, which has the Tagged Values <i>targetNamespace</i> and <i>targetNamespacePrefix</i> set, these are included as attributes of the schema element.</p> <p>In addition, an <i>import</i> or <i>include</i> element is created for each referenced package. (An <i>include</i> element is used if the external package shares the same <i>targetNamespace</i> Tagged Value as the target package. An <i>import</i> element is used where the <i>targetNamespaces</i> differ).</p>
<b>Class</b>	<p>A root-level element declaration and <i>complexType</i> definition are generated. The element name and type are the same as the Class name. An XSD sequence model group is generated to contain UML attributes generated as elements.</p>
<b>Attribute</b>	<p>An element is declared for each Class attribute. The element name is set to that of the UML attribute name. This is prefixed with the Class name to make the element unique. The <i>minOccurs</i> and <i>maxOccurs</i> attributes are set to reflect the attribute cardinality.</p> <p><b>Note:</b></p> <p>If left unspecified, <i>minOccurs</i> and <i>maxOccurs</i> default to 1.</p> <p>If the attribute refers to another Class, the element declaration is followed a <i>complexType</i> definition, which contains a reference to the appropriate <i>complexType</i>.</p>
<b>Association</b>	<p>An element is declared for each association owned by a Class. The element name is set to that of the association role. The <i>minOccurs</i> and <i>maxOccurs</i> reflect the cardinality of the association.</p> <p><b>Note:</b></p> <p>If the direction of the association is unspecified, the owner is assumed to be the source.</p>
<b>Generalization (Inheritance)</b>	<p>For single inheritances, an extension element is generated with the base attribute set to the base Classname. The UML attributes of the child Class are then appended to an all model group within the extension element.</p>
<b>«enumeration» (stereotype)</b>	<p>A <i>simpleType</i> element is declared for the enumeration Class with the name attribute set to the Classname. A restriction element is generated with base set to string. Each of the Class attributes is appended to the restriction element as XSD enumeration elements with value set to the UML attribute name. Any type specification for the UML attributes is ignored by the schema generator.</p>

## 5.2.9 Web Services - WSDL

Enterprise Architect enables rapid modeling, forward engineering and reverse engineering of [Web Service Definition Language](#) (WSDL), a key W3C XML technology.

WSDL support is critical for the development of a complete *Service Oriented Architecture* (SOA), and the coupling of UML 2.3 and XML provides the natural mechanism for specifying, constructing and deploying XML-based SOA artifacts within an organization. This section explains how to use Enterprise Architect to

[model WSDL](#) <sup>[1050]</sup> files.

### 5.2.9.1 Model WSDL

The [WSDL pages](#) <sup>[420]</sup> of the **Toolbox** can be used to conveniently model WSDL documents. WSDL documents are represented as components marked with the stereotype *WSDL*. WSDL documents are contained in a package hierarchy representing the target WSDL namespace and its constituent *XSD Types*, *Messages*, *PortTypes*, *Bindings* and *Services*. The top-level package is stereotyped as a *WSDLnamespace*. The figure below shows a WSDL namespace package structure:

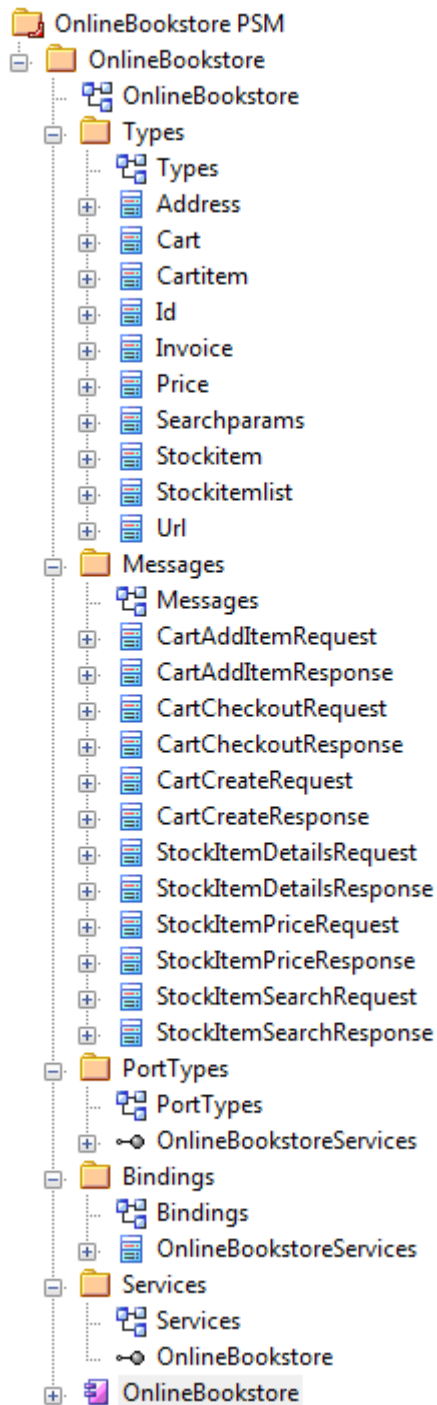

A *WSDLnamespace* package can contain one or more WSDL components. Each WSDL component can be automatically generated to a WSDL file using Enterprise Architect's built in [WSDL generator](#) <sup>[1379]</sup>. The following topics describe the various WSDL elements and features supported by Enterprise Architect:

- [WSDL Namespace](#) <sup>[1051]</sup>
- [WSDL Document](#) <sup>[1053]</sup>
- [WSDL Service](#) <sup>[1054]</sup>
- [WSDL Port Type](#) <sup>[1056]</sup>
- [WSDL Message](#) <sup>[1056]</sup>
- [WSDL Binding](#) <sup>[1057]</sup>
- [WSDL Port Type Operation](#) <sup>[1059]</sup>
- [WSDL Message Part](#) <sup>[1060]</sup>

#### 5.2.9.1.1 WSDL Namespace

The WSDL namespace in Enterprise Architect represents the top-level container for the WSDL elements, including WSDL documents. Conceptually it maps to the *targetNamespace* in a WSDL definition element. A given WSDL namespace can reuse its schema Types, Messages, Port Types, Bindings and Service across multiple physical WSDL documents.

The figure below shows an example WSDL namespace (*OnlineBookstore PSM*, which has a red margin to the bottom right corner), including a single WSDL document:

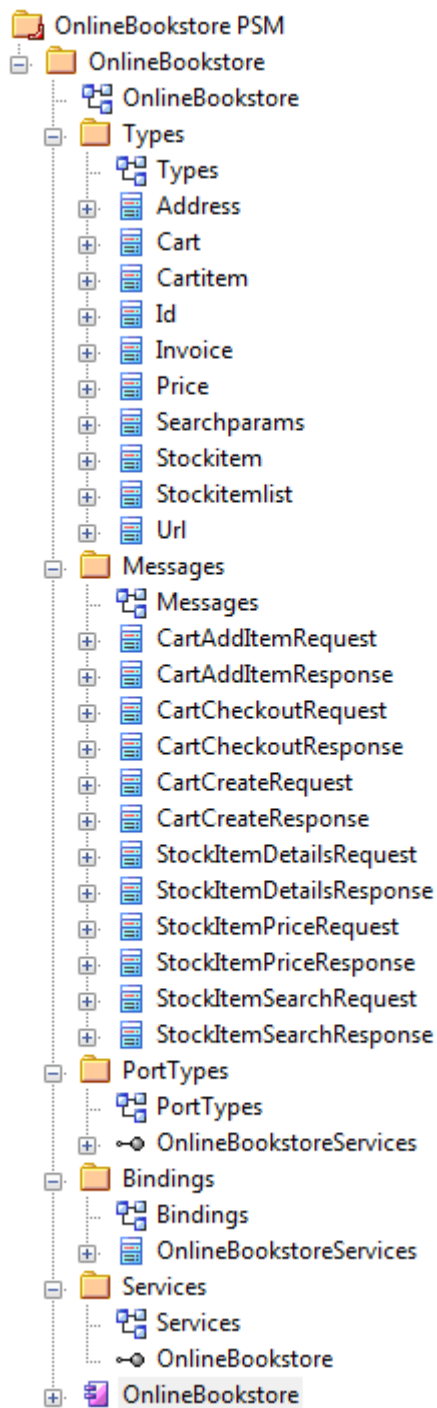

To create a new WSDL namespace in your model, follow the steps below.

1. Open or create the appropriate diagram.
2. Select the **More Tools | WSDL** menu option from the **Toolbox**.
3. Drag the *Namespace* element from the **Toolbox** onto the diagram. The **WSDL Namespace Properties** dialog displays:



WSDL Package Name :

Target Namespace :

OK Cancel Help

- Type in a **WSDL Package Name** and **Target Namespace** name. You can edit these values later.
- Click on the **OK** button to create a package stereotyped as *WSDLnamespace*. This contains the following sub-packages and an Overview diagram to navigate between the sub-packages:
  - Types:** Contains the XSD types used by the WSDL *Message* elements; this package is modeled as an [XML Schema](#) <sup>[1040]</sup>, and you drag [XSDelement](#) <sup>[1044]</sup>, [XSDsimpleType](#) <sup>[1043]</sup> and [XSDcomplexType](#) <sup>[1043]</sup> elements onto the Types diagram from the [XML Schema](#) <sup>[420]</sup> [page](#) <sup>[420]</sup> of the **Toolbox**
  - Messages:** Contains the WSDL *Messages*, modeled as UML Classes marked with the stereotype *WSDLmessage*
  - PortTypes:** Contains the WSDL *Port Types*, modeled as UML interfaces marked with the stereotype *WSDLportType*
  - Bindings:** Contains the WSDL *Bindings*, modeled as UML Classes that realize the *PortTypes*
  - Services:** Contains the WSDL *Services*, modeled as UML interfaces with associations to each exposed *Binding*.
- Use the Overview diagram to navigate between the subpackages, by double-clicking the relevant packages. You can edit the sample WSDL elements created in the previous step, or drag new items from the **WSDL** pages of the **Toolbox** onto the relevant diagrams.

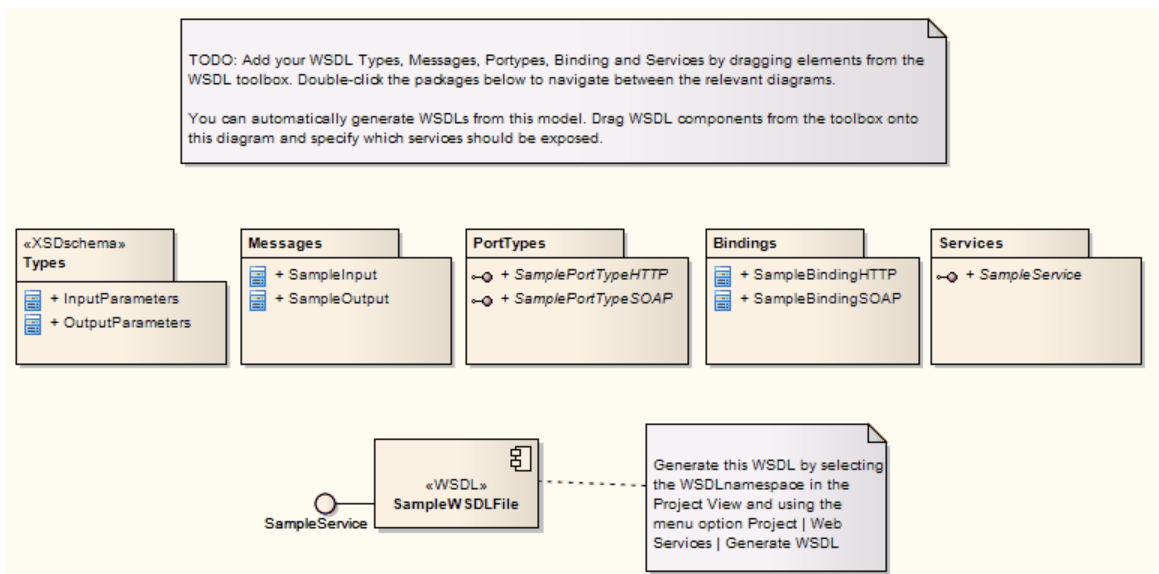

You can edit the WSDL-specific properties of the namespace later by double-clicking the package in the **Project Browser**. Alternatively, on the **WSDL Namespace Properties** dialog, click on the **UML** button to invoke the standard **Properties** dialog for a package. (This button does not display on the initial **WSDL Namespace Properties** dialog for a new Namespace element.)

### 5.2.9.1.2 WSDL Document

WSDL documents are represented in Enterprise Architect by UML components stereotyped as *«WSDL»*. These components are modeled as direct child elements of the top-level WSDL namespace package. You can create multiple WSDL documents for a single namespace, thus enabling the services for that namespace to be reused and exposed as required across multiple WSDLs.

To define new WSDL document components for your namespace, follow the steps below:

- Open the Overview diagram defined for your WSDL namespace package, and drag the *WSDL* element from the **Toolbox** onto the diagram. The **WSDL Document Properties** dialog displays.

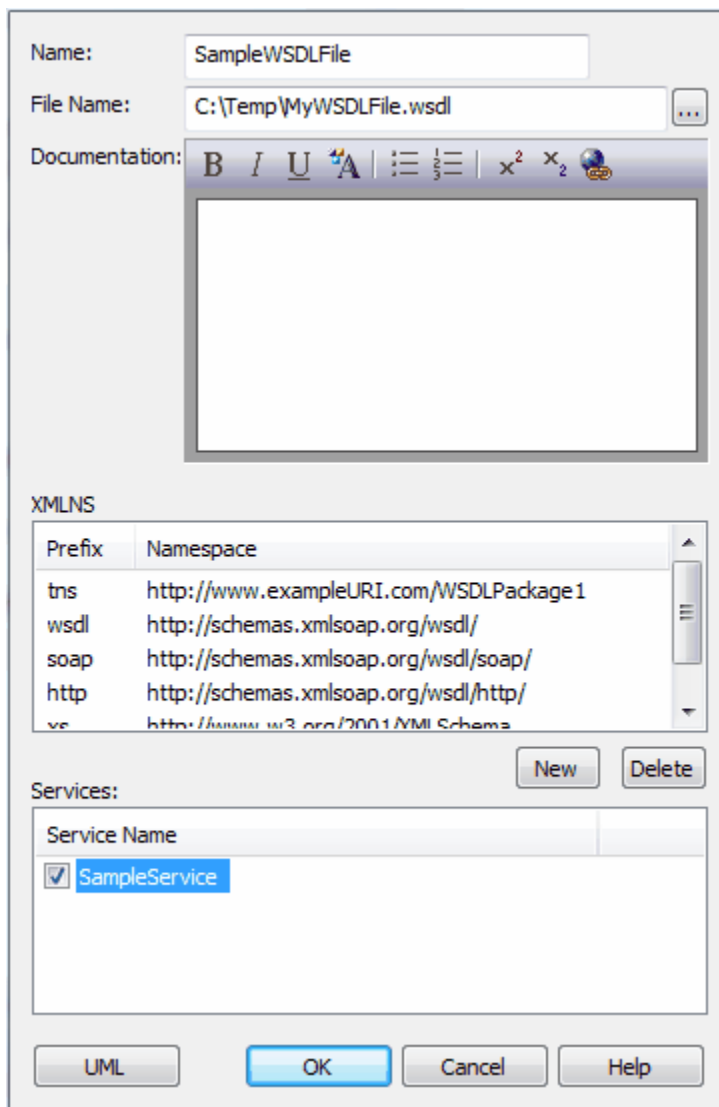

2. Type in the **Name** and **File Name** for the document.
3. The **XMLNS** panel lists the default XML namespaces used by the document. If required, click on the **New** button to add further namespaces.

**Note:**

You can also delete any namespace entries that you add. It is recommended that you do not delete any of the default entries, as it may cause an invalid WSDL document to be generated.

4. Select one or more services that should be exposed by this document. The list of available services is populated from the [Services package](#) [1054].
5. Click on the **OK** button.

You can edit the WSDL-specific properties of the document later by double-clicking the component in the diagram or the **Project Browser**. Alternatively, click on the **UML** button in the **WSDL Document Properties** dialog to invoke the standard **Properties** dialog for a package. (This button does not display on the initial **WSDL Document Properties** dialog for a new WSDL element.)

### 5.2.9.1.3 WSDL Service

WSDL services are represented in Enterprise Architect by UML interfaces, stereotyped as *WSDLservice*. Services should be defined under the Services packages in the WSDL namespace structure.

To define new *WSDLservice* elements for your namespace, follow the steps below:

1. Open the Overview diagram defined for your WSDL namespace package, and double-click on the

Services package element to open the Services diagram.

2. Drag the **Service** element from the **Toolbox** onto the diagram. The **WSDL Service** dialog displays.

The screenshot shows the 'WSDL Service' dialog box. At the top, the 'Name' field is filled with 'SampleService'. Below it is a 'Documentation' field with a rich text editor toolbar. The 'Ports' section features a table with the following data:

Port Name	Binding	Location
SamplePortHTTP	SampleBindingHTTP	http://www.exampleL
SamplePortSOAP	SampleBindingSOAP	http://www.exampleL

Buttons for 'New' and 'Delete' are located above the table. At the bottom of the dialog are buttons for 'UML', 'OK', 'Cancel', and 'Help'.

3. In the **Name** field, type the service name.
4. Click on the **New** button to add Service Ports. The **WSDL Port** dialog displays.

The screenshot shows the 'WSDL Port' dialog box. The 'Port Name' field contains 'Port1'. The 'Binding' dropdown menu is set to 'SampleBindingHTTP'. The 'Location' field contains 'www.exampleLocation.com/Port1'. The 'Documentation' field is empty. At the bottom are buttons for 'OK', 'Cancel', and 'Help'.

5. Type in the **Port Name** and **Location**, and select a **Binding**. The list of Bindings is taken from those defined in the [Bindings package](#) <sup>1057</sup>.
6. Click on the **OK** button to close the **WSDL Port** dialog. For each Port defined in this way, Enterprise Architect creates an Association relationship between the Service and corresponding *Binding* element.
7. Click on the **OK** button to close the **WSDL Service** dialog.

You can edit the WSDL-specific properties of the service later by double-clicking the Service interface in the diagram or **Project Browser**. Alternatively, click on the **UML** button in the **WSDL Service** dialog to invoke the standard **Properties** dialog for an interface. (This button does not display on the initial **WSDL Service** dialog for a new Service element.)

#### 5.2.9.1.4 WSDL Port Type

WSDL *Port Types* are represented in Enterprise Architect by UML interfaces stereotyped as *WSDLportType*. PortTypes should be defined under the *PortTypes* packages in the WSDL namespace structure.

To define new WSDLportType elements for your namespace, follow the steps below:

1. Open the Overview diagram defined for your WSDL namespace package, and double-click on the PortTypes package to open the PortTypes diagram.
2. Drag the *Port Type* element from the **Toolbox** onto the diagram. The **WSDL PortType** dialog displays.

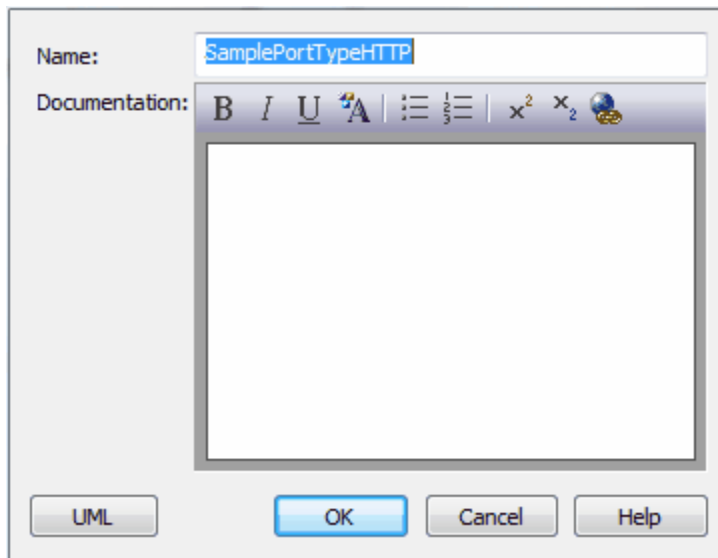

3. Type in the name for the portType.
4. Click on the **OK** button to close the **WSDL PortType** dialog.
5. Define operations for the portType by dragging the **Port Type Operation** <sup>[1059]</sup> item from the **WSDL** page of the **Toolbox** onto the portType interface.

You can edit the WSDL-specific properties of the portType later by double-clicking the interface in the diagram or **Project Browser**. Alternatively, in the **WSDL PortType** dialog, click on the **UML** button to invoke the standard **Properties** dialog for an interface. (This button does not display on the initial **WSDL PortType** dialog for a new PortType element.)

#### 5.2.9.1.5 WSDL Message

WSDL messages are represented in Enterprise Architect by UML Classes stereotyped as *WSDLmessage*. Messages should be defined under the *Messages* package in the WSDL namespace structure.

To define new WSDLmessage elements for your namespace, follow the steps below:

1. Open the Overview diagram defined for your WSDL namespace package, and double-click on the Messages package to open the Messages diagram.
2. Drag the *Message* element from the **Toolbox** onto the diagram. The **WSDL Message** dialog displays.

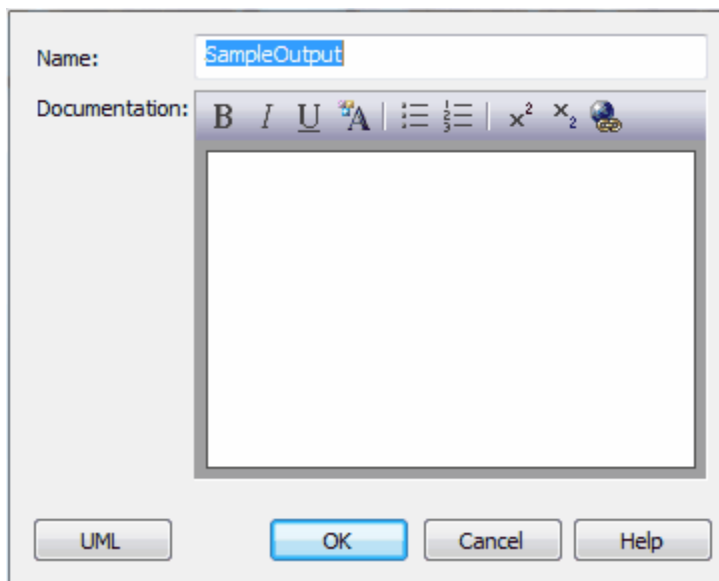

3. Type in the **Name** for the message.
4. Click on the **OK** button to close the **WSDL Message** dialog.
5. You can define parts for the message by dragging the [Message Part](#)<sup>[1060]</sup> element from the **WSDL Elements** page of the **Toolbox** onto the Message element.

You can edit the WSDL-specific properties of the message later by double-clicking the Message element in the diagram or **Project Browser**. Alternatively, on the **WSDL Message** dialog, click on the **UML** button to invoke the standard **Properties** dialog for a Class. (This button does not display on the initial **WSDL Message** dialog for a new Message element.)

#### 5.2.9.1.6 WSDL Binding

WSDL bindings are represented in Enterprise Architect by UML Classes stereotyped as *WSDLbinding*. Bindings should be defined under the Bindings package in the WSDL namespace structure. Each *WSDLbinding* Class implements the operations specified by a particular *WSDLportType* interface. Therefore, [WSDLportTypes should be defined before](#)<sup>[1056]</sup> creating *WSDLbindings*.

To define new *WSDLbinding* elements for your namespace, follow the steps below:

1. Open the Overview diagram defined for your WSDL namespace package, and double-click on the Bindings package to open the Bindings diagram.
2. Drag the *Binding* element from the **Toolbox** onto the diagram. The **WSDL Binding** dialog displays.

Name:

PortType:

Protocol:

Transport:

Style:

Verb:

Documentation:   
B I U A | | | x<sup>2</sup> x<sub>2</sub>

3. Type in a **Name** for the Binding.
4. Select the **PortType** for the Binding; the drop-down list of PortTypes is taken from those defined in the PortTypes package.
5. Select the **Protocol** for the Binding, either **http** or **soap**.
6. For SOAP Bindings, enter the **Transport** URL and select the **Style**. For http Bindings, select the **Verb**.
7. Click on the **OK** button to close the **WSDL Binding** dialog and create the binding. A *realization* connector is created between the binding and the corresponding *Port Type* interface.
8. To specify the Binding operations, select and double-click on an Operation in the Binding element. The **WSDL Binding Operation Details** dialog displays.

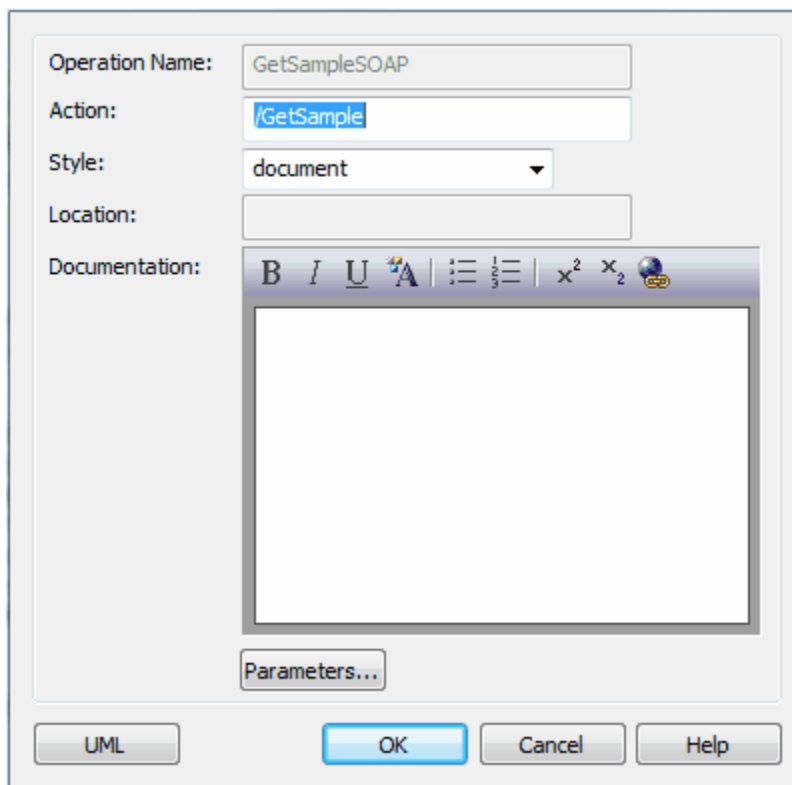

9. Type in or select the Binding Operation details.
10. Click on the **Parameters** button. The **WSDL Binding Operation Parameters** dialog displays. For each input, output and fault, click on the **Details** button and enter the details.
11. Click on the **OK** button on each of the **WSDL Binding Parameter Details**, **WSDL Binding Operation Parameters** and **WSDL Binding Operation Details** dialogs to close them.

You can edit the WSDL-specific properties of the binding later by double-clicking the binding Class in the diagram or **Project Browser**. Alternatively, on the **WSDL Binding** dialog, click on the **UML** button to invoke the standard **Properties** dialog for a Class. (This button does not display on the initial **WSDL Binding** dialog for a new Binding element.)

#### 5.2.9.1.7 WSDL Port Type Operation

WSDL portType operations are represented in Enterprise Architect by operations defined as part of a WSDLportType interface (see the [WSDL Port Type](#) <sup>[1058]</sup> topic).

To add portType operations to your WSDLportType interfaces, follow the steps below.

1. Open the Overview diagram defined for your WSDL namespace package, and double-click on the PortTypes package to open the PortTypes diagram.
2. Drag the *PortType Operation* item onto a WSDLPortType stereotyped interface. The **WSDL PortType Operation** dialog displays.

The screenshot shows the 'WSDL PortType Operation' dialog box. It has the following fields and controls:

- Name:** GetSampleSOAP
- Documentation:** A rich text editor with a toolbar containing Bold (B), Italic (I), Underline (U), Text Color (A), Bulleted List, Numbered List, Indent, Outdent, Superscript (x<sup>2</sup>), Subscript (x<sub>2</sub>), and a globe icon.
- Operation Type:** Request-Response (dropdown menu)
- Input:**
  - Name:** Request
  - Message:** SampleInput (dropdown menu)
  - Documentation:** Text area with scrollbars
- Output:**
  - Name:** Response
  - Message:** SampleOutput (dropdown menu)
  - Documentation:** Text area with scrollbars
- Faults:**
  - Buttons: New, Delete
  - Table:

Fault Name	Type

At the bottom are buttons for 'UML', 'OK', 'Cancel', and 'Help'.

3. Type in the **Name** for the operation.
4. Select the **Operation Type**.
5. Type in or select the **Input**, **Output** and **Fault** details for the operation. The **Message** drop-down list is taken from the WSDLmessage elements defined under the Messages package.
6. Click on the **OK** button to close the **WSDL PortType Operation** dialog and create the operation.

You can edit the WSDL-specific properties of the portType operation later by double-clicking the operation in the diagram or **Project Browser**. Alternatively, on the **WSDL PortType Operation** dialog, click on the **UML** button to invoke the standard **Properties** dialog for an operation. (This button does not display on the initial **WSDL PortType Operation** dialog for a new PortType Operation.)

#### 5.2.9.1.8 WSDL Message Part

WSDL message parts are represented in Enterprise Architect by UML attributes defined as part of a WSDLmessage Class (see the [WSDL Message](#)<sup>[1056]</sup> topic).

To add message parts to your WSDLmessage Classes, follow the steps below:

1. Open the Overview diagram defined for your WSDL namespace package, and double-click on the Messages package to open the Messages diagram.
2. Drag the *Message Part* element onto a WSDLmessage stereotyped Class. The **WSDL Message Part**



dialog displays.

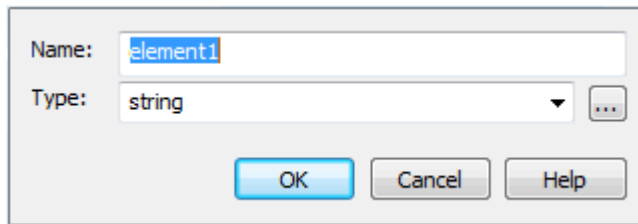

3. Type in a **Name** and **Type** for the message part. The type should be selected from the drop-down list of primitive XSD types or from the types defined under the Types package.
4. Click on the **OK** button.

You can edit the WSDL-specific properties of the message part later by double-clicking the attribute in the diagram or **Project Browser**. Alternatively, on the **WSDL Message Part** dialog, click on the **UML** button to invoke the standard **Properties** dialog for an attribute. (This button does not display on the initial **WSDL Message Part** dialog for a new message part attribute.)

### 5.2.10 SPEM

According to the Object Management Group (OMG) *Software & Systems Process Engineering Meta-Model Specification (Version 2.0, April 01 2008)*:

*The Software and Systems Process Engineering Meta-model (SPEM) is a process engineering meta-model as well as conceptual framework, which can provide the necessary concepts for modeling, documenting, presenting, managing, interchanging, and enacting development methods and processes. An implementation of this meta-model would be targeted at process engineers, project leads, project and program managers who are responsible for maintaining and implementing processes for their development organizations or individual projects.*

In 1999, the OMG placed a Request for Proposal concerning Software Process Engineering (SPE). In November 2002, the OMG released the Software Process Engineering Meta-model Specification 1.0. SPEM was defined as a Profile of UML, which used UML as a notation and took an object-oriented approach. To accommodate UML 2, the SPEM specification was upgraded to 2.0 in April 2008.

For more information on the concepts of SPEM, please refer to the full specification at <http://www.omg.org/spec/SPEM/2.0/PDF>.

#### SPEM in Enterprise Architect

SPEM 2.0 focuses on providing the additional information structures that you require for processes modeled with UML 2 Activities or BPMN/BPDM, to describe an actual development process.

Enterprise Architect enables you to develop SPEM diagrams quickly and simply, through use of an MDG Technology integrated with the Enterprise Architect installer. The SPEM facilities are provided in the form of:

- A SPEM diagram type, accessed through the [New Diagram](#)<sup>[422]</sup> dialog
- A set of [SPEM pages](#)<sup>[1062]</sup> in the **Toolbox**, providing SPEM elements (stereotyped UML elements)
- SPEM element and relationship entries in the [Toolbox Shortcut](#)<sup>[403]</sup> Menu and [Quick Linker](#)<sup>[474]</sup>.

#### Disable SPEM

If you prefer not to use SPEM in Enterprise Architect, you can disable it (and subsequently re-enable it) using the [MDG Technologies](#)<sup>[1069]</sup> dialog (**Settings | MDG Technologies**).

### 5.2.10.1 SPEM Toolbox Pages

You can access the SPEM pages of the **Toolbox** through the **More tools | SPEM** menu option. These pages provide the graphical SPEM elements for drawing the diagrams.

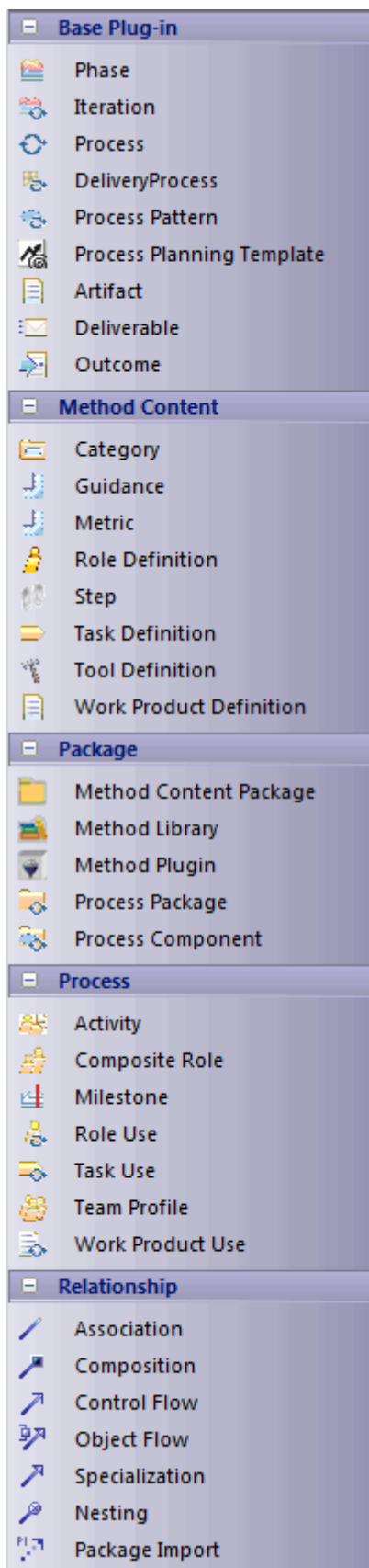

Page	Item	Use to
Base Plug-in	Phase	Create a predefined special Activity representing a significant period in a project.
	Iteration	Group a set of nested Activities that are repeated more than once. Typically, Iteration is an Activity for which the default value of the <i>isRepeatable</i> attribute is <b>True</b> .
	Process	Represent a special Activity that describes a structure for particular types of development projects, or parts of them.
	Delivery Process	Represent a special Process describing a complete and integrated approach for implementing a specific project type.
	Process Pattern	Represent a special Process to describe a reusable cluster of Activities in a general process area that provides a consistent development approach to common problems.
	Process Planning Template	Represent a special Process that is prepared for instantiation by a project planning tool.
	Artifact	Represent a Work Product Definition that provides a description and definition for tangible work product types.
	Deliverable	Represent a Work Product Definition that provides a description and definition for packaging other Work Products, and that can be delivered to an internal or external party.
	Outcome	Represent a Work Product Definition that provides a description and definition for non-tangible work products.
	Method Content	Category
Guidance		Identify reference items such as Guidelines, Templates, Checklists, Tool Mentors, Estimates, Supporting Materials, Reports and Concepts.
Metric		Define a standard measurement for instances of Method Content elements.
Role Definition		Define a set of related skills, competencies, and responsibilities.
Step		Represent parts or subunits of a Task Definition.
Task Definition		Describe an assignable unit of work. Every Task Definition is assigned to specific Role Definitions. A Task is associated with input and output Work Products.
Tool Definition		Describe the tools that are recommended or necessary for completing a specific Task.
Work Product Definition		Define any forms of document, report or outcome that are consumed, produced or modified by Tasks.
Package	Method Content Package	Create a physical container to organize the Method Content elements.
	Method Library	Create an overall physical container for all SPEM 2.0 elements.
	Method Plugin	Create a physical container for Method Content Package and Process Packages. It can be used stand-alone as well as extended to many other Method Plugins.
	Process Package	Create a physical container that contains different kinds of

Page	Item	Use to
		Process element.
	<b>Process Component</b>	Create a special Process Package that provides the mechanism of encapsulation.
<b>Process</b>	<b>Activity</b>	Define basic units of work within a Process as well as the Process itself.
	<b>Composite Role</b>	Represent an aggregation of Role Definition references for an Activity.
	<b>Milestone</b>	Represent any significant events in a development project.
	<b>Process</b>	Create a special Activity that describes a structure for particular types of development project.
	<b>Role Use</b>	Represent a Role Definition in the context of one specific Activity.
	<b>Task Use</b>	Represent a Task Definition in the context of one specific Activity.
	<b>Team Profile</b>	Define a nested hierarchy of teams and team members.
	<b>Work Product Use</b>	Represent a Work Product Definition in the context of one specific Activity.

In Enterprise Architect, every SPEM stereotype can be presented in one of two ways:

- Iconic presentation, or
- Textual presentation.

The *iconstyle* tag is used for switching between these presentations. For example, in the SPEM diagram below, if you want the *SPEM\_TaskDefinition* to have iconic presentation you set the *iconstyle* Tagged Value to **True**, and display the element as an icon. To get the textual presentation for *SPEM\_TaskDefinition*, as an outline with a decoration in the top right corner, set the Tagged Value to **False**.

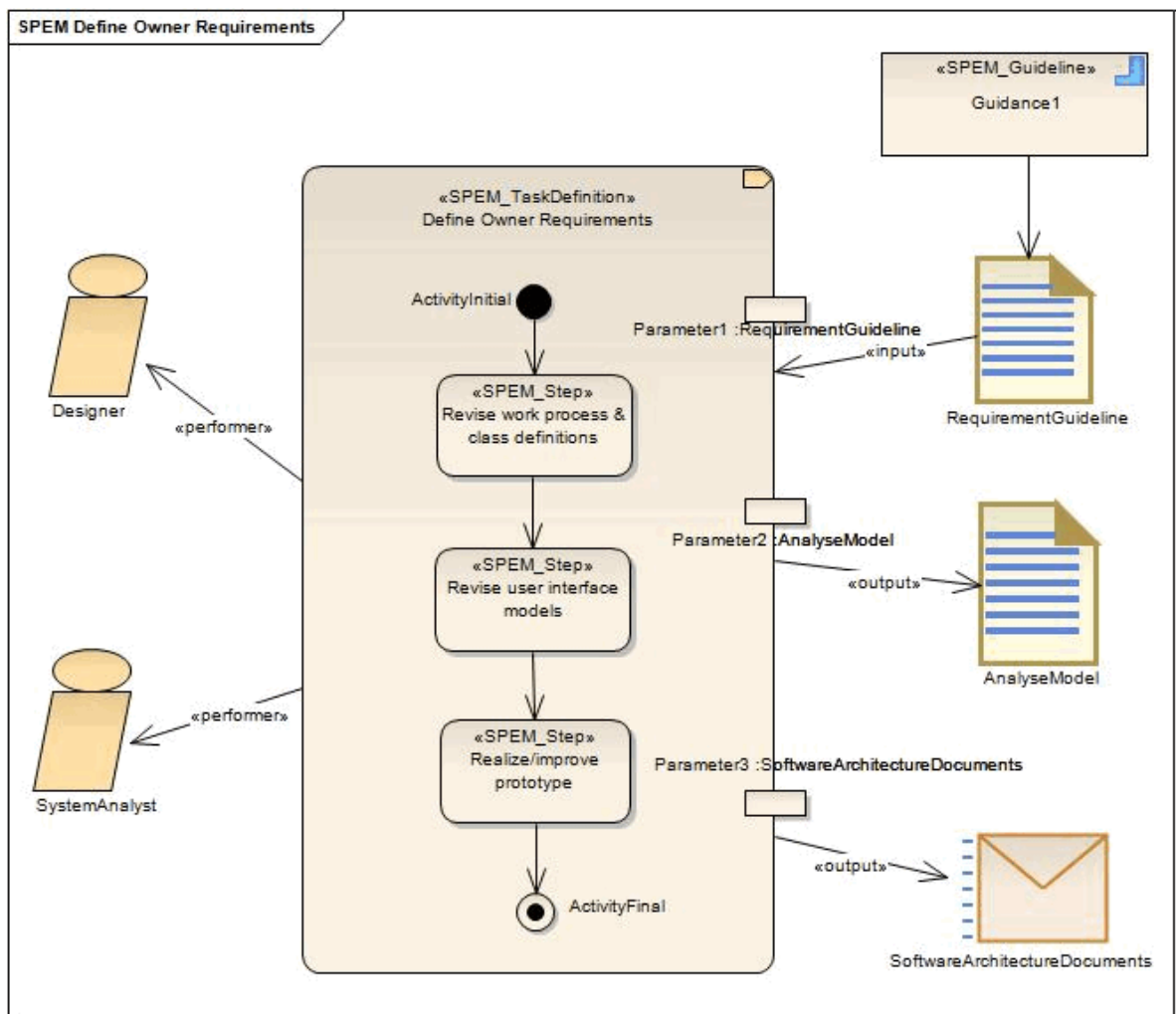

### 5.2.11 MDG Technologies - Using

The Model Driven Generation (MDG) Technologies enable you to access and use resources pertaining to a specific technology in Enterprise Architect. You have various options for bringing MDG Technologies into use with Enterprise Architect:

- Sparx Systems already provide some in the Enterprise Architect Install directory, such as [Archimate](#)<sup>[1073]</sup>, [Data Flow Diagrams](#)<sup>[1076]</sup>, [Entity Relationship Diagrams](#)<sup>[1077]</sup>, [ICONIX](#)<sup>[1084]</sup>, and [Mind Mapping](#)<sup>[1087]</sup>; you can see which technologies are available using the [MDG Technologies](#)<sup>[1069]</sup> dialog; these are available across Enterprise Architect
- You can [access and activate](#)<sup>[1070]</sup> MDG Technologies remote from Enterprise Architect, in system folders or web sites; these are available across Enterprise Architect
- Technology Developers can [create new MDG Technologies](#)<sup>[1092]</sup> and deploy them to the project team as appropriate.

You can also [import Technologies](#)<sup>[1077]</sup> into the **Resources** window for the current model only; however, this method is no longer recommended.

Having made the MDG Technologies available to Enterprise Architect, you can [manage](#)<sup>[1069]</sup> their availability to users and you can [work](#)<sup>[1067]</sup> with them.

You also have the facility to [turn off](#)<sup>[1070]</sup> or disable the Enterprise Architect basic UML and Extended **Toolbox** pages and facilities, so that you can apply the Enterprise Architect facilities and features exclusively to one or more selected MDG Technologies.

### 5.2.11.1 Work with MDG Technologies

Any MDG Technology listed on the [MDG Technologies](#) <sup>1069</sup> dialog can be enabled, which makes their interface profiles and **Toolbox** pages available for your use.

#### MDG Technology Toolbox Pages

When you enable an MDG Technology, any Technology-specific diagram types are added to the **New Diagram** dialog lists, and the Technology's **Toolbox** pages are added to those available through the **More tools** menus in the **Toolbox**.

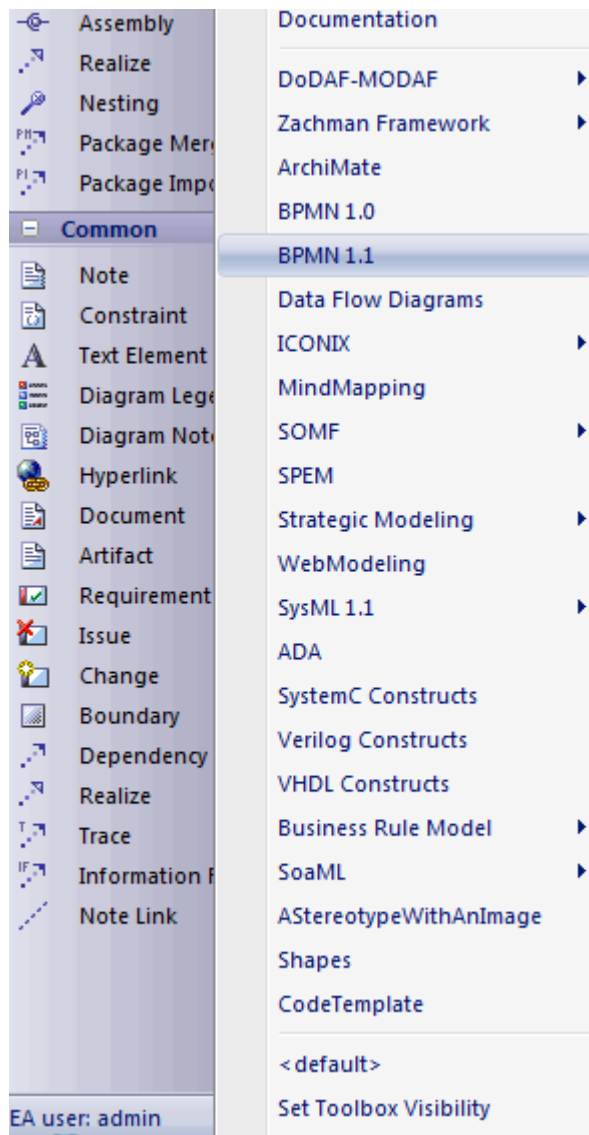

If you set the MDG Technology to *Active*, its **Toolbox** pages override any parallel Enterprise Architect **Toolbox** pages. For example, the *ICONIX Class* pages would override the Enterprise Architect *Class* pages.

You [create](#) <sup>422</sup> Technology-specific diagrams and populate them with elements and connectors in the same way as for standard Enterprise Architect diagrams.

## The Resources Window

### Note:

The method of importing MDG Technologies into the **Resources** window is available but not recommended. If you use this method, the MDG Technology **Toolbox** pages, **Tasks Pane**, **Project Browser** icons and model templates are not available.

It is now recommended that you create or download new technologies into the Enterprise Architect installation directory, or use new technologies from [remote file locations and web sites](#) <sup>[1070]</sup>.

However, you might previously have imported Technologies into the **Resources** window, and these are still available until you specifically delete them (right-click on the Technology and select the **Delete Technology** context menu option).

The **Resources** <sup>[667]</sup> window (**View | Other Element Tools | Resources**) displays a tree structure containing nodes such as imported MDG Technologies, Templates, Documents, Stylesheets, Matrix profiles and UML Profiles.

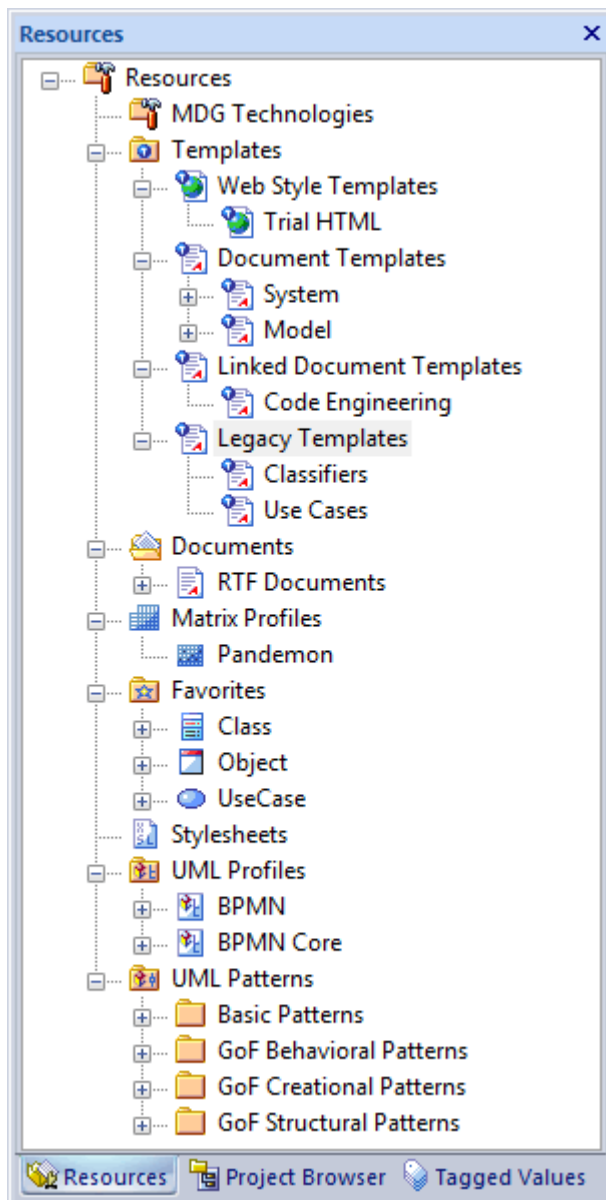

MDG Technologies can bundle the functionality provided by UML Profiles, UML Patterns, Code Templates and Model Types.



Profiles contained in MDG Technologies are applied to:

- Elements such as Classes and Interfaces, which are dragged directly from the **Toolbox** or the **Resources** window to the current diagram
- Attributes, which are dragged over a host element (such as a Class) to be automatically added to the element feature list
- Operations which, like Attributes, are dragged over a host element to add the operation
- Connectors such as Association, Generalization, and Dependency, which are added by selecting them in the **Toolbox** or **Resources** window, then clicking on the source element in a diagram and dragging to the target element (in the same way as adding normal connectors); the connector is added with the new stereotype and Tagged Value information
- Association Ends, which are added by dragging the connector end element over the end of an Association in the diagram.

Patterns contained in MDG Technologies are used to:

- Enable reuse in a model
- Build in robustness.

Code Templates are used to:

- Specify the transformation from UML elements into various parts of a given programming language.

Model Types are used to:

- Define the data types for the model.

### 5.2.11.1.1 Manage MDG Technologies

You use the **MDG Technologies** dialog to manage the MDG Technologies available and accessible to Enterprise Architect users. To display this dialog, select the **Settings | MDG Technologies** menu option.

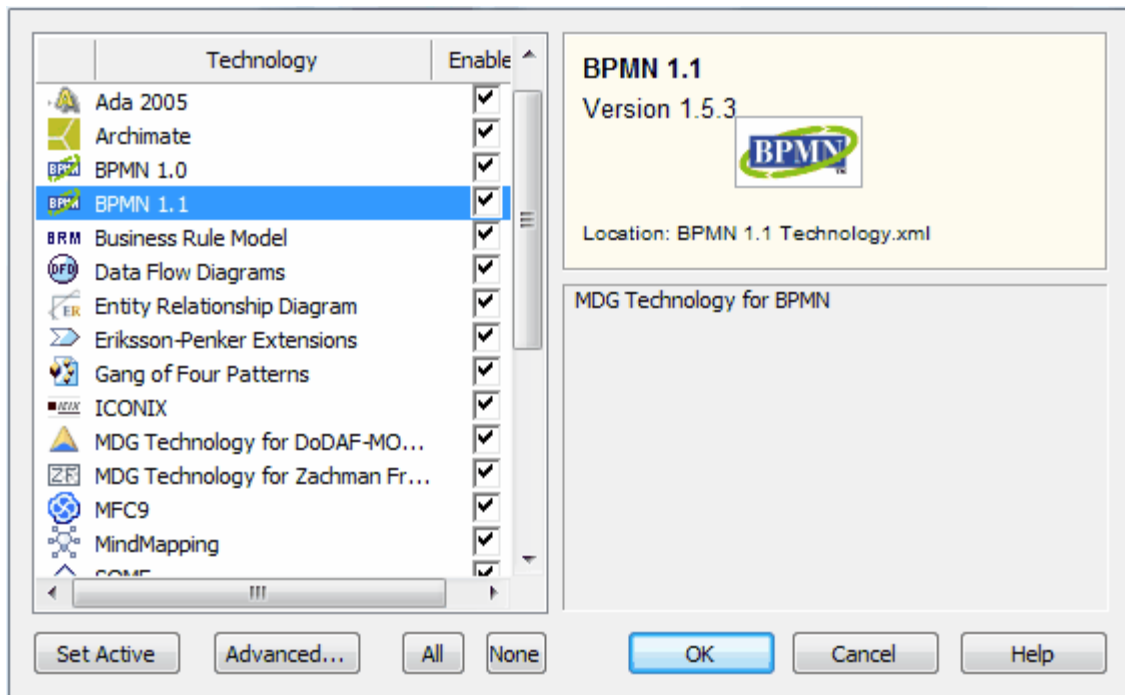

The **MDG Technologies** dialog lists the technologies held in the Enterprise Architect Install directory, in alphabetical order.

### Enable and Disable MDG Technologies

All MDG Technologies listed can be made available (enabled) or removed from use (disabled). To enable or disable a Technology, click on its **Enabled** checkbox.

When an MDG Technology is enabled, three things happen:

- The MDG Technology is added to the list of available options in the profile field of the [Default Tools](#) <sup>80</sup>

toolbar, so that you can apply the interface profiles of the MDG Technology

- At least one set of **Toolbox** pages for the MDG Technology is automatically added to the **Toolbox** <sup>[399]</sup>; you can access the added **Toolbox** pages through the **More Tools** menu
- Any MDG Technology-specific diagram templates are added to the **New Diagram** <sup>[422]</sup> dialog for selection; when selected, these display the diagram-specific **Toolbox** pages.

You can quickly enable or disable all the listed MDG Technologies by clicking on the **All** or **None** buttons. However, if you click on the **None** button, you should scroll to the top of the list and select the **Basic UML 2 Technology** checkbox to re-enable the UML and Extended **Toolbox** pages and diagram types.

### Set as Default

You can make an MDG Technology the default interface to Enterprise Architect. Depending on the MDG Technology selected, this can change the way Enterprise Architect windows are displayed and override the **Toolbox** pages with pages specific to that Technology.

To set an MDG Technology as the default interface, click on it in the **Technology** panel and click on the **Set Active** button.

This displays an asterisk against the MDG Technology name in the **Technology** panel, and selects the MDG Technology in the profile field of the **Default Tools** toolbar. If the MDG Technology has not been enabled, this also enables it.

You can also enable one or more of the MDG Technologies (and likely make one of them the default) and then *deselect* the **Basic UML 2 Technology** checkbox, to work exclusively in the selected technologies only. The UML and Extended **Toolbox** pages, diagram types and quicklinks are excluded from the **Toolbox**, **More tools** menu, diagrams and **New Diagram** dialog in the user interface.

### MDG Technologies Outside Enterprise Architect

The **MDG Technologies** dialog lists technologies that have been loaded into the Enterprise Architect install directory. You can also add MDG Technologies in folders and websites remote from Enterprise Architect. To do this, click on the **Advanced** button. See the [Access Remote MDG Technologies](#) <sup>[1070]</sup> topic.

#### 5.2.11.1.1 Access Remote MDG Technologies

You can access MDG Technologies in folders and websites remote from Enterprise Architect.

If you have not already identified the location of the MDG Technology, you must first do this. You can then [select](#) <sup>[1071]</sup> the MDG Technology for use.

Later, if you have no further use for the MDG Technology, you can [remove](#) <sup>[1071]</sup> it from the list of identified MDG Technologies.

#### Note:

If you add or remove remote MDG Technologies, you must restart Enterprise Architect to show them on or remove them from the list on the **MDG Technologies** dialog.

### Identify Remote MDG Technology

To specify the location of the MDG Technology to access, follow the steps below:

1. Select the **Settings | MDG Technologies** menu option. The **MDG Technologies** <sup>[1069]</sup> dialog displays.
2. Click on the **Advanced** button. The **MDG Technologies - Advanced** dialog displays.

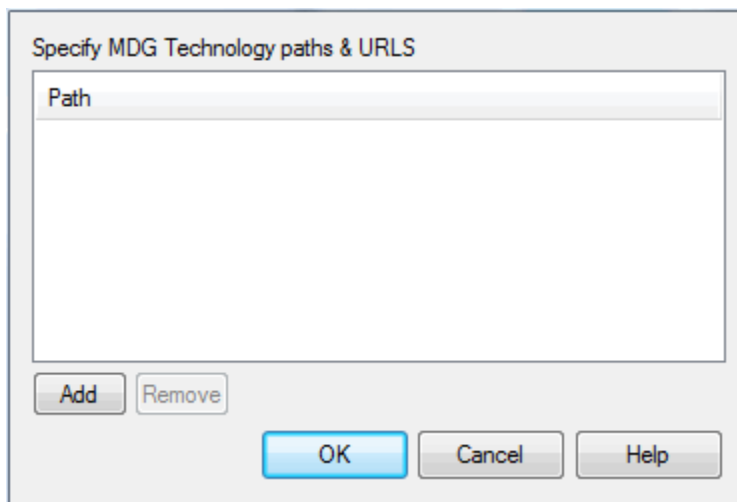

3. Click on the **Add** button. A short context menu displays, offering the options:
  - **Add Path**
  - **Add URL**.
4. To specify an MDG Technology in a directory folder, select the **Add Path** option. The **Browse for Folder** dialog displays. Browse for the MDG Technology folder, click on it, and click on the **OK** button. Go to step 6.
5. To specify an MDG Technology on a web site, select the **Add URL** option. The **Input** dialog displays.

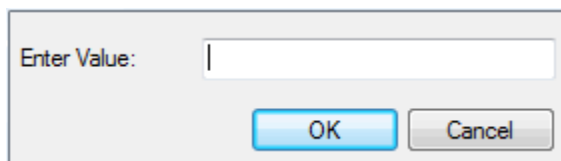

In the **Enter Value** field, type or copy-and-paste the MDG Technology URL. Click on the **OK** button.

6. The folder path or URL for the MDG Technology displays in the **Path** panel.

### Use Remote MDG Technology

To access a remote MDG Technology listed in the **MDG Technologies - Advanced** dialog, double-click on the folder path or URL.

### Remove Listed MDG Technology

To remove an MDG Technology listed in the **MDG Technologies - Advanced** dialog, click on the folder path or URL and click on the **Remove** button. The path or URL is deleted.

## 5.2.11.2 Import MDG Technologies

### Note:

This method of importing MDG Technologies into the **Resources** window is available but not recommended. If you use this method, the MDG Technology **Toolbox** pages, **Tasks Pane**, **Project Browser** icons and model templates are not available.

It is now recommended that you reference technologies directly from the Enterprise Architect install directory on your hard drive, or from [remote file locations and web sites](#)<sup>1070</sup>.

To import an MDG Technology you must have a suitable MDG Technology XML file. If the MDG Technology includes references to any metafiles, they should be in the same directory as the MDG Technology XML file.

An imported MDG Technology is available only within the model into which it has been imported, not in every model you have in Enterprise Architect. To make the MDG Technology available across all your models, download it into the Enterprise Architect install directory.

## Import an MDG Technology

To import an MDG Technology, follow the steps below:

1. Select the **Tools | Import Technology** menu option. The **Import Technology** dialog displays.

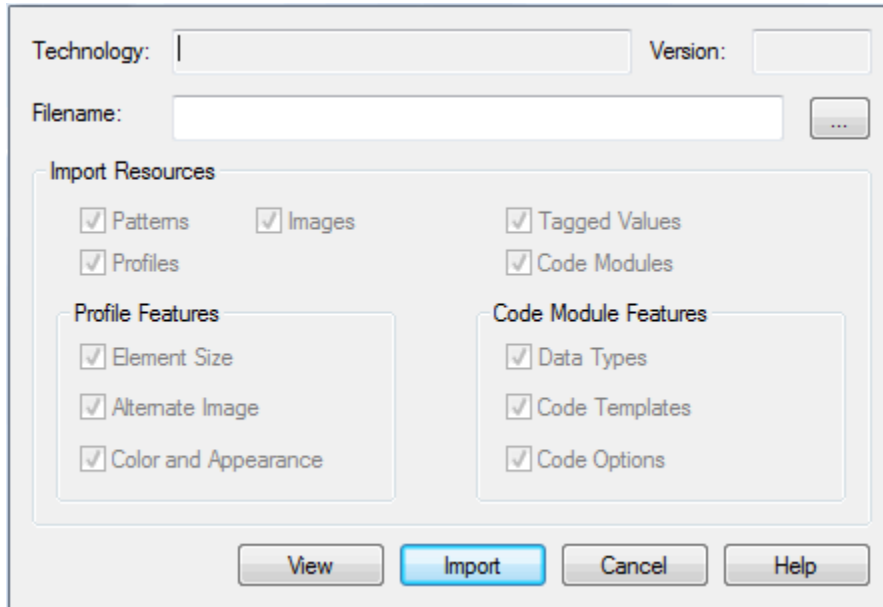

2. In the **Filename** field, type the path and filename of the MDG Technology file to import, or browse for it using the [ ... ] button.

### Note:

When you enter the filename, the MDG Technology name displays in the **Technology** field and the option checkboxes become available. Any options that remain grayed out indicate that no examples of that type exist in the MDG Technology XML file.

3. All option checkboxes default to selected. *Clear* those against resources you do not want to import, and *leave selected* the checkbox against each of the resources to import. Leave selected:
  - **Patterns**, to import patterns, if they exist
  - **Images**, to import graphics
  - **Profiles**, to import profiles, if they exist
  - **Element Size**, to import the element size attributes
  - **Alternate Image**, to import the metafile image
  - **Tagged Values**, to import Tagged Values
  - **Color and Appearance**, to import the color (background, border and font) and appearance (border thickness) attributes
  - **Code Modules**, to import the various languages associated with the technology, if they exist
  - **Data Types**, to import the data types
  - **Code Templates**, to import the code templates, if they exist
  - **Code Options**, to import the options that include items such as default file extensions and default file paths.
4. Click on the **Import** button.

If the MDG Technology already exists, Enterprise Architect displays a prompt to overwrite the existing version and import the new one.

Once the import is complete, the MDG Technology is listed in the *MDG Technologies* folder of the [Resources](#) <sup>[1067]</sup> window and in the [MDG Technologies](#) <sup>[1069]</sup> dialog.

### 5.2.11.3 Extensions - MDG Technologies

Enterprise Architect is the core for a range of Model Driven Generation (MDG) Add-Ins that enable you to extend its modeling capabilities to use more specialized, niche frameworks and profiles. Some of these, such as [Archimate](#)<sup>[1073]</sup>, [BPEL](#)<sup>[958]</sup>, [BPMN](#)<sup>[952]</sup>, [Data Flow Diagrams](#)<sup>[1076]</sup>, [Eriksson-Penker Extensions](#)<sup>[1086]</sup>, [ICONIX](#)<sup>[1084]</sup>, [Mind Mapping](#)<sup>[1087]</sup>, [Systems Modeling Language \(SysML\)](#)<sup>[989]</sup> and [SPEM](#)<sup>[1061]</sup> are already provided with the Enterprise Architect installer.

Enterprise Architect provides support for [downloading MDG Technologies](#)<sup>[1070]</sup> from external system files or websites, or for creating your own easily with the Enterprise Architect [MDG Technology Wizard](#)<sup>[1118]</sup>.

Sparx Systems also market a number of MDG products, as follows:

- MDG Technology For:
  - Zachman Framework
  - The Open Group Architecture Framework (TOGAF)
  - Department Of Defense Architecture Framework - Ministry Of Defence Architecture Framework (DoDAF-MODAF)
  - Data Distribution Service (DDS)
  - [Strategic Modeling](#)
  - Python (for Enterprise Architect versions 4.5 to 5.0; integrated in later versions) (\* free product! \*)
  - CORBA (\* free product! \*)
  - Java Beans (\* free product! \*)
  - Testing (\* free product! \*)
- MDG Integration For:
  - Eclipse 3.3
  - Visual Studio 2005 and 2008
  - Siemens PLM Teamcenter Systems Engineering (TcSE)
- MDG Link For
  - Eclipse
  - Visual Studio.Net
  - Microsoft Visio (\* free product! \*)
  - Telelogic DOORS

Over time, this list is being extended to include further products.

Sparx Systems provide different editions of Enterprise Architect tailored for [systems engineering](#)<sup>[14]</sup> and [business engineering](#)<sup>[13]</sup>, or [both](#)<sup>[13]</sup> together. These editions incorporate several of the above MDG Technologies and other add-ins.

### Product Information

For the latest list of available Add-Ins and an introduction to each product, including details of pricing, purchasing and download options, see the [Products Page on the Sparx Systems website](#). When you purchase one of the Add-Ins, you receive one or more license keys and instructions on obtaining, installing and registering the product.

The information page for most products provides a link to download the product **User Guide** in .pdf format.

The product User Guide can also be displayed as a .chm file online within the product itself. To access this online help in Enterprise Architect, select the **Add-Ins | <productname> | Help** menu option.

### 5.2.11.4 Archimate

*Archimate* is an open-standard enterprise architecture language from The Open Group, based on the IEEE 1471 standard.

Archimate offers a common language for describing the construction and operation of business processes, organizational structures, information flows, IT systems and technical infrastructure, enabling Enterprise Architects to describe, analyse and visualize the relationships among business domains in an unambiguous way.

### Archimate in Enterprise Architect

Enterprise Architect enables you to develop Archimate diagrams quickly and simply, through use of an Archimate MDG Technology integrated with the Enterprise Architect installer. The Archimate facilities are provided in the form of:

- An Archimate diagram type, accessed through the [New Diagram](#)<sup>[422]</sup> dialog
- A set of [Archimate](#) pages in the [Toolbox](#)
- Archimate element and relationship entries in the [Toolbox Shortcut](#)<sup>[403]</sup> Menu and [Quick Linker](#)<sup>[474]</sup>.

#### Archimate Toolbox Pages

You can access the [Archimate](#) pages of the [Toolbox](#) through the **More tools | Archimate** menu option.

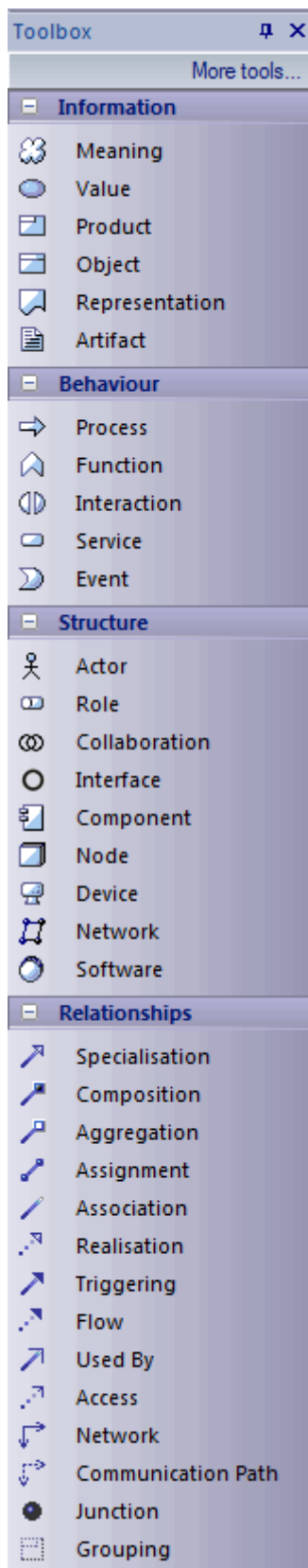

The toolbox pages provide three categories of elements - Information, Behavior and Structure - and a page of connectors that are largely based on the UML connectors.

The appearance of elements can be modified with the use of Tagged Values, as suggested below:

- For Artifact, Process, Function, Interaction, Service, Event, Actor, Role, Collaboration, Interface, Component, Node and Device elements:
  - *iconstyle=true* shows the iconic representation of the element
  - *iconstyle=false* shows a rectangle with a decoration in the top corner
- An Interface element (if *iconstyle=true*) can be *provided*, *required*, *symmetric* or *assembly*, and can be rotated, by setting the Tagged Values
- A Function element (if *iconstyle=true*) can be rotated
- An Actor element (if *iconstyle=false*) can be compound
- Process and Function elements can be marked *atomic*.

Because there is a large range of Archimate elements, you should make good use of the [Quick Linker](#)<sup>[474]</sup> arrow to guide you in selecting appropriate source and target elements and relationship types to model your enterprise architecture.

### Disable Archimate

If you prefer not to use Archimate in Enterprise Architect, you can disable it (and subsequently re-enable it) using the [MDG Technologies](#)<sup>[1069]</sup> dialog (**Settings | MDG Technologies**).

### 5.2.11.5 Data Flow Diagrams

The following text is derived from the [Data Flow Diagram](#) entry in the online Wikipedia.

*A data flow diagram (DFD) is a graphical representation of the "flow" of data through an information system. A data flow diagram can also be used for the visualization of data processing (structured design). It is common practice for a designer to draw a context-level DFD first which shows the interaction between the system and outside entities. This context-level DFD is then "exploded" to show more detail of the system being modeled.*

*Data flow diagrams were invented by Larry Constantine ... based on Martin and Estrin's "data flow graph" model of computation. [They] are one of the three essential perspectives of Structured Systems Analysis and Design Method SSADM. The sponsor of a project and the end users will need to be briefed and consulted throughout all stages of a system's evolution. With a dataflow diagram, users are able to visualize how the system will operate, what the system will accomplish, and how the system will be implemented. The old system's dataflow diagrams can be drawn up and compared with the new system's dataflow diagrams to draw comparisons to implement a more efficient system.*

*Developing a DFD helps in identifying the transaction data in the data model.*

For further information on the concepts of Data Flow Diagrams, refer to the [Wikipedia](#) item and its linked sources.

### Data Flow Diagrams in Enterprise Architect

Enterprise Architect enables you to develop Data Flow diagrams quickly and simply, through use of an MDG Technology integrated with the Enterprise Architect installer. The Data Flow diagram facilities are provided in the form of:

- A Data Flow diagram type, accessed through the [New Diagram](#)<sup>[422]</sup> dialog
- A **Data Flow Diagram** page in the **Toolbox**
- Data Flow element and relationship entries in the [Toolbox Shortcut](#)<sup>[403]</sup> Menu and [Quick Linker](#)<sup>[474]</sup>.

### Data Flow Diagram Toolbox Page

You can access the **Data Flow Diagram** page of the **Toolbox** through the **More tools | Data Flow Diagrams** menu option. The following icons are available:

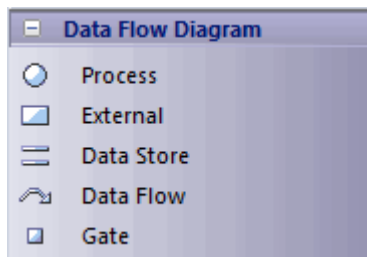

- *Process* is a process or activity in which data is used or generated
- *External* represents an external source, user or depository of the data
- *Data Store* represents an internal physical or electronic repository of data, into and out of which data is stored and retrieved
- *Data Flow* (connector) represents how data flows through the system, in physical or electronic form
- *Gate* represents the termination point of incoming and outgoing messages on a lower level diagram (that is, messages to and from processes depicted elsewhere).

When dragged onto a Data Flow diagram, the elements and relationship have the following appearances:



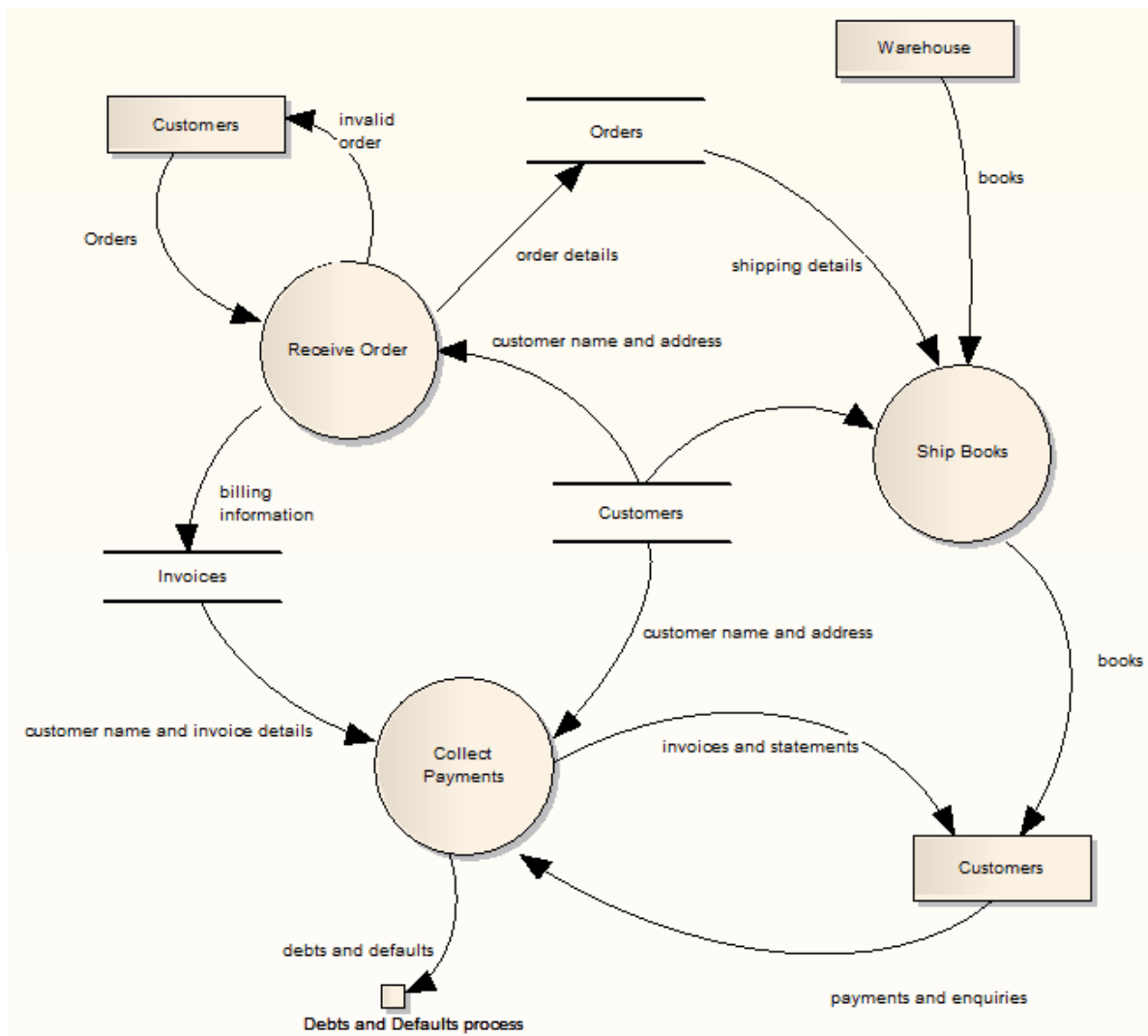

To preserve the simplicity and readability of the diagram, you cannot display the element compartments on the diagram.

### Context Diagram

A *Context* diagram is a top-level Data Flow diagram that has just one Process element representing the system being modeled, showing its relationship to external systems.

### Disable Data Flow Diagrams

If you prefer not to use Data Flow Diagramming in Enterprise Architect, you can disable it (and subsequently re-enable it) using the [MDG Technologies](#) dialog (**Settings | MDG Technologies**).

### 5.2.11.6 Entity Relationship Diagrams (ERDs)

#### Note:

Entity Relationship Diagrams are supported in the Corporate, Business and Software Engineering, Systems Engineering and Ultimate editions of Enterprise Architect.

The following text is derived from the [Entity Relationship Model](#) entry in the online Wikipedia:

*An entity-relationship model (ERM) is an abstract and conceptual representation of data. Entity-relationship modeling is a database modeling method, used to produce a type of conceptual schema or semantic data model of a system, often a relational database, and its requirements in a top-down fashion. Diagrams created by this process are called Entity-Relationship Diagrams, ER*

*Diagrams, or ERDs.*

For further information on the concepts of Entity Relationship Diagrams, refer to the [Wikipedia](#) item and its linked sources.

## Entity Relationship Diagrams in Enterprise Architect

Entity Relationship Diagrams in Enterprise Architect are based on Chen's ERD building blocks: entities are represented as rectangles, attributes are represented as ellipses and relationships are represented as diamond-shape connectors. ERD technology in Enterprise Architect assists you in every stage from building conceptual data models to generating Data Definition Language (DDL) for the target DBMS.

Enterprise Architect enables you to develop Entity Relationship diagrams quickly and simply, through use of an MDG Technology integrated with the Enterprise Architect installer. The Entity Relationship diagram facilities are provided in the form of:

- An Entity Relationship diagram type, accessed through the [New Diagram](#) <sup>[422]</sup> dialog
- An **Entity Relationship Diagram** page in the **Toolbox**
- Entity Relationship element and relationship entries in the [Toolbox Shortcut](#) <sup>[403]</sup> Menu and [Quick Linker](#) <sup>[474]</sup>.

Enterprise Architect also provides transformation templates to transform [Entity Relationship Diagrams](#) <sup>[1399]</sup> into Data Modeling Diagrams, and [vice versa](#) <sup>[1390]</sup>.

### Entity Relationship Diagram Toolbox Page

You can access the **Entity Relationship Diagram** page of the **Toolbox** through the **More tools | Entity Relationship Diagrams** menu option. The following icons are available:

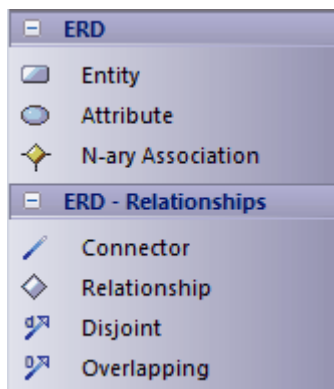

- *Entity* is an object or concept that is uniquely identifiable. The property of *Multiplicity* in the SourceRole and TargetRole definitions for the *Relationship* connector (below) can be used to define the cardinality of an Entity that participates in this relationship.
- *Attribute* is a property of an entity or a relationship type.
- *N-ary Association* represents unary (many-to-many recursive) or ternary relationships and can also be used to represent relationships that have attributes among the entities; Note that the N-ary Association element should always be at the target end of a connector.
- *Connector* is a connector between an Entity and an Attribute, and between two Attributes.
- *Relationship* is a diamond-shape connector, representing the meaningful association among entities.
- *Disjoint* and *Overlapping* represent the relationships between the super-class Entity and the sub-class Entity.

### Tagged Values

Some of the Entity Relationship diagram components can be modified by Tagged Values, as indicated below:

Component	Tagged Value	Notes
Entity	isWeakEntity	If <b>true</b> , this entity is a weak entity.
Attribute	attributeType	Four options:

Component	Tagged Value	Notes
		<ul style="list-style-type: none"> <li>• normal Attribute</li> <li>• primary key attribute</li> <li>• multi-valued Attribute</li> <li>• derived Attribute.</li> </ul>
	commonDataType	Defines the common data type for each attribute.
	dbmsDataType	Defines the customized DBMS data type for each attribute.  <b>Note:</b> You must define the customized type first through the <b>Settings   Database Datatypes</b> menu option. Also, set the <i>commonDataType</i> tag to <b>na</b> to activate the <i>dbmsDataType</i> tag.
<b>N-ary Association</b>	isRecursive	If <b>true</b> , the N-ary Association represents the many-to-many recursive relationship.  For one-to-many and one-to-one recursive relationships, we suggest using the normal <i>Relationship</i> connector.
<b>Relationship</b>	isWeak	If true, the Relationship is a weak relationship.
<b>Disjoin Overlapping</b>	Participation	Two options: <b>partial</b> and <b>total</b> .

### Diagram

A typical Entity Relationship Diagram is represented below:

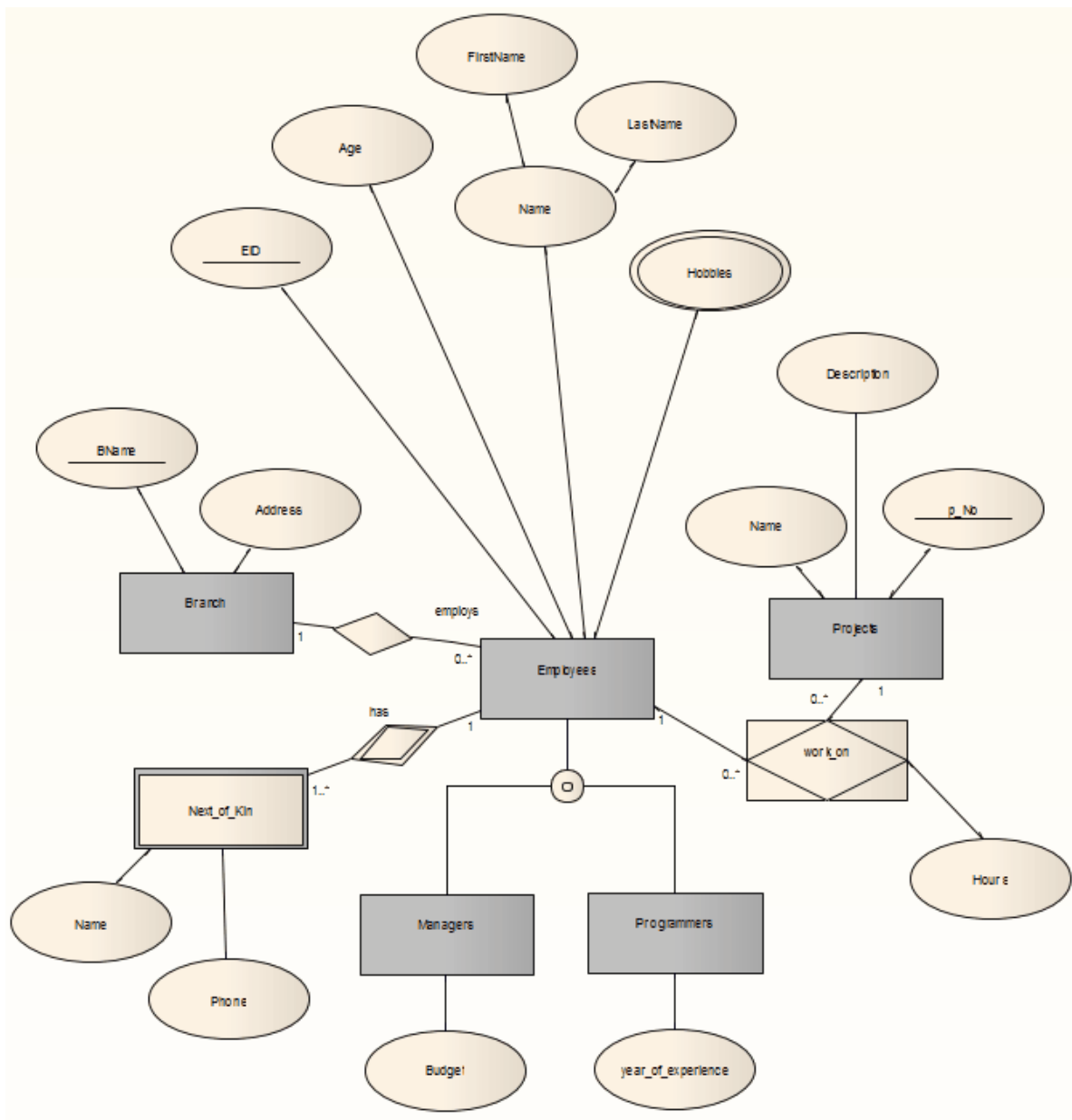
**Tip:**

Sometimes you might want to limit the stretch of the diamond-shape Relationship connectors. Simply pick a Relationship connector, right-click to display the context menu, and select the **Bend Line at Cursor** option.

### Disable Entity Relationship Diagrams

If you prefer not to use Entity Relationship Diagrams in Enterprise Architect, you can disable it (and subsequently re-enable it) using the [MDG Technologies](#) 10089 dialog (**Settings | MDG Technologies**).

#### 5.2.11.7 Eriksson-Penker Extensions

*Eriksson-Penker* extensions (developed by H. E. Eriksson and M. Penker) provide a framework for UML business processing model extensions, to which an enterprise architect can add stereotypes and properties appropriate to their business.

### Eriksson-Penker in Enterprise Architect

Enterprise Architect provides - through the integration of MDG Technologies with the installer - two

well-respected and proven UML extensions that further enhance the capture of business activities, processes, objects and information flows. One of these is [Business Process Modeling Notation](#)<sup>[952]</sup> (BPMN). The other is the Eriksson-Penker profile which, through a set of stereotypes, provides a unique and powerful means of visualizing and communicating business processes and the necessary flow of information within an organization.

The Eriksson-Penker extensions are provided in the form of:

- An Eriksson-Penker diagram type, accessed through the [New Diagram](#)<sup>[422]</sup> dialog
- An Eriksson-Penker page in the **Toolbox**
- Eriksson-Penker element and relationship entries in the [Toolbox Shortcut](#)<sup>[403]</sup> Menu and [Quick Linker](#)<sup>[474]</sup>.

### **Eriksson-Penker Toolbox Page**

You can access the Eriksson-Penker page of the **Toolbox** through the **More tools | Eriksson-Penker Extensions** menu option. The following icons are available:

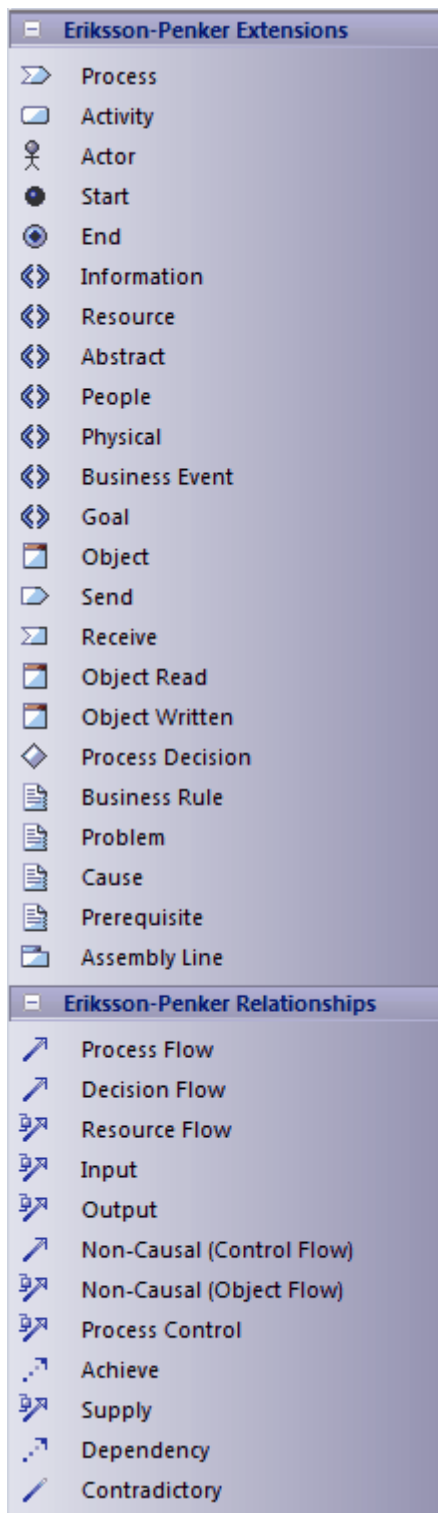

The following is an example of a simple Eriksson-Penker diagram:

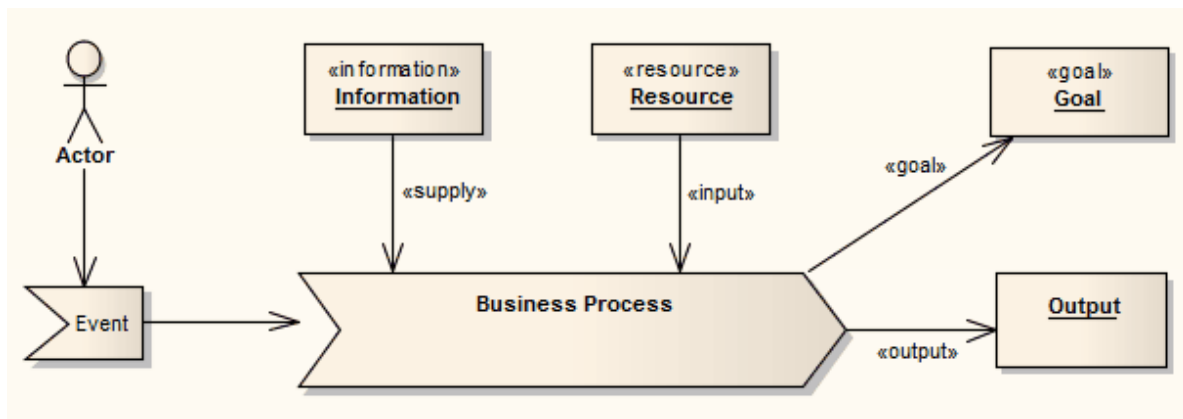

For further information on the MDG Technology for Eriksson-Penker Extensions, see [The Business Process Model](#) tutorial.

### 5.2.11.8 GoF Patterns

The following text is derived from the [Design Patterns](#) entry in the online Wikipedia.

*Gang of Four (GoF) Patterns are 23 classic software design patterns providing recurring solutions to common problems in software design. They were developed by Erich Gamma, Richard Helm, Ralph Johnson and John Vlissides, often referred to as the Gang of Four. The patterns are defined in the book Design Patterns: Elements of Reusable Object-Oriented Software (Gamma et al., ISBN 0-201-63361-2).*

For further information on the concepts of GoF Patterns, refer to the [Wikipedia](#) item and its linked sources.

### GoF Patterns in Enterprise Architect

Enterprise Architect enables you to develop diagrams from GoF patterns quickly and simply, through use of an MDG Technology integrated with the Enterprise Architect installer. The GoF Patterns are provided in the form of:

- [GoF Behavioral Patterns](#), [GoF Creational Patterns](#) and [GoF Structural Patterns](#) pages in the [Toolbox](#)
- Gang of Four pattern entries in the [Toolbox Shortcut](#) <sup>[403]</sup> Menu.

### GoF Toolbox Pages

You can access the [GoF Pattern](#) pages of the [Toolbox](#) through the **More tools | GoF Patterns** menu option. The following icons are available:

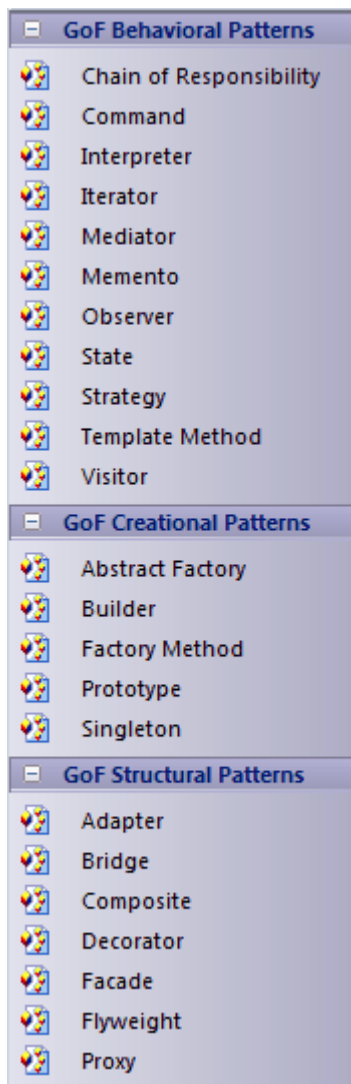

When you drag one of the pattern elements onto a new diagram, the [Add Pattern GoF <pattern group><pattern type>](#)<sup>[904]</sup> dialog displays. If necessary, modify the action and/or default for the component elements, then click on the **OK** button to create a diagram based on the pattern.

The GoF patterns are drawn from the **Resources** window. If you delete a pattern in the **Resources** window the equivalent **Toolbox** item cannot work. Therefore, if you cannot drop a pattern element from the **Toolbox**, check that it is still available in the **Resources** window.

### Disable GoF Patterns

If you prefer not to use the GoF Patterns technology in Enterprise Architect, you can disable it (and subsequently re-enable it) using the [MDG Technologies](#)<sup>[1069]</sup> dialog (**Settings | MDG Technologies**).

#### 5.2.11.9 ICONIX

The following text is derived from the [ICONIX](#) entry in the online Wikipedia.

*The ICONIX Process is a minimalist, streamlined approach to Use Case driven UML modeling that uses a core subset of UML diagrams and techniques to provide thorough coverage of object-oriented analysis and design. Its main activity is robustness analysis, a method for bridging the gap between analysis and design. Robustness analysis reduces the ambiguity in use case descriptions, by ensuring that they are written in the context of an accompanying domain model. This process makes the use cases much easier to design, test and estimate.*

The ICONIX Process was developed by Doug Rosenberg. For more information on ICONIX, see the *ICONIX Software Engineering Inc.* website <http://www.iconixsw.com/>.



## ICONIX in Enterprise Architect

Enterprise Architect enables you to develop models under ICONIX quickly and simply, through use of an MDG Technology integrated with the Enterprise Architect installer. The ICONIX facilities are provided in the form of:

- A set of **ICONIX** pages in the **Toolbox**
- ICONIX element and relationship entries in the **Toolbox Shortcut** <sup>[403]</sup> Menu and **Quick Linker** <sup>[474]</sup>.

To further help you develop and manage a project under ICONIX, Enterprise Architect also provides a white paper on the [ICONIX Roadmap](#).

In addition, Enterprise Architect has an alternative [visual layout](#) <sup>[1088]</sup> specific to ICONIX.

### ICONIX Toolbox Pages

Within the **Toolbox**, Enterprise Architect provides ICONIX versions of the pages for UML [Analysis](#) <sup>[733]</sup>, [Use Case](#) <sup>[676]</sup>, [Class](#) <sup>[721]</sup>, Interaction ([Sequence](#) <sup>[706]</sup>), [Activity](#) <sup>[674]</sup> and [Custom](#) <sup>[734]</sup> diagrams (which often form the basis for *Robustness* diagrams). Compared to the standard **Toolbox** pages, these have slightly different element and relationship sets. You can access them by either:

- Selecting the **More tools | ICONIX | <Diagram Type>** menu option for a specific **Toolbox** page, or
- Selecting the **ICONIX** option in the drop-down field of the **Default Tools** toolbar, which adds all six pages to the **Toolbox**. The first page and the **Common** page are expanded, and the others are closed up.

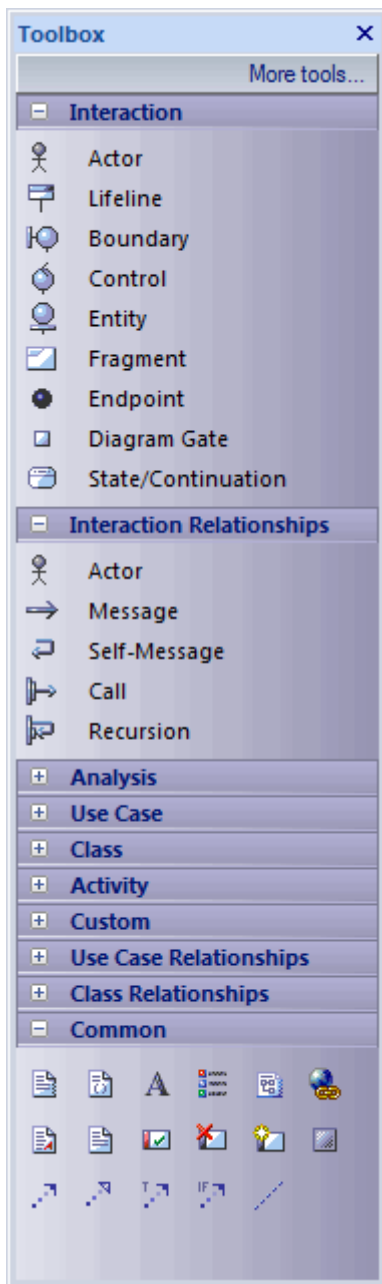

### ICONIX Layout

The ICONIX layout re-organizes the Enterprise Architect work area, opening the:

- **Toolbox** on the right hand side of the screen (follow the instructions above to display the ICONIX pages)
- The **Tasks Pane** window auto-hidden in the top right of the screen
- **Project Browser** window in the top left of the screen, and
- **Notes**, **Properties** and **Tagged Values** windows nested on the bottom left of the screen.

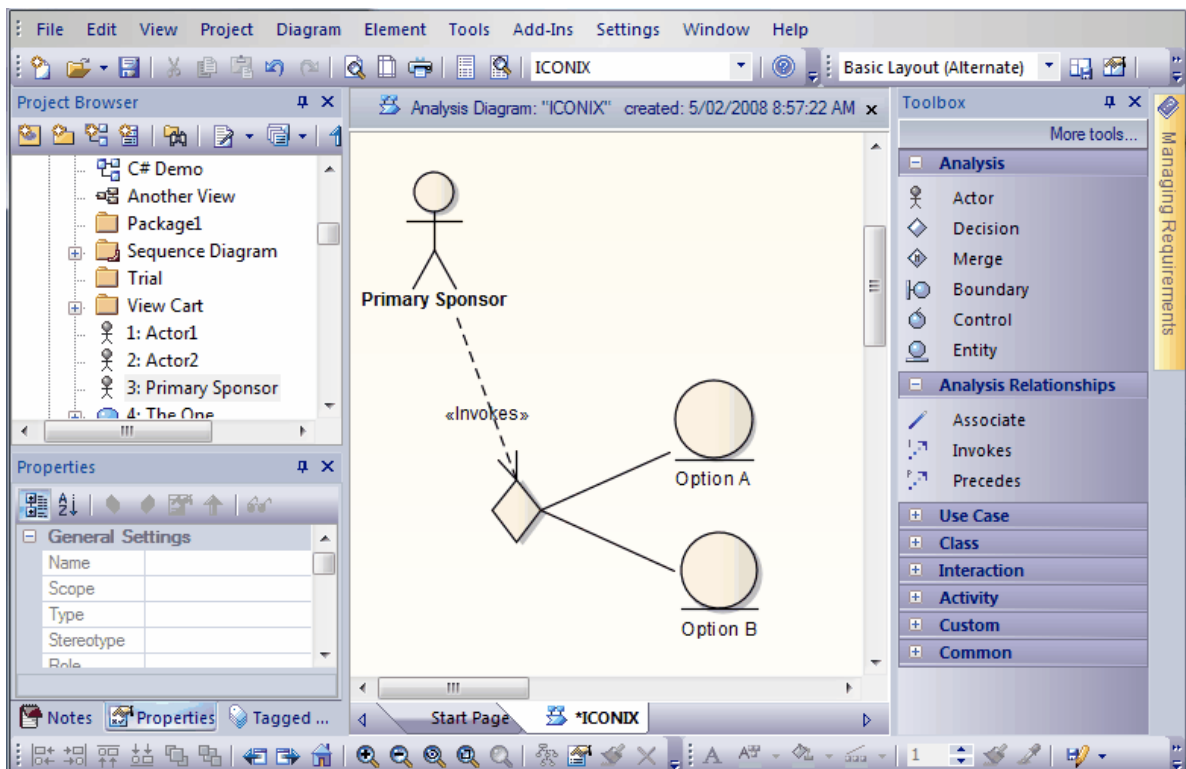

To apply this layout, select the **View | Workspace Layouts** menu option and select the [Basic Layout \(Alternate\)](#)<sup>[86]</sup> option.

### Disable ICONIX

If you prefer not to use ICONIX in Enterprise Architect, you can disable it (and subsequently re-enable it) using the [MDG Technologies](#)<sup>[1069]</sup> dialog (**Settings | MDG Technologies**).

This does not affect the ICONIX layout, which you can switch back to your own layout or the Enterprise Architect default layout using the **View | Workspace Layouts** menu option.

#### 5.2.11.10 Mind Mapping

The following text is derived from the [Mind Map](#) entry in the online Wikipedia.

*A Mind Map is a diagram used to represent words, ideas, tasks or other items linked to and arranged radially around a central key word or idea. It is used to generate, visualize, structure and classify ideas, and as an aid in study, organization, problem solving, decision making, and writing.*

*A Mind Map is an image-centered diagram that represents semantic or other connections between portions of information. By presenting these connections in a radial, non-linear graphical manner, it encourages a brainstorming approach to any given organizational task, eliminating the hurdle of initially establishing an intrinsically appropriate or relevant conceptual framework to work within.*

*The elements are arranged intuitively according to the importance of the concepts and are organized into groupings, branches, or areas. The uniform graphic formulation of the semantic structure of information on the method of gathering knowledge, may aid recall of existing memories.*

The use of the term *Mind Maps* is trademarked in the UK and the USA by The Buzan Organization, Ltd.

For further information on the concepts of Mind Mapping, refer to the [Wikipedia](#) item and its linked sources.

### Mind Mapping in Enterprise Architect

Enterprise Architect enables you to develop Mind Maps quickly and simply, through use of an MDG Technology integrated with the Enterprise Architect installer. The Mind Mapping facilities are provided in the form of:

- A Mind Mapping diagram type, accessed through the [New Diagram](#)<sup>[422]</sup> dialog

- A [Mind Mapping](#) page in the [Toolbox](#)
- Mind Mapping element and relationship entries in the [Toolbox Shortcut](#)<sup>[403]</sup> Menu and [Quick Linker](#)<sup>[474]</sup>.

### Mind Mapping Toolbox Page

You can access the [Mind Mapping](#) page of the [Toolbox](#) through the **More tools | Mind Mapping** menu option. The following icons are available:

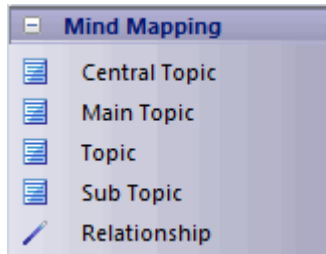

- *Central Topic* is the main theme of the Mind Map; you would normally have one or two of these on the diagram, but can add as many as are necessary
- *Main Topic* represents the immediate concepts generated by the Central Topic
- *Topic* represents the larger divisions of a Main Topic
- *Sub Topic* represents the finer divisions of a Topic or Main Topic; you could also have Subtopics of Subtopics to represent increasingly finer distinctions
- *Relationship* represents the connection between any two elements; you can have several Relationships per element. Each relationship has three anchor points, so you can curve the lines to develop the flow of concepts more easily.

When dragged onto a Mind Mapping diagram, the elements and relationship have the following appearances:

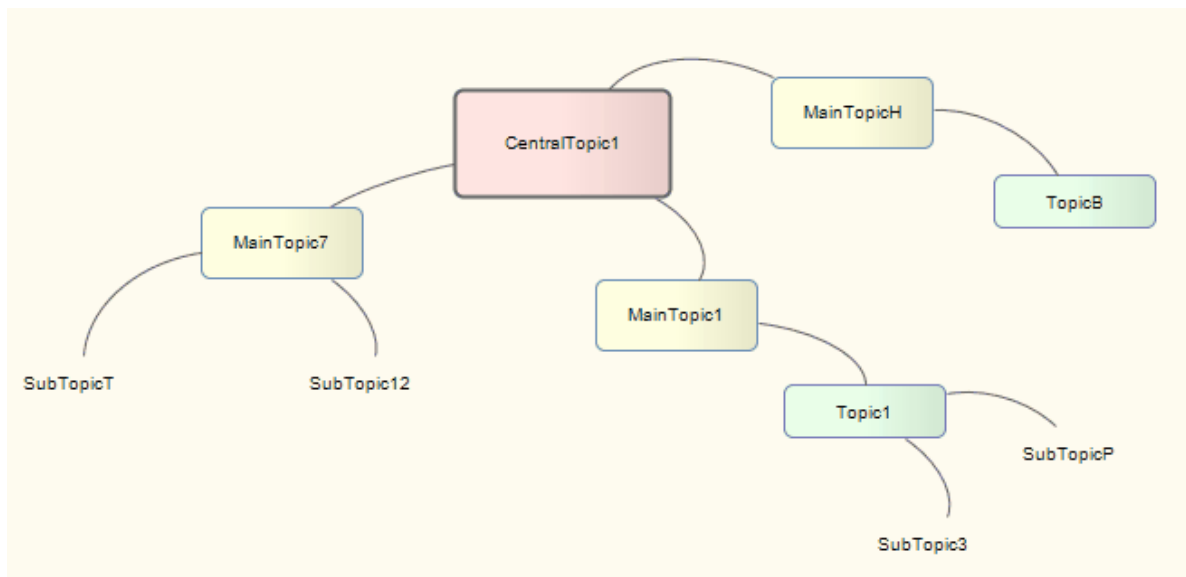

As the elements can represent any concept, object or relationship, you can use the full range of element properties and features to expand on what the element represents, including adding *Note* elements. However, to preserve the simplicity and readability of the diagram itself, you cannot display the element compartments on the diagram.

### Disable Mind Mapping

If you prefer not to use Mind Mapping in Enterprise Architect, you can disable it (and subsequently re-enable it) using the [MDG Technologies](#)<sup>[1069]</sup> dialog (**Settings | MDG Technologies**).

### 5.2.11.11 SoaML

**Note:**

Service Oriented Architecture Modeling Language (SoaML) is supported in the Corporate, Systems Engineering, Business and Software Engineering and Ultimate editions of Enterprise Architect.

The following text is derived from *Service oriented architecture Modeling Language (SoaML) - Specification for the UML Profile and metamodel for Services (UPMS)* (OMG document ad/2008-11-01); pp. 25-26:

*A service is an offer of value to another through a well-defined interface and available to a community (which may be the general public). A service results in work provided to one by another.*

*Service Oriented Architecture (SOA) is a way of organizing and understanding [representations of] organizations, communities and systems to maximize agility, scale and interoperability. The SOA approach is simple - people, organizations and systems provide services to each other. These services allow us to get something done without doing it ourselves or even without knowing how to do it - enabling us to be more efficient and agile. Services also enable us to offer our capabilities to others in exchange for some value - thus establishing a community, process or marketplace. The SOA paradigm works equally well for integrating existing capabilities as for creating and integrating new capabilities.*

*SOA ... is an architectural paradigm for defining how people, organizations and systems provide and use services to achieve results. SoaML ... provides a standard way to architect and model SOA solutions using the Unified Modeling Language (UML). The profile uses the built-in extension mechanisms of UML to define SOA concepts in terms of existing UML concepts.*

*... the highest leverage of employing SOA comes from understanding a community, process or enterprise as a set of interrelated services and ... supporting that service oriented enterprise with service-enabled systems. SoaML enables business oriented and systems oriented services architectures to mutually and collaboratively support the enterprise mission. ... SoaML depends on Model Driven Architecture® (MDA®) to help map business and systems architectures, the design of the enterprise, to the technologies that support SOA, like web services and CORBA®.*

For further information on the concepts of SoaML, see the specification document on the OMG website (<http://www.omg.org/docs/ad/08-11-01.pdf>).

### SoaML in Enterprise Architect

Enterprise Architect enables you to model services architectures quickly and simply, through use of an MDG Technology integrated with the Enterprise Architect installer. The SoaML facilities are provided in the form of:

- Two SoaML diagram types - *SoaML Component Diagram* and *SoaML Sequence Diagram* - accessed through the [New Diagram](#)<sup>[422]</sup> dialog
- **SoaML** pages in the **Toolbox**
- SoaML element and relationship entries in the [Toolbox Shortcut](#)<sup>[403]</sup> Menu and [Quick Linker](#)<sup>[474]</sup>.

### SoaML Toolbox Pages

You can access the **SoaML** pages of the **Toolbox** through the **More tools | Mind Mapping** menu option. There is a set of pages for each SoaML diagram type, although the last five pages in each set are the same.

## SoaML Component Diagram

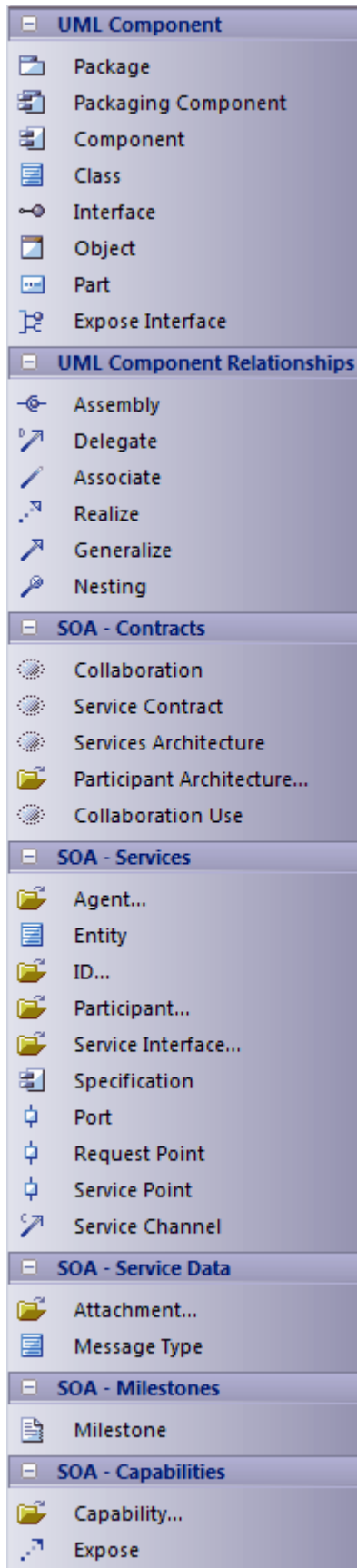

## SoaML Sequence Diagram

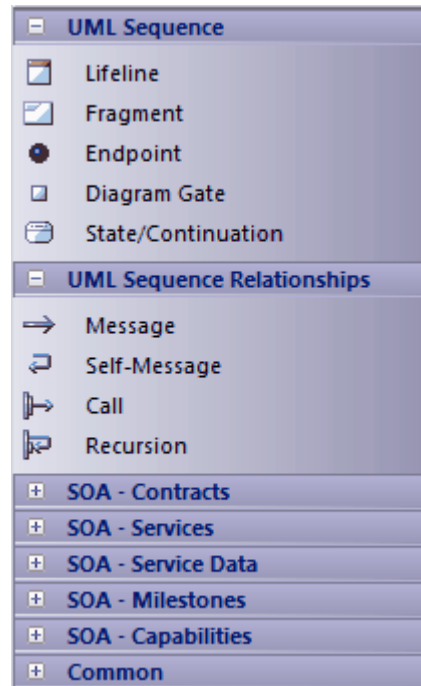

## Example SoaML Diagram

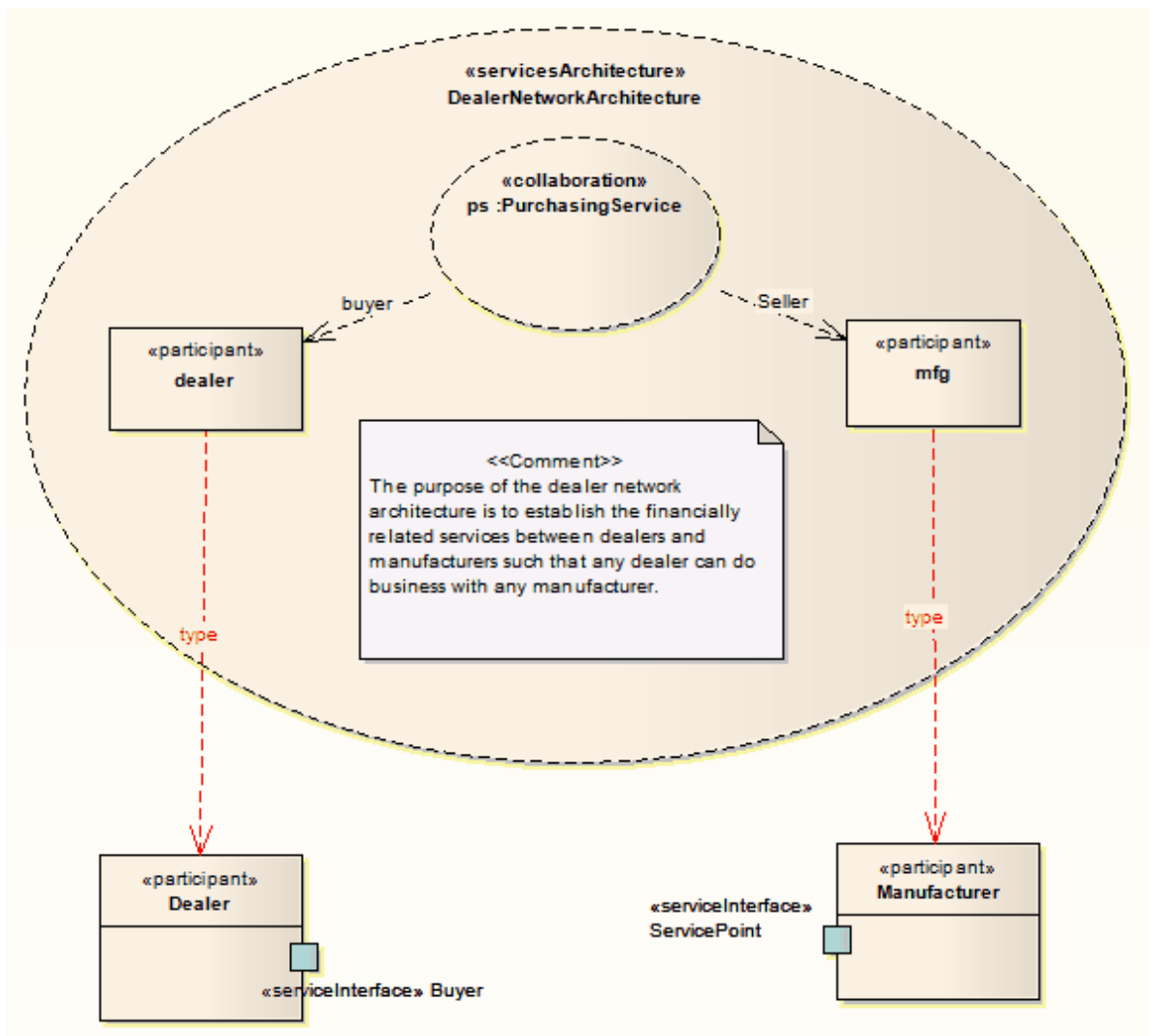

## Disable SoaML

If you prefer not to use SoaML in Enterprise Architect, you can disable it (and subsequently re-enable it) using the [MDG Technologies](#) <sup>[1069]</sup> dialog (**Settings | MDG Technologies**).

## 5.3 Build Your Own Modeling Language



Enterprise Architect enables you to create models using UML. However, it also enables you to go much further, extending the scope both of your modeling and of the UML components you use, as outlined below.

### UML Stereotypes

*Stereotypes* are an inbuilt mechanism for logically extending or altering the meaning, display and syntax of a model element. Different model elements have different standard stereotypes associated with them. You can also define your own stereotypes.

For further information on stereotypes, see the [UML Stereotypes](#)<sup>[895]</sup> topic.

### UML Profiles

UML Profiles are a means of extending UML, which enables you to build models in particular domains. A Profile is a collection of additional stereotypes and Tagged Values applied to elements, attributes, methods and connectors, which together describe some particular modeling problem and facilitate modeling constructs in that domain.

For further information on Profiles, see the [UML Profiles](#)<sup>[906]</sup> topic.

### UML Patterns

Patterns are groups of collaborating Objects/Classes that can be abstracted from a general set of modeling scenarios (that is, parameterized collaborations). They generally describe how to solve an abstract problem, and are an excellent means of achieving re-use and building in robustness.

For more information on Patterns, see the [UML Patterns](#)<sup>[907]</sup> topic.

### MDG Technologies

The Model Driven Generation (MDG) Technologies enable you to access and use the resources of a specific technology within Enterprise Architect. Interfaces to some technologies, such as BPMN and ICONIX, are integrated with Enterprise Architect, whilst interfaces to others such as Eclipse and Visual Studio can be added separately. You can also link to technologies that you have [created yourself](#)<sup>[1092]</sup>.

For more information on MDG Technologies, see the [MDG Technologies](#)<sup>[1066]</sup> topic.

### 5.3.1 MDG Technology SDK

#### Introduction

In describing aspects of developing technologies to use in conjunction with Enterprise Architect, it is expected that you are familiar with the concepts introduced in the main body of the *Enterprise Architect User Guide*. Wherever appropriate, cross-references to these concepts are provided in the text.

#### Contents

- [Developing Profiles](#)<sup>[1093]</sup> (incorporating [Custom Stereotypes](#)<sup>[1093]</sup>)
- [MDG Technologies](#)<sup>[1118]</sup>
- [Shape Scripts](#)<sup>[1147]</sup>
- [Tagged Value Types](#)<sup>[1166]</sup>
- [Code Template Framework](#)<sup>[1172]</sup>



### 5.3.1.1 Developing Profiles

#### Introduction

Profiles provide a means of extending the UML, which enables you to build models in particular domains. They are based on additional [stereotypes](#)<sup>[1093]</sup> and [Tagged Values](#)<sup>[1165]</sup> that are applied to UML elements, connectors and their components. A Profile is a collection of such extensions that together describe some particular modeling problem and facilitate modeling constructs in that domain. UML Profiles for Enterprise Architect are specified in XML files, with a specific format. These XML files can be imported into Enterprise Architect through the [Resources](#) window.

The imported Profile also automatically generates a page of elements and relationships in the [Toolbox](#).

The [Resources](#) window contains a tree structure with entries for items such as MDG Technologies, Documents, Stylesheets, Matrix profiles and UML Profiles. The *UML Profiles* node initially contains no entries; to be able to use Profiles you must import them into Enterprise Architect from supplied XML files.

Items in the Profile represent stereotypes. UML supports a large number of stereotypes, which are an inbuilt mechanism for logically extending or altering the meaning, display, appearance and syntax of a model element. Different model elements have different stereotypes associated with them.

For more information on the use of Profiles in Enterprise Architect, see the [UML Profiles](#)<sup>[906]</sup> topic.

For information on developing your own Profiles, see the following topics:

- [Custom Stereotypes](#)<sup>[1093]</sup>
- [Create Profiles](#)<sup>[1095]</sup>
- [Quick Linker](#)<sup>[1113]</sup>
- [Customize Toolbox Profiles](#)<sup>[1134]</sup>
- [Create Diagram Profiles](#)<sup>[1139]</sup>
- [Create Tasks Pane Profiles](#)<sup>[1141]</sup>

#### 5.3.1.1.1 Custom Stereotypes

UML supports a large number of *stereotypes*, which are an inbuilt mechanism for logically extending or altering the meaning, physical appearance and syntax of a model element. Different model elements have different stereotypes associated with them. For more information on the use of stereotypes in Enterprise Architect, see the [UML Stereotypes](#)<sup>[895]</sup> topic.

In Enterprise Architect you can create new stereotypes with their own custom appearance. The stereotypes can be altered to make use of metafiles (image files) and customized colors, or you can make use of an Enterprise Architect Shape Script to make new element shapes to determine the shape and dimensions of the element.

To add your own custom stereotypes, follow the steps below:

1. From the main menu, select **Settings | UML**. The [UML Types](#) dialog displays, defaulted to the [Stereotypes](#) tab.

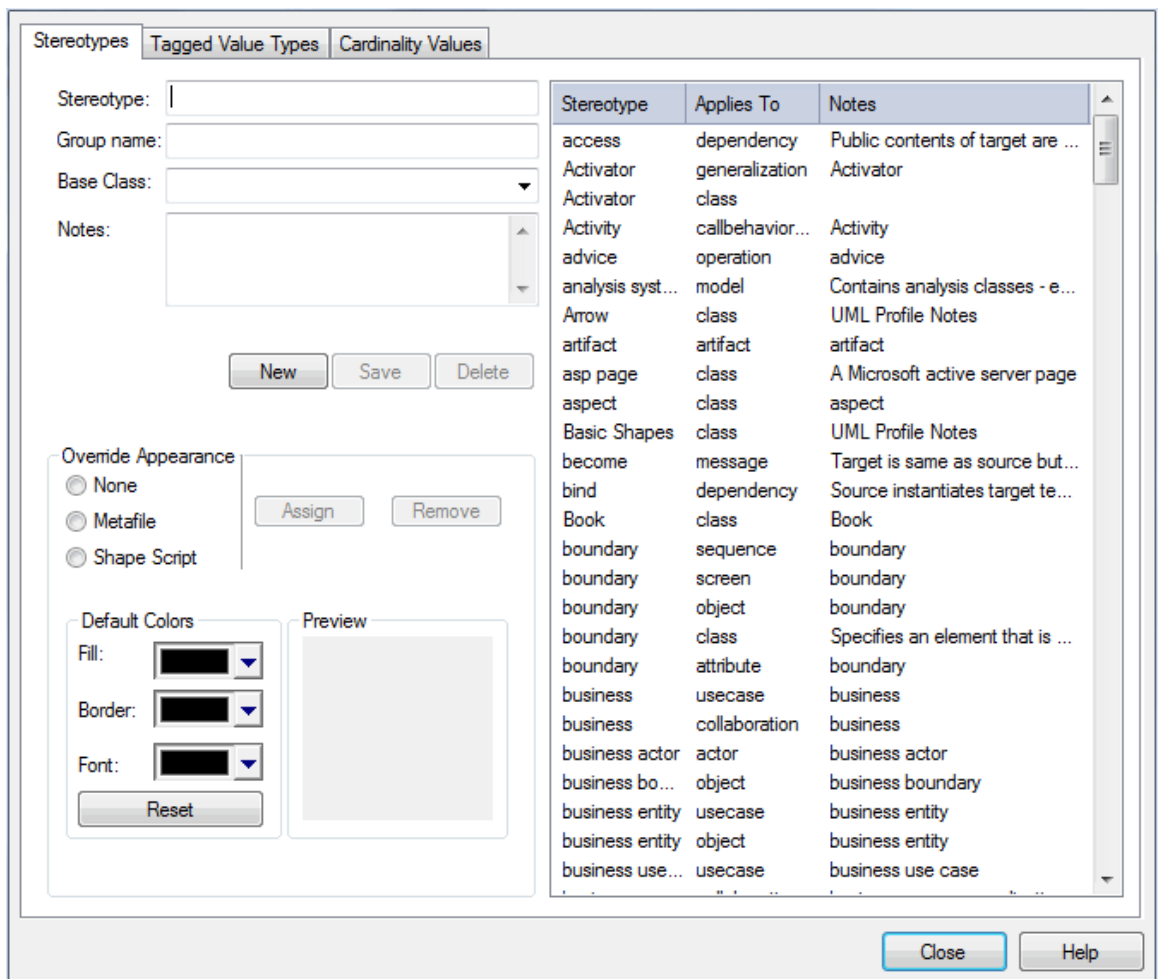

2. Type or select a **Stereotype** name.
3. Select a **Base Class** from the drop-down list.
4. To associate a Metafile with this stereotype, click on the **Metafile** radio button and the **Assign** button, and locate the required .emf or .wmf file.
5. Enter optional **Notes** and select **Default Colors** for this stereotype.
6. Click on the **Save** button to save the stereotype.

The table below describes the functionality of the **Stereotypes** tab.

Option	Use to
<b>Stereotype</b>	Specify the name of the stereotype.
<b>Group name</b>	Enable grouping of stereotype features by a plural name, for attributes and operations, which is shown on diagrams in the attribute and operations compartments.
<b>Base Class</b>	Enable the stereotyped element to inherit the base characteristics from a pre-existing element type.
<b>Notes</b>	Type any notes concerning the stereotype (not the elements to which the stereotype is to be applied).
<b>Override Appearance</b>	
<b>None</b>	Switch to the default element appearance.
<b>Metafile</b>	Enable an image file to be used for the appearance of the stereotype.

Option	Use to
<b>Shape Script</b>	Specify custom shapes for the stereotype using the <i>Enterprise Architect Shape Scripting</i> language. For more information see the <a href="#">Shape Scripts</a> <sup>[1147]</sup> topic.
<b>Assign</b>	Add the associated metafile or Shape Script from the stereotyped element.
<b>Remove</b>	Remove the associated metafile or Shape Script from the stereotyped element.
<b>Default Colors</b>	
<b>Fill</b>	Set the default background color of the element.
<b>Border</b>	Control the border color.
<b>Font</b>	Control the color of the stereotype font.
<b>Reset</b>	Reset the appearance of the element to the default element appearance.

**Note:**

You can transport these custom stereotype definitions between models, using the [Export Reference Data](#) <sup>[223]</sup> and [Import Reference Data](#) <sup>[223]</sup> options on the **Tools** menu.

### 5.3.1.1.2 Create Profiles

This topic describes how to create profiles and profile items. These creation tasks include creating the profile stereotypes, defining the metaclasses they apply to, and defining Tagged Values and constraints. This topic also describes how to export a profile for use in modeling.

To create a Profile, follow the steps below:

1. [Create a Profile Package](#) <sup>[1095]</sup>
2. [Add Stereotypes and Metaclasses](#) <sup>[1096]</sup>
3. [Define Tagged Values for Stereotypes](#) <sup>[1098]</sup>
4. [Define Constraints for Stereotypes](#) <sup>[1101]</sup>
5. [Add Enumerations](#) <sup>[1103]</sup>
6. [Add Shape Scripts](#) <sup>[1104]</sup>
7. [Set Default Appearance](#) <sup>[1106]</sup>
8. [Export the Profile](#) <sup>[1106]</sup>

#### 5.3.1.1.2.1 Create a Profile Package

In Enterprise Architect, you must create a Profile in a Package that has the stereotype «*profile*». To create a Profile Package, follow the steps below.

1. Open or create a Package diagram.
2. Open the **Profile** page of the **Toolbox (More tools | Profile)**.

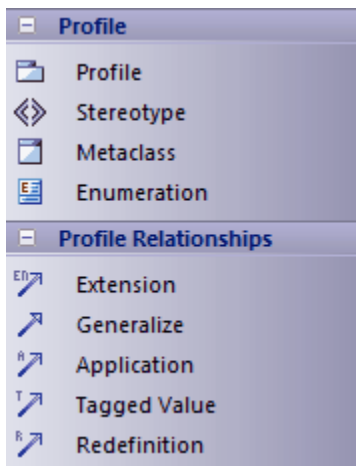

3. Drag the *Profile* item onto the Class diagram. The **New Model Package** dialog displays.
  4. In the **Package Name** field, type a name for the Profile.
  5. Select the **Automatically add new diagram** checkbox.
  6. Click on the **OK** button. The [New Diagram](#) <sup>[422]</sup> dialog displays.
  7. Provide the required diagram name, and select the diagram group **UML Structural** and diagram type **Class**.
  8. Click on the **OK** button. Enterprise Architect creates a package with the stereotype «*profile*» and with a child Class diagram.
  9. In the **Project Browser**, double-click on the Profile Package on the diagram to open the child diagram.
- You now use this child diagram to [add stereotypes](#) <sup>[1096]</sup> to the Profile.

#### 5.3.1.1.2 Add Stereotypes and Metaclasses

To add metaclasses and stereotypes to a Profile, follow the steps below for as many stereotypes and metaclasses as you require:

1. Open the child diagram of the Profile Package.
2. Drag the *Metaclass* element from the **Profile** page of the **Toolbox** onto the diagram. The **Create New Metaclass** dialog displays, in which you can tick multiple metaclasses for dropping onto the diagram.

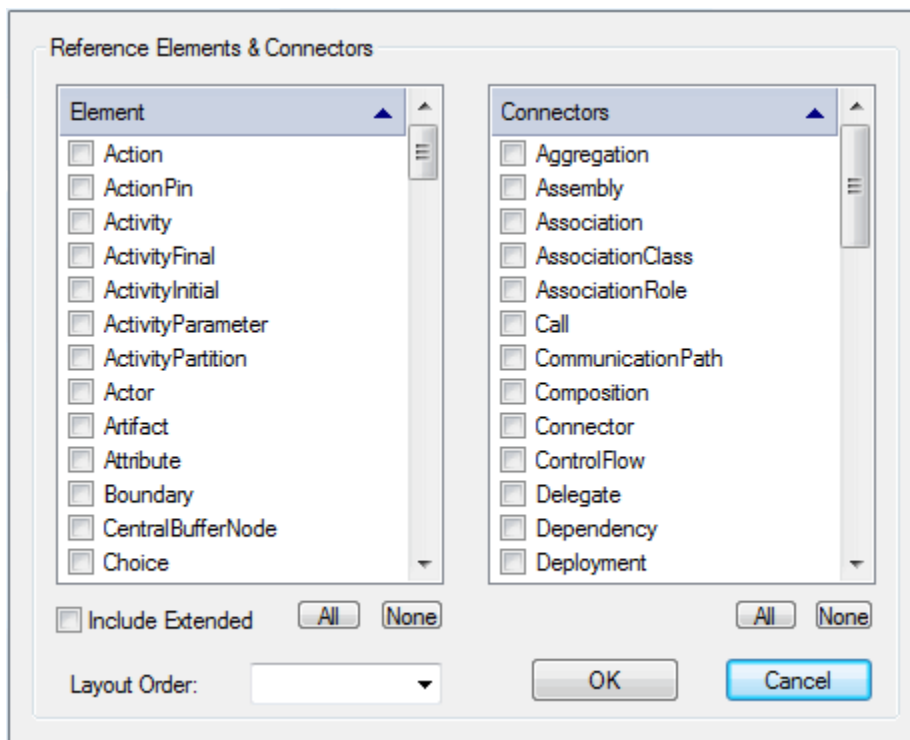

3. Scroll down the **Element** list and select the checkbox for **Class**.
4. Click on the **OK** button, display the Class **Properties** dialog, and in the **Name** field type a name for the element. Click on the **OK** button again.
5. Drag a **Stereotype** element from the **Toolbox** onto the diagram. If the **Properties** dialog does not display, double-click on the element on the diagram.
6. In the **Name** field, type a name for the stereotype.
7. Click on the **OK** button and, if it displays, **Close** the **Generate Code** dialog.
8. Click on the **Extension** relationship in the **Toolbox** and drag the connection from the stereotype element to the metaclass element.
9. Your diagram should now resemble the one below:

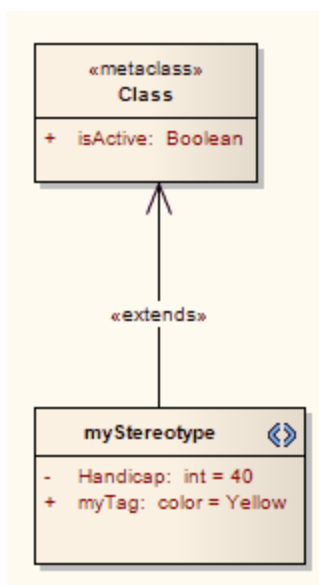

**Note:**

If you want to have a stereotype extending more than one metaclass, do not create two stereotype Classes with the same name. You cannot have two stereotypes with the same name in the same profile; one is discarded when you save the profile. Therefore, create one stereotype Class with an Extension connector to each of several Metaclass elements, as shown below.

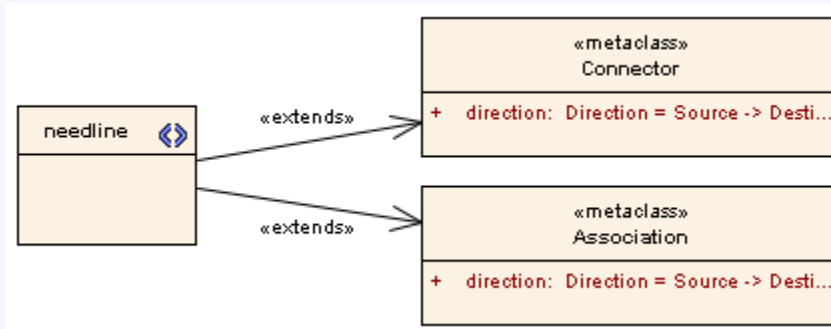

You can now add [stereotype Tags](#)<sup>[1098]</sup>, [Constraints](#)<sup>[1101]</sup>, [Enumerations](#)<sup>[1103]</sup>, and/or [Shape Scripts](#)<sup>[1104]</sup> to your Profile, and define the [default appearance](#)<sup>[1106]</sup> of the elements or connectors as required.

### 5.3.1.1.2.3 Define Stereotype Tagged Values

Stereotypes within a UML Profile can have one or more associated Tagged Values. When creating a UML Profile, you define these Tagged Values as attributes of the stereotyped Class.

You can also:

- [Define Stereotype Tags with Predefined Tag Types](#)<sup>[1099]</sup>
- [Define Stereotype Tags with Supported Attributes](#)<sup>[1100]</sup>
- [Use the Tagged Value Connector](#)<sup>[1107]</sup>

To define Tagged Values for a stereotype, follow the steps below:

1. Open the **Attributes** dialog for the stereotyped element.

The screenshot shows a 'General' tab in a modeling tool's property editor. The 'Name' field is 'Handicap', 'Type' is 'int', and 'Initial' is '40'. There are checkboxes for 'Derived', 'Static', 'Property', and 'Const'. A 'Notes' field is present with a rich text editor. Below the main form is an 'Attributes' section with a table:

Name	Type	Initial Value
Handicap	int	40
myTag	Color	Yellow

2. Click on the **New** button to create a new attribute.
3. In the **Name** field, type the name of the stereotype tag.
4. In the **Type** field, click on the drop-down arrow and select the attribute type.
5. In the **Initial** field, type the initial value of the tag. (See [Add Enumeration Elements](#)<sup>[1103]</sup> for the steps for creating enumerated types for Tagged Values.)
6. In the **Notes** field, type a description of the tag.
7. Click on the **Save** button and **Close** button.

### Define Predefined Tag Types

To define a stereotype tag with a predefined Tagged Value Type, you must first create the predefined Tagged Value Type. For full instructions on how to do this, see the [Create Structured Tagged Values](#)<sup>[1168]</sup> topic.

### Assign Predefined Tag Types to Stereotypes

To assign a predefined tag type to a stereotype, just create an attribute with the same name. For example, to make the Tagged Value *Handicap* appear in a stereotype, create an attribute named *Handicap*. You can set the default value for the Tagged Value by giving the attribute an *Initial* value.

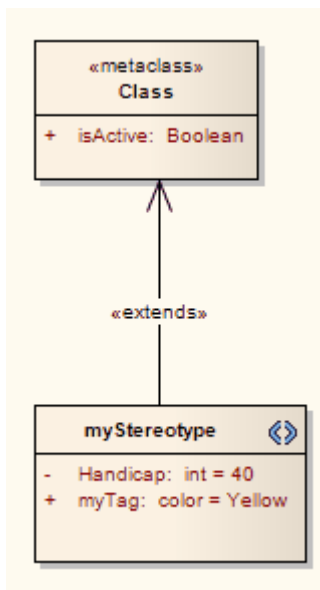

Supported stereotype attribute tags are special tags that set the default behavior of stereotyped elements, such as the initial size of the element and the default location of any image files associated with the stereotype. For a list of supported attributes, see the [Supported Attributes](#) topic.

To define tags for a stereotype with supported attributes, follow the steps below:

1. Open the **Attributes** dialog for the stereotyped element.

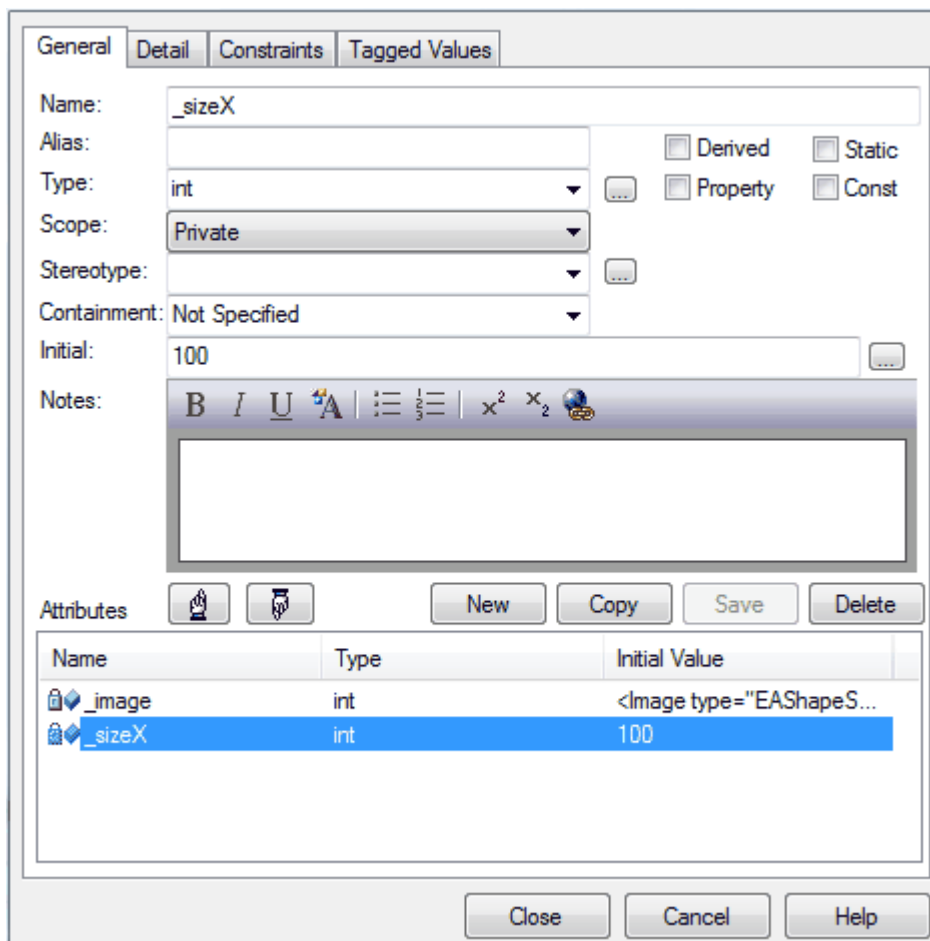



2. In the **Name** field, type the name of the stereotype tag.
3. In the **Initial** field, type the initial value of the tag.

**Note:**

For supported attributes you set only the **Name** (which must match the attributes listed in the supported attributes section) and the **Initial** value; do not set the other values.

4. Click on the **Save** button and **Close** button.

In a Profile, you can use the *Tagged Value* connector to define a Tagged Value that has as its value the name of an element containing the stereotype pointed to. You select the Tagged Value connector from the **Profile** pages of the **Toolbox**.

The following diagram demonstrates how you might use the connector. It shows a (*saved* and *imported*) profile that defines two stereotypes: «*Collection*» and «*Node*». The «*Collection*» stereotype has a Tagged Value connector with the target role named *rootNode*, pointing to the «*Node*» stereotype.

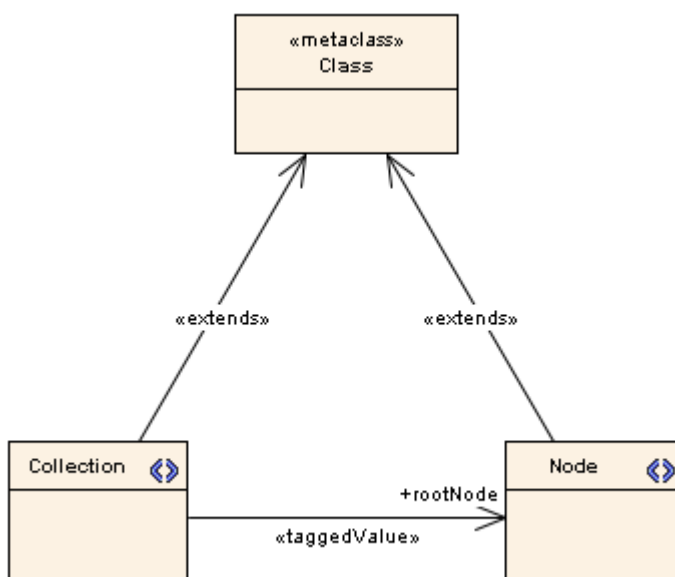

In the **Tagged Values** window for the connector, against *rootNode*, you click on the selection button ([ ... ]). This displays the **Select <Item>** dialog, through which you locate the elements in the current model with the «*Node*» stereotype. You can then select one of these elements as the value of the tag.

#### 5.3.1.1.2.4 Define Stereotype Constraints

Defining constraints for stereotypes uses the same procedure as defining constraints for any Class. To define constraints for a stereotype, follow the steps below:

1. Open the Class **Properties** dialog of the stereotype element in a diagram.
2. Click on the **Constraints** tab and click on the **New** button to create a new constraint.

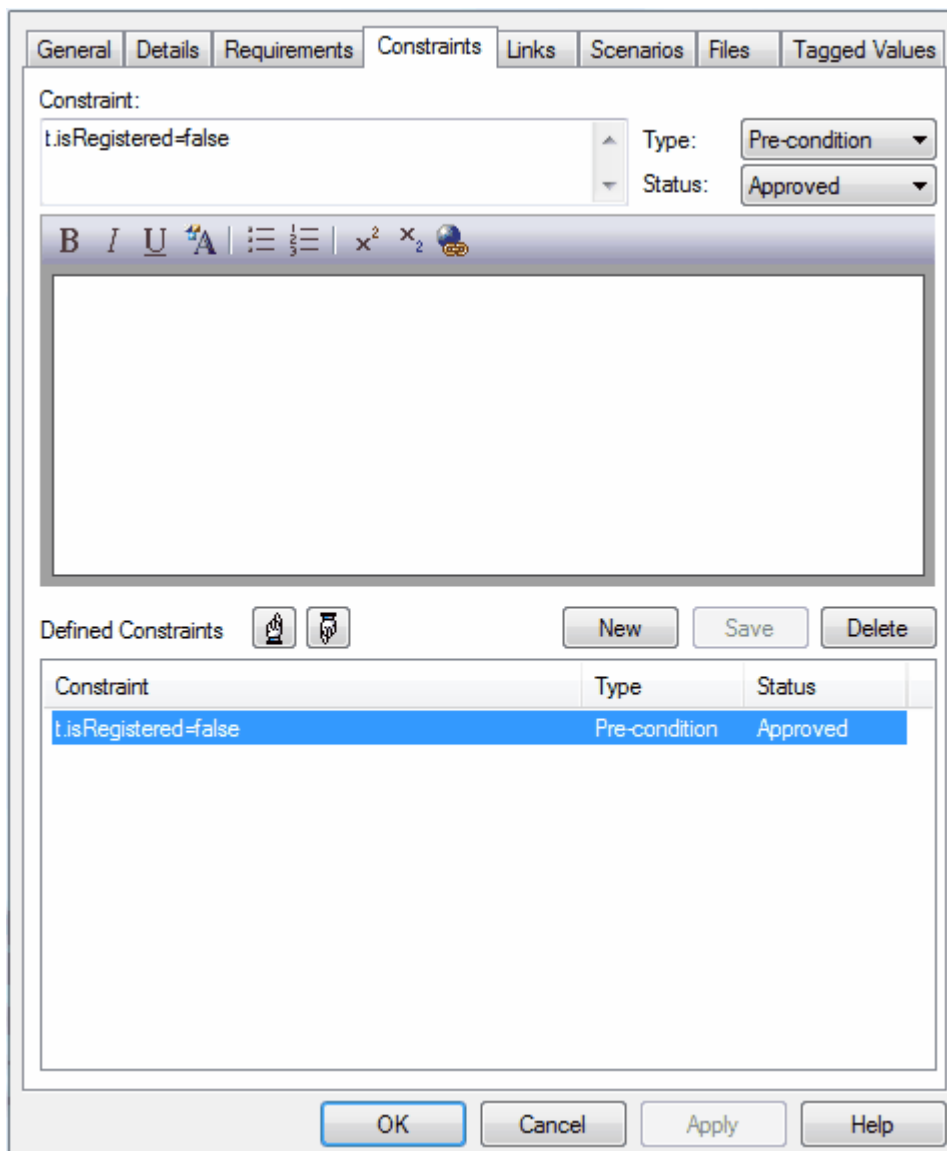

3. In the **Constraint** field, type the value of the constraint.
4. In the **Type** field, click on the drop-down arrow and select the appropriate type.
5. In the **Status** field, click on the drop-down arrow and select the appropriate status.
6. In the **Notes** field, type any additional information required.
7. Click on the **Save** button, and on the **OK** button to close the dialog.

### 5.3.1.1.2.5 Add Enumeration Elements

Enumerations can be used to restrict the values available to stereotype tags.

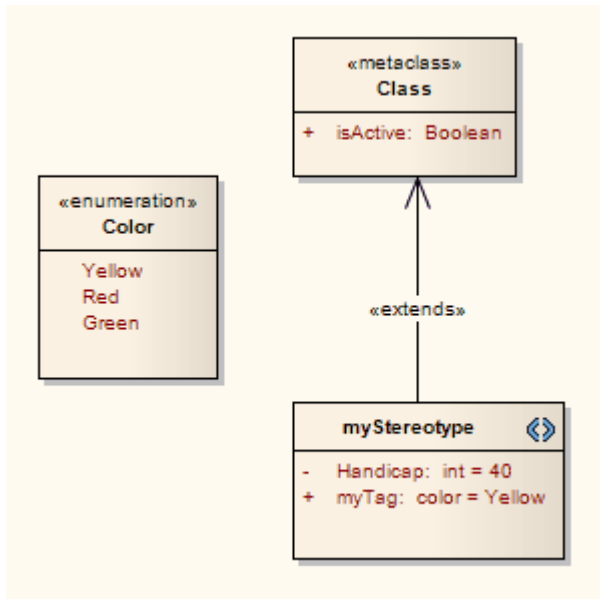

#### Note:

Enumerations defined under a Profile Package do not appear as elements in the profile when imported.

To add an Enumeration element, follow the steps below:

1. Open your Profile Package child Class diagram.
2. In the **Toolbox**, select **More tools | Profile**. The contents of the **Profile** page of the **Toolbox** display.
3. Drag an *Enumeration* item from the toolbox onto the diagram. If the **Properties** dialog does not display, double-click on the element on the diagram.
4. In the **Name** field, type the name of the new Enumeration.
5. Click on the **Details** tab and click on the **Attributes** button. The **Attributes Properties** dialog displays.

Name	Type	Initial Value
Green	int	

6. In the **Name** field, type the name of the Enumeration attribute.
  7. In the **Type** field, click on the drop-down arrow and select the appropriate type.
  8. In the **Initial** field, type the initial value of the attribute.
  9. Click on the **Save** button, and repeat steps 6 to 9 for additional attributes.
  10. When you are finished, click on the **Close** button.
  11. Right-click on the *Stereotype* element and select the **Attributes** context menu option. The **Attribute Properties** dialog displays for the stereotype.
  12. In the **Name** field type a name for the attribute.
  13. In the **Type** field type the name of the Enumeration element.
  14. In the **Initial** field type the name of the first enumeration attribute you defined.
  15. Click on the **Save** and **Close** buttons.
- You have now generated a drop-down list for setting the value of the tag in the **Tagged Values** window.

#### 5.3.1.1.2.6 Add Shape Scripts

To add a [Shape Script](#)<sup>[1147]</sup> to a stereotype in a UML Profile, follow the steps below:

1. On the Profile Package child diagram, select a *Stereotype* element.
2. Right-click on the element and select the **Attributes** context menu option.
3. In the **Attributes Properties** dialog, in the **Name** field, type **\_image**.

The screenshot shows a 'General' tab in a property editor. The 'Name' field contains '\_image'. The 'Type' is set to 'int'. The 'Scope' is 'Private'. The 'Initial' field is empty. Below the text fields is a rich text editor for 'Notes'. At the bottom, there is an 'Attributes' table with one entry: '\_image' of type 'int'. Buttons for 'New', 'Copy', 'Save', and 'Delete' are visible above the table. At the very bottom are 'Close', 'Cancel', and 'Help' buttons.

Name	Type	Initial Value
_image	int	

4. Click on the [ ... ] button next to the **Initial** field. The [Shape Editor](#)<sup>[1150]</sup> dialog displays.
  5. Enter the Shape Script in the **Shape Editor** dialog, and click on the **OK** and **Close** buttons.
- The Stereotype element now resembles the example below:

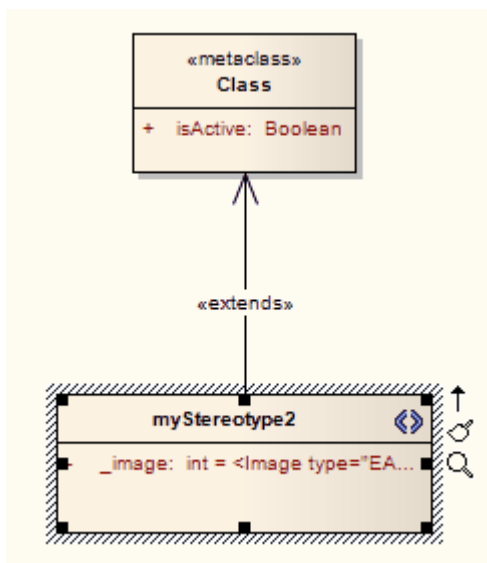

**Note:**

If you are creating a Shape Script for an [Association Class](#) <sup>[856]</sup>, be aware that the Shape Script is applied to both the Class part and the Association part. Therefore, you might have to include logic in the *shape main* that tests the type of the element so that you can give separate drawing instructions for Class and for Association. Such logic is not necessary in the:

- *shape source* or *shape target*, which are ignored by Classes, or the
- *decoration* shapes which are ignored by Associations.

**5.3.1.1.2.7 Set Default Appearance**

You can define the appearance of stereotyped elements and connectors as you [create or edit the stereotypes](#) <sup>[1093]</sup>, using the **Override Appearance** and **Default Colors** panels of the **UML Types** dialog. However, an easier way is to review your completed profile diagram and set the default appearance of the elements and connectors in place.

Simply click on the required element or connector and press **[F4]**, then define the background, font and border colors and border thickness as appropriate, on the [Default Appearance](#) <sup>[538]</sup> dialog.

When you [save the profile](#) <sup>[1106]</sup> containing the stereotyped elements and connectors, make sure that you select the **Color and Appearance** checkbox on the **Save UML Profile** dialog.

**5.3.1.1.2.8 Export a Profile**

Once you have created a Profile and defined the elements and metaclasses, you can save (export) the Profile to disk for future models.

To save a Profile, follow the steps below:

1. If your profile is
  - a single profile spread over multiple diagrams within the same Profile package, find the Profile package in the **Project Browser** window, right-click on it and select the **Save Package as UML Profile** context menu option
  - one of multiple profiles within the same Profile package, right-click anywhere in the background of the Profile diagram and select the **Save as Profile** context menu option
  - a single diagram within the Profile package, choose either the **Save Package as UML Profile** context menu option or the **Save as Profile** context menu option.

**Note:**

The two menu options give slightly different results. See [Save Profile Options](#) <sup>[1107]</sup>.

2. The **Save UML Profile** dialog displays.

The screenshot shows the 'Save UML Profile' dialog box. The 'Profile Name' field contains 'Timing'. The 'Filename' field contains 'C:\Users\vrchester\Documents\Miniclass.xml'. The 'Profile Type' dropdown is set to 'XMI UML(2.0)' and the 'Version' field is '1.0'. There is a 'Notes' text area. Below these is an 'Include' section with four checked checkboxes: 'Element Size', 'Alternate Image', 'Color and Appearance', and 'Code Templates'. At the bottom are 'Save', 'Cancel', and 'Help' buttons.

3. Click on the [ ... ] (Browse) button, and select the export destination for the XML Profile file. If necessary, edit the profile filename, but do not delete the .xml extension.
4. In the **Profile Type** field, click on the drop-down arrow and select **XMI (UML)2.0**.

**Note:**

The drop-down list is not available unless the package has the <<profile>> stereotype.

5. Set the required export options for all stereotypes defined in the profile:
    - **Element Size** - select the checkbox to export the element size attributes
    - **Color and Appearance** <sup>[1106]</sup> - select the checkbox to export the color (background, border and font) and appearance (border thickness) attributes
    - **Alternate Image** - select the checkbox to export the metafile images
    - **Code Templates** - select the checkbox to export the code templates, if they exist.
  6. Click on the **Save** button to save the profile to disk.
- For information on importing and using the profile in modeling, see the [Use Profiles](#) <sup>[907]</sup> topic.

When you save a UML Profile, you can save it either from the package or from the diagram, depending on whether the Profile is:

- a single profile spread over multiple diagrams within the same Profile package (find the Profile *package* in the **Project Browser**, right-click on it and select the **Save Package as UML Profile** context menu option), which is typically the case for a stereotypes profile
- one of multiple profiles within the same Profile package (right-click anywhere in the background of the Profile *diagram* and select the **Save as Profile** context menu option); for example, when creating multiple toolbox profiles
- a single diagram within the Profile Package (choose *either* the **Save Package as UML Profile** context menu option *or* the **Save as Profile** context menu option).

The two context menu options produce slightly different results. You should take these into consideration, especially in the third instance where you could choose either option.

Save From Diagram	Save From Package	Notes
The profile takes the diagram name.	The profile takes the package name.	Package and diagram names are not necessarily the same, although you can save a lot of confusion if you make them the same or very similar. For example: package <i>GL</i> with diagrams <i>GL1</i> , <i>GL2</i> , <i>GL3</i> .
The profile takes the diagram's notes.	The profile takes the package's notes.	
You can take the default size and appearance (including alternate image) from the diagram object.	You cannot take the default size and appearance from the diagram object.  You can use the <code>_sizeX</code> , <code>_sizeY</code> and <code>_image</code> properties, but there is no equivalent for default colors.	
Can be much faster.	Can be much slower.	The difference arises because diagram objects are kept in memory and <b>Project Browser</b> elements aren't.  This is only likely to be an issue if the profile is a large one and you are using a slow network connection to a remote repository.

### 5.3.1.1.2.9 Supported Attributes

#### Supported Stereotype Attributes in UML Profiles

The following attributes can be applied to stereotypes in UML Profiles:

Attribute	Meaning
<b>icon</b>	Contains the path to a bitmap file to be used as the <b>Project Browser</b> icon for all elements other than <i>Package</i> , with the given stereotype. The bitmap must be 16x16 pixels. For a transparent background, use light grey - RGB(192,192,192).
<b>_image</b>	Shape script definition.
<b>_instanceMode</b>	Used for <a href="#">defining behavior on creating an instance</a> [1110].
<b>_instanceOwner</b>	
<b>_instanceType</b>	
<b>_lineStyle</b>	Sets the line style of a connector. The value of the attribute can be one of: <ul style="list-style-type: none"> <li>• <b>direct</b></li> <li>• <b>auto</b></li> <li>• <b>custom</b></li> <li>• <b>bezier</b></li> <li>• <b>treeH</b> (horizontal)</li> <li>• <b>treeV</b> (vertical)</li> <li>• <b>treeLH</b> (lateral horizontal)</li> <li>• <b>treeLV</b> (lateral vertical).</li> </ul>
<b>_metatype</b>	Used for <a href="#">defining stereotypes as metatypes</a> [1109].
<b>_sizeY</b>	Initial height of the element, in pixels at 100% zoom.
<b>_sizeX</b>	Initial width of the element, in pixels at 100% zoom.
<b>_strictness</b>	Used for <a href="#">restricting application of multiple stereotypes</a> [1110].

#### Supported Metatype Attributes in UML Profiles

The following attributes can be applied to metatype Classes in UML Profiles, and refer to the stereotypes that extend them:

Attribute	Meaning
<b>_AttInh</b>	If set to <b>1</b> , switches on the <i>Inherited Features: Show Attributes</i> setting.
<b>_AttPkg</b>	If set to <b>1</b> , switches on the <i>Attribute Visibility: Package</i> setting.
<b>_AttPri</b>	If set to <b>1</b> , switches on the <i>Attribute Visibility: Private</i> setting.
<b>_AttPro</b>	If set to <b>1</b> , switches on the <i>Attribute Visibility: Protected</i> setting.
<b>_AttPub</b>	If set to <b>1</b> , switches on the <i>Attribute Visibility: Public</i> setting.
<b>_ConInh</b>	If set to <b>1</b> , switches on the <i>Show Element Compartments: Inherited Constraints</i> setting.
<b>_Constraint</b>	If set to <b>1</b> , switches on the <i>Show Element Compartments: Constraints</i> setting.
<b>_DefaultDiagramType</b>	Used for <a href="#">defining child diagram types</a> [1111].



Attribute	Meaning
<b>_HideStype</b>	If set to a comma-separated list of stereotypes, sets the <i>Hide Stereotyped Features</i> filter.
<b>_MakeComposite</b>	Used for <a href="#">creating composite elements</a> <sup>[111]</sup> .
<b>_OpInh</b>	If set to <b>1</b> , switches on the <i>Inherited Features: Show Operations</i> setting.
<b>_OpPkg</b>	If set to <b>1</b> , switches on the <i>Operation Visibility: Package</i> setting.
<b>_OpPri</b>	If set to <b>1</b> , switches on the <i>Operation Visibility: Private</i> setting.
<b>_OpPro</b>	If set to <b>1</b> , switches on the <i>Operation Visibility: Protected</i> setting.
<b>_OpPub</b>	If set to <b>1</b> , switches on the <i>Operation Visibility: Public</i> setting.
<b>_PType</b>	If set to <b>1</b> , switches on the <i>Show element type (Port and Part only)</i> setting.
<b>_ResInh</b>	If set to <b>1</b> , switches on the <i>Show Element Compartments: Inherited Responsibilities</i> setting.
<b>_Responsibility</b>	If set to <b>1</b> , switches on the <i>Show Element Compartments: Responsibilities</i> setting.
<b>_Runstate</b>	If set to <b>1</b> , switches on the <i>Hide Object Runstate in current diagram</i> setting.
<b>_SourceAggregation</b>	Used to set the aggregation type at the end of a connector; do not set <i>both</i> <b>_SourceAggregation</b> and <b>_TargetAggregation</b> . Set to <b>1</b> for shared, <b>2</b> for composite.
<b>_SourceMultiplicity</b>	Used to set the multiplicity of the source element, such as <b>1..*</b> or <b>0..1</b> .
<b>_SourceNavigability</b>	If the connector is non-navigable, set this attribute to <b>Non-Navigable</b> . For other values, set the <a href="#">direction</a> <sup>[173]</sup> attribute.
<b>_Tag</b>	If set to <b>1</b> , switches on the <i>Show Element Compartments: Tags</i> setting.
<b>_TagInh</b>	If set to <b>1</b> , switches on the <i>Show Element Compartments: Inherited Tags</i> setting.
<b>_TargetAggregation</b>	Used to set the aggregation type at the end of a connector; do not set <i>both</i> <b>_SourceAggregation</b> and <b>_TargetAggregation</b> . Set to <b>1</b> for shared, <b>2</b> for composite.
<b>_TargetMultiplicity</b>	Used to set the multiplicity of the target element, such as <b>1..*</b> or <b>0..1</b> .
<b>_TargetNavigability</b>	If the connector is non-navigable, set this attribute to <b>Non-Navigable</b> . For other values, set the <a href="#">direction</a> <sup>[173]</sup> attribute.

The **\_metatype** attribute is applied to a stereotype element. This is used where users want to hide the identity of an element as a stereotyped UML element. It is also a method of getting custom types to appear in contexts where only Enterprise Architect's inbuilt types would normally appear; for example in the lists of element types in the [Relationship Matrix](#).

In the following example from SysML, *block* is defined as a stereotype that extends a UML Class.

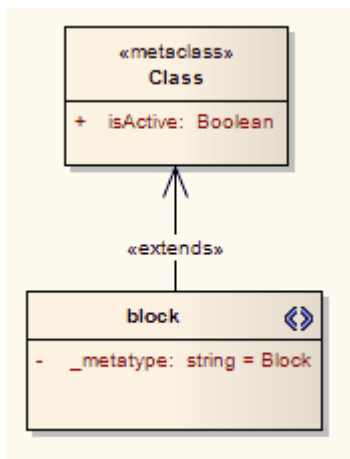

However, a SysML user isn't interested in UML Classes, only in SysML Blocks. An element created from a stereotype defined this way, while behaving like a stereotyped Class in most contexts:

- Shows *Block Properties* rather than *Class Properties* as the title of its **Properties** dialog
- Is auto-numbered as *Block1* not *Class1* on creation, and
- Appears as *Block* not *Class* in many other contexts throughout Enterprise Architect.

The **\_strictness** attribute is applied to a stereotype element. It defines to what level multiple stereotypes can be applied to an element. The type of the attribute is *StereotypeStrictnessKind* and it can have one of four values:

- *profile*, which states that an element of this type cannot be given more than one different stereotype from the same profile
- *technology*, which states that an element of this type cannot be given more than one different stereotype from the same technology
- *all*, which states that an element of this type cannot have multiple stereotypes at all, or
- *none*, which is the default Enterprise Architect behaviour and states that there are no restrictions on the use of multiple stereotypes.

The following example is from SysML and shows that a «flowPort» cannot have any other stereotype applied to it.

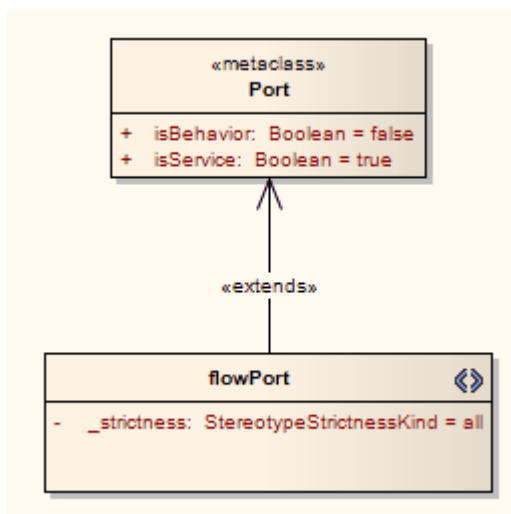

The **\_instanceType** attribute is applied to a stereotype element and defines what kind of element is created as an instance of this element type. The value corresponds to the metatype given to a stereotype using the **\_metatype** attribute. It is shown on the [Paste Element](#)<sup>[430]</sup> dialog and is translated if it matches an Enterprise Architect element type.

The `_instanceMode` attribute is applied to a stereotype element and controls the text in the **Paste Element** dialog after being translated. Valid values are **instance** and **property**, with the default being **instance**.

The `_instanceOwner` attribute is applied to a stereotype element and controls the text in the **Paste Element** dialog. It is translated if it matches an Enterprise Architect element type. The default value is **Element**.

The following example from SysML shows that when an instance of a Block is created, it is created as a **BlockProperty** element.

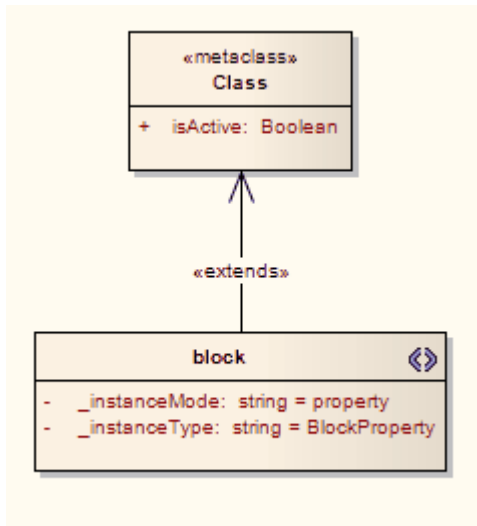

The `_makeComposite` attribute is applied to a metaclass element, not a stereotype element. It defines whether an element is always made composite when created.

#### Notes:

- A stereotyped package is not by default created with a child diagram, so you should use the `_makeComposite` attribute to ensure the child diagram is created.
- Unless you also use the `_defaultDiagramType` attribute to [define the child diagram type](#)<sup>[1111]</sup>, the child diagram created is a Package diagram.

The following example from BPMN shows that a *BusinessProcess* element is always created as a Composite element with a BPMN custom child diagram.

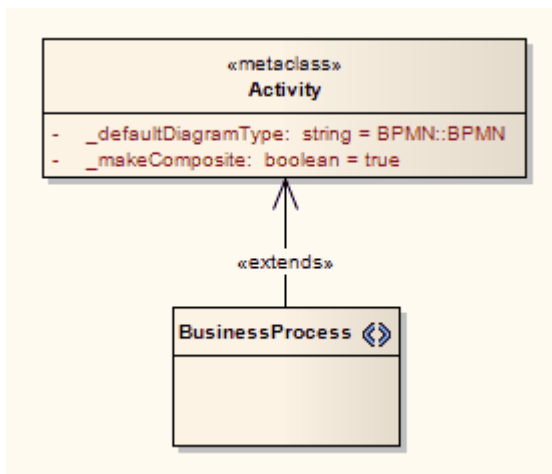

The `_defaultDiagramType` attribute is applied to a metaclass element, not a stereotype element. It defines the type of diagram created when an element is [made composite](#)<sup>[1111]</sup>.

This attribute can take as its name any of the inbuilt diagram types of Enterprise Architect as listed in *Values*

For `_defaultDiagramType`, below.

Alternatively, if a custom diagram type is required, it should be prefixed with the *diagram profile name* and '::`'.`

**Note:**

The *diagram profile name* is the name given to the profile when you save it, which by default is the name of the profile package or profile diagram. If you follow the recommendation in [Create Diagram Profiles](#) <sup>[1138]</sup>, the diagram profile name is based on the technology name, but be aware that the attribute prefix is **not** a **direct** reference to the technology name.

The following examples show a `«BusinessProcess»Activity` that, when made a composite element, automatically creates an Analysis diagram, and a `«block»` stereotype that creates a SysML *InternalBlock* custom diagram.

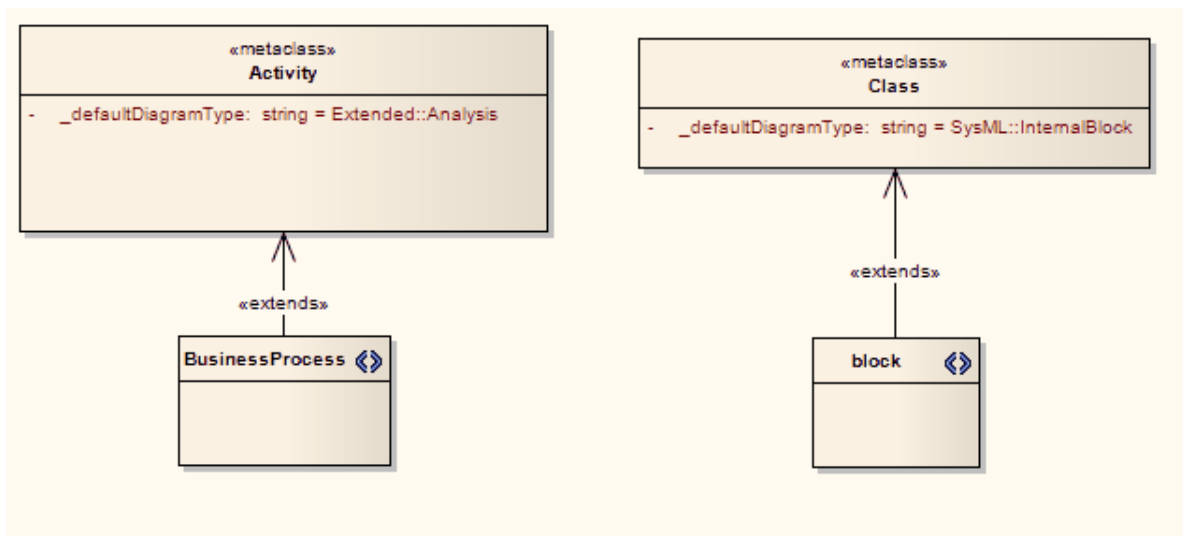

You can also use the `_defaultDiagramType` attribute for packages, extending the Package metaclass.

### Values For `_defaultDiagramType`

The following initial values should be used to refer to Enterprise Architect's inbuilt diagram types:

- UML Behavioral::Use Case
- UML Behavioral::Activity
- UML Behavioral::State Machine
- UML Behavioral::Communication
- UML Behavioral::Sequence
- UML Behavioral::Timing
- UML Behavioral::Interaction Overview
- UML Structural::Package
- UML Structural::Class
- UML Structural::Object
- UML Structural::Composite Structure
- UML Structural::Component
- UML Structural::Deployment
- Extended::Custom
- Extended::Requirements
- Extended::Maintenance
- Extended::Analysis
- Extended::User Interface
- Extended::Data Modeling
- Extended::ModelDocument.

### 5.3.1.1.2.10 Stereotype Profiles

In Enterprise Architect 6, an MDG Technology could consist of many UML Profiles, each representing an **Toolbox** page. Each profile could include stereotype definitions alongside redefinitions of standard UML elements. This meant that to define a stereotype in a technology, it had to appear in one of the **Toolbox** pages.

Releases from Enterprise Architect 7 take a different approach, splitting the task of defining the stereotypes and the task of defining the **Toolbox** pages into separate profiles. The MDG Technology's stereotypes are contained in one or more profiles. The stereotypes within each profile use the profile name as the namespace.

Create one or more packages with the «*profile*» stereotype, each package name being the namespace. Within each package create profile diagrams defining all the stereotypes in the namespace. You can use multiple diagrams to do this, but do not use nested packages.

Give the «*profile*» package a description in the **Notes** field (e.g. *MDG Technology for BPMN*). When all of the stereotypes are defined (make sure that every stereotype extends at least one *Metaclass*) right-click on the profile package in the **Project Browser** and select the **Save Package as UML Profile** context menu option, then proceed as usual.

### 5.3.1.1.3 Quick Linker

#### Introduction

The Quick Linker provides a fast and simple way to create new elements and connectors on a diagram.

When an element is selected in a diagram, the Quick Linker arrow is displayed in the upper right corner of a element. Simply clicking and dragging the arrow enables you to create new connectors and elements. The philosophy behind the built-in Quick Linker definitions is to provide, not a complete list of valid or legal connections, but a short and convenient list of the commonest connections for the given context.

As part of a UML Profile, you can add to or replace the built-in Quick Linker definitions, as explained in the following sections:

- [Quick Linker Definition Format](#) <sup>[1113]</sup>
- [Quick Linker Example](#) <sup>[1115]</sup>
- [Hide Default Quick Linker Settings](#) <sup>[1117]</sup>
- [Quick Linker Object Names](#) <sup>[1117]</sup>.

#### Customized Quick Linker Settings

A Quick Linker definition is a Comma Separated Value (CSV) format file. It is best manipulated in a spreadsheet which should be set up to save the CSV file as comma-separated text without quotation marks around text fields.

To add a Quick Linker definition file to a profile or technology, simply place a *DocumentArtifact* element onto the *Profile* diagram. Give it the name *QuickLink* then double-click on it. Open your CSV file in a text editor such as Notepad and copy and paste the contents into the *DocumentArtifact* element. The definitions are saved with the profile and are processed and applied when the profile is imported. The same applies if a profile is included within a technology, with the proviso that the QuickLink element must be in the same profile as the link stereotype definitions. This means that a technology could have a set of Quick Link definitions for each profile.

#### 5.3.1.1.3.1 Quick Linker Definition Format

A Quick Linker definition is a text file consisting of records terminated by new-line characters. Each record must consist of 23 comma-separated fields, as defined by the table below. The values of each field must not be in quotes (" "). A Quick Linker definition can include comments: all lines that begin with // are ignored by Enterprise Architect.

Each record of the Quick Linker definition represents a single entry on the Quick Linker menu. Some fields define the menu command; some fields can be thought of as filters, with the entry being ignored if the filter condition isn't met.

A Quick Linker definition has the following fields.

Column	Field	Description
A	Source Element	The row is ignored unless a connector is being dragged away from this

Column	Field	Description
	<b>Type</b>	type of element.
<b>B</b>	<b>Source Stereotype Filter</b>	If set, the row is ignored unless a connector is being dragged away from an element with this stereotype.
<b>C</b>	<b>Target Element Type</b>	If set, the row is ignored unless a connector is being dragged onto this type of element.  If blank, the row is ignored unless a connector is being dragged onto an empty piece of diagram.
<b>D</b>	<b>Target Stereotype Filter</b>	If set and <b>Target Element Type</b> also set, the row is ignored unless a connector is being dragged onto an element with this stereotype.
<b>E</b>	<b>Diagram Filter</b>	Contains either an inclusive or exclusive list of diagrams, which limits the diagrams the given kind of connector can be included on.  Each diagram name is terminated by a semi-colon. Excluded diagram names are preceded by an exclamation mark.  Example of an inclusive list: <i>Collaboration;Object;Custom;</i> Example of an Exclusive list: <i>!Sequence;</i>
<b>F</b>	<b>New Element Type</b>	If set and <b>Create Element</b> also set, results in the creation of an element of this type.
<b>G</b>	<b>New Element Stereotype</b>	If set and <b>Create Element</b> also set, results in the creation of an element with this stereotype.
<b>H</b>	<b>New Link Type</b>	If set and <b>Create Link</b> also set, results in the creation of a connector of this type.
<b>I</b>	<b>New Link Stereotype</b>	If set and <b>Create Link</b> also set, results in the creation of a connector with this stereotype.
<b>J</b>	<b>New Link Direction</b>	Can be: <ul style="list-style-type: none"> <li>• directed (always creates an association from source to target)</li> <li>• from (always creates an association from target to source)</li> <li>• undirected (always creates an association with unspecified direction)</li> <li>• bidirectional (always creates a bi-directional association), or</li> <li>• to (creates either a directed or undirected association, depending on the value of the <b>Association Direction</b> option).</li> </ul> <p><b>Note:</b> Not all of the above work with all connector types; for example, you cannot create a bi-directional Generalization.</p>
<b>K</b>	<b>New Link Caption</b>	If a new connector is being created but not a new element, then this is the text that appears on the context menu.
<b>L</b>	<b>New Link &amp; Element Caption</b>	If a new connector AND a new element are being created, then this is the text that appears on the context menu.
<b>M</b>	<b>Create Link</b>	If set to <b>TRUE</b> , results in creation of a new connector; otherwise should be left blank.
<b>N</b>	<b>Create Element</b>	If set to <b>TRUE</b> the row is ignored unless a connector is being dragged onto an empty piece of diagram and results in creation of a new element; otherwise should be left blank.  This overrides the values of <b>Target Element Type</b> and <b>Target Stereotype Filter</b> .

Column	Field	Description
O	Disallow Self connector	Should be set to <b>TRUE</b> if self connectors are invalid for this kind of connector; otherwise should be left blank.
P	Exclusive to ST Filter + No inherit from Metatype	If set to <b>TRUE</b> , indicates that elements of type <i>Source Element Type</i> with the stereotype <i>Source Stereotype Filter</i> do not display the Quick Linker definitions of the equivalent unstereotyped element.
Q	Menu Group	If set, indicates the name of a sub-menu in which a menu item is created.
R	Complexity Level	Not implemented, always set to 0.
S	Target Must Be Parent	If set to <b>TRUE</b> this menu item only appears when dragging from a child element to its parent; for example from a port to its containing Class.
T	Embed element	If set to <b>TRUE</b> the element being created is embedded in the target element; otherwise should be left blank.
U	Precedes Separator LEAF	If set to <b>TRUE</b> results in a menu separator being added to the Quick Linker menu; otherwise should be left blank.
V	Precedes Separator GROUP	If set to <b>TRUE</b> results in a menu separator being added to the Quick Linker sub-menu; otherwise should be left blank.
W	Dummy Column	Depending on which spreadsheet application you use, this column might require a value in every cell to force CSV export to work correctly with trailing blank values.

### 5.3.1.1.3.2 Quick Linker Example

This example uses a Class element with the stereotype «*quick*». The example scenario is this: when you drag a connector away from one of these elements, you want to create a Dependency either to or from a component element. When you drag a connector onto an existing *Port* or component element, you want a Dependency either to or from the component **or**, in the case of a component, you want to be able to create an embedded Port element.

This results in 8 records in the [Quick Linker definition](#) <sup>[1113]</sup> file.

1. Dependency to new Component
2. Dependency from new Component
3. Dependency to existing Component
4. Dependency from existing Component
5. Dependency to existing Port
6. Dependency from existing Port
7. Dependency to existing Component, create new Port
8. Dependency from existing Component, create new Port

In the spreadsheet, this is implemented by the following values:

	A	B	C	E	F	H	J	K
1	//Source Element Type	Source ST filter	Target Element Type	Diagram Filter	New Element Type	New Link Type	New Link Direction	New Link Caption
2	Class	quick			Component	Dependency	to	
3	Class	quick			Component	Dependency	from	
4	Class	quick	Component			Dependency	to	Dependency to
5	Class	quick	Component			Dependency	from	Dependency from
6	Class	quick	Port			Dependency	to	Dependency to
7	Class	quick	Port			Dependency	from	Dependency from
8	Class	quick	Component		Port	Dependency	to	
9	Class	quick	Component		Port	Dependency	from	

	L	M	N	O	P	Q	R	S	T	U	V
1	New Link & Element Caption	Create Link	Create Element	Disallow Self connector	No inherit from metatype	Menu Group	Complexity Level	Target Must Be Parent	Embed element	Precedes Separator LEAF	Precedes Separator GROUP
2	Dependency to	TRUE	TRUE	TRUE	TRUE	Component	0				
3	Dependency from	TRUE	TRUE	TRUE	TRUE	Component	0			TRUE	
4		TRUE		TRUE	TRUE		0				
5		TRUE		TRUE	TRUE		0			TRUE	
6		TRUE		TRUE	TRUE		0				
7		TRUE		TRUE	TRUE		0			TRUE	
8	Dependency to	TRUE	TRUE	TRUE	TRUE	Port	0		TRUE		
9	Dependency from	TRUE	TRUE	TRUE	TRUE	Port	0		TRUE	TRUE	

This saves to the following CSV:

```
Class,quick,,,,Component,,Dependency,,to,,Dependency to,TRUE,TRUE,TRUE,TRUE,Component,0,,,,
Class,quick,,,,Component,,Dependency,,from,,Dependency from,TRUE,TRUE,TRUE,TRUE,Component,0,,,TRUE,,
Class,quick,Component,,,,Dependency,,to,Dependency to,,TRUE,,TRUE,TRUE,,0,,,,
Class,quick,Component,,,,Dependency,,from,Dependency from,,TRUE,,TRUE,TRUE,,0,,,TRUE,,
Class,quick,Port,,,,Dependency,,to,Dependency to,,TRUE,,TRUE,TRUE,,0,,,,
Class,quick,Port,,,,Dependency,,from,Dependency from,,TRUE,,TRUE,TRUE,,0,,,TRUE,,
Class,quick,Component,,Port,,Dependency,,to,,Dependency to,TRUE,TRUE,TRUE,TRUE,Port,0,,TRUE,,,
Class,quick,Component,,Port,,Dependency,,from,,Dependency from,TRUE,TRUE,TRUE,TRUE,Port,0,,TRUE,TRUE,,
```

You can create the following profile and cut and paste the CSV data into the document artifact to test the effect.

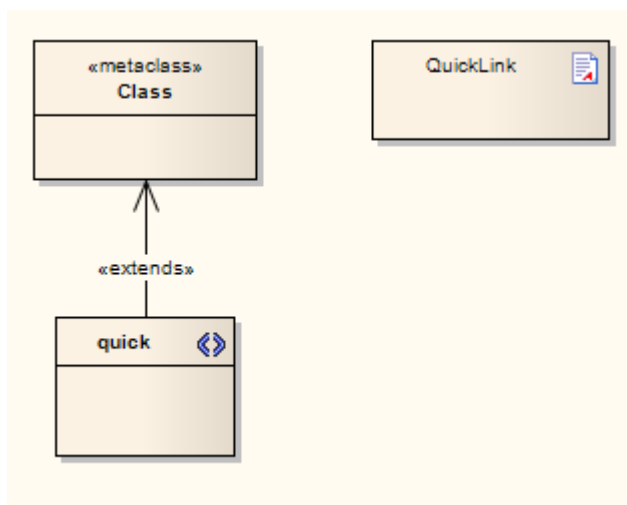



### 5.3.1.1.3.3 Hide Default Quick Linker Settings

If you have a Quick Linker definition with the *Exclusive to stereotype* flag (column P) set to **TRUE**, then the default Quick Linker definitions between the given source and target are overridden. However, you might want to override the defaults without actually having a Quick Linker definition. For example, if you don't define any Quick Links for a «*quick*» Class to another «*quick*» Class, Enterprise Architect displays the default Quick Links for a Class to another Class. To override this behaviour, create a Quick Linker definition that has the source element type, source stereotype filter, target element type and target stereotype filter fields (columns A, B, C and D) all set, with the **Exclusive to stereotype** flag (column P) set to **TRUE**, and with the new link type field (column H) set to **<none>**.

For example, add this line to the example in [Quick Linker Example](#)<sup>[1115]</sup>:

```
Class,quick,Interface,,,,,<none>,,,,,TRUE,,0,,,,
```

This overrides the default Class-to-Interface Quick Links when a Quick Link is dragged from a «*quick*» Class to an Interface element.

#### Note:

This technique does not affect the automatic appearance of Dependency, Trace, Information Flow and Help items on the Quick Linker menu.

### 5.3.1.1.3.4 Quick Linker Object Names

#### List of Element Types

The following element names can be used in Quick Linker definitions:

Action	ExecutionEnvironment	Package
ActionPin	ExitPoint	Part
Activity	ExitState	Port
ActivityParameter	ExpansionNode	PrimitiveType
ActivityPartition	ExpansionRegion	ProvidedInterface
Actor	Feature	Receive
Artifact	GUIElement	RequiredInterface
Boundary	HistoryState	Requirement
CentralBufferNode	InformationItem	Screen
Change	InitialActivity	Send
ChoiceState	InitialState	Sequence
Class	InteractionOccurrence	Signal
Collaboration	Interface	State
Component	Issue	StateLifeline
DataType	InterruptableActivityRegion	StateMachine
Decision	JunctionState	Synchronization_H
DeepHistoryState	MergeNode	Synchronization_V
Deployment Specification	MessageEndpoint	SynchState
Device	n-ary Association	UMLDiagram
DiagramGate	Node	UseCase
EntryPoint	Object	ValueLifeline
EntryState	ObjectNode	

#### List of Connector Types

The following connector names can be used in Quick Linker definitions:

Aggregation	Deployment	Realization
Association	Extension	Redefinition
AssociationClass	Generalization	Sequence
CommunicationPath	InterfaceLink	StateFlow
Composition	Manifest	UCExtends
ConnectorLink	Nesting	UCIncludes
ControlFlow	ObjectFlow	UseCase
DelegateLink	PackageImport	
Dependency	PackageMerge	

### 5.3.1.2 MDG Technologies - Creating

The Model Driven Generation (MDG) Technologies enable Enterprise Architect users to access and use resources pertaining to a specific technology in Enterprise Architect. There are various options for an administrator or individual user to bring MDG Technologies into use with Enterprise Architect, as described in the [MDG Technologies - Using](#) topic. You should read the MDG Technology topics to understand how MDG Technologies are accessed and used within Enterprise Architect, especially the [Manage MDG Technologies](#) topic.

A further option is that Technology Developers can develop new MDG Technologies and deploy them to the project team as appropriate; this is described in the following topics:

- [Create MDG Technologies](#)
- [Working With MTS Files](#)
- [Customize Toolbox Profiles](#)
- [Create Diagram Profiles](#)
- [Create Tasks Pane Profiles](#)
- [Define Validation Configuration](#)
- [Incorporate Model Templates](#)
- [Deploy an MDG Technology](#)

An example of creating an MDG Technology for an Enterprise Architecture framework is provided in the white paper: [Enterprise Architecture Framework Design with Sparx Systems Enterprise Architect](#).

#### 5.3.1.2.1 Create MDG Technologies

Using the MDG Technology Wizard, you can create MDG Technology files that can include UML Profiles, code modules, Patterns, images, Tagged Value Types, RTF report templates, linked document templates, **Toolbox** pages and **Task Pane** pages. To create an MDG Technology file, follow the steps below:

1. Select the **Tools | Generate MDG Technology File** menu option. The **MDG Technology Creation Wizard** screen displays.

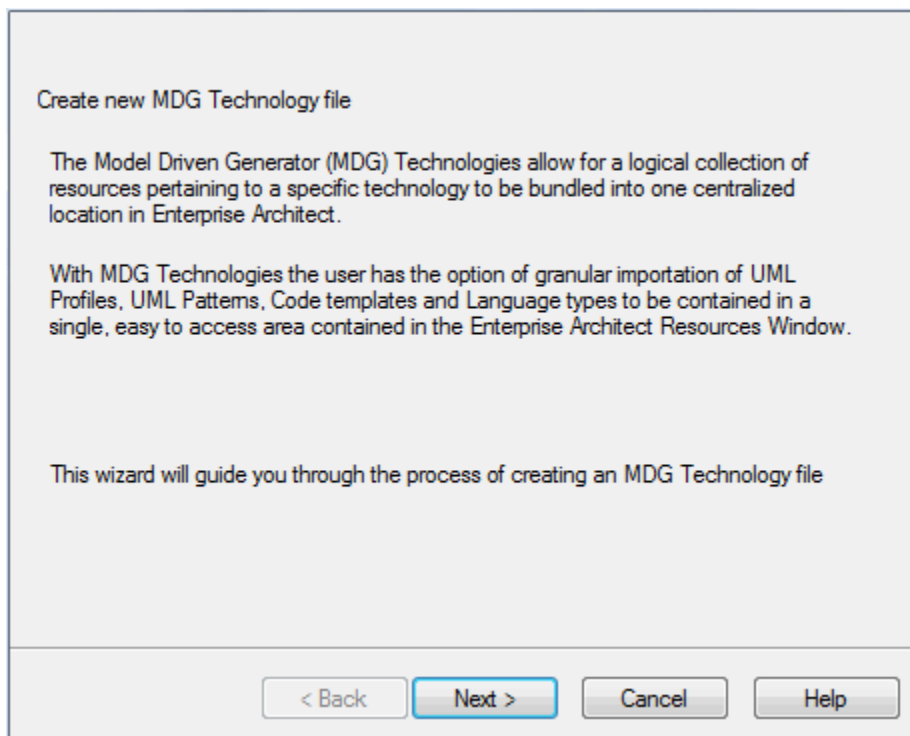

2. Click on the **Next** button to proceed. The **MDG Technology Wizard** prompts you to:
  - Create an MDG Technology File by creating a new MDG Technology Selection (MTS) file
  - Create an MDG Technology File using an existing MTS file
  - Not use any MTS file.

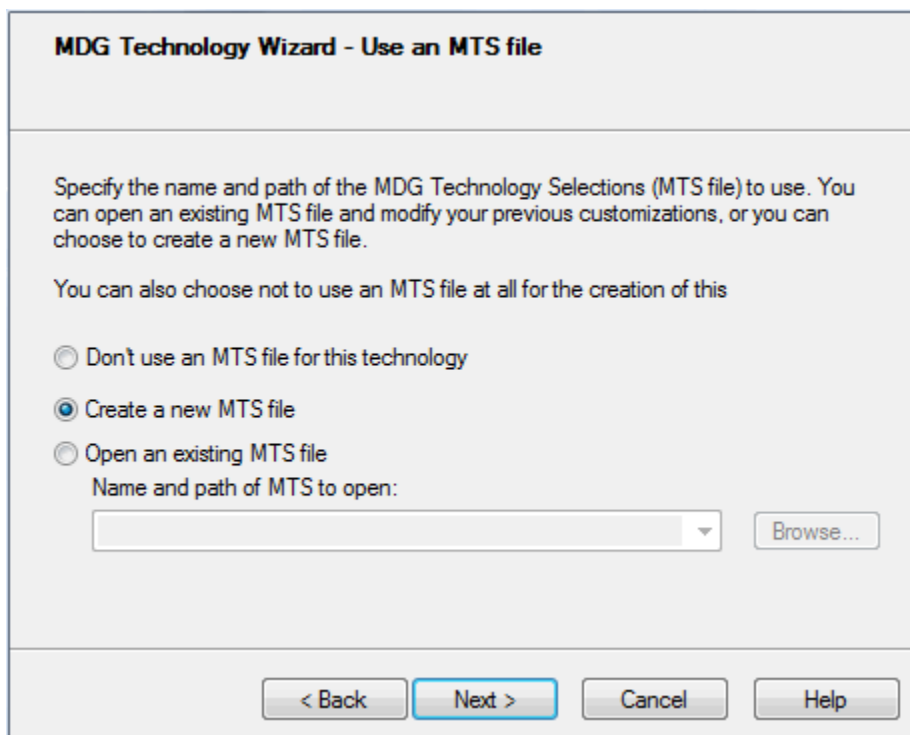

(An MTS file stores the selected options that you define during the creation of an MDG Technology File. If you use an MTS file, you can later modify it to add or remove specific items in the MDG Technology File. This is the recommended process.)

3. Select the appropriate MTS file option. Click on the **Next** button.

If you selected an MTS file, the **MDG Technology Wizard** prompts you to save the changes in the existing MTS file or into a new MTS file. This enables you to create a modification based on the existing MTS file, while preserving the original file.

The screenshot shows a dialog box titled "MDG Technology Wizard - Save MTS file". The main text reads: "You can save your changes in the MTS file that you opened, or enter the name and path of a new MTS file." Below this, there is a text input field labeled "Name and path of MTS to save:" containing the text "Y:\Dev\Roy\MY\_MTS.mts". To the right of the input field is a "Browse..." button. At the bottom of the dialog, there are four buttons: "< Back", "Next >", "Cancel", and "Help".

4. If necessary, type in or browse for the required file path and name. Click on the **Next** button. The **MDG Technology Wizard - Create** screen displays.

The screenshot shows a dialog box titled "MDG Technology Wizard - Create" with the subtitle "Please specify the technology to be created". The form contains the following fields:

- Technology: MDG Technology For Workflows
- Filename: Y:\UML Profiles\WKFL\MDG Technology For Workflows.xml (with a browse button)
- ID: WKFL
- Version: 0.1
- Icon: Y:\Dev\Help\Source\EA Next\Help\_Graphics\uml\_profiles.bn (with a browse button)
- Logo: Y:\Dev\Help\Source\EA Next\Help\_Graphics\Banner1.BMP (with a browse button)
- URL: (empty)
- Support: (empty)
- Notes: Technology to generate and collate project development workflows.

At the bottom, there are four buttons: "< Back", "Next >", "Cancel", and "Help".

5. Complete the fields on this screen as follows:

Option	Use to
<b>Technology</b>	Type the name of the MDG Technology.
<b>Filename</b>	Type or select the path and filename of the MDG Technology File (the file extension for this file is .xml).
<b>ID</b>	Type a reference for the MDG Technology File, up to 12 characters long.
<b>Version</b>	Type the version number of the MDG Technology File.
<b>Icon</b>	(Optional) Type or select the path and file name of the graphics file containing the technology icon. The icon is a 16x16 bitmap image that is shown in the list of technologies on the left of the <b>MDG Technologies</b> dialog.
<b>Logo</b>	(Optional) Type or select the path and file name of the graphics file containing the technology logo. The logo is a 64x64 bitmap image that is shown in the display pane on the top-right corner of the <b>MDG Technologies</b> dialog.
<b>URL</b>	(Optional) If you have any website product information that might be helpful for users of this Technology, type or paste the URL in this field.
<b>Support</b>	(Optional) If you have any web-based or other support facility that might be helpful for users of this Technology, type or paste the contact address in this field.
<b>Notes</b>	Type a short explanation of the functionality of the MDG Technology.

6. Click on the **Next** button. The **MDG Technology Wizard - Contents** screen displays.

**MDG Technology Wizard - Contents**  
Select the information to be included in your technology

**Metamodel**

- Profiles
- Patterns
- Diagram Types
- Toolboxes
- Taskpages
- Tagged Value Types

**Code**

- Code Modules
- MDA Transforms

**Reports**

- RTF Templates
- Linked Document Templates

**Other**

- Images
- Scripts

< Back    Next >    Cancel    Help

7. Select the checkbox for each item to be included in the MDG Technology file. Each selection runs specific dialogs to enable definition of the specific items to be included in the MDG Technology, as described in the following topics:

- [Add a Profile](#) <sup>[1122]</sup>
- [Add a Pattern](#) <sup>[1123]</sup>

- [Add a Diagram Profile](#) <sup>[1124]</sup>
  - [Add a Toolbox Profile](#) <sup>[1125]</sup>
  - [Add Task Panel Pages](#) <sup>[1126]</sup>
  - [Add Tagged Value Types](#) <sup>[1127]</sup>
  - [Add Code Modules](#) <sup>[1128]</sup>
  - [Add MDA Transformations](#) <sup>[1130]</sup>
  - [RTF Report Templates](#) <sup>[1132]</sup>
  - [Linked Document Templates](#) <sup>[1133]</sup>
  - [Add Images](#) <sup>[1130]</sup>
  - [Add Scripts](#) <sup>[1131]</sup> (Corporate and 'Suite' editions).
8. Work through the dialogs displayed in response to your choices, and when all are complete, click on the **Next** button. The **MDG Technology Wizard - Finish** screen displays, providing information on the items included in the MDG Technology File.

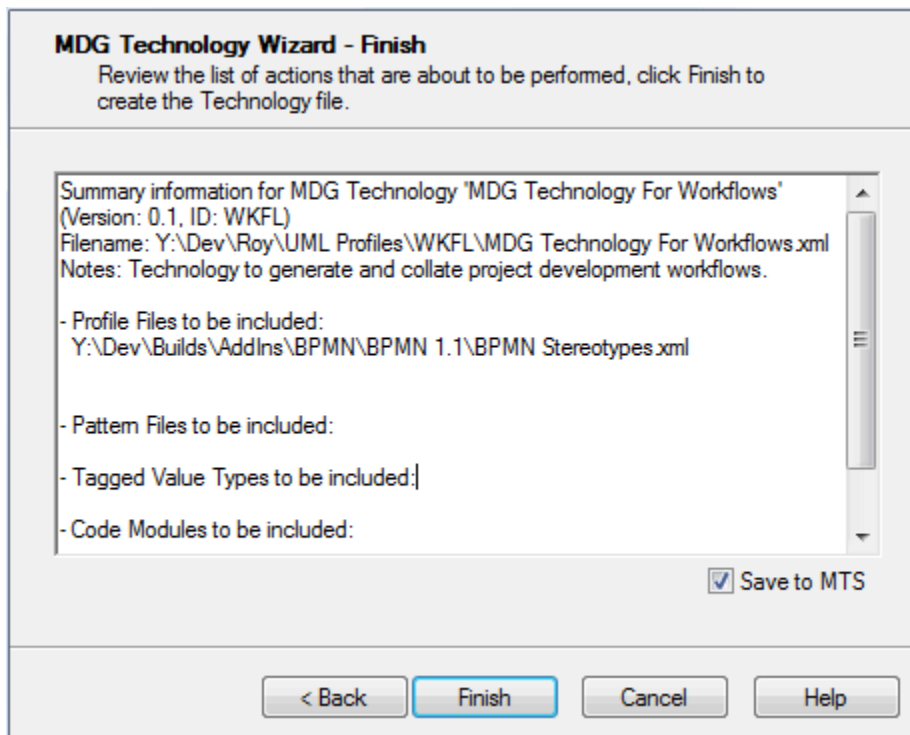

9. If you have used an MTS file and want to update it, select the **Save to MTS** checkbox.
10. If you are satisfied with the selection of items, click on the **Finish** button.

You can now [edit the MTS file](#) <sup>[1133]</sup>, if required, to add further items such as:

- Model Search definitions
- Model Views
- Model Validation configurations
- Model Templates.

To make the MDG Technology File accessible to an Enterprise Architect model, you must *add* the technology file path to the **MDG Technologies - Advanced** dialog. See the [Access Remote MDG Technologies](#) <sup>[1070]</sup> topic.

### 5.3.1.2.1.1 Add a Profile

When creating an MDG Technology file, you can include UML 2.3-compliant profiles [that you have defined](#) <sup>[1095]</sup>. To use the Profiles section of the MDG Technology Wizard, follow the steps below:

1. Follow the steps in the *Create MDG Technologies* topic up to and including [Step 6](#) <sup>[1121]</sup>, where you select the Profiles checkbox. The **MDG Technology Wizard - Profile files selection** dialog displays.

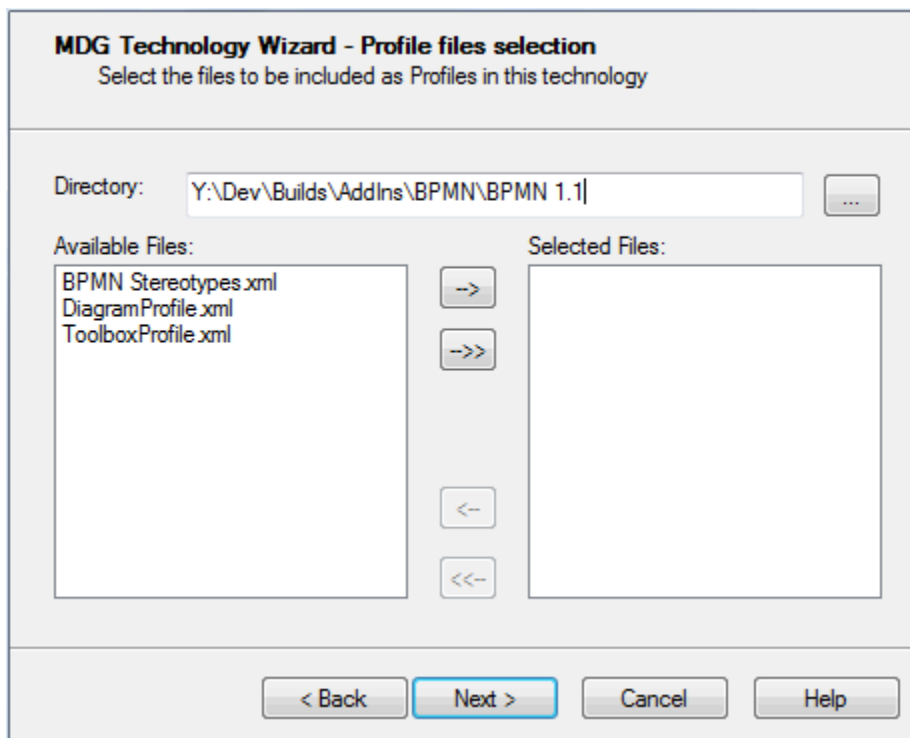

2. In the **Directory** field, navigate to the directory containing the required Profile or Profiles. The Profile files are automatically listed in the **Available Files** panel.
3. To select each required Profile individually, highlight the Profile in the **Available Files** list and click on the --> button. The file name displays in the **Selected Files** list. Alternatively, to select all available Profiles, click on the -->> button.

**Notes:**

- DO NOT select diagram profiles or toolbox profiles on this dialog; this would generate conflicting commands in the .MTS file.
- Make sure you do include your [stereotype profile](#)<sup>[1113]</sup>.

4. Click on the **Next** button to proceed.

### 5.3.1.2.1.2 Add a Pattern

When creating an MDG Technology file, you can include [patterns](#)<sup>[902]</sup>. To use the *Patterns* section of the MDG Technology Wizard, follow the steps below:

1. Follow the steps in the *Create MDG Technologies* topic up to and including [Step 6](#)<sup>[112]</sup>, where you select the **Patterns** checkbox. The **MDG Technology Wizard - Pattern files selection** dialog displays.

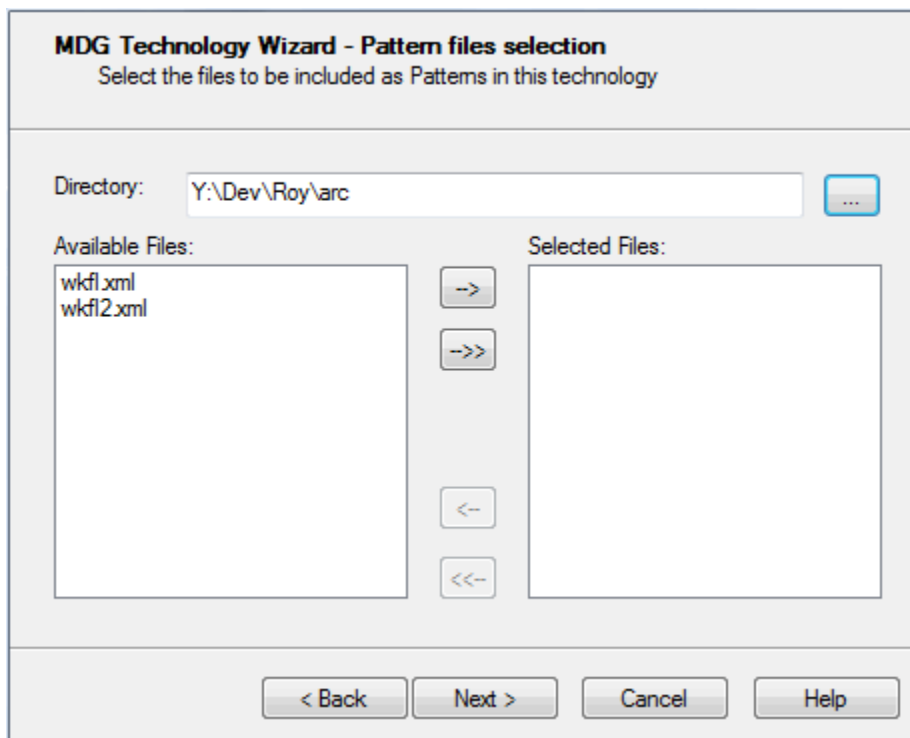

2. In the **Directory** field, navigate to the directory containing the required pattern or patterns. The pattern files are automatically listed in the **Available Files** panel.
3. To select each required pattern individually, highlight the pattern in the **Available Files** list and click on the --> button. The file name displays in the **Selected Files** list. Alternatively, to select all available patterns, click on the -->> button.
4. Click on the **Next** button to proceed.

#### 5.3.1.2.1.3 Add a Diagram Profile

When creating an MDG Technology file, you can include a diagram profile [that you have defined](#)<sup>[11139]</sup>. To use the diagram profiles section of the MDG Technology Wizard, follow the steps below:

1. Follow the steps in the *Create MDG Technologies* topic up to and including [Step 6](#)<sup>[1121]</sup>, where you select the **Diagram Types** checkbox. The **MDG Technology Wizard - Diagram Types** dialog displays.



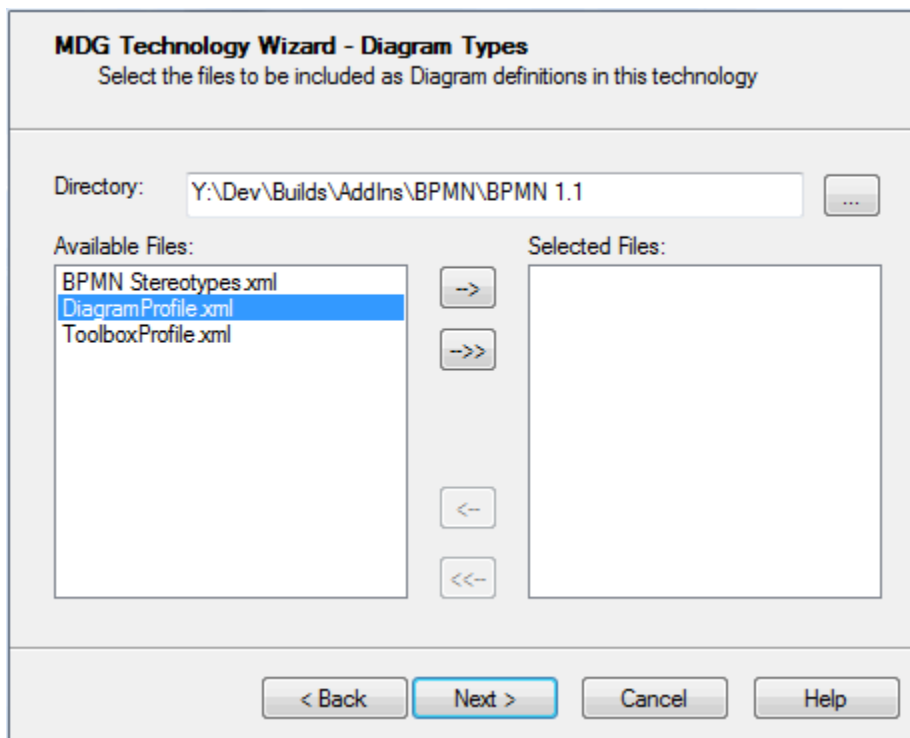

2. In the **Directory** field, navigate to the directory containing the required diagram profiles. The profiles in the directory are automatically listed in the **Available Files** panel.
3. To select each required diagram profile individually, highlight the file name in the **Available Files** list and click on the --> button. The file name displays in the **Selected Files** list. Alternatively, to select all available profiles (assuming they are all diagram profiles), click on the -->> button.
4. Click on the **Next** button to proceed.

#### 5.3.1.2.1.4 Add a Toolbox Profile

When creating an MDG Technology file, you can include Enterprise Architect **Toolbox** page definitions [that you have created](#)<sup>[134]</sup>. To use the Toolboxes section of the MDG Technology Wizard, follow the steps below:

1. Follow the steps in the *Create MDG Technologies* topic up to and including [Step 6](#)<sup>[112]</sup>, where you select the **Toolboxes** checkbox. The **MDG Technology Wizard - Toolboxes** dialog displays.

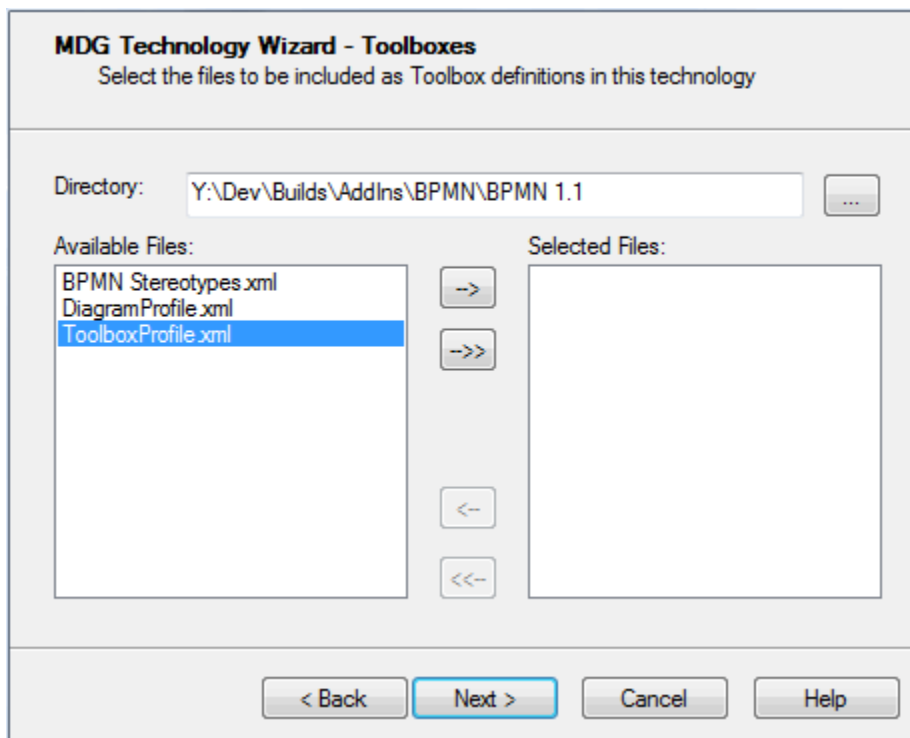

2. In the **Directory** field, navigate to the directory containing the required toolbox profiles. The profile files are automatically listed in the **Available Files** panel.
3. To select each required toolbox profile individually, highlight the file name in the **Available Files** list and click on the --> button. The file name displays in the **Selected Files** list. Alternatively, to select all available profiles (assuming they are all toolbox profiles), click on the -->> button.
4. Click on the **Next** button to proceed.

#### 5.3.1.2.1.5 Add Task Panel Pages

When creating an MDG Technology file, you can include Enterprise Architect **Task Panel** profiles [that you have created](#). To use the Taskpages section of the MDG Technology Wizard, follow the steps below:

1. Follow the steps in the *Create MDG Technologies* topic up to and including [Step 6](#), where you select the **Taskpages** checkbox. The **MDG Technology Wizard - Taskpages** dialog displays.

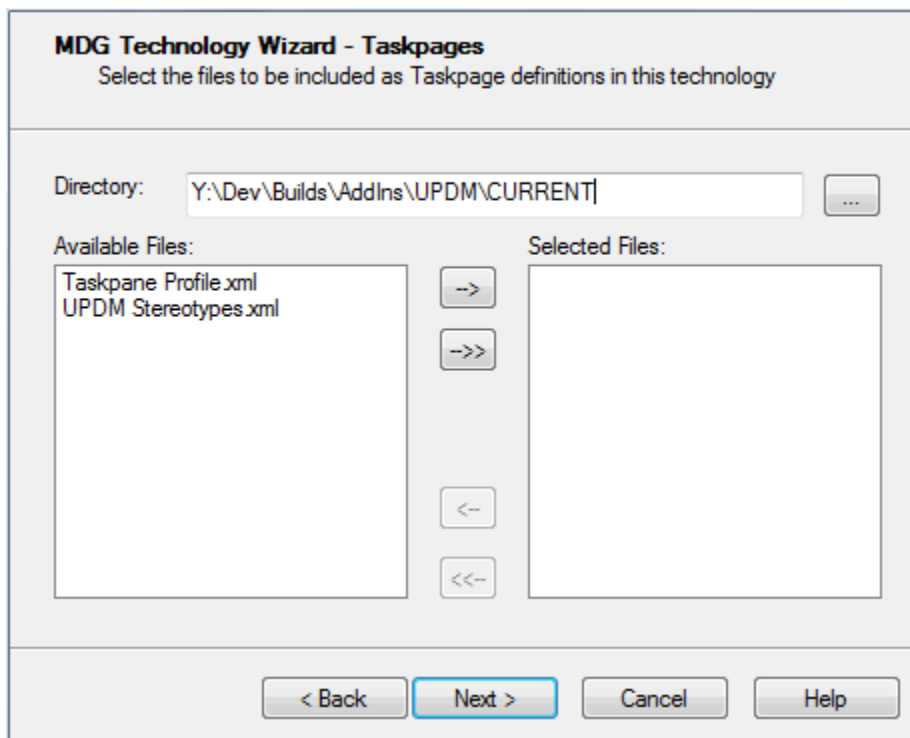

2. In the **Directory** field, navigate to the directory containing the required taskpage profiles. The profile files are automatically listed in the **Available Files** panel.
3. To select each required taskpage profile individually, highlight the file name in the **Available Files** list and click on the --> button. The file name displays in the **Selected Files** list. Alternatively, to select all available profiles (assuming they are all taskpage profiles), click on the -->> button.
4. Click on the **Next** button to proceed.

#### 5.3.1.2.1.6 Add Tagged Value Types

When creating an MDG Technology file, you can include [Tagged Value Types](#)<sup>[1166]</sup>. To use the Tagged Value Types section of the MDG Technology Types Wizard, follow the steps below:

1. Follow the steps in the *Create MDG Technologies* topic up to and including [Step 6](#)<sup>[1121]</sup>, where you select the **Tagged Value Types** checkbox. The **MDG Technology Wizard - Tagged Value Types** dialog displays.

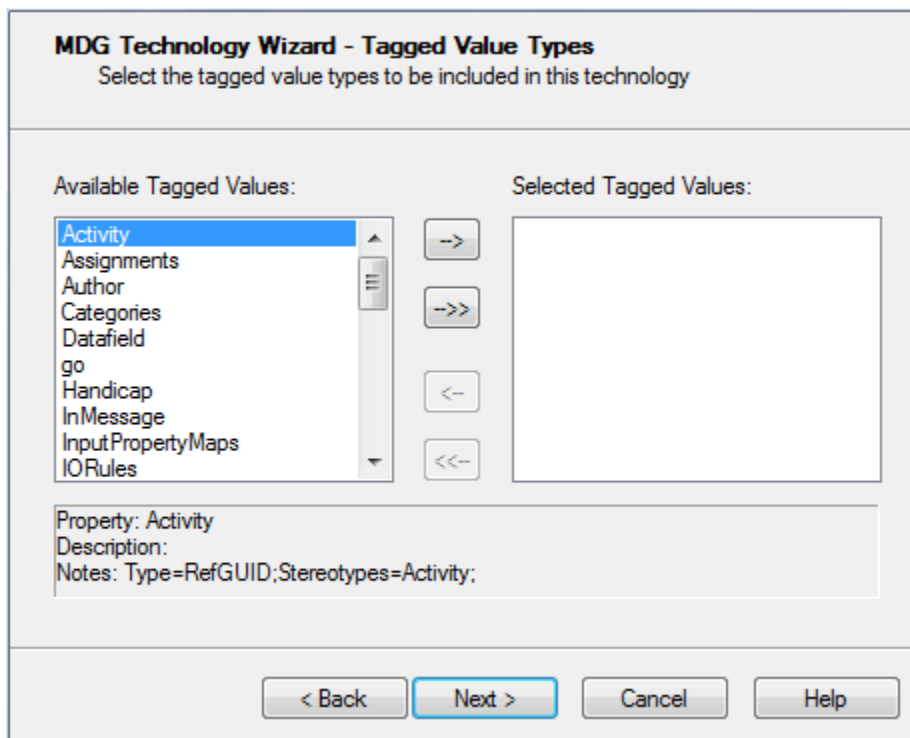

2. To select each required Tagged Value Type individually, highlight the file name in the **Available Files** list and click on the --> button. The file name displays in the **Selected Files** list. Alternatively, to select all available Tagged Value Types, click on the -->> button.
3. Click on the **Next** button to proceed.

#### 5.3.1.2.1.7 Add Code Modules

When creating an MDG Technology file, you can include code modules. To use the code modules section of the MDG Technology Types Wizard, follow the steps below:

1. Follow the steps in the *Create MDG Technologies* topic up to and including [Step 6](#)<sup>1128</sup>, where you select the **Code Modules** checkbox. The **MDG Technology Wizard - Code Modules** dialog displays.

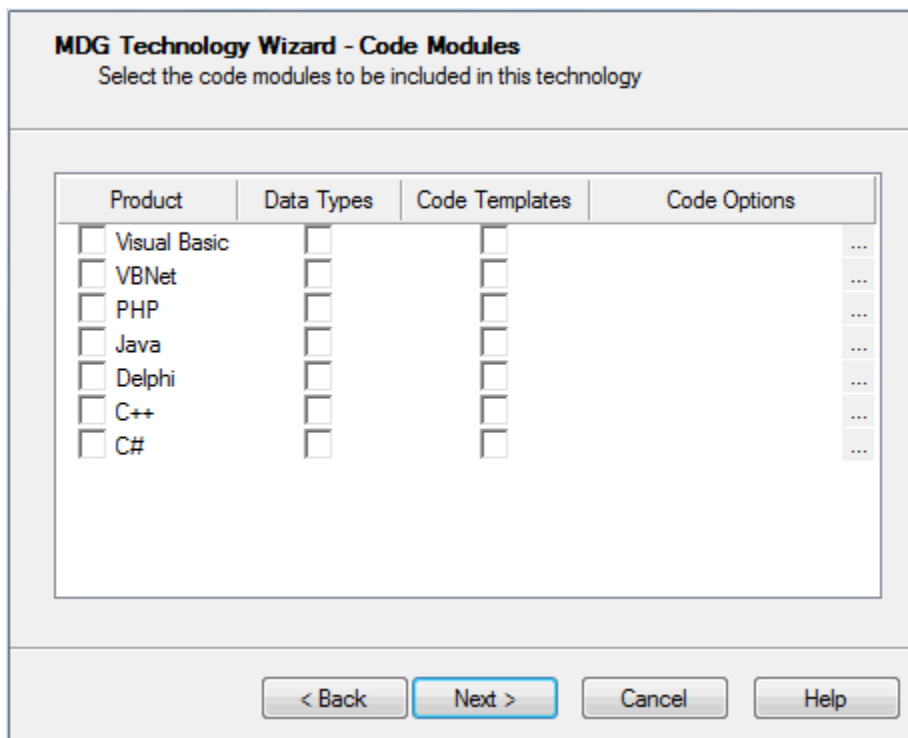

- Click on the checkboxes (**Product**, **Data Types**, and **Code Templates**) for each of the required Code Modules.

**Note:**

The code modules listed are those defined in your current project. These could be the Enterprise Architect default languages, or those you have defined yourself using [code templates](#) <sup>[1302]</sup> and the [Code Template Editor](#) <sup>[1305]</sup>. Before you can set up a code template for the new language in the editor, you must define at least one [data type](#) <sup>[666]</sup> for the language. Once the MDG Technology file is created it can be loaded into your current model and into other models.

- To select any code options for a module, click on the [ ... ] button in the **Code Options** column for that module. This enables you to select an XML document that provides additional settings for the language that are not covered by the data types or code templates.

The root node of the XML document should be CodeOptions. The child nodes should be called CodeOption and should contain a *name* attribute. The supported code options are as follows:

Code Option	Description
ConstructorName	The name of a function used as a constructor. Used by the <a href="#">classHasConstructor</a> <sup>[1174]</sup> code template macro.
CopyConstructorName	The name of a function used as a copy constructor. Used by the <a href="#">classHasCopyConstructor</a> <sup>[1174]</sup> code template macro.
DefaultExtension	The default extension when generating code.
DefaultSourceDirectory	The default path to which Enterprise Architect generates new files.
DestructorName	The name of a function used as a destructor. Used by the <a href="#">classHasDestructor</a> <sup>[1174]</sup> code template macro.
Editor	The external editor used for editing source of this language.
ImplementationExtension	The extension used by Enterprise Architect to generate an implementation file.

Code Option	Description
ImplementationPath	The relative path from the source file to generate the implementation file.
PackagePathSeparator	The delimiter used to separate package names when using the <i>packagePath</i> macro from the code templates.

An example of a valid code options file is shown below.

```
<CodeOptions>
<CodeOption name="DefaultExtension">.ext</CodeOption>
<CodeOption name="Editor">C:\Windows\notepad.exe</CodeOption>
</CodeOptions>
```

4. Click on the **Next** button to proceed.

You can edit the code option values for [source code engineering](#) and for each required language using the [appropriate Language Options](#) page of the **Options** dialog.

#### 5.3.1.2.1.8 Add MDA Transforms

When creating an MDG Technology file, you can include the MDA Transformations that have been modified in the model. To use the Transform Modules section of the MDG Technology Wizard, follow the steps below:

1. Follow the steps in the *Create MDG Technologies* topic up to and including [Step 6](#), where you select the **MDA Transforms** checkbox. The **MDG Technology Wizard - Transform Modules** dialog displays.

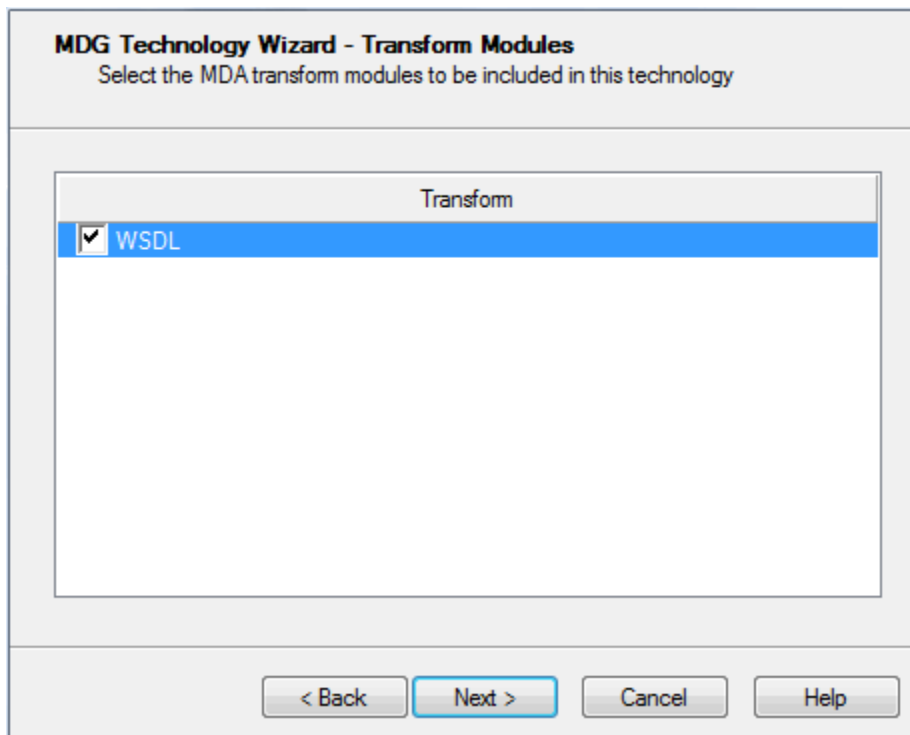

2. Click the checkbox against the template name of each required template that is present in the current model.
3. Click on the **Next** button to proceed.

#### 5.3.1.2.1.9 Add Images

When creating an MDG Technology file, you can include the images that have been imported into the model. To use the Image Selection section of the MDG Technology Wizard, follow the steps below:

1. Follow the steps in the *Create MDG Technologies* topic up to and including [Step 6](#), where you select the **Images** checkbox. The **MDG Technology Wizard - Image Selection** dialog displays.

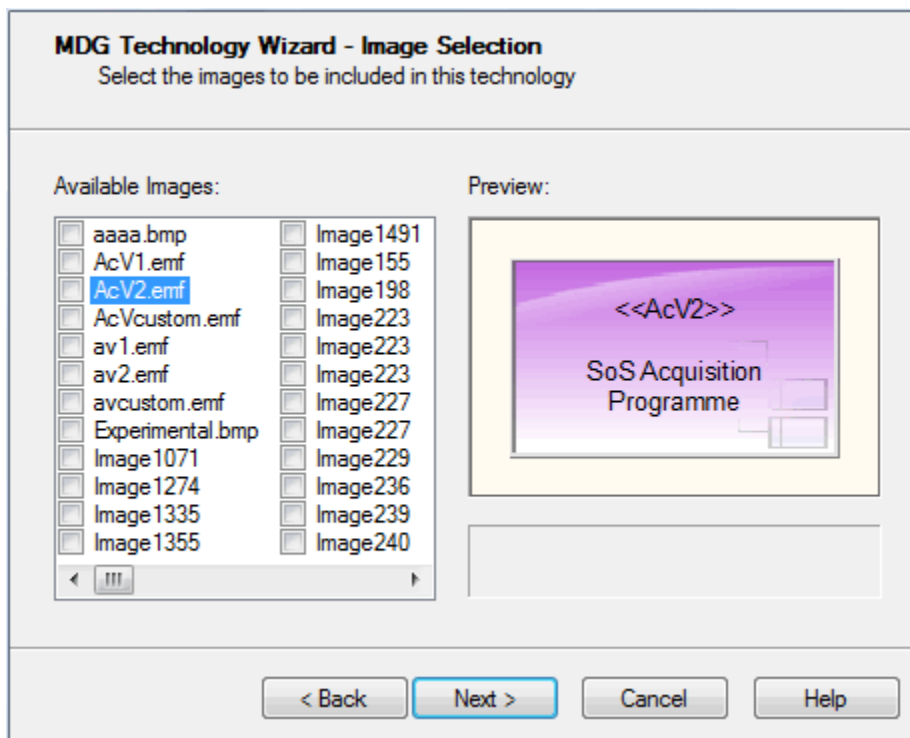

2. For each required model image available in the current model, select the checkbox next to the image name. A preview of each image displays on the right of the dialog as you select the checkbox.
3. Click on the **Next** button to proceed.

#### 5.3.1.2.1.10 Add Scripts

When creating an MDG Technology file, you can include [scripts](#) <sup>[1660]</sup> that you have created in the model.

##### Note:

This facility is available in the Corporate, Business and Software Engineering, Systems Engineering and Ultimate editions of Enterprise Architect.

To use the Script Selection section of the MDG Technology Wizard, follow the steps below:

1. Follow the steps in the *Create MDG Technologies* topic up to and including [Step 6](#) <sup>[1121]</sup>, where you select the **Scripts** checkbox. The **MDG Technology Wizard - Scripts** dialog displays.

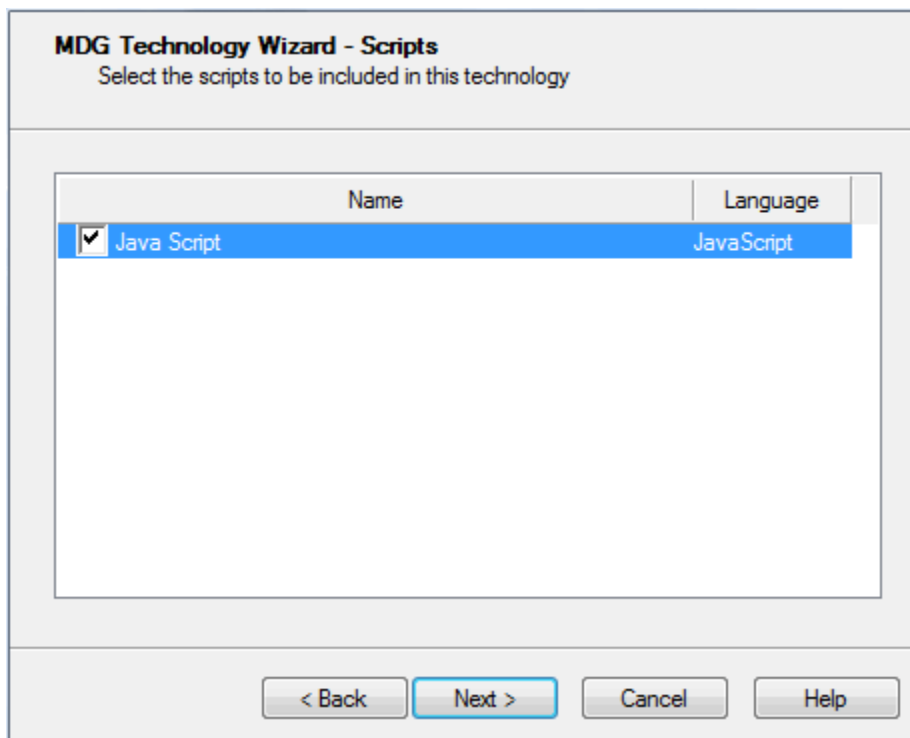

2. For each required script available in the current model, select the checkbox next to the script name.
3. Click on the **Next** button to proceed.

#### 5.3.1.2.1.11 Add RTF Report Templates

When creating an MDG Technology file, you can include user-defined RTF Report templates. To use the report templates section of the MDG Technology Wizard, follow the steps below:

1. Follow the steps in the *Create MDG Technologies* topic up to and including [Step 6](#)<sup>1127</sup>, where you select the **RTF Templates** checkbox. The *MDG Technology Wizard - RTF Report Templates* dialog displays.

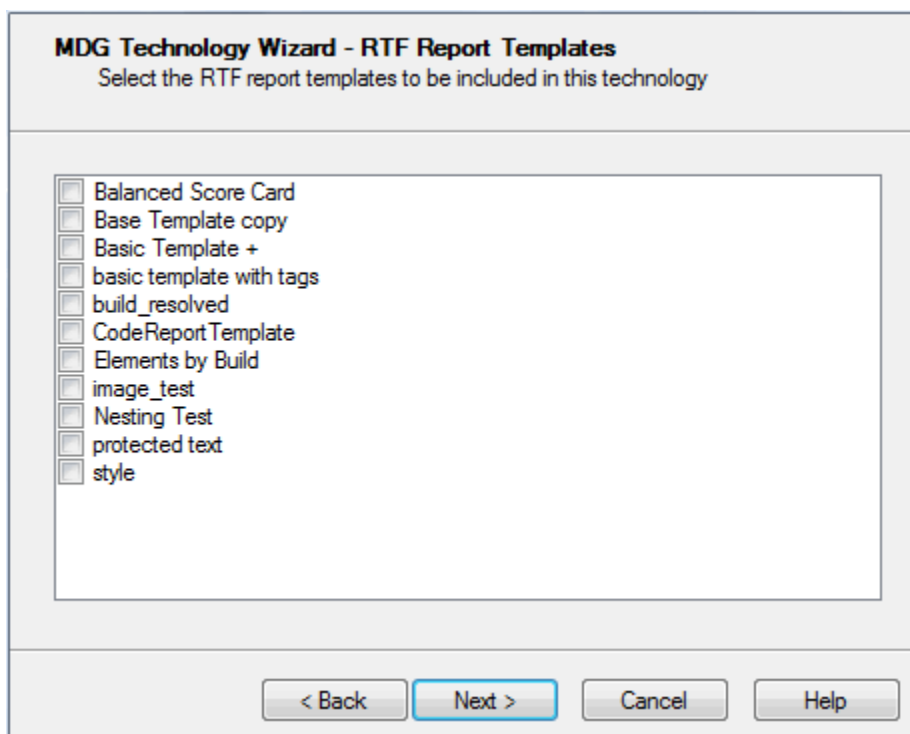



2. For each required user-defined report template available in the current model, select the checkbox next to the template name.
3. Click on the **Next** button to proceed.

#### 5.3.1.2.1.12 Add Linked Document Templates

When creating an MDG Technology file, you can include Linked Document templates. To use the Linked Document templates section of the MDG Technology Wizard, follow the steps below:

1. Follow the steps in the *Create MDG Technologies* topic up to and including [Step 6](#)<sup>[112]</sup>, where you select the **Linked Document Templates** checkbox. The **MDG Technology Wizard - Linked Document Templates** dialog displays.

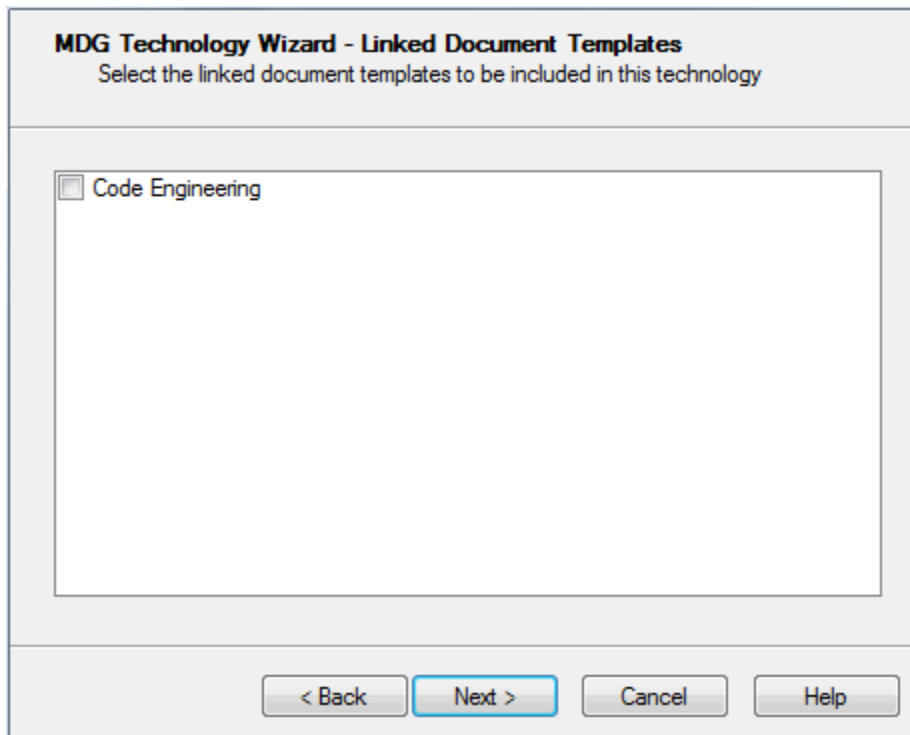

2. For each required document template available in the current model, select the checkbox next to the template name.
3. Click on the **Next** button to proceed.

#### 5.3.1.2.2 Working with MTS Files

An MDG Technology Selection (.MTS) file stores the selected options that you define when creating an MDG Technology File using the MDG Technology Wizard. If you use a .MTS file, you can edit it to change the features selected when you generated the file, and to add or remove the advanced features described in this topic.

#### Create a .MTS File

To create a .MTS file, select the **Tools | Generate MDG Technology File** menu option to launch the MDG Technology Wizard, and work through the screens as described in [Create MDG Technologies](#)<sup>[118]</sup>. On the second page, select the **Create a new MTS file** option.

#### Advanced Options For Your .MTS File

Once you have created the .MTS file, you can add:

- [Model Search definitions](#)<sup>[123]</sup>

#### Note:

If you use a custom SQL search, the SQL must include `ea_guid AS CLASSGUID` and the *object type*.

- [Model Views](#) <sup>[1227]</sup>

#### Notes:

- Technology views do not store Favorite packages, only Views.
- If your exported views run searches that you have defined you must also include those searches in your MDG Technology.

- [Model Validation configurations](#) <sup>[1145]</sup>

- [Model Templates](#) <sup>[1146]</sup>

Open the .MTS file in a text editor. To make it easier for you, you can copy the following lines and paste them into the file before the last line of the file (that is, just before the </MDG.Selections> lines:

```
<ModelSearches file=""/>
<ModelViews file=""/>
```

(The code for the model validation configurations and model templates is provided in the corresponding sections, accessed via the links in the list above.)

You can, if necessary, have more than one line for each inclusion; for example, more than one *ModelSearch*. For each inserted line:

- In the file attribute, enter the filename of the Model Search XML file or Model View XML file.

Save the .MTS file.

## Update the MDG Technology

Again select the **Tools | Generate MDG Technology File** menu option, but this time on the second page select **Open an Existing MTS file** and specify the file path of the .MTS file you have updated. Click on **<Next>** until the wizard is finished. Your MDG Technology file is updated.

### 5.3.1.2.3 Customize Toolbox Profiles

The following is a road map of how to create a set of custom toolboxes for Enterprise Architect.

1. Create a set of [Toolbox Profiles](#) <sup>[1134]</sup> that contain the definitions that Enterprise Architect requires to create the toolboxes.
2. [Create a .MTS file](#) <sup>[1118]</sup> containing instructions on how to build your MDG Technology. Use this .MTS file to build your MDG Technology.
3. Add some finishing touches:
  - Create [hidden sub-menus](#) <sup>[1135]</sup>
  - [Override Enterprise Architect's default toolboxes](#) <sup>[1136]</sup>
  - Change the default [icons for toolbox items](#) <sup>[1136]</sup>.

#### 5.3.1.2.3.1 Create Toolbox Profiles

You can create multiple toolbox profiles within an MDG Technology. Each toolbox profile contains definitions that determine what appears in the **Toolbox** when a specific **Toolbox** page is open, either by selecting from the **More tools...** option in the **Toolbox** window, or by opening or creating a diagram of the type that is linked to the toolbox profile.

To create a toolbox profile, follow the steps below:

1. Create a diagram in a profile package. Give it a name by which you can refer to it later, such as *MyClassDiagram*. In the **Notes** field for the diagram give it an alias and a description in the following format:  
Alias=MyClass;Notes=Structural elements for class diagrams;
2. On the diagram, create a Class, name it *ToolboxPage* and give it the «*metaclass*» stereotype.
3. Create a «*stereotype*» element for each of the toolbox pages to create within your toolbox, such as *MyClassElements* and *MyClassRelationships*. Set their Alias to the text to display in the title bar of each toolbox page, such as *My Class Elements* and *My Class Relationships* respectively. Use the **Notes** field to define the tool-tip for each toolbox page; that is, **Elements for Class Diagrams** and **Relationships for Class Diagrams**. Use the «*extends*» connector to set the stereotype elements to extend *ToolboxPage*. See also: [Toolbox Page Attributes](#) <sup>[1135]</sup>.
4. In the «*stereotype*» elements, create an attribute for each toolbox item. The name of the attribute should be the name of the element or connector to be dropped, including namespace, for example, *UML::Package*, *UML::Class* and *UML::Interface*. The toolbox items display in the same order as the

attributes in the Class, so make use of the attribute ordering buttons to define the order of your toolbox.

**Note:**

To name an attribute for an item from your own technology, precede it with your profile name as the namespace, and then follow it in brackets with the element or connector type that you are extending (so that Enterprise Architect knows what object to create). For example, a SysML block element would appear as *SysML::Block(UML::Class)*. Click on the following links for a complete list of [elements](#)<sup>[1137]</sup> and [connectors](#)<sup>[1138]</sup> that can be extended.

To define a toolbox item that allows a pattern to be dropped onto a diagram, name the attribute *My Technology::MyPattern(UMLPattern)* where *MyTechnology* is the ID of the technology and *MyPattern* is the name of the pattern to drop. For example, *BusFramework::Builder(UMLPattern)*.

To define a model-based pattern in a custom toolbox (such as the [GoF patterns](#)<sup>[90†]</sup>) create an attribute with a name of the format *PatternCategory::PatternName(UML Pattern)*. For example: *GoF Behavioral Patterns:: Mediator(UML Pattern)*.

You might not want to use names such as *UML::Package* or *UML::Class* in your toolbox, so give the attributes an **Initial Value** of, for example, *Package* or *Class*.

5. To save the toolbox profile, right-click on the diagram and select the **Save as Profile** context menu option.

**Note:**

Each profile element incorporated into an MDG **Toolbox** page enables [synchronization](#)<sup>[91†]</sup> of the Tagged Values and Constraints of all elements created from them.

The following attributes can be added to a stereotype Class that extends the *ToolboxPage* metaclass:

- **ImagesOnly**: if you give a toolbox page an attribute named *imagesOnly* with **Initial Value** set to **true**, the toolbox page displays without the text labels next to the icons
- **isCommon**: if you give a toolbox page an attribute named *IsCommon* with **Initial Value** set to **true**, the toolbox page is common to all defined toolboxes while your technology is active; the page is initially displayed as collapsed
- **isCollapsed**: if you give a toolbox page an attribute named *IsCollapsed* with **Initial Value** set to **true**, the toolbox page is initially minimized.
- **Icon**: see [Assign Icons for Toolbox Items](#)<sup>[1136]</sup>
- **isHidden**: see [Create Hidden Sub-Menus](#)<sup>[1135]</sup>.

### 5.3.1.2.3.2 Create Hidden Sub-Menus

To create a sub-menu, create an additional «*stereotype*» element in the same toolbox profile and give it an attribute named *isHidden* with **Initial Value** of **true**. Define the toolbox item attributes as before. In the parent «*stereotype*» element, create an attribute with the identical name to the sub-menu element. The sub-menu element can have an alias.

This technique is very useful for 'disambiguating' stereotypes that can be applied to multiple metaclasses. In the example below, the «*MyStereo*» stereotype can be applied to either a Class or an Interface. On dragging and dropping one from the toolbox, a hidden menu displays giving the choice of Class or Interface, then the appropriate element is dropped:

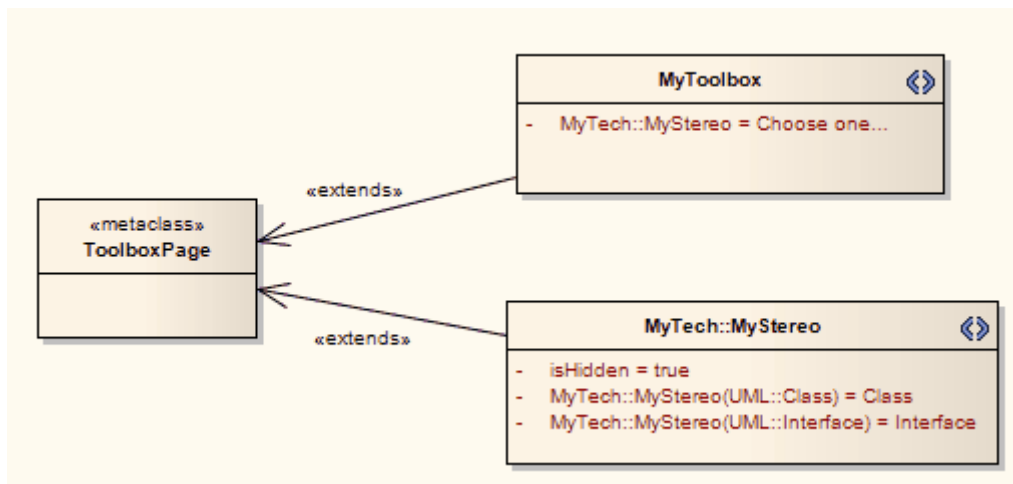

### 5.3.1.2.3.3 Override Default Toolboxes

Enterprise Architect has many default Toolbox Profiles, one for each of its inbuilt diagram types. These define the Toolbox pages that are displayed, by default, every time a diagram of a specific type is opened or brought into view.

To replace one of Enterprise Architect's default toolboxes with one of your own (for example, if you have your own version of the `UML::Class` toolbox that you want to be opened every time a Class diagram is opened - as long as your technology is active) then include a *RedefinedToolbox* clause in the **Notes** field for the diagram properties of your Toolbox Profile diagram. For example, the profile diagram's **Notes** field could resemble the following:

```
RedefinedToolbox=UML::Class;Alias=Class;Notes=Structural elements for Class diagrams;
```

This states that the toolbox defined by this profile replaces the Enterprise Architect toolbox `UML::Class` as the default toolbox for all UML Class diagrams. For a list of inbuilt toolboxes, see the [List of Enterprise Architect Toolboxes](#) <sup>[1137]</sup> topic.

### 5.3.1.2.3.4 Assign Icons To Toolbox Items

To assign an icon to a toolbox item, create a new `«stereotype»` element in the same toolbox profile as the toolbox item. Have the stereotype element extend a `«metaclass»` element named `ToolboxItemImage`. The `«stereotype»` element must have the same name as the attribute that it is assigning an image to (for example, `MyTech::MyStereo(UML::Class)` in the diagram below) and must have an attribute named `Icon` with **Initial Value** set to the full path and file name of the image to be used. The image must be a 16x16 .BMP file.



### 5.3.1.2.3.5 List of Enterprise Architect Toolboxes

The following is a list of the **Toolbox** pages that can be overridden:

- UML::Activity
- UML::Class
- UML::Communication
- UML::Component
- UML::Composite
- UML::Deployment
- UML::Interaction
- UML::Metamodel
- UML::Object
- UML::Profile
- UML::State
- UML::Timing
- UML::UseCase
- Extended::Analysis
- Extended::Custom
- Extended::DataModeling
- Extended::Maintenance
- Extended::Requirements
- Extended::UserInterface
- Extended::WSDL
- Extended::XMLSchema

### 5.3.1.2.3.6 Elements Used in Toolboxes

The following elements (all preceded with the namespace **UML::**) can be extended or redefined in Enterprise Architect **Toolbox** pages. The text in red indicates the label name displayed in the default Enterprise Architect **Toolbox** pages, where this differs in any way from the **UML::** statement text.

When these profile elements are incorporated into an MDG **Toolbox** page, they enable [synchronization](#)<sup>[910]</sup> of the Tagged Values and Constraints of all elements created from them.

You can also extend [connectors](#)<sup>[1138]</sup>.

- Action
- Activity
- ActivityFinal (**Final**)
- ActivityInitial (**Initial**)
- ActivityParameter
- ActivityPartition (**Partition**)
- ActivityRegion (**Region**)
- Actor
- Artifact
- AssociationElement (**Association**)
- Boundary (for Use Cases)
- CentralBufferNode (**Central Buffer Node**)
- Change
- Choice
- Class
- Collaboration
- CollaborationOccurrence
- InteractionState (**State/Continuation**)
- Interface
- Issue
- Junction
- Lifeline
- MergeNode (**Merge**)
- MessageEndPoint (**Endpoint** or **Message Endpoint**)
- MessageLabel (**Message Label**)
- Metaclass
- Node
- Object
- ObjectBoundary (**Boundary**)
- ObjectControl (**Control**)
- ObjectEntity (**Entity**)
- Package
- PackagingComponent
- Part

- Comment (**Note**)
- Component
- Constraint
- Datastore
- Decision
- DeploymentSpecification (**Deployment Specification**)
- Device
- DiagramLegend (**Diagram Legend**)
- DiagramNotes (**Diagram Notes**)
- DocumentArtifact (**Document Artifact** or **Document**)
- Entity (**Information**)
- EntityObject (**Entity**)
- EntryState (**Entry**)
- Enumeration
- ExceptionHandler (**Exception**)
- ExecutionEnvironment (**Execution Environment**)
- ExitState (**Exit**)
- Feature
- FinalState (**Final**)
- FlowFinalNode (**Flow Final**)
- ForkJoinH (**Fork/Join** - Horizontal)
- ForkJoinV (**Fork/Join** - Vertical)
- Gate (**Diagram Gate**)
- GUIElement (**UI Control**)
- HistoryState (**History**)
- Hyperlink
- InformationItem (**Information Item**)
- InitialState (**Initial**)
- InteractionFragment (**Fragment**)
- Port
- Primitive
- Process
- Profile
- ProvidedInterface (**Expose Interface**)
- ReceiveEvent (**Receive**)
- Requirement
- RobustBoundary (**Boundary**)
- RobustControl (**Control**)
- RobustEntity (**Entity**)
- Screen
- SendEvent (**Send**)
- SequenceBoundary (**Boundary**)
- SequenceControl (**Control**)
- SequenceEntity (**Entity**)
- Signal
- State
- StateMachine (**State Machine**)
- StateTimeLine (**State Lifeline**)
- Stereotype
- StructuredActivity (**Structured Activity**)
- SynchState (**Synch**)
- Table
- Terminate
- TestCase (**Test Case**)
- Text
- UseCase (**Use Case**)
- UMLBoundary (**Boundary**)
- ValueTimeLine (**Value Lifeline**)

### 5.3.1.2.3.7 Connectors Used In Toolboxes

The following connectors (all preceded with the namespace **UML::**) can be extended or redefined in Enterprise Architect toolboxes. The text in red indicates the label name displayed in the default Enterprise Architect **Toolbox** pages, where this differs in any way from the **UML::** statement text.

You can also extend [elements](#) <sup>[1137]</sup>.

- Aggregation (**Aggregate**)
- Assembly
- Association (**Associate**)
- AssociationClass (**Association Class**)
- CallFromRecursion (**Call**)
- NoteLink (**Note Link**)
- ObjectFlow (**Object Flow**)
- Occurrence
- PackageImport (**Package Import**)
- PackageMerge (**Package Merge**)

- CommunicationPath (**Communication Path**)
- Composition (**Compose**)
- Connector
- ControlFlow (**Control Flow**)
- Delegate
- Dependency
- Deployment
- Extension
- Generalization (**Generalize** or **Inheritance**)
- InformationFlow (**Information Flow**)
- InterruptFlow (**Interrupt Flow**)
- Invokes
- Manifest
- Message
- Nesting
- Precedes
- ProfileApplication (**Application**)
- Realization (**Realize** or **Implements**)
- Recursion
- Redefinition
- Representation
- Represents
- RoleBinding (**Role Binding**)
- SelfMessage (**Self-Message**)
- TagValAssociation (**Tagged Value**)
- TraceLink (**Trace**)
- Transition
- UCExtend (**Extend**)
- UCInclude (**Include**)
- UseCaseLink (**Use**)

#### 5.3.1.2.4 Create Diagram Profiles

### Custom Diagram Types

You can create extended diagram types in Enterprise Architect and include them in MDG Technologies. To do this, perform the following steps.

1. Create a profile with the same name as the MDG Technology in which it is to be included; for example, *SysML*.
2. Create a «stereotype» Class element that is named as the custom diagram, for example, *BlockDefinition*.
3. Create a Class element and name it as one of the [Built-In Diagram Types](#)<sup>[1146]</sup> prefixed with *Diagram\_*, for example *Diagram\_Logical* for Class diagrams or *Diagram\_Use Case* for Use Case diagrams.
4. Give the *Diagram\_x* Class the «metaclass» stereotype and draw an «extends» connector from the stereotype to the metaclass.
5. In the **Notes** field, give the stereotype Class a brief description of what the diagram is used for. This description displays in the bottom right-hand corner of the **New Diagram** dialog.
6. Give the *Diagram\_x* Class the following attributes as required:
  - *alias*: *string = Type* (where *Type* appears before the word 'Diagram' on the diagram title bar)
  - *diagramID*: *string = abc* (where *abc* is the diagram type that appears in the [diagram frame](#)<sup>[766]</sup> label)
  - *toolbox*: *string = ToolboxName* (where *ToolboxName* is the name of the toolbox profile for the toolbox that opens automatically each time a diagram is opened)
  - *frameString*: *string = FrameFormatString* (where *FrameFormatString* is a string containing substitution macros for defining the frame title, with or without additional delimiters such as [ ]; m across that can be used are:
    - #DGMSTEREO#
    - #DGMID#
    - #DGMTYPE#
    - #DGMALIAS#
    - #DGMOWNERNAME#
    - #DGMOWNERNAMEFULL#
    - #DGMNAME#
    - #DGMNAMEFULL#
  - *swimlanes*: *string = Lanes=2;Orientation=Horizontal;Lane1=Title1;Lane2=Title2*; (where *Lanes* can be any value, but the number of *Lane<n>* values must equal the value of *Lanes*; *Orientation* can be omitted, in which case the swimlanes default to vertical)

- *styleex*: *string* = one or more of a range of values; see [Attribute Values - stylex & pdata](#)<sup>[1140]</sup>
  - *pdata*: *string* = one or more of a range of values; see [Attribute Values - stylex & pdata](#)<sup>[1140]</sup>.
- The following example shows the DFD diagram profile which defines a DFD diagram as an extension of the Enterprise Architect Analysis diagram.

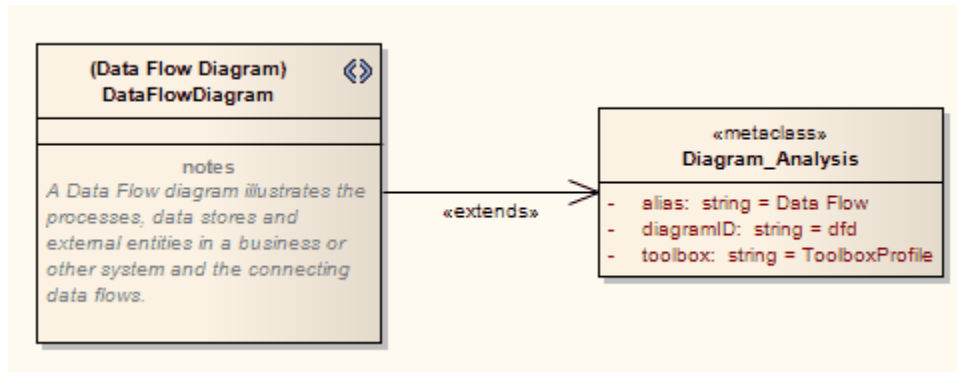

7. Save the diagram as a profile in the usual manner.
8. [Add the diagram profile to the](#)<sup>[1124]</sup>.MTS file used in the MDG Technology.

#### 5.3.1.2.4.1 Built-In Diagram Types

The following is a full list of built-in diagram types provided by Enterprise Architect.

- Activity
- Analysis
- Collaboration
- Component
- CompositeStructure
- Custom
- Deployment
- InteractionOverview
- Logical
- Object
- Package
- Sequence
- Statechart
- Timing
- Use Case

Note the use of *Logical* for Class diagrams and also notice the space in the middle of *Use Case*. These names are used in [Defining Child Diagram Types](#)<sup>[1111]</sup>, or prefixed by *Diagram\_* in creating [Diagram Profiles](#)<sup>[1139]</sup>.

#### 5.3.1.2.4.2 Attribute Values - stylex & pdata

When creating a diagram profile, you can use the *pdata* and *stylex* attributes to define a range of characteristics of the diagrams created with the profile. If the attribute is defining several characteristics at once, put the values in a single string separated by semicolons. For example:

*styleEx*: *string* = *HideQuals=0;AdvanceElementProps=1;ShowNotes=1;*

**styleex**: *string* =

- *TConnectorNotation=Option*; (where *Option* is one of **UML 2.1**, **IDEF1X**, or **Information Engineering**)
- *ShowAsList=1*; (to make the diagram open directly into the [Element List](#)<sup>[1258]</sup>)
- *AdvanceElementProps=1*; (to show the element property string)
- *ShowTests=1*; (to show the element Testing compartment)
- *ShowMaint=1*; (to show the element Maintenance compartment)
- *ShowNotes=1*; (to show the element Notes compartment)



- *HideQuals=0*; (to show qualifiers and visibility indicators)
- *AdvancedFeatureProps=1*; (to show the feature property string)
- *ShowOpRetType=1*; (to show the operation return type)
- *SuppressBrackets=1*; (to suppress brackets on operations without parameters)
- *AttPkg=1*; (to show package visible class members)
- *VisibleAttributeDetail=1*; (to show attribute details on the diagram)
- *TExplicitNavigability=1*; (to show non-navigable connector ends)
- *AdvancedConnectorProps=1*; (to show connector property strings)
- *SuppConnectorLabels=1*; (to suppress all connector labels).

**pdata: string =**

- *UseAlias=1*; (to use the aliases or elements in the diagram, if available)
- *HideParents=0*; (to show additional parents of elements in the diagram)
- *HideEStereo=0*; (to show element stereotypes in the diagram)
- *ShowSN=1*; (to show sequence notes)
- *ShowIcons=1*; (to use stereotype icons)
- *HideAtts=0*; (to show the element Attributes compartment)
- *HideOps=0*; (to show the element Operations compartment)
- *ShowTags=1*; (to show the element Tagged values compartment)
- *ShowReqs=1*; (to show the element Requirements compartment)
- *ShowCons=1*; (to show the element Constraints compartment)
- *HideStereo=0*; (to show attribute and operation stereotypes)
- *HideProps=0*; (to show property methods)
- *OpParams=3*; (to show operation parameters)
- *HideRel=0*; (to show relationships)
- *SuppCN=0*; (to show collaboration numbers).

### 5.3.1.2.5 Create Tasks Pane Profiles

Defining **Tasks Pane** profiles is a four-part process:

1. [Define Toolboxes](#)<sup>[1141]</sup>. Create any number of stereotype elements that each define a **Tasks Pane** toolbox page
2. [Define Contexts](#)<sup>[1144]</sup>. Create any number of stereotype elements that each define a named Context. A context might be when a specific diagram type is open, or when a specific element type is selected.
3. [Allocate Contexts](#)<sup>[1144]</sup> to Toolboxes. Define the many-to-many relationships between the **Tasks Pane** toolboxes and the available contexts.
4. [Create the Profile](#)<sup>[1145]</sup> and [incorporate it](#)<sup>[1126]</sup> into your Technology.

#### 5.3.1.2.5.1 Define Tasks Pane Toolboxes

A **Tasks Pane** toolbox is defined by a «*stereotype*» Class that extends a «*metaclass*»`ToolboxPage` element. These elements must be owned by a «*profile*» package. Each «*stereotype*» Class represents the contents of the **Tasks Pane** for a given context, and each attribute of the «*stereotype*» Class defines a command button in the **Tasks Pane**. The following diagram shows an example of a **Tasks Pane** toolbox.

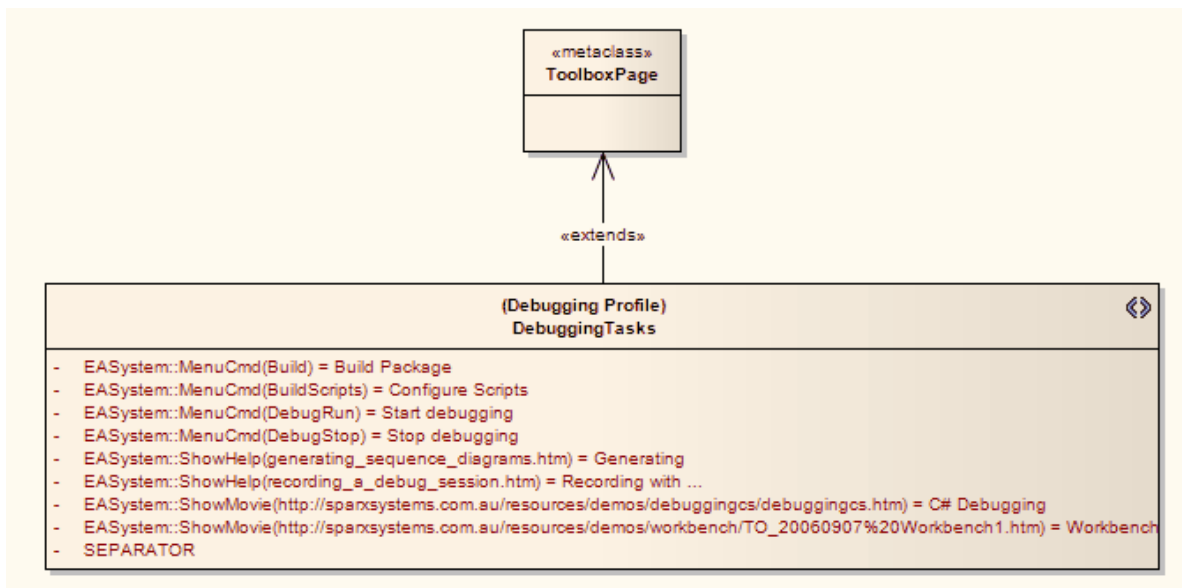

The title bar of the **Tasks Pane** toolbox is defined by the Alias of the «stereotype» Class, in this case *Debugging Profile*. This example uses the following standard attribute types:

- **EASystem::MenuCmd**. These entries name an Enterprise Architect main menu command inside round brackets. See the complete [list of inbuilt commands](#)<sup>[1142]</sup>. Type the text to appear in the **Tasks Pane** into the **Initial Value** field.
- **EASystem::ShowHelp**. These entries name a page from the *Enterprise Architect User Guide* inside round brackets. To find out the names of pages in the *Enterprise Architect User Guide*, right-click on the page and select the **Properties** context menu option. Type the text to appear in the **Tasks Pane** into the **Initial Value** field.
- **EASystem::ShowMovie**. These entries give the URL of a movie inside round brackets. Type the text to appear in the **Tasks Pane** into the **Initial Value** field.
- **SEPARATOR**. This entry indicates that a separator should be placed in the **Tasks Pane** toolbox. If it is necessary to place multiple separators in a single toolbox, note that Enterprise Architect does not allow identically named attributes for a Class: simply change the case of one or more letters to get around the problem.

Other useful attributes include:

- **EASystem::ShowURL**. This entry gives the URL of a web page inside round brackets. Type the text to appear in the **Tasks Pane** into the **Initial Value** field.
- **isCommon**: A boolean attribute with **Initial Value** set to **True**, defines a **Tasks Pane** toolbox as context-free and common, appearing for all contexts
- You can also [run Add-In functions](#)<sup>[1143]</sup> from the **Tasks Pane**.

## Next Step

The next step is to create a set of [Tasks Pane Contexts](#)<sup>[1144]</sup>.

The following Enterprise Architect commands can all be used in user-defined **Tasks Pane** profiles. **Tasks Pane** pages have attributes named in the form *EASystem::MenuCmd(<CommandName>)* where <CommandName> is the name chosen from the following list:

- |                       |                         |   |
|-----------------------|-------------------------|---|
| • AddDiagram          | • ImplementationDetails | • ValidateModel                             |
| • AddElement          | • ImportBinary          | • ViewAuditing                              |
| • AddPackage          | • ImportExportCSV       | • ViewDebug                                 |
| • AutoRecordThread    | • ImportSchema          | • ViewElementList                           |
| • AddModelFromPattern | • ImportSourceDirectory | • ViewForum (for <b>Team Review</b> window) |
| • Build               | • ImportWSDL            | • ViewHierarchy (for <b>Traceability</b> )  |

- BuildScripts
- ConfigureCSV
- ConfigureValidation
- CreateBaseLine
- CreateSequenceDiagram
- DebugPause
- DebugRun
- DebugStop
- Deploy
- DiagramsOnlyReport
- ElementUsage
- ExportXML
- FileNew
- FileOpen
- GenerateDDL
- GenerateWSDL
- GenerateXMLSchema
- ImportXML
- ImportXMLSchema
- Run
- RunHTMLReport
- RunRTFReport
- SetClassifier
- ShowHideExecution
- StartDebugRecording
- StepInto
- StepOut
- StepOver
- StopDebugRecording
- Test
- TestingReport
- ToggleLevelNumbering
- TransformPackage
- TransformSelectedElements
- window)
- ViewMaintenance
- ViewOutput
- ViewProjectManagement
- ViewRelationships
- ViewRelMatrix
- ViewRequirementTypes
- ViewRules
- ViewSearch
- ViewSourceCode
- ViewTaggedValues
- ViewTesting
- ViewTestingDetails
- ViewWebBrowser

To run Add-In functions from the **Tasks Pane**, you create an attribute in the **Tasks Pane «stereotype» Class** with the following format:

```
"Assembly::FunctionName()"
```

where *Assembly* is the name of the Add-In and *FunctionName* is the name of a public function in the Add-In. Give the attribute an initial value of the text that is to appear in the **Tasks Pane**. The function receives two parameters and returns a success status, as in the following VB.Net example:

```
Public Function ShowMyDiagram(ByRef Repository As EA.Repository, ByVal args As Object) As String
    Dim ret As String
    ret = Repository.SQLQuery("select ea_guid from t_diagram where diagram_type='Custom' and StyleEx like
*;MDGDgm=MyDiagrams::MyCustomDiagram;*"")
    If ret Is Nothing Then
        ShowMyDiagram = False
        Exit Function
    End If

    Dim oXML As MSXML2.DOMDocument = New MSXML2.DOMDocument
    oXML.loadXML(ret)

    Dim NodeList As MSXML2.IXMLDOMNodeList = oXML.selectNodes("//ea_guid")
    If NodeList.length = 0 Then
        ShowMyDiagram = False
        Exit Function
    End If

    Dim Node As MSXML2.IXMLDOMNode
    Dim diag As EA.Diagram
    If NodeList.length >= 1 Then
        Node = NodeList.item(0)
        diag = Repository.GetDiagramByGuid(Node.text)
        Repository.OpenDiagram(diag.DiagramID)
        Repository.ShowInProjectView(diag)
    End If

    ShowMyDiagram = True
End Function
```

### 5.3.1.2.5.2 Define Tasks Pane Contexts

#### Named Contexts

To create a context-sensitive set of **Tasks Panes**, you must define a set of named contexts that can be used in the definition. A named context is a *«stereotype»* Class which extends a *«metaclass»* named *ToolboxContext*. These elements must be owned by the same *«profile»* package that owns the [Task Pane toolbox definitions](#) [1144]. The context Class has one of the following attributes:

- contextDiagramType; this should have an **Initial Value** set to a valid diagram type
- contextItemType; this should have an **Initial Value** set to a valid element type
- contextKey.

#### Example Context Profile

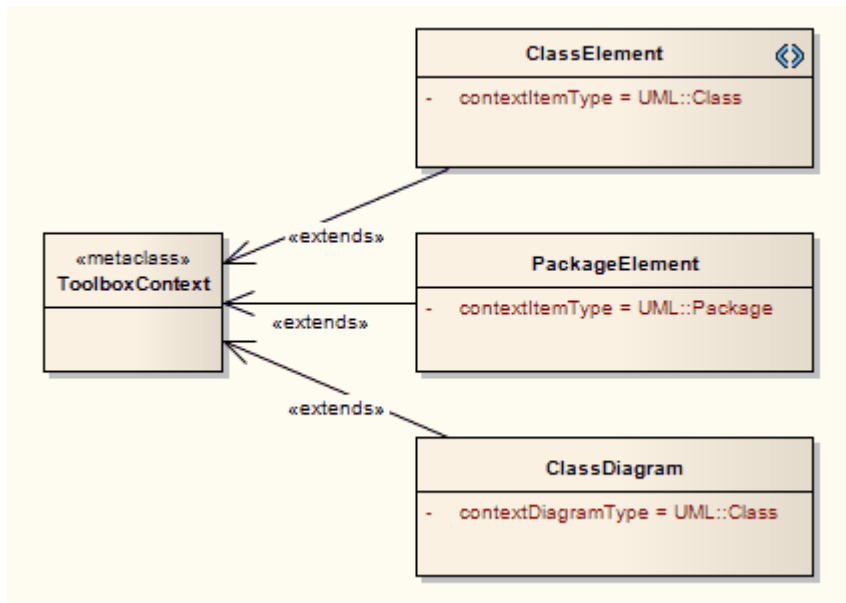

#### Next Step

The next step is to [allocate Tasks Pane contexts to Tasks Pane toolboxes](#) [1144].

### 5.3.1.2.5.3 Allocate Tasks Pane Contexts

Once you have defined your [Tasks Pane toolboxes](#) [1144] and [Tasks Pane contexts](#) [1144], you can allocate your toolboxes to as many contexts as apply, and any number of toolboxes can be allocated to a single context. This is done by creating a *«taggedValue»* connector from the toolbox element to the context element. The Association end at the context end must be named. The following diagram shows how this might appear.

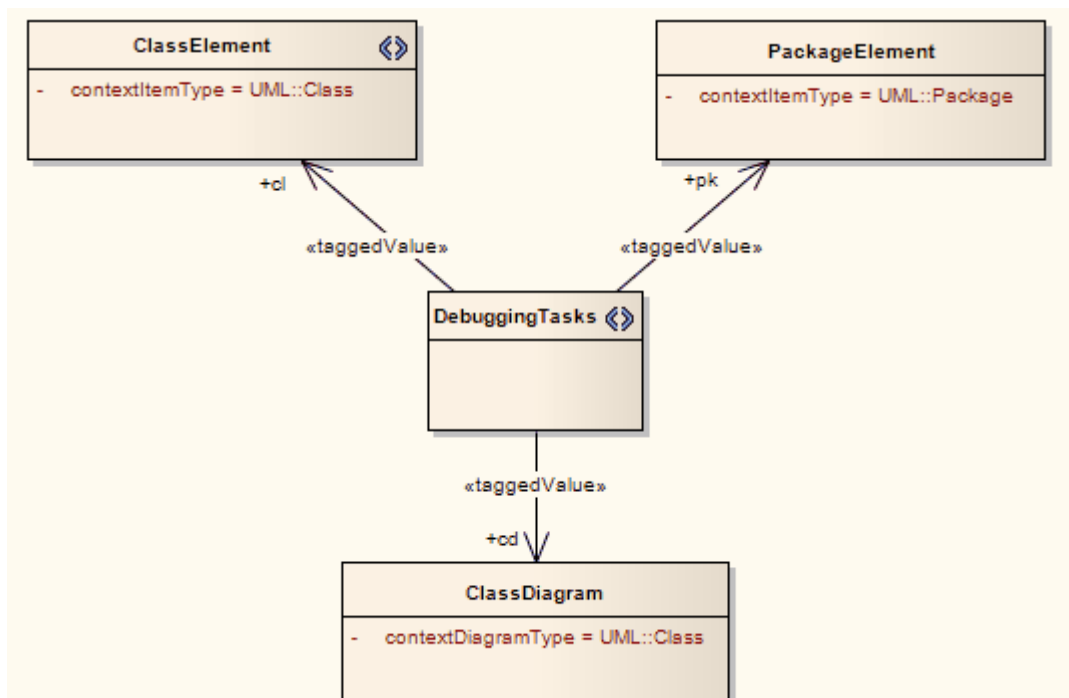

### Next Step

The next step is to [Save your Tasks Pane Profile](#)<sup>[1145]</sup>.

#### 5.3.1.2.5.4 Save a Tasks Pane Profile

The best organization structure for the model in which you are creating your **Tasks Pane** Profile is:

- A single «profile» package
- Three diagrams within the «profile» package named *Toolboxes*, *Contexts* and *Context Allocations*
- Each toolbox page «stereotype» element is owned by the «profile» package and appears on the *Toolboxes* and *Context Allocations* diagrams
- Each context «stereotype» element is owned by the «profile» package and appears on the *Contexts* and *Context Allocations* diagrams
- Each «metaclass» element is owned by the «profile» package and appears on the *Toolboxes* or *Contexts* diagram.

From this structure, creating a **Tasks Pane** Profile is as simple as right-clicking on the «profile» package in the **Project Browser** and selecting the **Save Package as UML Profile** context menu option.

#### 5.3.1.2.6 Define Validation Configuration

The **Model Validation Configuration** dialog can be opened using the **Project | Model Validation | Configure...** menu option. Using this dialog, you can choose which sets of validation rules are and are not executed when a user performs a validation. Rather than perform this configuration manually and potentially have to change the settings every time Enterprise Architect is started and a different technology is set active, you can define the configuration settings within the MTS file.

To specify a set of rules as a white-list (that is, anything added to this list is turned ON), open your MTS file in a text editor and copy and paste the following <ModelValidation> block at the top level inside the <MDG.Selections> block:

```

<ModelValidation>
  <RuleSet name="BPMNRules"/> <!-- ruleset ID defined in the Project.DefineRuleCategory call -->
  <RuleSet name="MVR7F0001"/> <!-- notice you can turn on/off system rules as well! -->
</ModelValidation>
  
```

Ensure that the ruleset IDs do not contain any spaces.

To specify a set of rules as a black-list (that is, anything added to this list is turned OFF), open your MTS file in a text editor and copy and paste the following <ModelValidation> block at the top level inside the <MDG.Selections>

> block:

```
<ModelValidation isBlackList="true">
  <RuleSet name="BPMNRules"/>
  <RuleSet name="MVR7F0001"/>
</ModelValidation>
```

In the examples above, "BPMNRules" is the rule-set ID defined in the Project.DefineRuleCategory call - see [Project Interface](#)<sup>[1753]</sup> for details. "MVR7F0001" is one of Enterprise Architect's built-in rule-sets. These validation options are applied when you activate the appropriate technology. The global (default) technology has all rules turned on.

### 5.3.1.2.7 Incorporate Model Templates

Enterprise Architect has a number of [Model Templates](#)<sup>[373]</sup> that can be added into a model, either on creation of the model, or at any time by right-clicking on a package in the **Project Browser** and selecting the **Add | Add a New Model using Wizard**<sup>[372]</sup>... context menu option. You can create your own templates and include them in your MDG Technology. The first step is to create a template package and save it to the MTS file.

Open your MTS file in a text editor and copy and paste the following <ModelTemplates> block at the top level inside the <MDG.Selections> block:

```
<ModelTemplates>
  <Model name="Template Name"
    description="This is the description."
    location="MyTemplatePackage.xml"
    default="yes"
    icon = "34"
    filter= "Filter Name"/>
</ModelTemplates>
```

You can include as many <ModelTemplates> blocks as you have model templates. The attributes have the following meanings:

- **Model name:** The name of the model template as shown in the **Select model(s)** dialog, which displays when you create a new model or when you execute the **Add a New Model using Wizard** menu option.
- **description:** The text that is displayed in the **Select model(s)** dialog when the name is selected.
- **location:** Contains the path of the XML file that contains the XMI export of the model template package, relative to the location of the MDG Technology file. If the XMI file is in the same folder as the technology file then this just contains the file name.
- **default:** Contains either **yes** indicating that the model template is checked by default, or **no** indicating that the model template is un-checked by default.
- **icon:** Contains an index to Enterprise Architect's base icons list. To show the appropriate view icon, use one of the following values: **29** = Use Case, **30** = Dynamic; **31** = Class; **32** = Component; **33** = Deployment; **34** = Simple.
- **filter:** If you have a large number of model templates, you can group them on the **Select model(s)** dialog by giving all the model templates in the same group the same filter name. The filter name given appears in the **Select from:** list box in the **Select model(s)** dialog.

### 5.3.1.2.8 Deploy An MDG Technology

An MDG Technology can be deployed in one of two ways: as a file or from an Add-In.

#### Deploy From a File

To deploy your technology as a file, you have a number of choices:

- Copy it to a folder named MDGTechnologies, which you must create under your Enterprise Architect installation directory (by default this is C:\Program Files\Sparx Systems\EA. When you restart Enterprise Architect, your MDG Technology is deployed.
- Copy it to any folder in your file system, including network drives: use the Enterprise Architect **Settings | MDG Technologies...** menu option, press the **Advanced** button and add the folder to the Technologies path. This deployment method enables you to quickly and easily deploy a technology to all Enterprise Architect users on a LAN.
- Upload it to an internet or intranet location: use the Enterprise Architect **Settings | MDG Technologies...** menu option, press the **Advanced** button and add the URL to the Technologies path. This deployment method enables you to quickly and easily deploy a technology to an even wider group of Enterprise Architect users.

## Deploy From an Add-in

To deploy your technology from an Add-In, you must write an [EA\\_OnInitializeTechnologies](#) <sup>[1803]</sup> function. The following example is written in VB.Net:

```
Public Function EA_OnInitializeTechnologies(ByVal Repository As EA.Repository) As Object
    EA_OnInitializeTechnologies = My.Resources.MyTechnology
End Function
```

### 5.3.1.3 Shape Scripts

#### Introduction

Enterprise Architect *Shape Scripts* enable you to specify custom shapes via a scripting language. These custom shapes are drawn instead of the standard UML notation. Each script is associated with a particular stereotype, and is drawn for every element of that stereotype. The following topics describe how to create and apply Shape Scripts:

- [Getting Started with Shape Scripts](#) <sup>[1148]</sup>
- [Write Scripts](#) <sup>[1151]</sup>
- [Example Scripts](#) <sup>[1163]</sup>
- [Shape Editor](#) <sup>[1150]</sup>
- [Add Shape Scripts to UML Profiles](#) <sup>[1104]</sup>

### 5.3.1.3.1 Getting Started With Shape Scripts

*Shape Scripts* are associated with stereotypes and are defined via the **Stereotypes** tab of the **UML Types** dialog. To access this dialog, select the **Settings | UML** menu option. Each stereotype defined can have a Shape Script.

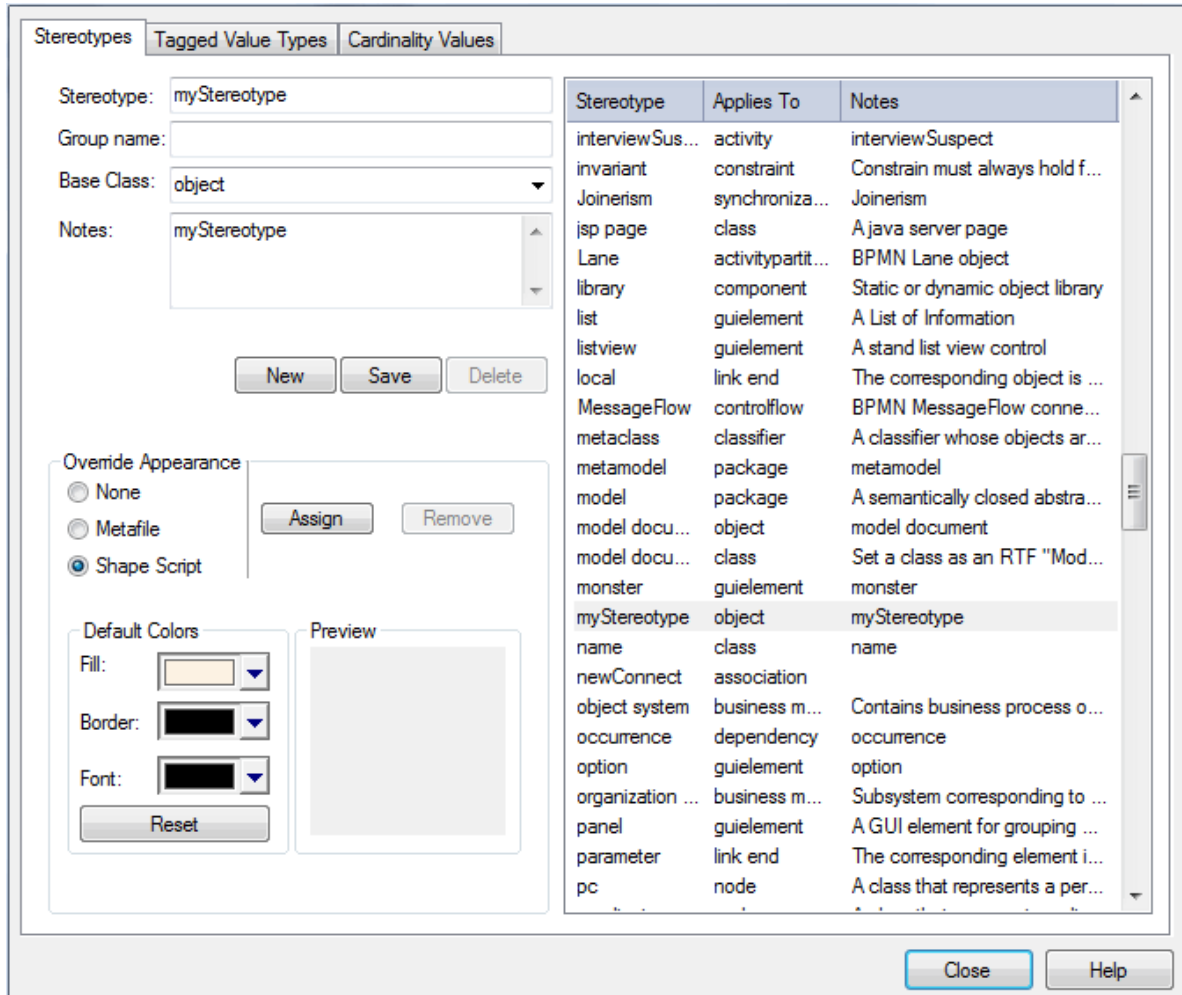

You can create a Shape Script for an existing stereotype by selecting the stereotype from the list. Alternatively, you can create new stereotypes by clicking on the **New** button and giving the stereotype a name. Select a base Class and click on the **Save** button. Once the stereotype is saved, it displays in the list.

To override the appearance, select the **Shape Script** radio button and then click on the **Assign** button. The [Shape Script Editor](#) [1150] displays.



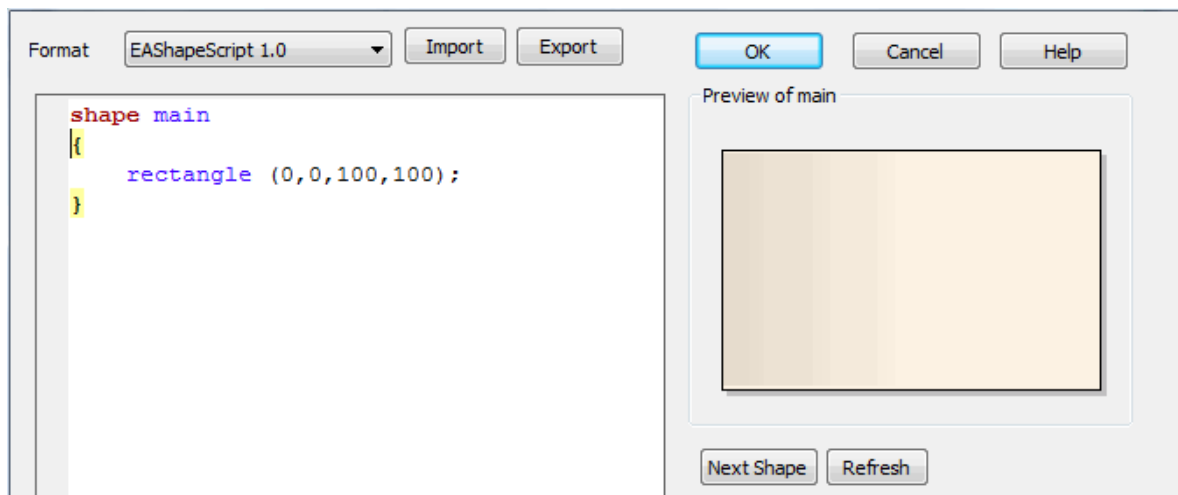

Type the example Shape Scripts in the **Edit** window. You can click on the **Refresh** button in order to view the shape in the preview window.

**Note:**

If you define a composite Shape Script (such as the connector at the end of the [Example Scripts](#)<sup>[1151]</sup> topic), click on the **Next Shape** button to page through the components of the shape.

Once you have finished [writing your Shape Script](#)<sup>[1151]</sup>, click on the **OK** button. To save the Shape Script you must click on the **Save** button on the **Stereotypes** tab.

Once you have created your Shape Script for a particular stereotype, you can assign that stereotype to an element or connector. The appearance reflects the Shape Script you created. To do this, drag and drop the appropriate element or connector into your diagram.

**Note:**

If an element's appearance is modified by a Shape Script, many of the options on the [Advanced](#)<sup>[549]</sup> context menu for that element are disabled.

Right-click on the element or connector and select the **Properties** context menu option. Click on the **Stereotype** field drop-down arrow, select the stereotype you created and click on the **OK** button. The object's shape now reflects the Shape Script you created.

The screenshot shows a dialog box with the following fields and controls:

- General** (selected tab): Details, Requirements, Constraints, Links, Scenarios, Files, Tagged Values
- Name:** Class1
- Stereotype:** architecture (dropdown menu)
- Author:** Frederick Walter (dropdown menu)
- Scope:** Public (dropdown menu)
- Alias:** (empty text field)
- Persistence:** (empty dropdown menu)
- Phase:** 1.0 (text field)
- Version:** 1.0 (text field)
- Status:** Proposed (dropdown menu)
- Complexity:** Easy (dropdown menu)
- Language:** Java (dropdown menu)
- Keywords:** (empty text field)
- Abstract:**
- Advanced:** (button)
- Notes:** (text area with rich text editor toolbar)
- Buttons:** OK, Cancel, Apply, Help

### 5.3.1.3.2 Shape Editor

The **Shape Editor** enables you to create Shape Scripts. It provides the facilities of the *Common Code Editor*, including intellisense for shape script attributes and functions. For more information on intellisense and the Common Code Editor, see the [Code Editors](#) <sup>[1428]</sup> topic.

To access the **Shape Editor**, follow the steps below:

1. Select the **Settings | UML** menu option; the **UML Types** dialog displays, defaulted to the **Stereotypes** tab.
2. Type a name in the **Stereotype** field, or click on an the required stereotype in the list.
3. From the **Override Appearance** panel, select the **Shape Script** radio button.
4. Click on the **Assign** button. The **Shape Editor** dialog displays.

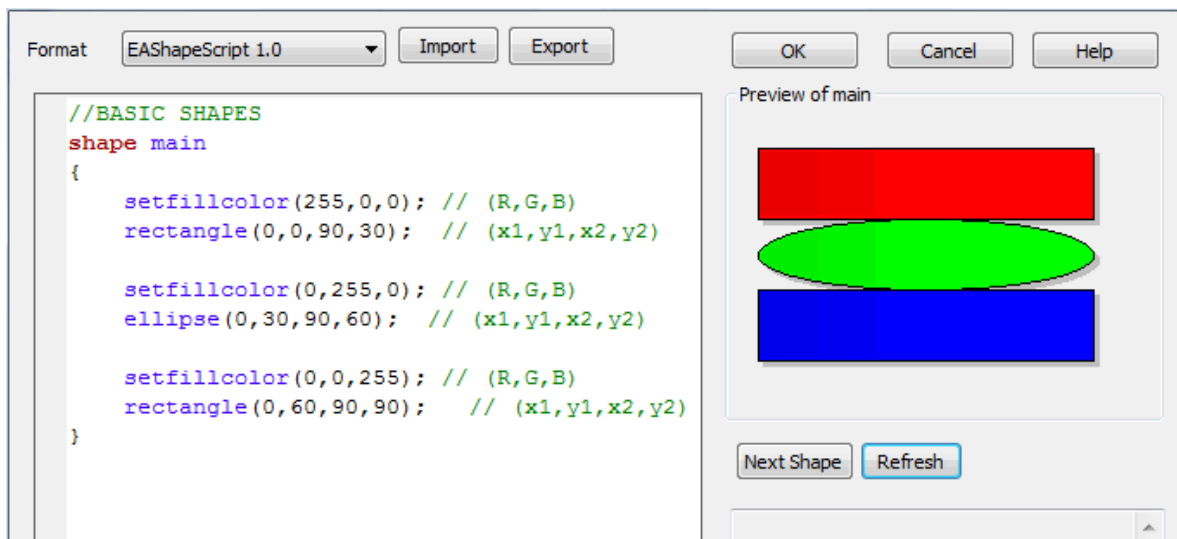

Option	Use to
Format	Select the Shape Script version.
Import	Import a Shape Script from a text file.
Export	Export a Shape Script to a text file.
OK	Exit from the <b>Shape Editor</b> , don't forget to save your script from the <b>Stereotypes</b> tab. See <a href="#">Getting Started With Shape Scripts</a> <sup>[1148]</sup> .
Next Shape	Rotate though the multiple shape definitions.
Refresh	Parse your script and display the result in the <b>Preview</b> window.

### 5.3.1.3.3 Write Scripts

This topic is a detailed reference for writing Shape Scripts. For an introduction to writing Shape Scripts, see the [Getting Started With Shape Scripts](#) <sup>[1148]</sup> and [Example Scripts](#) <sup>[1163]</sup> topics.

See the following reference topics for more detailed information on shape scripting:

- [Syntax Grammar](#) <sup>[1151]</sup>
- [Shape Attributes](#) <sup>[1152]</sup>
- [Drawing Methods](#) <sup>[1154]</sup>
- [Color Queries](#) <sup>[1158]</sup>
- [Conditional Branching](#) <sup>[1158]</sup>
- [Query Methods](#) <sup>[1158]</sup>
- [Display Element/Connector Properties](#) <sup>[1158]</sup>
- [Sub-shapes](#) <sup>[1160]</sup>
- [Reserved Names](#) <sup>[1161]</sup>
- [Miscellaneous](#) <sup>[1162]</sup>

#### 5.3.1.3.3.1 Syntax Grammar

Grammar symbols:

- \* = zero or more
- + = one or more
- | = or
- ; = terminator

<b>ShapeScript</b>	::=	<Shape>*;
<b>Shape</b>	::=	<ShapeDeclaration> <ShapeBody>;
<b>ShapeDeclaration</b>	::=	<ShapeType> <ShapeName>;
<b>ShapeType</b>	::=	"shape"   "decoration";
<b>ShapeName</b>	::=	<ReservedShapeName>   <stringliteral>;
<b>ReservedShapeName</b>	::=	See <a href="#">Reserved Names</a> <sup>[1167]</sup> for full reserved shape listing
<b>ShapeBody</b>	::=	"{" <InitialisationAttributeAssignment>* <DrawingStatement>* <SubShape>* "}";
<b>InitialisationAttributeAssignment</b>	::=	<Attribute> "=" <Value> ",";
<b>Attribute</b>	::=	See <a href="#">Shape Attributes</a> <sup>[1152]</sup> for full listing of attribute names
<b>DrawingStatement</b>	::=	<IfElseSection>   <Method>;
<b>IfElseSection</b>	::=	"if" "(" <QueryExpression> ")" <TrueSection> [<ElseSection>];
<b>QueryExpression</b>	::=	<QueryName> "(" <ParameterList> ")";
<b>QueryName</b>	::=	See <a href="#">Query Methods</a> <sup>[1158]</sup> for a full listing of Query names
<b>TrueSection</b>	::=	"{" <DrawingStatement>* "}"
<b>ElseSection</b>	::=	"else" "{" <DrawingStatement>* "}"
<b>Method</b>	::=	<MethodName> "(" <ParameterList> ")" ",";
<b>MethodName</b>	::=	See <a href="#">Drawing Methods</a> <sup>[1154]</sup> for a full listing of method names

### 5.3.1.3.3.2 Shape Attributes

*syntax: attribute "=" value ","*

example:

```
shape main
{
    //Initialisation attributes - must be before drawing commands
    noshadow = "true";
    h_align = "center";

    //drawing commands
    rectangle(0,0,100,100);
    println("foo bar");
}
```

Attribute Name	Type	Description
<b>bottomAnchorOffset</b>	<i>(int,int)</i>	When creating a Shape Script for an embedded element (such as a Port), use this attribute to offset the shape from the bottom edge of its parent. For example: <i>bottomAnchorOffset=(0,-10)</i> ; move embedded element up 10 pixels from the bottom edge
<b>dockable</b>	<i>string</i>	Makes the shape default to <a href="#">dockable</a> <sup>[555]</sup> , so that it can be aligned with and joined to other elements (both other Shape Scripts and standard elements) on a diagram. You cannot reverse the dockable status with the

Attribute Name	Type	Description
		<b>Appearance</b> menu option; to change the status, you must edit the Shape Script. Valid values: <b>standard</b> or <b>off</b>
<b>editableField</b>	<i>string</i>	Defines a shape as an editable region of the element. This field impacts element shapes only, line glyphs are not supported. Valid Values: <b>alias, name, note, stereotype</b>
<b>endPointY, endPointX</b>	<i>integer</i>	Only used for the reserved target and source shapes for connectors; this point determines where the main connector line connects to the end shapes. Default: <b>0</b> and <b>0</b>
<b>fixedAspectRatio</b>	<i>string</i>	Set to <b>true</b> to fix the aspect ratio. Do not use if you do not want to fix the aspect ratio.
<b>h_Align</b>	<i>string</i>	Affects horizontal placement of printed text and subshapes depending on the <b>layoutType</b> attribute. Valid values: <b>left, center, or right</b>
<b>layoutType</b>	<i>string</i>	Determines how subshapes are sized and positioned. See <a href="#">Subshape Layout</a> <sup>[116b]</sup> for further details. Valid values: <b>leftright, topdown, border</b>
<b>leftAnchorOffset</b>	<i>(int,int)</i>	When creating a Shape Script for an embedded element (such as a Port), use this attribute to offset the shape from the left edge of its parent. For example: <i>leftAnchorOffset=(10,0)</i> ; move embedded element right 10 pixels from the left edge
<b>noShadow</b>	<i>string</i>	Set to <b>true</b> to suppress the shapes shadow from being rendered. Valid values: <b>true</b> or <b>false</b> (default= <b>false</b> )
<b>orientation</b>	<i>string</i>	Applies to decoration shapes only. Determines where the decoration is positioned within the containing element glyph. Valid values: <b>NW, N, NE, E, SE, S, SW, W</b>
<b>preferredHeight</b>		Used by <b>border</b> layoutType - north and south Used in drawing the source and target shapes for connectors to determine how wide the line is.
<b>preferredWidth</b>		Used by <b>border</b> layoutType - east and west. Used by <b>leftright</b> layoutType, shapes where <i>scalable</i> is <b>false</b> to determine how much space they occupy for layout purposes.
<b>rightAnchorOffset</b>	<i>(int,int)</i>	When creating a Shape Script for an embedded element (such as a Port), use this attribute to offset the shape from the right edge of its parent. For example: <i>rightAnchorOffset=(-10,0)</i> ; move embedded element left 10 pixels from the right edge
<b>rotatable</b>	<i>string</i>	Set to <b>false</b> to prevent rotation of the shape. This attribute is only applicable to the source and target shapes for lines glyphs. Valid values: <b>true</b> or <b>false</b> (default = <b>true</b> )

Attribute Name	Type	Description
<b>scalable</b>	<i>string</i>	Set to <b>false</b> to stop the shape from being relatively sized to the associated diagram glyph. Valid values: <b>true</b> or <b>false</b> (default= <b>true</b> )
<b>topAnchorOffset</b>	<i>(int,int)</i>	When creating a Shape Script for an embedded element (such as a Port), use this attribute to offset the shape from the top edge of its parent. For example: <i>topAnchorOffset=(0,10)</i> ; move embedded element down 10 pixels from the top edge
<b>v_Align</b>	<i>string</i>	Affects vertical placement of printed text and subshapes depending on the <b>layoutType</b> attribute. Valid values: <b>top</b> , <b>center</b> , or <b>bottom</b>

### 5.3.1.3.3.3 Drawing Methods

Method Name	Description
<b>addsubshape</b> ( <b>string shapename</b> [], <b>int width</b> , <b>int height</b> )	Adds a sub-shape with the name <b>shapename</b> that must be defined within the current shape definition.
<b>arc</b> ( <b>int left</b> , <b>int top</b> , <b>int right</b> , <b>int bottom</b> , <b>int startingpointx</b> , <b>int startingpointy</b> , <b>int endingpointx</b> , <b>int endingpointy</b> )	Draws an elliptical anticlockwise arc with the ellipse having extents at <b>left</b> , <b>top</b> , <b>right</b> and <b>bottom</b> . The start point of the arc is defined by the intersection of the ellipse and the line from the center of the ellipse to the point ( <b>startingpointx</b> , <b>startingpointy</b> ). The end of the arc is similarly defined by the intersection of the ellipse and the line from the center of the ellipse to the point ( <b>endingpointx</b> , <b>endingpointy</b> ). For example: <code>Arc(0, 0, 100, 100, 95, 0, 5, 0);</code>
<b>arco</b> ( <b>int left</b> , <b>int top</b> , <b>int right</b> , <b>int bottom</b> , <b>int startingpointx</b> , <b>int startingpointy</b> , <b>int endingpointx</b> , <b>int endingpointy</b> )	As for the arc method, except that a line is drawn from the current position to the starting point of the arc, and then the current position is updated to the end point of the arc.

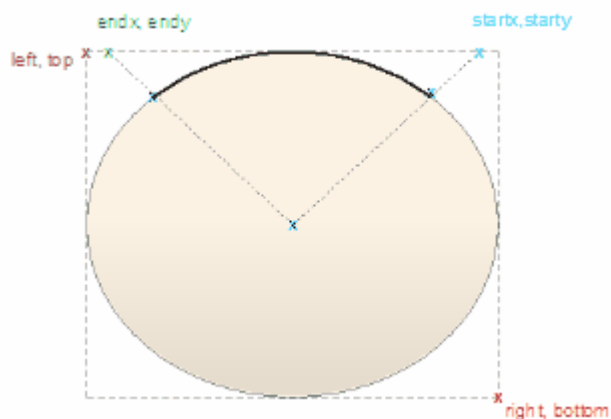

Method Name	Description
<b>bezierto</b> ( int controlpoint1x, int controlpoint1y, int controlpoint2x, int controlpoint2y, int endpointx, int endpointy)	Draws a bezier curve and updates the pen position.
<b>defSize</b> (int width, int height)	<p>Sets the default size of the element.</p> <p>This can appear in IF and ELSE clauses with different values in each, and causes the element to be resized automatically each time the values change. For example:</p> <pre>if(HasTag("horizontal","true")) {     defSize(100,20);     rectangle(0,0,100,100); } else {     defSize(20,100);     rectangle(0,0,100,100); }</pre> <p>The above example sets the shape to the specified default size each time the Tagged Value <i>horizontal</i> is changed.</p> <p>When this is set, <b>[Alt]+[Z]</b> also resizes the shape to the defined dimensions.</p> <p><b>Note:</b></p> <p>The minimum value for both <b>int width</b> and <b>int height</b> is 10.</p>
<b>drawnativeshape</b> ()	<p>Causes Enterprise Architect to render the shape using its usual, non-Shapescript notation. Subsequent drawing commands are super-imposed over the native notation.</p> <p>This method is only enabled for element Shape Scripts; line Shape Scripts are not supported.</p>
<b>ellipse</b> ( int left, int top, int right, int bottom)	Draws an ellipse with extents defined by <b>left</b> , <b>top</b> , <b>right</b> and <b>bottom</b> .
<b>endpath</b> ()	Ends the sequence of drawing commands that define a path.
<b>fillandstrokepath</b> ()	Fills the previously defined path with the current fill color, then draws its outline with the current pen.
<b>fillpath</b> ()	Fills the previously defined path with the current fill color.
<b>hidelabel</b> ( string labelname)	Hides the label specified by <b>labelname</b> .
<b>image</b> ( string imageld, int left, int top, int right, int bottom)	<p>Draws the image that has the name <b>imageld</b> in the <b>Image Manager</b>.</p> <p><b>Note:</b></p> <p>The image must exist within the model in which the stereotype is used. If it does not already exist in the model, you must import it as <a href="#">reference data</a> [225].</p>
<b>lineto</b> (	Draws a line from the current cursor position to a point specified by <b>x</b> and <b>y</b> ,

Method Name	Description
<code>int x,</code> <code>int y)</code>	and then updates the pen cursor to that position.
<code>moveto(</code> <code>int x,</code> <code>int y)</code>	Moves the pen cursor to the point specified by <b>x</b> and <b>y</b> .
<code>polygon(</code> <code>int centerx,</code> <code>int centery,</code> <code>int numberofsides,</code> <code>int radius,</code> <code>float rotation)</code>	Draws a regular polygon with center at the point ( <b>centerx</b> , <b>centery</b> ), and <b>numberofsides</b> number of sides.
<code>print(</code> <code>string text)</code>	Prints the specified text string.  <b>Note:</b> You cannot change the font size, type or color of this text.
<code>printifdefined(</code> <code>string</code> <code>propertyname,</code> <code>string truepart[,</code> <code>string falsepart])</code>	Prints the <i>truepart</i> if the given property exists and has a non-empty value, otherwise prints the optional <i>falsepart</i> .  <b>Note:</b> You cannot change the font size, type or color of this text.
<code>println(</code> <code>string text)</code>	Appends a line of text to the shape and a line break.  <b>Note:</b> You cannot change the font size, type or color of this text.
<code>printwrapped(</code> <code>string text)</code>	Prints the specified text string, wrapped over multiple lines if the text is wider than its containing shape.  <b>Note:</b> You cannot change the font size, type or color of this text.
<code>rectangle(</code> <code>int left,</code> <code>int top,</code> <code>int right,</code> <code>int bottom)</code>	Draws a rectangle with extents at <b>left</b> , <b>top</b> , <b>right</b> , <b>bottom</b> . Values are percentages.
<code>roundrect(</code> <code>int left,</code> <code>int top,</code> <code>int right,</code> <code>int bottom,</code> <code>int</code> <code>abs_cornerwidth,</code> <code>int</code> <code>abs_cornerheight)</code>	Draws a rectangle with rounded corners, with extents defined by <b>left</b> , <b>top</b> , <b>right</b> and <b>bottom</b> . The size for the corners is defined by <b>abs_cornerwidth</b> and <b>abs_cornerheight</b> ; these values do not scale with the shape.
<code>setdefaultcolors()</code>	Returns the brush and pen color to the default settings, or to the user-defined colors if available. See <a href="#">Color Queries</a> <sup>[1158]</sup> .
<code>setfillcolor(</code> <code>int red,</code> <code>int green,</code>	Sets the fill color.  You can specify the required color by defining RGB values or using a color value returned by any of the <a href="#">Color Queries</a> <sup>[1158]</sup> ; for example:



Method Name	Description
<pre>int blue) setfillcolor(     Color newColor)</pre>	<p>GetUserFillColor()</p>
<pre>setlinestyle(     string linestyle)</pre>	<p>Changes the stroke pattern for commands that use the pen.</p> <p>Parameters:</p> <p><b>string linestyle:</b> the following styles are valid:</p> <ul style="list-style-type: none"> <li>• <b>solid</b></li> <li>• <b>dash</b></li> <li>• <b>dot</b></li> <li>• <b>dashdot</b></li> <li>• <b>dashdotdot</b></li> </ul>
<pre>setorigin(     string relativeTo,     int xOffset,     int yOffset)</pre>	<p>Positions floating text labels relative to the main shape.</p> <p><b>relativeTo</b> is one of <b>N, NE, E, SE, S, SW, W, NW, CENTER</b></p> <p><b>xOffset</b> and <b>yOffset</b> are in pixels, not percentage values, and can be negative.</p>
<pre>setpen(     int red,     int green,     int blue[,     int penwidth])</pre>	<p>Sets the pen to the defined color and optionally sets the pen width.</p> <p><b>Note:</b></p> <p>This method is only for line-drawing commands. It does not affect any text commands.</p>
<pre>setpencolor(     int red,     int green,     int blue) setpencolor(     Color newColor)</pre>	<p>Sets the pen color.</p> <p>You can specify the required color by defining RGB values or using a color value returned by any of the <a href="#">Color Queries</a> <sup>[1158]</sup>; for example:</p> <pre>GetUserFillColor()</pre> <p><b>Note:</b></p> <p>This method is only for line-drawing commands. It does not affect any text commands.</p>
<pre>setpenwidth(     int penwidth)</pre>	<p>Sets the width of the pen. Pen width should be between <b>1</b> and <b>5</b>.</p> <p><b>Note:</b></p> <p>This method is only for line-drawing commands. It does not affect any text commands.</p>
<pre>showlabel(     string labelname)</pre>	<p>Reveals the hidden label specified by <b>labelname</b>.</p>
<pre>startcloudpath(     puffWidth,     puffHeight,     noise)</pre>	<p>Similar to <b>StartPath</b>, except that it draws the path with cloud-like curved segments (<i>puffs</i>).</p> <p>Parameters:</p> <ul style="list-style-type: none"> <li>• <i>float</i> <b>puffWidth</b> (default = <b>30</b>), the horizontal distance between puffs</li> <li>• <i>float</i> <b>puffHeight</b> (default = <b>15</b>), the vertical distance between puffs</li> <li>• <i>float</i> <b>noise</b> (default = <b>1.0</b>), the randomization of the puffs' positions.</li> </ul>
<pre>startpath()</pre>	<p>Starts the sequence of drawing commands that define a path.</p>
<pre>strokepath()</pre>	<p>Draws the outline of the previously defined path with the current pen.</p>

#### 5.3.1.3.3.4 Color Queries

Color queries can only be used to retrieve arguments for the *SetPenColor* and *SetFillColor* commands. These queries can be used in place of the arguments.

```

getUserFillColor()
getUserBorderColor()
getUserFontColor()
getUserPenSize()

    shape main
    {
        setfillcolor(getuserbordercolor());
        setpencolor(getuserfillcolor());

        rectangle(0,0,100,100);
    }

```

#### 5.3.1.3.3.5 Conditional Branching

Shape Scripts provide condition branching with the *if else* statement, and query methods that evaluate to either *True* or *False*. See:

- [Syntax Grammar](#)<sup>[1157]</sup> for IF statement syntax.
- [Query Methods](#)<sup>[1158]</sup> for methods that can be used as the conditional expression for IF statements.
- [Example Scripts](#)<sup>[1163]</sup> for an example.

#### 5.3.1.3.3.6 Query Methods

Two query methods are available for seeing if the associated element has certain tags or properties; these methods can be used as the conditional expression for an *if else* statement.

Method	Description
<b>boolean HasTag( string tagname, [string tagvalue])</b>	Returns <b>true</b> if the associated element has a tag value with the name <i>tagname</i> . If the second parameter <i>tagvalue</i> is provided, the tag <i>tagname</i> must be present, and the value of the tag has to be equal to <i>tagvalue</i> for the method to return <b>true</b> .
<b>boolean HasProperty( string propertyname, [string propertyvalue])</b>	Returns <b>true</b> if the associated element has a property with the name <i>propertyname</i> . If the second parameter <i>propertyvalue</i> is provided, the property must be present, and the value of the property has to be equal to <i>propertyvalue</i> for the method to return <b>true</b> .  See <a href="#">Display Element/Connector Properties</a> <sup>[1158]</sup> for a list of valid values for <i>propertyname</i> .

#### 5.3.1.3.3.7 Display Element/Connector Properties

The commands **print**, **println**, and **printwrapped** all take a string parameter representing the text to be printed. Element and connector properties can be added to the text using the substitution macro *#propertyname#*.

For example: `println("name: #NAME#");`

In addition to the properties listed below, Tagged Values can also be displayed by prefixing the Tagged Value name with TAG:.

For example: `print("#TAG:condition#");`

You can also test against and display an element's *custom* properties in the same way as you do the named properties.

For example: `if(hasproperty("Name", "Value"))`

...

and: `print("#Name#");`

## Properties Visible to Shape Scripts

### Properties for Element Shape Scripts

- addin (value returned from an Add-In)
- alias
- author
- cardinality
- classifier
- classifier.alias
- classifier.metatype
- classifier.stereotype
- classifier.type
- complexity
- concurrency
- datecreated
- datemodified
- diagram.mdgtype
- diagram.name
- diagram.stereotype
- diagram.type
- haslinkeddokument
- isabstract
- isactive
- iscomposite
- isembedded
- isinparent
- isleaf
- islocked
- isroot
- isspec
- istagged
- keywords
- language
- metatype
- multiplicity
- name
- notes
- packagename
- parentedge ("Right", "Left", "Top", "Bottom")
- parent.metatype
- persistence
- phase
- propertytype
- propertytype.alias
- propertytype.metatype
- propertytype.name
- propertytype.stereotype
- scope
- status
- stereotype
- type
- version

- visibility.

#### Properties for Connector Shape Scripts

- addin (value returned from an Add-In)
- alias
- diagram.connectornotation
- diagram.mdgtype
- diagram.name
- diagram.stereotype
- diagram.type
- direction
- isroot
- isleaf
- name
- notes
- source.aggregation
- source.alias
- source.changeable
- source.constraints
- source.element.name
- source.element.stereotype
- source.metatype
- source.multiplicity
- source.multiplicityisordered
- source.qualifiers
- source.stereotype
- source.targetscope
- stereotype
- subtype
- target.aggregation
- target.alias
- target.changable
- target.constraints
- target.element.name
- target.element.stereotype
- target.metatype
- target.multiplicity
- target.multiplicityisordered
- target.qualifiers
- target.stereotype
- target.targetscope
- type.

#### 5.3.1.3.3.8 Sub-Shapes

Shapes can contain - and be composed of - other shapes.

#### Subshape Layout

To set the layout type, the *layoutType* attribute must be set in the **initialization attributes** section of the script; in other words, before any of the methods are called. Valid values for this attribute are:

#### LeftRight

Shapes with *leftright* layout position subshapes side by side, with the first added on the left, and subsequent subshapes to the right.

## TopDown

*TopDown* places subshapes in a vertical arrangement, with the first shape added to the top and subsequent shape added below.

## Border

*Border* layout requires an additional argument to the *addsubshape* method to specify which region of the containing shape the subshape is to occupy: *N*, *E*, *S*, *W* or *CENTER*. Each region can only be occupied by one subshape.

A subshape that is assigned to the *E* or *W* region must have its *preferredwidth* attribute specified in its declaration. Similarly, subshapes added to *N* or *S* must have their *preferredheight* attribute set. In this case, the values for these attributes are treated as static lengths and do not scale glyphs.

For example:

```
shape main
{
  layouttype="topdown";
  setfillcolor{0,0,255};
  rectangle{0,0,100,100};
  addsubshape{"sub",50,100,20,0};
  addsubshape{"sub",50,100,30,-100};
  addsubshape{"sub",50,100,40,-200};
  addsubshape{"sub",50,100,50,-300};

  shape sub
  {
    setfillcolor{0,255,0};
    ellipse{0,0,100,100};
  }
}
```

The above script provides the following shape:

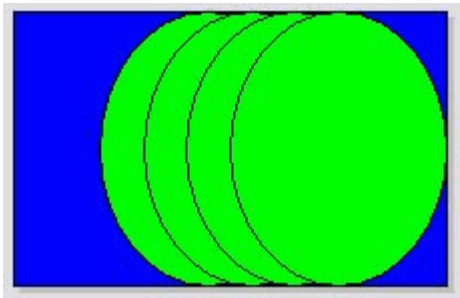

### 5.3.1.3.3.9 Reserved Names

#### Elements

Elements (such as Class, State or Event) have the following reserved names for parts of the shape.

Name	Description
<b>shape main</b>	The <b>main</b> shape is the whole shape.
<b>shape label</b>	The shape <b>label</b> gives the shape a detached label.
<b>decoration</b> <identifier>	<b>Decoration</b> gives the shape a decoration as defined by the name in <identifier>.

#### Connectors

Connectors (such as Association, Dependency or Generalization) have the following reserved names for parts

of the shape.

Name	Description
<b>shape main</b>	The <b>main</b> shape is the whole shape.
<b>shape source</b>	The <b>source</b> shape is an extra shape at the source end of the connector.
<b>shape target</b>	The <b>target</b> shape is an extra shape at the target end of the connector.
<b>shape &lt;labelID&gt;</b>	The <labelID> gives the connector a detached label, where <labelID> is one of the following: <ul style="list-style-type: none"> <li>• <b>LeftTopLabel</b></li> <li>• <b>MiddleTopLabel</b></li> <li>• <b>RightTopLabel</b></li> <li>• <b>LeftBottomLabel</b></li> <li>• <b>MiddleBottomLabel</b></li> <li>• <b>RightBottomLabel</b></li> </ul>

#### 5.3.1.3.3.10 Miscellaneous

##### Return Command

Execution of the script can be terminated by using the return command. Please see [Example Scripts](#)<sup>[1163]</sup> for an example.

##### Looping

The Shape Script feature does not support looping constructs.

##### Comments

C-style comments are supported. For example:

```
// C Style Single Line comment
/* Multi Line
comment supported */
```

##### String Manipulation

Not Supported.

##### Arithmetical Operations

Not Supported.

##### Variables Declaration

Not Supported.

##### Change ShapeScript Fonts

Not possible.

##### Can I apply a Shapescrpt without using Stereotypes?

No.

### 5.3.1.3.4 Example Scripts

Below is a selection of example Shape Scripts.

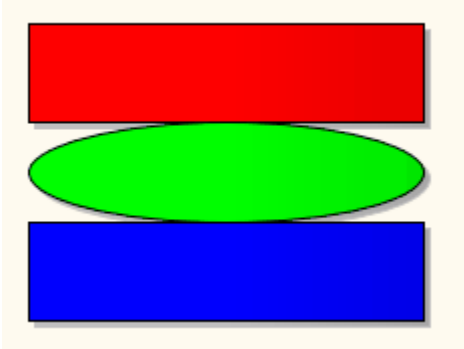
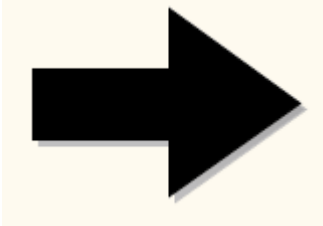
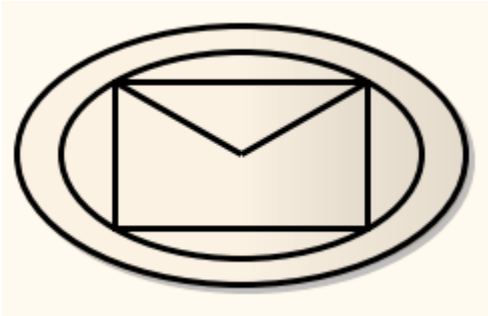
Code	Result
<pre>//BASIC SHAPES shape main {     setfillcolor(255,0,0); // (R,G,B)     rectangle(0,0,90,30); // (x1,y1,x2,y2)      setfillcolor(0,255,0); // (R,G,B)     ellipse(0,30,90,60); // (x1,y1,x2,y2)      setfillcolor(0,0,255); // (R,G,B)     rectangle(0,60,90,90); // (x1,y1,x2,y2) }</pre>	
<pre>//SINGLE CONDITIONAL SHAPE shape main {     if (HasTag("Trigger","Link"))     {         // Only draw if the object has a Tagged Value         // Trigger=Link         // Set the fill color for the path         setfillcolor(0,0,0);         startpath(); // Start to trace out a path         moveto(23,40);         lineto(23,60);         lineto(50,60);         lineto(50,76);         lineto(76,50);         lineto(50,23);         lineto(50,40);         endpath(); // End tracing out a path         // Fill the traced path with the fill color         fillandstrokepath();         return;     } }</pre>	
<pre>//MULTI CONDITIONAL SHAPE shape main {     startpath();     ellipse(0,0,100,100);     endpath();     fillandstrokepath();     ellipse(3,3,27,27);      if (HasTag("Trigger","None"))     {         return;     }      if (HasTag("Trigger","Error"))     {         setfillcolor(0,0,0);         startpath();         moveto(23,77);         lineto(37,40);         lineto(60,47);         lineto(77,23);         lineto(63,60);         lineto(40,53);         lineto(23,77);         endpath();         fillandstrokepath();         return;     }      if (HasTag("Trigger","Message"))</pre>	

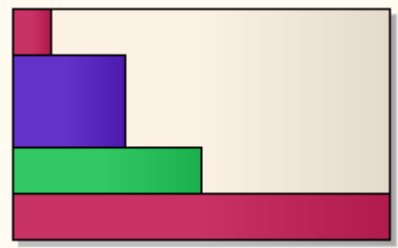
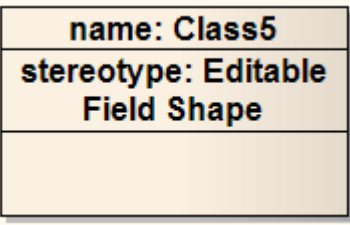
Code	Result
<pre> {   rectangle(22,22,78,78);   moveto(22,22);   lineto(50,50);   lineto(78,22);   return; } </pre>	
<pre> //SUB SHAPES shape main {   rectangle(0,0,100,100);    addsubshape("red", 10, 20);   addsubshape("blue", 30, 40);   addsubshape("green", 50, 20);   addsubshape("red", 100, 20);    shape red   {     setfillcolor(200, 50, 100);     rectangle(0,0,100,100);   }    shape blue   {     setfillcolor(100, 50, 200);     rectangle(0,0,100,100);   }    shape green   {     setfillcolor(50, 200, 100);     rectangle(0,0,100,100);   } } </pre>	
<pre> //Editable Field Shape shape main {   rectangle(0,0,100,100);    addsubshape("namecompartment", 100, 20);   addsubshape("stereotypecompartment", 100, 40);    shape namecompartment   {     h_align = "center";     editablefield = "name";      rectangle(0,0,100,100);     println("name: #name#");   }    shape stereotypecompartment   {     h_align = "center";     editablefield = "stereotype";      rectangle(0,0,100,100);     println("stereotype: #stereotype#");   } } </pre>	

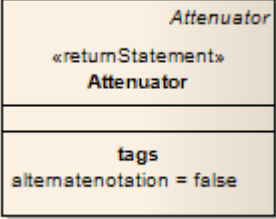
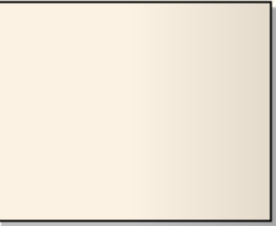
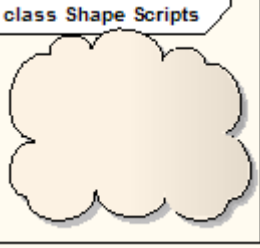
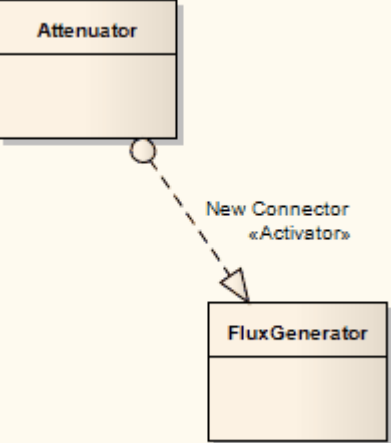

Code	Result
<pre> //Return Statement Shape shape main {     if(hasTag("alternatenotation", "false"))     {         //draw ea's inbuild glyph         drawnativeshape();         //exit script with the return statement         return;     }      //alternate notation commands     //...     rectangle(0,0,100,100); } </pre>	 
<pre> //Cloud Path Example Shape shape main {     StartCloudPath();     Rectangle(0,0,100,100);     EndPath();     FillAndStrokePath(); } </pre>	
<pre> // Connector Example shape main {     // draw a dashed line     noshadow=true;     setlinestyle("DASH");     moveto(0,0);     lineto(100,0); }  shape source {     // draw a circle at the source end     rotatable = true;     startpath();     ellipse(0,6,12,-6);     endpath();     fillandstrokepath(); }  shape target {     // draw an arrowhead at the target end     rotatable = true;     startpath();     moveto(0,0);     lineto(16,6);     lineto(16,-6);     endpath();     fillandstrokepath(); } </pre>	
<pre> // Double Line shape main {     noshadow=true;     moveto(0,-10);     lineto(100,-10);     moveto(0,10);     lineto(100,10); } </pre>	

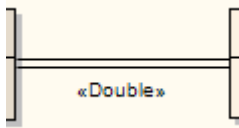
Code	Result
}	

### 5.3.1.4 Tagged Value Types

Enterprise Architect provides a number of predefined Tagged Value Types that enable you to create your own:

- Tagged Values that are [structured](#) [1166] with a specific format, with or without tag [filters](#) [1167], or
- Tagged Values that return values from the various [reference data](#) [1169] tables.

You can also use a masking parameter to create your own customized [masked Tagged Value Type](#) [1171].

#### Note:

You can transport Tagged Value Type definitions between models, using the [Export Reference Data](#) [223] and [Import Reference Data](#) [223] options on the **Tools** menu. Tagged Value Types are exported as *Property Types*.

#### 5.3.1.4.1 Predefined Structured Types

This table details the predefined structured Tagged Value types, along with the syntax used to create the initial values for their use. You use these to [create your own structured Tagged Values](#) [1168].

#### Note:

**Tagged Value Type** and **Format** entries are case-sensitive.

Tagged Value Type	Format	Description
Boolean	<b>Type=Boolean;</b> <b>Default=Val;</b>	Enables input of <b>True</b> or <b>False</b> , either of which can be the default value.
Classifier	<b>Type=Classifier;</b> <b>Values=Type1,Type2;</b> <b>Stereotypes=Stereotype 1;</b>	<b>Deprecated. Use RefGUID and RefGUIDList.</b> Returns the <i>name</i> of a user-selected element from the model, where <b>Type1</b> and <b>Type2</b> specify one or more allowed element types and <b>Stereotype1</b> represents an allowed stereotype.
Color	<b>Type=Color;</b> <b>Default=Val;</b>	Enables input of a color value from a color chooser menu, where the value is the decimal integer translation of the color's Hex RGB value. For example, the RGB for Red is FF, and the decimal value is 255.
Const	<b>Type=Const;</b> <b>Default=Val;</b>	Enables creation of a read-only constant value.
Custom	<b>Type= Custom;</b>	Enables you to create your own template for predefined types; more information is provided in the <a href="#">Create Custom Tagged Value Type</a> [1171] topic.
DateTime	<b>Type=DateTime;</b>	Enables input of the date and time for the Tagged Value from a calendar menu.
Directory	<b>Type=Directory;</b> <b>Default=Val;</b>	Enables entry of a directory path from a browser. You can set a default directory path as a string value.
Enum	<b>Type=Enum;</b> <b>Values=Val1,Val2,Val3;</b> <b>Default=Val2;</b>	Enables definition of a comma-separated list, where <b>Val1</b> , <b>Val2</b> and <b>Val3</b> represent values in the list and <b>Default</b> represents the default value of the list.

Tagged Value Type	Format	Description
File	<b>Type=File;</b> <b>Default=Val;</b>	Enables input of a filename from a file browser dialog. The named file can be launched in its default application.  You can set a default file as a string containing the file path and file name.
Float, Decimal, Double	<b>Type=Float;</b> <b>Type=Decimal;</b> <b>Type=Double;</b> <b>Default=Val;</b>	Enable entry of a Float, Decimal or Double value. These types all map to the same type of data.  You can set a default for any or all of these.
Integer	<b>Type=Integer;</b> <b>Default=Val;</b>	Enables entry of an Integer value, and a default.
Memo	<b>Type=Memo;</b>	Enables input of large and complex Tagged Values.
RefGUID	<b>Type=RefGUID;</b> <b>Values=Type1,Type2;</b> <b>Stereotypes=Stereotype 1;</b>	Enables the Tagged Value to reference an element from the model by specifying the element's <i>GUID</i> , where <b>Type1</b> and <b>Type2</b> specify one or more allowed diagram objects (such as <b>Class</b> , <b>Component</b> , <b>Attribute</b> or <b>Operation</b> ) and <b>Stereotype1</b> represents an allowed stereotype.  Set the <a href="#">classifier</a> <sup>[515]</sup> , <a href="#">attribute or operation</a> <sup>[748]</sup> for a Tagged Value of this type by clicking on the [ ... ] button against the Tagged Value in the <b>Tagged Value</b> window.
RefGUIDList	<b>Type=RefGUIDList;</b> <b>Values=Type1,Type2;</b> <b>Stereotypes=Stereotype 1;</b>	Enables the Tagged Value to reference a list of elements from the model by specifying each element's <i>GUID</i> , where <b>Type1</b> and <b>Type2</b> specify one or more allowed diagram objects (such as <b>Class</b> or <b>Component</b> ) and <b>Stereotype1</b> represents an allowed stereotype.  Set the <a href="#">classifier</a> <sup>[515]</sup> , <a href="#">attribute or operation</a> <sup>[748]</sup> for a Tagged Value of this type by clicking on the [ ... ] button against the Tagged Value in the <b>Tagged Value</b> window.
Spin	<b>Type=Spin;</b> <b>LowerBound=x;</b> <b>UpperBound=x;</b> <b>Default=Val;</b>	Enables creation of a spin control with the value of <b>LowerBound</b> being the lowest value and <b>UpperBound</b> being the highest value.  You can also set a default within that range.
String	<b>Type=String;</b> <b>Default=Val;</b>	Enables entry of a string value, up to 255 characters in length, and a default text string.  For longer texts, use <i>Type=Memo</i> <sup>[1167]</sup> .
URL	<b>Type=URL;</b> <b>Default=Val;</b>	Enables entry of a web URL. The URL should start with: <ul style="list-style-type: none"> <li>• 'http://'</li> <li>• 'https://'</li> <li>• 'www.'</li> </ul> You can set a default URL as a string value.

## Tag Filters

The following table details filters that can be used to restrict where a Tagged Value can be applied.

Filter	Format	Description
AppliesTo	<b>AppliesTo=Type1, Type2;</b>	Restricts the element types this filter can be applied to, where <b>Type1</b> and <b>Type2</b> are the valid types.  Possible values are: <ul style="list-style-type: none"> <li>• all element types</li> <li>• all connector types</li> <li>• Attribute</li> <li>• Operation and</li> <li>• OperationParameter.</li> </ul>
BaseStereotype	<b>BaseStereotype=S1,S2;</b>	Restricts the stereotypes that this tag belongs to, where <b>S1</b> and <b>S2</b> are the allowed stereotypes.

#### 5.3.1.4.2 Create Structured Tagged Values

To create your own Tagged Value based on a predefined [structured Tagged Value Type](#)<sup>[1168]</sup>, follow the steps below:

1. Select the **Settings | UML** menu option. The **UML Types** dialog displays. Select the **Tagged Value Types** tab.

The screenshot shows the 'UML Types' dialog with the 'Tagged Value Types' tab selected. The 'Tag Name' field contains 'Handicap' and the 'Description' field contains 'Spin Control'. The 'Detail' field contains the following text: 'Type=Spin; LowerBound=0; UpperBound=250;'. Below the detail field are 'New', 'Save', and 'Delete' buttons. At the bottom, there is a 'Defined Tag Types' table with the following content:

Type	Description
Activity	
Assignments	Assignments
Author	Returns Authors of the Model
Categories	Categories
Datafield	Database field
go	ki
Handicap	Spin Control
InMessage	
InputPropertyMaps	InputPropertyMaps
IORules	IORules
..	

At the bottom of the dialog are 'Close' and 'Help' buttons.

2. Click on the **New** button.
3. In the **Tag Name** field type an appropriate Tagged Value name.
4. In the **Description** field type the purpose of the Tagged Value, if required.
5. In the **Detail** field copy-and-paste or type the syntax of the predefined structured Tagged Value Type.

In the example above (which is used in the definition of a field to enable a user to set a sports handicap) the predefined type is **Spin**, with the Upper and Lower Bounds set for the field values. (*Spin* is the Microsoft term for selection arrows in a variable field - the user clicks on the arrows to increase or decrease the value between the upper and lower bound limits.)

- Click on the **Save** button.

The Tagged Value type displays in the **Defined Tag Types** list.

#### 5.3.1.4.3 Predefined Reference Data Types

This table details the predefined Reference Data Tagged Value types that are used to return the values held in a relevant table in Enterprise Architect, along with the syntax required for their use. You use these to [create your own Reference Data Tagged Values](#)<sup>[1170]</sup>.

Tagged Value Type	Format	Drop-Down List Returned
Authors	<b>Type=Enum; List=Authors;</b>	Authors that have been defined for the Enterprise Architect model.
Cardinality	<b>Type=Enum; List=Cardinality;</b>	Cardinality types that have been defined for the Enterprise Architect model.
Clients	<b>Type=Enum; List=Clients;</b>	Clients that have been defined for the Enterprise Architect model.
ComplexityTypes	<b>Type=Enum; List=ComplexityTypes;</b>	Complexity types that have been defined for the Enterprise Architect model.  Whilst complexity types can be exported and imported as project <a href="#">reference data</a> <sup>[644]</sup> , they cannot be updated and so are effectively standard across all projects.
ConstraintTypes	<b>Type=Enum; List=ConstraintTypes;</b>	Constraint types that have been defined for the Enterprise Architect model.
EffortTypes	<b>Type=Enum; List=EffortTypes;</b>	Effort types that have been defined for the Enterprise Architect model.
MaintenanceTypes	<b>Type=Enum; List=MaintenanceTypes ;</b>	Maintenance types that have been defined for the Enterprise Architect model.
ObjectTypes	<b>Type=Enum; List=ObjectTypes;</b>	Object types that have been defined for the Enterprise Architect model.
Phases	<b>Type=Enum; List=Phases;</b>	Phases that have been defined for the Enterprise Architect model.
ProblemTypes	<b>Type=Enum; List=ProblemTypes;</b>	Problem types that have been defined for the Enterprise Architect model.
RoleTypes	<b>Type=Enum; List=RoleTypes;</b>	Role types that have been defined for the Enterprise Architect model.
RequirementTypes	<b>Type=Enum; List=RequirementTypes ;</b>	Requirement types that have been defined for the Enterprise Architect model.
Resources	<b>Type=Enum; List=Resources;</b>	Resources that have been defined for the Enterprise Architect model.
RiskTypes	<b>Type=Enum; List=RiskTypes;</b>	Risk types that have been defined for the Enterprise Architect model.

Tagged Value Type	Format	Drop-Down List Returned
RTFTemplates	Type=Enum; List=RTFTemplates;	RTF Templates that have been defined for the Enterprise Architect model.
ScenarioTypes	Type=Enum; List=ScenarioTypes;	Scenario types that have been defined for the Enterprise Architect model.
TestTypes	Type=Enum; List=TestTypes;	Test types that have been defined for the Enterprise Architect model.

#### 5.3.1.4.4 Create Reference Data Tagged Values

To create your own Tagged Value based on a [predefined Reference Data Tagged Value Type](#)<sup>[1169]</sup>, follow the steps below:

1. Select the **Settings | UML** menu option. The **UML Types** dialog displays; select the **Tagged Value Types** tab.

The screenshot shows the 'UML Types' dialog with the 'Tagged Value Types' tab selected. The 'Tag Name' field contains 'Author' and the 'Description' field contains 'Returns Authors of the Model'. The 'Detail' field contains the following text: 'Type=Enum; Type=List; List=Authors;'. Below the detail field are three buttons: 'New', 'Save', and 'Delete'. At the bottom, there is a table titled 'Defined Tag Types' with two columns: 'Type' and 'Description'. The table contains the following entries:

Type	Description
Activity	
Assignments	Assignments
Author	Returns Authors of the Model
Categories	Categories
Datafield	Database field

2. In the **Tag** field type an appropriate Tagged Value name.
3. In the **Description** field type a description of the purpose of the Tagged Value, if required.
4. In the **Detail** field copy-and-paste or type the syntax of the predefined Reference Data Tagged Value Type. In the example above, the Tagged Value returns the values for all of the Authors in the Enterprise Architect model.

This enables you to assign any of the previously defined Authors to a model feature (model features that can have Tagged Values applied to them are detailed in the [Model Elements and Features with Tagged Values](#)<sup>[633]</sup> topic.

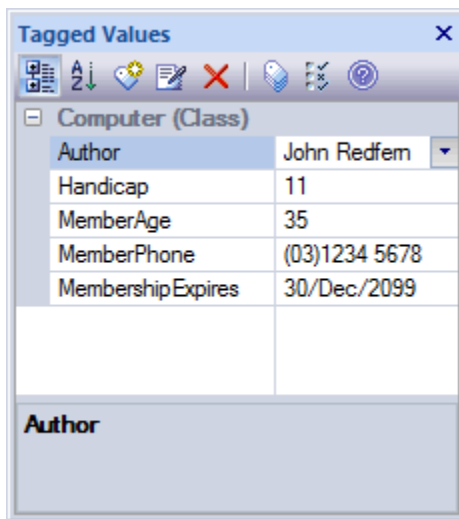
**Note:**

If the values in the reference data are changed after the Tagged Value Type is created, Enterprise Architect must be reloaded in order to reflect the changes in the Tagged Value Type.

#### 5.3.1.4.5 Create Custom Tagged Value Type

Custom masked Tagged Values give you great flexibility in designing model components that accept data entries.

To create a masked Tagged Value follow the steps below:

1. Select the **Settings | UML** menu option. The **UML Types** dialog displays; select the **Tagged Value Types** tab.
2. In the **Tag** field type an appropriate name for the Tagged Value.
3. In the **Description** field type the purpose of the Tagged Value, if required.
4. In the **Detail** field type **Type=Custom**;

The type **Custom** enables you to set up the appropriate mask, using the following characters to define the format of the mask:

Mask	Description
<b>D</b>	Enables the Tagged Value to display digits only.
<b>d</b>	Enables the Tagged Value to display digits or spaces.
<b>+</b>	Enables the use of <b>+</b> , <b>-</b> or <i>spaces</i> .
<b>C</b>	Enables the use of alpha characters only.
<b>c</b>	Enables the Tagged Value to be an alpha character or a space.
<b>A</b>	Enables the use of alphanumeric characters.
<b>a</b>	Enables the Tagged Value to use alphanumeric values or a space.

In the diagram below the **Mask** configuration option shows syntax that first defines seven blank spaces, which are occupied by characters determined by the template option. The first two visible characters in the **Mask** option are represented by a lower case **c** indicating that the enableable information can entered as either an alpha character or as a space. The following blank spaces again indicate space defined by the template option and the remaining characters are defined by the **d** character, which represents the enableable characters as digits or spaces. The hyphen is present in the final output, splitting up the digits.

With the **Template** configuration option, the syntax defines the template of the masked option by occupying the blank spaces that are present in the **Mask** option. The template is used to ensure that this information is

present with every use of this custom Tagged Value. The underscored values indicate the area that is to be occupied by data input by the user as defined in the **Mask** option.

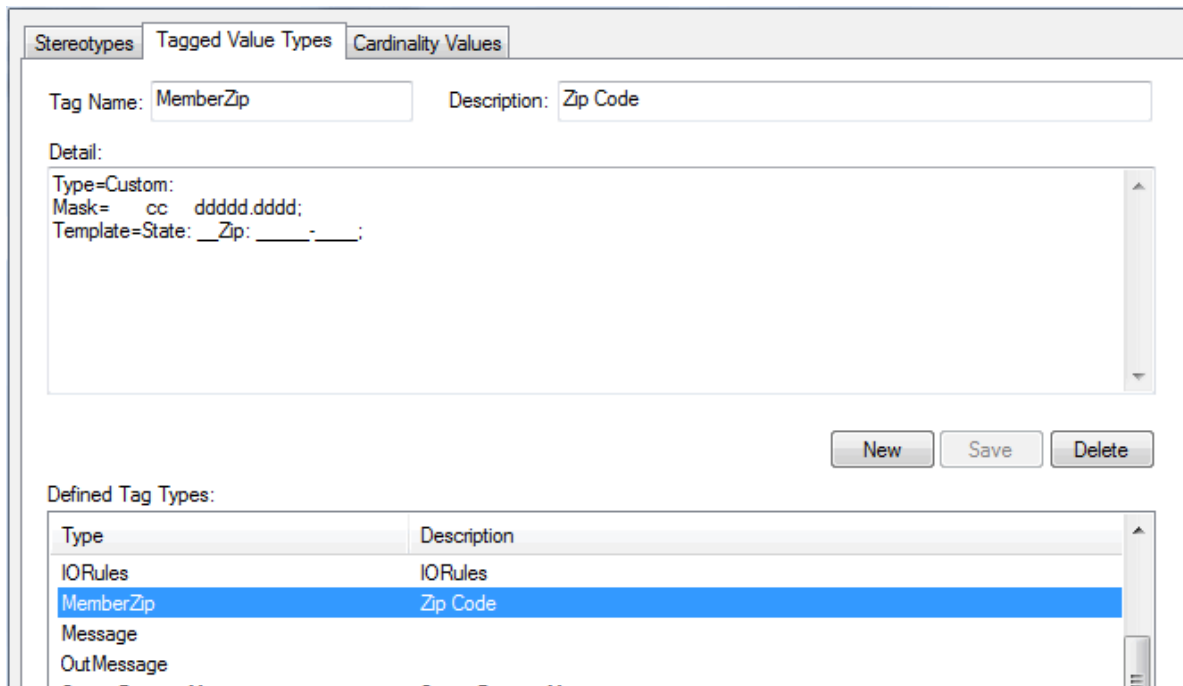

### 5.3.1.5 Code Template Framework

The Code Template Framework (CTF) is used during forward engineering of UML models. This section discusses how you customize the way in which Enterprise Architect generates source code, using the [Code Template Editor](#).<sup>[1202]</sup>

Enterprise Architect's code templates specify the transformation from UML elements to the various parts of a given programming language. The templates are written as plain text with a [syntax](#)<sup>[1172]</sup> that shares some aspects of both mark-up languages and scripting languages. The Base Templates provided in Enterprise Architect are described in the [Base Templates](#)<sup>[1302]</sup> topic.

#### 5.3.1.5.1 Code Template Syntax

Code Templates are written as plain text, using Enterprise Architect's code template editor (see [The Code Template Editor](#)<sup>[1202]</sup>). The template syntax centers on three basic constructs:

- [Literal Text](#)<sup>[1172]</sup>
- [Macros](#)<sup>[1173]</sup>
- [Variables](#)<sup>[1200]</sup>

Templates can contain any or all of these constructs.

##### 5.3.1.5.1.1 Literal Text

All text within a given template that is not part of a macro or a variable definition/reference, is considered literal text. With the exception of blank lines, which are ignored, literal text is directly substituted from the template into the generated code.

Consider the following excerpt from the java Class Declaration template:

```
%PI=" "%
%CONVERT_SCOPE(classScope)%

%classStereotype=="static" ? "static": ""%
%classStereotype=="final" ? "final": ""%
%classStereotype=="static final" ? "static final": ""%
%classAbstract=="T" ? "abstract": ""%
%PI=""%
class %className%$bases
```



On the final line, the word *class*, including the subsequent space, would be treated as literal text and thus reproduced in the output. The blank line following the *CONVERT\_SCOPE* macro, however, would have no effect on the output.

The %, \$ and " characters have special meaning in the template syntax and cannot always be used as literal text. If these characters must be generated from within the templates, they can be safely reproduced using the following direct substitution macros:

Macro	Use to
<code>%d!</code>	Produce a literal \$ character.
<code>%pc</code>	Produce a literal % character.
<code>%qt</code>	Produce a literal " character.

### 5.3.1.5.1.2 Macros

Macros provide access to element fields within the UML model and are also used to structure the generated output. All macros are enclosed within percent (%) signs. The CTF contains six basic types of macros:

- [Template substitution macros](#) <sup>[1173]</sup>
- [Field substitution macros](#) <sup>[1174]</sup>
- [Tagged Value substitution macros](#) <sup>[1186]</sup>
- [Control macros](#) <sup>[1190]</sup>
- [Function macros](#) <sup>[1187]</sup>
- [EASL code generation macros](#) <sup>[1193]</sup>

In general, macros (including the % delimiters) are substituted with literal text in the output. For example consider the following item from the *Class Declaration* template:

```
... class %className% ...
```

The field substitution macro, `%className%`, would result in the current Class name being substituted in the output. So if the Class being generated was named *Foo*, the output would be:

```
... class Foo ...
```

*Template substitution* macros correspond to [Base templates](#) <sup>[1302]</sup>. These macros result in the execution of the named template. By convention, template macros are named according to Pascal casing.

*Structure:* `%<TemplateName>%`

where `<TemplateName>` can be one of the templates listed below.

When a template is referenced from within another template, it is generated with respect to the elements currently in scope. The specific template is selected based on the stereotypes of the elements in scope.

As noted previously, there is an implicit hierarchy among the various templates. Some care should be taken in order to preserve a sensible hierarchy of template references. For example, it does not make sense to use the `%ClassInherits%` macro within any of the attribute or operation templates. Conversely, the *Operation* and *Attribute* templates are designed for use within the *ClassBody* template.

The CTF contains the following template substitution macros:

- AttributeDeclaration
- AttributeNotes
- Attribute
- Class
- ClassImpl
- ClassBase
- ClassBody
- ClassBodyImpl
- ClassParameter
- File
- FileImpl
- ImportSection
- ImportSectionImpl
- InnerClass
- InnerClassImpl
- LinkedAttribute
- NamespaceBody
- NamespaceDeclaration
- NamespaceImpl
- Operation
- OperationBody
- OperationBodyImpl
- OperationDeclaration
- OperationDeclarationImpl

- ClassDeclaration
- ClassDeclarationImpl
- ClassInherits
- ClassInterface
- ClassNotes
- LinkedAttributeNotes
- LinkedAttributeDeclaration
- LinkedClassBase
- LinkedClassInterface
- Namespace
- OperationImpl
- OperationNotes
- Parameter

The *field substitution* macros provide access to data in the model. In particular, they are used to access data fields from:

- Packages
- Classes
- Attributes
- Operations
- Parameters.

Field substitution macros are named according to Camel casing. By convention, the macro is prefixed with an abbreviated form of the corresponding model element. For example, attribute-related macros begin with **att**, as in the `%attName%` macro, to access the name of the attribute in scope.

The following table lists each of the field substitution macros with a description of the result.

**Note:**

Macros that represent checkboxes return a value of **T** if the box is selected. Otherwise the value is empty.

Macro Name	Description
attAlias	<b>Attributes</b> dialog: <b>Alias</b> .
attAllowDuplicates	<b>Attributes Detail</b> dialog: <b>Allow Duplicates</b> checkbox.
attClassifierGUID	The unique GUID for the classifier of the current attribute.
attCollection	<b>Attributes Detail</b> dialog: <b>Attribute is a Collection</b> checkbox.
attConst	<b>Attributes</b> dialog: <b>Const</b> checkbox.
attContainerType	<b>Attributes Detail</b> dialog: <b>Container Type</b> .
attContainment	<b>Attributes</b> dialog: <b>Containment</b> .
attDerived	<b>Attributes</b> dialog: <b>Derived</b> checkbox.
attGUID	The unique GUID for the current attribute.
attInitial	<b>Attributes</b> dialog: <b>Initial</b> .
attIsEnumLiteral	<b>Attributes</b> dialog: <b>Is Literal</b> checkbox.
attLength	<b>Column</b> dialog: <b>Length</b> .
attLowerBound	<b>Attributes Detail</b> dialog: <b>Lower Bound</b> .
attName	<b>Attributes</b> dialog: <b>Name</b> .
attNotes	<b>Attributes</b> dialog: <b>Notes</b> .
attOrderedMultiplicity	<b>Attributes Detail</b> dialog: <b>Ordered Multiplicity</b> checkbox.
attProperty	<b>Attributes</b> dialog: <b>Property</b> checkbox.
attQualType	The attribute type qualified by the namespace path (if generating namespaces) and the classifier path (dot delimited). If the attribute

Macro Name	Description
	classifier has not been set, is equivalent to the <i>attType</i> macro.
attScope	<b>Attributes</b> dialog: <b>Scope</b> .
attStatic	<b>Attributes</b> dialog: <b>Static</b> checkbox.
attStereotype	<b>Attributes</b> dialog: <b>Stereotype</b> .
attType	<b>Attributes</b> dialog: <b>Type</b> .
attUpperBound	<b>Attributes Detail</b> dialog: <b>Upper Bound</b> .
attVolatile	<b>Attributes Detail</b> dialog: <b>Transient</b> checkbox.
classAbstract	<b>Class</b> dialog: <b>Abstract</b> checkbox.
classAlias	<b>Class</b> dialog: <b>Alias</b> .
classArguments	<b>Class Detail</b> dialog: <b>C++ Templates: Arguments</b> .
classAuthor	<b>Class</b> dialog: <b>Author</b> .
classBaseName	<b>Type Hierarchy</b> dialog: <b>Class Name</b> (for use where no connector exists between child and base Classes).
classBaseScope	The scope of the inheritance as reverse engineered. (For use where no connector exists between child and base Classes.)
classBaseVirtual	The virtual property of the inheritance as reverse engineered. (For use where no connector exists between child and base Classes.)
classComplexity	<b>Class</b> dialog: <b>Complexity</b> .
classCreated	The date and time the Class was created.
classGUID	The unique GUID for the current Class.
classHasConstructor	Looks at the list of methods in the current object and, depending on the conventions of the current language, returns <b>T</b> if one is a default constructor. Typically used with the <a href="#">genOptGenConstructor</a> <sup>[1180]</sup> macro.
classHasCopyConstructor	Looks at the list of methods in the current object and, depending on the conventions of the current language, returns <b>T</b> if one is a copy constructor. Typically used with the <a href="#">genOptGenCopyConstructor</a> <sup>[1180]</sup> macro.
classHasDestructor	Looks at the list of methods in the current object and, depending on the conventions of the current language, returns <b>T</b> if one is a destructor. Typically used with the <a href="#">genOptGenDestructor</a> <sup>[1180]</sup> macro.
classHasParent	<b>True</b> , if the Class in scope has one or more base Classes.
classImports	<b>Code Gen</b> dialog: <b>Imports</b> .
classIsActive	<b>Class Advanced</b> dialog: <b>Is Active</b> checkbox.
classIsInstantiated	<b>True</b> , if the Class is an instantiated template Class.
classIsLeaf	<b>Class Advanced</b> dialog: <b>Is Leaf</b> checkbox.
classIsRoot	<b>Class Advanced</b> dialog: <b>Is Root</b> checkbox.
classIsSpecification	<b>Class Advanced</b> dialog: <b>Is Specification</b> checkbox.

Macro Name	Description
classKeywords	Class dialog: <b>Keywords</b> .
classLanguage	Class dialog: <b>Language</b> .
classMacros	A space separated list of macros defined for the Class.
classModified	The date and time the Class was last modified.
classMultiplicity	Class <b>Advanced</b> dialog: <b>Multiplicity</b> .
className	Class dialog: <b>Name</b> .
classNotes	Class dialog: <b>Note</b> .
classParamDefault	Class <b>Detail</b> dialog.
classParamName	Class <b>Detail</b> dialog.
classParamType	Class <b>Detail</b> dialog.
classPersistence	Class dialog: <b>Persistence</b> .
classPhase	Class dialog: <b>Phase</b> .
classQualName	The Class name prefixed by its outer Classes. Class names are separated by double colons (::).
classScope	Class dialog: <b>Scope</b> .
classStereotype	Class dialog: <b>Stereotype</b> .
classStatus	Class dialog: <b>Status</b> .
classVersion	Class dialog: <b>Version</b> .
connectorAlias	Connector <b>Properties</b> dialog: <b>Alias</b> .
connectorDestAccess	Connector <b>Properties</b> dialog, <b>Target Role</b> tab: <b>Access</b> .
connectorDestAggregation	Connector <b>Properties</b> dialog, <b>Target Role</b> tab: <b>Aggregation</b> .
connectorDestAlias	Connector <b>Properties</b> dialog, <b>Target Role</b> tab: <b>Alias</b> .
connectorDestAllowDuplicates	Connector <b>Properties</b> dialog, <b>Target Role</b> tab: <b>Allow Duplicates</b> checkbox.
connectorDestChangeable	Connector <b>Properties</b> dialog, <b>Target Role</b> tab: <b>Changeable</b> .
connectorDestConstraint	Connector <b>Properties</b> dialog, <b>Target Role</b> tab: <b>Constraint(s)</b> .
connectorDestContainment	Connector <b>Properties</b> dialog, <b>Target Role</b> tab: <b>Containment</b> .
connectorDestDerived	Connector <b>Properties</b> dialog, <b>Target Role</b> tab: <b>Derived</b> checkbox.
connectorDestDerivedUnion	Connector <b>Properties</b> dialog, <b>Target Role</b> tab: <b>DerivedUnion</b> checkbox.
connectorDestElem*	A set of macros that access a property of the element at the target end of a connector. The * (asterisk) is a wildcard that corresponds to any class substitution macro in this list; for example: <i>connectorDestElemAlias</i> ( <i>classAlias</i> ), <i>connectorDestElemAuthor</i> ( <i>classAuthor</i> ).
connectorDestElemType	The element type of the connector destination element. (Separate from the <i>connectorDestElem*</i> macros because there is no <i>classType</i>

Macro Name	Description
	substitution macro.)
connectorDestMemberType	Connector <b>Properties</b> dialog, <b>Target Role</b> tab: <b>Member Type</b> .
connectorDestMultiplicity	Connector <b>Properties</b> dialog, <b>Target Role</b> tab: <b>Multiplicity</b> .
connectorDestNavigability	Connector <b>Properties</b> dialog, <b>Target Role</b> tab: <b>Navigability</b> .
connectorDestNotes	Connector <b>Properties</b> dialog, <b>Target Role</b> tab: <b>Role Notes</b> .
connectorDestOrdered	Connector <b>Properties</b> dialog, <b>Target Role</b> tab: <b>Ordered</b> checkbox.
connectorDestOwned	Connector <b>Properties</b> dialog, <b>Target Role</b> tab: <b>Owned</b> checkbox.
connectorDestQualifier	Connector <b>Properties</b> dialog, <b>Target Role</b> tab: <b>Qualifier(s)</b> .
connectorDestRole	Connector <b>Properties</b> dialog, <b>Target Role</b> tab: <b>Role</b> .
connectorDestScope	Connector <b>Properties</b> dialog, <b>Target Role</b> tab: <b>Target Scope</b> .
connectorDestStereotype	Connector <b>Properties</b> dialog, <b>Target Role</b> tab: <b>Stereotype</b> .
connectorDirection	Connector <b>Properties</b> : <b>Direction</b> .
connectorEffect	<b>Transition Constraints</b> dialog: <b>Effect</b> .
connectorGuard	<b>Object Flow</b> and <b>Transition Constraints</b> dialog: <b>Guard</b> .
connectorGUID	The unique GUID for the current connector.
connectorName	Connector <b>Properties</b> : <b>Name</b> .
connectorNotes	Connector <b>Properties</b> : <b>Notes</b> .
connectorSourceAccess	Connector <b>Properties</b> dialog, <b>Source Role</b> tab: <b>Access</b> .
connectorSourceAggregation	Connector <b>Properties</b> dialog, <b>Source Role</b> tab: <b>Aggregation</b> .
connectorSourceAlias	Connector <b>Properties</b> dialog, <b>Source Role</b> tab: <b>Alias</b> .
connectorSourceAllowDuplicates	Connector <b>Properties</b> dialog, <b>Source Role</b> tab: <b>Allow Duplicates</b> checkbox.
connectorSourceChangeable	Connector <b>Properties</b> dialog, <b>Source Role</b> tab: <b>Changeable</b> .
connectorSourceConstraint	Connector <b>Properties</b> dialog, <b>Source Role</b> tab: <b>Constraint(s)</b> .
connectorSourceContainment	Connector <b>Properties</b> dialog, <b>Source Role</b> tab: <b>Containment</b> .
connectorSourceDerived	Connector <b>Properties</b> dialog, <b>Source Role</b> tab: <b>Derived</b> checkbox.
connectorSourceDerivedUnion	Connector <b>Properties</b> dialog, <b>Source Role</b> tab: <b>DerivedUnion</b> checkbox.
connectorSourceElem*	A set of macros that access a property of the element at the source end of a connector. The * (asterisk) is a wildcard that corresponds to any class substitution macro in this list; for example: <i>connectorSourceElemAlias (classAlias)</i> , <i>connectorSourceElemAuthor (classAuthor)</i> .
connectorSourceElemType	The element type of the connector source element. (Separate from the <i>connectorSourceElem*</i> macros because there is no <i>classType</i> substitution macro.)

Macro Name	Description
connectorSourceMemberType	Connector <b>Properties</b> dialog, <b>Source Role</b> tab: <b>Member Type</b> .
connectorSourceMultiplicity	Connector <b>Properties</b> dialog, <b>Source Role</b> tab: <b>Multiplicity</b> .
connectorSourceNavigability	Connector <b>Properties</b> dialog, <b>Source Role</b> tab: <b>Navigability</b> .
connectorSourceNotes	Connector <b>Properties</b> dialog, <b>Source Role</b> tab: <b>Role Notes</b> .
connectorSourceOrdered	Connector <b>Properties</b> dialog, <b>Source Role</b> tab: <b>Ordered</b> checkbox.
connectorSourceOwned	Connector <b>Properties</b> dialog, <b>Source Role</b> tab: <b>Owned</b> checkbox.
connectorSourceQualifier	Connector <b>Properties</b> dialog, <b>Source Role</b> tab: <b>Qualifier(s)</b> .
connectorSourceRole	Connector <b>Properties</b> dialog, <b>Source Role</b> tab: <b>Role</b> .
connectorSourceScope	Connector <b>Properties</b> dialog, <b>Source Role</b> tab: <b>Target Scope</b> .
connectorSourceStereotype	Connector <b>Properties</b> dialog, <b>Source Role</b> tab: <b>Stereotype</b> .
connectorStereotype	Connector <b>Properties</b> dialog: <b>Stereotype</b> .
connectorTrigger	<b>Transition Constraints</b> dialog: <b>Trigger</b> .
connectorType	The connector type; for example, Association or Generalization.
connectorWeight	<b>Object Flow Constraints</b> dialog: <b>Weight</b> .
constraintName	<b>Class</b> dialog, <b>Constraints</b> tab: <b>Name</b> .
constraintNotes	<b>Class</b> dialog, <b>Constraints</b> tab: <b>Notes</b> .
constraintStatus	<b>Class</b> dialog, <b>Constraints</b> tab: <b>Status</b> .
constraintType	<b>Class</b> dialog, <b>Constraints</b> tab: <b>Type</b> .
constraintWeight	<b>Class</b> dialog, <b>Constraints</b> tab: ordering (hand up/down) keys.
eaDateTime	The current time with format: <i>DD-MMM-YYYY HH:MM:SS AM/PM</i> .
eaGUID	A unique GUID for this generation.
eaVersion	Program Version (Located in an Enterprise Architect dialog by selecting <b>Help   About EA</b> ).
effortName	<b>Project Management</b> window: <b>Effort</b> .
effortNotes	<b>Project Management</b> window: <b>Notes</b> (unlabelled).
effortTime	<b>Project Management</b> window: <b>Time</b> .
effortType	<b>Project Management</b> window: <b>Type</b> .
elemType	The element type: Interface or Class.
fileExtension	The file type extension of the file being generated.
fileName	The name of the file being generated.
fileNameImpl	The filename of the implementation file for this generation, if applicable.
fileHeaders	<b>Code Gen</b> dialog: <b>Headers</b> .
fileImports	<b>Code Gen</b> dialog: <b>Imports</b> . For supported languages this also includes

Macro Name	Description
	dependencies derived from associations.
filePath	The full path of the file being generated.
filePathImpl	The full path of the implementation file for this generation, if applicable.
genOptActionScriptVersion	<b>ActionScript Specifications</b> dialog: <b>Default Version</b> .
genOptCDefaultAttributeType	<b>C Specifications</b> dialog: <b>Default Attribute Type</b> .
genOptCGenMethodNotesInBody	<b>C Specifications</b> dialog: <b>Method Notes In Implementation</b> .
genOptCGenMethodNotesInHeader	<b>C Specifications</b> dialog: <b>Method Notes In Header</b> .
genOptCSynchNotes	<b>C Specifications</b> dialog: <b>Synchronize Notes in Generation</b> .
genOptCSynchCFile	<b>C Specifications</b> dialog: <b>Synchronise Implementation file in Generation</b> .
genOptCDefaultSourceDirectory	<b>C Specifications</b> dialog: <b>Default Source Directory</b> .
genOptCNamespaceDelimiter	<b>C Specifications</b> dialog: <b>Namespace Delimiter</b> .
genOptCOperationRefParam	<b>C Specifications</b> dialog: <b>Reference as Operation Parameter</b> .
genOptCOperationRefParamStyle	<b>C Specifications</b> dialog: <b>Reference Parameter Style</b> .
genOptCOperationRefParamName	<b>C Specifications</b> dialog: <b>Reference Parameter Name</b> .
genOptCConstructorName	<b>C Specifications</b> dialog: <b>Default Constructor Name</b> .
genOptCDestructorName	<b>C Specifications</b> dialog: <b>Default Destructor Name</b> .
genOptCPPCommentStyle	<b>C++ Specifications</b> dialog: <b>Comment Style</b> .
genOptCPPDefaultAttributeType	<b>C++ Specifications</b> dialog: <b>Default Attribute Type</b> .
genOptCPPDefaultReferenceType	<b>C++ Specifications</b> dialog: <b>Default Reference Type</b> .
genOptCPPDefaultSourceDirectory	<b>C++ Specifications</b> dialog: <b>Default Source Directory</b> .
genOptCPPGenMethodNotesInHeader	<b>C++ Specifications</b> dialog: <b>Method Notes In Header</b> checkbox.
genOptCPPGenMethodNotesInBody	<b>C++ Specifications</b> dialog: <b>Method Notes In Body</b> checkbox.
genOptCPPGetPrefix	<b>C++ Specifications</b> dialog: <b>Get Prefix</b> .
genOptCPPHeaderExtension	<b>C++ Specifications</b> dialog: <b>Header Extension</b> .
genOptCPPSetPrefix	<b>C++ Specifications</b> dialog: <b>Set Prefix</b> .
genOptCPPSourceExtension	<b>C++ Specifications</b> dialog: <b>Source Extension</b> .
genOptCPPSynchCPPFile	<b>C++ Specifications</b> dialog: <b>Synchronize Notes</b> .
genOptCPPSynchNotes	<b>C++ Specifications</b> dialog: <b>Synchronize CPP File</b> .
genOptCSharpDefaultAttributeType	<b>C# Specifications</b> dialog: <b>Default Attribute Type</b> .

Macro Name	Description
genOptCSSourceExtension	C# Specifications dialog: <b>Default file extension.</b>
genOptCSGenDispose	C# Specifications dialog: <b>Generate Dispose.</b>
genOptCSGenFinalizer	C# Specifications dialog: <b>Generate Finalizer.</b>
genOptCSGenNamespace	C# Specifications dialog: <b>Generate Namespace.</b>
genOptCSDefaultSourceDirectory	C# Specifications dialog: <b>Default Source Directory.</b>
genOptDefaultAssocAttName	Attribute Specifications dialog: <b>Default name for associated attrib.</b>
genOptDefaultConstructorScope	Object Lifetimes dialog: <b>Default Constructor Visibility.</b>
genOptDefaultCopyConstructorScope	Object Lifetimes dialog: <b>Default Copy Constructor Visibility.</b>
genOptDefaultDatabase	Code Editors dialog: <b>Default Database.</b>
genOptDefaultDestructorScope	Object Lifetimes dialog: <b>Default Destructor Constructor Visibility.</b>
genOptGenCapitalisedProperties	Source Code Engineering dialog: <b>Capitalize Attribute Names for Properties</b> checkbox.
genOptGenComments	Source Code Engineering dialog: <b>Generate Comments</b> checkbox.
genOptGenConstructor	Object Lifetimes dialog: <b>Generate Constructor</b> checkbox.
genOptGenConstructorInline	Object Lifetimes dialog: <b>Constructor Inline</b> checkbox.
genOptGenCopyConstructor	Object Lifetimes dialog: <b>Generate Copy Constructor</b> checkbox.
genOptGenCopyConstructorInline	Object Lifetimes dialog: <b>Copy Constructor Inline</b> checkbox.
genOptGenDestructor	Object Lifetimes dialog: <b>Generate Destructor</b> checkbox.
genOptGenDestructorInline	Object Lifetimes dialog: <b>Destructor Inline</b> checkbox.
genOptGenDestructorVirtual	Object Lifetimes dialog: <b>Virtual Destructor</b> checkbox.
genOptGenImplementedInterfaceOps	Attribute/Operations Specifications dialog: <b>Generate methods for implemented interfaces</b> checkbox.
genOptGenPrefixBoolProperties	Source Code Engineering dialog: <b>Use is prefix for boolean property Get().</b>
genOptGenRoleNames	Source Code Engineering dialog: <b>Autogenerate role names when creating code.</b>
genOptGenUnspecAssocDir	Source Code Engineering dialog: <b>Do not generate members where Association direction is unspecified</b> checkbox.
genOptJavaDefaultAttributeType	Java Specifications dialog: <b>Default attribute type.</b>
genOptJavaGetPrefix	Java Specifications dialog: <b>Get Prefix.</b>
genOptJavaDefaultSourceDirectory	Java Specifications dialog: <b>Default Source Directory.</b>
genOptJavaSetPrefix	Java Specifications dialog: <b>Set Prefix.</b>
genOptJavaSourceExtension	Java Specifications dialog: <b>Source code extension.</b>
genOptPHPDefaultSourceDirectory	PHP Specifications dialog: <b>Default Source Directory.</b>



Macro Name	Description
y	
genOptPHPGetPrefix	PHP Specifications dialog: <b>Get Prefix</b> .
genOptPHPSetPrefix	PHP Specifications dialog: <b>Set Prefix</b> .
genOptPHPSourceExtension	PHP Specifications dialog: <b>Default file extension</b> .
genOptPHPVersion	PHP Specifications dialog: <b>PHP Version</b> .
genOptPropertyPrefix	Source Code Engineering dialog: <b>Remove prefixes when generating Get/Set properties</b> .
genOptVBMultiUse	VB Specifications dialog: <b>Multiuse</b> checkbox.
genOptVBPersistable	VB Specifications dialog: <b>Persistable</b> checkbox.
genOptVBDataBindingBehavior	VB Specifications dialog: <b>Data binding behavior</b> checkbox.
genOptVBDataSourceBehavior	VB Specifications dialog: <b>Data source behavior</b> checkbox.
genOptVBGlobal	VB Specifications dialog: <b>Global namespace</b> checkbox.
genOptVBCreatable	VB Specifications dialog: <b>Creatable</b> checkbox.
genOptVBExposed	VB Specifications dialog: <b>Exposed</b> checkbox.
genOptVBMTS	VB Specifications dialog: <b>MTS Transaction Mode</b> .
genOptVBNetGenNamespace	VB.Net Specifications dialog: <b>Generate Namespace</b> .
genOptVBVersion	VB Specifications dialog: <b>Default Version</b> .
genOptWrapComment	Source Code Engineering dialog: <b>Wrap length for comment lines</b> .
importClassName	The name of the Class being imported.
importFileName	The filename of the Class being imported.
importFilePath	The full path of the Class being imported.
importFromAggregation	<b>T</b> if the Class has an Aggregation connector to a Class in this file, <b>F</b> otherwise.
importFromAssociation	<b>T</b> if the Class has an Association connector to a Class in this file, <b>F</b> otherwise.
importFromAtt	<b>T</b> if an attribute of a Class in the current file is of the type of this Class, <b>F</b> otherwise.
importFromDependency	<b>T</b> if the Class has a Dependency connector to a Class in this file, <b>F</b> otherwise.
importFromGeneralization	<b>T</b> if the Class has a Generalization connector to a Class in this file, <b>F</b> otherwise.
importFromMeth	<b>T</b> if a method return type of a Class in the current file is the type of this Class, <b>F</b> otherwise.
importFromParam	<b>T</b> if a method parameter of a Class in the current file is of the type of this Class, <b>F</b> otherwise.
importFromRealization	<b>T</b> if the Class has a Realization connector to a Class in this file, <b>F</b> otherwise.

Macro Name	Description
importInFile	<b>T</b> if the Class is in the current file, <b>F</b> otherwise.
importPackagePath	The package path with a '.' separator of the Class being imported.
ImportRelativeFilePath	The relative file path of the Class being imported from the file path of the file being generated.
linkAttAccess	Association Properties Target Role dialog: <b>Access</b> .
linkAttCollectionClass	The collection appropriate for the linked attribute in scope.
linkAttContainment	Association Properties Target Role dialog: <b>Containment</b> .
linkAttName	Association Properties dialog: <b>Target</b> .
linkAttNotes	Association Properties Target Role dialog: <b>Role Notes</b> .
linkAttQualName	The Association target qualified by the namespace path (if generating namespaces) and the classifier path (dot delimited).
linkAttRole	Association Properties Target Role dialog: <b>Role</b> .
linkAttStereotype	Association Properties Target Role dialog: <b>Stereotype</b> .
linkAttTargetScope	Association Properties Target Role dialog: <b>Target Scope</b> .
linkCard	Link Properties Target Role dialog: <b>Multiplicity</b> .
linkedFileLastWrite	Class Properties dialog: <b>Last Write</b> .
linkedFileNotes	Class Properties dialog: <b>Notes</b> .
linkedFilePath	Class Properties dialog: <b>File Path</b> .
linkedFileSize	Class Properties dialog: <b>Size</b> .
linkedFileType	Class Properties dialog: <b>Type</b> .
linkGUID	The unique GUID for the current connector.
linkParentName	Generalization Properties dialog: <b>Target</b> .
linkParentQualName	The Generalization target qualified by the namespace path (if generating namespaces) and the classifier path (dot delimited).
linkStereotype	The stereotype of the current connector.
linkVirtualInheritance	Generalization Properties dialog: <b>Virtual Inheritance</b> .
metricName	Project Management dialog, Metrics tab: <b>Metric</b> field.
metricNotes	Project Management dialog, Metrics tab: (Notes) field.
metricType	Project Management dialog, Metrics tab: <b>Type</b> field.
metricWeight	Project Management dialog, Metrics tab: <b>Weight</b> field.
opAbstract	Operation dialog: <b>Virtual</b> checkbox.
opAlias	Operation dialog: <b>Alias</b> .
opBehavior	Operation Behavior dialog: <b>Behavior</b> .
opCode	Operation Behavior dialog: <b>Initial Code</b> .

Macro Name	Description
opConcurrency	<b>Operation</b> dialog: <b>Concurrency</b> .
opConst	<b>Operation</b> dialog: <b>Const</b> checkbox.
opGUID	The unique GUID for the current operation.
opImplMacros	A space-separated list of macros defined in the implementation of this operation.
opIsQuery	<b>Operation</b> dialog: <b>IsQuery</b> checkbox.
opMacros	A space-separated list of macros defined in the declaration for this operation.
opName	<b>Operation</b> dialog: <b>Name</b> .
opNotes	<b>Operation</b> dialog: <b>Notes</b> .
opPure	<b>Operation</b> dialog: <b>Pure</b> checkbox.
opReturnArray	<b>Operation</b> dialog: <b>Return Array</b> checkbox.
opReturnClassifierGUID	The unique GUID for the classifier of the current operation.
opReturnQualType	The operation return type qualified by the namespace path (if generating namespaces) and the classifier path (dot delimited). If the return type classifier has not been set, is equivalent to the <i>opReturn</i> macro.
opReturnType	<b>Operation</b> dialog: <b>Return Type</b> .
opScope	<b>Operation</b> dialog: <b>Scope</b> .
opStatic	<b>Operation</b> dialog: <b>Static</b> checkbox.
opStereotype	<b>Operation</b> dialog: <b>Stereotype</b> .
opSynchronized	<b>Operation</b> dialog: <b>Synchronized</b> checkbox.
packageAbstract	<b>Package</b> dialog: <b>Abstract</b> .
packageAlias	<b>Package</b> dialog: <b>Alias</b> .
packageAuthor	<b>Package</b> dialog: <b>Author</b> .
packageComplexity	<b>Package</b> dialog: <b>Complexity</b> .
packageGUID	The unique GUID for the current package.
packageKeywords	<b>Package</b> dialog: <b>Keywords</b> .
packageLanguage	<b>Package</b> dialog: <b>Language</b> .
packageName	<b>Package</b> dialog: <b>Name</b> .
packagePath	The string representing the hierarchy of packages, for the Class in scope. Each package name is separated by a dot (.).
packagePhase	<b>Package</b> dialog: <b>Phase</b> .
packageScope	<b>Package</b> dialog: <b>Scope</b> .
packageStatus	<b>Package</b> dialog: <b>Status</b> .

Macro Name	Description
packageStereotype	<b>Package</b> dialog: <b>Stereotype</b> .
packageVersion	<b>Package</b> dialog: <b>Version</b> .
paramClassifierGUID	The unique GUID for the classifier of the current parameter.
paramDefault	<b>Operation Parameters</b> dialog: <b>Default</b> .
paramFixed	<b>Operation Parameters</b> dialog: <b>Fixed</b> checkbox.
paramGUID	The unique GUID for the current parameter.
paramsEnum	<b>True</b> , if the parameter uses the <i>enum</i> keyword (C++).
paramKind	<b>Operation Parameters</b> dialog: <b>Kind</b> .
paramName	<b>Operation Parameters</b> dialog: <b>Name</b> .
paramNotes	<b>Operation Parameters</b> dialog: <b>Notes</b> .
paramQualType	The parameter type qualified by the namespace path (if generating namespaces) and the classifier path (dot delimited). If the parameter classifier has not been set, is equivalent to the <i>paramType</i> macro.
paramType	<b>Operation Parameters</b> dialog: <b>Type</b> .
problemCompletedBy	<b>Maintenance</b> dialog, <b>Element Issues</b> tab: <b>Completed by</b> .
problemCompletedDate	<b>Maintenance</b> dialog, <b>Element Issues</b> tab: <b>Completed</b> .
problemHistory	<b>Maintenance</b> dialog, <b>Element Issues</b> tab: <b>History</b> .
problemName	<b>Maintenance</b> dialog, <b>Element Issues</b> tab: <b>Name</b> .
problemNotes	<b>Maintenance</b> dialog, <b>Element Issues</b> tab: <b>Description</b> .
problemPriority	<b>Maintenance</b> dialog, <b>Element Issues</b> tab: <b>Priority</b> .
problemRaisedBy	<b>Maintenance</b> dialog, <b>Element Issues</b> tab: <b>Raised by</b> .
problemRaisedDate	<b>Maintenance</b> dialog, <b>Element Issues</b> tab: <b>Raised</b> .
problemStatus	<b>Maintenance</b> dialog, <b>Element Issues</b> tab: <b>Status</b> .
problemVersion	<b>Maintenance</b> dialog, <b>Element Issues</b> tab: <b>Version</b> .
requirementDifficulty	<b>Properties</b> dialog: <b>Require</b> tab: <b>Difficulty</b> .
requirementLastUpdated	<b>Properties</b> dialog: <b>Require</b> tab: <b>Last Update</b> .
requirementName	<b>Properties</b> dialog: <b>Require</b> tab: <b>Short Description</b> .
requirementNotes	<b>Properties</b> dialog: <b>Require</b> tab: <b>Notes</b> .
requirementPriority	<b>Properties</b> dialog: <b>Require</b> tab: <b>Priority</b> .
requirementStatus	<b>Properties</b> dialog: <b>Require</b> tab: <b>Status</b> .
requirementType	<b>Properties</b> dialog: <b>Require</b> tab: <b>Type</b> .
resourceAllocatedTime	<b>Project Management</b> window, <b>Resource Allocation</b> tab: <b>Allocated Time</b> .
resourceEndDate	<b>Project Management</b> window, <b>Resource Allocation</b> tab: <b>End Date</b> .

Macro Name	Description
resourceExpectedTime	Project Management window, Resource Allocation tab: <b>Expected Time</b> .
resourceExpendedTime	Project Management window, Resource Allocation tab: <b>Time Expended</b> .
resourceHistory	Project Management window, Resource Allocation tab: <b>History</b> .
resourceName	Project Management window, Resource Allocation tab: <b>Resource</b> .
resourceNotes	Project Management window, Resource Allocation tab: <b>Description</b> .
resourcePercentCompleted	Project Management window, Resource Allocation tab: <b>Completed(%)</b> .
resourceRole	Project Management window, Resource Allocation tab: <b>Role</b> .
resourceStartDate	Project Management window, Resource Allocation tab: <b>Start Date</b> .
riskName	Project Management window, Risks tab: <b>Risk</b> .
riskNotes	Project Management window, Risks tab: (Notes).
riskType	Project Management window, Risks tab: <b>Type</b> .
riskWeight	Project Management window, Risks tab: <b>Weight</b> .
scenarioGUID	The unique ID for a scenario. Identifies the scenario unambiguously within a model.
scenarioName	Properties dialog, Scenario tab: <b>Scenario</b> .
scenarioNotes	Properties dialog, Scenario tab: (Notes).
scenarioType	Properties dialog, Scenario tab: <b>Type</b> .
testAcceptanceCriteria	Testing window: <b>Acceptance Criteria</b> .
testCheckedBy	Testing window: <b>Checked By</b> .
testDateRun	Testing window: <b>Last Run</b> .
testClass	The Testing window tab (the type of test defined): <b>Unit, Integration, System, Acceptance, Scenario</b> .
testInput	Testing window: <b>Input</b> .
testName	Testing window: <b>Test</b> .
testNotes	Testing window: <b>Description</b> .
testResults	Testing window: <b>Results</b> .
testRunBy	Testing window: <b>Run By</b> .
testStatus	Testing window: <b>Status</b> .
testType	Testing window: <b>Type</b> .

Field substitution macros can be used in one of two ways:

### Use 1: Direct Substitution

This form directly substitutes the corresponding value of the element in scope into the output.

Structure: %<macroName>%

Where <macroName> can be any of the macros listed above.

### Examples:

- %className%
- %opName%
- %attName%

## Use 2: Conditional Substitution

This form of the macro enables alternative substitutions to be made depending on the macro's value.

Structure: %<macroName> [ == "<test>" ] ? <subTrue> [ : <subFalse> ]%

Where:

- [ <text> ] denotes that <text> is optional
- <test> is a string representing a possible value for the macro
- <subTrue> and <subFalse> can be a combination of quoted strings and the keyword value; where the value is used, it is replaced with the macro's value in the output.

### Examples:

- %classAbstract=="T" ? "pure" : ""%
- %opStereotype=="operator" ? "operator" : ""%
- %paramDefault != "" ? " = " value : ""%

The above three examples output nothing if the condition fails. In this case the false condition can be omitted, resulting in the following usage:

### Examples:

- %classAbstract=="T" ? "pure" %
- %opStereotype=="operator" ? "operator" %
- %paramDefault != "" ? " = " value %

The third example of both blocks shows a comparison checking for a non-empty value or existence. This test can also be omitted.

- %paramDefault ? " = " value : ""%
- %paramDefault ? " = " value %

All of the above examples containing paramDefault are equivalent. If the parameter in scope had a default value of **10**, the output from each of them would normally be:

= 10

### Note:

In a conditional substitution macro, any white space following <macroName> is ignored. If white space is required in the output, it should be included within the quoted substitution strings.

*Tagged Value* macros are a special form of field substitution macros, which provide access to element tags and the corresponding Tagged Values.

## Use 1: Direct Substitution

This form of the macro directly substitutes the value of the named tag into the output.

Structure: %<macroName>:"<tagName>"%

<macroName> can be one of:

- attTag
- classTag
- connectorDestElemTag
- connectorDestTag

- connectorSourceElemTag
- connectorSourceTag
- connectorTag
- linkAttTag
- linkTag
- opTag
- packageTag
- paramTag

This corresponds to the tags for attributes, Classes, operations, packages, parameters, connectors with both ends, elements at both ends of connectors and connectors including the attribute end.

`<tagName>` is a string representing the specific tag name.

#### Examples:

```
%opTag:"attribute"%
```

## Use 2: Conditional Substitution

This form of the macro mimics the conditional substitution defined for field substitution macros.

Structure: `%<macroName>:"<tagName>" [ == "<test>" ] ? <subTrue> [ : <subFalse> ]%`

Where:

- `<macroName>` and `<tagName>` are as defined above
- `[ <text> ]` denotes that `<text>` is optional
- `<test>` is a string representing a possible value for the macro
- `<subTrue>` and `<subFalse>` can be a combination of quoted strings and the keyword value. Where the value is used, it gets replaced with the macro's value in the output.

#### Examples:

```
%opTag:"opInline" ? "inline" : ""%
%opTag:"opInline" ? "inline"%
%classTag:"unsafe" == "true" ? "unsafe" : ""%
%classTag:"unsafe" == "true" ? "unsafe"%
```

Tagged Value macros use the same naming convention as field substitution macros.

*Function macros* are a convenient way of manipulating and formatting various element data. Each function macro returns a result string. There are two primary ways to use the results of function macros:

- Direct substitution of the returned string into the output, such as: `%TO_LOWER(attName)%`
- Storing the returned string as part of a variable definition such as: `$name = %TO_LOWER(attName)%`

Function macros can take parameters, which can be passed to the macros as:

- String literals, enclosed within double quotation marks
- Direct substitution macros without the enclosing percent signs
- Variable references
- Numeric literals.

Multiple parameters are passed using a comma-separated list.

The available function macros are described below. Parameters are denoted by angle brackets, as in: `FUNCTION_NAME(<param>)`.

#### Note:

Function macros are named according to the All-Caps style, as in: `%CONVERT_SCOPE(opScope)%`

### **CONVERT\_SCOPE(<umlScope>)**

For use with supported languages. Converts `<umlScope>` to the appropriate scope keyword for the language being generated. The following table shows the conversion of `<umlScope>` with respect to the given language.

Language	Package	Public	Private	Protected
C++	public	public	private	protected
C#	internal	public	private	protected
Delphi	protected	public	private	protected
Java		public	private	protected
PHP	public	public	private	protected
VB	Protected	Public	Private	Protected
VB .Net	Friend	Public	Private	Protected

**COLLECTION\_CLASS(<language>)**

Gives the appropriate collection Class for the language specified for the current linked attribute.

**CSTYLE\_COMMENT(<wrap\_length>)**

Converts the notes for the element currently in scope to plain C-style comments, using `/*` and `*/`.

**DELPHI\_PROPERTIES(<scope>, <separator>, <indent>)**

Generates a Delphi property.

**DELPHI\_COMMENT(<wrap\_length>)**

Converts the notes for the element currently in scope to Delphi comments.

**EXEC\_ADD\_IN(<addin\_name>, <function\_name>, <prm\_1>, ..., <prm\_n>)**

Invokes an Enterprise Architect Add-In function, which can return a result string. `<addin_name>` and `<function_name>` specify the names of the Add-In and function to be invoked. Parameters to the Add-In function can be specified via parameters `<prm_1>` to `<prm_n>`. For example:

```
$result = %EXEC_ADD_IN("MyAddin","ProcessOperation",classGUID, opGUID)%
```

Any function that is to be called by the `EXEC_ADD_IN` macro must have two parameters: an `EA.Repository` object, and a `Variant` array that contains any additional parameters from the `EXEC_ADD_IN` call. Return type should be `Variant`. For example:

```
Public Function ProcessOperation(Repository As EA.Repository, args As Variant) As Variant
```

**FIND(<src>, <subString>)**

Position of the first instance of `<subString>` in `<src>`; `-1` if none.

**GET\_ALIGNMENT()**

Returns a string where all of the text on the current line of output is converted into spaces and tabs.

**JAVADOC\_COMMENT(<wrap\_length>)**

Converts the notes for the element currently in scope to `javadoc`-style comments.

**LEFT(<src>, <count>)**

The first `<count>` characters of `<src>`.

**LENGTH(<src>)**

Length of `<src>`.

**MID(<src>, <count>)****MID(<src>, <start>, <count>)**

Substring of `<src>` starting at `<start>` and including `<count>` characters. Where `<count>` is omitted the rest of



the string is included.

**PI(<option>, <value>, ...)**

Sets the PI for the current template to <value>. <option> controls when the new PI takes effect. Valid values are:

- *I, Immediate*: the new PI is generated before the next non-empty template line
- *N, Next*: the new PI is generated after the next non-empty template line.

Multiple pairs of options are allowed in one call. For more details, see the [description of PI](#).<sup>[1192]</sup>

**PROCESS\_END\_OBJECT(<template\_name>)**

Enables the Classes that are one Class further away from the base Class, to be transformed into objects (such as attributes, operations, packages, parameters and columns) of the base Class. <template\_name> refers to the working template that temporarily stores the data.

**REMOVE\_DUPLICATES(<source>, <separator>)**

Where <source> is a <separator> separated list; this removes any duplicate or empty strings.

**REPLACE(<string>, <old>, <new>)**

Replaces all occurrences of <old> with <new> in the given string <string>.

**RESOLVE\_OP\_NAME()**

Resolves clashes in interface names where two method-from interfaces have the same name.

**RESOLVE\_QUALIFIED\_TYPE()****RESOLVE\_QUALIFIED\_TYPE(<separator>)****RESOLVE\_QUALIFIED\_TYPE(<separator>, <default>)**

Generates a qualified type for the current attribute, linked attribute, linked parent, operation, or parameter. Enables the specification of a separator other than . and a default value for when some value is required.

**RIGHT(<src>, <count>)**

The last <count> characters of <src>.

**TO\_LOWER(<string>)**

Converts <string> to lower case.

**TO\_UPPER(<string>)**

Converts <string> to upper case.

**TRIM(<string>)****TRIM(<string>, <trimChars>)**

Removes trailing and leading white spaces from <string>. If <trimChars> is specified, all leading and trailing characters in the set of <trimChars> are removed.

**TRIM\_LEFT(<string>)****TRIM\_LEFT(<string>, <trimChars>)**

Removes the specified leading characters from <string>.

**TRIM\_RIGHT(<string>)****TRIM\_RIGHT(<string>, <trimChars>)**

Removes the specified trailing characters from <string>.

**VB\_COMMENT(<wrap\_length>)**

Converts the notes for the element currently in scope to Visual Basic style comments.

**WRAP\_COMMENT(<comment>, <wrap\_length>, <indent>, <start\_string>)**

Wraps the text <comment> at width <wrap\_length> putting <indent> and <start\_string> at the beginning of each line. For example:

```
$behavior = %WRAP_COMMENT(opBehavior, "40", " ", "//")%
```

**Note:**

<wrap\_length> must still be passed as a string, even though **WRAP\_COMMENT** treats this parameter as an integer.

**WRAP\_LINES(<text>, <wrap\_length>, <start\_string>[, <end\_string>])**

Wraps <text> as designated to be <wrap\_length>, adding <start\_string> to the beginning of every line and <end\_string> to the end of the line if it is specified.

**XML\_COMMENT(<wrap\_length>)**

Converts the notes for the element currently in scope to XML-style comments.

*Control macros* are used to control the processing and formatting of the templates. The basic types of control macro include:

- The *list* macro, for generating multiple element features, such as attributes and operations
- The branching macros, which form *if-then-else* constructs to conditionally execute parts of a template
- The PI macro, which takes effect from the next non-empty line
- A PI [function macro](#) <sup>[1187]</sup> that enables setting PI to a variable and adds the ability to set the PI that is generated before the next line
- The PI macro for formatting new lines in the output
- The synchronization macros.

In general, control macros are named according to Camel casing.

**List**

The *list* macro is used to generate multiple elements. The basic structure is:

```
%list=<TemplateName> @separator=<string> @indent=<string> [<conditions>]%
```

where <string> is a double-quoted literal string and <TemplateName> can be one of the following template names:

- Attribute
- Class
- ClassBase
- ClassImpl
- ClassInterface
- Constraint
- Custom Template (custom templates enable you to define your own templates; for more information see [Custom Templates](#) <sup>[1202]</sup>.)
- Effort
- InnerClass
- InnerClassImpl
- LinkedFile
- Metric
- Namespace
- Operation
- OperationImpl
- Parameter
- Problem
- Requirement
- Resource
- Risk

- Scenario
- Test

<conditions> is optional and appears the same as the conditions for *if* and *elseif* statements.

#### Example:

```
%list="Attribute" @separator="\n" @indent="  "%
```

The *separator* attribute, denoted above by *@separator*, specifies the space that should be used between the list items. This excludes the last item in the list.

The *indent* attribute, denoted by *@indent*, specifies the space by which each line in the generated output should be indented.

The above example would output the result of processing the *Attribute* template, for each attribute element of the Class in scope. The resultant list would separate its items with a single new line and indent them two spaces respectively. If the Class in scope had any stereotyped attributes, they would be generated using the appropriately specialized template.

There are some special cases to consider when using the *list* macro:

- If the *Attribute* template is used as an argument to the list macro, this also generates attributes derived from associations by executing the appropriate *LinkedAttribute* template
- If the *ClassBase* template is used as an argument to the list macro, this also generates Class bases derived from links in the model by executing the appropriate *LinkedClassBase* template
- If the *ClassInterface* template is used as an argument to the list macro, this also generates Class bases derived from links in the model by executing the appropriate *LinkedClassInterface* template
- If *InnerClass* or *InnerClassImpl* is used as an argument to the list macro, these Classes are generated using the *Class* and *ClassImpl* templates respectively. These arguments tell Enterprise Architect that it should process the templates based on the inner Classes of the Class in scope.

## Branching (if-then-else Constructs)

The CTF supports a limited form of branching through the following macros:

- *if*
- *elseif*
- *endif*
- *endTemplate*

The basic structure of the *if* and *elseif* macros is:

```
%if <test> <operator> <test>%
```

where <operator> can be one of:

- ==
- !=

and <test> can be one of:

- a string literal, enclosed within double quotation marks
- a direct substitution macro, without the enclosing percent signs
- a variable reference.

Branches can be nested, and multiple conditions can be specified using one of:

- and
- or.

#### Note:

When specifying multiple conditions, *and* and *or* have the same order of precedence, and conditions are processed left to right.

The *endif* or *endTemplate* macros must be used to signify the end of a branch. In addition, the *endTemplate* macro causes the template to return immediately, if the corresponding branch is being executed.

#### Example:

```
%if elemType == "Interface"%  
;  
;%else%
```

```
%OperationBody%
%endif%
```

### Example:

```
$bases=%list="ClassBase" @separator=", "%
$interfaces=%list="ClassInterface" @separator=", "%
%if $bases != "" and $interfaces != ""%
: $bases, $interfaces
%elseif $bases != ""%
: $bases
%elseif $interfaces != ""%
: $interfaces
%endif%
```

## The PI Macro

There are two primary means of generating whitespace from the templates:

- Explicitly using the *newline*, *space* and *tab* characters (`\n`, `\t`) as part of Literal Text
- Using the *PI* macro to format lines in the template that result in non-empty substitutions in the output.

By default, each template line that generates a non-empty substitution also results in a newline being produced in the output. This behavior can be changed through the *PI* macro.

To demonstrate the use of the *PI* macro, consider the default *C# Operation* template:

```
%opTag:"Attribute"%
```

Default PI is `\n`, so any attributes would be on their own line

```
%PI=" "%
```

Blank lines have no effect on the output

```
%opTag:"unsafe"=="true" ? "unsafe" : ""%
```

Set the PI, so keywords are separated by a space

```
%CONVERT_SCOPE(opScope)%
```

```
%opTag:"new"=="true" ? "new" : ""%
```

Any keyword that does not apply - that is, the macro produces an empty result - does not result in a space

```
%opAbstract=="T" ? "abstract" : ""%
```

```
%opConst=="T" ? "sealed" : ""%
```

```
%opStatic=="T" ? "static" : ""%
```

```
%opTag:"extern"=="true" ? "extern" : ""%
```

```
%opTag:"delegate"=="true" ? "delegate" : ""%
```

```
%opTag:"override"=="true" ? "override" : ""%
```

```
%opTag:"virtual"=="true" ? "virtual" : ""%
```

Only one space is generated for this line

```
%opReturnType%%opReturnArray=="T" ? "[]" : ""%
```

```
%opStereotype=="operator" ? "operator" : ""%
```

```
%opName%(%list="Parameter" @separator=", "%)
```

The final line in the template does not generate a space

In the above example macros for the various keywords are to be arranged vertically for readability. In the output, however, each relevant keyword is to be separated by a single space. This is achieved by the line:

```
%PI=" "%
```

Notice how you do not specify the space between each of the possible keywords. This space is already implied by setting the PI to a single space. Essentially the PI acts as a convenience mechanism for formatting the output from within the templates.

The structure for setting the processing instruction is:

```
%PI=<value>%
```

where *<value>* can be a literal string enclosed by double quotes.

The following points apply to the *PI* macro:

- The value of the PI is not accessed explicitly
- Only template lines that result in a non-empty substitution cause the PI to be generated
- The last non-empty template line does not cause the PI to be generated
- The PI is not appended to the last substitution, regardless of which template line caused that substitution.

## Synchronization Macros

The *synchronization macros* are used to provide formatting hints to Enterprise Architect when inserting new sections into the source code, during forward synchronization. The values for synchronization macros must be set in the **File** templates.

The structure for setting synchronization macros is:

```
%<name>=<value>%
```

where *<name>* can be one of the macros listed below and *<value>* is a literal string enclosed by double quotes.

Macro Name	Description
<b>synchNewClassNotesSpace</b>	Space to append to a new Class note. Default value: \n.
<b>synchNewAttributeNotesSpace</b>	Space to append to a new attribute note. Default value: \n.
<b>synchNewOperationNotesSpace</b>	Space to append to a new operation note. Default value: \n.
<b>synchNewOperationBodySpace</b>	Space to append to a new operation body. Default value: \n.
<b>synchNamespaceBodyIndent</b>	Indent applied to Classes within non-global namespaces. Default value: \t.

Enterprise Architect provides two Enterprise Architect Simulation Library (EASL) code generation macros to generate code from behavioral models. These are:

- EASL\_GET and
- EASLList.

## EASL\_GET

The *EASL\_GET* macro is used to retrieve a property or a collection of an EASL object. The EASL objects and the properties and collections for each object are identified in the [EASL Collections](#)<sup>[1194]</sup> and [EASL Properties](#)<sup>[1195]</sup> topics.

### Syntax

```
$result = %EASL_GET(<<Property>>, <<Owner ID>>, <<Name>>)
```

where:

- <<Property>> is either "Property" or "Collection"
- <<OwnerID>> is the ID of the owner object for which the property/collection is to be retrieved
- <<Name>> is the name of the property or Collection being accessed
- \$result is the returned value; this is "" if not a valid property.

### Example

```
$sPropName = %EASL_GET("Property", $context, "Name")%
```

## EASLList

The *EASLList* macro is used to render each object in an EASL collection using the appropriate template.

### Syntax

```
$result = %EASLList=<<TemplateName>> @separator=<<Separator>>
@indent=<<indent>> @owner=<<OwnedID>>
@collection=<<CollectionName>> @option1=<<OPTION1>>
@option2=<<OPTION2>>..... @optionN=<<OPTIONN>>%
```

where:

- <<TemplateName>> is the name of any [behavioral model template](#)<sup>[1194]</sup> or [custom template](#)<sup>[1202]</sup>
- <<Separator>> is a list separator (such as "\n")
- <<indent>> is any indentation to be applied to the result
- <<owner>> is the ID of the object that contains the required collection
- <<CollectionName>> is the name of the required collection
- <<OPTION1>>....<<OPTION99>> are miscellaneous options that might be passed on the template; each option is given as an additional input parameter to the template
- \$result is the resultant value; this is "" if not a valid collection.

**Example**

```

$$States = %EASList="State" @separator="\n" @indent="\t"
           @owner=$StateMachineGUID @collection="States" @option=$$Option%

```

**Behavioral Model Templates**

- Action
- Action Assignment
- Action Break
- Action Call
- Action Create
- Action Destroy
- Action If
- Action Loop
- Action Opaque
- Action Parallel
- Action RaiseEvent
- Action RaiseException
- Action Switch
- Behavior
- Behavior Body
- Behavior Declaration
- Behavior Parameter
- Call Argument
- Guard
- Property Object
- Property Declaration
- Property Notes
- State
- State CallBack
- State Enumerate
- State EnumeratedName
- StateMachine
- StateMachine HistoryVar
- Transition
- Transition Effect
- Trigger.

This topic lists the EASL collections for each of the EASL objects, as retrieved by the [EASL\\_GET](#)<sup>[1193]</sup> code generation macro.

**Action**

Collection Name	Description
Arguments	The Action's arguments.
SubActions	The sub-actions of the Action.

**Behavior**

Collection Name	Description
Actions	The Behavior's Actions.

Collection Name	Description
Nodes	The Behavior's nodes.
Parameters	The Behavior's parameters.
Variables	The Behavior's variables.

### Classifier

Collection Name	Description
AllStateMachines	All State Machines for the Classifier.
AsynchProperties	The asynchronous properties of the Classifier.
AsynchTriggers	The asynchronous triggers of the Classifier.
Behaviors	The behaviors of the Classifier.
Properties	The properties of the Classifier.
TimedProperties	The timed properties of the Classifier.
TimedTriggers	The timed triggers of the Classifier.

### Construct

Collection Name	Description
AllChildren	The Construct's children.
ClientDependencies	The client dependencies on the Construct.
StereoTypes	The stereotypes of the Construct.
SupplierDependencies	The supplier dependencies on the Construct.

### Node

Collection Name	Description
IncomingEdges	The Node's incoming edges.
OutgoingEdges	The Node's outgoing edges.
SubNodes	The sub-nodes of the Node.

### State

Collection Name	Description
DoBehaviors	The State's Do behaviors.
EntryBehaviors	The State's Entry behaviors.
ExitBehaviors	The State's Exit behaviors.

## StateMachine

Collection Name	Description
AllFinalStates	The State Machine's final States.
AllStates	All States within the State Machine, including those within Submachine States.
DerivedTransitions	The State Machine's derived transitions with the associated valid effect.
States	The States within the State Machine.
Transitions	The transitions within the State Machine.
Vertices	The State Machine's vertices.

## Transition

Collection Name	Description
Effects	The Transition's effects.
Guards	The Transition's guards.
Triggers	The Transition's triggers.

## Trigger

Collection Name	Description
TriggeredTransitions	The triggered transitions associated with the Trigger.

## Vertex

Collection Name	Description
DerivedOutgoingTransitions	The Vertex's derived outgoing transitions after traversing the pseudo-nodes.
IncomingTransitions	The Vertex's incoming transitions.
OutgoingTransitions	The Vertex's outgoing transitions.

This topic lists the EASL properties for each of the EASL objects, as retrieved by the [EASL\\_GET](#)<sup>[1193]</sup> code generation macro.

## Action

Property Name	Description
Behavior	The Action's associated behavior ( <i>Call Behavior Action</i> or <i>Call Operation Action</i> ).
Body	The Action's body.
Context	The Action's context.
Guard	The Action's guard.
IsFinal	A check on whether the action is a final Action.
IsGuarded	A check on whether the action is a guarded Action.



Property Name	Description
IsInitial	A check on whether the action is an initial Action.
Kind	The Action's kind.
Next	The Action's next action.
Node	The Action's associated node in the graph.

### Argument

Property Name	Description
Parameter	The ID of the Argument's associated parameter.
Value	The default value of the argument.

### Behavior

Property Name	Description
InitialAction	The Behavior's initial action.
isReadOnly	The isReadOnly of the Behavior.
isSingleExecution	The isSingleExecution of the Behavior.
Kind	The kind of Behavior.
ReturnType	The return type of the Behavior.

### CallEvent

Property Name	Description
Operation	The operation of the CallEvent.

### ChangeEvent

Property Name	Description
ChangeExpression	The change expression of the ChangeEvent.

### Classifier

Property Name	Description
HasBehaviors	A check on whether the Classifier has behavioral models (Activity and Interaction).
Language	The Classifier's language.
StateMachine	The State Machine of the Classifier.

### Condition

Property Name	Description
Expression	The Condition's expression.
Lower	The Condition's lower value.
Upper	The Condition's upper value.

### Construct

Property Name	Description
GetTaggedValue	The Property's Tagged Value.
IsStereotypeApplied	A check on whether a particular stereotype is applied to the Property.
Notes	Notes on the Property.
UMLType	The UML type of the Property.
Visibility	The visibility of the Property.

### Edge

Property Name	Description
From	The ID of the node from which the Edge arises.
To	The ID of the node at which the Edge is targeted.

### EventObject

Property Name	Description
EventKind	The event kind of the Event Object.

### Instance

Property Name	Description
Classifier	The classifier of the Instance.
Value	The value of the Instance.

### Parameter

Property Name	Description
Direction	The direction of the Parameter.
Type	The type of the Parameter.
Value	The value of the parameter.

## Primitive

Property Name	Description
FQName	The FQ name of the Primitive.
ID	The ID of the Primitive.
Name	The name of the Primitive.
ObjectType	The object type of the Primitive.
Parent	The IDParent of the Primitive.

## PropertyObject

Property Name	Description
BoundSize	The bound size of the PropertyObject (if it is a collection).
ClassifierStereoType	The stereotype of the PropertyObject's classifier.
IsAsynchProp	A check on whether the PropertyObject is an asynchronous property.
IsCollection	A check on whether the PropertyObject is a collection.
IsOrdered	A check on whether the PropertyObject is ordered (if it is a collection).
IsTimedProp	A check on whether the PropertyObject is a timed property.
Kind	The PropertyObject's kind.
LowerValue	The PropertyObject's lower value (if it is a collection).
Type	The PropertyObject's type.
UpperValue	The PropertyObject's upper value (if it is a collection).
Value	The PropertyObject's value.

## SignalEvent

Property Name	Description
Signal	The signal of the SignalEvent.

## State

Property Name	Description
HasSubMachine	A check on whether the State is a Submachine state.
IsFinalState	A check on whether the State is a final state.
SubMachine	Get the ID of the Submachine contained by the State (if applicable).

## StateMachine

Property Name	Description
HasSubMachineState	A check on whether the State Machine has a Submachine state.

Property Name	Description
InitialState	The State Machine's initial state.
SubMachineState	The State Machine's Submachine state.

### TimeEvent

Property Name	Description
When	The 'when' property of the TimeEvent.

### Transition

Property Name	Description
HasEffect	A check on whether the transition has a valid effect.
IsDerived	A check on whether the transition is a derived transition.
IsTranscend	A check on whether the transition transcends from one State Machine (Submachine state) to another.
IsTriggered	A check on whether the transition is triggered.
Source	The Transition's source.
Target	The Transition's target.

### Trigger

Property Name	Description
AsynchDestinationState	The asynchronous destination state of the Trigger (if it is an asynchronous trigger).
DependentProperty	The ID of the property associated with the Trigger.
Event	The Trigger's event.
Name	The Trigger's name.
Type	The Trigger's type.

### Vertex

Property Name	Description
IsHistory	A check on whether the vertex is a history state.
IsPseudoState	A check on whether the vertex is a pseudo state.
PseudoStateKind	The Vertex's pseudo-state kind.

#### 5.3.1.5.1.3 Variables

Template variables provide a convenient way of storing and retrieving data within a template. This section explains how variables are [defined](#)<sup>[1200]</sup> and [referenced](#)<sup>[1201]</sup>.

#### Variable Definitions

Variable definitions take the basic form:

```
$<name> = <value>
```

where *<name>* can be any alpha-numeric sequence and *<value>* is derived from a macro or another variable.

A simple example definition would be:

```
$foo = %className%
```

Variables can be defined, using values from:

- Substitution, function or list macros
- String literals, enclosed within double quotation marks
- Variable references.

### Definition Rules

The following rules apply to variable definitions:

- Variables have global scope within the template in which they are defined and are not accessible to other templates
- Each variable must be defined at the start of a line, without any intervening whitespace
- Variables are denoted by prefixing the name with \$, as in \$foo
- Variables do not have to be declared, prior to being defined
- Variables must be defined using either the assignment operator (=), or the addition-assignment operator (+=)
- Multiple terms can be combined in a single definition using the addition operator (+).

### Examples

Using a substitution macro:

```
$foo = %opTag:"bar"%
```

Using a literal string:

```
$foo = "bar"
```

Using another variable:

```
$foo = $bar
```

Using a list macro:

```
$ops = %list="Operation" @separator="\n\n" @indent="\t"%
```

Using the addition-assignment operator (+=):

```
$body += %list="Operation" @separator="\n\n" @indent="\t"%
```

The above definition is equivalent to the following:

```
$body = $body + %list="Operation" @separator="\n\n" @indent="\t"%
```

Using multiple terms:

```
$templateArgs = %list="ClassParameter" @separator=", "%  
$template = "template<" + $templateArgs + ">"
```

## Variable References

Variable values can be retrieved by using a reference of the form:

```
$<name>
```

where *<name>* can be a previously defined variable.

Variable references can be used in one of the following ways:

- As part of a macro, such as the argument to a function macro
- As a term in a variable definition
- As a direct substitution of the variable value into the output.

#### Note:

It is legal to reference a variable before it is defined. In this case, the variable is assumed to contain an empty string value: ""

### Example 1

Using variables as part of a macro. The following is an excerpt from the default C++ ClassNotes template.

```
$wrapLen = %genOptWrapComment%
$style = %genOptCPPCommentStyle%
```

Define variables to store the style and wrap length options.

```
%if $style == "XML.NET"%
%XML_COMMENT($wrapLen)%
%else%
%CSTYLE_COMMENT($wrapLen)%
%endif%
```

Reference to `$style` as part of a condition.

Reference to `$wrapLen` as an argument to function macro.

### Example 2

Using variable references as part of a variable definitions:

```
$foo = "foo"
$bar = "bar"

$foobar = $foo + $bar
```

Define our variables.

`$foobar` now contains the value `foobar`.

### Example 3

Substituting variable values into the output

```
$bases=%classInherits%

Class %className%$bases
```

Store the result of the `ClassInherits` template in `$bases`.

Now output the value of `$bases` after the Class name.

#### 5.3.1.5.2 The Code Template Editor in MDG Development

The following topics describe how you use the **Code Template Editor** window to create custom templates:

- [Custom Templates](#)<sup>[1202]</sup>
- [Override Default Templates](#)<sup>[1204]</sup>
- [Add New Stereotyped Templates](#)<sup>[1205]</sup>
- [Create Templates For Custom Languages](#)<sup>[1206]</sup>

The Code Template Editor provides the facilities of the *Common Code Editor*, including intellisense for the code generation template [macros](#)<sup>[1173]</sup>. For more information on intellisense and the Common Code Editor, see the [Code Editors](#)<sup>[1428]</sup> topic.

##### 5.3.1.5.2.1 Custom Templates

Custom templates enable you to generate an element in many different ways. Enterprise Architect enables you to define custom templates that are associated with given elements and call these templates from existing templates. You can even add stereotype overrides to your custom templates. For example, you might list all of your parameters and their notes in your method notes.

To create a new custom template, follow the steps below:

1. Select the **Settings | Code Generation Templates** menu option, or press **[Ctrl]+[Shift]+[P]**. The **Code Templates Editor** tab opens.
2. In the **Language** field, click on the drop-down arrow and select the appropriate language.
3. Click on the **Add New Custom Template** button. The **Create New Custom Template** dialog displays.

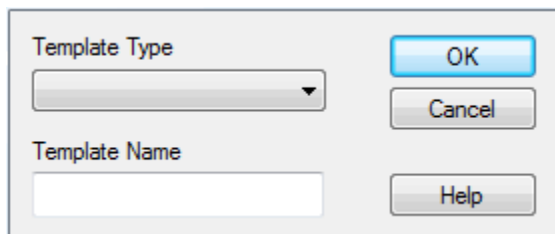

4. In the **Template Type** field, click on the drop-down arrow and select the appropriate element. The elements currently supported are:
  - Attribute
  - Class
  - Class Base

- Class Interface
- Class Parameter
- Connector
- Import
- Linked Attribute
- Linked Class Base
- Linked Class Interface
- Namespace
- Operation
- Parameter.

**Note:**

**<None>** requires special treatment. It enables the definition of a function macro that doesn't actually apply to any of the types, but must be called as a function to define variables *\$parameter1*, *\$parameter2* and so on for each value passed in.

5. In the **Template Name** field, type an appropriate name, then click on the **OK** button.
6. On the **Code Templates Editor** tab, the new template displays in the **Templates** list with the value **Yes** in the **Modified** field. The template is called <Template Type>\_<Template Name>.
7. Select the appropriate template from the **Templates** list and edit the contents in the **Template** field to meet your requirements.

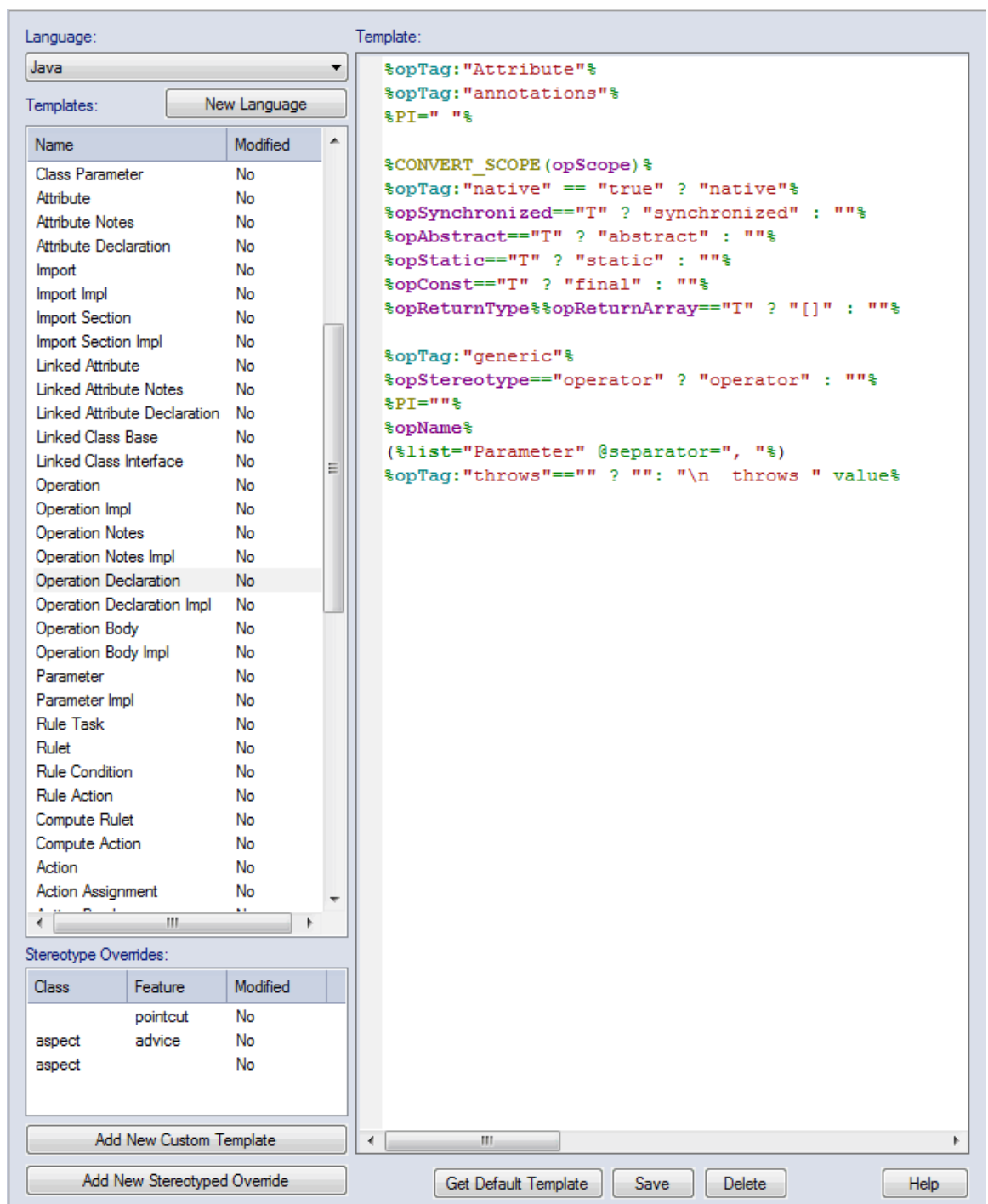

- Click on the **Save** button. This stores the new stereotyped template in the .EAP file. The template is now available from the list of templates and via direct substitution for use.

### 5.3.1.5.2.2 Override Default Templates

Enterprise Architect has a set of built-in or default code generation templates. The **Code Templates Editor** enables you to modify these default templates, hence customizing the way in which Enterprise Architect generates code. You can choose to modify any or all of the base templates to achieve your required coding style.

Any templates that you have overridden are stored in the .EAP file. When generating code, Enterprise Architect first checks whether a template has been modified and if so, uses that template. Otherwise the appropriate default template is used.



## Procedure

To override a default code generation template, follow the steps below.

1. Select the **Configuration | Code Generation Templates** menu option. The **Code Templates Editor** displays.
2. Select the appropriate language from the **Language** list.
3. Select one of the base templates from the **Templates** list.
4. If the base template has stereotyped overrides, you can select one of these from the **Stereotype Overrides** list.
5. In the **Code Templates Editor**, make the required modifications.
6. Click on the **Save** button. This stores the modified version of the template to the .EAP file. The template is marked as modified.

When generating code, Enterprise Architect now uses the overridden template, instead of the default template.

### 5.3.1.5.2.3 Add New Stereotyped Templates

Sometimes it is useful to define a specific code generation template for use with elements of a given stereotype. This enables different code to be generated for elements, depending on their stereotype. Enterprise Architect provides some default templates, which have been specialized for commonly used stereotypes in supported languages. For example the Operation Body template for C# has been specialized for the *property* stereotype, so that it automatically generates its constituent *get* and *set* methods. Users can override the default stereotyped templates as described in the previous topic. Additionally users can define templates for their own stereotypes, as described below.

## Add a New Stereotyped Template

To override a default code generation template, follow the steps below.

1. Select the **Configuration | Code Generation Templates** menu option to open the **Code Templates Editor**.
2. Select the appropriate language, from the **Language** list.
3. Select one of the base templates, from the **Templates** list.
4. Click on the **Add New Stereotyped Override** button. The **New Template Override** dialog displays.

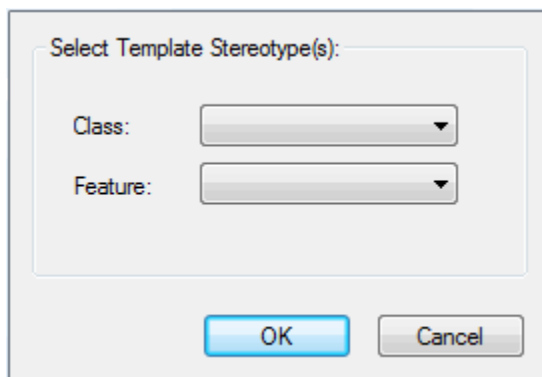

5. Select the required **Feature** and/or **Class** stereotype and click on the **OK** button.
6. The new stereotyped template override displays in **Stereotype Overrides** list, marked as modified.
7. Make the required modifications in the **Code Templates Editor**.
8. Click on the **Save** button. This stores the new stereotyped template in the .EAP file.

Enterprise Architect can now use the stereotyped template, when generating code for elements of that stereotype.

Note that Class and feature stereotypes can be combined to provide a further level of specialization for features. For example, if properties should be generated differently when the Class has a stereotype *MyStereotype*, then both *property* and *MyStereotype* should be specified in the **New Template Override** dialog.

#### 5.3.1.5.2.4 Create Custom Language Template

Enterprise Architect can forward generate code for languages that it does not specifically support, if the appropriate code generation templates are defined for that language. This topic outlines the steps required to define templates for custom languages.

#### Define a Template for a Custom Language

1. Create the custom language as a new product. To do this:
  - Select the **Settings | Code Datatypes** menu option. The **Programming Languages Datatypes** dialog displays.
  - In the **Product Name** field type the name of the new language, and in the **Datatype** field type a datatype (one is enough to declare that the new language exists). See the [Data Types](#)<sup>[666]</sup> topic for more details.
2. Select the **Settings | Code Generation Templates** menu option. The **Code Templates Editor** view displays.
3. In the **Language** field, click on the drop-down arrow and select the custom language.
4. From the **Templates** list, select one of the base templates.
5. Define the template using the **Code Templates Editor**.
6. Click on the **Save** button. This stores the template in the .EAP file.
7. Repeat steps 1 to 6 for each of the relevant base templates for the custom language.

#### Note:

The *File* template must be defined for the custom language. The *File* template can then see the *Import Section*, *Namespace* and *Class* templates.

**Part**



## 6 *Navigate, Search and Trace*



This section explains how you navigate through the model structures in Enterprise Architect, locate and display specific data and structures, and trace the origins and development of the model components.

The section describes:

- The Enterprise Architect [Project Browser](#)<sup>[1209]</sup>
- The use of [Model Views](#)<sup>[1222]</sup> to provide different perspectives
- The [Model Search](#)<sup>[1231]</sup> facility
- Support for [Traceability](#)<sup>[1245]</sup> during model development
- Use of the [Element List](#)<sup>[1255]</sup> to review model components
- Use of the [Relationship Matrix](#)<sup>[1261]</sup> to review relationships between model components.

## 6.1 The Project Browser



The **Project Browser** enables you to navigate through the Enterprise Architect project space. It displays packages, diagrams, elements and element properties.

You can drag and drop elements between folders, or drop ([paste](#))<sup>[430]</sup> elements from the **Project Browser** directly into the current diagram.

If you right-click on an item in the **Project Browser** to display the context menus, you can perform additional actions such as adding new packages, creating diagrams, renaming items, creating documentation and other reports, and deleting model elements. You can also edit the name of any item in the **Project Browser** by selecting the item and pressing **[F2]**.

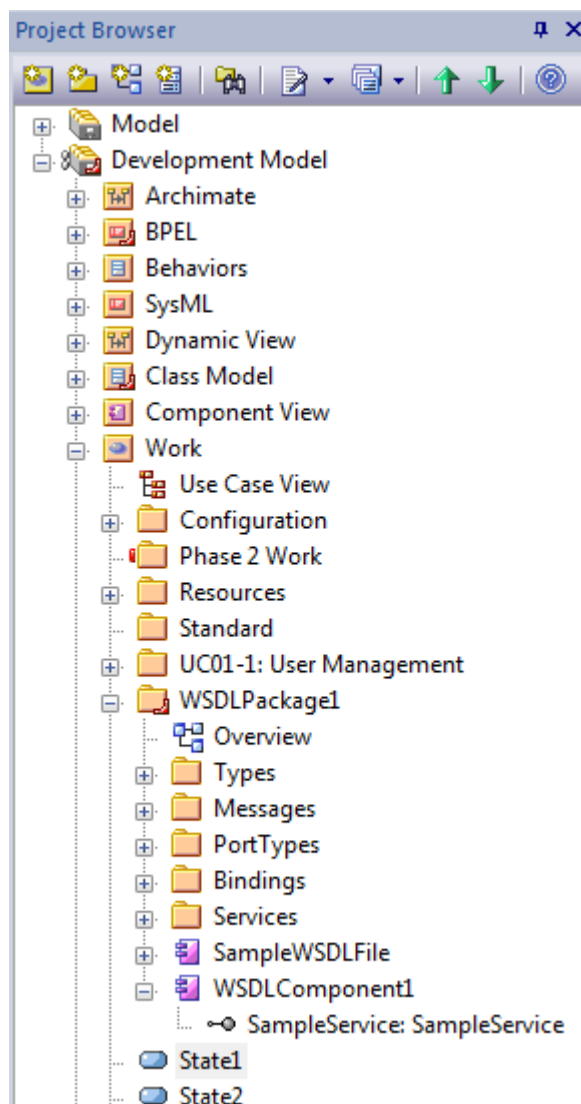

**Tip:**

The **Project Browser** is the main view of all model elements in your model; use the mouse to navigate the project.

**Note:**

You can hide and show the **Project Browser** by pressing **[Alt]+[0]**.

## Views

The **Project Browser** can be divided into [Views](#)<sup>[383]</sup>, each of which contains diagrams, packages and other elements. A default View hierarchy is described below, but you can create different Views to suit your requirements:

View	Description
Use Case View	The functional and early analysis View. Contains Business Process and Use Case models.
Dynamic View	Contains State Charts, Activity and Interaction diagrams. The dynamics of your system.
Logical View	The Class Model and Domain Model View.
Component View	A View for your system components. The high level view of what software is to be built (such as executables, DLLs and components).
Deployment View	The physical model; what hardware is to be deployed and what software is to run on it.
Custom View	A work area for other Views, such as formal requirements, recycle bin, interview notes and non-functional requirements.

## Selective Collapse

When you are working on an expanded project in the **Project Browser**, you might want to locate the parent element or package of an item, and/or collapse the structure under that parent element or package. To do this, follow the steps below:

1. Position the cursor on an item within the element or package.
2. Press **[←]** on the keyboard to highlight the parent.
3. Press the key again to collapse the structure under that parent element or package.

### See Also

- [Project Browser Icon Overlays](#)<sup>[1213]</sup>

### 6.1.1 Order Package Contents

Enterprise Architect enables you to change the order of elements listed in the **Project Browser**.

Elements by default are first listed in order of type, then in order of set position, then alphabetically. You can use the context menu options to move an element up or down within its type, but not outside its type. This means you can re-sequence Packages or Diagrams or Use Cases, but you cannot mix elements up. However, you can [change this default behavior](#)<sup>[1210]</sup> to allow elements to be re-ordered within the package, regardless of type.

Ordering elements is very important when it comes to structuring your model, especially packages. RTF documents honor any custom ordering when printing documentation.

### 6.1.2 Set Default Behavior

The **General** page of the **Options** dialog provides several options for altering the look and behavior of the **Project Browser**.

To access the **General** page, select the **Tools | Options | General** menu option.

## Double-click Behavior

In the **Double click on browser** panel, select the appropriate radio button.

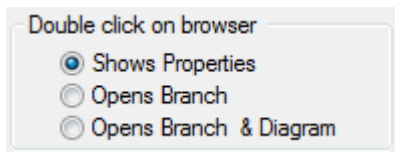



- **Shows Properties** - double-clicking an item in the **Project Browser** opens a **Property** dialog (if available) for that element
- **Opens Branch** - double-clicking an item in the **Project Browser** expands the tree to show the item's children; if there are no children, nothing happens
- **Opens Branch & Diagram** - as above, but also opens the first diagram beneath the item, if applicable.

## Enable Free Sorting

The **General** page of the **Options** dialog, in the **Project Browser** panel, select the **Allow Free Sorting** checkbox. This enables you to [re-order elements](#) within a package regardless of type, within the **Project Browser**.

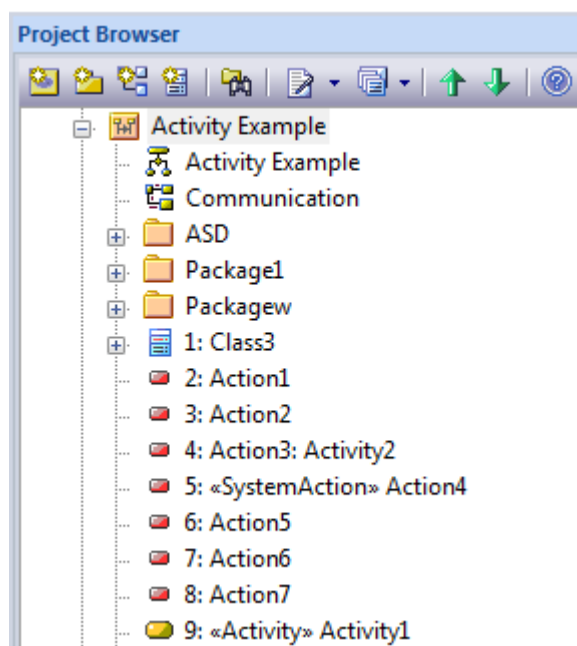
For example, below, the element *Class3* has been moved from its original position with the other **Class** elements, to a point amongst the **Action** elements.



You move elements using the  icon (moves the element further up the tree) and  icon (moves the element further down the tree) in the **Project Browser** toolbar.

## Show Stereotypes

1. On the **Options** dialog, in the **Project Browser** panel, select the **Show Stereotypes** checkbox.
2. When prompted, shut down and restart Enterprise Architect to enable this change to take effect.

As shown in the above screen, when a stereotype is defined for an element, the stereotype name then displays in front of the element name (see *Action4* and *Activity1*).

You set the stereotype of an element in its **Properties** dialog.

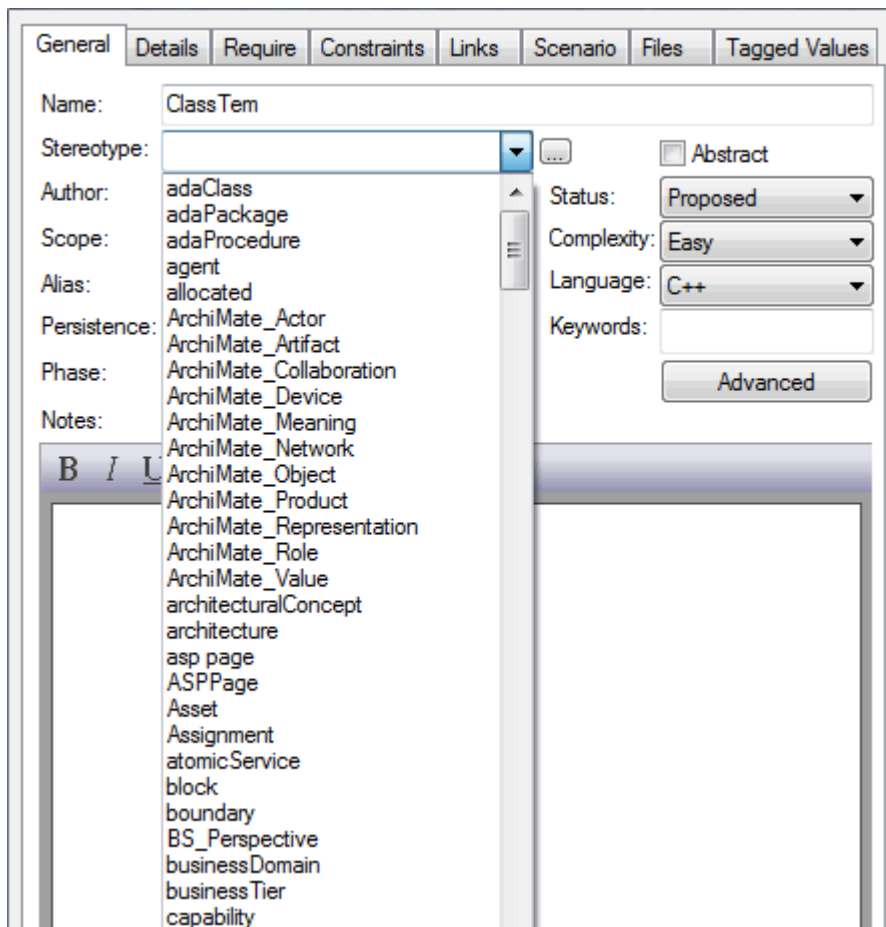

### 6.1.3 Project Browser Toolbar

The **Project Browser** toolbar enables you to perform a range of operations on your project structures.







The functions of each icon in the toolbar are, from left to right:

- [Create a new Model Package](#)<sup>[372]</sup> in the project, from a predefined UML or Technology pattern
- [Create a new child package](#)<sup>[387]</sup> under the selected package
- [Create a new child diagram](#)<sup>[422]</sup> under the selected package or element
- [Create a new child element](#)<sup>[524]</sup> under the selected package or element
- Perform a simple search for a text string in the **Project Browser**
- Provide options to generate an [RTF report](#)<sup>[1570]</sup>, [HTML report](#)<sup>[1647]</sup> or [Diagram Only](#)<sup>[1625]</sup> report on the selected package in the **Project Browser**
- Provide options to [generate source code](#)<sup>[1311]</sup> or [DDL](#)<sup>[1369]</sup>, [import a source directory](#)<sup>[1332]</sup>, [binary module](#)<sup>[1334]</sup> or [database schema](#)<sup>[1363]</sup>, [generate package contents](#)<sup>[1313]</sup> to synchronize with package code, or [reset the source code language](#)<sup>[1361]</sup>, all for the selected package
- Move the selected package or element further up the **Project Browser**, within its parent package
- Move the selected package or element further down the **Project Browser**, within its parent package
- Open the Enterprise Architect Help on the **Project Browser**.







### 6.1.4 Project Browser Icon Overlays

The **Project Browser** displays the status of each package in the model by overlaying status icons on the package icon. The following table describes what each overlaid icon means.

Icon Overlay	Indicates that...
	This package is <a href="#">controlled</a> <sup>[293]</sup> and is represented by an XMI file on disk. Version control either is not being used or is not available. You can edit the package.
	This package is version controlled and <a href="#">checked out</a> <sup>[267]</sup> to you, therefore you can edit the package.
	This package is version controlled and not checked out to you, therefore you cannot edit the package (unless you check the package out).
	This package is version controlled, but you checked it out whilst <a href="#">not connected to the version control</a> <sup>[268]</sup> server. You can edit the package but there could be version conflicts when you check the package in again.
	This package is a namespace root. It denotes where the namespace structure starts; packages below this point are generated as <a href="#">namespaces</a> <sup>[137]</sup> to code.
<MDG Add-In icon>	<a href="#">MDG Add-Ins</a> <sup>[182]</sup> specify their own icon to denote that this branch of the model belongs to that Add-In. All packages connected to an MDG Add-In correspond to a namespace root, so the namespace root icon is not displayed.

Similarly, the **Project Browser** indicates attribute and operation scope status with icons. The following table describes what each indicator icon means.

Icon Overlay	Indicates that...
 	The attribute or operation is scoped as protected.
 	The attribute or operation is scoped as private.

In the Corporate, Business and Software Engineering, Systems Engineering and Ultimate editions, if [Project User Security](#) <sup>[188]</sup> is on, the **Project Browser** also has element locking indicators (red and blue exclamation marks) that indicate the lock status of individual elements and packages. The availability of these elements for editing depends on whether user locks are required or not. For further information, see the [Locked Element Indicators](#) <sup>[208]</sup> topic.

### 6.1.5 Project Browser Context Menus

This section describes the many options available to work on objects in the **Project Browser**, selected from the following context menus:

- [Model \(Root Node\) context menu](#) <sup>[1213]</sup>
- [Package Context Menu](#) <sup>[1214]</sup>
- [Element Context Menu](#) <sup>[1218]</sup>
- [Diagram Context Menu](#) <sup>[1220]</sup>
- [Operation Context Menu](#) <sup>[1221]</sup>

#### 6.1.5.1 Model (Root Node) Context Menu

The *Root Node* in the **Project Browser** is the *Model* element. You can have more than one model element.

The first level packages beneath the Model node are sometimes referred to as *Views* as they commonly divide a model into categories such as Use Case Model and Logical Model.

Right-click on the Root Node to display the **Model** context menu.

Menu Option & Function Keys	Use to
Add-In	Access the facilities of each Add-In currently enabled for the project.
Scripts	List the scripts enabled for execution directly from the <b>Project Browser</b> . (Does not display if no <b>Project Browser</b> scripts exist.)
Package Control	Display the <b>Package Control</b> <sup>[294]</sup> submenu.
Rename Model	Rename the current model.
New Model (root node)	Create a new model root.
New View	Create a new View (package).
Add a New Model using Wizard	Add further models using the <b>Model Wizard</b> <sup>[372]</sup> .
Copy Package to Clipboard	<b>Copy the selected package</b> <sup>[388]</sup> to the clipboard, to be copied into another package in the same .eap file or a different .eap file.
Paste Package from Clipboard	<b>Paste a package</b> <sup>[388]</sup> from the clipboard into the selected package.
Find in Project Browser [Ctrl]+[Shift]+[F]	Find a specified term in the <b>Project Browser</b> .
Expand Branch	Expand all items.
Collapse Branch	Collapse all items.
Import Model from XMI [Ctrl]+[Alt]+[I]	<b>Import a model</b> <sup>[288]</sup> from an XMI file.
Export Model to XMI [Ctrl]+[Alt]+[E]	<b>Export a model</b> <sup>[288]</sup> to XMI.
Rich Text Format (RTF) Report [F8]	<b>Produce RTF documentation</b> <sup>[1569]</sup> for the model.
HTML Report [Shift]+[F8]	<b>Produce HTML documentation</b> <sup>[1647]</sup> for the model.
Diagrams Only Report [Ctrl]+[Shift]+[F8]	Produce a <b>Diagrams Only</b> <sup>[1625]</sup> report (in RTF) for the model.
Copy Reference	Copy a reference to the root node to the Enterprise Architect clipboard. Select the appropriate sub-option to copy the: <ul style="list-style-type: none"> <li>selected package hierarchy structure (node path) or</li> <li>node GUID.</li> </ul>
Delete Project Root	Delete the Model node and all subordinate Views and packages.
Help	Display the Help topic for the <b>Project Browser</b> .

### 6.1.5.2 Package Menu

Right-click on a View or Package in the **Project Browser**. The context menu displays, providing the following options:

Menu Option & Function Keys	Use to
Add-In	Access the facilities of each Add-In currently enabled for the project.

Menu Option & Function Keys	Use to
<b>Scripts</b>	List the <a href="#">scripts</a> [1663] enabled for execution directly from the <b>Project Browser</b> . (Does not display if no <b>Project Browser</b> scripts exist.)
<b>Properties</b>	Add new packages to the model.
<b>Package Control</b>	Submit packages to <a href="#">package control</a> [294] and <a href="#">version control</a> [257].
<b>Add</b>	<a href="#">Add</a> [1218] a new diagram, element or another package to the current package.
<b>View Package As List</b>	Display the <a href="#">Element List</a> [1255], showing the elements contained in the selected package.
<b>Turn On Level Numbering (Turn Off Level Numbering)</b>	<p>Add a sequence number to each element in the package, based on the element's <a href="#">position in the package hierarchy</a> [923].</p> <p>For nested elements, the numbering indicates level; that is:</p> <p>3.2 3.2.1 3.2.1.1.</p> <p>This option is only available for packages, and the numbering only applies to the elements in the package, not diagrams.</p> <p>If elements are added, moved or deleted from the package, the numbering automatically adjusts.</p>
<b>Linked Document [Ctrl]+[Alt]+[D]</b>	Create or display a <a href="#">linked document</a> [597] for the package or view.
<b>Delete Linked Document</b>	Delete the linked document attached to the package. The system prompts you to confirm the deletion.
<b>Paste Diagram</b>	If you have copied a diagram from another package, paste the diagram into the currently-selected package.
<b>Documentation</b>	Produce a variety of reports and <a href="#">documentation</a> [1218] in RTF format.
<b>Code Engineering</b>	Perform <a href="#">Code Engineering</a> [1217] functions.
<b>Execution Analyzer</b>	Perform <a href="#">build, run</a> [1217] and execution analysis functions.
<b>Import/Export</b>	<a href="#">Import and export</a> [1218] using XML text files.
<b>Transform Current Package [Ctrl]+[Shift]+[H]</b>	Perform a <a href="#">model transformation</a> [1387] on the selected package.
<b>Contents</b>	Reorganize the package <a href="#">contents</a> [1218] after making changes.
<b>Bookmarks</b>	<a href="#">Bookmark</a> [347] all elements in the selected folder.
<b>Find in Project Browser [Ctrl]+[Shift]+[F]</b>	Search the <b>Project Browser</b> for specific elements.
<b>Copy Reference</b>	<p>Copy a reference to the package to the Enterprise Architect clipboard. Select the appropriate sub-option to copy the:</p> <ul style="list-style-type: none"> <li>• selected package hierarchy structure (node path) or</li> <li>• node GUID.</li> </ul>
<b>Copy Package to Clipboard</b>	<a href="#">Copy the selected package</a> [388] to the clipboard, to be copied into another package in the same .eap file or a different .eap file.

Menu Option & Function Keys	Use to
Paste Package from Clipboard	<a href="#">Paste a package</a> <sup>[388]</sup> from the clipboard into the selected package.
Paste Element(s) from Clipboard	<a href="#">Paste elements copied to the clipboard</a> <sup>[531]</sup> into the selected package.
Save Package as UML Profile	Save the selected package as a <a href="#">Profile</a> <sup>[906]</sup> .
Set View Icon	Change the display icon for the selected package (View level).
Move up	Move the package up in the list.
Move down	Move the package down the list.
Delete <packagename>	Delete the selected package and its contents.
Help	Display the Help topic for the <b>Project Browser</b> .

#### 6.1.5.2.1 Add Sub-Menu

In the **Project Browser**, right-click on a package and select the **Add** context menu option.

Menu Option & Function Keys
<a href="#">Add Diagram</a> <sup>[422]</sup>
<a href="#">Add Element</a> <sup>[524]</sup> [Ctrl]+[M]
<a href="#">Add Package</a> <sup>[387]</sup> [Ctrl]+[W]
<a href="#">Add a New Model using Wizard</a> <sup>[372]</sup>

#### 6.1.5.2.2 Documentation Sub-Menu

In the **Project Browser**, right-click on a package and select the **Documentation** context menu option.

Menu Option & Function Keys
<a href="#">Rich Text Format (RTF) Report</a> <sup>[1569]</sup> [F8]
<a href="#">HTML Report</a> <sup>[1647]</sup> [Shift]+[F8]
<a href="#">Diagrams Only Report</a> <sup>[1625]</sup> [Ctrl]+[Shift]+[F8]
<a href="#">Testing Report</a> <sup>[1550]</sup>
<a href="#">Open in Relationship Matrix</a> <sup>[1261]</sup>
<a href="#">RTF Report Options</a> <sup>[1573]</sup>
<a href="#">Copy RTF Bookmark</a> <sup>[1639]</sup>
<a href="#">Implementation Report</a> <sup>[1626]</sup>
<a href="#">Dependency Report</a> <sup>[1624]</sup>
<a href="#">Testing Details</a> <sup>[1549]</sup>

Menu Option & Function Keys
<a href="#">Resource Allocation</a> <sup>[318]</sup>
<a href="#">Package Metrics</a> <sup>[338]</sup>

### 6.1.5.2.3 Code Engineering Sub-Menu

In the **Project Browser**, right-click on a package and select the **Code Engineering** context menu option.

Menu Option & Function Keys
<a href="#">Generate Source Code</a> <sup>[1308]</sup> [Ctrl]+[Alt]+[K]
<a href="#">Import Source Directory</a> <sup>[1332]</sup> [Ctrl]+[Shift]+[U]
<a href="#">Import Binary Module</a> <sup>[1334]</sup>
<a href="#">Synchronize Package With Code</a> <sup>[1327]</sup> [Ctrl]+[Alt]+[M]
<a href="#">Generate DDL</a> <sup>[1369]</sup>
<a href="#">Import DB schema from ODBC</a> <sup>[1363]</sup>
<a href="#">Generate XML Schema</a> <sup>[1376]</sup>
<a href="#">Import XML Schema</a> <sup>[1373]</sup>
<a href="#">Generate WSDL</a> <sup>[1379]</sup>
<a href="#">Import WSDL</a> <sup>[1378]</sup>
<a href="#">Reset Options for this Package</a> <sup>[1361]</sup>
<a href="#">Reset DBMS Options</a> <sup>[1036]</sup>
<a href="#">Set as Namespace Root</a> <sup>[1313]</sup> <b>Clear Namespace Root</b>

### 6.1.5.2.4 Execution Analyzer Sub-Menu

In the **Project Browser**, right-click on a package and select the **Execution Analyzer** <sup>[1488]</sup> context menu option.

Menu Option & Function Keys
<a href="#">Package Build Scripts</a> <sup>[1426]</sup> [Shift]+[F12]
<a href="#">Build</a> <sup>[1444]</sup> [Ctrl]+[Shift]+[F12]
<a href="#">Test</a> <sup>[1483]</sup> [Ctrl]+[Alt]+[T]
<a href="#">Run</a> <sup>[1482]</sup> [Ctrl]+[Alt]+[N]
<a href="#">Deploy</a> <sup>[1484]</sup> [Ctrl]+[Shift]+[Alt]+[F12]
<a href="#">Debug</a> <sup>[1447]</sup> [F6]
<a href="#">Step Into</a> <sup>[1473]</sup> [Shift]+[F6]
<a href="#">Step Over</a> <sup>[1472]</sup> [Alt]+[F6]

Menu Option & Function Keys
<a href="#">Step Through</a> <sup>[1480]</sup>
<a href="#">Step Out</a> <sup>[1473]</sup> [Ctrl+[F6]
<a href="#">Stop Debugging</a> <sup>[1446]</sup> [Ctrl]+[Alt]+[F6]
<a href="#">Start Recording</a> <sup>[1505]</sup>
<a href="#">Stop Recording</a> <sup>[1505]</sup>
<a href="#">Create Diagram From History</a> <sup>[1507]</sup>
<a href="#">Create Diagram From Stack</a> <sup>[1480]</sup>

#### 6.1.5.2.5 Import/Export Sub-Menu

In the **Project Browser**, right-click on a package and select the **Import/Export** context menu option.

Menu Option & Function Keys
<a href="#">Import package</a> <sup>[290]</sup> from XMI file [Ctrl]+[Alt]+[I]
<a href="#">Export package</a> <sup>[289]</sup> to XMI file [Ctrl]+[Alt]+[E]
CSV <a href="#">Import</a> <sup>[305]</sup> / <a href="#">Export</a> <sup>[303]</sup>

#### 6.1.5.2.6 Contents Sub-Menu

In the **Project Browser**, right-click on a package and select the **Contents** context menu option.

Menu Option	Use to
<b>Expand Branch</b>	Expand all of the items in the <b>Project Browser</b> .
<b>Collapse Branch</b>	Collapse all of the items in the <b>Project Browser</b> .
<b>Reset Sort Order</b>	Return sorting of package contents to list in alphabetical order.
<b>Reload current package</b>	<a href="#">Refresh the current package</a> <sup>[267]</sup> in the <b>Project Browser</b> .

#### 6.1.5.3 Element Menu - Project Browser

Right-click on an *element* (such as Class, Object, Activity, State) in the **Project Browser** to display the element's context menu.

Menu Option & Function Keys	Use to
<b>Add-In</b>	Access the facilities of each Add-In currently enabled for the project.
<b>Scripts</b>	List the <a href="#">scripts</a> <sup>[1663]</sup> enabled for execution directly from the <b>Project Browser</b> . (Does not display if no <b>Project Browser</b> scripts exist.)
<b>Properties</b>	View and modify the element properties.
<b>Custom Properties</b> [Ctrl]+[Shift]+[Enter]	Customize the properties.

Menu Option & Function Keys	Use to
<b>Add</b>	<a href="#">Create</a> <sup>[1219]</sup> a child element and diagram (Classifier elements) or a connector to another element.
<b>Rule Composer</b>	For a Rule Task element, invoke the <a href="#">Rule Composer</a> <sup>[945]</sup> tab in Business Rule Modeling.
<b>Attributes</b>	Display the <a href="#">Attribute</a> dialog ready to create a new attribute.
<b>Operations</b>	Display the <a href="#">Operations</a> dialog ready to create a new operation.
<b>Create Workbench Instance [Ctrl]+[Shift]+[J]</b>	<a href="#">Create workbench variables</a> <sup>[1521]</sup> from the selected Class. When you select this option, Enterprise Architect prompts you to name the variable. It then displays in the <a href="#">Workbench</a> <sup>[1519]</sup> window.
<b>Generate Code [F11]</b>	Generate the source code for this element. See <a href="#">Generate Source Code</a> <sup>[1308]</sup>
<b>Synchronize with Code [F7]</b>	Synchronize the element in the diagram with the source code. See <a href="#">Import Source Code</a> <sup>[1328]</sup> .
<b>View Source Code [F12]</b>	<a href="#">View the source code</a> <sup>[1441]</sup> of the element.
<b>Open Source Directory [Ctrl]+[Alt]+[Y]</b>	Open the source directory.
<b>In Diagrams [Ctrl]+[U]</b>	Locate the element in all open diagrams.
<b>Locate in Current Diagram</b>	Select the element in the currently-visible diagram. If the element is not in the diagram, this option is grayed out.
<b>Copy RTF Bookmark</b>	Copy a <a href="#">bookmark</a> <sup>[1639]</sup> in RTF format to the clipboard.
<b>Linked Document [Ctrl]+[Alt]+[D]</b>	Create a Linked Document (Corporate, Business and Software Engineering, Systems Engineering and Ultimate editions). See the <a href="#">Linked Documents</a> <sup>[597]</sup> topic.
<b>Delete Linked Document</b>	Delete the linked document attached to the selected element.
<b>Add Custom Reference [Ctrl]+[J]</b>	Set up <a href="#">cross references</a> <sup>[527]</sup> between elements in a diagram and the selected element in the <a href="#">Project Browser</a> .
<b>Copy Element(s) to Clipboard</b>	<a href="#">Copy the selected element</a> <sup>[531]</sup> or elements to the clipboard to be pasted into another package in this .eap file or another .eap file.
<b>Copy Reference</b>	Copy a reference to the element to the Enterprise Architect clipboard. Select the appropriate sub-option to copy the: <ul style="list-style-type: none"> <li>selected element hierarchy structure (node path) or</li> <li>node GUID.</li> </ul>
<b>Move Up</b>	Move the element up in the list of elements within this package.
<b>Move Down</b>	Move the element down in the list of elements within this package.
<b>Delete '&lt;element Name&gt;'</b>	Delete the element.
<b>Help</b>	Display the Help topic for the <a href="#">Project Browser</a> .

### 6.1.5.3.1 Add Sub Menu

To display the **Add** submenu, either click on the element in the [Project Browser](#) and press **[Insert]**, or right-click on the element and select the **Add** context menu option.

The **Add** sub-menu enables you to:

- Add a Behavior element ([Activity](#)<sup>[753]</sup>, [Interaction](#)<sup>[780]</sup> or [State Machine](#)<sup>[796]</sup>) and one of its associated diagrams to the selected [Classifier](#)<sup>[519]</sup> element
- Add a [Rule Flow Activity](#)<sup>[939]</sup> element to a Class, in Business Rule Modeling
- Create a diagram to explain or expand on the selected Classifier element, using the [New Diagram](#)<sup>[422]</sup> dialog, or
- [Create a connector](#)<sup>[618]</sup> to another element.

Elements such as Actors, Classes and Activities can define a large amount of information that can be conveniently represented by or expanded in a child diagram. The **Add** sub-menu for these elements provides all of the options listed above.

Other elements, such as Timing, Exit and History have much more specific functions that do not require expansion. Therefore, the **Add** sub-menu for these elements only provides the option to create a connector to another element, and does not offer options for adding child elements and diagrams.

#### 6.1.5.4 Diagram Menu - Project Browser

Right-click on a diagram in the **Project Browser** to open the **Diagram** context menu. The example below illustrates the functions available from this menu.

Menu Option & Function Keys	Use to
<b>Add-In</b>	Access the facilities of each Add-In currently enabled for the project.
<b>Scripts</b>	List the <a href="#">scripts</a> <sup>[1663]</sup> enabled for execution directly from the <b>Project Browser</b> . (Does not display if no <b>Project Browser</b> scripts exist.)
<b>Properties [F5]</b>	View and modify a diagram's properties.
<b>Open</b>	Open the diagram in the <b>Diagram View</b> .
<b>View Diagram As List</b>	Display the <a href="#">Element List</a> <sup>[1255]</sup> , listing the elements in the selected diagram.
<b>Copy Diagram</b>	Copy the diagram for pasting into another location (see <a href="#">Copy a Diagram</a> <sup>[436]</sup> ).
<b>Copy RTF Bookmark</b>	Copy a <a href="#">bookmark</a> <sup>[1639]</sup> in RTF format to the clipboard.
<b>Add Custom Reference</b>	Add this diagram as a <a href="#">cross reference</a> <sup>[527]</sup> to other elements.
<b>Print Diagram(s)</b>	Print the currently-selected diagram or diagrams (hold <b>[Ctrl]</b> or <b>[Shift]</b> while selecting).
<b>Copy Reference</b>	Copy a reference to the diagram node to the Enterprise Architect clipboard. Select the appropriate sub-option to copy the: <ul style="list-style-type: none"> <li>• selected hierarchy structure (node path) or</li> <li>• node GUID.</li> </ul>
<b>Move up</b>	Move the diagram up in the list of diagrams within this package.
<b>Move down</b>	Move the diagram down in the list of diagrams within this package.
<b>Delete '&lt;diagram name&gt;'</b>	Delete the selected diagram.
<b>Delete selected items</b>	Delete several selected diagrams (hold <b>[Ctrl]</b> or <b>[Shift]</b> while selecting).
<b>Help</b>	Display the Help topic for the <b>Project Browser</b> .



### 6.1.5.5 Operation Menu - Project Browser

To display the **Operation** (or Method) context menu, right-click on an Operation in the **Project Browser**.

Menu Option & Function Keys	Use to
<b>Add-In</b>	Access the facilities of each Add-In currently enabled for the project.
<b>Scripts</b>	List the <a href="#">scripts</a> <sup>[1663]</sup> enabled for execution directly from the <b>Project Browser</b> . (Does not display if no <b>Project Browser</b> scripts exist.)
<b>Generate Code [F11]</b>	Generate code for the operation.
<b>Synchronize With Code [F7]</b>	Synchronize the operation with the code.
<b>View Source Code [F12]</b>	Open the <a href="#">Source Code Viewer</a> <sup>[1441]</sup> and display the operation.
<b>Operation Properties</b>	Display the <b>Properties</b> dialog for the operation.
<b>Copy Reference</b>	Copy a reference to the operation to the Enterprise Architect clipboard. Select the appropriate sub-option to copy the: <ul style="list-style-type: none"> <li>selected hierarchy structure (node path) or</li> <li>node GUID.</li> </ul>
<b>Delete Operation</b>	Delete the operation.
<b>Help</b>	Display the Help topic for the <b>Project Browser</b> .

You can display an equivalent context menu for an attribute by right-clicking on the attribute in the **Project Browser**.

## 6.2 Model Views

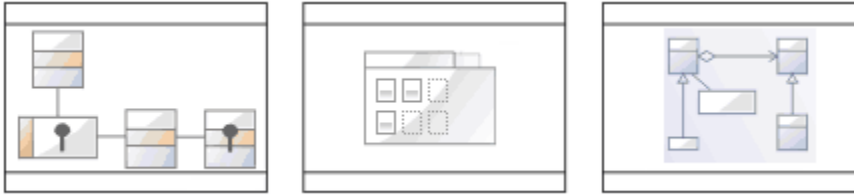

The **Model Views** window enables you to encapsulate your model into the areas you are interested in. You display the window by selecting the **View | Model Views** menu option.

### View Root Nodes

There are three types of View root-node available:

- *Model Views* - stored in the model and visible to all users; you can have many of these
- *My Views* - stored locally on your machine and visible only to you; you can have only one of these
- *Technology-defined Views* - read only; each View is stored with and [populated by](#)<sup>[1227]</sup> the corresponding active MDG Technology.

Additionally, there is a *Recent Discussions* folder that contains current correspondence from the [Team Review](#)<sup>[208]</sup> concerning items that are held in any of the Views. The folder has a separate repository of postings for each [team review server connection](#)<sup>[218]</sup> you access through the model. You can [control how recent](#)<sup>[1224]</sup> these postings must be, and how many are to be listed.

When you open the **Model Views** window for the first time on a project, a *Model Views* root section, *My Views* root section and *Recent Discussions* folder are added for you. These can not be deleted or renamed. However you can create further *Model View* root nodes which you can modify and delete.

### Subordinate Folders

Under the *My Views* root node you can add a single level of *View folders*, which enable you to group *Search View* folders as best suit your requirements.

- A Search View is a folder of elements or structures that you assemble by assigning a model search to the folder. When you double-click or expand the folder, the search runs and refreshes the folder contents. You can also set a search to refresh at a defined interval, and to [notify you if new results](#)<sup>[1228]</sup> are found.

Under a *Model View* root node you can create Views folders that can contain Search View folders, *Slideshow* folders and *Favorites* folders.

- A Slideshow folder contains diagrams only, which you can [display as a slide show](#)<sup>[1228]</sup> with diagrams being shown in the sequence in which they are listed in the folder. One folder represents one slide show. You can run the slide show automatically or manually; in either case the diagrams are closed after they have been displayed.
- A Favorites folder gives you easy access to commonly-used items in the **Project Browser**. To create hyperlinks in a Favorites folder to the required items in the **Project Browser**, drag items from the **Project Browser** into the Favorites folder.

You can also [export](#)<sup>[1227]</sup> all of the View folders containing Views from any root section as an XML file, and [import](#)<sup>[1227]</sup> a Views XML file as an additional, editable *Model View* root node.

#### Note:

These are single-level items; if you drag a package into the *Favorites* folder, you cannot expand that package there. To select specific items inside a package, expand it in the **Project Browser** and then drag the items into the *Favorites* folder.

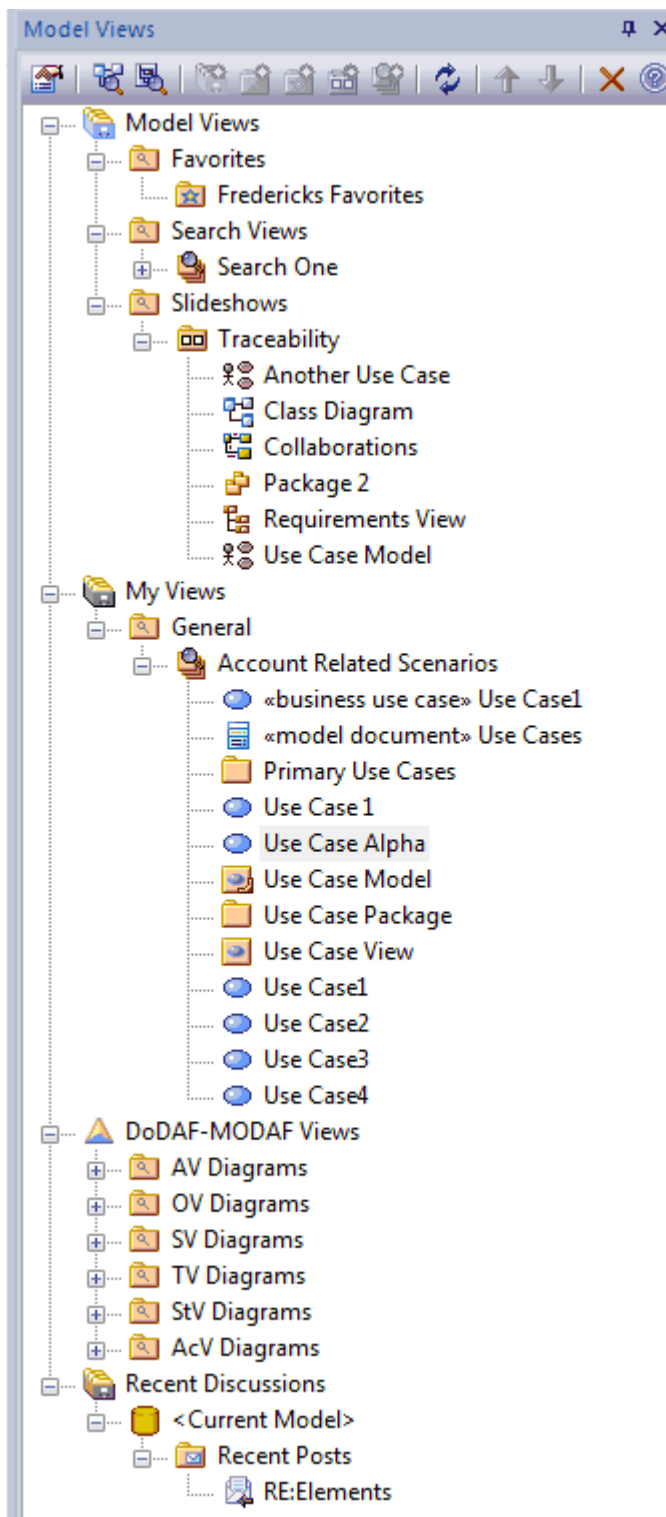

**Key to Model View Contents**

[Model Views toolbar](#) <sup>[1223]</sup>













- A Model View root node
- A View Folder
- A Favorites Folder
- A View (search-based)
- A Slideshow Folder
- The My Views root node
- The DoDAF-MODAF View (a Technology-defined View)
- The Recent Discussions folder
- A repository of postings from a selected team review, concerning elements in the Model Views
- The recent posts folder for the selected team review

Each level of the Model Views hierarchy has a slightly different [context menu](#). <sup>[1224]</sup>

**6.2.1 Model Views Toolbar**



The availability of the **Model Views** toolbar options depends on the type of object selected. The options are, from left to right:

-  Displays the appropriate **Properties** dialog for the item selected. Alternatively, double-click on the item, or press **[Enter]**.
-  Locates the selected object in any diagrams in which it has been used in the model, and either displays the single diagram with the object highlighted or lists the several diagrams in which the object has been located.
-  Locates and highlights the selected object in the **Project Browser**.
-  Creates a new *Model View* root node, and displays the **New Model View** dialog in which you enter the root node name.
-  Creates a new *Views* folder in the currently-selected root node.
-  Creates a new *Favorites* folder in the currently-selected *Views* folder.
-  Creates a new **Slideshow** <sup>[1228]</sup> folder in the currently-selected *Views* folder.
-  Creates a new *View* in the currently-selected *Views* folder, and displays the **Create New View** dialog to **define the search** <sup>[1228]</sup> that populates the *View*.
-  Refreshes the selected Model Views root node, folder, *View* or *Favorites*. For a *View*, this runs the Model Search defined in the *View properties*. <sup>[1226]</sup>
-  Moves the currently-selected object up or down **within its type**; you cannot move - for example - a package below a diagram, or a *View* above a *Favorites* folder.
-  Displays a prompt to confirm deletion of the selected object and - if appropriate - its contents. You cannot delete the original *Model Views*, *My Views* or *Recent Discussions* root nodes, or any technology-defined *Views*.
-  Displays Help on Model Views.

## 6.2.2 Model Views Context Menus

The **Model Views** window context menus display different options, depending on which level of the **Model Views** hierarchy you right-click on. The options are described below:

Menu Option	Use to
<b>Properties</b>	<p>Display the appropriate <b>Properties</b> dialog for the selected object. (Not the <i>My Views</i>, <i>Recent Discussions</i>, initial <i>Model Views</i> or <i>Technology-defined</i> root nodes.)</p> <p>You can edit any of the properties, if required. Changes to objects populated from the model are reflected in all other views (<b>Properties</b> window, diagrams, reports) of that object.</p> <p>The <b>Properties</b> option for the <i>Recent Posts</i> folder displays the <b>Recent Post Options</b> dialog, which enables you to specify the number of days back from which to extract postings from the <b>Team Review</b>, and the number of postings to list.</p> <p>The <b>Properties</b> option for a <i>Slideshow</i> folder displays the <b>Slideshow Properties</b> <sup>[1228]</sup> dialog, which enables you to automate the slide show and set the number of seconds for which each diagram is displayed.</p> <p>If you deselect the <b>Enable</b> checkbox, you must press <b>[Spacebar]</b> to display each diagram.</p>
<b>New Views Folder</b>	Display a prompt for the <i>Views folder</i> name and create the folder in the selected root node. (Root node only.)
<b>Import Views From XML</b> <sup>[1227]</sup>	Prompt for the XML file location and create a new <i>Model Views</i> node to hold the imported Views. (Root node only.)
<b>Export to XML (Views Only)</b> <sup>[1227]</sup>	Prompt for a file path and name, and copy all Views under the selected root node to an XML file at that location. (Root node only.)

Menu Option	Use to
<b>Remove Model View</b>	Display a prompt to delete the selected user-defined Model View and, if confirmed, delete the root node and all contents. (Not for the <i>My Views</i> , initial <i>Model Views</i> or <i>Technology-defined</i> root nodes.)
<b>New Search Folder</b>	Display the <b>Create New View</b> dialog (similar to the <b>View Properties</b> dialog) for you to <a href="#">define the search that populates the View</a> <sup>[1226]</sup> . (View folder only.)
<b>New Favorites Folder</b>	Display the <b>Create a new favorites based folder</b> dialog, which prompts for the folder name. (View folder only.)
<b>New Slideshow</b>	Display the <b>Create a new slideshow</b> <sup>[1228]</sup> dialog, in which you type the name of the slide show. You must use the <b>Properties</b> dialog to define the properties of the slide show. (Model View, View folder only)
<b>Open Search</b>	Display the <b>Model Search</b> tab in the main work area, listing the full results of the search and giving access to all the facilities of the <a href="#">Model Search</a> <sup>[1233]</sup> (View only). Alternatively, press <b>[Shift]+[Space]</b> .
<b>Refresh</b>	Refresh the search and open the View or Postings Repository to show the elements or Posts retrieved by the search. Alternatively, press <b>[Space]</b> .
<b>Double Click Opens Search</b>	Enable you to perform the Open Search function by double-clicking on the View. If you deselect this option, double-click refreshes the search and opens the View to show the elements retrieved by the search.
<b>Find Post</b>	Open the Project <b>Team Review</b> and highlight the selected post.
<b>Open Team Review</b>	Open the Project <b>Team Review</b> at the top level (Category).
<b>Edit Connections</b>	Display the <a href="#">Team Review Server Connections</a> <sup>[218]</sup> dialog, to select which review to open.
<b>Remove Folder</b>	Display a prompt to delete the selected Views folder and, if confirmed, delete the folder and all contents. (View folder only.)
<b>Remove View</b>	Display a prompt to delete the selected View and, if confirmed, delete the View and all contents.
<b>Remove Favorites</b>	Display a prompt to delete the selected Favorites folder and, if confirmed, delete the folder and all contents.
<b>Remove Slideshow</b>	Display a prompt to confirm deletion of the selected slide show and, if confirmed, delete the slide show and all its diagrams.
<b>Run Slideshow</b>	<a href="#">Run the slide show</a> <sup>[1228]</sup> in the <b>Diagram View</b> .
<b>Run Slideshow Full Screen</b>	<a href="#">Run the slide show</a> <sup>[1228]</sup> in full screen mode, so that the slide show fills the whole screen.
<b>Stop Slideshow</b>	<a href="#">Cancel execution of the slide show</a> <sup>[1228]</sup> running in the <b>Diagram View</b> . Alternatively, press <b>[Esc]</b> .
<b>In Project Browser</b>	Highlight the selected item in the <b>Project Browser</b> . (Element / Diagram / Package object only.)
<b>In Diagrams</b>	Locate the selected object in any diagrams in which it has been used in the model, and either display the single diagram with the object highlighted or list the several diagrams in which the object has been located.(Element / child Package object only.)
<b>Remove Linked</b>	Display a prompt to delete the selected object and, if confirmed, remove the object from

Menu Option	Use to
Item	<p>the folder. This has no effect on the object in the <b>Project Browser</b> or any diagrams. (Element / Diagram / Package object only.)</p> <p><b>Note:</b> You would not delete an object in a View, as it is replaced the next time the View is refreshed.</p>
Help	Display Help on Model Views.

### 6.2.3 Model Views Operations

#### Define View Search

When you:

- First create a View, the **Create New View** dialog displays
- Select to display the View properties, the **View Properties** dialog displays.

These two dialogs are identical. However, in the Corporate, Business and Software Engineering, Systems Engineering and Ultimate editions of Enterprise Architect, a [work flow](#)<sup>[342]</sup> feature is added to the dialogs (second illustration).

To create a view, select a defined search and optionally enter a search term.

Name:

Search:

Search Term:

To create a view, select a defined search and optionally enter a search term.

Name:

Search:

Search Term:

Refresh this search    Frequency:

Notify me when new results found

In the **Name** field, type a name for the View.

In the **Search** field, either:

- Click on the drop-down arrow and select an existing search from the lists, or
- Click on the [ ... ] (Browse) button to display the [Manage Searches](#)<sup>[1235]</sup> dialog, edit an existing search or define a new one, then **Close** the dialog and select that search name in the **Search** field.

**Note:**

For a custom SQL search statement, the statement should return the *guid* and *type* of the object found so that Enterprise Architect can search for the selected item in the **Project Browser**. For example:

```
SELECT ea_guid AS CLASSGUID, Object_Type AS CLASSTYPE, Name FROM t_object
```

If required, in the **Search Term** field type a specific value to search for.

If you are working with the Corporate or extended versions of Enterprise Architect, and you want the search to run automatically and refresh the results, select the **Refresh this search** checkbox. The **Frequency** field has three sections, for hours, minutes and seconds. Click on the appropriate section and use the up and down arrows at the end of the field to set the interval for refreshing the search results. You can also set the refresh to display a pop-up notification if the search results change. To do this, select the **Notify me when new results found** checkbox.

Click on the **OK** button. The View is created (or updated) in a collapsed state. When you expand the View, the search executes and populates the View.

## Display Recent Postings

If a new post is added to the **Team Review**, and that post refers to any **Model View** items, that post is also added automatically to the **Recent Discussions | <Connection> | Recent Posts** folder in the **Model View**. To open a post, double-click on the entry; the **Team Review** tab displays, showing the selected message. You can control how many posts are displayed, and for what period of time, using the **Model Views context menu** for the **Recent Discussions** folder.

## Move Objects Into Favorites

Drag any required package, diagram or element from the **Project Browser** into the required Favorites folder.

## Move Objects Between Views

Views and Favorites folders are fixed in the Views folder in which you create them, and you cannot move them. However, you can **copy** (by dragging) objects from any View into any Favorites folder, and **move** (by dragging) objects between any two Favorites folders.

## Use Objects From Model Views

To make use of the elements, diagrams and packages held in any View or Favorites folder, click on the item and drag it into a diagram or a **Team Review** posting. The item behaves in the same way as if you dragged it from the **Project Browser**.

## Export/Import Views

You export Views to create an XML file that you can:

- Import into another model as a user-created Model View or
- Call from an MDG Technology Selection (MTS) file to access the Technology-defined View provided by the active MDG Technology.

The export and import functions are available from the Model Views root-node context menus.

When you use the *export* function, it acts on the complete set of View folders in the selected My Views root node, Model Views root node, or user-generated root node. You cannot export individual Views, nor can you export Favorites folders. The function displays the **Save As** dialog, on which you browse for the directory location for the exported XML file, and specify the file name.

When you use the *import* function, it displays the **Select Import Filename** dialog on which you browse for the directory and XML file you want to import. The import creates a new Model View folder with the same name as the copied root node.

## Set Up a Technology-Defined View

To set up the Technology-defined View for an MDG Technology, you:

1. Create a user-generated Model View in Enterprise Architect while using the technology
2. Populate it with the required View folders and Views.
3. Export the Views from that Model View as an XML file to an appropriate location

4. [Create a call to the file from the technology's MTS file](#) <sup>[1133]</sup>.

Thereafter, any model for which the MDG Technology is active *automatically* displays those Views in a Technology-defined View.

## 6.2.4 Diagram Slide Show

The *Slide show* facility in the **Model Views** window enables you to:

- Create screen-based presentations of sets of diagrams
- Run a slide show manually
- Run a slide show automatically with each diagram displaying for a period that you define
- Display the slide show within the Enterprise Architect work area
- Display the slide show in full screen mode.

You create each slide show as a [folder](#) <sup>[1223]</sup> within a Views folder under a Model View node. When you run a slide show, it displays the diagrams in the folder in the sequence in which they are listed in the folder. After each diagram has been displayed, it is closed.

### Create a Slide Show

To create a slide show, follow the steps below.

1. Under a Model Views node, click on the Views folder to contain the slide show.
2. Either:
  - Right-click on the Views folder and select the **New Slideshow** context menu option or
  - Click on the **New Slideshow folder** icon in the **Model Views** toolbar.

The **Create a new slideshow folder** dialog displays.

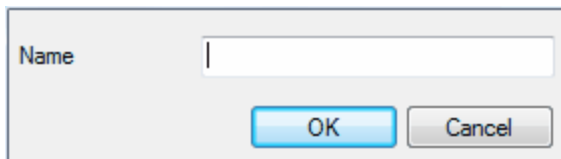

3. In the **Name** field, type the name of the slide show.
4. Click on the **OK** button. The new slide show folder is added to the selected View folder.
5. [Dock](#) <sup>[76]</sup> the **Project Browser** window separately from the **Model Views** window.
6. Drag the diagrams to be displayed as part of the slide show from the **Project Browser** into the new slide show folder. Organize the diagrams in the order in which they are to be displayed.

#### Note:

The diagram items in the slide show folder are links to the diagrams in the **Project Browser**, not copies of the diagrams or the diagrams themselves. Any actions you take in the slide show have no impact on the original diagrams.

7. Close the folder.

You can reorganize the diagrams in the slide show using the [up/down green arrows](#) <sup>[1223]</sup> in the **Model Views** toolbar.

To remove a diagram that is not required, right-click on it in the slide show folder and select the **Remove Linked Item** context menu option.

### Define Slide Show Operation

Slide show operation can be automated or manual. To define how the slide show is to operate, follow the steps below.

1. Right-click on the slide show folder. The context menu displays.
2. Select the **Properties** context menu option. The **Slideshow Properties** dialog displays.



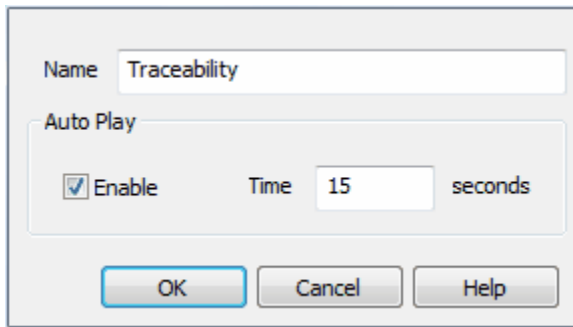

3. If you intend to automate the slide show, select the **Enable** checkbox. To run the slide show manually, deselect the checkbox.
4. If you intend to automate the slide show, in the **Time** field type the number of seconds that each diagram is to remain on display.
5. Click on the **OK** button.

### Run Slide Show







To run a slide show of diagrams, either in the **Diagram View** or full screen, follow the steps below:

1. Right-click on the slide show folder. The context menu displays.
2. Select either the:
  - **Run Slideshow** option, to run the slideshow in the **Diagram View**
  - **Run Slideshow Fullscreen** option to run the slideshow using the full screen.

The first diagram in the slide show displays.
3. If you have set up the slide show to run automatically, you can leave it to display the diagrams as defined. You can also moderate the slide show using manual commands.
4. If you are controlling the slide show manually, right-click on a slide. A small toolbar displays.



5. Control the slide show using the toolbar icons and other aids, as follows:

To:	Click On, or Press
Display the next slide	 [Spacebar] or [1]
Display the previous slide	 [←]
Display the first slide	 [↑]
Display the final slide	 [↓]
Pause the slide show	
Resume the slide show	

To:	Click On, or Press
Stop the slide show	 (In <b>Diagram View</b> ) right-click on the slide show folder and select the <b>Stop Slideshow</b> context menu option.

### Delete Slide Show

To delete a slide show, right-click on the slide show folder and select the **Remove Slideshow** context menu option. Enterprise Architect prompts you to confirm the deletion. The folder and its list of links to diagrams in the model is removed.

## 6.3 Model Search



The **Model Search** generates a report list that you can view in the main workspace. It lists each object in the **Project Browser** that meets the search criteria you specify within the search terms and search type.

For more information on conducting searches see the [Use the Model Search](#)<sup>[1233]</sup> topic.

When you have generated your search results, you can [print them or generate an RTF report](#)<sup>[1234]</sup> on them.

To access the **Model Search**:

- Select the **Edit | Model Search** menu option
- Click on a package in the **Project Browser** and press either **[Ctrl]+[Alt]+[A]** or **[Ctrl]+[F]**.

The **Model Search** tab displays.

Search Term:  Search:

Drag a column header here to group by that column.

Object	Type	Stereotype	Scope	Status	Phase	Created	Modified
Orders	Class	table	Public	Proposed	1.0	19/04/2007	21/08/2008
Fulfill Orders	Package		Public	Proposed	1.0	2/04/2008	21/08/2008
Order	Class		Public	Proposed	1.0	7/05/2007	21/08/2008
Orders	Package		Public	Proposed	1.0	9/02/2009	9/02/2009
Text	Text		Public	Proposed	1.0	10/01/2008	24/04/2009
<b>Notes:</b>							
Ordering is set by the Project View order rather than the element sequence in a diagram.							
The Element and Attribute order governs the Template and Package ordering respectively.							
Order	Object		Public	Proposed	1.0	13/02/2008	21/08/2008
<input checked="" type="checkbox"/> REQ034 - Crea...	Requirement	Functional	Public	Proposed	1.0	13/02/2008	21/08/2008
Fulfill Orders	Package		Public	Proposed	1.0	27/10/2008	27/10/2008
<input checked="" type="checkbox"/> REQ028 - Proc...	Requirement	Functional	Public	Proposed	1.0	27/10/2008	27/10/2008
OrderID	Object		Public	Proposed	1.0	27/10/2008	27/10/2008

### Sorting and Selecting

In the **Model Search** you can:

- Sort the items by any column value in ascending or descending order, by clicking on the column header
- Display element or diagram properties, by double-clicking on the item
- Select:
  - An element or diagram by clicking on it
  - Several individual elements or diagrams by holding **[Ctrl]** as you click on them
  - A range of elements or diagrams by holding **[Shift]** as you click on the first and last in the range
  - All elements or diagrams in the list by pressing **[Ctrl]+[A]**.

### The Options Button

The **Options** button displays the **Search Options** submenu, which enables you to display the search results as a tab of the **Output**<sup>[102]</sup> window<sup>[\*\*\*\*]</sup><sup>[102]</sup> rather than in the **Model Search** View. An advantage of moving the search results to the **Output** window is that you can select items from the search results and drag them onto a diagram, which you cannot do when the results are in the **Model Search** View. If you select the **Dock in**

**Output Bar** menu option, when you next display the menu this option becomes **Dock in Main View**.

The **Search Options** submenu also provides the means of performing [advanced searches](#)<sup>[1235]</sup> on your project, and displaying [project metrics](#)<sup>[338]</sup>. The arrow button to the right of the **Options** button also enables you to perform advanced searches.

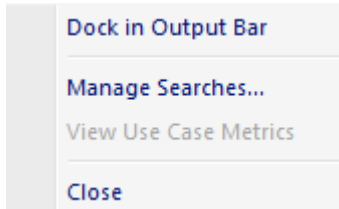

### The Toolbar

The **Model Search** toolbar enables you to quickly select a number of operations on the search list as a whole, or selected items.



The options are, from left to right:

- **Edit Notes ([Ctrl]+[Spacebar])** - For the selected item, opens the **Notes** window (if it is not already open) so that you can edit the text of the notes.
- **Delete ([Ctrl]+[D])** - For a selected item or group of items, deletes them from the model; refresh the project to check that the items have been deleted.
- **Print** - Prints the complete set of search results.
- **Rich Text Report** - For a selected item or group of items, generates and prints an RTF report.
- **View Notes** - Displays a short menu that enables you to select whether, for all items, to:
  - Hide any Notes text from display in the search results
  - Display the first few words of the Notes text in the search results
  - Display the full Notes text in the search results.
- **Help** - Displays the Enterprise Architect Help, starting with the **Model Search** Help topic.

### The View Header

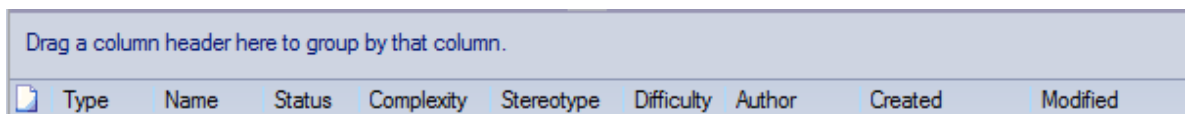

The View header defines the columns of information that are presented by the **Model Search**, and the order in which data items are presented. By right-clicking on the header you display the **Field Chooser** context menu option, which in turn displays the **Field Chooser** dialog. This enables you to add columns from the output. Between them, the View header and **Field Chooser** dialog show the full range of column headers available.

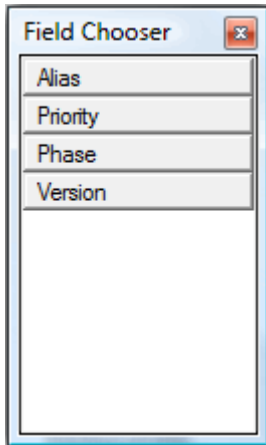

To *add* a column heading to the View header, drag it from the **Field Chooser** dialog onto the header, to the position you want the column of data to display. When you have selected the column headings you require, click on the red cross in the top right corner of the **Field Chooser** dialog to close it.

To *remove* a column from the output, drag the column heading downwards out of the View header. A black cross displays on the heading as you move it, and then both heading and cross disappear when you release the mouse button.

You can also change the sequence of columns, by dragging column headers left or right.

You can organize the reported data hierarchically according to the value of one or more of the column categories. For example, you could organize the data by *Type*, and within each *Type* by *Status*. If you then click on any of the other column headings, the data within this grouping is further sorted with the values of the selected column (for example, *Created*) in ascending or descending order.

To set up the hierarchical grouping, drag the column heading representing the primary grouping (such as *Type*) onto the **Drag a column header here to group by that column** field. Then drag the column heading for the next level of grouping (such as *Status*) to the right of the first heading. The two heading titles display as connected blocks, as shown below.



You can, if required, add further levels of grouping by dragging other column headings onto the hierarchy, and restructure the hierarchy by dragging existing or additional headings into the level you want them to hold. For example, you could make *Type* the secondary grouping by dragging it to the right of *Status*, or extend the hierarchy by dropping *Object* between *Type* and *Status*.

To remove a grouping level, drag the appropriate column heading out of the hierarchy and below the View header. Any subordinate groupings move up a level.

### 6.3.1 Use the Model Search

You perform searches within your project using the [Model Search](#)<sup>[1233]</sup>. You search the whole model, unless you have selected the **Current Tree Selection** option in the [search management panel](#)<sup>[1235]</sup>. In that case, you can search within a specific package selected from the [Project Browser](#).

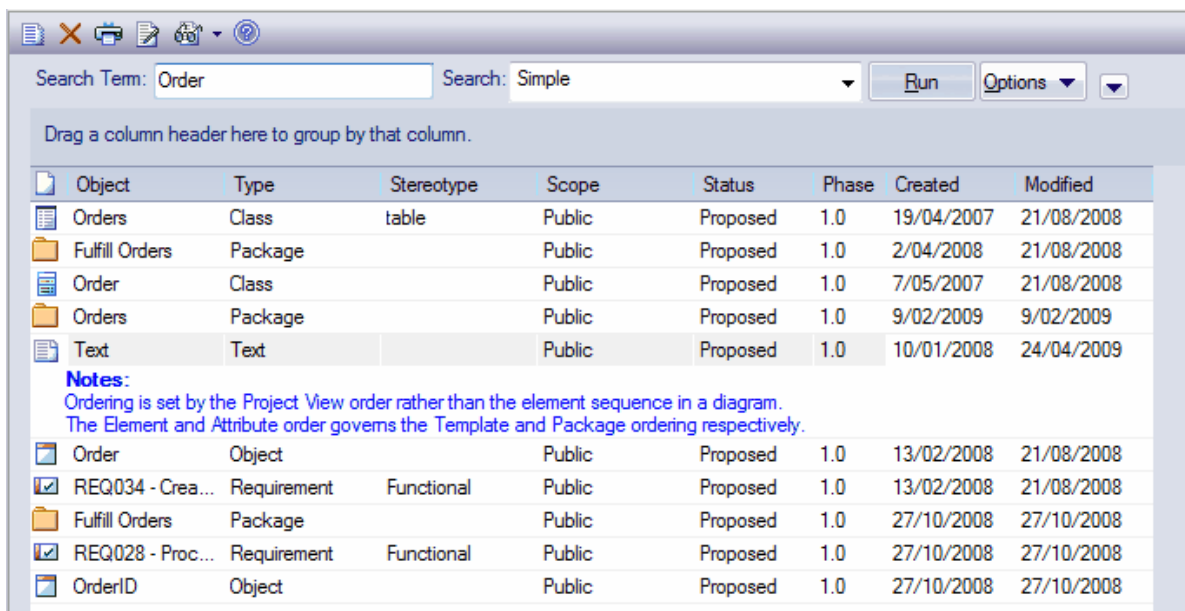

In the **Search Term** field type the text to search for, and in the **Search** field select the [type of search to perform](#) (the default being **Simple**). Click on the **Run** button to display your results.

You can perform more complex searches and create your own [search definitions](#). To begin these tasks:

1. Click on the arrow button to the right of the **Options** button. The [search manager panel](#) displays just above the search results panel.

### External Access to Model Search

You can access the **Model Search** facilities and perform specific searches indirectly, from Add-Ins, MDG Technologies, from a hyperlink and from a shortcut to access your model. This entails setting up a search profile either in the appropriate tool, or as an XML file accessed by the tool.

For information on performing a search from:	See
An MDG Technology Selection (MTS) File (using an <a href="#">exported search definition</a> )	<a href="#">Working With MTS Files</a>
A Login Shortcut	<a href="#">Shortcuts To .EAP Files</a>
An Add-In	<a href="#">Add-In Search</a>
A Hyperlink	<a href="#">Hyperlinks</a>

### 6.3.2 Work On Objects In Search

You can select elements or diagrams in the **Model Search** and perform various operations on them, as well as simply dragging the item into a [Team Review](#) post.

Right-click on the required object to display the following context menu:

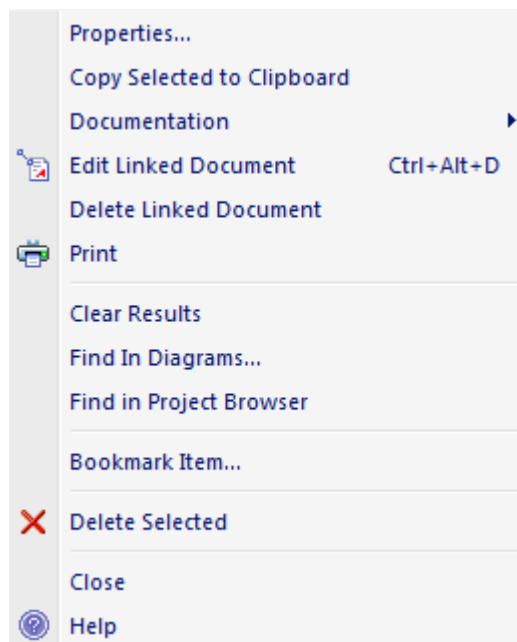

**Note:**

Not all options are available for a diagram.

Menu Option	Use to
Properties	Display the <b>Properties</b> dialog for the element.

Menu Option	Use to
<b>Copy Selected to Clipboard</b>	Copy the selected item to the MS Windows clipboard so that it can be pasted to a document, spreadsheet or email.
<b>Documentation</b>	<p>Generate an RTF report. You have two options:</p> <ul style="list-style-type: none"> <li>• Generate a separate report on each selected object in the <b>Model Search</b>.</li> <li>• Generate one report on all selected objects.</li> </ul> <p>In either case, the <a href="#">Generate RTF Documentation</a><sup>[1573]</sup> dialog displays.</p> <p><b>Note:</b></p> <p>If you generate the report using a custom SQL search, the <a href="#">SQL must include</a><sup>[1239]</sup> <code>ea_guid AS CLASSGUID</code> and the <i>object type</i>.</p>
<b>Create Linked Document [Ctrl]+[Alt]+[D] (Edit Linked Document)</b>	<p><a href="#">Create</a><sup>[599]</sup> (or <a href="#">edit</a><sup>[600]</sup>) a linked document (Corporate, Business and Software Engineering, Systems Engineering and Ultimate editions).</p> <p>See the <a href="#">Linked Documents</a><sup>[597]</sup> topic.</p>
<b>Delete Linked Document</b>	Delete an existing linked document. (Only displays if the element has a linked document.)
<b>Print</b>	Print out the filtered results.
<b>Clear Results</b>	Clear the search results from the <b>Model Search</b> .
<b>Find in Diagrams</b>	Display the diagram that uses the element or, if the element is used in multiple diagrams, display a list of diagrams to choose from.
<b>Find in Project Browser</b>	Highlight the element in the <b>Project Browser</b> .
<b>Bookmark Selected</b>	Bookmark the element.
<b>Delete Selected</b>	Delete the selected element from the <b>Model Search</b> .
<b>Close</b>	Close the <b>Model Search</b> .
<b>Help</b>	Display this Help topic on the <b>Model Search</b> .

### 6.3.3 Search Definitions

You provide search filters and create new search definitions using the search manager panel. To display this panel:

1. On the **Model Search** tab, click on the arrow button to the right of the [Options button](#)<sup>[1235]</sup>. The search manager panel displays underneath the **Search Term** and **Search** fields.

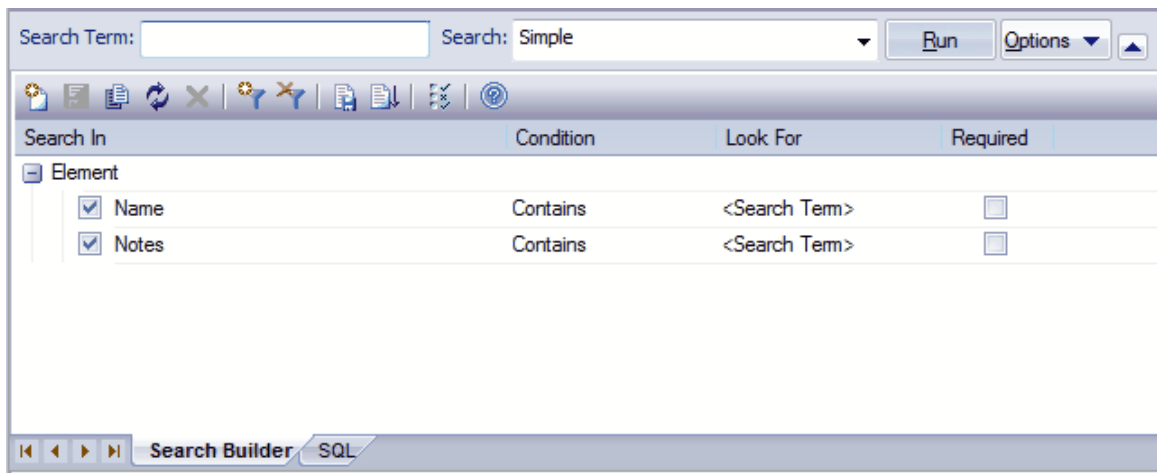

Search filters enable you to perform customized searches on a **Search Term** in order to locate model elements having specific characteristics. The **Search** drop-down list provides several [pre-defined searches](#) <sup>124</sup>

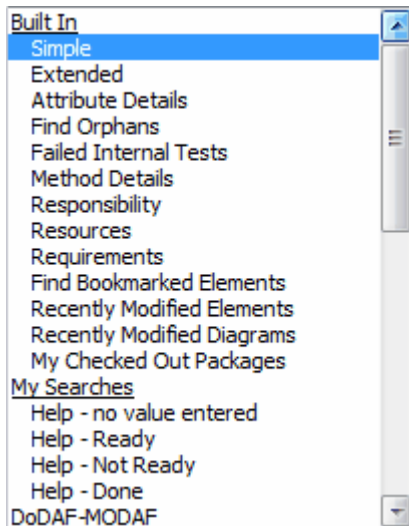

For ease of use, the list of available searches is separated into built-in searches, [user-defined searches](#) <sup>1239</sup> and Add-In searches.

The default is a **Simple** search, which searches all elements, looking at the **Name** and **Notes** fields only. If the search term is found in the **Name** field or the **Notes** field, those elements are displayed.

#### Important:

The fields listed in a search have an OR relationship when none of the **Required** checkboxes are ticked; that is, if the search term is found in any *one* of those fields, then the element is displayed.

If the search definition includes one field only, the **Required** checkbox must be selected, otherwise the search produces incorrect results.

In the Simple search below, the **Name** and **Notes** fields both have the **Required** checkbox ticked, so the two fields have an **AND** relationship. The search displays only those elements that contain the search term in both the **Name** and **Notes** fields.



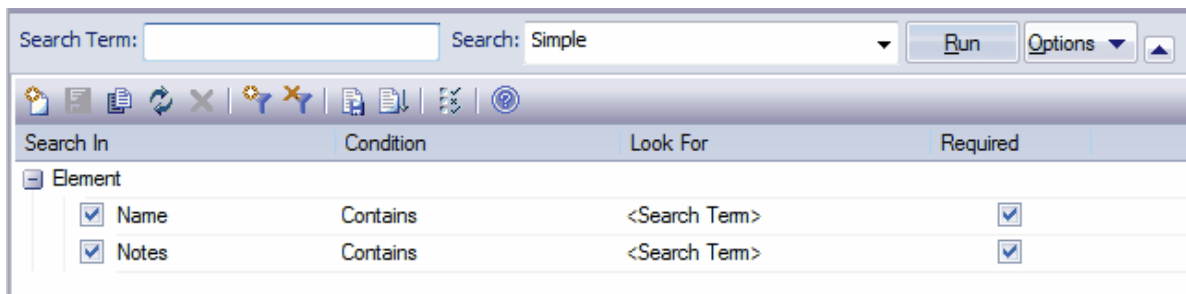

**Note:**

Any field having the **Required** checkbox ticked overrides fields where the **Required** checkbox is not ticked.

The following search finds elements that must have the search term in the **Name** field and that might or might not have the search term in the **Notes** field.

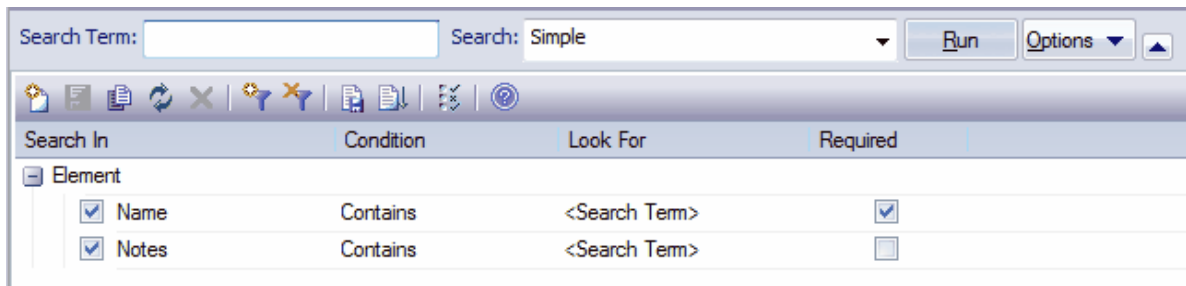



The search manager toolbar enables you to configure the system-provided searches, and to create and edit your own searches. The toolbar icons, from left to right, provide access to the following functions:

Option	Use to
<b>New Search</b>	Create a new search definition, with new search criteria. See <a href="#">Create Search Definitions</a>
<b>Save Search</b>	Save a modified or new search.
<b>Copy Search</b>	Copy the existing search selected in the <b>Search</b> field, to modify.
<b>Restore Default</b>	Restore any changed parameters to the default settings and format.
<b>Delete Search</b>	Delete the search definition from the <b>Search</b> drop-down list.
<b>Add Filter</b>	<a href="#">Add a new set</a> of parameters to filter the search on.
<b>Remove Filter</b>	Delete the selected filter from the search.
<b>Export Search</b>	Display a selection box that enables you to select searches to export to an external directory as an XML Search file.
<b>Import Search</b>	Display the Windows Directory Explorer <b>Open</b> dialog to enable you to import searches as XML Search files from an external directory.
<b>Search Options</b>	Display the <a href="#">Advanced Options</a> dialog, to define where the search should operate and how the search should match filters.  This icon is available only for searches created with the <a href="#">Query-Builder</a> , and not for those created with the <a href="#">SQL Editor</a> .

You use the main body of the search manager panel to configure the element search filters that are contained in the selected search. A filter item consists of the element field name (**Search In**), the conditions placed on the field value, the actual value or delimiting value to search on, and whether the filter item is required

(mandatory). The components are defined in greater detail in the following table:

Column	Use to
<b>Search In</b>	Select the type and name of each element feature to search on.
<b>Condition</b> 	Select the condition of the search parameter. The available options are <b>Contains</b> , <b>Equal To</b> , <b>Not Equals</b> and <b>One Of</b> .
<b>Look for</b> 	Specify the search term to perform the conditional search on. This value can pertain to the selected element type. For example, the value could be a date for <i>DateCreated</i> or a text value for other fields. The search term can contain multiple values, separated by commas.
<b>Required</b>	Indicate that the search results must include elements with your search term in that field.

You add the filters by clicking on the **Add Filter** toolbar icon, to display the **Add Filters**  dialog.

### 6.3.3.1 Advanced Search Options

When you click on the **Search Options** icon on the **Manage Searches** toolbar, the **Advanced Options** dialog displays.

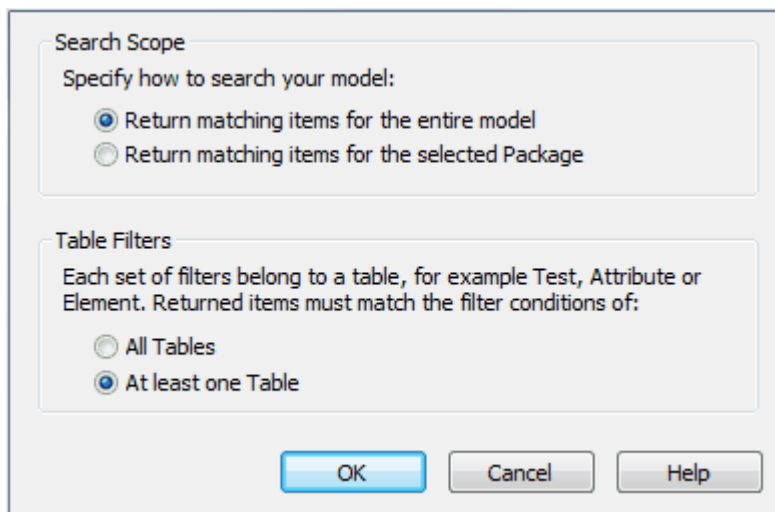

In the **Search Scope** panel, select either:

- **Return matching items for the entire model** - the default, to run the search across the entire model, or
- **Return matching items for the selected Package** - to run the search on a specific package, which you select in the **Project Browser**.

#### Note:

If you select **Return matching items for the selected Package**, navigating the **Project Browser** does not change your search results until you click on the **Run** button. That is, to search different areas of the project, click on the first required package in the **Project Browser** and click on the **Run** button, check the results, and then click on another package in the **Project Browser** and click on the **Run** button again.

In the **Table Filters** panel, select either:

- **All Tables** - to ensure that the search only retrieves elements that match every check in the search
- **At least one Table** - the default, to ensure that the search retrieves elements that match at least one of the checks in the search.

### 6.3.3.2 Create Search Definitions

[Search definitions](#) <sup>[1235]</sup> are created using the search manager panel. To display this panel:

1. On the **Model Search** tab, click on the arrow button to the right of the [Options button](#) <sup>[1235]</sup>. The search manager panel displays underneath the **Search Term** and **Search** fields.

To create a new search definition, follow the steps below:

1. Click on the **New Search** icon in the toolbar. The **Create New Search Query** dialog displays.

2. In the **Search Name** field, type a name for your new search.
3. Select the radio button for the type of search you require:
  - The [Query Builder](#) <sup>[1239]</sup> option provides an interface that enables you to design your own search.
  - The [SQL Editor](#) <sup>[1239]</sup> option enables advanced users to directly write SQL Select statements.
  - The [Add-In Search](#) <sup>[1241]</sup> option enables you to supply the name of your Add-In and a method (for example *MyAddin.RunThisMethod*). This method is called whenever the search is run. This search can be exported and distributed as a part of your Add-In. For more information, see [Enterprise Architect Add-In Model](#) <sup>[1776]</sup>.
4. Click on the **OK** button.

#### Note:

User-defined searches are stored in the Program Files directory, and not in the project repository.

### Query Builder

Your search definition now appears as being selected in the **Search** drop-down field. You can now click on the **Add Filter** toolbar icon to [Add Filters](#) <sup>[1242]</sup>.

Search In	Condition	Look For	Required

### SQL Editor

The **Custom SQL** dialog displays, enabling you to input your *SELECT* statement. The SQL editor is based on the common Code Editor, and provides an intellisense *autocomplete list* populated with Enterprise Architect's repository structure. You can display the autocomplete list by pressing **[Ctrl]+[Spacebar]**.

For more details on intellisense and the common Code Editor, see the [Code Editors](#) <sup>[1428]</sup> topic.

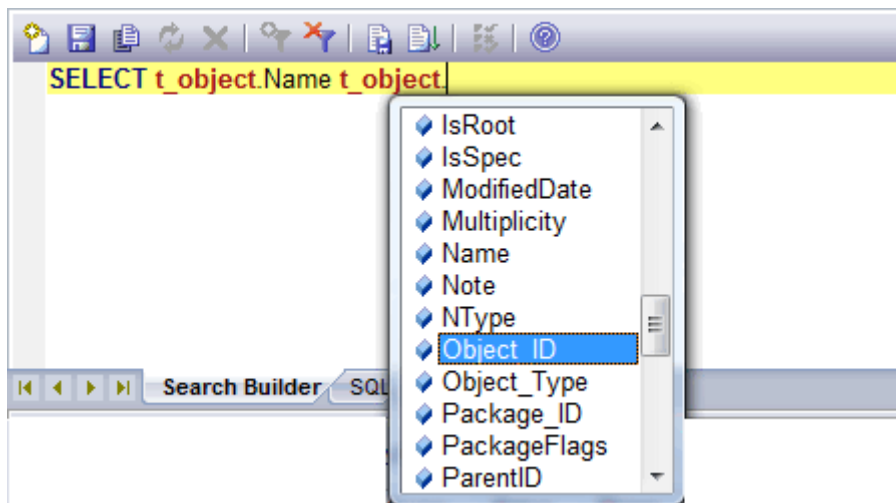

Enterprise Architect also enables you to use #xxx# macros as string replacers in WHERE statements, so that the same search can be used by different people in different environments. These macros include:

- #WC# - Gets the appropriate wild card for the current database, and so enables the search to be performed on models on different databases; for example, *t\_object.Name LIKE '#WC#Test#WC#'*
- #Author# - Takes the value of the **Author** field in the **Options** dialog **General** page, and enables the defined search to be performed on objects created by that user (this value can be manually re-set in the **Options** dialog)
- #DB=<DBNAME># where <DBNAME> can be one of the following:
  - MYSQL
  - JET
  - ORACLE
  - SQLSVR
  - ASA
  - OPENEDGE
  - POSTGRES.

For example, *#DB=ORACLE# t\_object.ModifiedDate >= (SYSDATE - INTERVAL '<Search Term>' DAY)*

- #UserName# - Gets the name of the person logged into version control; for example, *t\_package.PackageFlags LIKE '#WC#VCCFG=#WC#CheckedOutTo=#UserName##WC#'* (this is from Enterprise Architect's built in search *My Checked Out Packages*).

#### Note:

For all Enterprise Architect functions in which you use a custom SQL statement (such as RTF reporting or Model Views) the statement must return the *guid* and *type* of the object found so that Enterprise Architect can search for the selected item in the **Project Browser**. For example:

```
SELECT ea_guid AS CLASSGUID, Object_Type AS CLASSTYPE, Name FROM t_object
```

You can extend the usability of your SQL searches using the aliases *CLASSGUID* and *CLASSTYPE*. These enable Enterprise Architect to display the **Properties** dialog and icon for elements, connectors, attributes or operations, as well as selecting them in the **Project Browser**. Some simple examples for using these aliased fields are provided below:

```
SELECT ea_guid AS CLASSGUID, Object_Type AS CLASSTYPE, Name FROM t_object
```

```
SELECT ea_guid AS CLASSGUID, Connector_Type AS CLASSTYPE, Name FROM t_connector
```

```
SELECT ea_guid AS CLASSGUID, 'Operation' AS CLASSTYPE, Name FROM t_operation
```

```
SELECT ea_guid AS CLASSGUID, 'Attribute' AS CLASSTYPE, Name FROM t_attribute.
```

When you have defined the *SELECT* statement, click on the **Save** button to save this search. The search is

then available from the **Search** drop-down list.

### Add-In Search

Type in the field the name of your Add-In, a period (full stop) and then the name of the method to be called (for example, *MyAddin.RunThisMethod*). Your search is automatically saved and available from the **Search** drop-down list.

#### 6.3.3.3 Pre-defined Searches

The following pre-defined searches are provided with Enterprise Architect, and are listed in the *Built-In* category in the **Search** drop-down list.

- **Simple** - Searches the *Name*, *Alias* and *Notes* fields of all elements for the given **Search Term**.
- **Element Name** - Searches for an exact match against the element name, alias, method or operation; the default search in the [Search in Model](#) menu option.
- **Extended** - Searches many additional fields relating to the element, including *Attributes*, *Operations*, *Tagged Values* and *Test Cases*.
- **Attribute Details** - Searches for elements with attributes relating to the **Search Term**, including Tagged Values, constraints, and common attribute data fields.
- **Find Orphans** - Searches for orphaned elements throughout the model, with the ability to filter on common element fields using a **search term**. An 'orphaned' element is an element that does not appear on any diagram in the model.
- **Failed Internal Tests** - Searches for elements containing internal test cases where the **Search Term** is in any common *Test Case* field and the *Status* value is 'Fail'.
- **Method Details** - Searches for elements with operations and methods relating to the **Search Term**, including Tagged Values, constraints and common operation and method data fields.
- **Responsibility** - Searches for elements with internal responsibilities/requirements where the **Search Term** relates to any common *Responsibility/Requirement* field.
- **Resources** - Searches for elements with assigned resources where the search term relates to any common *Resource* field.
- **Requirements** - Searches for Requirement element types where the search term relates to any common element field.
- **Find Bookmarked Elements** - Searches for elements that have been bookmarked, anywhere in the project.
- **Recently Modified Elements** - Searches for elements that have been recently modified, anywhere in the project. The **Search Term** relates to any common element field. The default is to show elements modified in the last three days, but you can set an alternative interval by typing the appropriate number of days in the **Search Term** field.
- **Recently Modified Diagrams** - Searches for diagrams that have been recently modified, anywhere in the project. The **Search Term** relates to any common diagram properties field. The default is to show diagrams modified in the last three days, but you can set an alternative interval by typing the appropriate number of days in the **Search Term** field.
- **My Checked Out Packages** - Searches for packages that are marked as checked out by the currently-logged in user.

### 6.3.3.4 Add Filters

Click on the **Add Filter** icon in the [search manager panel](#)<sup>[1235]</sup> or the **Add Filter** button on the [Generate RTF Documentation](#)<sup>[1573]</sup> dialog. The **Add Filters** dialog displays.

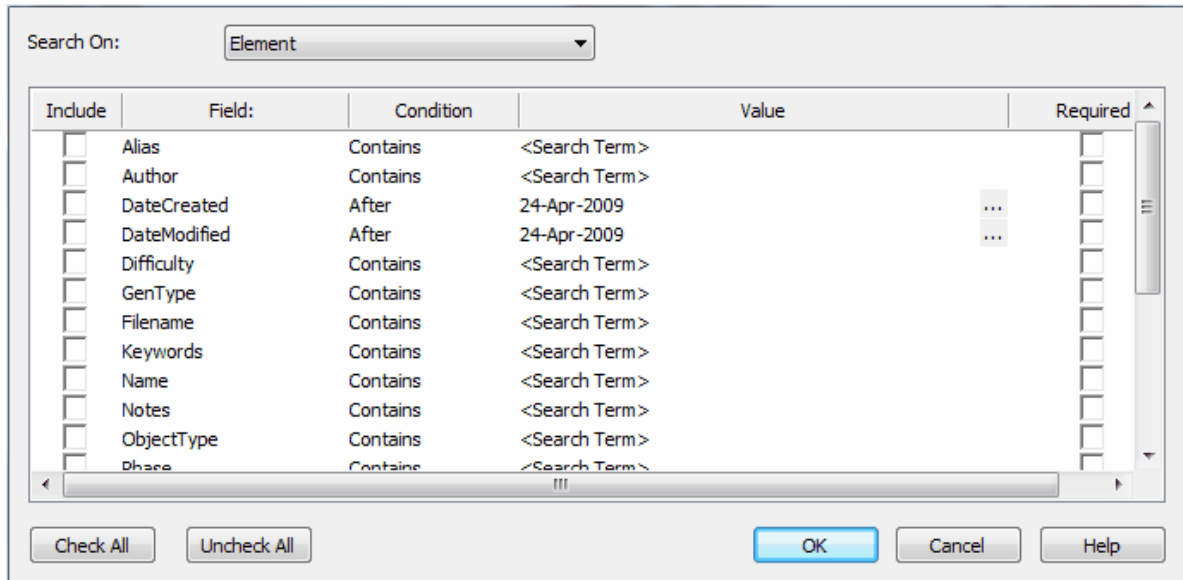

Option	Use to
<p><b>Search On</b></p>	<p>Select items to build up search filters on any information about an object.</p> <p>The following is a list of what is available, before you have defined a search.</p> <div data-bbox="475 1182 906 1787" style="border: 1px solid gray; padding: 5px;"> <ul style="list-style-type: none"> <li>Element</li> <li>Diagram</li> <li>Attribute</li> <li>Attribute.AttConstraint</li> <li>Attribute.AttTagValue</li> <li>Change</li> <li>Custom Property</li> <li>Constraint</li> <li>Method</li> <li>Method.MethodTagValue</li> <li>Method.Parameter</li> <li>Method.PostCondition</li> <li>Method.PreCondition</li> <li>Method.Parameter.ParamTagValue</li> <li>File</li> <li>Issue</li> <li>Defect</li> <li>Scenario</li> <li>TagValue</li> <li>Task</li> <li>Test</li> <li>Responsibility</li> <li>Resource</li> </ul> </div> <p>If you are adding filters to an existing search, the list contains only items appropriate to the initial filter. For example, if the initial filter is on diagram properties, the list for any subsequent filters for the search only contains the <b>Diagram</b> option.</p>
<p><b>Include</b></p>	<p>Select each field item to include in your search (select the checkbox).</p>
<p><b>Field</b></p>	<p>Identify the name of the field to search. See <a href="#">Fields and Conditions</a><sup>[1243]</sup>. The list presents items specific to the filter <i>Search On</i> item.</p>

Option	Use to
Condition	Specify the condition of the search parameter. See <a href="#">Fields and Conditions</a> <sup>[1243]</sup> .
Value	Type a value pertaining to the selected element field. For example, the value could be a date for <i>DateCreated</i> or a text value for other fields. The search term can contain multiple values separated by commas; see <a href="#">Fields and Conditions</a> <sup>[1243]</sup> .
Required	Select a particular field to generate a result set that <i>must</i> contain your search term in that field.
Check All	Select all the items to include them in the search definition.
Uncheck All	Deselect all the items to omit them from the search definition.
OK	Apply the filter. The fields selected are added to the search definition.

You can add multiple search definitions as necessary. Note that if you select the **Required** field in multiple definitions the search rapidly becomes impractical. Multiple search definitions are better for 'and/or' searches.

**See Also**

- [Create Search Definitions](#) <sup>[1239]</sup>

**6.3.3.4.1 Fields and Conditions**

When you click on a condition for a particular field, a selection of condition options becomes available, as shown in the following example:

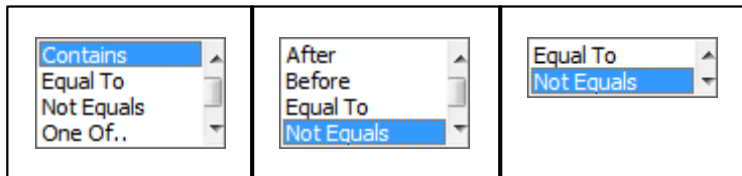

For some conditions, the value field contains an ellipsis (...). Click on this to display a selection dialog. Examples of selection dialogs are shown below.

**Example Selection dialog for *One Of* section**

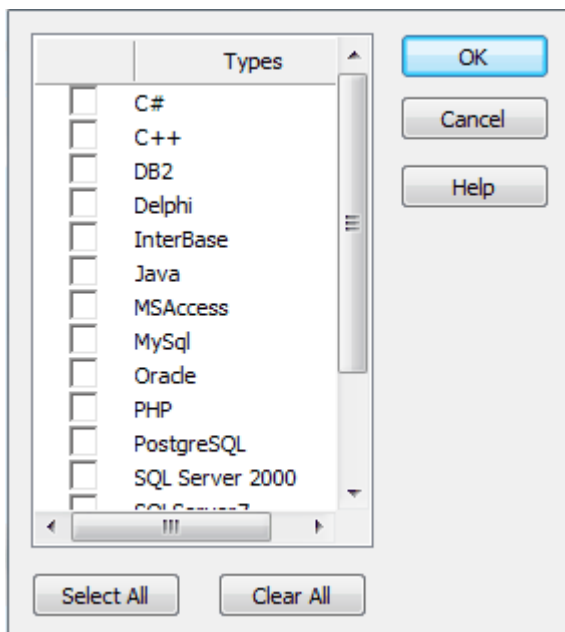

**Date Selection dialog for *Before* or *After* section**

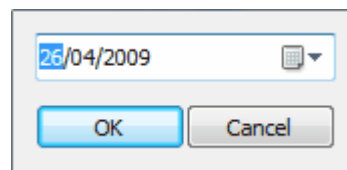

**Date selection from the drop-down**

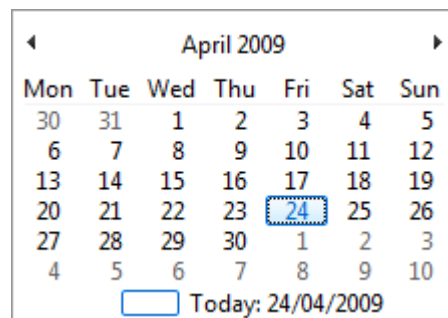

**See Also**

- [Create Search Definitions](#) 1239
- [Add Filters](#) 1242



## 6.4 Traceability

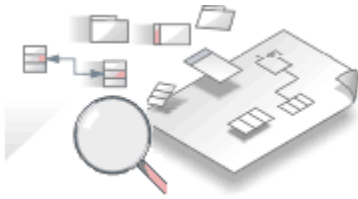

Traceability identifies the way a given process has been, or is to be, developed in a system. The process can be an internal, model-management process, where you monitor work by asking questions such as 'what work has been done to realize this Requirement or Use Case?', or a business or system process that is being modeled, where you ask questions such as 'what Requirements, Use Cases, Classes, Components, Test Cases and other elements define the implementation and deployment of this process?'

Traceability also helps to clarify the aspects of a process that the model does not address. A process typically includes a range of manual, automated and external procedures. A correctly-structured model illustrates exactly what requirements and functionality service a particular process; any missing functionality must come from other systems, developments or procedures.

There are various tools in Enterprise Architect that enable you to trace the definition and implementation of a process from initial requirement to generated code or technical deployment, or vice versa. If you have performed any [Transformations](#)<sup>[1385]</sup> in developing your model and code, Enterprise Architect automatically creates [Transformation Dependency](#)<sup>[1385]</sup> connectors that you can trace - with the [Traceability](#)<sup>[1253]</sup> window - to establish what objects and code have been generated from each PSM element, or what the initial PSM element was for a generated object. Whether you use transformations or develop the stages of the model in other ways, you can build up a range of [Traceability diagrams](#)<sup>[1250]</sup> (Custom diagrams) to identify the development pathway and the dependencies between entities such as Requirements, Use Cases, Classes, Packages, Test Cases and other model artefacts, or possibly between these entities and the overall [business process model](#)<sup>[933]</sup>.

### Maintaining Traceability

The following [Project Browser](#) hierarchy represents a model that is structured to enable traceability. Notice firstly that themes are developed in the structure - the Requirements Model, Use Case Model and Abstract Implementation Model each contain units with the same functional names, such as *Manage Users* and *Manage Inventory*. These units help you to quickly develop a *Traceability Model* within your project, to trace development and implementation.

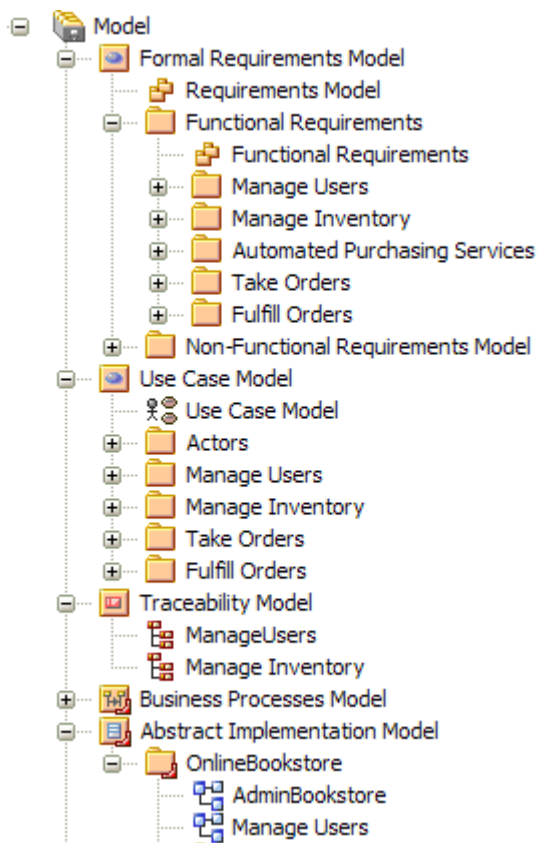

Traceability in this model is examined further in the following topics:

- [Packages and Elements](#) <sup>[1246]</sup>
- [Create Traceability Diagrams](#) <sup>[1250]</sup>
- [Traceability Tools](#) <sup>[1251]</sup>

### 6.4.1 Packages and Elements

Analyzing the requirements of a system or process helps you identify units of functional activity in that system or process. You can represent these units with Packages, which you then populate with elements of relevance to the functional units and to the stage of development.

In the following four diagrams, you can see how Requirements and Use Case Packages are created to group the Requirements elements and Use Case elements that define and start to implement each of several functional areas. By maintaining the same structure in each model in the project (as discussed in the [Traceability](#) <sup>[1245]</sup> topic), you also make it easy to trace the project development through the stages.

Requirement Packages for Online Bookstore Process

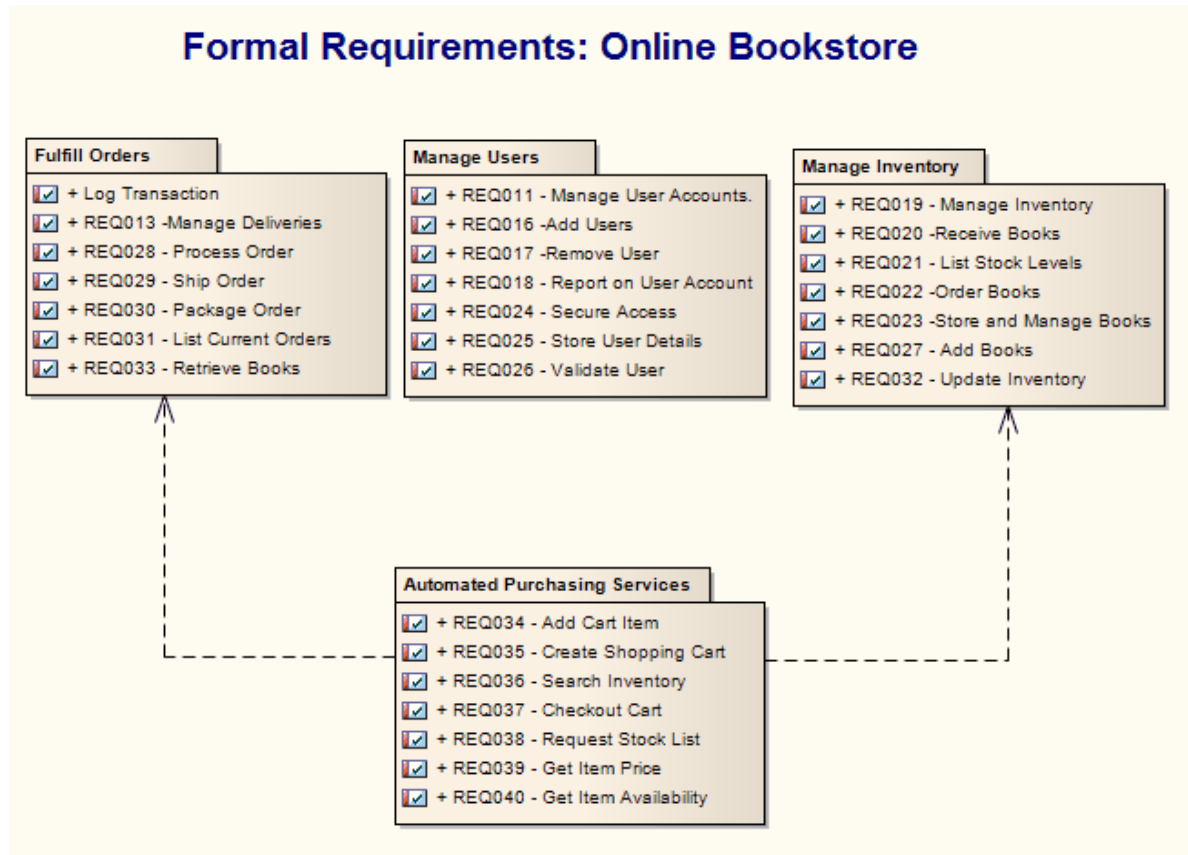

Requirements in Manage Users Unit of Online Bookstore Process

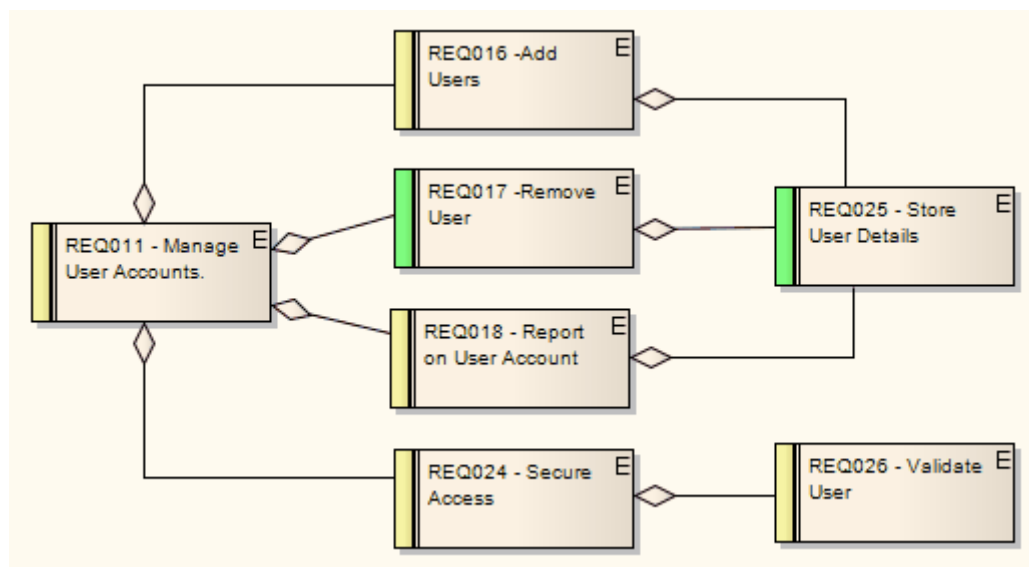

The Requirements diagram also makes it clear what Requirements form subsets of others, or are components of more than one other Requirement.

## Use Case Packages For Online Bookstore Process

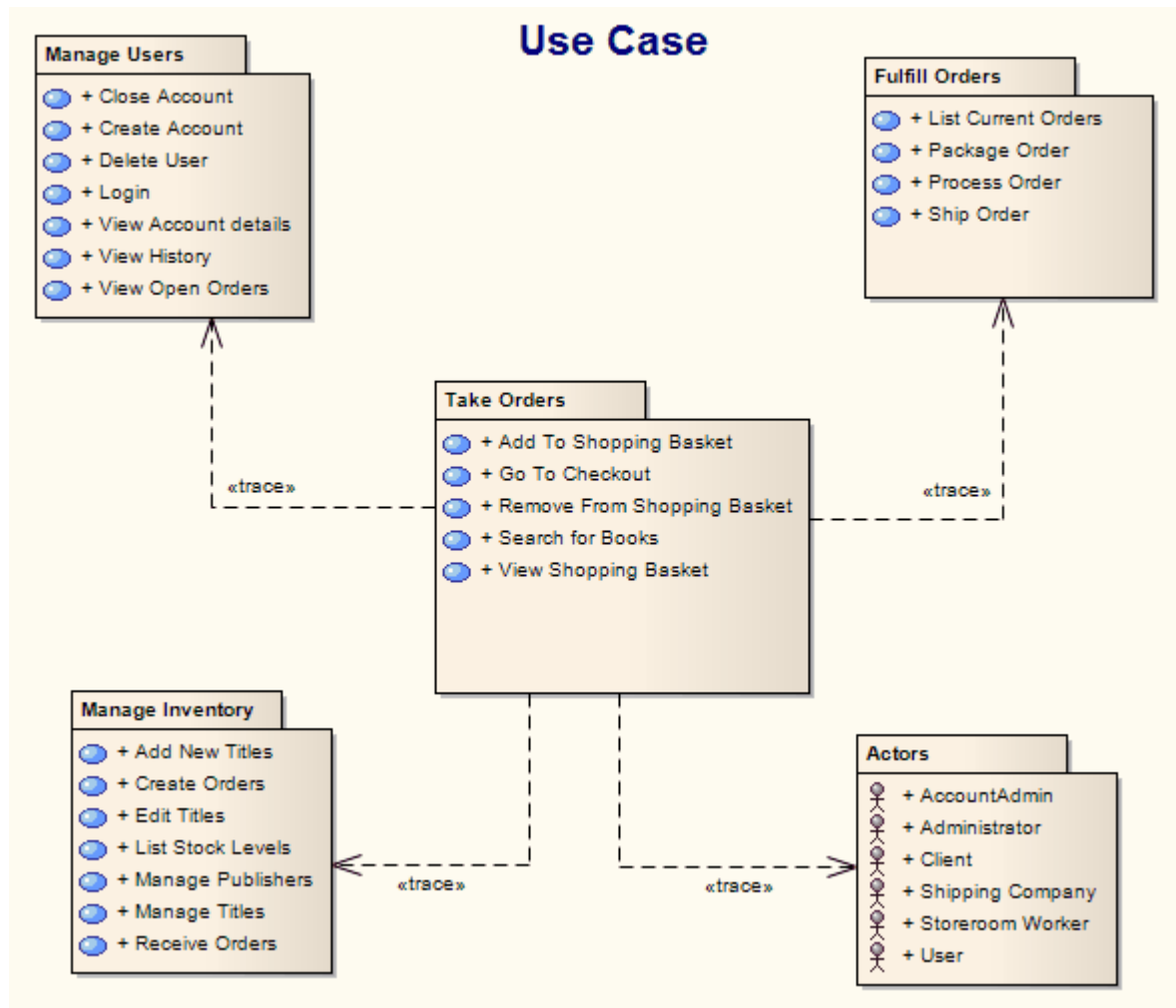

### Use Cases in Manage Users Unit of Online Bookstore Process

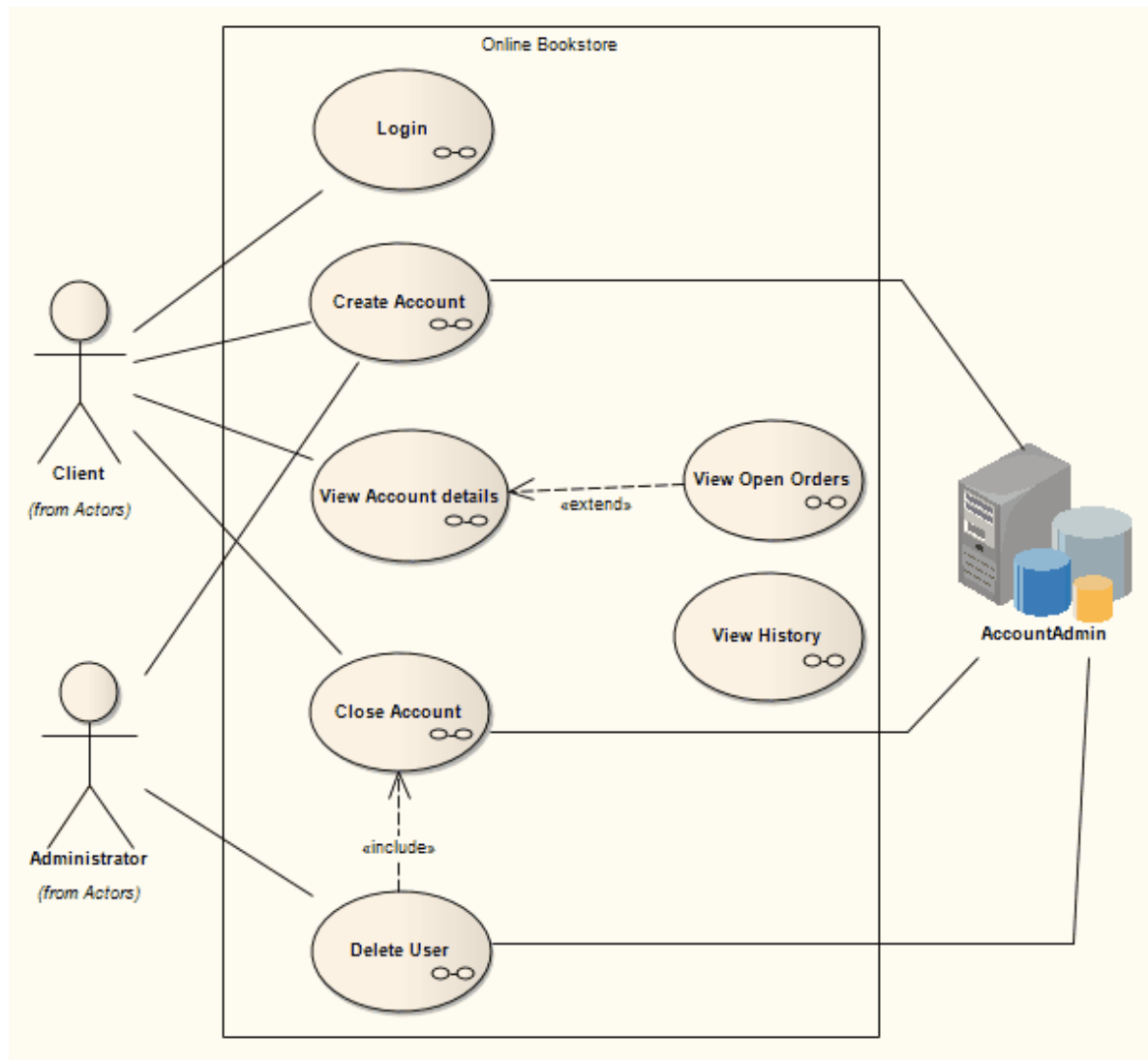

The Use Case diagrams can also clarify what aspects of a process require or enable human intervention, and which require or enable system intervention.

#### Implementation Stage

For completeness, you could also consider the next stage, the implementation of some of these Use Cases, as represented by Class elements associated with this functional unit.

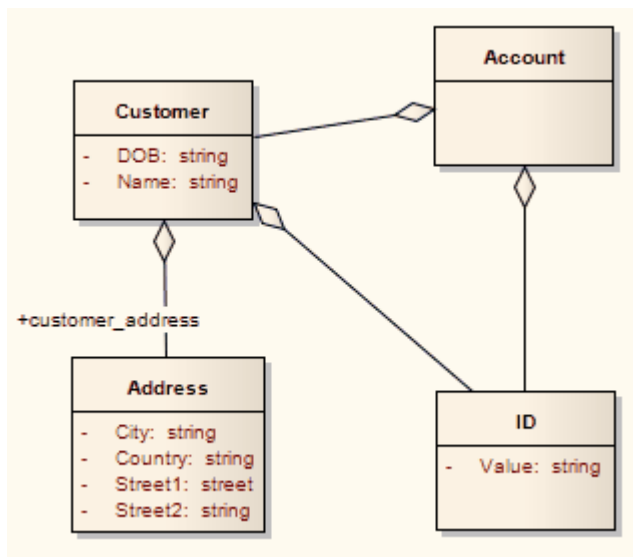

## 6.4.2 Create Traceability Diagrams

Having structured the models of a project to indicate directions and theoretical relationships between the models and packages, you can formalize these directions on a *Traceability* diagram, using [Realize](#)<sup>[889]</sup>, [Trace](#)<sup>[892]</sup> and similar relationships.

You initially create a Traceability diagram as a [Custom](#)<sup>[734]</sup> diagram, but if you are creating the diagram manually you can use elements and relationships from other [Toolbox](#) pages to develop the diagram as broadly as is necessary.

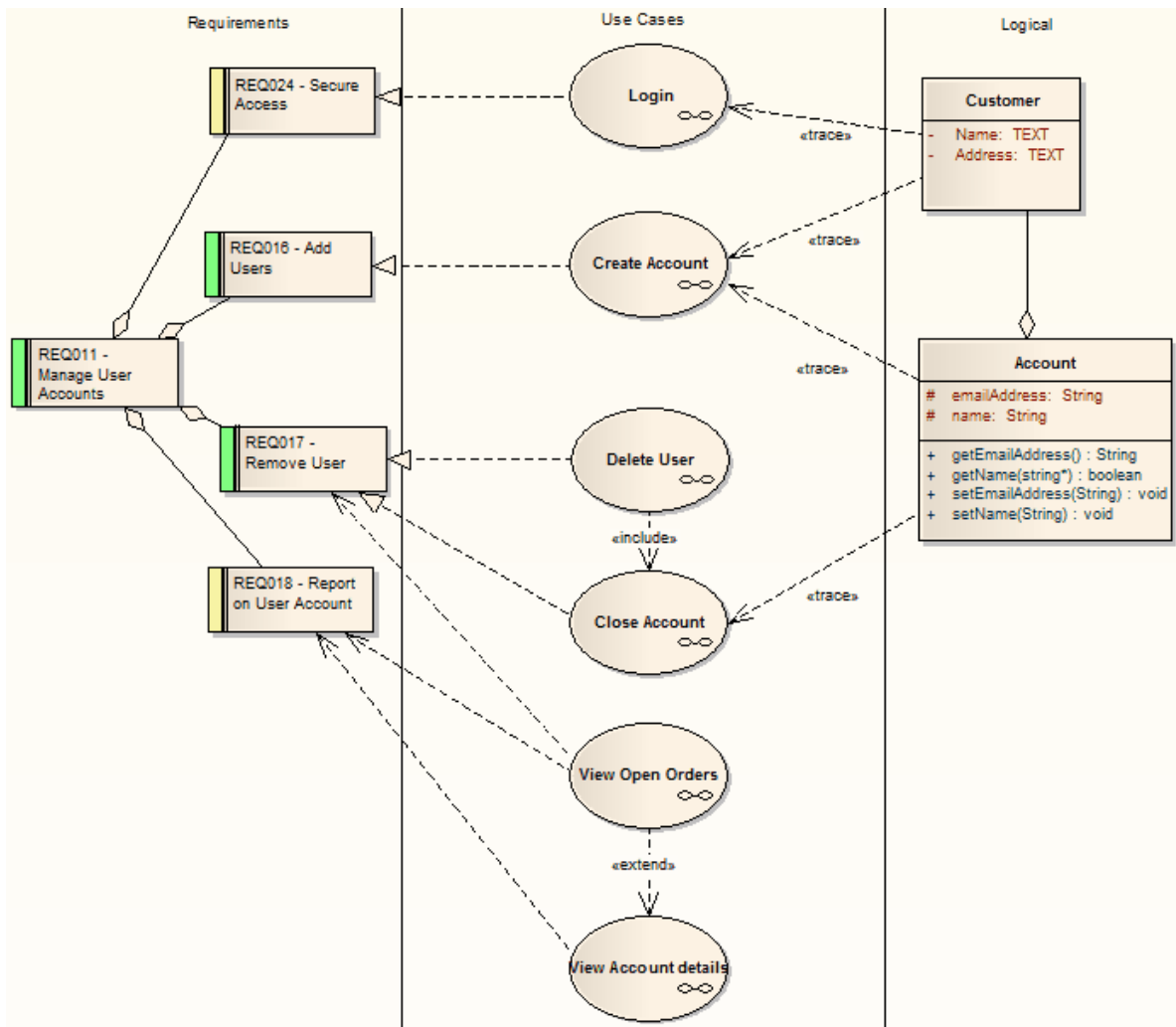

You can also generate the diagram using the **Add | Related Elements context menu option** <sup>[55]</sup> to automatically bring in elements linked to the selected element. It is probably better to add the elements in stages, one level at a time, but you could add several levels in one go to see how far the hierarchy extends and to identify relationship and element types to exclude from the 'clean' diagram. You could perform a similar operation, one element at a time, using the **Relationships** <sup>[126]</sup> window.

The above diagram instantly shows how two levels of Requirements are realized by Use Cases, and which Requirement is realized by which Use Case(s). It also shows how some of the Use Cases are implemented by Class elements. Further, you can drill down on the Use Cases (or, in other Traceability diagrams, any other composite elements) to display more detailed diagrams showing how the Use Case meets the Requirement. The *Close Account* Use Case, for example, contains a Communication diagram and a Sequence diagram.

You can tailor your Traceability diagrams to depict any level of granularity and any stages of development that are appropriate. You might narrow the above diagram, for example, to show development from just the *Remove User* Requirement, and extend it to include Interfaces, Components, Test Case elements or any other facet of the system or process.

Whilst the Traceability diagram itself provides information on the definition, design and implementation of a business process feature, much more information can be obtained using **tools** <sup>[125]</sup> such as the **Relationships Matrix** and relationships **Traceability** window.

### 6.4.3 Traceability Tools

The **model structure** <sup>[124]</sup> and **Traceability diagram** <sup>[125]</sup> act as starting points for tracing the definition, design and implementation of a feature of a system or process. By applying tools such as the **Relationship Matrix** and **Traceability** window to these, you can follow threads throughout the model to determine how the feature is implemented and tested. You can also obtain information on what elements realize and are realized by the elements in a given package, using the **Dependency report** <sup>[162]</sup> and **Implementation report** <sup>[162]</sup>, respectively.

## Traceability Window

The [Traceability](#) <sup>[1253]</sup> window is a most useful and versatile traceability tool. Starting with a Traceability diagram or a package structure in the [Project Browser](#), you can use the [Traceability](#) window to quickly explore the relationship chain of which any element is a component. When you click on the element, it immediately becomes the top point in the [Traceability](#) window. When you click on the background of a diagram, all elements in the diagram are listed in the [Traceability](#) window, and you can follow the threads starting at each element through the diagram.

If you require a rapid, broad-brush view of relationship flows in the project structure, starting with a general list of - say - all functional Requirements, you can use a combination of [Model Search](#) <sup>[1237]</sup>, [Project Browser](#) and [Traceability](#) window; this is a powerful tool for scanning your project, identifying how elements have been organized, and how they interact. For example, the [Model Search](#) would list all the requirements, you could rapidly click on each element and immediately see in the [Project Browser](#) where it has been grouped, and at the same time - in the [Traceability](#) window - how that element interacts with other elements in the model.

You can select any or all of the relationship types available in the [Traceability](#) window toolbox. The single type selected below is *Realizes* (Implements), and the selected element is the *Delete User* Use Case. The [Traceability](#) window then shows that *Delete User* implements *REQ017*, but this is also partially realized by the *Close Account* Use Case.

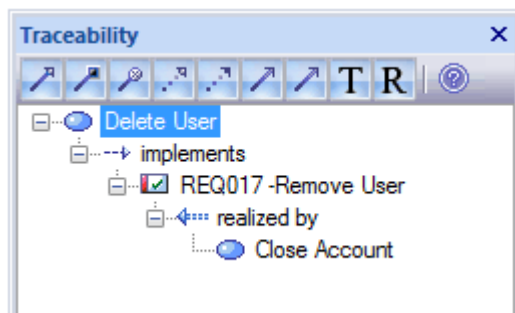

By moving the cursor around a diagram or the [Project Browser](#), and/or changing the relationship type combinations in the [Traceability](#) window, you can quickly see how elements are connected and how they influence each other. For example, you can see that *REQ017* is realized by two Use Cases, so you might then explore what else influences and is influenced by these two Use Cases. The [Traceability](#) window takes you well beyond what is likely to be depicted on any single diagram.

If you have used transformations to develop your model, the **T** icon displays the transformation dependencies that exist between an element in a PIM and elements in the PSMs.

## Relationship Matrix

Using the [Relationship Matrix](#) <sup>[1267]</sup>, you can both create and study the relationships between, for example, the Requirements and Use Cases for a module. You might identify the 'theme' package (in this case, *Manage Users*) in the Requirements model and the Use Case model as the source and target packages, and explore the likely element and connector types in the packages. This, like the Traceability diagram, identifies which Requirements are (or should be) realized by which Use Cases. You can then perform similar checks with the *Manage Users* packages in, say, the Use Case and Implementation models.

The **Source** and **Target** field browsers ([ ... ]) enable you to examine child packages within the 'theme' package, and obtain further detail on how the feature at this stage is defined.



Source: Manage Users ... Type: UseCase Link Type: Realisation Profile: ...  
 Target: Manage Users ... Type: <All> Direction: Source -> Target Refresh Options

	REQ011 - Manage User Accounts.	REQ016 - Add Users	REQ017 - Remove User	REQ018 - Report on User Account	REQ024 - Secure Access	REQ025 - Store User Details	REQ026 - Validate User
Close Account			↑				
Create Account		↑				↑	
Delete User			↑				
Login					↑	↑	
View Account details				↑			
View History							
View Open Orders				↑			

### Other Tools

You can also obtain information on what elements realize and are realized by the elements in a given package, using the [Dependency report](#)<sup>[1624]</sup> and [Implementation report](#)<sup>[1626]</sup>, respectively.

You can trace how a Class or Interface element in a diagram or the **Project Browser** is implemented in code or, for tables, in DDL, using the [Source Code viewer](#)<sup>[1441]</sup>. For code, as you click on features in the element, the corresponding code is highlighted in the viewer.

From the perspective of model management or project management, you could also use the [Audit View](#)<sup>[270]</sup> as a means of tracing the change history of a package or element. The **Relationship Matrix** also assists in this respect, indicating the impact of changes in one element on others. A Use Case exists because it defines how a Requirement is met; if the Requirement is changed, the Use Case and its dependent diagrams and elements should probably be changed, if not deleted.

### 6.4.4 The Traceability Window

Access: **View | Traceability**.

The **Traceability** window shows a mini picture of the composition of the current element with respect to other elements.

This information is derived from relationships with child or related Classes. Relationships shown in the hierarchy include Aggregation, Inheritance and Dependency; embedded elements are also shown. This helps extend the picture of where an element exists in the model space.

Display of each type of relationship is optional, and can be toggled using the window toolbar. Roll the cursor over each toolbar icon to display the types of relationship that the icon filters. For example, **T** filters the hierarchy to display [Transformation Dependencies](#)<sup>[1385]</sup>, and **R** filters for [Custom References](#)<sup>[527]</sup>.

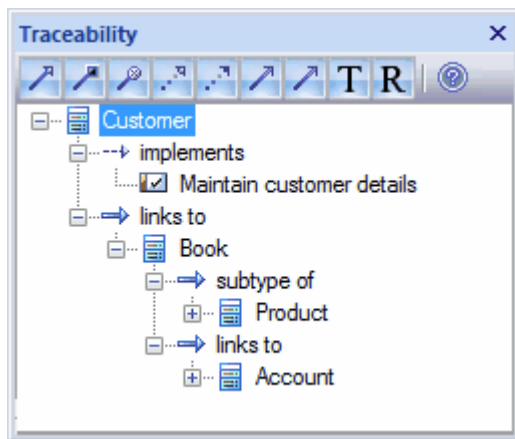

If you open a diagram and click on the diagram background, the **Traceability** window lists all the elements in the diagram. As above, you can expand the display for each individual element to show the relationships and related elements for that element. This is useful, especially in large and complex diagrams, for exposing threads through the diagram and indicating what might be impacted by changing or deleting the element or a connector.

## 6.5 Element List

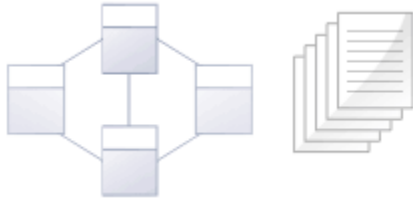

The **Element List** is a tabular, editable view of elements that can be displayed in the main workspace. You can use the **Element List** to streamline the process of creating and updating elements in a package or diagram selected from the **Project Browser**. This can be particularly useful for analysts to create and maintain formal requirement definitions within the model. You can also [print the list or generate an RTF document](#)<sup>[1259]</sup> directly from the entries on the **Element List**.

To access the **Element List**, either:

- Select a diagram or package in the **Project Browser** and select the **View | Element List** main menu option
- Select a diagram or package in the **Project Browser** and press **[Ctrl]+[Alt]+[R]**
- Right-click on a diagram or package in the **Project Browser** and select the **View Diagram As List** or **View Package As List** menu option
- Right-click on the background of an open diagram and select the **Switch to List View** context menu option

The **Element List** tab displays, showing the element information for the selected package or diagram. There are two possible formats that you can switch between using the **Show Hierarchy** button () in the toolbar:

- *User-Defined* format - as shown below, where you determine how the element information is structured on the screen, using the [value-grouping](#)<sup>[1258]</sup> band below the toolbar

Element List:: Development Model\Old State

All

Type Status

Name	Complexity	Stereotype	Difficulty	Author	Created	Modified
<b>Type: Class</b>						
<b>Status: Approved</b>						
Any2	Easy	XSDany		Frederick Walter	26/04/2007	10/07/2009
Enumeration1	Medium	enumeration		Frederick Walter	26/04/2007	21/08/2008
AttGrp1	Easy	XSDattributeGroup		Frederick Walter	26/04/2007	10/07/2009
ComplexType1	Easy	XSDcomplexType		Frederick Walter	26/04/2007	10/07/2009
<b>Status: Implemented</b>						
Class2	Easy			The Administrator	7/03/2008	10/07/2009
Class7	Easy			The Administrator	7/03/2008	10/07/2009
<b>Status: Proposed</b>						
Grp1	Easy	XSDgroup		Frederick Walter	26/04/2007	21/08/2008
GlobalAtt1	Easy	XSDtopLevelAttrib...		Frederick Walter	26/04/2007	21/08/2008
MdlGrp1	Easy	XSDsequence		Frederick Walter	26/04/2007	21/08/2008
Union1	Easy	XSDunion		Frederick Walter	26/04/2007	21/08/2008
SimpleType1	Easy	XSDsimpleType		Frederick Walter	26/04/2007	21/08/2008
GlobalEl1	Easy	XSDtopLevelElem...		Frederick Walter	26/04/2007	21/08/2008
<b>Type: Event</b>						
<b>Status: Proposed</b>						
Trigger 3	Easy			Frederick Walter	24/04/2007	21/08/2008
Trigger 2	Easy			Frederick Walter	24/04/2007	21/08/2008

- *Model Hierarchy* format - as shown below, where the package and element hierarchies are represented in the display.

Element List:: Development Model\Old State

All

Name	Type	Status	Stereotype	Author	Complexity	Difficulty	Created	Modified
Schema1	Package	Proposed	XSDschema	Frederick Walter	Easy		26/04/2007	21/08/2008
Sales	Package	Proposed		Suzanne Pearson	Easy		9/02/2009	9/02/2009
Dispatch	Package	Proposed		Suzanne Pearson	Easy		9/02/2009	9/02/2009
State9	State	Proposed		Frederick Walter	Easy		23/04/2007	9/02/2009
State10	State	Proposed		Frederick Walter	Easy		23/04/2007	10/03/2009
Orders	Package	Proposed		Suzanne Pearson	Easy		9/02/2009	9/02/2009
Trigger1	Trigger	Proposed		Frederick Walter	Easy		15/05/2007	9/02/2009
Actor1	Actor	Proposed		The Administrator	Easy		7/03/2008	21/08/2008
Actor D	Actor	Proposed	case worker	Frederick Walter	Easy		24/05/2007	21/08/2008
Class2	Class	Implemented		The Administrator	Easy		7/03/2008	10/07/2009
Class7	Class	Implemented		The Administrator	Easy		7/03/2008	10/07/2009

In the **Element List** you can:

- Sort the items by any column value in ascending or descending order, by clicking on the column header; initially the elements are listed in numerical order (if level numbering is turned on in the **Project Browser**) or alphabetical order within type

- In *User Defined* format, change the filtered structure of the information in the list; see [Value Grouping](#)<sup>[1258]</sup>, below
- Change the sequence of columns, by dragging column headers left or right

**Note:**

In *Model Hierarchy* format, the **Name** column is always on the left; you cannot move any other column into that position, although you can rearrange the order of the rest of the columns. Because of this, if you group or sort information in *User Defined* format and switch to *Model Hierarchy* format your information structure is altered, and it is not restored when you switch back to *User Defined* format.

- Display the **Properties** dialog for an item by double-clicking on the item entry
- Select:
  - an element by clicking on it
  - a specific value by clicking twice on it (not double-clicking); either the value becomes directly editable or the **Properties** dialog displays in which you can edit the value
  - several individual elements by holding **[Ctrl]** as you click on them
  - a range of elements by holding **[Shift]** as you click on the first and last in the range.
- Add new items to the *package* covered by the **Element List**, by clicking on a listed element and pressing **[Ctrl]+[N]** or **[Insert]**, or right-clicking and selecting the **Add New** context menu option
  - in *Model Hierarchy* format, new elements are inserted in the order in which they appear in the **Project Browser**
  - in *User Defined* format, new items are inserted to comply with any sort order and/or grouping; if the list is not sorted or grouped, the items are added to the end.
- In *Model Hierarchy* format, you can add a child element to the selected element by pressing **[Esc]** and then **[Ctrl]+[N]**; otherwise, elements are added as siblings of the selected element

**Note:**

You can add child elements only when the whole row is selected, with none of the row cells or fields highlighted. Press **[Esc]** to remove selection from an individual cell.

- Automatically add elements to a *diagram* by generating the **Element List** on the diagram and adding elements to the list
- Delete elements from the list by selecting the item and pressing **[Ctrl]+[D]**.

**Note:**

In *Model Hierarchy* format, you cannot delete a parent element until all its child elements have been removed or deleted.

You can also [include each element's notes](#)<sup>[1259]</sup> (documentation), which are shown underneath the element. You can add or edit notes by clicking on the item and pressing **[Ctrl]+[Space]**. This transfers control to the **Notes** window, in which you create or edit the note text.

If it is necessary to review the element's custom (advanced) properties, click on the item and press **[Ctrl]+[Enter]**. This displays the **Custom Properties** dialog for the element.

You can do further work on the **Element List** using the toolbar and context menu [options](#)<sup>[1258]</sup>.

## The View Header

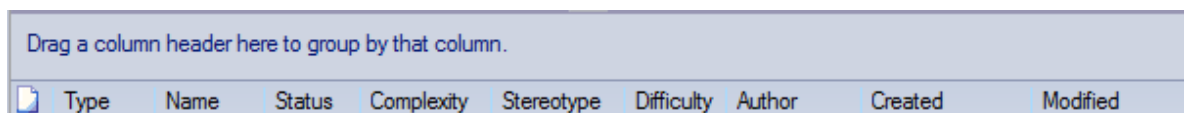

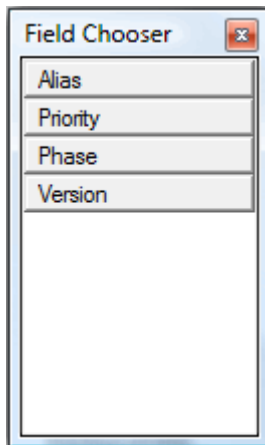

The View header defines the columns of information that are presented by the **Element List**, and the order in which data items are presented. By right-clicking on the header you display the **Field Chooser** context menu option, which in turn displays the **Field Chooser** dialog. This enables you to add or remove columns from the output. Between them, the View header and **Field Chooser** dialog show the full range of column headers available.

To *add* a column heading to the View header, drag it from the **Field Chooser** dialog onto the header, to the position you want the column of data to display. When you have selected the column headings you require, click on the red cross in the top right corner of the **Field Chooser** dialog to close it. If you want to *remove* a column from the output, drag the column heading to below the View header.

You can also change the sequence of columns, by dragging column headers left or right.

## Value Grouping

You can organize the reported data according to the value of one or more of the column categories. As in the illustration at the start of this topic, you might organize the data by *Type*, and within each *Type* by *Name*. If you then click on any of the other column headings, the data within this grouping is further sorted with the values of the selected column (for example, *Created*) in ascending or descending order.

To set up the value grouping, drag the column heading representing the primary grouping (such as *Type*) onto the **Drag a column header here to group by that column** field. Then drag the column heading for the next level of grouping (such as *Name*) to the right of the first heading. The two heading titles display as connected blocks, as shown below.









You can, if required, add further levels of grouping by dragging other column headings onto the hierarchy (such as *Status*), and restructure the order by dragging existing or additional headings into the level you want them to hold. For example, you could make *Type* the secondary grouping by dragging it to the right of *Name*, or drop *Status* between *Type* and *Name*.





To remove a grouping level, drag the appropriate column heading out of the sequence and below the View header. Any subordinate groupings move up a level.

## 6.5.1 Element List Options

### Toolbar Options

You can also add to or influence what information is displayed on the **Element List** by clicking on the following icons in the toolbar to:

-  - [add a new element](#)<sup>[524]</sup> to the diagram and/or package (**[Ctrl]+[N]**)
-  - display the **Notes** window, to add or edit notes for the selected element (**[Ctrl]+[Space]**)
-  - delete the selected element (**[Ctrl]+[D]**)
-  - print the current contents of the **Element List**
-  - display the **Generate RTF Documentation** dialog, to [create an RTF report](#)<sup>[1573]</sup> on the selected element (s)
-  - select the appropriate element type from a list (click on the drop-down arrow), or **All** to list all objects; the report then lists only elements of that specific type
-  - select a UML, Extended or MDG **Toolbox** category to specify the category of elements shown in the filter list (above)

-  - toggle between including child packages and their contents in the list, and showing only the first-level contents of the selected diagram or package
-  - toggle the display between model hierarchy format and user-defined [value-grouping](#) format
-  - display a short menu from which you can select to hide the contents of the Notes compartment of each element, display the first few words, or display the full text.
-  - display Help on the **Element List**.

### Audit History

In the Corporate, Business and Software Engineering, Systems Engineering and Ultimate editions of Enterprise Architect, if [Auditing](#) is turned on and the **Element List** is open, you can view a history of changes to any selected element or connector, in the [Audit History](#) tab of the [Output](#) window. (If security is enabled, you must have at least [Audit View](#) permissions to display the audit history).

### Work on Elements in the Element List

You can also use the context menu to perform operations on elements in the **Element List**. Right-click on the required element to display the context menu. The menu options are described below:

Menu Option & Function Keys	Use to
<b>Properties</b>	Display the <b>Properties</b> dialog for the selected element.
<b>Edit Notes</b> [Ctrl] +[Space]	Add or edit notes on the element, in the <b>Notes</b> window.
<b>Add New</b>	If the <b>Filter List</b> field in the toolbar is set to <b>All</b> , display the <b>New Element</b> dialog, through which you create an element of the required type.  If the <b>Filter List</b> field is set to a specific element type, this option adds an element of that type to the package or diagram in the <b>Element List</b> , the <b>Project Browser</b> and the <b>Diagram View</b> .
<b>Switch to Diagram View</b>	If you have opened the list for a diagram in the <b>Project Browser</b> , show the elements as the diagram instead of as the <b>Element List</b> .
<b>Find in Diagrams</b>	Display the diagram that uses the element or, if the element is used in multiple diagrams, display the <a href="#">Element Usage</a> dialog, which lists the diagrams that contain the element.
<b>Find In Project Browser</b>	Highlight the selected element in the <b>Project Browser</b> .
<b>Bookmark Item</b>	Bookmark the element.
<b>Create Linked Document</b> [Ctrl]+[Alt] +[D] <b>(Edit Linked Document)</b>	<a href="#">Create</a> (or <a href="#">edit</a> ) a <b>Linked Document</b> (Corporate, Business and Software Engineering, Systems Engineering and Ultimate editions).  See the <a href="#">Linked Documents</a> topic.
<b>Delete linked document</b>	Delete an existing linked document. (Only displays if the element has a linked document.)
<b>Documentation</b>	Generate an RTF report. You have two options: <ul style="list-style-type: none"> <li>Generate a separate report on each selected object in the report</li> <li>Generate one report on all selected objects.</li> </ul> In either case, the <a href="#">Generate RTF Documentation</a> dialog displays.  You also have the option to print out the <b>Element List</b> itself.  Alternatively, select the <b>Rich Text Report</b> icon in the <b>Element List</b> toolbar. This generates one report for all selected items.

Menu Option & Function Keys	Use to
Diagram Properties	Display the <a href="#">Diagram Properties</a> <sup>[423]</sup> dialog for the diagram.
Sort Contents	In <i>Model Hierarchy</i> format, synchronize the list with the <b>Project Browser</b> hierarchy, to ensure that all element and package hierarchies and sequences are - if necessary - updated. (Normally changes are updated automatically, but there can be delays if changes are made outside the <b>Element List</b> ).
Reload	Reload the element list to refresh the order and content with any recent changes.
Print	Print the <b>Element List</b> .
Delete Selected	Delete the selected element from the <b>Element List</b> . Alternatively, select the <b>Delete Selected</b> icon in the <b>Element List</b> toolbar.



## 6.6 Relationship Matrix

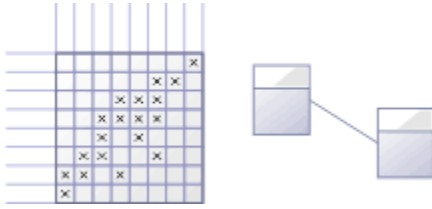

The **Relationship Matrix** is a spreadsheet display of relationships between model elements within packages. You select a source package and a target package, the relationship type and direction, and Enterprise Architect identifies all the relationships between source and target elements by highlighting a grid square and displaying an arrow indicating the direction of the relationship.

**Note:**

The direction is a reflection of which elements are the source elements and which are the target. It does not indicate the **Direction** property of the connector, as defined in the connector **Properties** dialog.

The **Relationship Matrix** is a convenient method of visualizing relationships quickly and definitively. It also enables you to create, modify and delete relationships between elements with a single mouse click - another quick way to set up complex sets of element relationships with a minimum of effort.

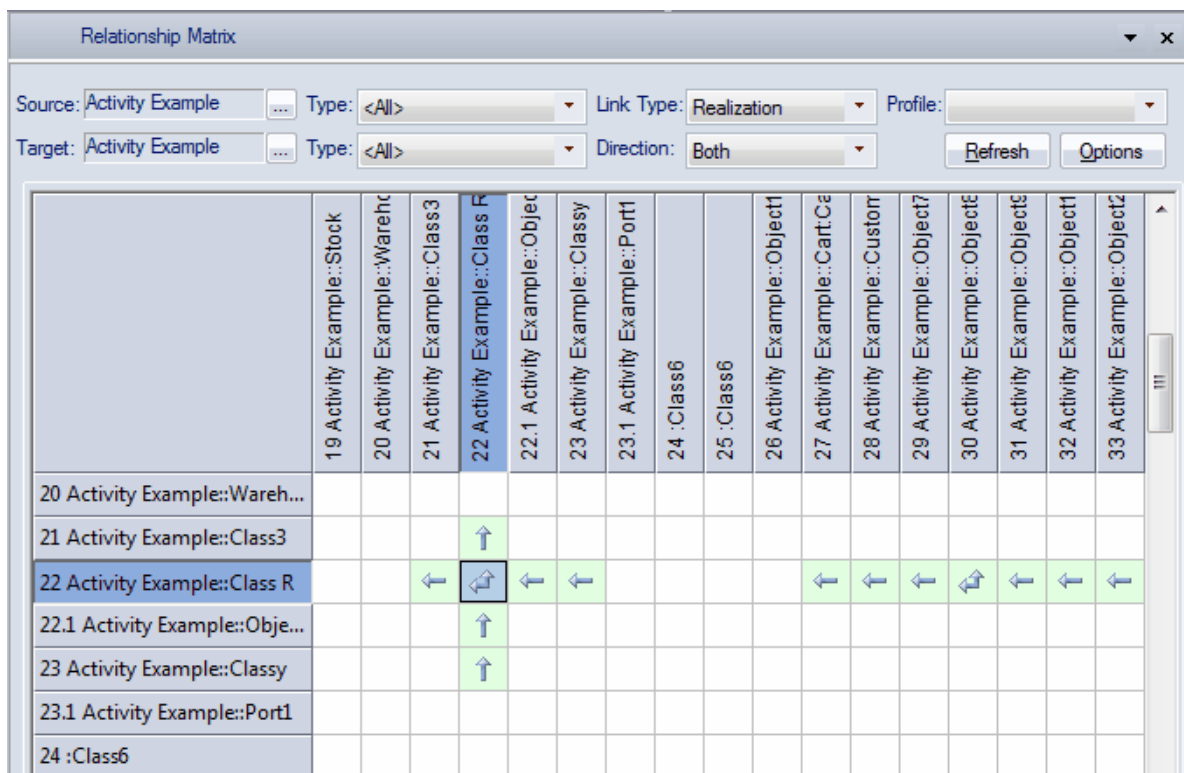

If you click on a square in the matrix, the square, the row headers and the column headers are highlighted, as shown in the example above. The example also illustrates the 'bent arrow' icon, indicating that connectors exist in both directions between the source and target elements.

The relationship squares in the example are green. This indicates that the *source* element is not locked (because the parent package has not been checked in under [version control](#)<sup>[263]</sup>). If the element is locked (the parent package has been checked in) the highlight is pink, as follows:



For information on accessing the **Relationship Matrix**, see the [Open the Relationship Matrix](#) topic.

You can also:

- [Select options](#) for modifying the type of information the **Relationship Matrix** displays
- [Update, delete and create](#) relationships through the **Relationship Matrix**
- Export the contents of the **Relationship Matrix** to a [CSV file](#) or to a [.png or .emf](#) file
- [Print the contents](#) of the **Relationship Matrix**, scaled down if required
- [Save a profile](#) of the **Relationship Matrix** settings to monitor development of the same source and target packages
- [Investigate the Source and Target elements](#) in the relationship.

### 6.6.1 Open the Relationship Matrix

To open the **Relationship Matrix** you can:

- Select the **View | Relationship Matrix** menu option
- Right-click on any package in the **Project Browser**, and select the **Documentation | Open in Relationship Matrix | As Source or As Target** context menu option.

Once the **Relationship Matrix** opens you can:

- [Set the source and target packages](#)
- [Select which element type to show](#)
- [Select connector type and direction to show](#)

The **Relationship Matrix** refreshes after every change you make to the input parameters.

#### Tip:

The **Relationship Matrix** includes ALL child elements in a hierarchy. Sometimes in a large model this can be a lot of elements, possibly too many to be useful. Take care in selecting the source and target package.

### 6.6.2 Set Element Type

The **Relationship Matrix** can show all element types, or you can specify which type to show.

To set the element type, follow the steps below:

1. Click on the **Type** drop-down arrow for the Source or Target package.
2. Find the required connector in the list and click on it. Enterprise Architect refreshes the **Relationship Matrix** content.

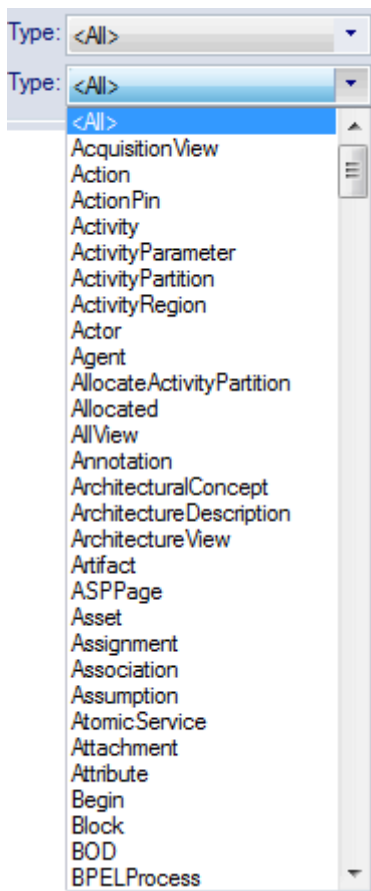

### 6.6.3 Set Connector Type and Direction

The **Relationship Matrix** requires that you set the connector type to report on and the connector direction. To do this, follow the steps below:

1. Click on the **Link Type** drop-down arrow to display a list of connector types.

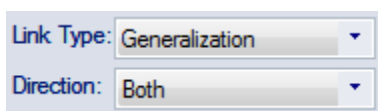

2. Scroll through the list and click on the appropriate connector type.
3. Click on the **Direction** drop-down arrow to display a list of directions.
4. Scroll through the list and click on the appropriate direction.

Enterprise Architect refreshes the **Relationship Matrix** content.

#### Notes:

- If you set **Direction** to **Both**, each relationship is indicated by two arrows - a *From-To* arrow and a *To-From* arrow. See the screen illustration in the [Relationship Matrix](#) <sup>1263</sup> topic.
- The direction is a reflection of which elements are the source elements and which are the target. It does not indicate the **Direction** property of the connector, as defined in the connector **Properties** dialog.

## 6.6.4 Set Source and Target Package

You must set both the source and target packages for the **Relationship Matrix** before relationships can be displayed.

### Tip:

You set the source and target packages **AFTER** setting the connector and element types/details; as Enterprise Architect refreshes the content after each change, this is usually faster.

### Set the Source or Target Package

To set the source or target package, follow the steps below:

1. In the **Project Browser**, click on the required source package, then press **[Ctrl]** and click on the required target package, to select the two packages together.
2. Drag the selected packages over the **Source** and **Target** fields; the first-selected package name displays in the **Source** field, and the second-selected package name displays in the **Target** field.

You can also select and drag a single package name over the required field, to change just the source or the target package. If you drop the package name anywhere else on the **Relationship Matrix**, the system prompts you to specify whether to add it to the **Source** or **Target** field.

*Alternatively:*

1. Click on the **[ ... ]** (Browse) button at the end of the **Source** or **Target** field.

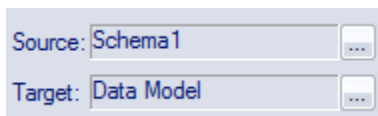

2. The **Browse Project** dialog displays.

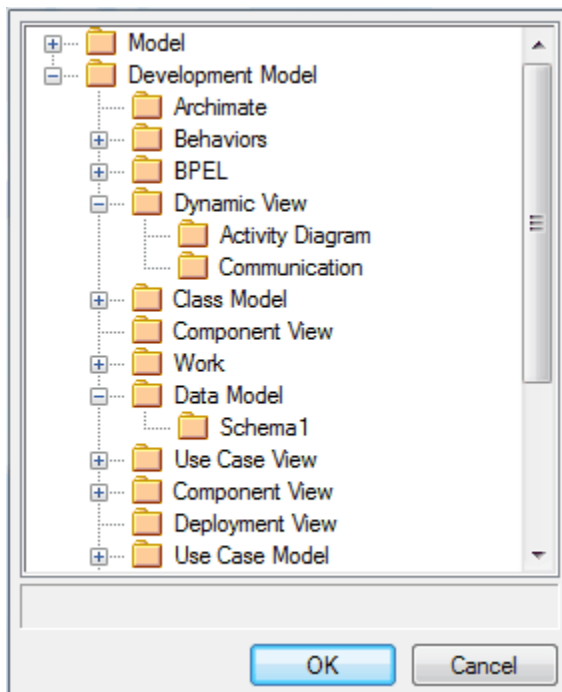

3. Select the required package and click on the **OK** button.

## 6.6.5 Relationship Matrix Options

The **Relationship Matrix** provides a menu of options that enable you to:

- **Output** the information on the **Relationship Matrix** to the printer or to a metafile, .png file or .csv file
- Create and update **profiles of the configurations of the matrix** that you have designed
- **Define local settings** to control what the **Relationship Matrix** displays.

### Output Relationship Matrix Information

Click on the **Options** button on the **Relationship Matrix** and click on the **Matrix** menu option. The following submenu displays:

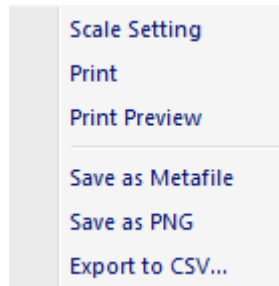

### Print Relationship Matrix

To print a WYSIWYG representation of the **Relationship Matrix** contents, click on the **Print** option. The **Print** dialog displays, on which you select the output printer and specify the printer properties, the range of pages to print, and the number of copies.

If you want to check what the matrix might look like on the page before you print, click on the **Print Preview** menu option. This displays the **Print Preview** screen.

### Scale Printout

When you print the **Relationship Matrix**, by default it prints on as many pages wide and long as the matrix requires. You can scale the printout into a fixed number of pages wide, and the row height is automatically adjusted to maintain the proportions of the matrix. This reduces the overall size of the printout and improves appearance, especially when used in conjunction with the **Landscape** option in the printer properties. For example, a 16-page printout without scaling can, with a scaling of 2 pages wide, be reduced to 6 pages.

To set the page scaling, click on the **Scale Setting** menu option. The **Scale Matrix** dialog displays.

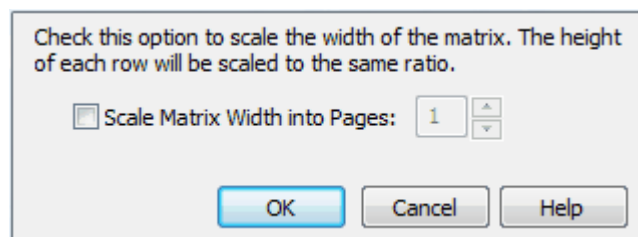

Select the **Scale Matrix Width into Pages** checkbox, and type or select the number of pages in width to scale to. Click on the **OK** button to apply the setting.

### Save Relationship Matrix as Graphic File

To save the current **Relationship Matrix** output as a graphic, click on the **Save as Metafile** or **Save as PNG** options. A **Browser** dialog displays that enables you to select the target file location and specify the filename of the .emf or .png file in which to save the output.

You can incorporate these files in an RTF or HTML report, as a hyperlinked file or an included file.

### Manage Display Content

Click on the **Options** button on the **Relationship Matrix** and click on the **Options** menu option. The **Matrix**

Options dialog displays.

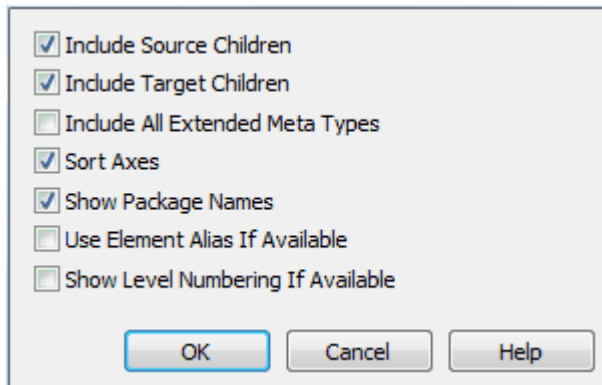

Select from the following options:

- **Include Source Children** - to recursively include child packages and contents under the Source
- **Include Target Children** - to recursively include child packages and contents under the Target
- **Include All Extended Meta Types** - to include elements that are extensions of a specified meta-type. For example, if there are Block elements (extending Class) in the package, selecting this option and specifying the type Class includes Class and Block elements, and any further derivatives of Block in the matrix.
- **Sort Axes** - to ensure package elements display in alphabetical order
- **Show Package Names** - to hide or show package names in the **Relationship Matrix**; this is useful for shortening the displayed texts, especially in circumstances where packages have long names
- **Use Element Alias If Available** - to display an element's alias instead of the element name, if an alias has been defined
- **Show Level Numbering If Available** - to reproduce level numbering in the **Relationship Matrix**, if it is turned on in the **Project Browser**; see the screen illustration in the [Relationship Matrix](#) <sup>[1267]</sup> topic.

## 6.6.6 Modify Relationships in Matrix

You can modify or delete relationships, or create new relationships, directly from the **Relationship Matrix**.

### To Modify or Delete Relationships

Right-click on a highlighted relationship to open the context menu, and select from the following options:

- **View relationship** - opens the **Properties** dialog for the selected relationship
- **Source element properties** - opens the **Properties** dialog for the source element
- **Target element properties** - opens the **Properties** dialog for the target element
- **Delete relationship.**

If you have selected **Delete relationship**, Enterprise Architect prompts you to confirm this action.

#### Note:

The **Delete relationship** option does not work if:

- The source element (that is, the owner) is locked
- You have selected **Both** in the **Direction** field - you are effectively trying to delete half a relationship.

If you have selected one of the other options, modify any properties as required, and click on the **OK** button to save the changes.

### To Create a New Relationship

1. Select the required relationship type in the **Link Type** field.
2. Right-click on the empty intersection of the source row and target column to display the context menu.

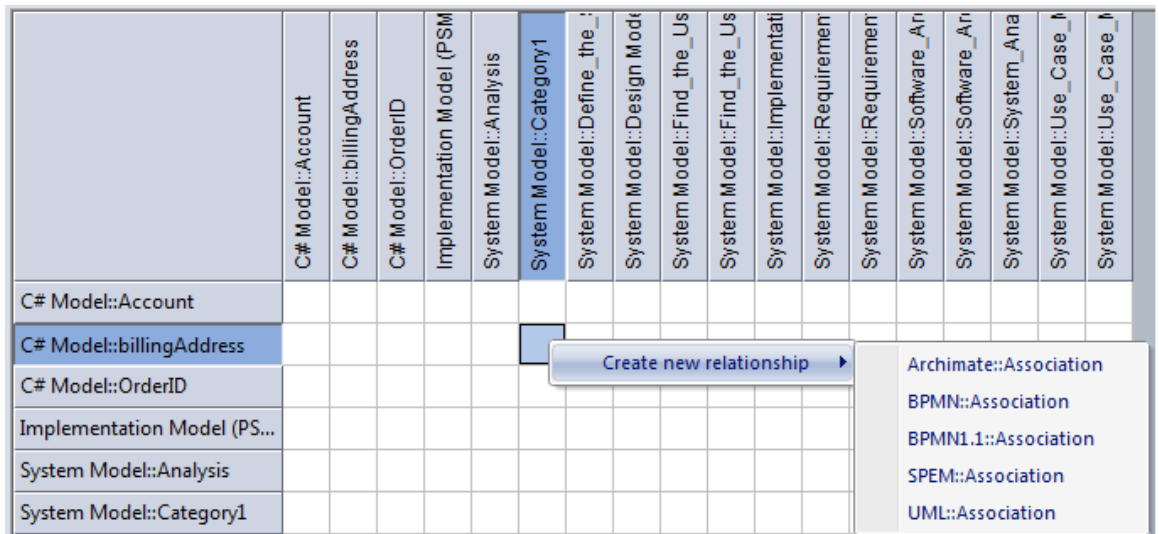

3. Select the **Create new relationship...** option; a submenu displays, listing the types of relationship you can create.
4. Click on the required type of relationship to create a new connector between the two elements.

**Tip:**

Use the matrix relationship management features to quickly create and manage relationships like Realization and Aggregation between Requirements and implementation elements (such as Use Cases).

### 6.6.7 Export to CSV

The contents of the **Relationship Matrix** can be exported to a CSV file. This provides a convenient mechanism for moving the matrix data to a spreadsheet environment such as Microsoft Excel. (This option is also active in the **'Lite'**, read-only version of Enterprise Architect.)

To export to CSV, follow the steps below:

1. Click on the **Options** button on the **Relationship Matrix** to display the context menu.
2. Select the **Matrix | Export to CSV** menu option. The Windows **Browser** dialog displays.
3. Browse to the required file location and type in a .CSV filename to export to.
4. Click on the **Save** button to export the data.

### 6.6.8 Matrix Profiles

To save a certain **Relationship Matrix** configuration as a named profile for later recall, follow the steps below:

1. Set up the **Relationship Matrix** as required, with source and target, element types and relationship types.
2. Click on the **Options** button on the **Relationship Matrix** to display the context menu, then select the **Profiles | Save as New Profile** menu option.
3. In the **Enter Value** field, type a profile name of up to 12 characters. Click on the **OK** button.

Once you have created a profile, you can select it from the drop-down list in the **Profile** field at the top of the **Relationship Matrix** screen.

You can also select an existing profile, modify it on the **Relationship Matrix** screen, then save it under the same profile name by selecting the **Profiles | Update Current Profiles** menu option.

To delete an existing profile, select it in the drop-down list and select the **Profile | Delete Current Profile** menu option.

### 6.6.9 Review Source and Target Elements

As well as providing information on connectors and relationships, the **Relationship Matrix** enables you to obtain information on the source and target elements in a relationship.

To help you quickly identify which source or target elements have relationships with a particular element, you can highlight the entire row or column for the element by clicking on the element name in the row or column titles. If the list of elements is long, you can scroll across or down the highlighted row or column and quickly identify where the relationships are.

If you right-click on an element name in the row or column titles, the following context menu displays:

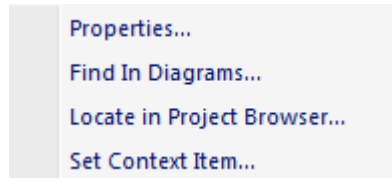

This enables you to:

- Display the **Properties** dialog for the selected element
- Display either the only diagram in which the element is used, with the element highlighted, or a list of the diagrams in which the element is used; you then select and open a diagram from the list
- Locate and highlight the element name in the **Project Browser**
- Make the selected element the context or focus in any docked screens or windows that are open, such as the **Tagged Values** window.



## 6.7 The Relationships Window



Access: **View | Other Element Tools | Relationships.**

The **Relationships** window displays all connectors between the currently selected element and other elements. This provides a quick overview of an element's relationships in the model.

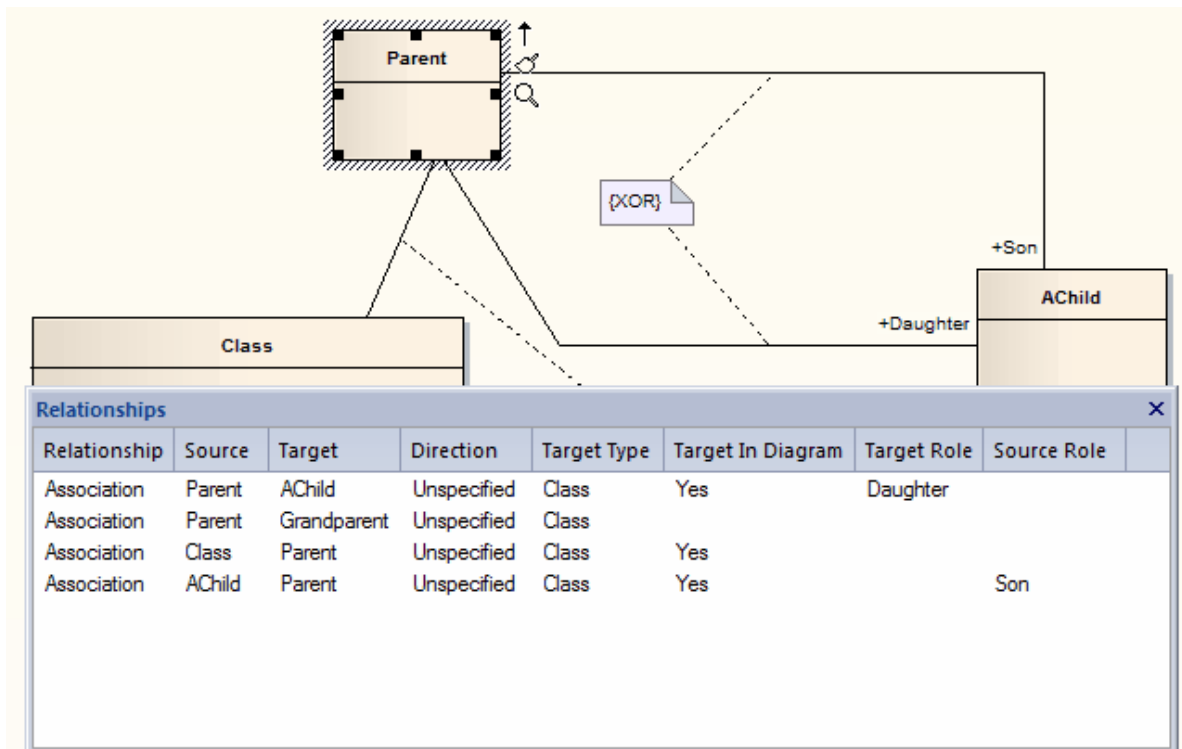

For each connector, the connector type and target element are displayed. If a 'Yes' appears in the **Target in Diagram** column, the target element is visible in the currently loaded diagram. This is useful when you are dragging related elements from the relationships list onto the current diagram.

Double-click on a connector in the list to open the **<connector type> Properties** dialog, where you can edit the connector attributes. Right-click on a connector to open the context menu.

You can locate the related element, view the related element properties or delete the connector. You can also hide certain connectors from appearing in diagrams, and show hidden connectors (first example of the menu, below).

If an element is not visible in the current diagram, the context menu has an option to place the selected element in the current diagram (second example of the menu, below). This is useful when you are building a picture of what an element interacts with, especially when reverse engineering an existing code base.

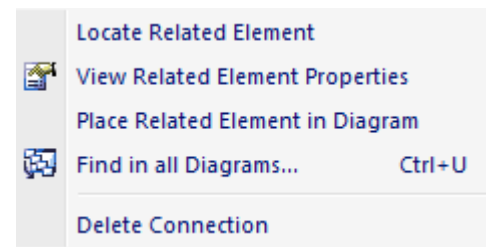
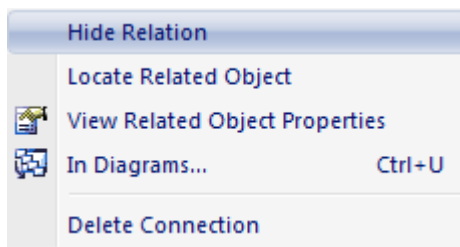
**Tip:**

In the Corporate, Business and Software Engineering, Systems Engineering and Ultimate editions of Enterprise Architect, with [security](#) <sup>[188]</sup> on, the diagram and the source and target elements must be free for editing before some of these options are available for use.

## 6.8 Diagram Filters

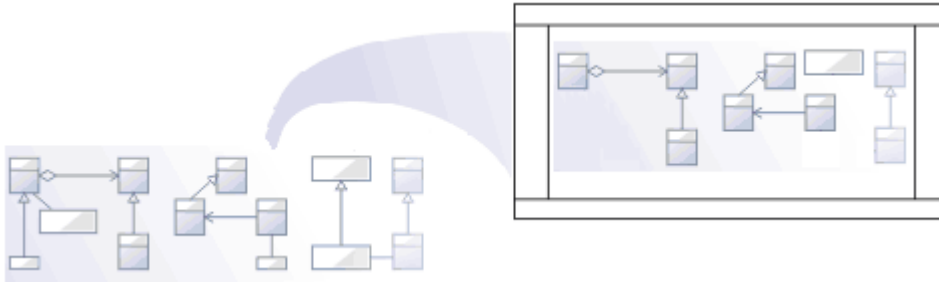

*Diagram Filters* (Dynamic Visual filters) enable you to modify the display of diagram components, so that the relevant items are immediately identified for the reader's attention without damaging the structure and integrity of the model. Currently the feature operates on elements, and filters according to element properties such as Author, Status, Date Created or Stereotype.

Diagram Filters are useful in tailoring the display of diagrams:

- For different users, so that - for example - technical staff and stakeholders each have a view that highlights the information pertinent to them
- To show what elements have been recently developed or changed
- To show which part of a model was developed by a particular person
- To show which parts of a diagram are at a particular phase, status or version.

You [create and define](#)<sup>[1272]</sup> as many filters as you require, setting up each filter by defining which element properties to specifically check for and (depending on how you set up the filter parameters) whether to include or exclude elements having particular property values. You can select to:

- Mute the irrelevant items in grayscale or a faded color
- Hide the irrelevant items completely, or
- Highlight (with a hashed border) the elements that *are* relevant.

If you select to mute or hide elements, the action of the filters is to *exclude* elements that *do not* match the parameters rather than *include* elements that do. If, for example, you selected to filter on element name, looking for elements with the word *Class* in the name, the filter would apply the following logic:

Does **Name** contain string *Class*? If **No**, apply effect. If **Yes**, take *no* action.

The elements you want are therefore what is left on the diagram, rather than what was operated on. The [filter effect](#)<sup>[1272]</sup> remains in force while you do other work on the diagram, until such time as you [disable](#)<sup>[1272]</sup> the filter.

In you select the *Highlight* effect, however, the logic is reversed:

Does **Name** contain string *Class*? If **No**, take *no* action. If **Yes**, apply effect.

In this case, the filter effect is not permanent, and clicking off the elements deselects them. This effect is, however, excellent for selecting elements having the same characteristics across a large diagram, to be processed in a single task. Instead of having to locate the elements and select them with **[Ctrl]+click** individually, you can apply the filter. If you inadvertently lose the selection by clicking off the elements, you can get it back again almost immediately by re-applying the filter.

You can use filters singly, in sequence, or in combination; for example, you could:

- Set up a filter for immediate use on a diagram, and modify that filter as you review the diagram so that you highlight elements with different values for the same properties - perhaps, by filtering on Phase, to compare 'as-is' and 'to-be' elements
- Set up a filter and leave it active so that all diagrams you display are automatically filtered the same way
- Set up a series of filters to use:
  - in one or more sequences to progressively highlight a diminishing set of elements, or
  - alternately to highlight contrasting views of the diagram.

A quick-start guide to using Diagram Filters is provided on the [Sparx Systems Community Site](#).

## 6.8.1 Work With Diagram Filters

### Access Diagram Filters

You create, list and activate Diagram Filters using the **Diagram Filters** window, which you display by selecting the **View | Diagram Filters** menu option.

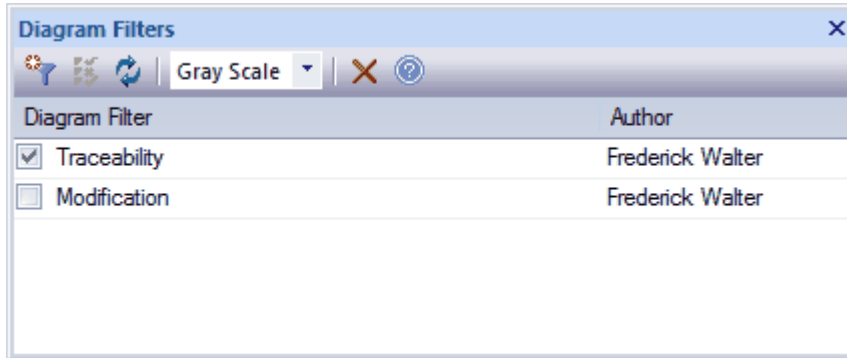

This is a dockable window, which you can move around or fix next to the **Diagram View** while you activate, deactivate and edit the filters.

### Create a Diagram Filter

To create a filter to be applied to your diagrams, follow the steps below:

1. On the **Diagram Filter** toolbar, click on the **New Filter** icon - the first on the left. Alternatively, right click on the list panel and select the **New Filter** context menu option. The **Create New Diagram Filter** dialog displays.

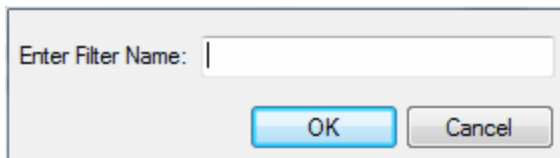

2. In the **Enter Filter Name** field, type a name for the filter, then click on the **OK** button. The **Diagram Filter** dialog displays, with the **Search On** field fixed on **Element**.

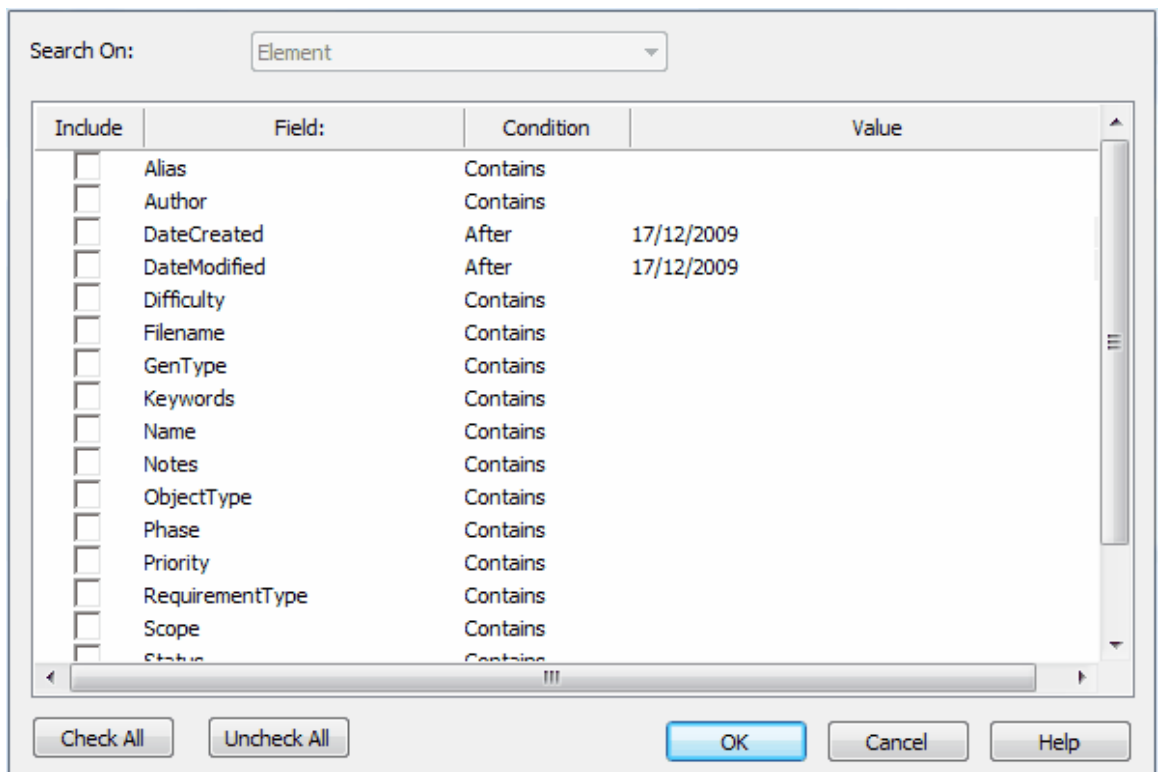

3. Scroll through the element properties to filter on, and select the checkbox against each property you require.
4. For each property, click on the **Condition** field and select, from the drop-down list, the comparison condition to be applied. (Be aware of how the combination of **Condition - Equal To / Not Equal To** - and **Filter Effect** <sup>1277</sup> might affect the results on the diagram.)
5. For each property, double-click on the **Value** field and type or select any specific value to filter on.
6. Click on the **OK** button to save the filter and return to the **Diagram Filters** window.

### Edit a Filter

To edit an existing filter on the **Diagram Filters** window, either double-click on the filter name, click on it and select the **Properties** icon from the toolbar (the second icon from the left), or right-click on the name and select the **Properties** context menu option. The **Diagram Filter** dialog displays; adjust the filtered fields as described above.

To just change the name of the filter, right-click on the name and select the **Change Name** context menu option. The **Create New Diagram Filter** dialog displays. Type over the existing name with the new name, and click on the **OK** button.

### Set Effect of Filters

To set how your filters identify selected elements on your diagrams, click on the drop-down arrow of the **Filter Effect** field in the toolbar, and select one of the following options:

- **Fade** - display all elements that do *not* match the filter criteria in a pale version of the diagram background color.
- **Gray Scale** - display all elements that do *not* match the filter criteria in pale gray.
- **Hide** - conceal all elements that do *not* match the filter criteria.
- **Select** - select and highlight (with a hashed border) all those elements that *do* match the filter criteria.

### Enable Filters

To enable a filter so that it takes immediate effect on your diagrams, select the check box against the filter name. You can select more than one filter at a time, to combine their effects.

### Disable/Clear Filters

To disable a filter, clear the checkbox. This clears the effect of the filter on the diagram, so that it displays in full.

To disable all filters, click on the **Reload Filters** icon in the toolbar (third option from the left), or right-click on the list panel and select the **Reload Filters** context menu option.

### Delete a Filter

To remove a filter from the **Diagram Filters** window, either click on the filter name and click on the **Delete** icon in the toolbar, or right-click on the filter name and select the **Delete Filter** context menu option.

## 6.9 The Pan & Zoom Window

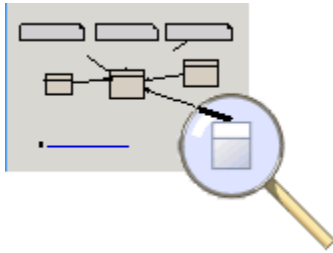

Access: **View | Pan & Zoom.**

The **Pan & Zoom** window provides a 'birds-eye' view of diagrams. It enables you to navigate quickly around large diagrams.

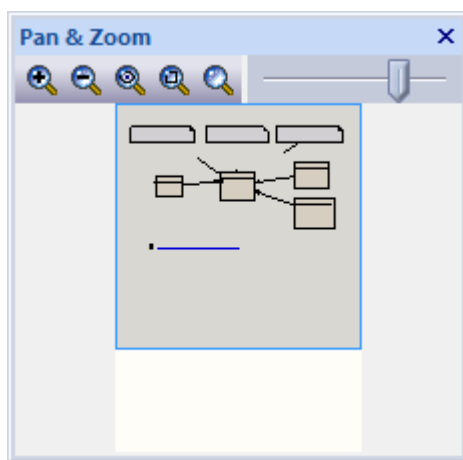

The shaded box represents the viewed area on the open diagram. The toolbar provides the following functions (in order):

- Zoom In
- Zoom Out
- Zoom to fit diagram
- Zoom to fit page
- Zoom to 100%
- Zoom Slider.

Move the cursor inside the window and hold down the mouse button to pan over the open diagram by moving the shaded box. To zoom, use either the *Zoom Slider* or the buttons located on the tool bar.

**Part**





## 7 Software Development



The Model Driven Development Environment (MDDE) provides tools to design, build and debug an application.

The MDDE integrates code and model by providing options to either generate source code from the model or reverse engineer existing source code into a model. Source code and model can be synchronized in either direction.

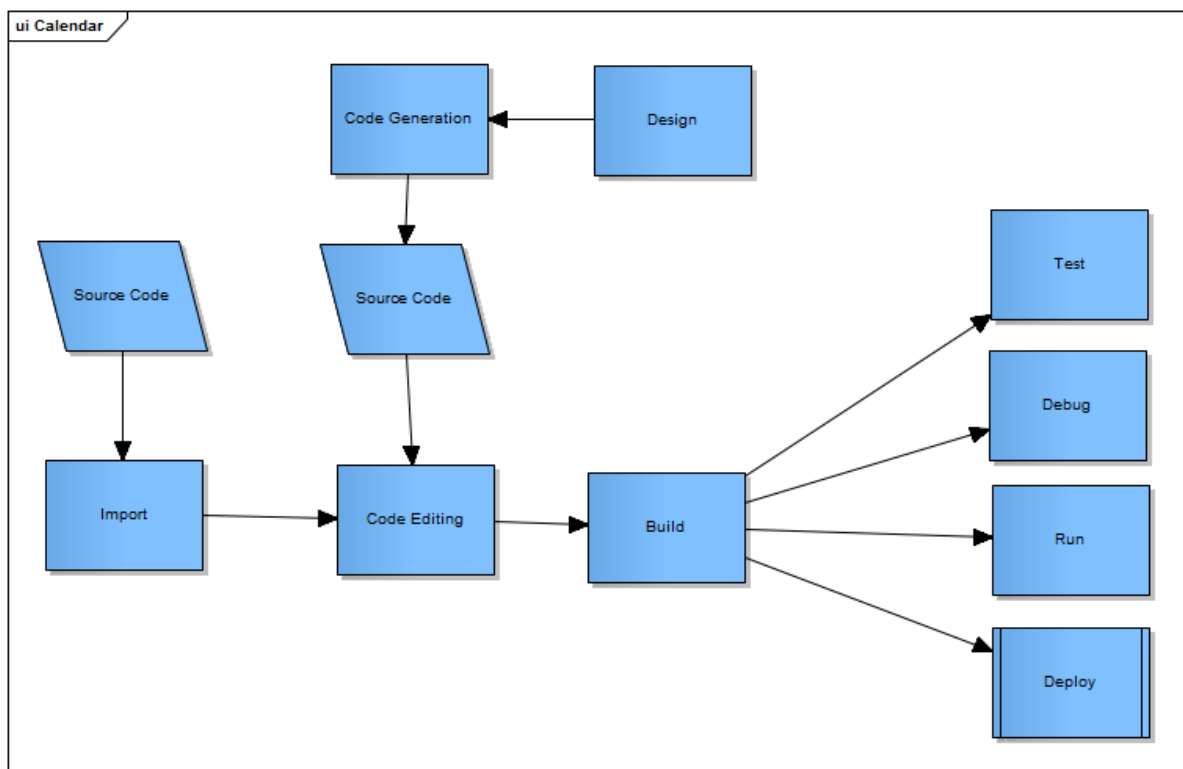

The MDDE provides development environments for popular languages including:

- C++
- C
- Java
- Microsoft .NET family
- ADA
- Python
- Perl

Toolboxes provide for different modeling technologies.

**Note:**

Although you can generate and reverse engineer code in a range of languages, Execution Analysis debugging and recording are supported for the following platforms / languages only:

- Microsoft Windows Native C
- Microsoft Windows Native C++
- Microsoft Windows Visual Basic
- Microsoft .NET Family (C#, J#, VB)
- Sun Microsystems Java.

To use the MDDE, work through the following sections:

- [Getting Started](#) <sup>[1424]</sup>
- [Basic Setup](#) <sup>[1425]</sup>
- [Software Engineering](#) <sup>[1281]</sup>
- [Using Code Editors](#) <sup>[1428]</sup>
- [Build Application](#) <sup>[1443]</sup>
- [Debug](#) <sup>[1470]</sup>
- [Test](#) <sup>[1483]</sup>
- [Run](#) <sup>[1482]</sup>
- [Deploy](#) <sup>[1484]</sup>

## 7.1 Overview of Development



Code Engineering with Enterprise Architect broadly encompasses various processes for generating or transforming code from your UML model and importing code into the model, to support model development in several coding languages, database development and SOA development.

### Code Engineering

Enterprise Architect supports:

- **Source code generation and reverse engineering** for many popular languages, including **C++, C#, Java, Delphi, VB.Net, Visual Basic, ActionScript, Python** and **PHP**.

Enterprise Architect also provides:

- A built in 'syntax highlighting' **source code editor**
- **Code generation templates**, which enable you to **customize** the generated source code to your company specifications.

For more information, see the [Software Engineering](#)<sup>[1287]</sup> topic.

### MDA Transformations

Enterprise Architect provides:

- Advanced Model Driven Architecture (**MDA**) transformations using **transformation templates**
- **Built-in transformations** for **DDL, C#, Java, EJB** and **XSD**.

One PIM can be used to generate and synchronize **multiple PSMs**, providing a **significant productivity boost**.

For more information, see the [Model Transformations - MDA](#)<sup>[1385]</sup> topic.

### Visual Execution Analysis

Enterprise Architect enables you to:

- **Build, test, debug, run and execute deployment scripts**
- **Integrate** UML development and modeling with source development and compilation
- **Generate NUnit and JUnit** test Classes from source Classes using **MDA Transformations**
- Integrate the **test process** directly into the Enterprise Architect IDE
- **Debug .NET, Java** and **Microsoft Native** (C, C++ and Visual Basic) applications.

For more information, see the [Visual Execution Analysis](#)<sup>[1488]</sup> topic.

### Database Modeling

Enterprise Architect enables you to:

- **Reverse engineer** from many popular **DBMSs**, including **SQL Server, My SQL, Access, PostgreSQL** and **Oracle 9i, 10g** or **11g**
- **Model database tables, columns, keys, foreign keys** and **complex relationships** using UML and an **inbuilt data modeling profile**
- **Forward generate DDL scripts** to create target database structures.

For more information, see the [Data Models](#)<sup>[1017]</sup> topic.

### XML Technology Engineering

Enterprise Architect enables you to rapidly **model, forward engineer** and **reverse engineer** two key **W3C**

**XML** technologies:

- **XML Schema (XSD)**
- **Web Service Definition Language (WSDL)**.

XSD and WSDL support is critical for the development of a complete **Service Oriented Architecture (SOA)**, and the coupling of UML 2.3 and XML provides the natural mechanism for implementing XML-based SOA artifacts within an organization.

For more information, see the [XML Schema - XSD](#)<sup>[1039]</sup> and [Web Services - WSDL](#)<sup>[1049]</sup> topics.

## 7.2 Software Engineering



Software Engineering is a process that includes **automated code generation**, **reverse engineering** of source code and **synchronization** between the source code and model.

Enterprise Architect also enables you to rapidly model, generate - or *forward engineer* - and reverse engineer:

- XML Technologies, namely [XML Schema \(XSD\)](#)<sup>[1039]</sup> and [Web Service Definition Language \(WSDL\)](#)<sup>[1049]</sup>
- [Database schema](#)<sup>[1017]</sup>, keys, triggers, constraints, RI and other relational database features, for and from a range of database products.

Software Engineering is available in the Professional, Corporate, Business and Software Engineering, System Engineering and Ultimate editions of Enterprise Architect.

### Code Generation

Enterprise Architect enables you to [generate source code](#)<sup>[1308]</sup> from UML model elements, creating a source code equivalent of the Class or Interface element for future elaboration and compilation. In particular you can generate [C, C++, C#, Delphi, Java, PHP, Python, ActionScript, Visual Basic and VB.NET](#)<sup>[1347]</sup> source code. The source code generated includes Class definitions, variables and function stubs for each attribute and method in the UML Class. You can use the [Source Code Viewer](#)<sup>[1441]</sup> to view any source code you are opening.

#### Note:

You view source code for an element by selecting it and pressing either **[Ctrl]+[E]** or **[F12]**. If the element does not have a generation file (that is, code has not been or cannot be generated, such as for a Use Case), Enterprise Architect checks whether the element has a [link](#)<sup>[617]</sup> to either an operation or an attribute of another element. If such a link exists, and that other element has source code, the code for that element displays.

You can also generate code from three UML behavioral modeling paradigms:

- [State Machine diagrams](#)<sup>[1316]</sup> (SW & HW)
- [Interaction \(Sequence\) diagrams](#)<sup>[1322]</sup> (SW)
- [Activity diagrams](#)<sup>[1323]</sup> (SW).

The [Code Template Framework \(CTF\)](#)<sup>[1307]</sup> enables you to customize the way Enterprise Architect generates source code. It also enables you to generate languages that Enterprise Architect does not specifically support, by helping you define the appropriate code generation templates for that language.

You can integrate the facilities of Enterprise Architect with other development environments. The [MDG Integration for Eclipse and MDG Integration for Visual Studio](#)<sup>[1334]</sup> are standalone products that provide an enhanced code engineering functionality between Enterprise Architect and the development environments.

### Reverse Engineering

[Reverse Engineering](#)<sup>[1328]</sup> is the import of existing source code into model elements, mapping the source code structures onto their UML representations. This enables you to examine legacy code and the functionality of code libraries for reuse, or to bring the UML model up to date with the code. You can reverse engineer in the same languages as you perform code generation with Enterprise Architect.

Enterprise Architect is also able to reverse engineer binary files, namely Java .jar files and .NET PE files.

#### Note:

Reverse Engineering of other languages including CORBA IDL is also currently available through the use of the MDG Technologies. See [www.sparxsystems.com/resources/mdg\\_tech/](http://www.sparxsystems.com/resources/mdg_tech/).

## Synchronization

[Synchronization](#)<sup>[1327]</sup> is when changes in the model are exported to the source code and changes to source code are imported into the model. This enables you to keep your model and source up to date as the project develops.

## Round-Trip Engineering

*Round trip engineering* is a combination of reverse and forward generation of code and includes synchronization between the source code and the model in all but the most trivial of code engineering projects. In order to get the most out of round trip engineering in Enterprise Architect, you should be familiar with the [modeling conventions](#)<sup>[1282]</sup> used when generating and reverse engineering the languages you use.

### 7.2.1 Modeling Conventions



In order to get the most out of the round trip engineering in Enterprise Architect, you must be familiar with the modeling conventions used when generating and reverse engineering the languages you use. This topic describes the stereotypes, Tagged Values and other conventions used in code engineering in Enterprise Architect for the following supported languages:

- [ActionScript](#)<sup>[1283]</sup>
- [Ada 2005](#)<sup>[1284]</sup> (for Systems Engineering and Ultimate editions of Enterprise Architect)
- [C](#)<sup>[1285]</sup>
- [C#](#)<sup>[1287]</sup>
- [C++](#)<sup>[1289]</sup>
- [Delphi](#)<sup>[1292]</sup>
- [Java](#)<sup>[1293]</sup>
- [PHP](#)<sup>[1294]</sup>
- [Python](#)<sup>[1295]</sup>
- [System C](#)<sup>[1295]</sup>
- [VB.Net](#)<sup>[1296]</sup>
- [Verilog](#)<sup>[1295]</sup>
- [VHDL](#)<sup>[1295]</sup>
- [Visual Basic](#)<sup>[1301]</sup>

**Note:**

Enterprise Architect incorporates a number of visibility indicators or scope values for its supported languages. These include, for:

- All languages - Public (+), Protected (#) and Private (-)
- Java - Package (~)
- Delphi - Published (^)
- C# - Internal (~), Protected Internal (^)
- ActionScript - Internal (~)
- VB.NET - Friend (~), Protected Friend (^)
- PHP - Package (~)
- Python - Package (~)
- C - Package (~)
- C++ - Package (~).

### 7.2.1.1 ActionScript Conventions

Enterprise Architect supports round trip engineering of ActionScript 2 and 3, where the following conventions are used.

#### Stereotypes

Stereotype	Applies To	Corresponds To
literal	Operation	A literal method referred to by a variable.
property get	Operation	A read property.
property set	Operation	A write property.

#### Tagged Values

Tag	Applies To	Corresponds To
attribute_name	Operation with stereotype <i>property get</i> or <i>property set</i>	The name of the variable behind this property.
dynamic	Class or Interface	The <i>dynamic</i> keyword.
final	ActionScript 3: Operation	The <i>final</i> keyword.
intrinsic	ActionScript 2: Class	The <i>intrinsic</i> keyword
namespace	ActionScript 3: Class, Interface, Attribute, Operation	The namespace of the current element.
override	ActionScript 3: Operation	The <i>override</i> keyword.
prototype	ActionScript 3: Attribute	The <i>prototype</i> keyword.
rest	ActionScript 3: Parameter	The <i>rest</i> parameter ( ... ).

#### Common Conventions

- Package qualifiers (ActionScript 2) and Packages (ActionScript 3) are generated when the current package is not a [namespace root](#)<sup>[1313]</sup>
- An unspecified type is modeled as *var* or an empty **Type** field.

## ActionScript 3 Conventions

- The *Is Leaf* property of a Class corresponds to the sealed keyword
- If a *namespace* tag is specified it overrides the *Scope* that is specified.

### See Also

- [Import Source Code](#) <sup>[1329]</sup>
- [Generate Source Code](#) <sup>[1308]</sup>
- [ActionScript Options](#) <sup>[1348]</sup>

### 7.2.1.2 Ada 2005

Ada 2005 support is available in the System Engineering and Ultimate editions of Enterprise Architect.

Enterprise Architect supports round trip engineering of Ada 2005, where the following conventions are used.

## Stereotypes

Stereotype	Applies To	Corresponds To
<b>adaPackage</b>	Class	A package specification in Ada 2005 without a tagged record.
<b>adaProcedure</b>	Class	A procedure specification in Ada 2005.
<b>delegate</b>	Operation	Access to a subprogram.
<b>enumeration</b>	Inner Class	An <i>enum</i> type.
<b>struct</b>	Inner Class	A record definition.
<b>typedef</b>	Inner Class	A type definition, subtype definition, access type definition, renaming.

## Tagged Values

Tag	Applies To	Corresponds To
<b>Discriminant</b>	Inner Class with stereotype <i>typedef</i>	The type's discriminant.
<b>IsAccess</b>	Parameter	Determination of whether the parameter is an access variable.
<b>InstantiatedUnitType</b>	Inner Class with stereotype <i>typedef</i>	The instantiated unit's type ( <i>Package / Procedure / Function</i> ).
<b>PartType</b>	Inner Class with stereotype <i>typedef</i>	The part type ( <i>renames</i> or <i>new</i> ).
<b>Type</b>	Inner Class with stereotype <i>typedef</i>	If Value = <i>SubType</i> , set subtype. If Value = <i>Access</i> , set access type.

## Other Conventions

- Appropriate type of source files: Ada specification file, **.ads**.
- Ada 2005 imports packages defined as either <<adaPackage>>Class or Class, based on the settings in the [Ada 2005 options](#) <sup>[1349]</sup>.
- A package in the Ada specification file is imported as a Class if it contains a Tagged Record, the name of which is governed by the options **Use Class Name for Tagged Record** and **Alternate Tagged Record Name**. All attributes defined in that Tagged Record are absorbed as the Class's attributes.
- A procedure / function in an Ada specification file is considered as the Class's member function if its first parameter satisfies the conditions specified in the options **Ref Param Style**, **Ignore Reference parameter name** and **Ref parameter name**.



- The option **Define Reference for Tagged Record**, if enabled, creates a reference type for the Class, the name of which is determined by the option **Reference Type Name**.

For example: *HelloWorld.ads*

```
package HelloWorld is
  type HelloWorld is tagged record
    Att1: Natural;
    Att3: Integer;
  end record;

  -- Public Functions
  function MyPublicFunction (P: HelloWorld) return String;
  procedure MyPublicFunction (P1: in out HelloWorld; AFlag: Boolean);

private
  -- Private Functions
  function MyPrivateFunction (P: HelloWorld) return String;
  procedure MyPrivateFunction (P1: in out HelloWorld; AFlag: Boolean);

end HelloWorld;
```

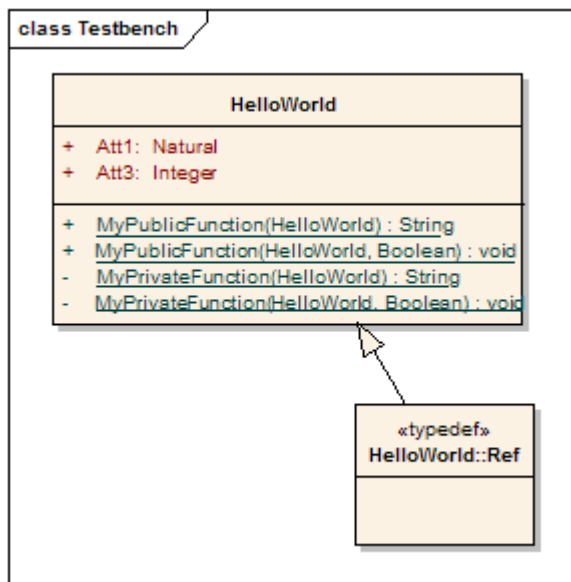

### See Also

- [Import Source Code](#)<sup>[1329]</sup>
- [Generate Source Code](#)<sup>[1308]</sup>

### 7.2.1.3 C Conventions

#### Note:

Separate conventions apply to [Object Oriented programming in C](#)<sup>[1286]</sup>.

Enterprise Architect supports round trip engineering of C, where the following conventions are used:

#### Stereotype

Stereotype	Applies To	Corresponds To
enumeration	Inner Class	An <i>enum</i> type.
struct	Inner Class	A <i>struct</i> type.
	Attribute	A keyword <i>struct</i> in variable definition.

Stereotype	Applies To	Corresponds To
<b>typedef</b>	Inner Class	A <i>typedef</i> statement, where the parent is the original type name.
<b>union</b>	Inner Class	A <i>union</i> type.
	Attribute	A keyword <i>union</i> in variable definition.

### Tagged Values

Tag	Applies To	Corresponds To
<b>anonymous</b>	Class also containing the Tagged Value <i>typedef</i>	The name of this class being defined only by the <i>typedef</i> statement.
<b>bodyLocation</b>	Operation	The location the method body is generated to. Expected values are <b>header</b> , <b>classDec</b> or <b>classBody</b> .
<b>typedef</b>	Class with stereotype other than <i>typedef</i>	This Class being defined in a <i>typedef</i> statement.

### C Code Generation for UML Model

UML	C Code	Notes
A Class	A pair of C files (.h + .c)	File name is the same as Class name.
Operation (public & protected)	Function declaration in .h file and definition in .c file	
Operation (private)	Function definition in .c file only	
Attribute (public & protected)	Variable definition in .h file	
Attribute (private)	Variable definition in .c file	
Inner Class (without stereotype)	(N/A)	This inner Class would be ignored

#### See Also

- [Import Source Code](#) <sup>[1329]</sup>
- [Generate Source Code](#) <sup>[1308]</sup>
- [C Options](#) <sup>[1349]</sup>

#### 7.2.1.3.1 Object Oriented Programming In C

The following conventions are used for Object-Oriented programming in C.

To configure Enterprise Architect to support Object-Oriented programming using C, you must set the **Object Oriented Support** option to **True** on the [C Specifications](#) <sup>[1349]</sup> page of the **Options** dialog.

### Stereotype

Stereotype	Applies To	Corresponds To
<b>enumeration</b>	Class	An <i>enum</i> type.
<b>struct</b>	Class	A <i>struct</i> type.

Stereotype	Applies To	Corresponds To
	Attribute	A keyword <i>struct</i> in variable definition.
<b>typedef</b>	Class	A <i>typedef</i> statement, where the parent is the original type name.
<b>union</b>	Class	A <i>union</i> type.
	Attribute	A keyword <i>union</i> in variable definition.

## Tagged Values

Tag	Applies To	Corresponds To
<b>anonymous</b>	Class with stereotype of <i>enumeration</i> , <i>struct</i> or <i>union</i> .	The name of this Class being defined only by the <i>typedef</i> statement.
<b>bodyLocation</b>	Operation	The location the method body is generated to. Expected values are <b>header</b> , <b>classDec</b> or <b>classBody</b> .
<b>define</b>	Attribute	<i>#define</i> statement.
<b>typedef</b>	Class with stereotype of <i>enumeration</i> , <i>struct</i> or <i>union</i> .	This Class being defined in a <i>typedef</i> statement.

## Object-Oriented C Code Generation for UML Model

The basic idea of implementing a UML Class in C code is to group the data variable (UML attributes) into a structure type. This structure is defined in a **.h** file so that it can be shared by other classes and by the client that referred to it.

An operation in a UML Class is implemented in C code as a function. The name of the function must be a fully qualified name that consists of the operation name, as well as the Class name to indicate that the operation is for that Class. A delimiter (specified in the **Namespace Delimiter** option on the [C Specifications](#) <sup>[1349]</sup> page) is used to join the Class name and function (operation) name.

The function in C code must also have a reference parameter to the Class object. You can modify the **Reference as Operation Parameter**, **Reference Parameter Style** and **Reference Parameter Name** options on the [C Specifications](#) page to support this reference parameter.

## Limitations of Object-Oriented Programming in C

1. No scope mapping for an attribute: an attribute in a UML Class is mapped to a structure variable in C code, and its scope (private, protected or public) is ignored.
2. Currently an inner Class is ignored: if a UML Class is the inner Class of another UML Class, it is ignored when generating C code.
3. Initial value is ignored: the initial value of an attribute in a UML Class is ignored in generated C code.

### See Also

- [Import Source Code](#) <sup>[1329]</sup>
- [Generate Source Code](#) <sup>[1308]</sup>
- [C Options](#) <sup>[1349]</sup>

### 7.2.1.4 C# Conventions

Enterprise Architect supports the round trip engineering of C#, where the following conventions are used.

#### Stereotypes

Stereotype	Applies To	Corresponds To
<b>enumeration</b>	Class	An <i>enum</i> type.

Stereotype	Applies To	Corresponds To
event	Operation	An event.
extension	Operation	A Class extension method, represented in code by a <i>this</i> parameter in the signature.
indexer	Operation	A property acting as an index for this Class.
partial	Operation	The <i>partial</i> keyword on an operation.
property	Operation	A property possibly containing both read and write code.
struct	Class	A <i>struct</i> type.

### Tagged Values

Tag	Applies To	Corresponds To
argumentName	Operation with stereotype <i>extension</i>	The name given to the <i>this</i> parameter.
attributeName	Operation with stereotype <i>property</i> or <i>event</i>	The name of the variable behind this property or event.
className	Operation with stereotype <i>extension</i>	The Class that this method is being added to.
const	Attribute	The <i>const</i> keyword.
definition	Operation with stereotype <i>partial</i>	Whether this is the declaration of the method, or the definition.
delegate	Operation	The <i>delegate</i> keyword.
enumType	Operation with stereotype <i>property</i>	The datatype that the property is represented as.
extern	Operation	The <i>extern</i> keyword.
fixed	Attribute	The <i>fixed</i> keyword.
generic	Operation	The generic parameters for this Operation.
genericConstraints	Templated Class or Interface, Operation with tag <i>generic</i>	The constraints on the generic parameters of this type or operation.
Implements	Operation	The name of the method this implements, including the interface name.
ImplementsExplicit	Operation	The presence of the source interface name in this method declaration.
initializer	Operation	A constructor initialization list.
new	Class, Interface, Operation	The <i>new</i> keyword.
override	Operation	The <i>override</i> keyword.
params	Parameter	A parameter list using the <i>params</i> keyword.
partial	Class, Interface	The <i>partial</i> keyword.
readonly	Operation with stereotype	This property only defining read code.

Tag	Applies To	Corresponds To
	<i>property</i>	
<b>sealed</b>	Operation	The <i>sealed</i> keyword.
<b>static</b>	Class	The <i>static</i> keyword.
<b>unsafe</b>	Class, Interface, Operation	The <i>unsafe</i> keyword.
<b>virtual</b>	Operation	The <i>virtual</i> keyword.
<b>writeonly</b>	Operation with stereotype <i>property</i>	This property only defining write code.

### Other Conventions

- *Namespaces* are generated for each package below a [namespace root](#) <sup>[1313]</sup>
- The *Const* property of an attribute corresponds to the *readonly* keyword, while the tag *const* corresponds to the *const* keyword
- The value of *inout* for the *Kind* property of a parameter corresponds to the *ref* keyword
- The value of *out* for the *Kind* property of a parameter corresponds to the *out* keyword
- Partial Classes can be modeled as two separate Classes with the *partial* tag
- The *Is Leaf* property of a Class corresponds to the *sealed* keyword.

### See Also

- [Import Source Code](#) <sup>[1329]</sup>
- [Generate Source Code](#) <sup>[1308]</sup>
- [C# Options](#) <sup>[1350]</sup>

### 7.2.1.5 C++ Conventions

Enterprise Architect supports round trip engineering of C++, including the [Managed C++](#) <sup>[1290]</sup> and [C++/CLI](#) <sup>[1291]</sup> extensions, where the following conventions are used.

### Stereotypes

Stereotype	Applies To	Corresponds To
<b>enumeration</b>	Class	An <i>enum</i> type.
<b>friend</b>	Operation	The <i>friend</i> keyword.
<b>property get</b>	Operation	A read property.
<b>property set</b>	Operation	A write property.
<b>struct</b>	Class	A <i>struct</i> type.
<b>typedef</b>	Class	A <i>typedef</i> statement, where the parent is the original type name.
<b>union</b>	Class	A <i>union</i> type.

### Tagged Values

Tag	Applies To	Corresponds To
<b>afx_msg</b>	Operation	The <i>afx_msg</i> keyword.
<b>anonymous</b>	Class also containing the	The name of this class being only defined by the <i>typedef</i>

Tag	Applies To	Corresponds To
	Tagged Value <i>typedef</i>	statement.
<b>attribute_name</b>	Operation with stereotype <i>property get</i> or <i>property set</i>	The name of the variable behind this property.
<b>bitfield</b>	Attribute	The size, in bits, allowed for storage of this attribute.
<b>bodyLocation</b>	Operation	The location the method body is generated to; expected values are <b>header</b> , <b>classDec</b> or <b>classBody</b> .
<b>callback</b>	Operation	A reference to the <b>CALLBACK</b> macro.
<b>explicit</b>	Operation	The <i>explicit</i> keyword.
<b>initializer</b>	Operation	A constructor initialization list.
<b>inline</b>	Operation	The <i>inline</i> keyword and inline generation of the method body.
<b>mutable</b>	Attribute	The <i>mutable</i> keyword.
<b>throws</b>	Operation	The exceptions that are thrown by this method.
<b>typedef</b>	Class with stereotype other than <i>typedef</i>	This Class being defined in a <i>typedef</i> statement.
<b>typeSynonyms</b>	Class	The <i>typedef</i> name and/or fields of this type.
<b>volatile</b>	Operation	The <i>volatile</i> keyword.

### Other conventions

- Namespaces are generated for each package below a [namespace root](#) <sup>[1315]</sup>
- By Reference* attributes correspond to a pointer to the type specified
- The *Transient* property of an attribute corresponds to the *volatile* keyword
- The *Abstract* property of an attribute corresponds to the *virtual* keyword
- The *Const* property of an operation corresponds to the *const* keyword, specifying a constant return type
- The *Is Query* property of an operation corresponds to the *const* keyword, specifying the method doesn't modify any fields
- The *Pure* property of an operation corresponds to a *pure virtual* method using the "= 0" syntax
- The *Fixed* property of a parameter corresponds to the *const* keyword.

#### See Also

- [Import Source Code](#) <sup>[1329]</sup>
- [Generate Source Code](#) <sup>[1308]</sup>
- [C++ Options](#) <sup>[1351]</sup>

#### 7.2.1.5.1 Managed C++ Conventions

The following conventions are used for managed extensions to C++ prior to [C++/CLI](#) <sup>[1291]</sup>. In order to set Enterprise Architect to generate managed C++ you must modify the C++ version in the [C++ Options](#) <sup>[1351]</sup>.

### Stereotypes

Stereotype	Applies To	Corresponds To
<b>property</b>	Operation	The <i>__property</i> keyword.
<b>property get</b>	Operation	The <i>__property</i> keyword and a read property.

Stereotype	Applies To	Corresponds To
property set	Operation	The <code>__property</code> keyword and a write property.
reference	Class	The <code>__gc</code> keyword.
value	Class	The <code>__value</code> keyword.

### Tagged Values

Tag	Applies To	Corresponds To
managedType	Class with stereotype <i>reference</i> , <i>value</i> or <i>enumeration</i> ; Interface	The keyword used in declaration of this type. Expected values are <i>class</i> or <i>struct</i> .

### Other Conventions

- The *typedef* and *anonymous* tags from native C++ are not supported
- The *Pure* property of an operation corresponds to the keyword `__abstract`.

#### See Also

- [Import Source Code](#)<sup>[1329]</sup>
- [Generate Source Code](#)<sup>[1308]</sup>

#### 7.2.1.5.2 C++/CLI Conventions

The following conventions are used for modeling C++/CLI extensions to C++. In order to set Enterprise Architect to generate managed C++/CLI you must modify the C++ version in the [C++ Options](#)<sup>[1357]</sup>.

### Stereotypes

Stereotype	Applies To	Description
event	Operation	Defines an event to provide access to the event handler for this Class.
property	Operation, Attribute	This is a property possibly containing both read and write code.
reference	Class	Corresponds to the <i>ref class</i> or <i>ref struct</i> keyword.
value	Class	Corresponds to the <i>value class</i> or <i>value struct</i> keyword.

### Tagged Values

Tag	Applies To	Description
attribute_name	Operation with stereotype <i>property</i> or <i>event</i>	The name of the variable behind this property or event.
generic	Operation	Defines the generic parameters for this Operation.
genericConstraints	Templated Class or Interface, Operation with tag <i>generic</i>	Defines the constraints on the generic parameters for this Operation.
initonly	Attribute	Corresponds to the <i>initonly</i> keyword.
literal	Attribute	Corresponds to the <i>literal</i> keyword.
managedType	Class with stereotype	Corresponds to either the <i>class</i> or <i>struct</i> keyword.

Tag	Applies To	Description
	<i>reference, value or enumeration</i> ; Interface	

### Other Conventions

- The *typedef* and *anonymous* tags are not used
- The *property get/property set* stereotypes are not used
- The *Pure* property of an operation corresponds to the keyword *abstract*.

### See Also

- [Import Source Code](#) <sup>[1329]</sup>
- [Generate Source Code](#) <sup>[1308]</sup>

### 7.2.1.6 Delphi Conventions

Enterprise Architect supports round trip engineering of Delphi, where the following conventions are used.

### Stereotypes

Stereotype	Applies To	Corresponds To
<b>constructor</b>	Operation	A constructor.
<b>destructor</b>	Operation	A destructor.
<b>dispinterface</b>	Class, Interface	A dispatch interface.
<b>enumeration</b>	Class	An enumerated type.
<b>metaclass</b>	Class	A metaclass type.
<b>object</b>	Class	An object type.
<b>operator</b>	Operation	An operator.
<b>property get</b>	Operation	A read property.
<b>property set</b>	Operation	A write property.
<b>struct</b>	Class	A record type.

### Tagged Values

Tag	Applies To	Corresponds To
<b>attribute_name</b>	Operation with stereotype <i>property get</i> or <i>property set</i>	The name of the variable behind this property.
<b>overload</b>	Operation	The <i>overload</i> keyword.
<b>override</b>	Operation	The <i>override</i> keyword.
<b>packed</b>	Class	The <i>packed</i> keyword.
<b>property</b>	Class	A property. See <a href="#">Delphi Properties</a> <sup>[1353]</sup> for more information.
<b>reintroduce</b>	Operation	The <i>reintroduce</i> keyword.



## Other Conventions

- The *Static* property of an attribute or operation corresponds to the *class* keyword
- The *Fixed* property of a parameter corresponds to the *const* keyword
- The value of *inout* for the *Kind* property of a parameter corresponds to the *Var* keyword
- The value of *out* for the *Kind* property of a parameter corresponds to the *Out* keyword.

### See Also

- [Import Source Code](#) <sup>[1329]</sup>
- [Generate Source Code](#) <sup>[1308]</sup>
- [Delphi Options](#) <sup>[1352]</sup>

### 7.2.1.7 Java Conventions

Enterprise Architect supports round trip engineering of Java - including [AspectJ](#) <sup>[1294]</sup> extensions - where the following conventions are used.

## Stereotypes

Stereotype	Applies To	Corresponds To
<b>annotation</b>	Interface	An <i>annotation</i> type.
<b>enum</b>	Attributes within a Class stereotyped <i>enumeration</i>	An <i>enumerated</i> option, distinguished from other attributes that have no stereotype.
<b>enumeration</b>	Class	An <i>enum</i> type.
<b>operator</b>	Operation	An operator.
<b>property get</b>	Operation	A read property.
<b>property set</b>	Operation	A write property.
<b>static</b>	Class or Interface	The <i>static</i> keyword.

## Tagged Values

Tag	Applies To	Corresponds To
<b>annotations</b>	Anything	The annotations on the current code feature.
<b>arguments</b>	Attribute with stereotype <i>enum</i>	The arguments that apply to this enumerated value.
<b>attribute_name</b>	Operation with stereotype <i>property get</i> or <i>property set</i>	The name of the variable behind this property.
<b>dynamic</b>	Class or Interface	The <i>dynamic</i> keyword.
<b>generic</b>	Operation	The generic parameters to this operation.
<b>parameterList</b>	Parameter	A parameter list with the ... syntax.
<b>throws</b>	Operation	The exceptions that are thrown by this method.
<b>transient</b>	Attribute	The <i>transient</i> keyword.

## Other Conventions

- Package statements are generated when the current package is not a [namespace root](#) <sup>[1313]</sup>
- The *Const* property of an attribute or operation corresponds to the final keyword

- The *Transient* property of an attribute corresponds to the volatile keyword
- The *Fixed* property of a parameter corresponds to the final keyword.

#### See Also

- [Import Source Code](#) <sup>[1329]</sup>
- [Generate Source Code](#) <sup>[1308]</sup>
- [Java Options](#) <sup>[1355]</sup>

### 7.2.1.7.1 AspectJ Conventions

The following are the conventions used for supporting AspectJ extensions to Java.

#### Stereotypes

Stereotype	Applies To	Corresponds To
<b>advice</b>	Operation	A piece of advice in an AspectJ aspect.
<b>aspect</b>	Class	An AspectJ aspect.
<b>pointcut</b>	Operation	A pointcut in an AspectJ aspect.

#### Tagged Values

Tag	Applies To	Corresponds To
<b>className</b>	Attribute or operation within a Class stereotyped <i>aspect</i>	The Classes this AspectJ intertype member belongs to.

#### Other Conventions

- The specifications of a pointcut are included in the **Behavior** field of the method.

#### See Also

- [Import Source Code](#) <sup>[1329]</sup>
- [Generate Source Code](#) <sup>[1308]</sup>

### 7.2.1.8 PHP Conventions

Enterprise Architect supports the round trip engineering of PHP 4 and 5, where the following conventions are used.

#### Stereotypes

Stereotype	Applies To	Corresponds To
<b>property get</b>	Operation	A read property.
<b>property set</b>	Operation	A write property.

#### Tagged Values

Tag	Applies To	Corresponds To
<b>attribute_name</b>	Operation with stereotype <i>property get</i> or <i>property set</i>	The name of the variable behind this property.
<b>final</b>	Operations in PHP 5.	The final keyword.

#### Common Conventions

- An unspecified type is modeled as *var*
- Methods returning a reference are generated by setting the *Return Type* to *var\**

- Reference parameters are generated from parameters with the parameter *Kind* set to *inout* or *out*.

### PHP 5 Conventions

- The *final* Class modifier corresponds to the *Is Leaf* property
- The *abstract* Class modifier corresponds to the *Abstract* property
- Parameter type hinting is supported by setting the *Type* of a parameter
- The value of *inout* or *out* for the *Kind* property of a parameter corresponds to a *reference* parameter.

#### See Also

- [Import Source Code](#) <sup>[1329]</sup>
- [Generate Source Code](#) <sup>[1308]</sup>
- [PHP Options](#) <sup>[1356]</sup>

### 7.2.1.9 Python Conventions

Enterprise Architect supports the round trip engineering of Python, where the following conventions are used.

#### Tagged values

Tag	Applies To	Corresponds To
decorators	Class, Operation	The decorators applied to this element in the source.

#### Other Conventions

- Model members with *Private Scope* correspond to code members with two leading underscores
- Attributes are only generated when the Initial value is not empty
- All types are reverse engineered as *var*.

#### See Also

- [Import Source Code](#) <sup>[1329]</sup>
- [Generate Source Code](#) <sup>[1308]</sup>
- [Python Options](#) <sup>[1356]</sup>

### 7.2.1.10 System C Conventions

Enterprise Architect supports round-trip engineering of SystemC, where the following conventions are used.

#### Stereotypes

Stereotype	Applies To	Corresponds To
<b>delegate</b>	Method	A delegate.
<b>enumeration</b>	Inner Class	An <i>enum</i> type.
<b>friend</b>	Method	A <i>friend</i> method.
<b>property</b>	Method	A property definition.
<b>sc_ctor</b>	Method	A SystemC constructor.
<b>sc_module</b>	Class	A SystemC module.
<b>sc_port</b>	Attribute	A port.
<b>sc_signal</b>	Attribute	A signal
<b>struct</b>	Inner Class	A <i>struct</i> or <i>union</i> .

## Tagged Values

Tag	Applies To	Corresponds To
<b>kind</b>	Attribute (Port)	Port kind ( <i>clocked, fifo, master, slave, resolved, vector</i> ).
<b>mode</b>	Attribute (Port)	Port mode ( <i>in, out, inout</i> ).
<b>overrides</b>	Method	The <i>Inheritance</i> list of a method declaration.
<b>throw</b>	Method	The exception specification of a method.

## Other Conventions

- SystemC also inherits most of the stereotypes and Tagged Values of [C++](#)<sup>[1289]</sup>.

## SystemC Toolbox Pages

To access the **SystemC** pages of the **Toolbox**, select the **More tools | HDL | SystemC Constructs** menu option. Drag these icons onto a diagram to model a SystemC design.

Page	Item	Use To
SystemC	Module	Define a SystemC Module. An <i>sc_module</i> -stereotyped Class element.
	Enumeration	Define an Enumerated Type. An <i>enumeration</i> -stereotyped Enumeration element.
	Struct	Define a Structure. A <i>struct</i> -stereotyped Class element.
SystemC Features	Port	Define a SystemC Port. An <i>sc_port</i> -stereotyped attribute.
	Signal	Define a SystemC Signal. An <i>sc_signal</i> -stereotyped attribute.
	Constructor	Define a SystemC Constructor. An <i>sc_ctor</i> -stereotyped method.

### See Also

- [Import Source Code](#)<sup>[1329]</sup>
- [Generate Source Code](#)<sup>[1308]</sup>
- [SystemC Options](#)<sup>[1357]</sup>

### 7.2.1.11 VB.Net Conventions

Enterprise Architect supports round-trip engineering of Visual Basic.Net, where the following conventions are used. Earlier versions of [Visual Basic](#)<sup>[1307]</sup> are supported as a different language.

## Stereotypes

Stereotype	Applies To	Corresponds To
<b>event</b>	Operation	An event declaration.
<b>import</b>	Operation	An operation to be imported from another library.
<b>module</b>	Class	A module.

Stereotype	Applies To	Corresponds To
<b>operator</b>	Operation	An operator overload definition.
<b>partial</b>	Operation	The <i>partial</i> keyword on an operation.
<b>property</b>	Operation	A property possibly containing both read and write code.

## Tagged Values

Tag	Applies To	Corresponds To
<b>Alias</b>	Operation with stereotype <i>import</i>	The alias for this imported operation.
<b>attribute_name</b>	Operation with stereotype <i>property</i>	The name of the variable behind this property.
<b>Charset</b>	Operation with stereotype <i>import</i>	The <i>character set</i> clause for this import. One of the values <i>Ansi</i> , <i>Unicode</i> or <i>Auto</i> .
<b>delegate</b>	Operation	The <i>Delegate</i> keyword.
<b>enumTag</b>	Operation with stereotype <i>property</i>	The datatype that this property is represented as.
<b>Handles</b>	Operation	The <i>handles</i> clause on this operation.
<b>Implements</b>	Operation	The <i>implements</i> clause on this operation.
<b>Lib</b>	Operation with stereotype <i>import</i>	The library this import comes from.
<b>MustOverride</b>	Operation	The <i>MustOverride</i> keyword.
<b>Narrowing</b>	Operation with stereotype <i>operator</i>	The <i>Narrowing</i> keyword.
<b>NotOverrideable</b>	Operation	The <i>NotOverrideable</i> keyword.
<b>Overloads</b>	Operation	The <i>Overloads</i> keyword.
<b>Overrides</b>	Operation	The <i>Overrides</i> keyword.
<b>parameterArray</b>	Parameter	A parameter list using the <i>ParamArray</i> keyword.
<b>partial</b>	Class, Interface	The <i>Partial</i> keyword.
<b>readonly</b>	Operation with stereotype <i>property</i>	This property only defining read code.
<b>shadows</b>	Class, Interface, Operation	The <i>Shadows</i> keyword.
<b>Shared</b>	Attribute	The <i>Shared</i> keyword.
<b>Widening</b>	Operation with stereotype <i>operator</i>	The <i>Widening</i> keyword.
<b>writeonly</b>	Operation with stereotype <i>property</i>	This property only defining write code.

## Other Conventions

- Namespaces are generated for each package below a [namespace root](#) <sup>[1315]</sup>
- The *Is Leaf* property of a Class corresponds to the *NotInheritable* keyword
- The *Abstract* property of a Class corresponds to the *MustInherit* keyword
- The *Static* property of an attribute or operation corresponds to the *Shared* keyword
- The *Abstract* property of an operation corresponds to the *MustOverride* keyword
- The value of *in* for the *Kind* property of a parameter corresponds to the *ByVal* keyword

- The value of *inout* or *out* for the *Kind* property of a parameter corresponds to the *ByRef* keyword.

#### See Also

- [Import Source Code](#) <sup>[1329]</sup>
- [Generate Source Code](#) <sup>[1308]</sup>
- [VB.Net Options](#) <sup>[1356]</sup>

### 7.2.1.12 Verilog Conventions

Enterprise Architect supports round-trip engineering of Verilog, where the following conventions are used.

#### Stereotypes

Stereotype	Applies To	Corresponds To
asynchronous	Method	A concurrent process.
enumeration	Inner Class	An <i>enum</i> type.
initializer	Method	An initializer process.
module	Class	A module.
part	Attribute	A component instantiation.
port	Attribute	A port.
synchronous	Method	A sequential process.

#### Tagged Values

Tag	Applies To	Corresponds To
kind	Attribute (signal)	The signal kind (such as <i>register</i> , <i>bus</i> ).
mode	Attribute (port)	The port mode ( <i>in</i> , <i>out</i> , <i>inout</i> ).
Portmap	Attribute (part)	The generic / port map of the component instantiated.
sensitivity	Method	The sensitivity list of a sequential process.
type	Attribute	The range or type value of an attribute.

#### Verilog Toolbox Pages

To access the **Verilog** pages of the **Toolbox**, select the **More tools | HDL | Verilog Constructs** menu option. Drag these icons onto a diagram to model a Verilog design.

Page	Item	Use To
Verilog	Module	Define a Verilog Module. A <i>module</i> -stereotyped Class element.
	Enumeration	Define an Enumerated Type. An <i>enumeration</i> -stereotyped Class element.
Verilog Features	Port	Define a Verilog Port. A <i>port</i> -stereotyped attribute.
	Part	Define a Verilog component instantiation A <i>part</i> -stereotyped attribute.

Page	Item	Use To
	Attribute	Define an attribute.
	Procedure <ul style="list-style-type: none"> <li>• Concurrent</li> <li>• Sequential</li> <li>• Initializer.</li> </ul>	Define a Verilog process: <ul style="list-style-type: none"> <li>• An <i>asynchronous</i>-stereotyped method</li> <li>• A <i>synchronous</i>-stereotyped method</li> <li>• An <i>initializer</i>-stereotyped method.</li> </ul>

#### See Also

- [Import Source Code](#) <sup>[1329]</sup>
- [Generate Source Code](#) <sup>[1308]</sup>
- [Verilog Options.](#) <sup>[1358]</sup>

### 7.2.1.13 VHDL Conventions

Enterprise Architect supports round-trip engineering of VHDL, where the following conventions are used.

#### Stereotypes

Stereotype	Applies To	Corresponds To
<b>architecture</b>	Class	An architecture.
<b>asynchronous</b>	Method	An asynchronous process.
<b>configuration</b>	Method	A configuration.
<b>enumeration</b>	Inner Class	An <i>enum</i> type.
<b>entity</b>	Interface	An entity.
<b>part</b>	Attribute	A component instantiation.
<b>port</b>	Attribute	A port.
<b>signal</b>	Attribute	A signal declaration.
<b>struct</b>	Inner Class	A record definition.
<b>synchronous</b>	Method	A synchronous process.
<b>typedef</b>	Inner Class	A <i>type</i> or <i>subtype</i> definition.

#### Tagged Values

Tag	Applies To	Corresponds To
<b>isGeneric</b>	Attribute (port)	The port declaration in a generic interface.
<b>isSubType</b>	Inner Class (typedef)	A subtype definition.
<b>kind</b>	Attribute (signal)	The signal kind (such as <i>register</i> , <i>bus</i> ).
<b>mode</b>	Attribute (port)	The port mode ( <i>in</i> , <i>out</i> , <i>inout</i> , <i>buffer</i> , <i>linkage</i> ).
<b>portmap</b>	Attribute (part)	The generic / port map of the component instantiated.
<b>sensitivity</b>	Method (synchronous)	The sensitivity list of a synchronous process.

Tag	Applies To	Corresponds To
<b>type</b>	Inner Class (typedef)	The type indication of a type declaration.
<b>typeNameSpace</b>	Attribute (part)	The type namespace of the instantiated component.

## VHDL Toolbox Pages

To access the **VHDL** pages of the **Toolbox**, select the **More tools | HDL | VHDL Constructs** menu option. Drag these icons onto a diagram to model a VHDL design.

Page	Item	Use To
<b>VHDL</b>	Architecture	Define an architecture to be associated with a VHDL entity. <i>An architecture-stereotyped Class element.</i>
	Entity	Define a VHDL entity to contain the Port definitions. <i>An entity-stereotyped interface element.</i>
	Enumeration	Define an Enumerated Type. <i>An enumeration-stereotyped enumeration element.</i>
	Struct	Define a VHDL record. <i>A struct-stereotyped Class element.</i>
	Typedef	Define a VHDL type or subtype <i>A typedef-stereotyped Class element.</i>
<b>VHDL Features</b>	Port	Define a VHDL Port. <i>A port-stereotyped attribute.</i>
	Part	Define a VHDL component instantiation <i>A part-stereotyped attribute.</i>
	Signal	Define a VHDL signal. <i>A signal-stereotyped attribute.</i>
	Procedure <ul style="list-style-type: none"> <li>• Concurrent</li> <li>• Sequential</li> <li>• Configuration</li> </ul>	Define a VHDL process: <ul style="list-style-type: none"> <li>• An <i>asynchronous</i>-stereotyped method</li> <li>• A <i>synchronous</i>-stereotyped method</li> <li>• A <i>configuration</i>-stereotyped method.</li> </ul>

### See Also

- [Import Source Code](#) <sup>[1329]</sup>
- [Generate Source Code](#) <sup>[1308]</sup>
- [VHDL Options.](#) <sup>[1359]</sup>



### 7.2.1.14 Visual Basic Conventions

Enterprise Architect supports the round trip engineering of Visual Basic 5 and 6, where the following conventions are used. [Visual Basic .Net](#)<sup>[1296]</sup> is supported as a different language.

#### Stereotypes

Stereotype	Applies To	Corresponds To
<b>global</b>	Attribute	The <i>Global</i> keyword.
<b>import</b>	Operation	An operation to be imported from another library.
<b>property get</b>	Operation	A property get.
<b>property set</b>	Operation	A property set.
<b>property let</b>	Operation	A property let.
<b>with events</b>	Attribute	The <i>WithEvents</i> keyword.

#### Tagged Values

Tag	Applies To	Corresponds To
<b>Alias</b>	Operation with stereotype <i>import</i>	The alias for this imported operation.
<b>attribute_name</b>	Operation with stereotype <i>property get</i> , <i>property set</i> or <i>property let</i>	The name of the variable behind this property.
<b>Lib</b>	Operation with stereotype <i>import</i>	The library this import comes from.
<b>New</b>	Attribute	The <i>New</i> keyword.

#### Other Conventions

- The value of *in* for the *Kind* property of a parameter corresponds to the *ByVal* keyword
- The value of *inout* or *out* for the *Kind* property of a parameter corresponds to the *ByRef* keyword.

#### See Also

- [Import Source Code](#)<sup>[1329]</sup>
- [Generate Source Code](#)<sup>[1308]</sup>
- [Visual Basic Options](#)<sup>[1360]</sup>

## 7.2.2 Code Template Framework

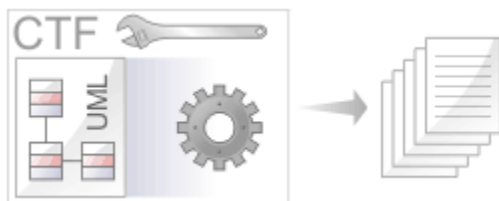

The Code Template Framework (CTF) is used during forward engineering of UML models. The CTF enables you to:

- Generate source code from UML models
- Customize the way in which Enterprise Architect generates source code
- Forward engineer languages not specifically supported by Enterprise Architect.

The CTF consists of:

- Default [Code Templates](#) <sup>[1302]</sup> which are built into Enterprise Architect for forward engineering supported languages
- A [Code Template Editor](#) <sup>[1305]</sup> for creating and maintaining user-defined Code Templates
- Code Templates to [synchronize code](#) <sup>[1307]</sup>.

### 7.2.2.1 Code Templates

Code templates enable you to customize code generation of existing languages. For example:

- Modify the file headers created when generating new files
- Change the style of the generated code (such as indenting or brace position) to match the required coding standards
- Handle particular stereotypes to generate things like specialized method bodies and extra methods.

They also enable you to add code generation of entirely new languages that Enterprise Architect would otherwise not be able to handle. In this situation it is most useful to combine code templates with an [MDG technology file](#) <sup>[1128]</sup> that includes the datatypes, and options for default file extensions.

Enterprise Architect's [base code templates](#) <sup>[1302]</sup> specify the transformation from UML elements to the various parts of a given programming language. The templates are written as plain text with a syntax that shares some aspects of both mark-up languages and scripting languages. A simple example of a template used by Enterprise Architect is the 'Class template'. It is used to generate source code from a UML Class:

```
%ClassNotes%
%ClassDeclaration%
%ClassBody%
```

The above template simply refers to three other templates, namely *ClassNotes*, *ClassDeclaration* and *ClassBody*. The enclosing percent (%) signs indicate a *macro*. Code Templates consist of various types of macros, each resulting in a substitution in the generated output. For a language such as C++, the result of processing the above template might be:

```
/**
 * This is an example class note generated using code templates
 * @author Sparx Systems
 */
class ClassA: public ClassB
{
...
}
```

### Execution of Code Templates

A reference to a template (such as the `%ClassNotes%` macro, from our example above) results in the execution of that template.

Each template is designed for use with a particular element. For example the *ClassNotes* template is to be used with UML Class elements.

The element that is currently being generated is said to be *in scope*. If the element in scope is stereotyped Enterprise Architect looks for a template that has been defined for that stereotype. If a match is found, the specialized template is executed. Otherwise the default implementation of the base template is used.

Templates are processed sequentially, line by line, replacing each macro with its underlying text value from the model.

#### 7.2.2.1.1 Base Templates

The Code Template Framework consists of a number of base templates. Each base template transforms particular aspects of the UML to corresponding parts of object-oriented languages.

The following table lists and briefly describes the base templates used in the CTF.

Template	Description
Attribute	A top-level template to generate member variables from UML attributes.
Attribute Declaration	Used by the <i>Attribute</i> template to generate a member variable declaration.
Attribute Notes	Used by the <i>Attribute</i> template to generate member variable notes.

Template	Description
Class	A top-level template for generating Classes from UML Classes.
Class Base	Used by the <i>Class</i> template to generate a base Class name in the inheritance list of a derived Class, where the base Class doesn't exist in the model.
Class Body	Used by the <i>Class</i> template to generate the body of a Class.
Class Declaration	Used by the <i>Class</i> template to generate the declaration of a Class.
Class Interface	Used by the <i>Class</i> template to generate an interface name in the inheritance list of a derived Class, where the interface doesn't exist in the model.
Class Notes	Used by the <i>Class</i> template to generate the Class notes.
File	A top-level template for generating the source file. For languages such as C++, this corresponds to the header file.
Import Section	Used in the <i>File</i> template to generate external dependencies.
Linked Attribute	A top-level template for generating attributes derived from UML Associations.
Linked Attribute Notes	Used by the <i>Linked Attribute</i> template to generate the attribute notes.
Linked Attribute Declaration	Used by the <i>Linked Attribute</i> template to generate the attribute declaration.
Linked Class Base	Used by the <i>Class</i> template to generate a base Class name in the inheritance list of a derived Class, for a Class element in the model that is a parent of the current Class.
Linked Class Interface	Used by the <i>Class</i> template to generate an Interface name in the inheritance list of a derived Class, for an Interface element in the model that is a parent of the current Class.
Namespace	A top-level template for generating namespaces from UML packages. (Although not all languages have namespaces, this template can be used to generate an equivalent construct, such as packages in Java.)
Namespace Body	Used by the <i>Namespace</i> template to generate the body of a namespace.
Namespace Declaration	Used by the <i>Namespace</i> template to generate the namespace declaration.
Operation	A top-level template for generating operations from a UML Class's operations.
Operation Body	Used by the <i>Operation</i> template to generate the body of a UML operation.
Operation Declaration	Used by the <i>Operation</i> template to generate the operation declaration.
Operation Notes	Used by the <i>Operation</i> template to generate documentation for an operation.
Parameter	Used by the <i>Operation Declaration</i> template to generate parameters.

The second table lists templates used for generating code for languages that have separate interface and implementation sections.

Template	Description
Class Impl	A top-level template for generating the implementation of a Class.
Class Body Impl	Used by the <i>Class Impl</i> template to generate the implementation of Class members.
File Impl	A top-level template for generating the implementation file.

Template	Description
File Notes Impl	Used by the <i>File Impl</i> template to generate notes in the source file.
Import Section Impl	Used by the <i>File Impl</i> template to generate external dependencies.
Operation Impl	A top-level template for generating operations from a UML Class's operations.
Operation Body Impl	Used by the <i>Operation</i> template to generate the body of a UML operation.
Operation Declaration Impl	Used by the <i>Operation</i> template to generate the operation declaration.
Operation Notes Impl	Used by the <i>Operation</i> template to generate documentation for an operation.

The base templates form a hierarchy, which varies slightly across different programming languages. A typical template hierarchy relevant to a language like C# or Java (which do not have header files) is shown in the example diagram below. In this diagram the templates are modeled as Classes (in reality they are just plain text). This hierarchy would be slightly more complicated for languages like C++ and Delphi, which have separate implementation templates.

Each of the base templates must be specialized to be of use in code engineering. In particular, each template is specialized for the supported languages (or 'products'). For example, there is a *ClassBody* template defined for C++, another for C#, another for Java, and so on. By specializing the templates, you can tailor the code generated for the corresponding UML entity.

Once the base templates are specialized for a given language, they can be further specialized based on:

- A Class's stereotype
- A feature's stereotype (where the feature can be an operation or attribute)

This type of specialization enables, for example, a C# operation that is stereotyped as «property» to have a different *Operation Body* template from an ordinary operation. The *Operation Body* template can then be specialized further, based on the Class stereotype.

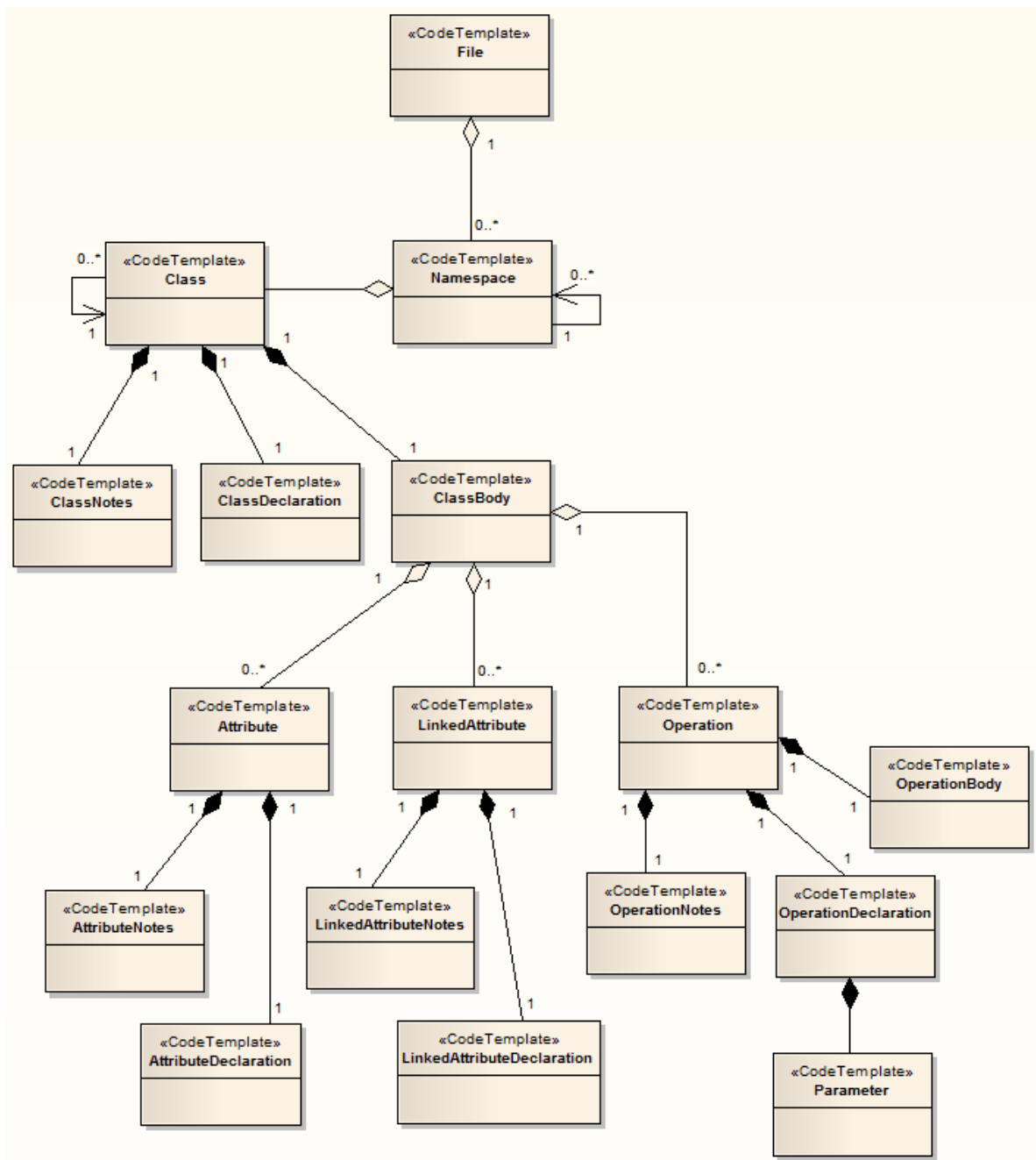
**Note:**

The above Class Model shows the hierarchy of Code Generation templates for a language such as C# or Java. The Aggregation connectors denote references between templates.

### 7.2.2.2 The Code Template Editor

The Code Template Editor provides the facilities of the *Common Code Editor*, including intellisense for the various macros. For more information on intellisense and the Common Code Editor, see the [Code Editors](#) <sup>1428</sup> topic.

To access the **Code Template Editor** window, select the **Settings | Code Generation Templates** menu option.

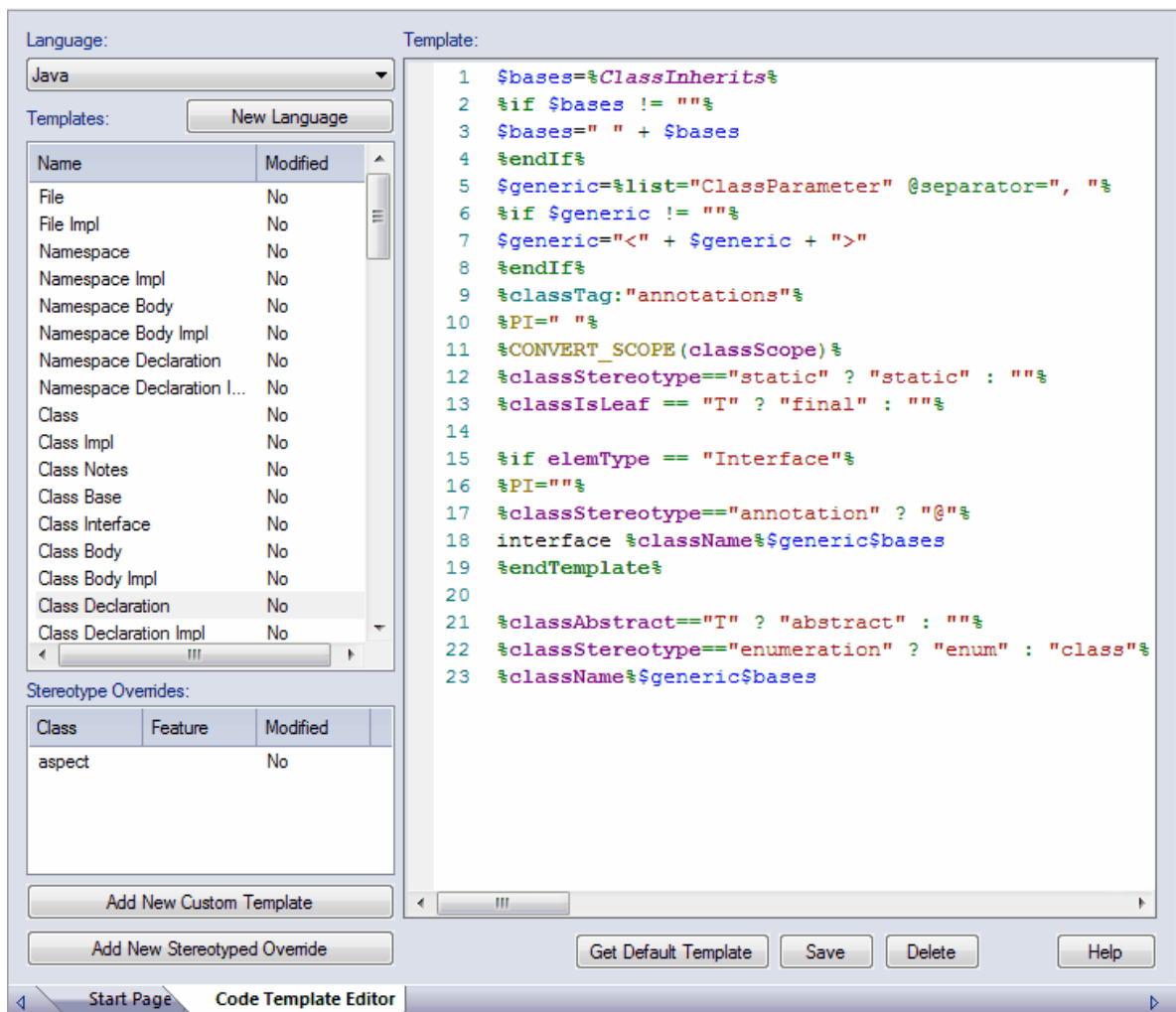

Option	Use to
Language	Select the programming language.
New Language	Display the <a href="#">Programming Languages Datatypes</a> <sup>666</sup> dialog, which enables you to include programming languages other than those supported for Enterprise Architect, for which to create or edit code templates.
Template	Display the contents of the active template, and provides the editor for modifying templates.
Templates	List the base code templates. The active template is highlighted. The <b>Modified</b> field indicates whether you have changed the default template for the current language.
Stereotype Overrides	List the stereotyped templates, for the active base template. The <b>Modified</b> field indicates whether you have modified a default stereotyped template.
Add New Custom Template	Invoke a dialog for creating a custom stereotyped template.
Add New Stereotyped Override	Invoke a dialog for adding a stereotyped template, for the currently selected base template.
Get Default Template	Update the editor display with the default version of the active template.

Option	Use to
Save	Overwrite the active templates with the contents of the editor.
Delete	If you have overridden the active template, the override is deleted and replaced by the corresponding default code template.

For information on creating and editing code templates using the [Code Template Editor](#) window, see [The Code Template Editor in MDG Development](#)<sup>[1202]</sup>,<sup>[1202]</sup>

**Note:**

User-modified and user-defined Code Templates can be imported and exported as Reference Data (see the [Sharing Reference Data](#)<sup>[223]</sup> topic). The templates defined for each language are indicated in the [Export Reference Data](#) dialog by the language name with the suffix `_Code_Templates`. If no templates exist for a language, there is no entry for the language in the dialog.

### 7.2.2.3 Synchronize Code

Enterprise Architect uses code templates during the forward synchronization of the following programming languages:

- ActionScript
- C
- C++
- C#
- Delphi
- Java
- PHP
- Python
- VB
- VB.Net

Only a subset of the code templates are used during synchronization. This subset corresponds to the distinct sections that Enterprise Architect recognizes in the source code. The following table lists the code templates and their corresponding code sections, which can be synchronized.

Code Template	Code Section
Class Notes	Comments preceding Class declaration.
Class Declaration	Up to and including Class parents.
Attribute Notes	Comments preceding Attribute declaration.
Attribute Declaration	Up to and including terminating character.
Operation Notes	Comments preceding operation declaration.
Operation Notes Impl	As for <i>Operation Notes</i> .
Operation Declaration	Up to and including terminating character.
Operation Declaration Impl	Up to and including terminating character.
Operation Body	Everything between and including the braces.
Operation Body Impl	As for <i>Operation Body</i> .

Three types of change can occur in the source when it is synchronized with the UML model:

- [Synchronize Existing Sections](#)<sup>[1308]</sup>: for example, changing the return type in an operation declaration
- [Add New Sections to Existing Features](#)<sup>[1308]</sup>: for example, adding notes to a Class declaration, where there were previously none

- [Add New Features and Elements](#)<sup>[1308]</sup>: for example, adding a new operation to a Class.

Each of these changes must be handled differently by Enterprise Architect; their effect on the CTF is described in the linked topics above.

### 7.2.2.3.1 Synchronize Existing Sections

When an existing section in the source code differs from the result generated by the corresponding template, that section is replaced. Consider for example, the following C++ Class declaration:

```
[asm] class A: public B
```

Now assume you add an inheritance relationship from Class A to Class C; the entire Class declaration would be replaced with something like:

```
[asm] class A: public B, public C
```

### 7.2.2.3.2 Add New Sections

The following can be added as new sections, to existing features in the source code:

- Class Notes
- Attribute Notes
- Operation Notes
- Operation Notes Impl
- Operation Body
- Operation Body Impl

Assume Class **A** from the previous example had no note when you originally generated the code. Now assume that you specify a note in the model for Class A. Enterprise Architect attempts to add the new note from the model during synchronization. It does this by executing the *Class Notes* template.

To make room for the new section to be inserted, you can specify how much white space to append to the section via synchronization macros. These macros are described in the [Control Macros](#)<sup>[1192]</sup> topic.

### 7.2.2.3.3 Add New Features and Elements

The following features and elements can be added to the source code during synchronization:

- Attributes
- Inner Classes
- Operations.

These are added by executing the relevant templates for each new element or feature in the model. Enterprise Architect attempts to preserve the appropriate indenting of new features in the code, by finding the indents specified in list macros of the Class. For languages that make use of namespaces, the *synchNamespaceBodyIndent* macro is available. Classes defined within a (non-global) namespace are indented according to the value set for this macro, during synchronization. This value is ignored for Classes defined within a package setup as a root namespace, or if the **Generate Namespace** option is set to **False** in the appropriate language page (C#, C++ or VB.Net) on the **Options** dialog (**Tools | Options | Source Code Engineering | <language>**).

## 7.2.3 Generate Source Code

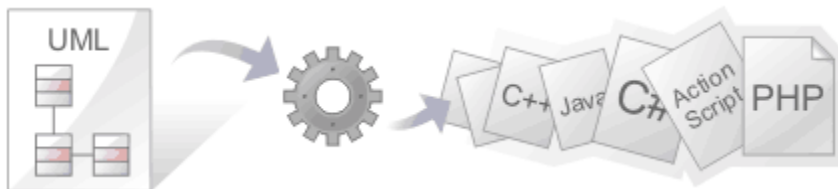

Generating source code (forward engineering) takes the UML Class or Interface model elements and creates a source code equivalent for future elaboration and compilation. By forward engineering code from the model, the mundane work involved with having to key in Classes and attributes and methods is avoided, and symmetry between model and code is ensured.

Code is generated from *Class* or *Interface* model elements, so you must create the required Class and Interface elements to generate from. Add attributes (which become variables) and operations (which become



methods).

Before you generate code, you should ensure the default settings for code generation match your requirements. The default generation settings are located in the **Source Code Engineering** page of the **Options** dialog (select the **Tools | Options | Source Code Engineering** menu option). Set up the defaults to match your required language and preferences. Preferences that you can define include default constructors and destructors, methods for interfaces and the Unicode options for created languages. Languages such as Java support **namespaces** and can be configured to specify a namespace root. In addition to the default settings for generating code, Enterprise Architect supports the following code languages with their own specific code generation options:

- [ActionScript](#)
- [C](#)
- [C#](#) (for both .NET 1.1 and .NET 2.0)
- [C++](#) (standard, plus .NET managed C++ extensions)
- [Delphi](#)
- [Java](#) (including Java 1.5, Aspects and Generics)
- [PHP](#)
- [Python](#)
- [Visual Basic](#)
- [Visual Basic .NET](#)

The **Code Template Framework (CTF)** enables you to customize the way Enterprise Architect generates source code and also enables generation of languages that are not specifically supported by Enterprise Architect.

Before generating code, you should also familiarize yourself with the way Enterprise Architect handles local path names. Local path names enable you to substitute tags for directory names (for example %SRC% = C:\Source).

When you have completed the design of your Classes, you can generate source code.

#### Note:

In the Corporate, Business and Software Engineering, System Engineering and Ultimate editions of Enterprise Architect, if security is enabled you must have **Generate Source Code and DDL** permission to generate source code.

## Use Live Code Generation

On the **Package Build Scripts** dialog, you have the option to update your source code instantly as you make changes to your model.

## Tasks

When you generate code, you perform one or more of the following tasks:

- [Generate a Single Class](#)
- [Generate a Group of Classes](#)
- [Generate a Package](#)
- [Update Package Contents](#)

### 7.2.3.1 Generate a Single Class

To generate code for a single Class, first ensure the design of the model element (Class or Interface) is complete. Also ensure you have added Inheritance connectors to parents and associations to other Classes that are used. Also add Inheritance connectors to Interfaces that your Class implements; Enterprise Architect offers the option to generate function stubs for all interface methods that a Class implements. Once the design is satisfactory, follow the steps below.

## Generate Code for a Single Class

1. Open the diagram containing the Class or Interface for which to generate code.
2. Right-click on the required Class or Interface to display the context menu and select the **Generate Code** menu option, or press **[F11]**. The **Generate Code** dialog displays, which enables you to control how and where your source code is generated.

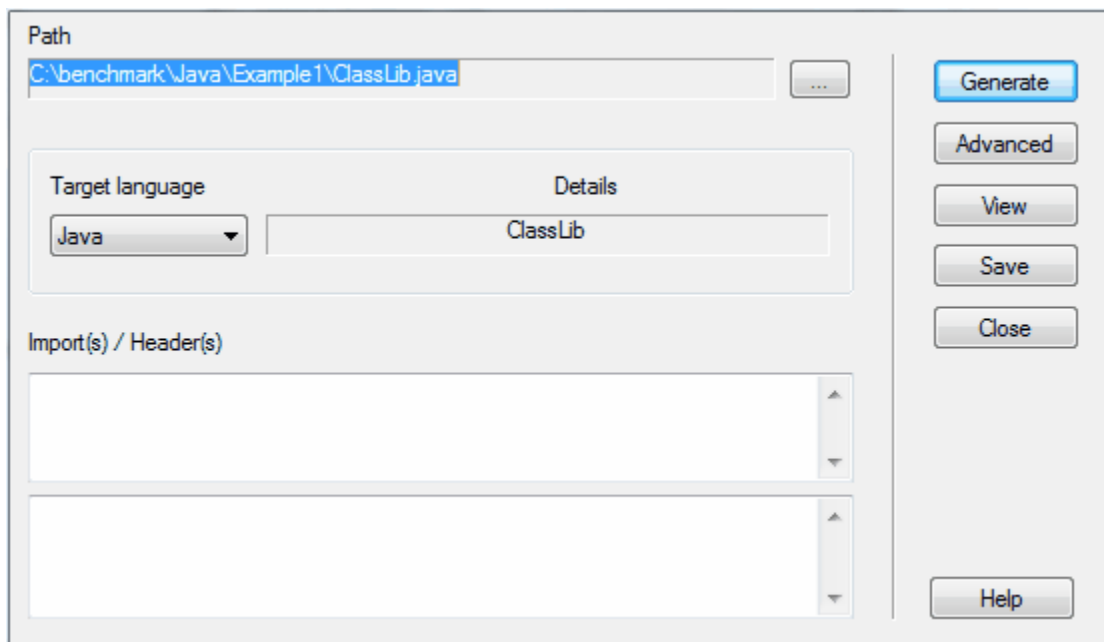

3. On the **Path** field, click on [ ... ] (Browse) and select a path name for your source code to be generated to.
4. In the **Target Language** field, click on the drop-down arrow and select the language to generate; this becomes the permanent option for that Class, so change it back if you are only doing one pass in another language.
5. Click on the **Advanced** button. The **Object Options** dialog displays.

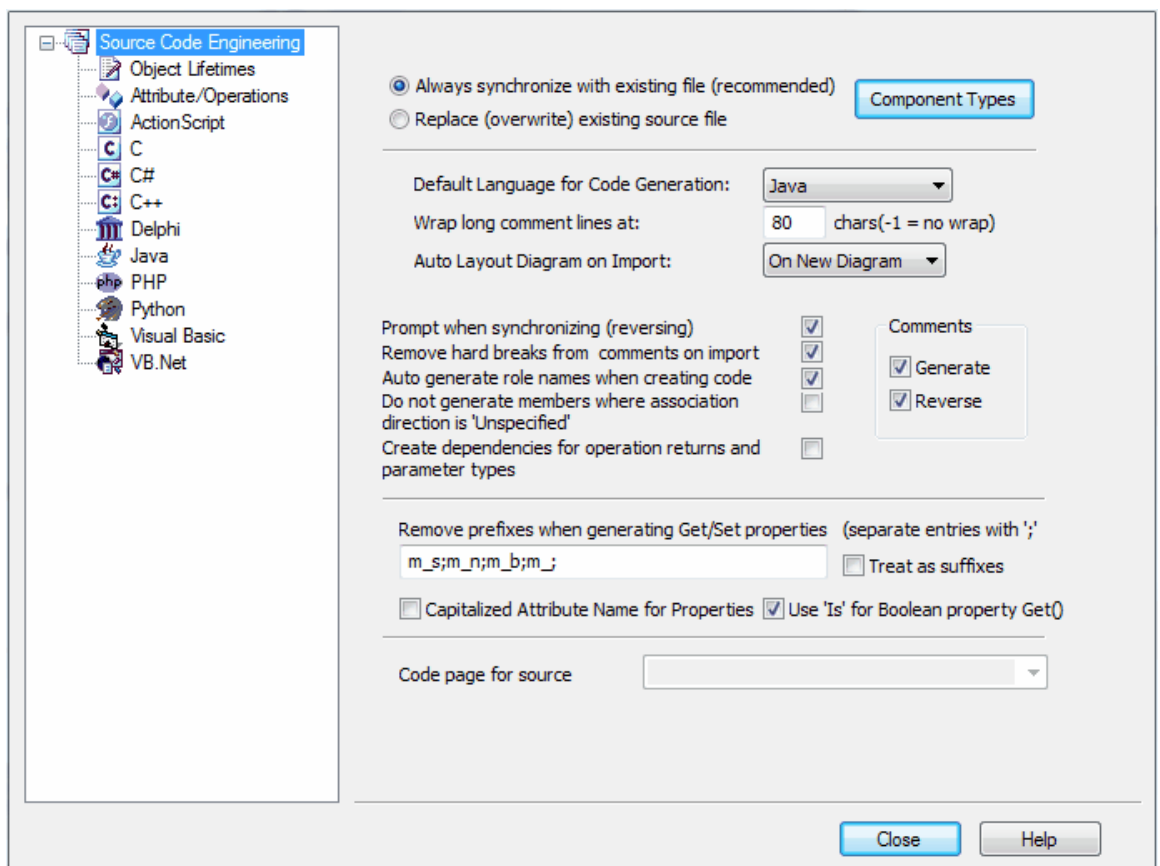

6. Set any custom options (for this Class alone), then click on the **Close** button to return to the **Generate Code** dialog.
7. In the **Import(s) / Header(s)** fields, type any import statements, *#includes* or other header information. (Note that in the case of Visual Basic this information is ignored; in the case of Java the two import text boxes are merged; and in the case of C++ the first import text area is placed in the header file and the second in the body (.cpp) file.)
8. Click on the **Generate** button to create the source code.
9. When complete, click on the **View** button to see what has been generated. Note that you should set up your **default viewer** <sup>1444</sup>/editor for each language type first. You can also set up the default editor on the **Code Editors** page of the **Options** dialog (**Tools | Options | Source Code Engineering | Code Editors**).

### 7.2.3.2 Generate a Group of Classes

In addition to being able to generate code for an individual Class, you can also select a group of Classes for batch code generation. When you do this, you accept all the default code generation options for each Class in the set.

#### To Generate Multiple Classes

1. Select a group of Classes and/or interfaces in a diagram.
2. Right-click on an element in the group to display the context menu.
3. Select the **Code Generation | Generate Selected elements** menu option. The **Save As** dialog displays, on which you specify the file path and name for each code file. Enter this information and click on the **Save** button.
4. The **Batch Generation** dialog displays, showing the status of the process as it executes (the process might be too fast to see this dialog).

#### Note:

If any of the elements selected are not Classes or interfaces the option to generate code is not available.

### 7.2.3.3 Generate a Package

In addition to generating source code from single Classes and groups of Classes, you can also generate code from a package. This feature provides options to recursively generate child packages and automatically generate directory structures based on the package hierarchy. This enables you to generate a whole branch of your project model in one step.

#### Generate a Package

To generate a package, follow the steps below:

1. In the **Project Browser**, right-click on the package to generate code for. The context menu displays.
2. Select the **Code Engineering | Generate Source Code** menu option. The **Generate Package Source Code** dialog displays.

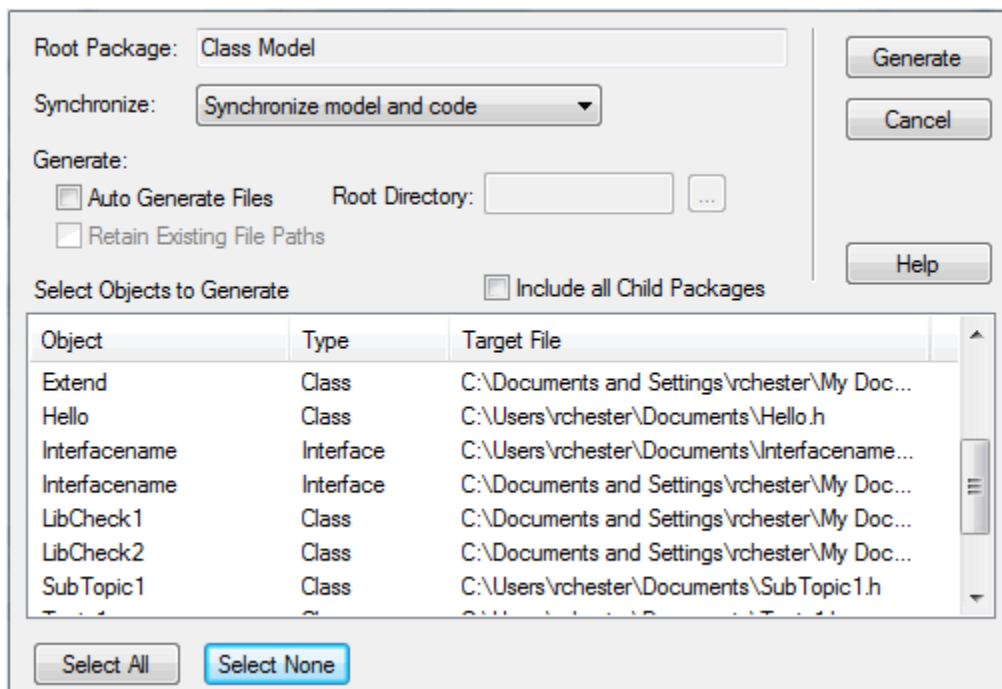

3. In the **Synchronize** field, click on the drop-down arrow and select the appropriate synchronize option:
  - **Synchronize model and code**: Classes with existing files are forward synchronized with that file; Classes with no existing file are generated to the displayed target file
  - **Overwrite code**: All selected target files are overwritten (forward generated)
  - **Do not generate**: Only selected Classes that do not have an existing file are generated; all other Classes are ignored.
4. Highlight the Classes to generate. Leave unselected any to not generate. If you want to display the information in a more readable layout, you can resize the dialog and its columns.
5. To make Enterprise Architect automatically generate directories and filenames based on the package hierarchy, select the **Auto Generate Files** checkbox. This then enables the **Root Directory** field, in which you select a root directory under which the source directories are to be generated. By default, the **Auto Generate Files** feature *ignores* any file paths that are already associated with a Class. You can change this behavior by also selecting the **Retain Existing File Paths** checkbox.
6. To include all sub-packages in the output, select the **Include Child Packages** checkbox.
7. Click on the **Generate** button to start generating code.

As code generation proceeds Enterprise Architect displays progress messages. If a Class requires an output filename Enterprise Architect prompts you to enter one at the appropriate time (assuming **Auto Generate Files** is not selected). For example, if the selected Classes include partial Classes, a prompt displays to enter the filename for the second partial Class.

For additional information on the options on the **Generate Package Source Code** dialog, see the following table:

Option	Use to
<b>Root Package</b>	Check the name of the package to be generated.
<b>Synchronize</b>	Select options that specify how existing files should be generated.
<b>Auto Generate Files</b>	Specify whether Enterprise Architect should automatically generate file names and directories, based on the package hierarchy.
<b>Root Directory</b>	If <b>Auto Generate Files</b> is selected, display the path under which the generated directory structures are created.
<b>Retain Existing File Paths</b>	If <b>Auto Generate Files</b> is selected, specify whether to use existing file paths associated with Classes. If unselected, Enterprise Architect generates

Option	Use to
	Classes to automatically determined paths, regardless of whether source files are already associated with Classes.
<b>Include all Child Packages</b>	Include all Classes from all sub-packages of the target package in the list. This option facilitates recursive generation of a given package and its sub-packages.
<b>Select Objects to Generate</b>	List all Classes that are available for generation under the target packages. Only selected (highlighted) Classes are generated. Classes are listed with their target source file.
<b>Select All</b>	Mark all Classes in the list as selected.
<b>Select None</b>	Mark all Classes in the list as unselected.
<b>Generate</b>	Start the generation of all selected Classes.
<b>Cancel</b>	Exit the <b>Generate Package Source Code</b> dialog. No Classes are generated.

### 7.2.3.4 Update Package Contents

Enterprise Architect enables you to synchronize a directory tree. Follow the steps below:

1. In the **Project Browser**, right-click on the root package of the tree to synchronize. The context menu displays.
2. Select the **Code Engineering | Synchronize Package With Code** menu option. The **Synchronize Package Contents** dialog displays.

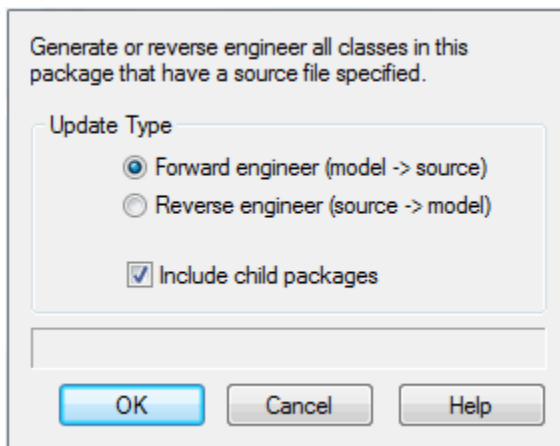

3. In the **Update Type** panel, select the radio button to **Forward Engineer** or **Reverse Engineer** the package Classes.
4. To include child packages in the synchronization, select the **Include child packages in generation** checkbox.
5. Click on the **OK** button to start.

Enterprise Architect uses the directory names specified when the project source was first imported/generated and updates either the model or the source code depending on the option chosen.

### 7.2.3.5 Namespaces

Languages such as Java support package structures or namespaces. Enterprise Architect lets you specify a package as a namespace root, which denotes where the namespace structure starts; all subordinate packages below this point are generated as namespaces to code.

To define a package as a namespace root, right-click on the package in the **Project Browser** and select the **Code Engineering | Set as Namespace Root** context menu option. The package icon in the **Project Browser** changes to include a colored corner (  ).

When you have set the namespace root, the menu option changes to **Clear Namespace Root**; click on this option to take the namespace root status off the package. (Also, see the context menu described below.)

Once you have set a namespace root, Java code generated beneath this root automatically adds a package declaration at the head of the generated file indicating the current package location.

To view a list of namespaces, select the **Settings | Namespaces** menu option. The **Namespaces** dialog displays.

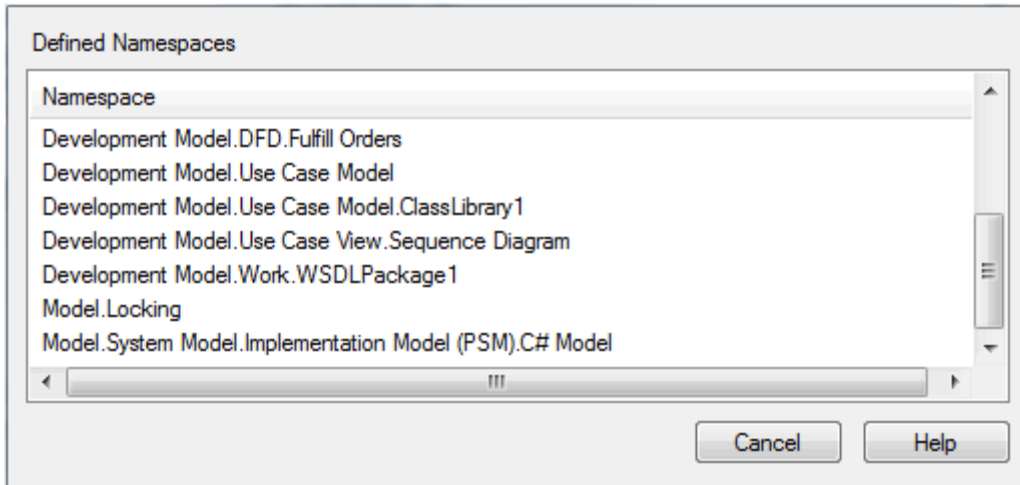

If you double-click on a namespace in the list, the package is highlighted in the **Project Browser**. Alternatively, right-click on the namespace to display a context menu, and select the **Locate Package in Browser** menu option.

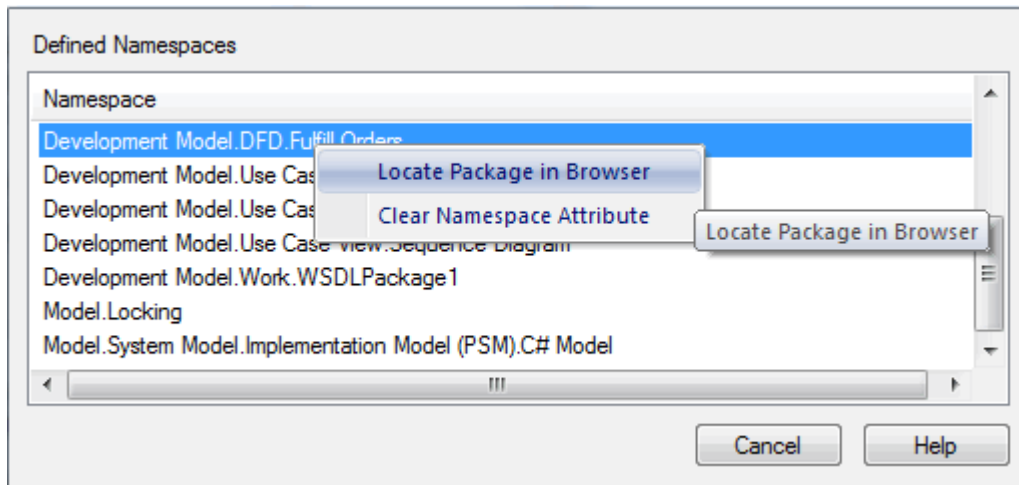

You can also clear the selected namespace, by selecting the **Clear Namespace Attribute** option.

### 7.2.4 Generate From Behavioral Models

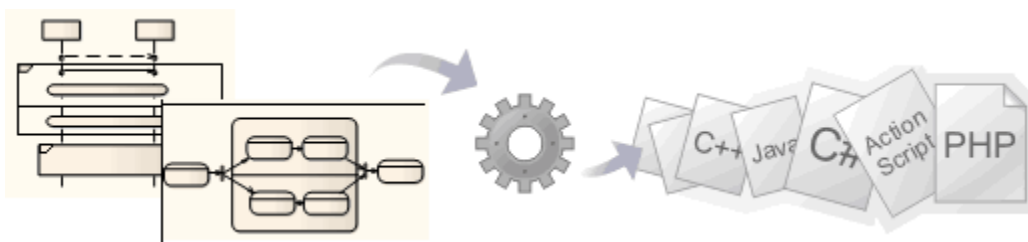

**Notes:**

- Software code generation from behavioral models is available in the Business and Software Engineering, Systems Engineering and Ultimate editions of Enterprise Architect.
- Hardware code generation from State Machine models is available in the Systems Engineering and Ultimate editions of Enterprise Architect.
- For C(OO), please ensure that, on the **C Specifications** page of the **Options** dialog, you have set the **Object Oriented Support** option to **True**.
- To be able to generate code from behavioral models, all behavioral constructs should be contained within a Class.

Enterprise Architect's system engineering capability facilitates code generation from each of the following UML behavioral diagrams:

- [State Machine diagrams](#)<sup>[1316]</sup> (SW & HW)
- [Interaction \(Sequence\) diagrams](#)<sup>[1322]</sup> (SW)
- [Activity diagrams](#)<sup>[1323]</sup> (SW).

You can generate code in various software and [hardware](#)<sup>[1319]</sup> languages, including C(OO), C++, C#, Java, VB.Net, VHDL, Verilog and SystemC.

To experiment with code generation from these diagrams, use the *EAExample* project provided with your Enterprise Architect installer, as follows:

1. Open the *EAExample.eap* file by selecting the **Help | Open Example Model** menu option.
2. From the **Project Browser**, select any of the following packages:

**Software Language Examples:**

- Project Models > System Model > Implementation Model (PSM) > Java Model With Behaviors. Generate the Account and Order classes.
- Project Models > Systems Engineering Model > Implementation Model > Software > C#. Generate the DataProcessor Class.
- Project Models > Systems Engineering Model > Implementation Model > Software > C++. Generate the IO Class.
- Project Models > Systems Engineering Model > Implementation Model > Software > Java. Generate the IO Class.
- Project Models > Systems Engineering Model > Implementation Model > Software > VBNet. Generate the IO Class.

**Hardware Language Examples:**

- Project Models > Systems Engineering Model > Implementation Model > Hardware > SystemC. Generate the Playback Class.
- Project Models > Systems Engineering Model > Implementation Model > Hardware > VHDL. Generate the Playback Class.
- Project Models > Systems Engineering Model > Implementation Model > Hardware > Verilog. Generate the Playback Class.

3. When completed, press **[Ctrl]+[E]** to open the generated source code. You should see methods generated in the code.

### 7.2.4.1 SW Code Generation - State Machine Diagrams

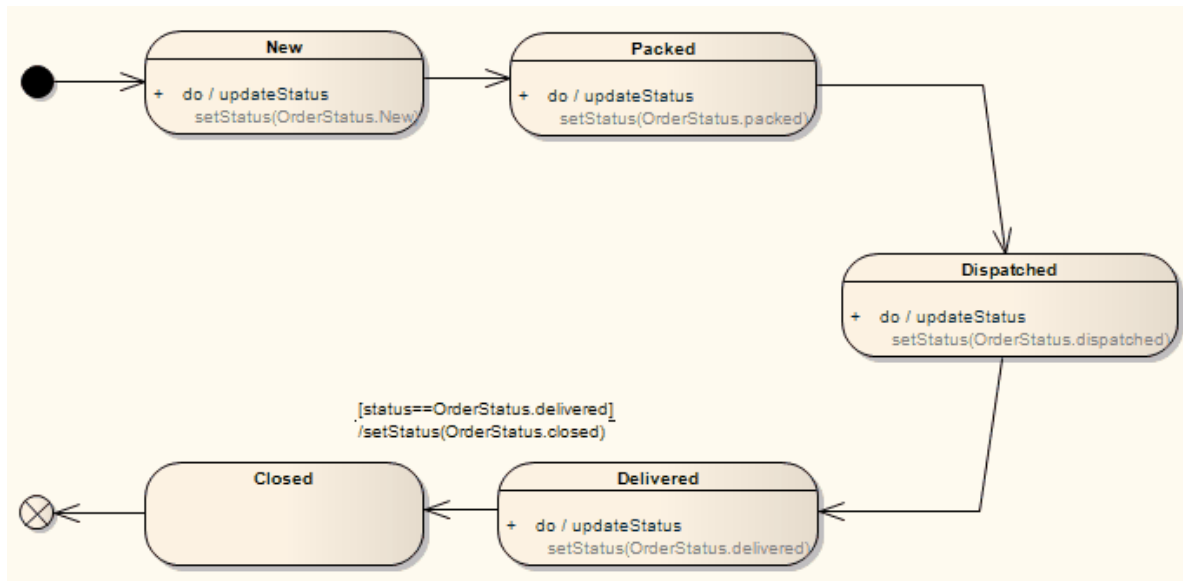

#### Note:

To be able to generate code from behavioral models, all behavioral constructs should be contained within a Class.

A [State Machine](#)<sup>[678]</sup> in a *Class* internally generates the following constructs in software languages to enable effective execution of the States' behaviors (**do**, **entry** and **exit**) and also to code the appropriate transition's effect when necessary.

#### Enumerations

- StateType - comprises an enumeration for each of the States contained within the State Machine
- TransitionType – comprises an enumeration for each transition that has a valid effect associated with it; for example *ProcessOrder\_Delivered\_to\_ProcessOrder\_Closed*
- CommandType – comprises an enumeration for each of the behavior types that a State can contain (**Do**, **Entry**, **Exit**).

#### Attributes

- currState:StateType - a variable to hold the current State's information
- nextState:StateType – a variable to hold the next State's information, set by each State's transitions accordingly
- currTransition:TransitionType – a variable to hold the current transition information; this is set if the transition has a valid effect associated with it
- transcend:Boolean - a flag used to advise if a transition is involved in transcending between different State Machines (or Submachine states)
- xx\_history:StateType – a history variable for each State Machine/Submachine State, to hold information about the last State from which the transition took place.

#### Operations

- StatesProc - a States procedure, containing a map between a State's enumeration and its operation; it de-references the current State's information to invoke the respective State's function
- TransitionsProc - a Transitions procedure, containing a map between the Transition's enumeration and its effect; it invokes the respective effect
- <<State>> - an operation for each of the States contained within the State Machine; this renders a State's behaviors based on the input *CommandType*, and also executes its transitions
- initializeStateMachine – a function that initializes all the framework-related attributes
- runStateMachine - a function that iterates through each State, and executes their behaviors and transitions



accordingly.

Click [here](#) to display an example of Java code generated from the State Machine diagram above.

#### 7.2.4.1.1 Java Code Generated From State Machine Diagram

```
private enum StateType : int
{
    ProcessOrder_Delivered,
    ProcessOrder_Packed,
    ProcessOrder_Closed,
    ProcessOrder_Dispatched,
    ProcessOrder_New,
    ST_NOSTATE
}
private enum TransitionType : int
{
    ProcessOrder_Delivered_to_ProcessOrder_Closed,
    TT_NOTRANSITION
}
private enum CommandType
{
    Do,
    Entry,
    Exit
}
private StateType currState;
private StateType nextState;
private TransitionType currTransition;
private boolean transcend;
private StateType ProcessOrder_history;
private void processOrder_Delivered(CommandType command)
{
    switch(command)
    {
        case Do:
        {
            // Do Behaviors..
            setStatus(Delivered);
            // State's Transitions
            if((status==Delivered))
            {
                nextState = StateType.ProcessOrder_Closed;
                currTransition =
TransitionType.ProcessOrder_Delivered_to_ProcessOrder_Closed;
            }
            break;
        }
        default:
        {
            break;
        }
    }
}
private void processOrder_Packed(CommandType command)
{
    switch(command)
    {
        case Do:
        {
            // Do Behaviors..
            setStatus(Packed);
            // State's Transitions
            nextState = StateType.ProcessOrder_Dispatched;
            break;
        }
        default:
        {
            break;
        }
    }
}
private void processOrder_Closed(CommandType command)
{
```

```
        switch(command)
        {
            case Do:
            {
                // Do Behaviors..
                // State's Transitions
                break;
            }
            default:
            {
                break;
            }
        }
    }

private void processOrder_Dispatched(CommandType command)
{
    switch(command)
    {
        case Do:
        {
            // Do Behaviors..
            setStatus(Dispatched);
            // State's Transitions
            nextState = StateType.ProcessOrder_Delivered;
            break;
        }
        default:
        {
            break;
        }
    }
}

private void processOrder_New(CommandType command)
{
    switch(command)
    {
        case Do:
        {
            // Do Behaviors..
            setStatus(new);
            // State's Transitions
            nextState = StateType.ProcessOrder_Packed;
            break;
        }
        default:
        {
            break;
        }
    }
}

private void StatesProc(StateType currState, CommandType command)
{
    switch(currState)
    {
        case ProcessOrder_Delivered:
        {
            processOrder_Delivered(command);
            break;
        }

        case ProcessOrder_Packed:
        {
            processOrder_Packed(command);
            break;
        }

        case ProcessOrder_Closed:
        {
            processOrder_Closed(command);
            break;
        }

        case ProcessOrder_Dispatched:
        {
            processOrder_Dispatched(command);
        }
    }
}
```

```

        break;
    }
    case ProcessOrder_New:
    {
        processOrder_New(command);
        break;
    }
    default:
        break;
}
private void TransitionsProc(TransitionType transition)
{
    switch(transition)
    {
        case ProcessOrder_Delivered_to_ProcessOrder_Closed:
        {
            setStatus(closed);
            break;
        }
        default:
            break;
    }
}
private void initializeStateMachine()
{
    currState = StateType.ProcessOrder_New;
    nextState = StateType.ST_NOSTATE;
    currTransition = TransitionType.TT_NOTTRANSITION;
}

private void runStateMachine()
{
    while(true)
    {
        if ( currState == StateType.ST_NOSTATE )
        {
            break ;
        }

        currTransition = TransitionType.TT_NOTTRANSITION;
        StatesProc(currState, CommandType.Do);
        // then check if there is any valid transition assigned after the do behavior
        if ( nextState == StateType.ST_NOSTATE)
        {
            break;
        }

        if ( currTransition != TransitionType.TT_NOTTRANSITION )
        {
            TransitionsProc( currTransition );
        }
        if ( currState != nextState)
        {
            StatesProc(currState, CommandType.Exit);
            StatesProc(nextState, CommandType.Entry);
            currState = nextState ;
        }
    }
}
}

```

### 7.2.4.2 State Machine Modeling For HDLs

#### Note:

To be able to generate code from behavioral models, all behavioral constructs should be contained within a Class.

For efficient code generation from State Machine models into Hardware Description Languages (HDL) such as VHDL, Verilog and Systems C, apply the design practices outlined in this topic.

In an HDL State Machine model, the following are expected:

- Designate Driving Triggers

- Establish Port–Trigger Mapping
- Active State Logic

**Designate Driving Triggers**

The top level State Machine diagram should be used to model the different modes of a hardware component, and the associated triggers that drive them, as shown in the following diagram.

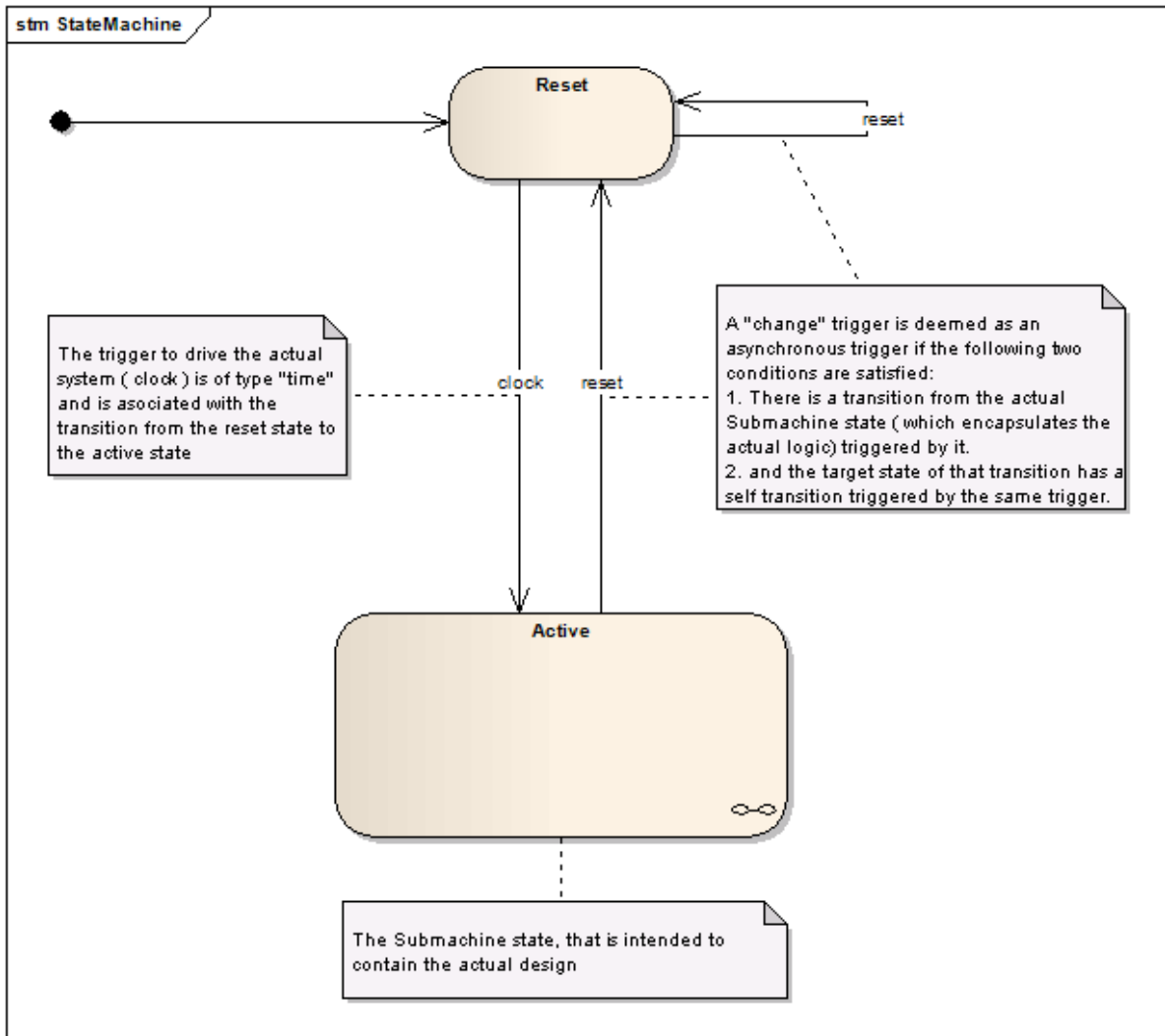

**Asynchronous Triggers**

Asynchronous triggers should be modeled according to the following pattern:

1. The trigger should be of type *Change* (specification: **true / false**)
2. The active state (Submachine State) should have a transition triggered by it.
3. The target state of the triggered transition should have a self transition with the same trigger

**Clock**

A trigger of type *time*, which triggers the transitions to the active state (Submachine State) is deemed as the *Clock*. The specification of this trigger should be specific to the target language.

**Clock Trigger Specifications**

Trigger Type	Language	Specification	
		Positive Edge Triggered	Negative Edge Triggered

Time	VHDL	rising_edge	falling_edge
	Verilog	posedge	negedge
	SystemC	positive	negative

### Establish Port – Trigger Mapping

After successfully modeling the different operating modes of the component, and the triggers associated with them, you must associate the triggers with the component's ports as shown in the following diagram.

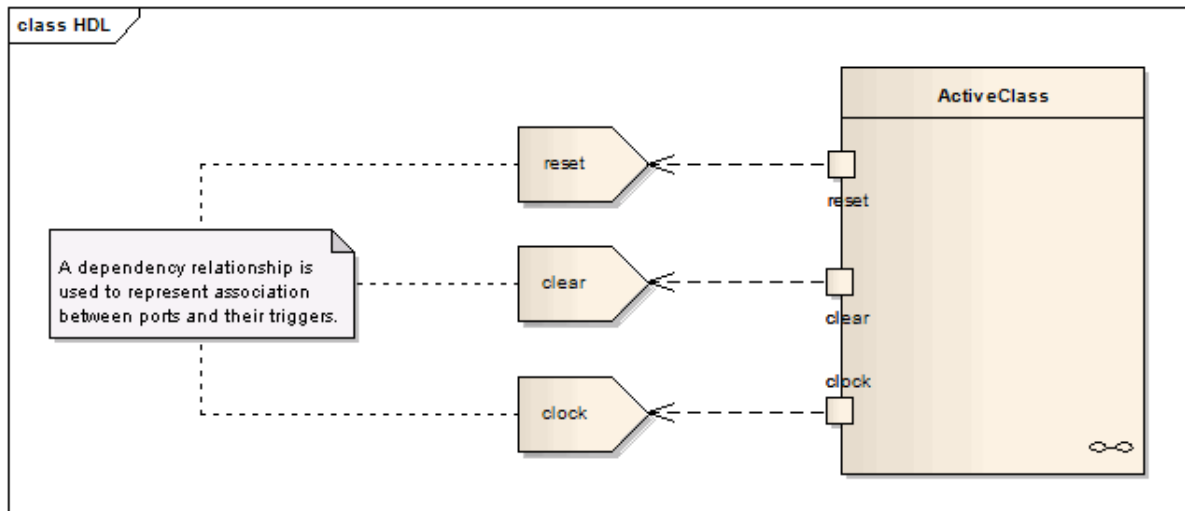

A Dependency relationship from the Port to the associated trigger should be used to signify their association.

#### See Also:

- [State Machine Diagram](#) <sup>[678]</sup>
- [Transition](#) <sup>[892]</sup>
- [SW Code Generation - State Machine Diagrams](#) <sup>[1316]</sup>

### Active State Logic

The first two aspects, above, put in place the preliminaries required for efficient interpretation of the hardware components. The actual State Machine logic is now modeled within the *Active* (Submachine) state.

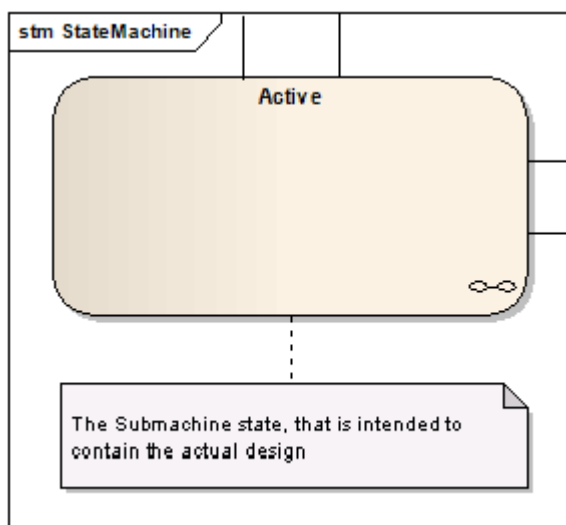

**Note:**

The current code generation engine supports only one *clock trigger* for a component.

**7.2.4.3 Code Generation - Interaction Diagrams****Note:**

To be able to generate code from behavioral models, all behavioral constructs should be contained within a Class.

For an Interaction (Sequence) diagram, the behavioral code generation engine expects the Sequence diagram and all its associated messages and interaction fragments to be encapsulated within an [Interaction](#) [779] element.

During code generation from [Interaction \(Sequence\) diagrams](#) [706] in a Class, Enterprise Architect applies its system engineering graph optimizer to transform the Class constructs into programmatic paradigms. Messages and Fragments are identified as one of the several action types based on their functionality, and Enterprise Architect uses the *EASL code generation templates* to render their behavior accordingly. For example:

- A Message that invokes an operation is identified as an *Action Call* and is rendered accordingly
- Combined Fragments are identified by their types and conditions; for instance, an *Alt* fragment is identified as an *Action If*, and a *loop* fragment is identified as an *Action Loop*.

For more information on the EASL code generation macros and templates Enterprise Architect uses to generate code from behavioral models see the [EASL Code Generation Macros](#) [1193] topic.

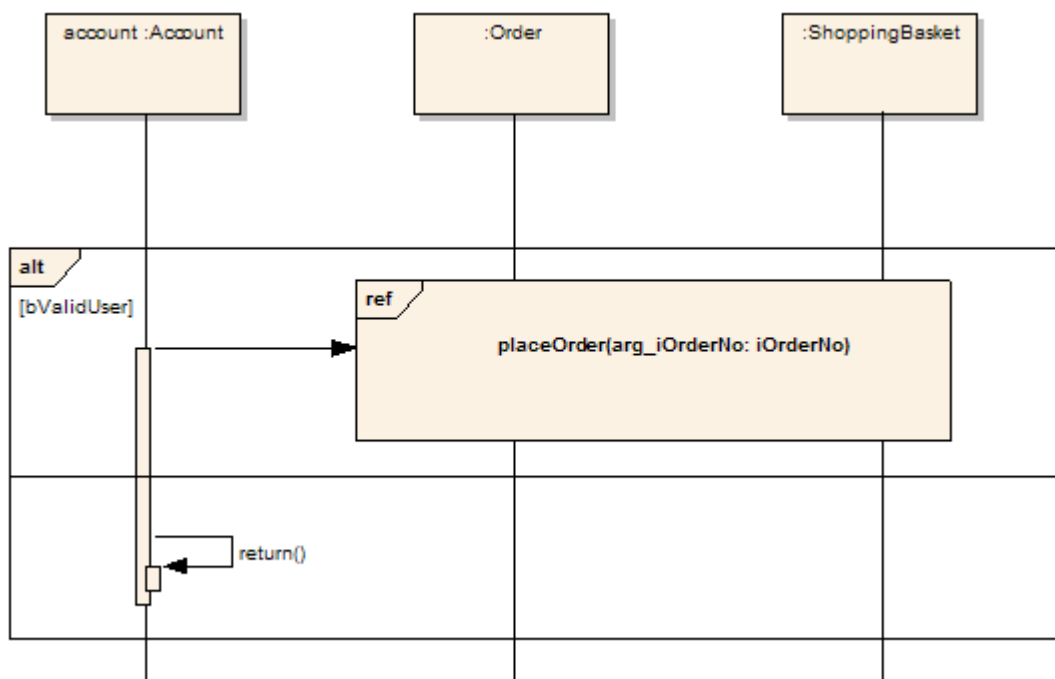

The above diagram contains:

- A [Combined Fragment](#) [759] (*alt*), which is identified as an *Action If*
- An [Interaction Occurrence](#) [780], which is identified as an *Action Call* with all argument information associated with it, and
- A message (*Action Opaque*).

The Java code generated from this diagram resembles the following:

```
public void newTransaction()
{
    // behavior is an Interaction
    if (bValidUser) // Alt combined fragment
```

```
        {
            placeOrder(101); //Interaction Occurrence
        }
        else
        {
            return;
        }
    }
```

#### 7.2.4.4 Code Generation - Activity Diagrams

**Note:**

To be able to generate code from behavioral models, all behavioral constructs should be contained within a Class.

Code generation from an [Activity diagram](#)<sup>[674]</sup> in a Class requires a validation phase, during which Enterprise Architect uses the system engineering graph optimizer to analyze the diagram and render it into various code-generatable constructs. Enterprise Architect also transforms the constructs into one of the various action types (if appropriate), similar to the Interaction diagram constructs. Enterprise Architect then uses the EASL code generation macros to generate code from these constructs.

For more information on the EASL code generation macros and templates Enterprise Architect uses to generate code from behavioral models see the [EASL Code Generation Macros](#)<sup>[1195]</sup> topic.

To provide a comprehensive analysis of these features several diagrams from the *EAExample* project are shown as examples.

#### Conditional Statements

To model a conditional statement, you use Decision/Merge nodes. Alternatively, you can imply Decisions/Merges internally. The graph optimizer expects an associated Merge node for each Decision node, to facilitate efficient tracking of various branches and analysis of the code constructs within them.

The following diagram is interpreted as a nested IF statement.

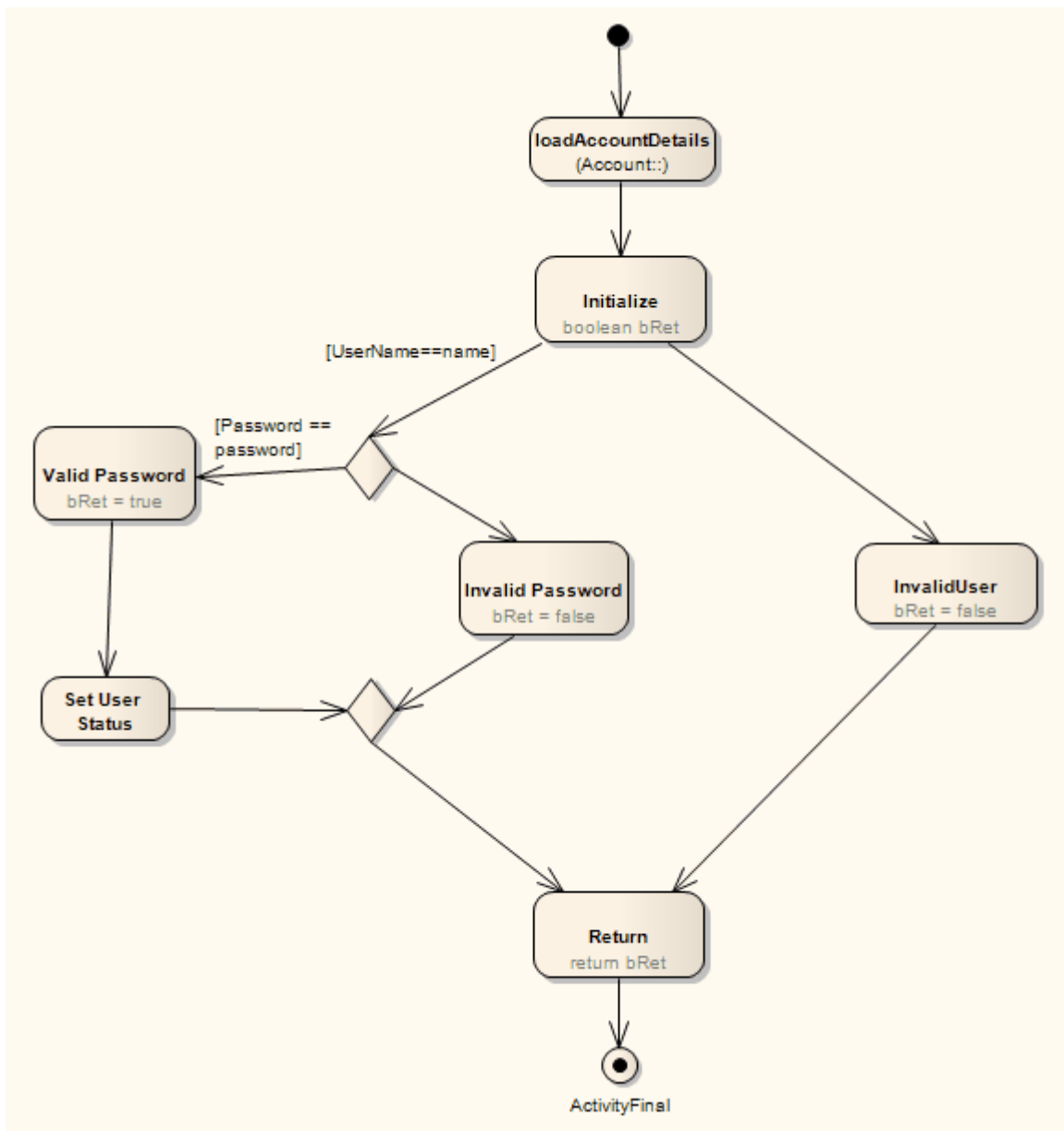

The Java code that might be generated from this diagram is as follows:

```

public boolean doValidateUser(String Password,String UserName)
{
    loadAccountDetails();
    boolean bRet;
    if (Username==name)
    {
        if (Password == password)
        {
            bRet = true;
            bValidUser = true;
        }
        else
        {
            bRet = false;
        }
    }
    else
    {

```



```

        bRet = false;
    }
    return bRet;
}

```

### Invocation Actions (Call Operation Action, Call Behavior Action)

*Call Actions* are handled more efficiently. Each action has arguments relating to the parameters of the associated behavior (use the **Synchronize** button of the **Arguments** dialog to synchronize arguments and parameters).

The following diagram demonstrates the use of a *Call Behavior Action* and a *Call Operation Action* interspersed with a conditional statement.

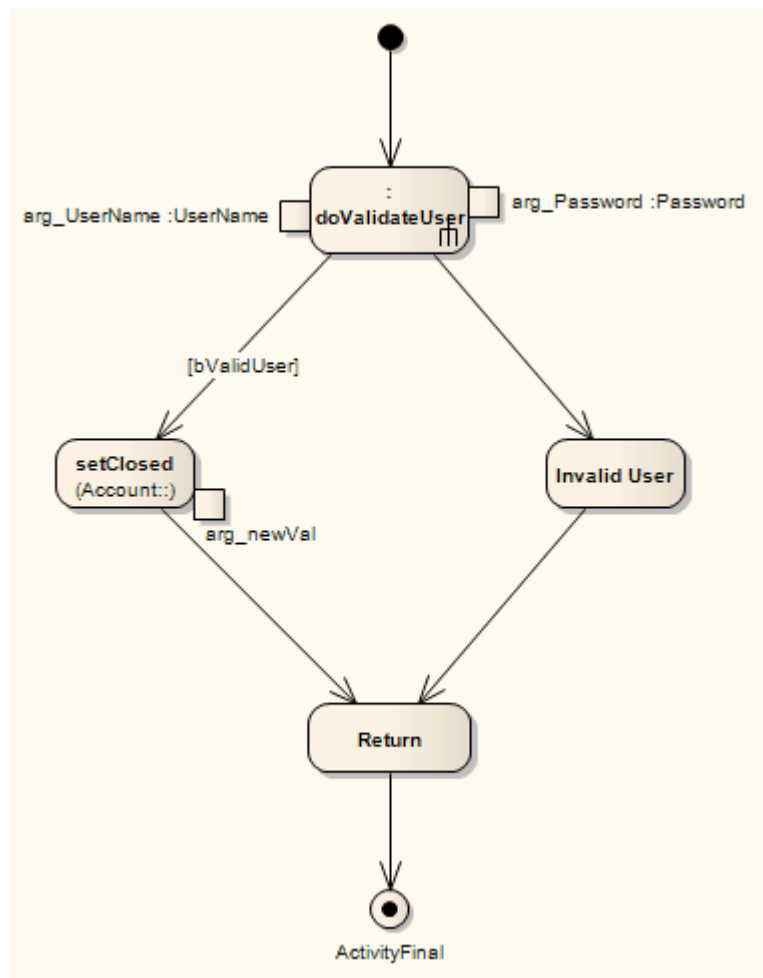

The generated Java code might appear as follows:

```

public void doMarkAccountClosed()
{
    doValidateUser(password,name);
    if (bValiduser)
    {
        setClosed(true);
    }
    else
    {
        System.out.println("Invalid user");
    }
    return;
}

```

## Loops

Enterprise Architect's system engineering graph optimizer is also capable of analyzing and identifying loops. An identified loop is internally rendered as an *Action Loop*, which is translated by the EASL code generation macros to generate the required code.

The following diagram demonstrates how a loop can be modeled.

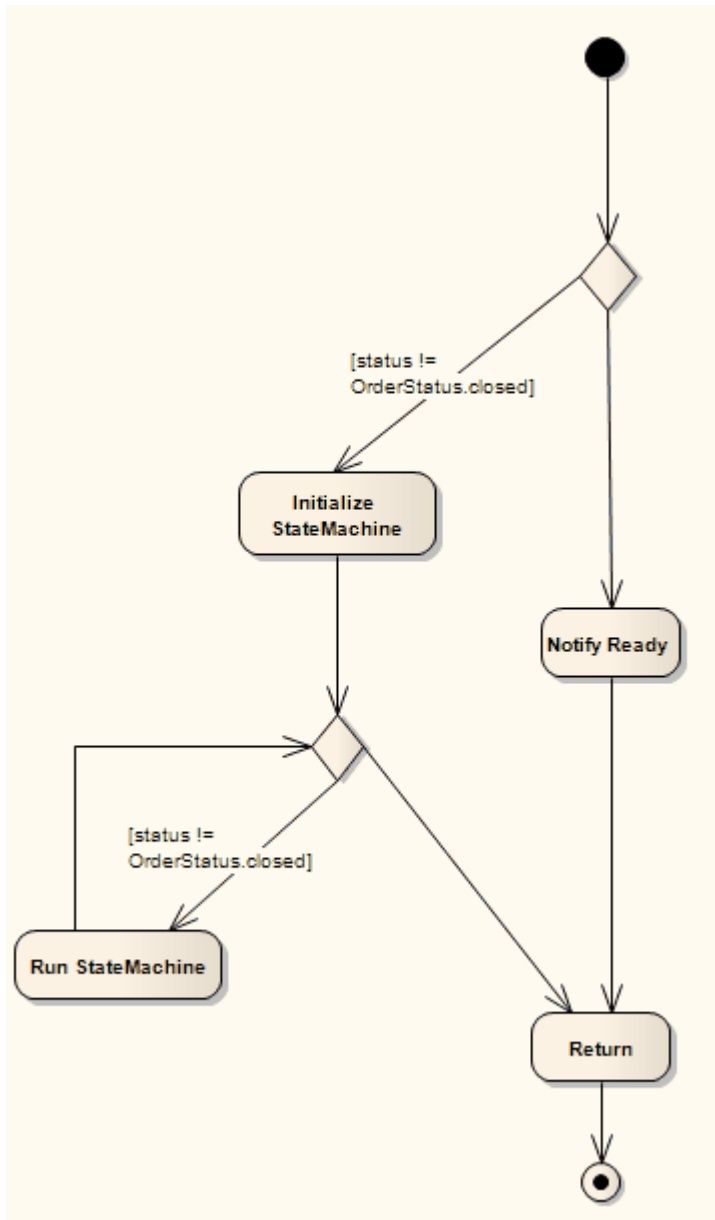

The generated Java code might appear as follows:

```
public void doCheckForOutstandingOrders()
{
    if (status != closed)
    {
        initializeStateMachine();
        while (status != closed)
        {
            runStateMachine();
        }
    }
    else

```

```
{  
    //No Outstanding orders;  
}  
return;  
}
```

## 7.2.5 Synchronize Model and Code

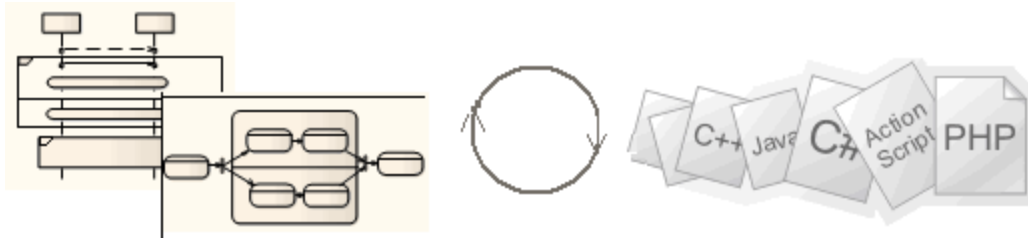

In addition to generating and importing code, Enterprise Architect provides the option to synchronize the model and source code, creating a model that represents the latest changes in the source code and vice versa. You can use either the model as the source, or the code as the source.

For example: you generated some source code, but made subsequent changes to the model. When you generate code again, Enterprise Architect *adds* any new attributes or methods to the existing source code, leaving intact what already exists. This means developers can work on the source code and then generate *additional* methods as required from the model, without having their code overwritten or destroyed.

### Note:

Code synchronization does not *change* method bodies. [Behavioral code generation](#)<sup>[1314]</sup> only works when generating the entire file.

Similarly, you might have made changes to a source code file, but the model has detailed notes and characteristics you do not want to lose. By synchronizing from the source code into the model, you import additional attributes and methods but do not change other model elements.

Using the two synchronization methods above, it is simple to keep source code and model elements up to date and synchronized.

### Note:

In the Corporate, Business and Software Engineering, System Engineering and Ultimate editions of Enterprise Architect, if security is enabled you must have [Generate Source Code and DDL](#)<sup>[198]</sup> permission to synchronize source code with model elements.

## Synchronize Classes on Forward Generation

When there are features present in the code but not in the model you can use the following buttons during forward synchronization:

### Note:

These buttons are only available when the **On forward synch, prompt to delete code features not in model** checkbox is selected in the [Options - Attributes and Operations](#)<sup>[1341]</sup> dialog.

- **Delete:** when you click on this button the selected code features are removed from the code.
- **Reassign:** when you click on this button the code elements are reassigned to elements in the model (this is only possible when an appropriate model element is present that is not already defined in the code).
- **Ignore:** when you click on this button the code elements not present in the model are ignored completely.
- **Reset to Default:** when you click on this button the settings for synchronizing during forward generation are set to Ignore, meaning that the elements present in the code but not in the model are ignored completely.

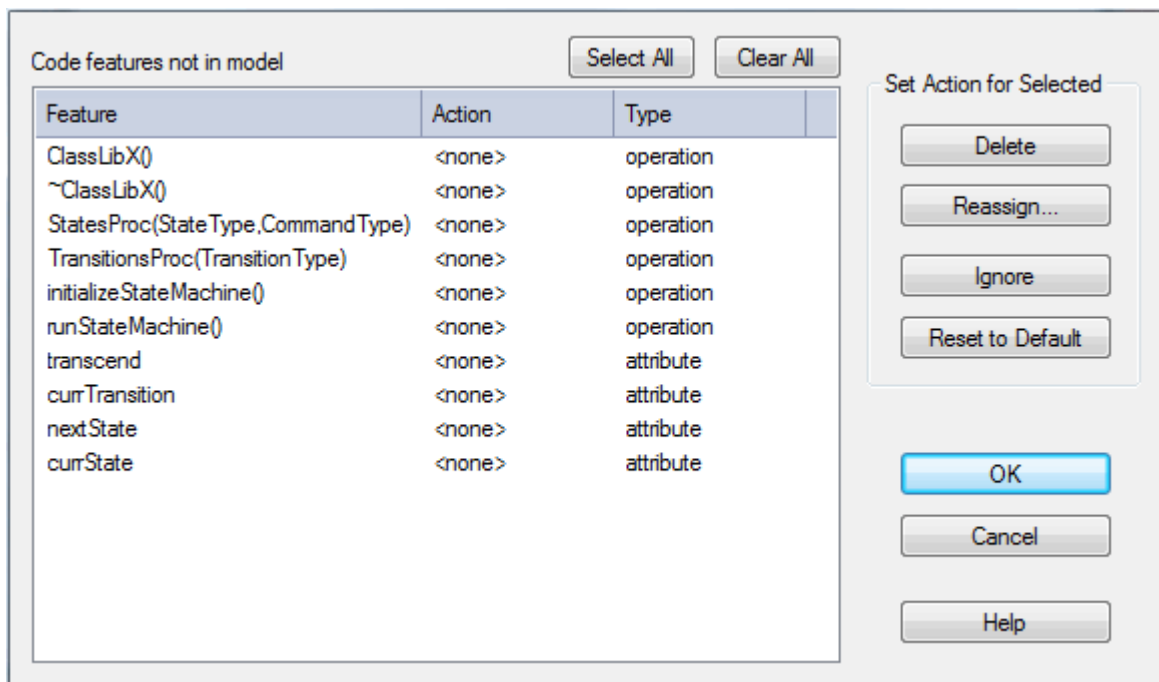

## 7.2.6 Import Source Code



Reverse Engineering in Enterprise Architect enables you to import existing source code from a variety of code languages into a UML model. Existing source code structures are mapped into their UML representations, for example a Java Class is mapped into a UML Class element with the variables being defined as attributes, methods are modeled as operations and the interactions between the Java Classes being displayed in the UML model Class diagram with the appropriate connectors.

### Note:

In the Corporate, Business and Software Engineering, System Engineering and Ultimate editions of Enterprise Architect, if security is enabled you must have [Reverse Engineer From DDL And Source Code](#) <sup>[198]</sup> permission to reverse engineer source code and synchronize model elements against code.

Reverse Engineering enables users to examine legacy code and examine the functionality of code libraries for reuse or to bring the UML model up to date with the code that has been developed as part of a process called *synchronization*. Examining the code in a UML model enables user to identify the critical modules contained the code, enabling a starting point for understanding of the business and system requirements of the pre-existing system and to enable the developers to gain a better overall understanding of the source code.

To begin the process of importing existing code into Enterprise Architect, an existing source of code must be [imported into Enterprise Architect](#) <sup>[1329]</sup>, which can be a single directory or a [directory structure](#) <sup>[1332]</sup>. Several options are available when performing the reverse engineering process. The [Source Code Engineering Options](#) <sup>[1336]</sup> topic contains several options that affect the reverse engineering process. These include:

- If comments are reverse engineered into notes fields, and how they are formatted if they are
- How property methods are recognized
- If dependencies should be created for operation return and parameter types.

It is important to note that when a legacy system is not well designed, simply importing the source into Enterprise Architect does not create an easily understandable UML model. When working with a legacy

system that is poorly designed it is useful to break down the code into manageable components by examining the code elements individually. This can be achieved by importing a specific Class of interest into a diagram and then [inserting the related elements](#) <sup>[55]</sup> at one level to determine immediate relationship to other Classes. From this point it is possible to create Use Cases that identify the interaction between the legacy Classes, enabling an overview of the legacy system's operation.

Copyright ownership is an important issue to take into account when undertaking the process of reverse engineering. In some cases, software might have specific limitations that prohibit the process of reverse engineering. It is important that a user address the issue of copyright before beginning the process of reverse engineering code. Situations that typically lend themselves to reverse engineering source code include source code that:

- You have already developed
- Is part of a third-party library that you have obtained permission to use
- Is part of a framework that your organization uses
- Is being developed on a daily basis by your developers.

Enterprise Architect currently supports reverse engineering in the following programming languages:

- [ActionScript](#) <sup>[1283]</sup>
- [Ada 2005](#) <sup>[1284]</sup> (Systems Engineering and Ultimate editions)
- [C](#) <sup>[1285]</sup>
- [C#](#) <sup>[1287]</sup>
- [C++](#) <sup>[1289]</sup>
- [Delphi](#) <sup>[1292]</sup>
- [Java](#) <sup>[1293]</sup>
- [PHP](#) <sup>[1294]</sup>
- [Python](#) <sup>[1295]</sup>
- [SystemC](#) <sup>[1295]</sup> (Systems Engineering and Ultimate editions)
- [Verilog](#) <sup>[1295]</sup> (Systems Engineering and Ultimate editions)
- [VHDL](#) <sup>[1295]</sup> (Systems Engineering and Ultimate editions)
- [Visual Basic](#) <sup>[1301]</sup>
- [Visual Basic .NET](#) <sup>[1296]</sup>

Enterprise Architect is also able to reverse engineer certain types of binary files: Java .jar files and .NET PE files. See [Import Binary Module](#) <sup>[1334]</sup> for more information.

#### Note:

Reverse Engineering of other languages is currently available through the use of MDG Technologies from [www.sparxsystems.com/resources/mdg\\_tech/](http://www.sparxsystems.com/resources/mdg_tech/).

### 7.2.6.1 Import Source Code

To import source code (reverse engineer) follow the steps below:

1. In the **Project Browser**, select (or add) a diagram into which to import the Classes.
2. Right-click on the diagram background to open the context menu and either:
  - Select the language to import from the **Import from source file(s)** submenu, or
  - Click on the **Import Language** drop-down arrow in the **Code Generation** toolbar and select the **Import | Import xxx files** menu option, where xxx represents the language to import.
3. From the file browser that appears, select one or more [source code files](#) <sup>[1331]</sup> to import.

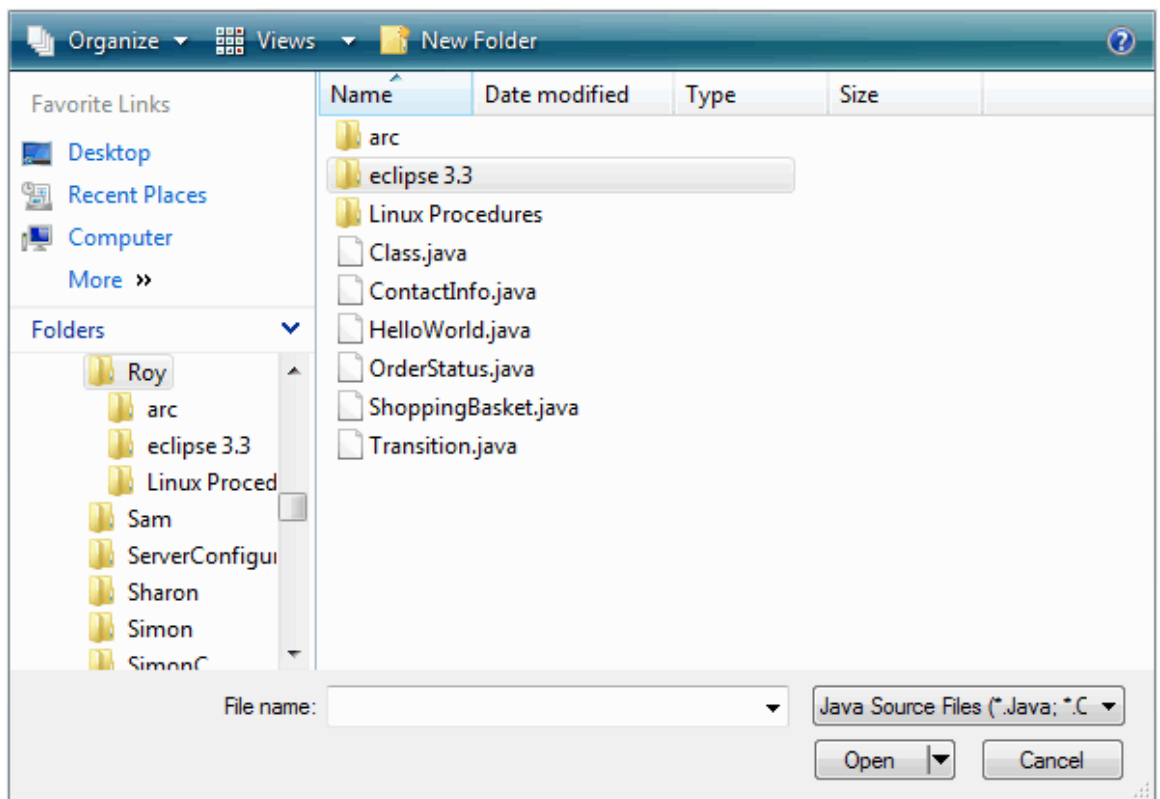

4. Click on the **Open** button to start the import process.

As the import proceeds, Enterprise Architect provides progress information. When all files are imported, Enterprise Architect makes a second pass to resolve associations and inheritance relationships between the imported Classes.

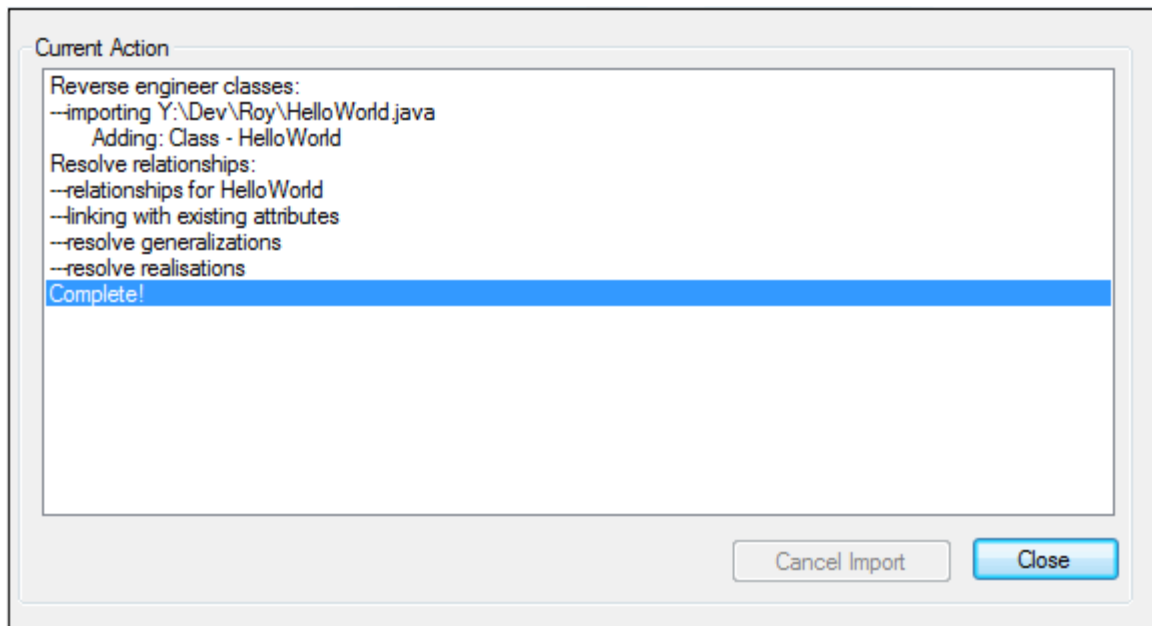

### 7.2.6.2 Notes on Source Code Import

Enterprise Architect enables you to [import code](#) into your project, in the following programming languages:

- [ActionScript](#)
- [C](#)
- [C#](#)
- [C++](#)
- [Delphi](#)
- [Java](#)
- [PHP](#)
- [Python](#)
- [Visual Basic](#)
- [Visual Basic .NET](#)

Enterprise Architect supports most constructs and keywords for each coding language.

If there is a particular feature you require support for that you feel is missing, please contact [Sparx Systems](#).

You must select the appropriate type of source file for the language, as the source code to import.

#### ActionScript

Appropriate type of source file: **.as**.

#### C

Appropriate type of source file: **.h** header files and/or **.c** files.

When you select a header file Enterprise Architect automatically searches for the corresponding **.c** implementation file to import based on the options for extension and search path specified in the [C options](#).

.

Enterprise Architect does not expand macros that have been used, these must be added into the internal list of [Language Macros](#).

#### C++

Appropriate type of source file: **.h** header file.

Enterprise Architect automatically searches for the **.cpp** implementation file based on the extension and search path set in the [C++ options](#). When it finds the implementation file it can use it to resolve parameter names and method notes as necessary.

When importing C++ source code, Enterprise Architect ignores function pointer declarations. To import them into your model you could create a *typedef* to define a function pointer type, then declare function pointers using that type. Function pointers declared in this way are imported as attributes of the function pointer type.

Enterprise Architect does not expand macros that have been used; these must be added into the internal list of [Language Macros](#).

#### C#

Appropriate type of source file: **.cs**.

#### Delphi

Appropriate type of source file: **.pas**.

#### Java

Appropriate type of source file: **.java**.

Enterprise Architect supports the AspectJ language extensions.

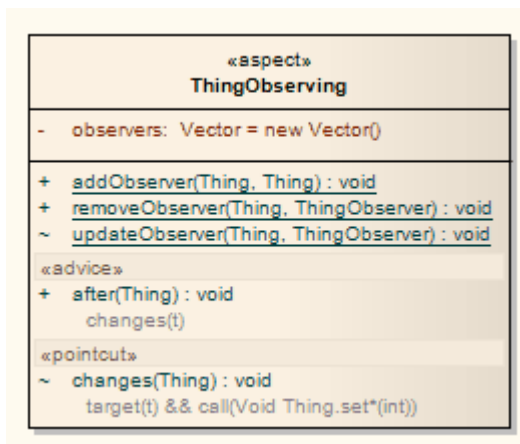

*Aspects* are modeled using Classes with the stereotype *aspect*. These aspects can then contain attributes and methods as for a normal Class. If an *intertype* attribute or operation is required, you can add a tag *className* with the value being the name of the Class it belongs to.

*Pointcuts* are defined as operations with the stereotype of *pointcut*. These can occur in any Java Class, Interface or aspect. The details of the pointcut are included in the **behavior** field of the method.

*Advice* is defined as an operation with the stereotype *advice*. The pointcut this advice operates on is in the **behavior** field and acts as part of the method's unique signature. After advice can also have one of the Tagged Values *returning* or *throwing*.

## PHP

Appropriate type of source file: **.php**, **.php4**, or **.inc**.

## Python

Appropriate type of source file: **.py**.

## Visual Basic

Appropriate type of source file: **.cls** Class file.

## Visual Basic .NET

Appropriate type of source file: **.vb** Class file.

### 7.2.6.3 Import a Directory Structure

You can import from all source files in a complete directory structure. This process enables you to import or synchronize multiple files in a directory tree in one pass. Enterprise Architect creates the necessary packages and diagrams during the import process.

To import a directory structure, follow the steps below:

1. In the **Project Browser**, right-click on the target package for the import.
2. From the context menu, select the **Code Engineering | Import Source Directory** menu option. The **Import Source Directory** dialog displays.



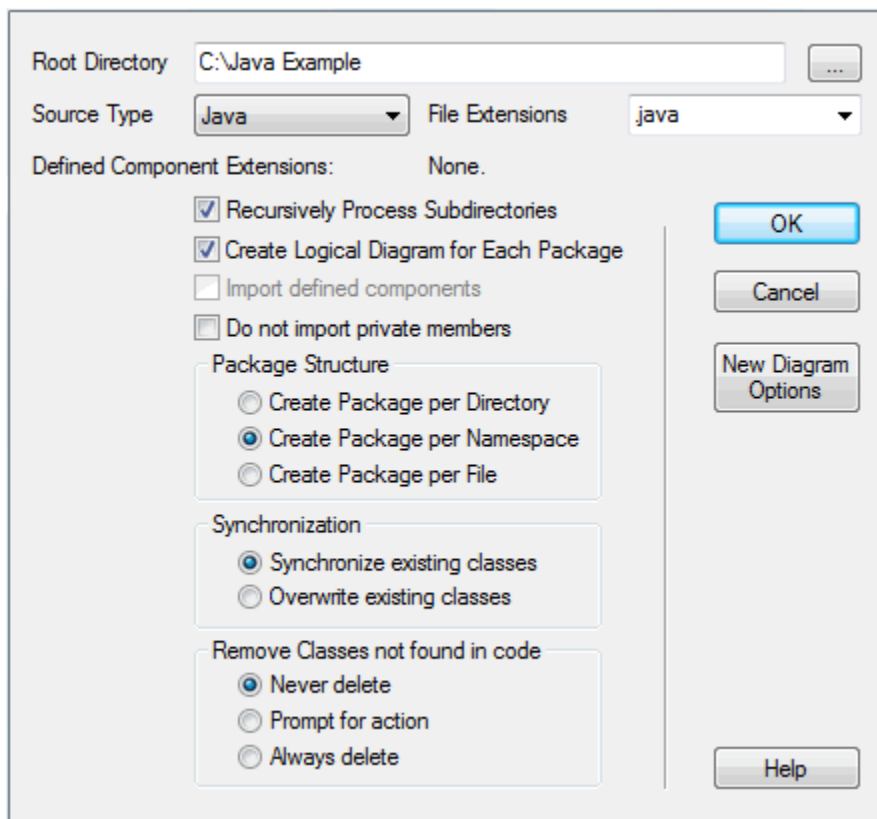

3. Select the options you require. You can configure:
  - The source directory
  - The source type
  - The file extensions to look at
  - Whether to recurse sub directories
  - Whether to create a diagram for each package
  - Whether to import additional files as described in the **Import Component Types** dialog
  - Whether to exclude private members from libraries being imported from the model
  - Whether to create a package for every directory, namespace or file; this might be restricted depending on the source type selected
  - Whether to Synchronize or Overwrite existing Classes when found (if a model Class is found matching the one in code, **Synchronize** *updates* the model Class to include the details from the one in code, which preserves information not represented in code such as the location of Classes in diagrams; **Overwrite** *deletes* the model Class and generates a new one from code, which deletes and does not replace the additional information)
  - How to handle Classes not found during the import (**Prompt for action** enables you to [review Classes individually](#)<sup>(1335)</sup>)
  - What is shown on diagrams created by the import.
4. Click on the **OK** button to start.

### 7.2.6.4 Import Binary Module

Enterprise Architect enables you to reverse-engineer certain types of binary modules. To import a binary module, right-click on the target package in the **Project Browser** and select the **Code Engineering | Import Binary Module** context menu option.

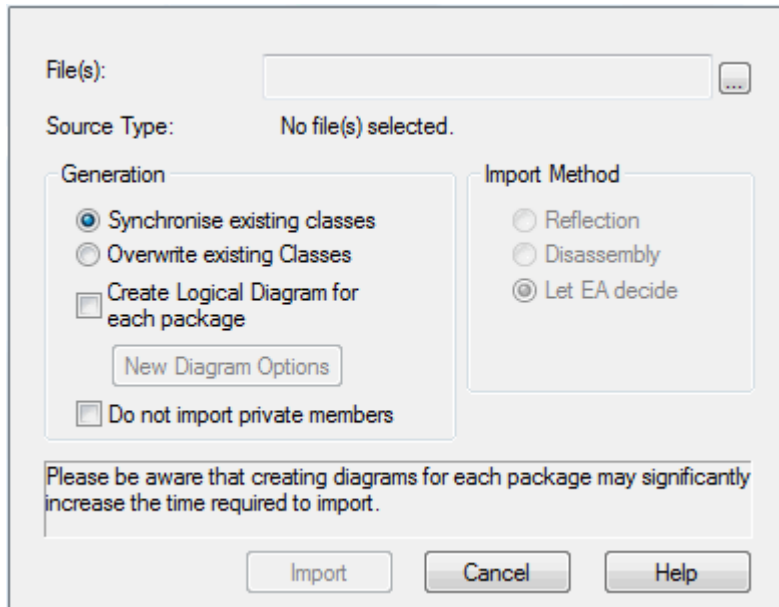

Currently the permitted types are as follows:

- Java Archive (.jar)
- .Net PE file (.exe, .dll); native Windows DLL and EXE files are not supported, only PE files containing .NET assembly data
- Intermediate Language file (.il).

Enterprise Architect creates the necessary packages and diagrams during the import process. Selecting the **Do not import private members** checkbox excludes private members from libraries from being imported into the model.

When importing .Net files, you can import via reflection or via disassembly, or let Enterprise Architect decide the best method - this might result in both types being used. The reflection-based importer relies on a .Net program, and requires the .Net runtime environment to be installed. The disassembler-based importer relies on a native Windows program called *lldasm.exe*, which is a tool provided with the MS .Net SDK. The SDK can be downloaded from the Microsoft website.

A choice of import methods is available because some files are not compatible with reflection (such as *mscorlib.dll*) and can only be opened using the disassembler. However, the reflection-based importer is generally much faster.

You can also configure:

- Whether to **Synchronize** or **Overwrite** existing Classes when found (if a model Class is found matching the one in the file, **Synchronize** updates the model Class to include the details from the one in the file, which preserves information not represented in the file such as the location of Classes in diagrams; **Overwrite** deletes the model Class and generates a new one from the file, which deletes and does not replace the additional information)
- Whether to create a diagram for each package
- What is shown on diagrams created by the import.

### 7.2.6.5 MDG Integration and Code Engineering

MDG Integration for Eclipse and MDG Integration for Visual Studio are standalone products that provide an enhanced code engineering functionality between Enterprise Architect and the development environments.

The MDG Integration programs provide a lightweight bridge between Enterprise Architect and the development environment, offering enhanced code generation, reverse engineering and synchronization

between code and the UML model. Merging changes can be achieved with minimal effort, and navigation between model and source code is significantly enhanced.

A trial version of MDG Integration for Eclipse can be downloaded from [www.sparxsystems.com/products/mdg/int/eclipse/index.html](http://www.sparxsystems.com/products/mdg/int/eclipse/index.html) and MDG Integration for Visual Studio can be downloaded from [www.sparxsystems.com/products/mdg/int/vs/index.html](http://www.sparxsystems.com/products/mdg/int/vs/index.html).

### 7.2.6.6 Classes Not Found During Import

When reverse synchronizing from your code, there are times when some Classes might be deliberately removed from your source code. Enterprise Architect's import source directory functionality keeps track of the Classes it expects to synchronize with and, on the **Import Directory Structure** dialog, provides options for how to handle the Classes that weren't found. You can select the appropriate action so that, at the end of the import, Enterprise Architect either ignores the missing Classes, automatically deletes them or prompts you to handle them.

If you select the **Prompt For Action** <sup>1332</sup> radio button on the **Import Directory Structure** dialog, to manually review missing Classes, the following dialog displays:

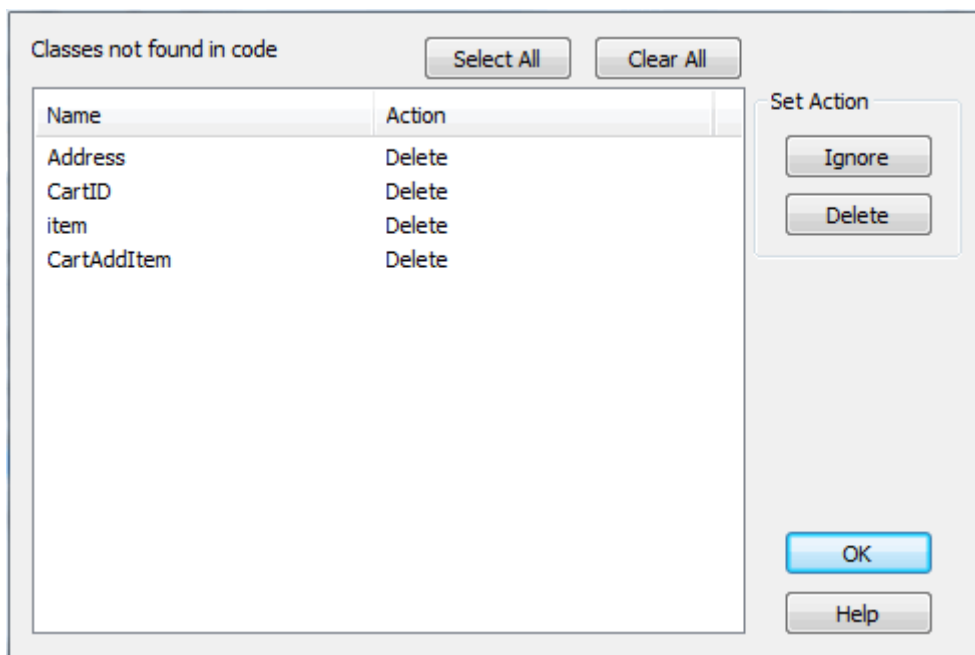

By default, all Classes are marked for deletion. To keep one or more Classes, select them and click on the **Ignore** button.

### 7.2.7 Other Settings



You can set the default code options such as the editors for each of the programming languages available for Enterprise Architect and special options for how source code is generated.

#### See Also

- [General Options](#) <sup>1336</sup>
- [Local Paths](#) <sup>1343</sup>
- [Local Path Dialog](#) <sup>1343</sup>
- [Language Macros](#) <sup>1344</sup>

- [Set Collection Classes](#) <sup>[1345]</sup>

### 7.2.7.1 Source Code Engineering

The following topics describe general options that apply to all languages when generating code from Enterprise Architect. These options are all available under the **Source Code Engineering** section of the **Options** dialog (select the **Tools | Options | Source Code Engineering** menu option).

- [Source Code Options](#) <sup>[1336]</sup>
- [Options - Code Editors](#) <sup>[1337]</sup>
- [Options - Object Lifetimes](#) <sup>[1340]</sup>
- [Options - Attribute/Operations](#) <sup>[1341]</sup>
- [Synchronize Model and Code](#) <sup>[1327]</sup>
- [Code Page for Source Editing](#) <sup>[1342]</sup>

#### 7.2.7.1.1 Source Code Options

When you generate code for a particular language, you can set certain options. These include:

- Create a default constructor
- Create a destructor
- Generate copy constructor
- Select default language
- Generate methods for implemented interfaces
- Set the unicode options for code generation.

These options are accessed the **Source Code Engineering** page of the **Options** dialog (select the **Tools | Options | Source Code Engineering** menu option).

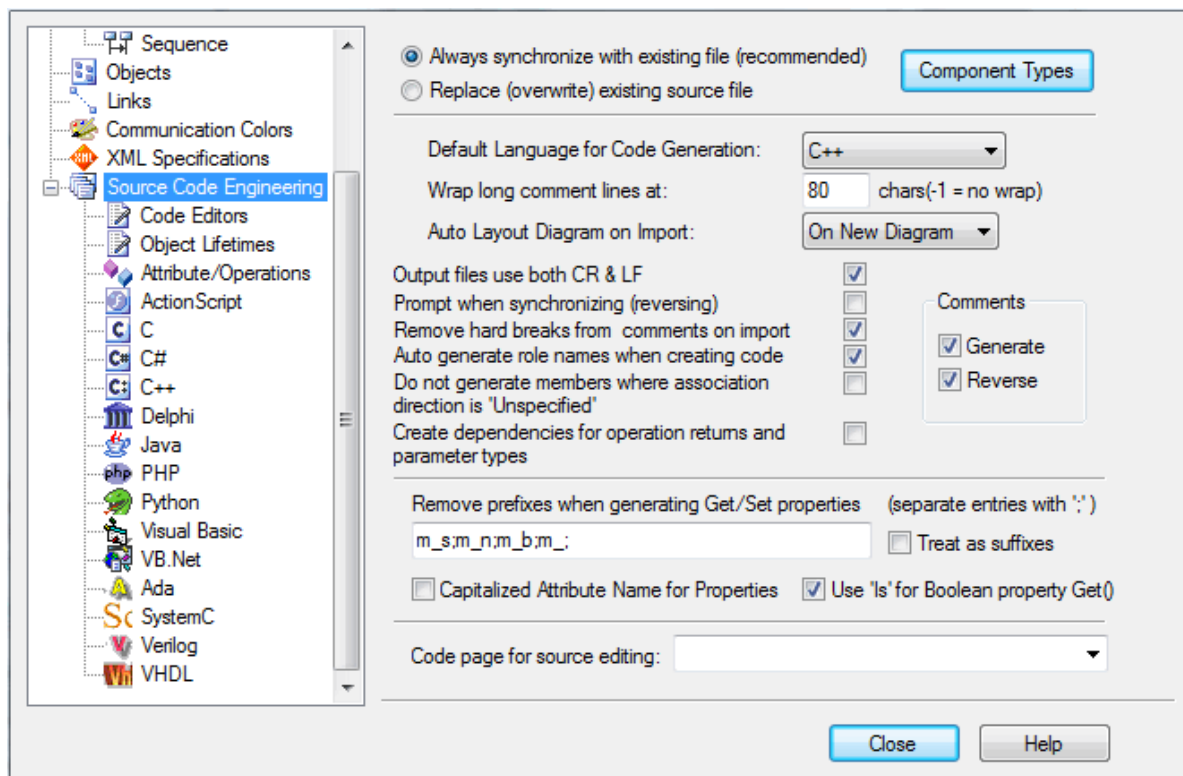

Most of the settings are self-explanatory. The **Remove prefixes when generating Get/Set properties** field enables you to specify prefixes used in your variable naming conventions, if those prefixes should be removed in the variables' corresponding get/set functions.

Click on the **Component Types** button to [configure what elements](#) <sup>[1337]</sup> should be created for files of any extension found while importing a source code directory.

**Note:**

It is worthwhile to configure these settings, as they serve as the defaults for all Classes in the model. You can override these on a per-Class basis using the custom settings (from the [Code Generation](#) dialog).

### 7.2.7.1.1.1 Import Component Types

The [Import Component Types](#) dialog enables you to configure what elements you would like to be created for files of any extension found while importing a source code directory.

To access the [Import Component Types](#) dialog select the **Tools | Options | Source Code Engineering** menu option to display the [Source Code Engineering](#) page of the [Options](#) dialog, and click on the **Component Types** button.

Specify for this model, the files by extension type, their UML equivalent and an optional stereotype for importing additional items when reverse engineering directories.

Extension	Type	Stereotype
sln	Artifact	solution
Extension	Type	Stereotype
rc	Artifact	resource
bmp	Component	bitmap
sln	Artifact	solution

Save New Delete Close

For each extension you can specify:

- The element type to be created
- The stereotype to apply to these objects.

**Note:**

You can transport these import component types between models, using the [Export Reference Data](#) <sup>[223]</sup> and [Import Reference Data](#) <sup>[223]</sup> options on the **Tools** menu.

### 7.2.7.1.2 Options - Code Editors

You access the source code editor options via the [Code Editors](#) page of the [Options](#) dialog (select the **Tools | Options | Source Code Engineering | Code Editors** menu option). They enable you to configure options for Enterprise Architect's internal editor, as well as the default editor for DDL scripts. You can configure external editors for code languages on each language options page.

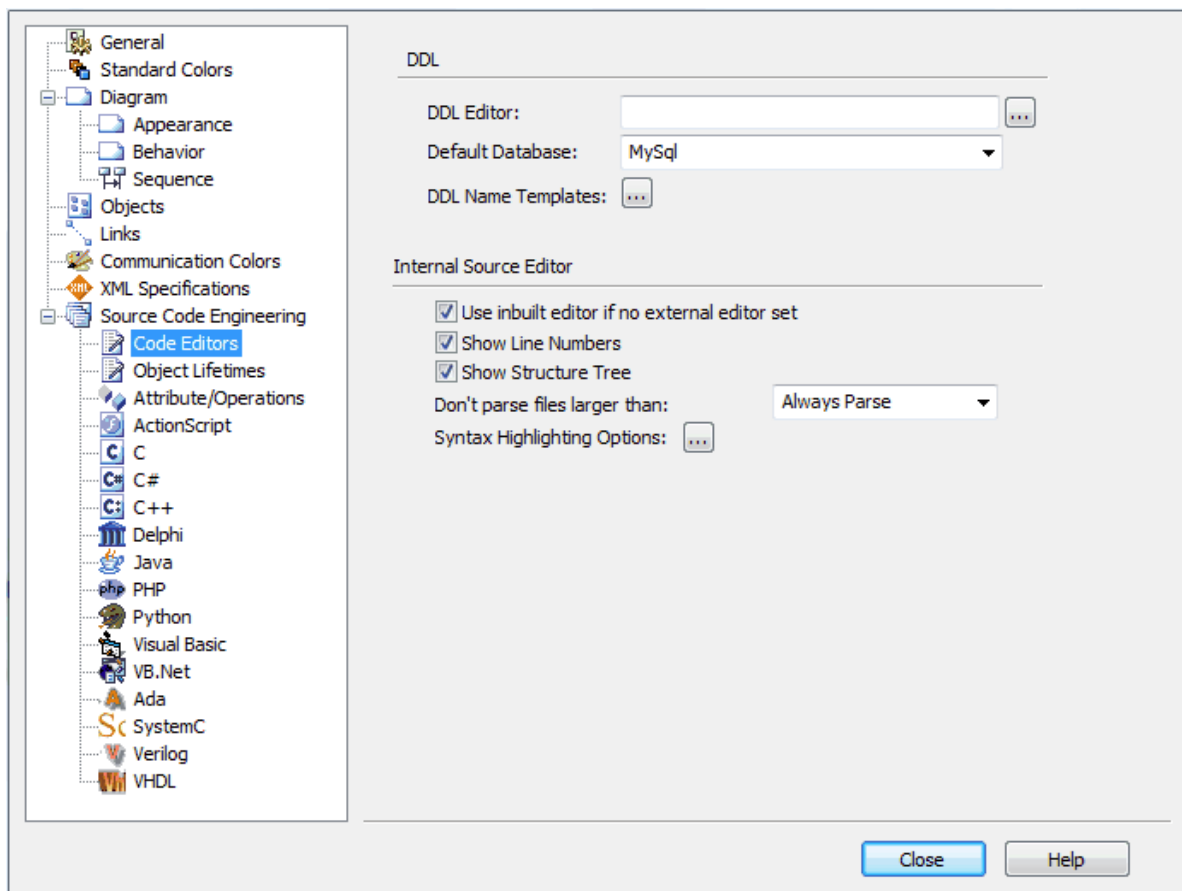

The options for the inbuilt editor are:

Option	Use to
<b>Use inbuilt editor if no external editor set</b>	Specify the editor for code in a language if no external editor is defined for that language.
<b>Show Line Numbers</b>	Show line numbers in the editor.
<b>Show Structure Tree</b>	Show a tree with the results of parsing the open file (requires that the file is parsed successfully).
<b>Don't parse files larger than</b>	Specify an upper limit on file size for parsing. Used to prevent performance decrease due to parsing very large files.
<b>Syntax Highlighting Options</b>	Specify both global and language-specific <a href="#">editor language properties</a> <sup>1338</sup> .

#### 7.2.7.1.2.1 Editor Language Properties

Enterprise Architect enables you to specify [syntax highlighting](#) <sup>1428</sup> properties for all the programming languages that Enterprise Architect supports at installation. (You cannot currently set properties for any additional languages you include through an [MDG Technology](#) <sup>1128</sup>).

On the [Code Editors](#) <sup>1337</sup> page of the **Options** dialog, click on the [ ... ] (Browse) button next to the **Syntax Highlighting Options** field. The **Editor Language Properties** dialog displays. You can resize this dialog, if required.

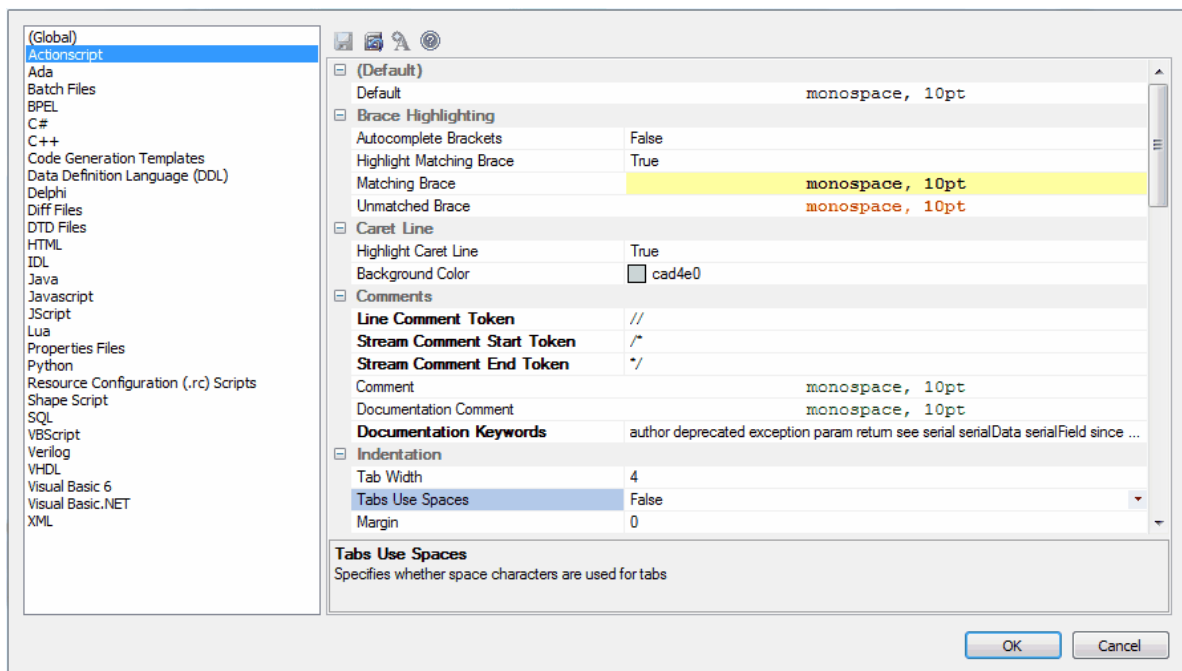

## General Features

The panel on the left of the dialog lists the languages for which you can set properties. The **(Global)** item at the top of the list enables you to set properties that apply to all programming languages; however, you can reset a global property to a different value for a specific language, on the page for that language. Resetting a global property for one language does not affect that property's value for the other languages.

Click on the required language in the list, to display the properties for that language. Those properties shown in bold indicate that this is the highest level at which this property can be defined (for most language options other than **Global**, this is effectively the *only* point at which the property is defined). Properties shown in normal font are generally the global properties that you can reset just for the current language.

Scroll through the property categories and individual properties for the language. You can collapse and expand categories as necessary, using the expansion box next to the category name ([-]).

When you click on a property name, an explanation of that property displays in the panel at the bottom right of the dialog, as shown for **Tabs Use Spaces** in the screen example above.

## Define Properties

To define a property, click on the value field following the property name. Depending on the type of property, either the field is enabled for direct editing or a drop-down arrow or **Browse** button displays (as described for the [Tagged Values](#) <sup>[635]</sup> window) to enable you to select the values to define the property. Select or type in the required values.

The Toolbar icons enable you to:

- Save your changes to the properties
- Reset **ALL** properties fields to the default settings shipped with Enterprise Architect
- Reset the current *style* field to the default setting (not enabled for non-style fields).

## Assign Keys to Macros

On the **Editor Language Properties** dialog, the *Macros* category enables you to assign **[Ctrl]+[Alt]** keystrokes to coding macros that you have created yourself in the [Source Code Viewer](#) <sup>[1442]</sup>. When you click on the **Browse** button in one of the **Macro** fields, the **Open Macro** dialog displays.

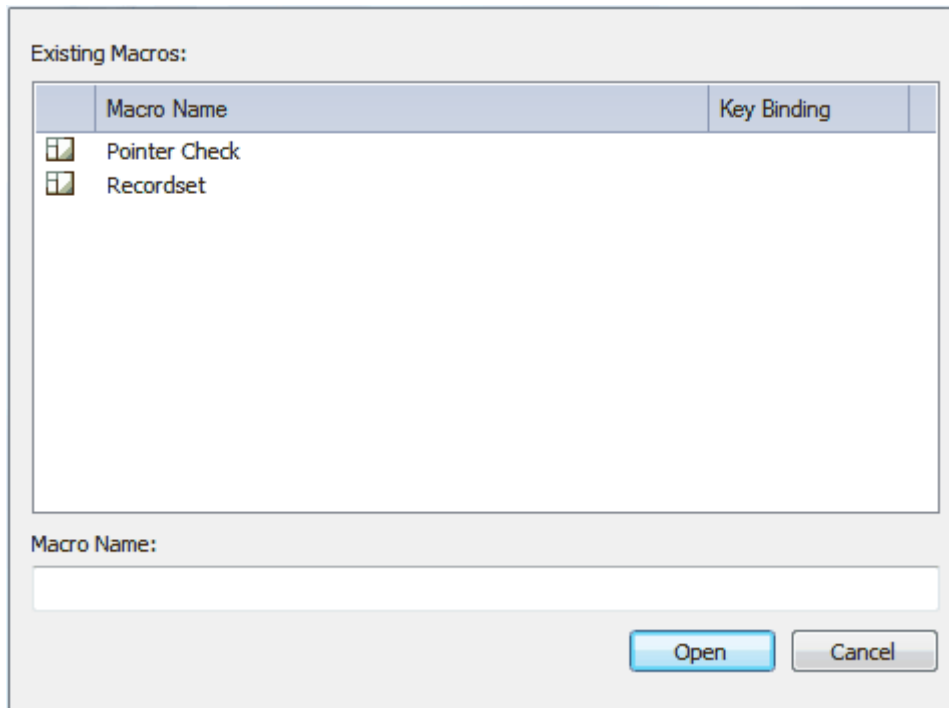

This dialog lists the existing macros and, if a key combination has been assigned to a macro, what that key combination is. These keys are **[Ctrl]+[Alt]+[n]** combinations.

Click on the name of the macro and on the **Open** button to assign the selected keys to the macro.

### 7.2.7.1.3 Options - Object Lifetimes

This set of options enables you to configure:

- Constructor details when generating code
- Whether to create a copy constructor
- Destructor details.

These options are accessed via the **Object Lifetimes** page of the **Options** dialog (select the **Tools | Options | Source Code Engineering | Object Lifetimes** menu option).



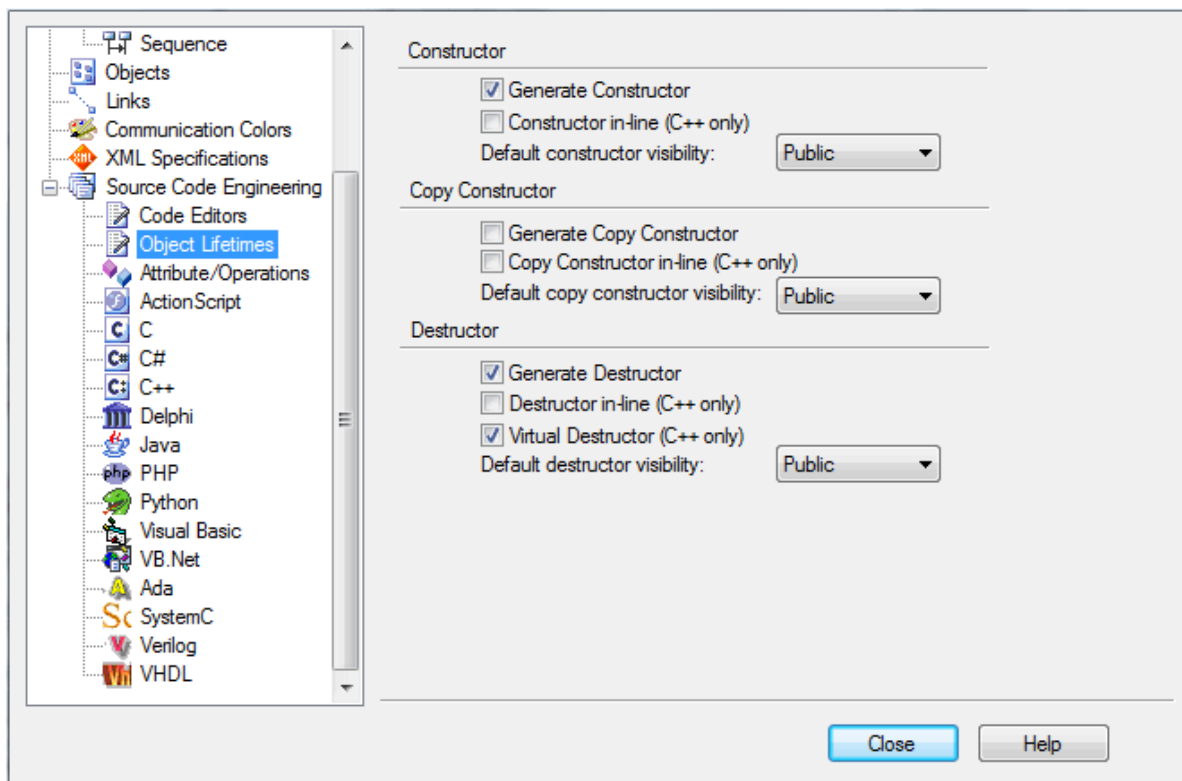

#### 7.2.7.1.4 Options - Attribute/Operations

This set of options enables you to:

- Configure the default name generated from imported attributes
- Generate methods for implemented interfaces
- Delete model attributes not included in the code during reverse synchronization
- Delete model methods not included in the code during reverse synchronization
- Delete code from features contained in the model during forward synchronization
- Delete model associations and aggregations that correspond to attributes not included in the code during reverse synchronization
- Define whether or not the bodies of methods are included and saved in the Enterprise Architect model when reverse engineering
- Create attributes in quick succession, clearing the dialog when you click on **Save** so that you can enter another attribute name.

These options are accessed via the **Attribute/Operations** page of the **Options** dialog (select the **Tools | Options | Source Code Engineering | Attribute/Operations** menu option).

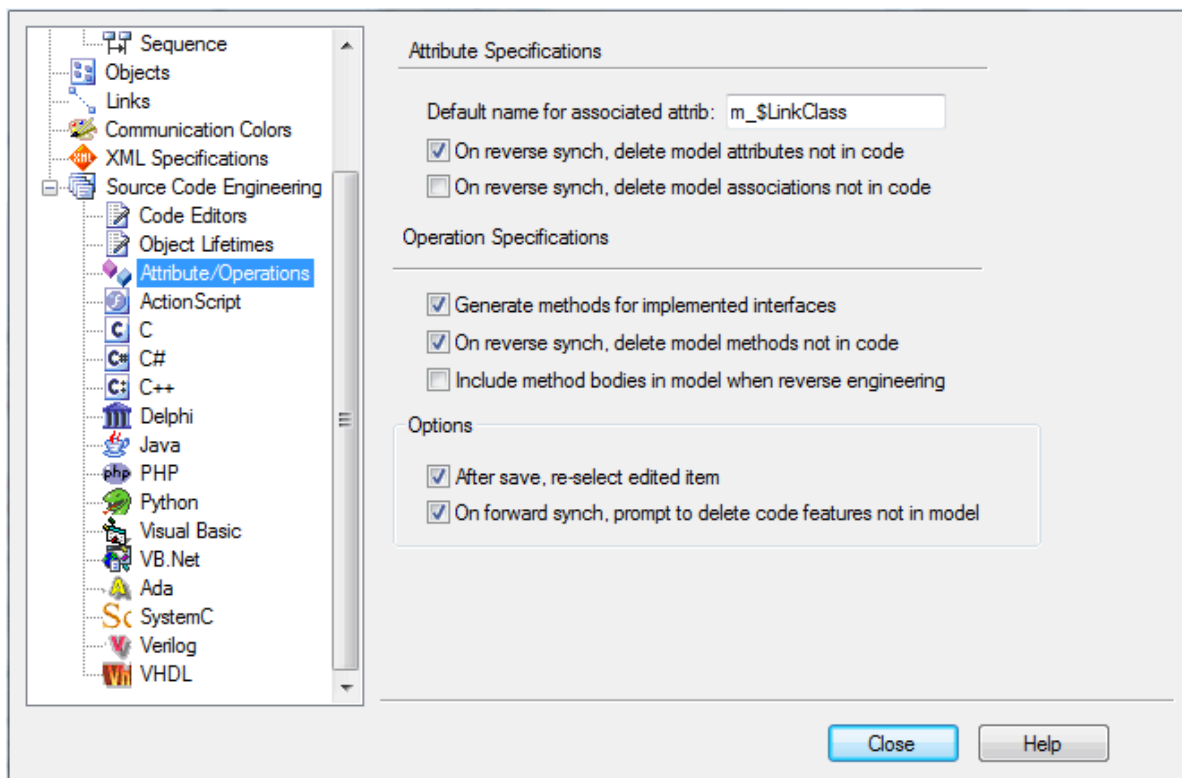

### 7.2.7.1.5 Code Page for Source Editing

Enterprise Architect enables you to define the Unicode character set for code generation. To set the Unicode character set follow the steps below:

1. Select the **Tools | Options | Source Code Engineering** menu option. The **Source Code Engineering** page of the **Options** dialog displays.

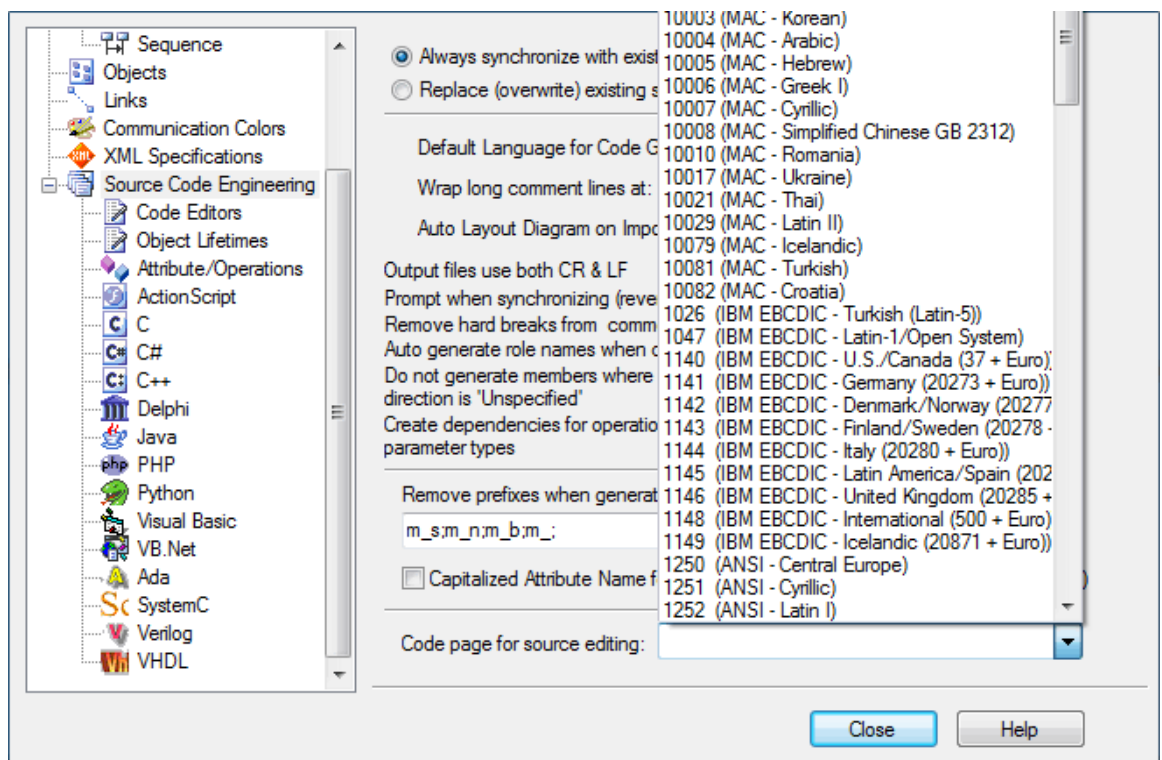

2. In the **Code page for source editing** field, click on the drop-down arrow and select the appropriate Unicode character set.
3. Click on the **Close** button.

### 7.2.7.2 Local Paths

Sometimes a team of developers could be working on the same Enterprise Architect model. Each developer might store their version of the source code in their local file system, but not always at the same location as their fellow developers. To handle this scenario, Enterprise Architect enables you to define local paths for each Enterprise Architect user, using the [Local Paths](#) <sup>[1343]</sup> dialog (select the **Settings | Local Paths** menu option).

As well as generating code and reverse engineering, you can use local paths in version control, developing XML schemas, and generating RTF and HTML reports.

Local paths take a bit of setting up, but if you want to work collaboratively on source and model concurrently, the effort is well worth while.

For example: developer A stores their .java files in a C:\Java\Source directory, while developer B stores theirs in D:\Source. Meanwhile, both developers want to generate and reverse engineer into the same Enterprise Architect model located on a shared (or replicated) network drive.

Developer A might define a local path of:

```
JAVA_SOURCE = "C:\Java\Source"
```

All Classes generated and stored in the Enterprise Architect project are stored as:

```
%JAVA_SOURCE%\<xxx.java>.
```

Developer B now defines a local path as:

```
JAVA_SOURCE ="D:\Source".
```

Now, Enterprise Architect stores all java files in these directories as:

```
%JAVA_SOURCE%\<filename>
```

On each developer's machine, the filename is expanded to the correct local version.

### 7.2.7.3 Local Paths Dialog

The **Local Paths** dialog enables you to set up local paths for a single user on a particular machine. For a description of what Local Paths are used for, see the [Local Paths](#) <sup>[1343]</sup> topic. To open the **Local Paths** dialog, select the **Settings | Local Paths** option.

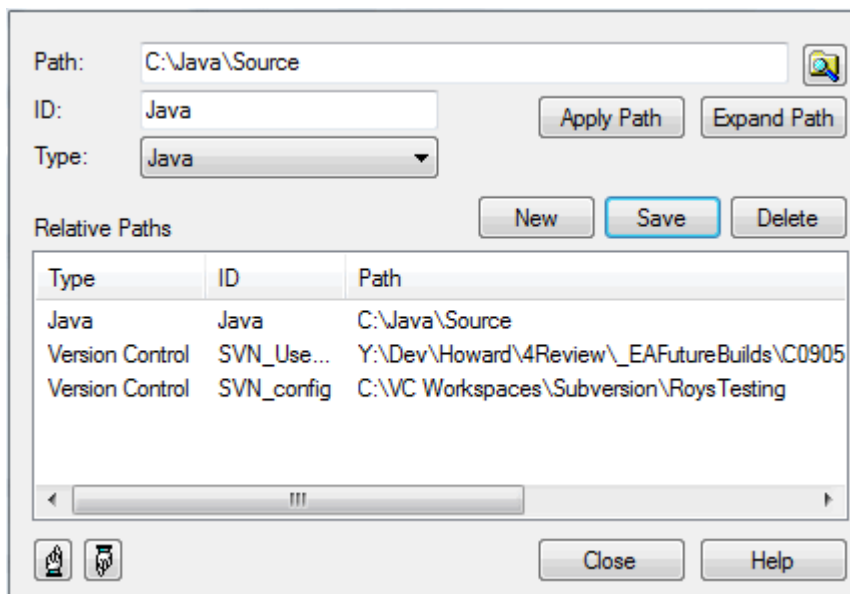

The **Local Paths** dialog enables you to define:

- **Path** - the local directory in the file system (for example, d:\java\source)
- **ID** - the shared ID that is substituted for the Local Path (for example, JAVA\_SRC)
- **Type** - the language type (for example, Java).

And also to:

- **Apply Path** - Select a path and click on this button to update any existing paths in the model (with full path names) to the shared relative path name (so `d:\java\source\main.java` might become `%JAVA_SRC%\main.java`)
- **Expand Path** - The opposite of **Apply Path**. This enables you to remove a relative path and substitute the full path name.

Using the two options you can update and change existing paths.

**Note:**

You can also set up a [hyperlink](#) [840] on a diagram to access the **Local Paths** dialog, to switch, update or expand your current Local Path.

### 7.2.7.4 Language Macros

When reverse engineering a language such as C++, you might find preprocessor directives scattered throughout the code. This can make code management easier, but can hamper parsing of the underlying C++ language.

To help remedy this, you can include any number of *macro* definitions, which are ignored during the parsing phase of the reverse engineering. It is still preferable, if you have the facility, to preprocess the code using the appropriate compiler first; this way, complex macro definitions and defines are expanded out and can be readily parsed. If you don't have this facility, then this option provides a convenient substitute.

**Note:**

You can transport these language macro (or preprocessor macro) definitions between models, using the [Export Reference Data](#) [223] and [Import Reference Data](#) [225] options on the **Tools** menu. The macros are exported as a *Macro List*.

### Define a Macro

1. Select the **Settings | Preprocessor Macros** menu option. The **Language Macros** dialog displays.

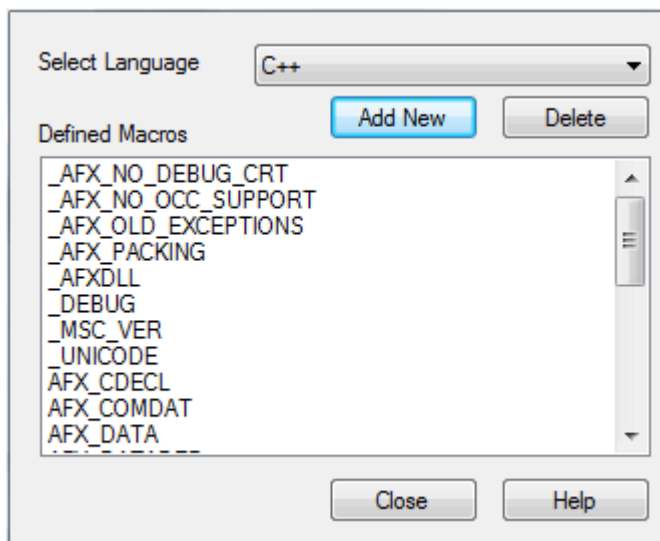

2. Click on the **Add New** button.
3. Enter details for your macro.
4. Click on the **OK** button.

### Macros Embedded Within Declarations

Macros are sometimes used within the declaration of Classes and operations, as in the following examples:

```
class __declspec Foo
{
    int __declspec Bar(int p);
};
```

If *declspec* is defined as a C++ macro, as outlined above, the imported Class and operation contain a Tagged Value called *DeclMacro1* with value `__declspec`. (Subsequent macros would be defined as *DeclMacro2*, *DeclMacro3* and so on.) During forward engineering, these Tagged Values are used to regenerate the macros in code.

## Define Complex Macros

It is sometimes useful to define rules for complex macros that can span multiple lines. Enterprise Architect ignores the entire code section defined by the rule. Such macros can be defined in Enterprise Architect as in the following two examples. Both types can be combined in one definition.

### Block Macros

```
BEGIN_INTERFACE_PART ^ END_INTERFACE_PART
```

where the ^ symbol represents the body of the macro. This enables skipping from one macro to another.

#### Note:

The spaces surrounding the ^ symbol are required.

### Function Macros

```
RTTI_EMULATION()
```

where Enterprise Architect skips over the token including everything inside the parentheses.

## 7.2.7.5 Set Collection Classes

Enterprise Architect enables you to define *Collection Classes* for generating code from Association connectors where the target role has a multiplicity setting greater than 1. There are two options for doing this:

1. On the **Source Code Engineering** section of the **Options** dialog (select the **Tools | Options | Source Code Engineering** option), on each language page click on the **Collection Classes** button.

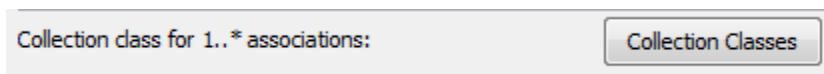

The **Collection Classes for Association Roles** dialog displays.

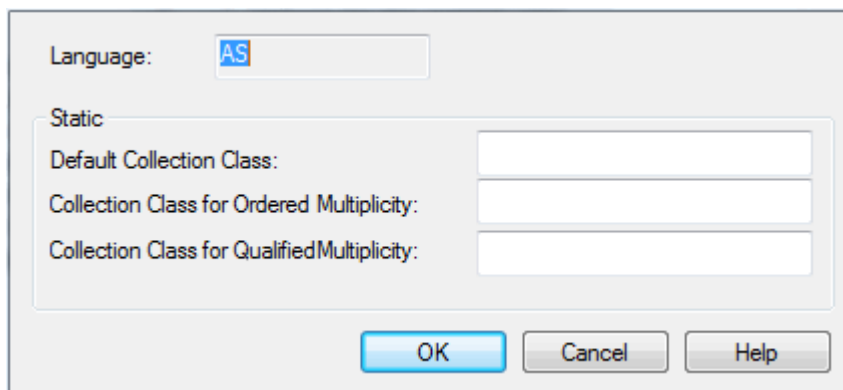

On this dialog, you can define:

- The default Collection Class for 1..\* roles
  - The ordered Collection Class to use for 1..\* roles
  - The qualified Collection Class to use for 1..\* roles.
2. On the **Detail** tab of the **Class Properties** dialog (accessible from the right-click context menu of any Class), click on the **Collection Classes** button.

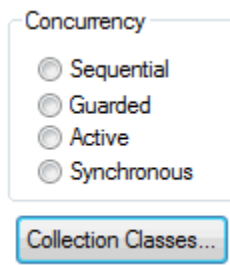

The **Collection Classes for Association Roles** dialog again displays, but here you define **for when only this Class is used**:

- The default Collection Class for 1..\* roles
- The ordered Collection Class to use for 1..\* roles
- The qualified Collection Class to use for 1..\* roles.

When Enterprise Architect generates code for a connector that has a multiplicity role >1, the Collection Class is calculated as follows:

1. If the **Qualifier** is set use the qualified collection:
  - for the Class if set
  - else use the code language qualified collection.
2. If the **Order** option is set use the ordered collection:
  - for the Class if set
  - else use the code language ordered collection.
3. Else use the default collection:
  - for the Class if set
  - else use the code language default collection.

**Note:**

You can include the marker #TYPE# in the collection name; Enterprise Architect replaces this with the name of the Class being collected at source generation time (for example, Vector<#TYPE#> would become Vector<foo>).

Additionally, on both the **Source Role** and **Target Role** tabs of the **Association Property** dialog (accessible from the right-click context menu of any Association) there is a **Member Type** field. If you set this, the value you enter overrides all the above options. The example below shows a defined *PersonList*; when code is generated, because this has a **Multiplicity** greater than 1 and the **Member Type** is defined, the variable created is of type *PersonList*.

### 7.2.7.6 Language Options

You can set up various options for how Enterprise Architect handles a particular language when generating code. These options are accessible on the **Options** dialog (select the **Tools | Options** menu option).

Under the **Source Code Engineering** option, select the required language. The following topics outline the options available for each language.

- [ActionScript](#) <sup>[1348]</sup>
- [Ada 2005](#) <sup>[1348]</sup> (in the System Engineering and Ultimate editions of Enterprise Architect)
- [ANSI C](#) <sup>[1349]</sup>
- [C#](#) <sup>[1350]</sup>
- [C++](#) <sup>[1351]</sup>
- [Delphi](#) <sup>[1352]</sup>
- [Delphi Properties](#) <sup>[1353]</sup>
- [Java](#) <sup>[1355]</sup>
- [PHP](#) <sup>[1356]</sup>
- [Python](#) <sup>[1356]</sup>
- [SystemC](#) <sup>[1357]</sup>
- [VB.Net](#) <sup>[1358]</sup>
- [Verilog](#) <sup>[1358]</sup>
- [VHDL](#) <sup>[1359]</sup>
- [Visual Basic](#) <sup>[1360]</sup>
- [MDG Technology Languages](#) <sup>[1360]</sup>
- [Reset Options](#) <sup>[1361]</sup>

### 7.2.7.6.1 ActionScript Options

Configure options for ActionScript code generation using the **ActionScript Specifications** page of the **Options** dialog (select the **Tools | Options | Source Code Engineering | ActionScript** menu option). The options you can specify include the:

- Default ActionScript version to generate (AS2.0 or AS3.0)
- Default file extensions (header and source)
- Default source directory
- Editor for ActionScript code.

ActionScript Specifications	
<input type="checkbox"/> Disable Language	
[-] Options for the current model	
Default Version	2.0
Default Extension	.as
[-] Options for the current user	
Default Source Directory	
Editor	
Collection class for 1..* associations:	
<input type="button" value="Collection Classes"/>	

### 7.2.7.6.2 Ada 2005 Options

**Note:**

Ada 2005 support is available in the System Engineering and Ultimate editions of Enterprise Architect.

Configure options for Ada 2005 code generation using the **Ada** page of the **Options** dialog (select the **Tools | Options | Source Code Engineering | Ada** menu option). The options you can specify include:

- Use Class Name for Tagged Record - to inform the reverse engineering process whether the name of the Tagged Record is the same as the package name
- Alternate Tagged Record Name - to advise the engine of the alternate Tagged Record name to locate
- Define Reference for Tagged Record - to specify whether the engine should create a reference type for the Tagged Record ( if one is not defined)
- Reference Type Name - to supply the name of the reference type to be created (default is *Ref*)
- Ref Parameter Style - to specify the reference parameter of a Reference / Access type
- Ignore Reference Parameter Name - to tell the engine to ignore the name of the reference parameter
- Ref Parameter Name - to indicate the name of the reference parameter to locate



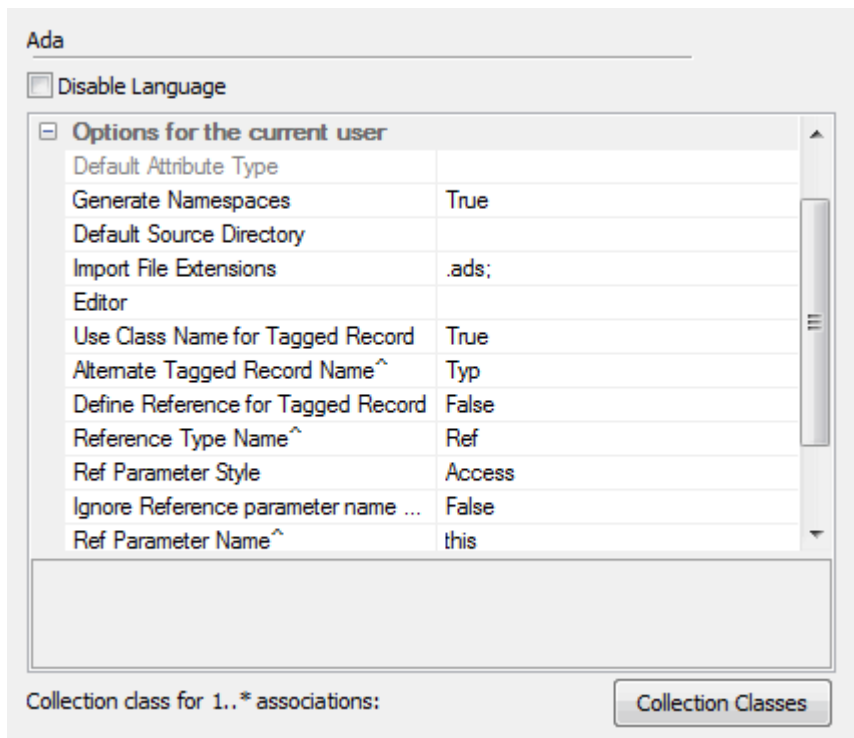

### 7.2.7.6.3 C Options

Configure options for C code generation using the **C Specifications** page of the **Options** dialog (select the **Tools | Options | Source Code Engineering | C** menu option). The options you can specify include:

- Support for Object Oriented coding
- Default file extensions (header and source)
- Default source directory
- Editor for C code
- Path that Enterprise Architect uses to search for the implementation file; the first path in the list is the default path when generating.

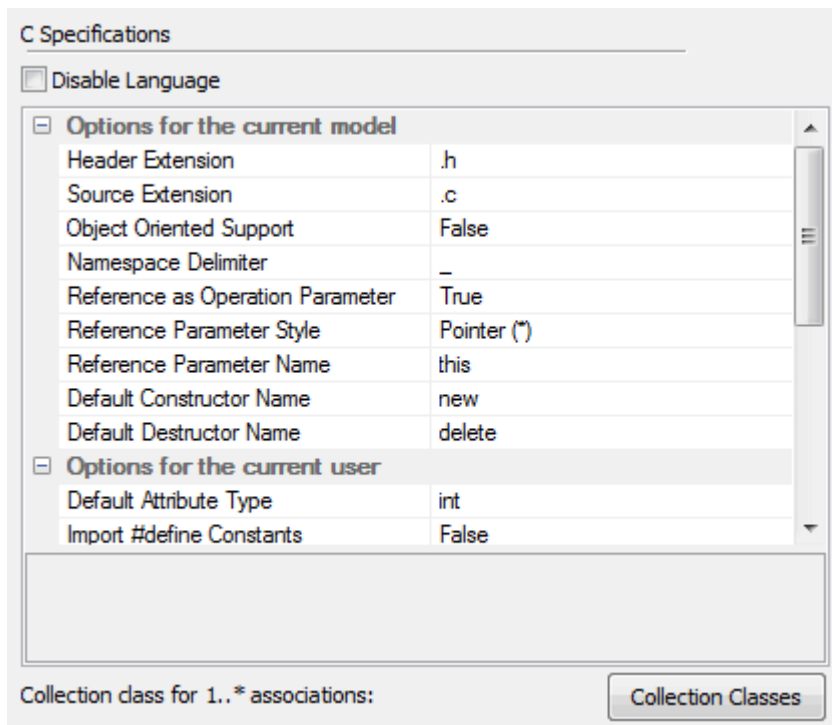

#### 7.2.7.6.4 C# Options

Configure options for C# code generation using the **C# Specifications** page of the **Options** dialog (select the **Tools | Options | Source Code Engineering | C#** menu option). The options you can specify include the default:

- File extension
- 'Get' prefix
- 'Set' prefix
- Directory for opening and saving C# source code.

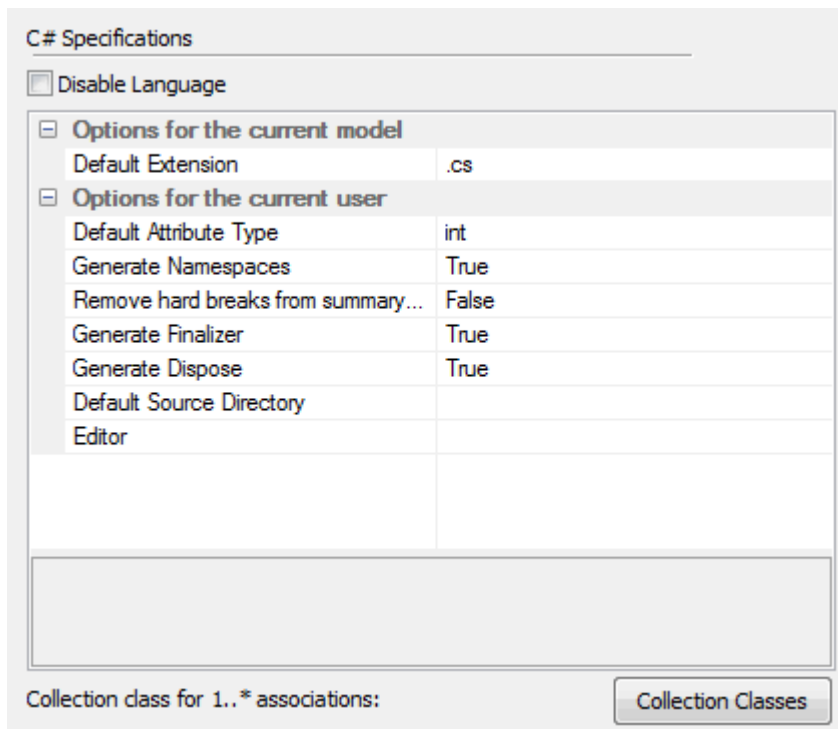

#### 7.2.7.6.5 C++ Options

Configure options for C++ code generation using the **C++ Specifications** page of the **Options** dialog (select the **Tools | Options | Source Code Engineering | C++** menu option). The options you can specify include:

- The version of C++ to generate; this controls the set of templates used and how properties are created
- The default reference type used when a type is specified by reference
- The default file extensions
- Default Get/Set prefixes
- Default source directory
- The path that Enterprise Architect uses to search for the implementation file. The first path in the list is the default path when generating new implementation files and parsing existing files; if you add further directories, Enterprise Architect also searches these when parsing existing files.

For example, you have a directory *inc* that contains all of your headers, while the source code is mixed through directories *src*, *srcA*, and *srcB*. You therefore set the **Source Path** option to **../src;../srcA;../srcB/**. This ensures that new implementation files are generated into *src*, but when parsing existing files Enterprise Architect looks in all three source directories (but never in the *inc* directory). You must still ensure that the implementation file name matches the header file name, and that the file extension matches the extension specified in the options. If these conditions are not met, Enterprise Architect cannot handle that code.

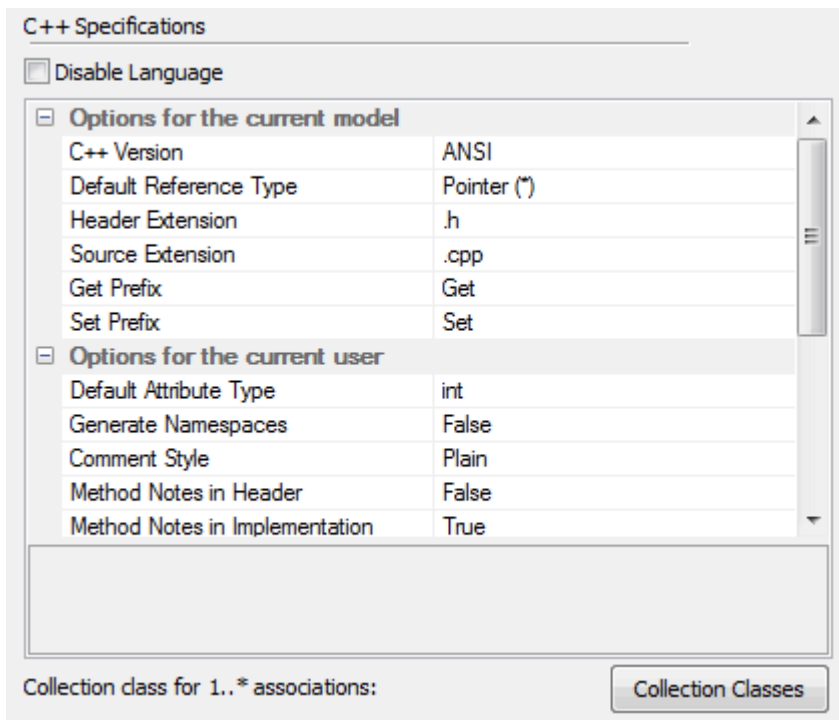

#### 7.2.7.6.6 Delphi Options

Configure options for Delphi code generation using the **Delphi Specifications** page of the **Options** dialog (select the **Tools | Options | Source Code Engineering | Delphi** menu option). The options you can specify include the:

- Default file extension
- Default source directory

You can also set a default directory for opening and saving Delphi source code.

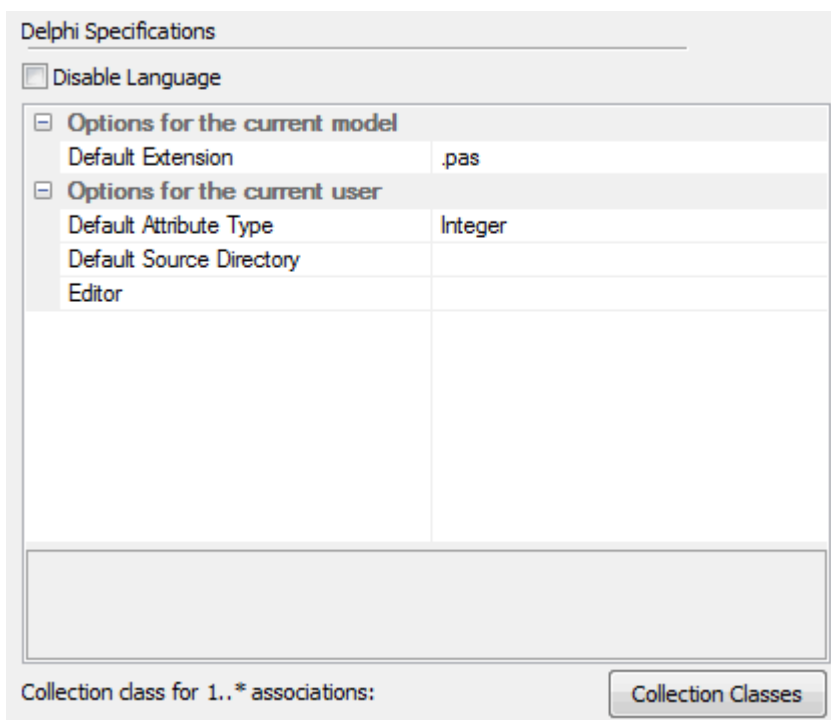

You should also set [Delphi properties](#) <sup>[1355]</sup> within each Class element.

### 7.2.7.6.6.1 Delphi Properties

Enterprise Architect has comprehensive support for Delphi properties. These are implemented as Tagged Values, with a specialized property editor to help create and modify Class properties. The Class image below illustrates the appearance of a Delphi Class that has had properties added to it. These are stored as Tagged Values, and by using the **Feature Visibility** element context menu option, you can display the 'tags' compartment that contains the properties. Imported Delphi Classes with properties have this feature automatically made visible for your convenience.

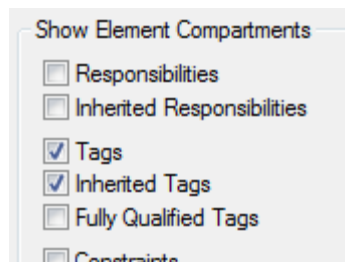

#### Note:

When you use the **Create Property** dialog from the **Attribute** screen, Enterprise Architect generates a pair of Get and Set functions, together with the required property definition as Tagged Values. You can manually edit these Tagged Values if required.

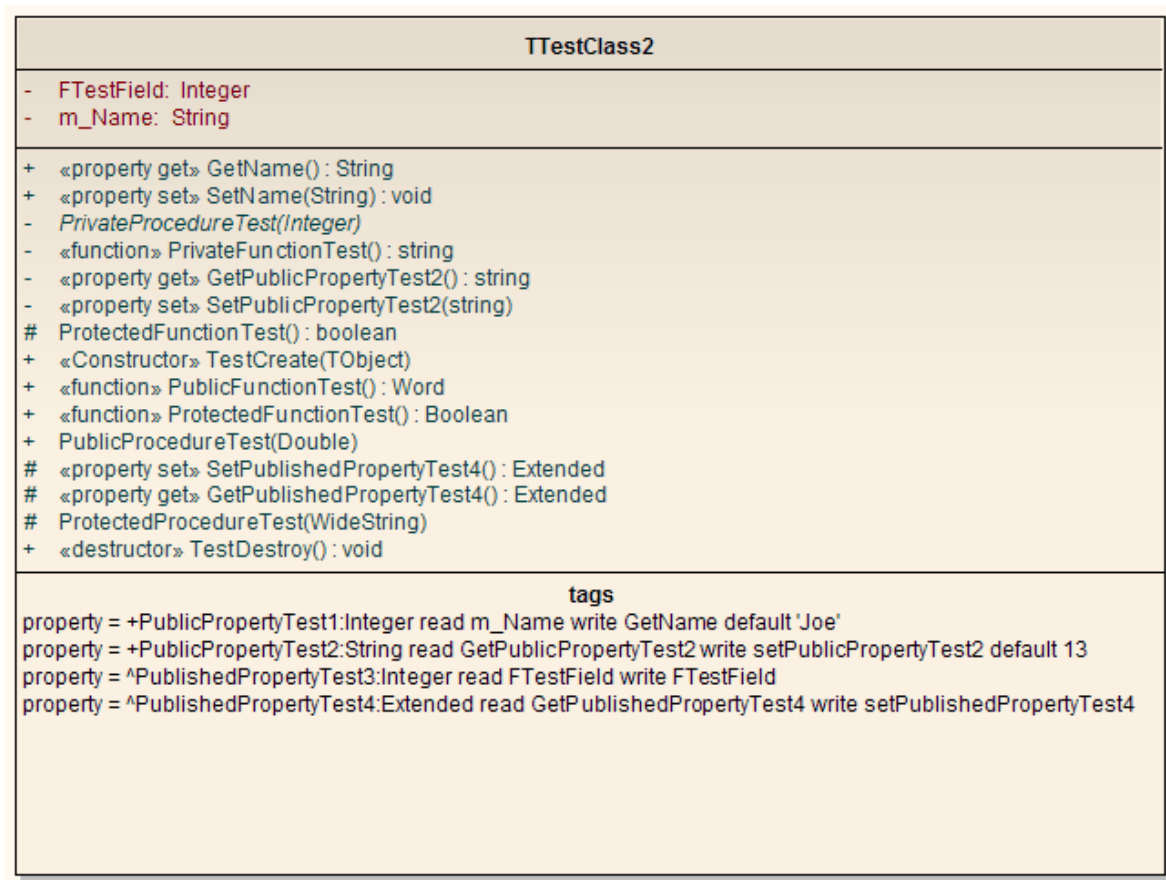

#### To manually activate the property editor

1. Ensure the Class you have selected has the code generation language set to Delphi
2. Right-click on the Class and select the **Delphi Properties** context menu option to open the editor.

The **Delphi Properties** editor enables you to build properties in a simple and straightforward manner. From here you can:

- Change the name and scope (only **Public** and **Published** are currently supported)
- Change the property type (the drop-down list includes all defined Classes in the project)
- Set the **Read** and **Write** information (the drop-down lists have all the attributes and operations from the current Class; you can also enter free text)
- Set **Stored** to **True** or **False**
- Set the **Implements** information
- Set the **Default** value, if one exists.

The screenshot shows the 'Property Details' dialog box in Delphi. The 'Name' field contains 'PublishedPropertyTest3', with 'Published' checked and 'Indexed' unchecked. The 'Type' is set to 'Integer'. The 'Read' and 'Write' fields are both set to 'FTestField'. The 'Stored' field is empty. The 'Implements' and 'Default' fields are also empty. The 'Definition' field contains the text '^PublishedPropertyTest3:Integer read FTestField write FTestField'. Below the 'Property Details' section are buttons for 'New', 'Save', 'Delete', and 'Close'. The 'Defined Properties' list at the bottom shows a list of properties, including the one being edited, which is marked with a '^' symbol.

#### Notes:

- Public properties are displayed with a '+' symbol prefix and published with a '^'.
- When creating a property in the **Create Property Implementation** dialog (accessed through the **Attributes** dialog), you can set the scope to **Published** if the property type is Delphi - see the example below.

The screenshot shows a 'Property Details' dialog box. On the left, under 'Language', 'Delphi' is selected with a radio button. The 'Property Details' section contains the following fields and options:

- Name: FTestField
- Getter: GetFTestField()
- Setter: SetFTestField( Value: Integer )
- Stereotype: (empty dropdown)
- Published:
- Read:
- Write:
- Get Scope: Public
- Set Scope: Public

Buttons for 'OK', 'Cancel', and 'Help' are located on the right side of the dialog.

### Limitations

- Only **Public** and **Published** are supported
- If you change the name of a property and forward engineer, a new property is added, but the old one must be manually deleted from the source file.

#### 7.2.7.6.7 Java Options

Configure options for Java code generation using the [Java Specifications](#) page of the [Options](#) dialog (select the **Tools | Options | Source Code Engineering | Java** menu option). The options you can specify include the:

- Default file extension
- Default 'Get' prefix
- Default 'Set' prefix

You can also set a default directory for opening and saving Java source code.

The screenshot shows the 'Java Specifications' dialog box. It has a 'Disable Language' checkbox which is unchecked. Below it are two expandable sections:

- Options for the current model**
  - Default Extension: java
  - Get Prefix: get
  - Set Prefix: set
  - Default Collection Class: (empty)
- Options for the current user**
  - Default Attribute Type: int
  - Default Source Directory: (empty)
  - Editor: (empty)

At the bottom, there is a text field labeled 'Collection class for 1..\* associations:' and a 'Collection Classes' button.

### 7.2.7.6.8 PHP Options

Configure options for PHP code generation using the **PHP Specifications** page of the **Options** dialog (select the **Tools | Options | Source Code Engineering | PHP** menu option). The options you can specify include the:

- Default source extension - specify the extension to be used when creating files for PHP source
- Default import extension - a semi-colon separated list of extensions to look at when doing a [directory code import](#) for PHP
- Default PHP version - the version of PHP to generate.

You can also set a default directory for opening and saving PHP source code.

Options for the current model	
Default Version	4.0
Default Extension	.php
Get Prefix	get
Set Prefix	set

Options for the current user	
Default Source Directory	
Import File Extensions	.php;.php4;.inc;
Editor	

Collection class for 1..\* associations:

### 7.2.7.6.9 Python Options

Configure options for Python code generation using the **Python Specifications** page of the **Options** dialog (select the **Tools | Options | Source Code Engineering | Python** menu option). The options you can specify include the:

- Default file extension(s)
- Default source directory.

You can also set the editor for Python code.



Python Specifications

Disable Language

Options for the current model	
Default Extension	.py
Options for the current user	
Default Source Directory	
Editor	

Collection class for 1..\* associations:

#### 7.2.7.6.10 SystemC Options

Configure options for SystemC code generation using the **SystemC** page of the **Options** dialog (select the **Tools | Options | Source Code Engineering | SystemC** menu option). The options you can specify include the:

- Default file extension(s)
- Default source directory
- Editor for changing code.

SystemC

Disable Language

Options for the current model	
Default Extension	sc
Options for the current user	
Default Attribute Type	
Default Source Directory	
Import File Extensions	.sc
Editor	

Collection class for 1..\* associations:

### 7.2.7.6.11 VB.Net Options

Configure options for VB.Net code generation using the **VB.Net Specifications** page of the **Options** dialog (select the **Tools | Options | Source Code Engineering | VB.Net** menu option). The options you can specify include the:

- Default file extension
- Default source directory.

VB.Net Specifications

Disable Language

Options for the current model

Default Extension	.vb
-------------------	-----

Options for the current user

Default Attribute Type	Variant
Generate Namespaces	True
Default Source Directory	
Editor	

Collection class for 1..\* associations:

Collection Classes

### 7.2.7.6.12 Verilog Options

Configure options for Verilog code generation using the **Verilog** page of the **Options** dialog (select the **Tools | Options | Source Code Engineering | Verilog** menu option). The options you can specify include the:

- Default file extension(s)
- Default source directory
- Editor for changing code.

Verilog

Disable Language

Options for the current model	
Default Extension	.v

Options for the current user	
Default Attribute Type	
Default Source Directory	
Import File Extensions	.v;.verilog
Editor	

Collection class for 1..\* associations:

#### 7.2.7.6.13 VHDL Options

Configure options for VHDL code generation using the **VHDL** page of the **Options** dialog (select the **Tools | Options | Source Code Engineering | VHDL** menu option). The options you can specify include the:

- Default file extension(s)
- Default source directory
- Editor for changing code.

VHDL

Disable Language

Options for the current model	
Default Extension	vhdl

Options for the current user	
Default Attribute Type	
Default Source Directory	
Import File Extensions	.vhdl;.vhd
Editor	

Collection class for 1..\* associations:

#### 7.2.7.6.14 Visual Basic Options

Configure options for Visual Basic code generation using the **VB Specifications** page of the **Options** dialog (select the **Tools | Options | Source Code Engineering | Visual Basic** menu option). The options you can specify include the:

- Default file extension when reading/writing
- Default Visual Basic version
- MTS transaction mode for MTS objects
- Multi use (true or false)
- Persistable
- Data binding
- Global namespace
- Exposed
- Data source behavior
- Creatable.

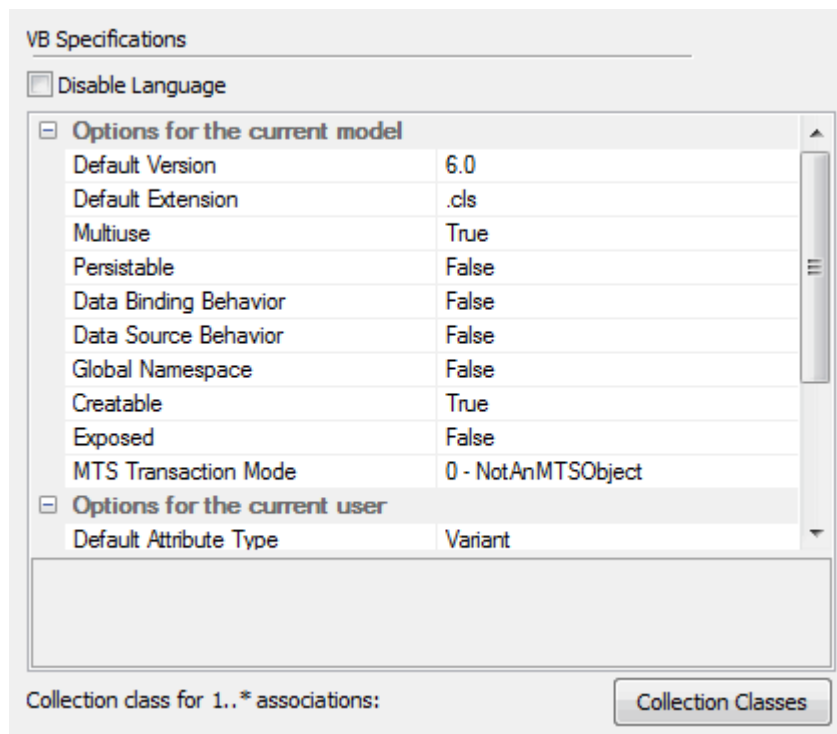

#### 7.2.7.6.15 MDG Technology Language Options

If you have loaded an [MDG Technology](#) [1118] that specifies a [code module](#) [1128] into your *Sparx Systems > EA > MDG Technologies* folder, the language is included in the **Source Code Engineering** list on the **Options** dialog. The language is only listed on the **Options** dialog if an MDG Technology file actually uses it in your model.

The options for each language are based on what is defined in the technology code module, but are limited to the following:

- **Default Extension**
  - Default extension for generated source files
  - Shown if the option is in the technology
  - Saved per project.
- **Import File Extensions**
  - Default folder to import source files from
  - Shown if there is a grammar set in the technology

- Saved once for all projects.
- **Generate Namespaces**
  - Option to generate namespaces or not
  - Shown if the technology supports namespaces
  - Saved once for all projects.
- **Default Source Directory**
  - The default directory to save generated source files
  - Always shown
  - Saved once for all projects.
- **Editor**
  - The editor that is loaded to edit the source files
  - Always shown
  - Saved once for all projects.
- **Att Type**
  - Default type for attributes
  - Always shown
  - Saved once for all projects.

These options are set in the technology inside the `<CodeOptions>` tag of a code module, as follows:

```
<CodeOption name="DefaultExtension">.rb</CodeOption>
```

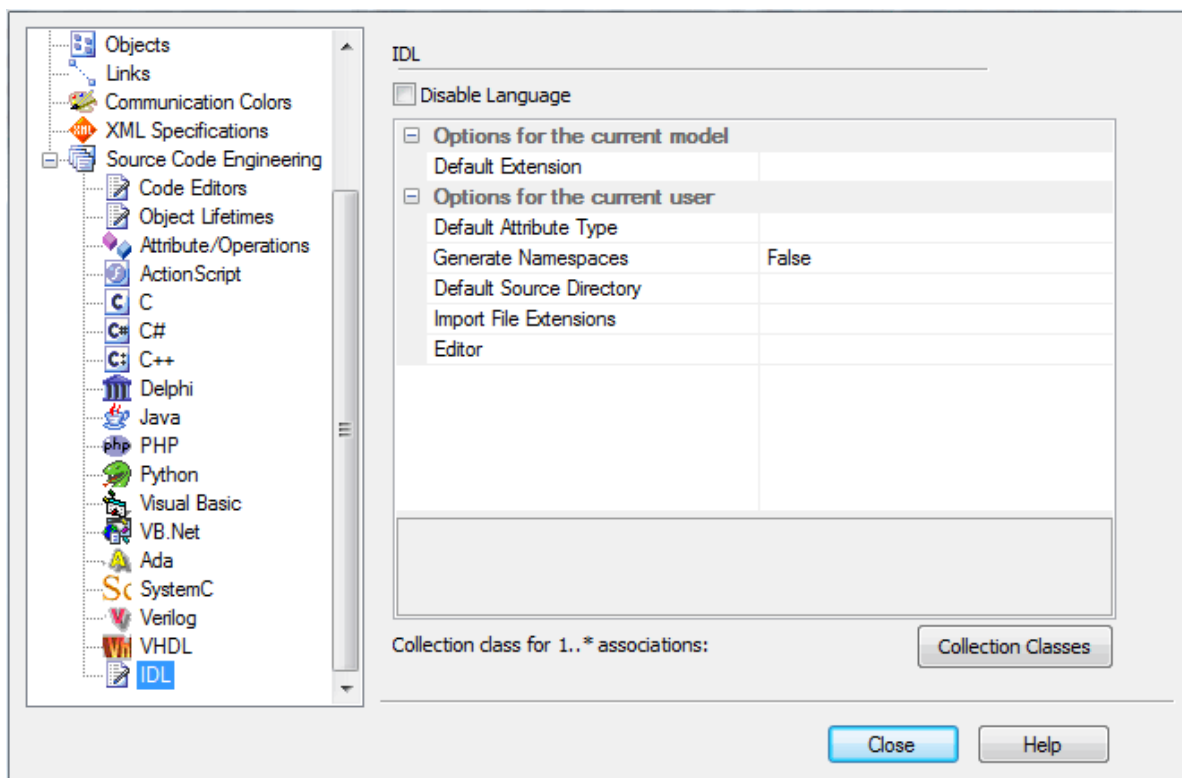

#### 7.2.7.6.16 Reset Options

Enterprise Architect stores some of the options for a Class when it is first created. Some are global; for example `$LinkClass` is stored when you first create the Class, so it won't automatically pick up the global change in the **Options** dialog in existing Classes. You must modify the options for the existing Class.

#### Modify Options for Single Class

To modify options for a single Class, follow the steps below:

1. Right-click on the Class to change, and select the **Generate Code** menu option from the context menu. The **Generate Code** dialog displays.
2. Click on the **Advanced** button. The **Object Options** dialog displays.
3. Click on the **Attributes/Operations** button.
4. Change the options, and click on the **Close** button to apply changes.

### Modify Options for All Classes

To modify options for all Classes within a package, follow the steps below:

1. Right-click on the package in the **Project Browser**. The context menu displays.
2. Select the **Code Engineering | Reset Options for this Package** menu option. The **Manage Code Generation** dialog displays.

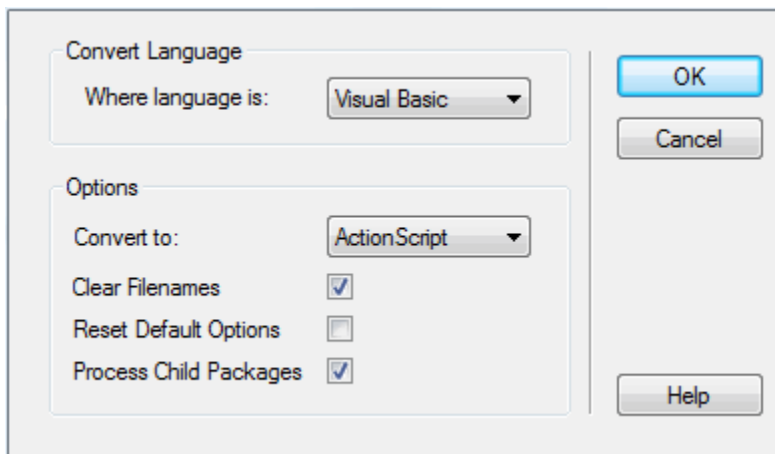

3. Reset the required defaults for each existing Class.
4. Click on the **OK** button to apply changes.

## 7.3 Database Engineering



This section describes database engineering, explaining:

- How to [import database schema](#)<sup>[1363]</sup>, and
- How to [generate DDL](#)<sup>[1367]</sup> for the model.

For information on database modeling, see the [Data Models](#)<sup>[1017]</sup> topic.

### 7.3.1 Import Database Schema

Analysis of legacy database systems is possible using Enterprise Architect's [reverse engineering](#)<sup>[1328]</sup> capabilities. By connecting to a live database via ODBC, you can import the database schema into a standard UML model. Subsequent imports enable you to maintain synchronization between the data model and the live database.

Enterprise Architect supports importing database tables from an ODBC data source. Tables are imported as stereotyped Classes with suitable data definitions for the source DBMS.

#### Notes:

- Import of stored procedures and views is supported for: DB2; SQL Server; Firebird/Interbase; Informix; Ingres; Oracle 9i, 10g and 11g; MySQL; PostgreSQL; Sybase Adaptive Server Enterprise (ASE) and Sybase Adaptive Server Anywhere (ASA).
- If you are importing database schema from an MS Access Jet 4.0 database, please ensure that you have selected the **Use Jet 4.0** checkbox on the [General](#)<sup>[357]</sup> page of the **Options** dialog. Otherwise, the Jet 3.5 routines are loaded. You must restart Enterprise Architect after selecting the checkbox.
- The ODBC connection should use the ODBC driver available from the DBMS vendor. For example, MySQL's ODBC driver for MySQL, and Oracle's ODBC driver for Oracle. Drivers provided by third-party vendors are not supported - this includes the *Microsoft* ODBC driver for Oracle.
- If setting up a ODBC connection for reverse engineering, the default settings are sufficient.
- Additional data types are available from the [Datamodeling Data Types](#) section of the [Resources](#) page on the Sparx Systems website.

### Import Database Tables and Stored Procedures

To import database tables and stored procedures, follow the steps below:

1. Select any package in the **Logical View**.
2. To import into:
  - The package only, right-click on the package to display the context menu, and select the **Code Engineering | Import DB Schema from ODBC** menu option.
  - A diagram, right-click on the diagram in the selected package to open the context menu, and select the **Import DB schema from ODBC** menu option.

#### Note:

Alternatively you can select the **Project | Database Engineering | Import DB Schema from ODBC** menu option.

The **Import DB Schema from ODBC Source** dialog displays.

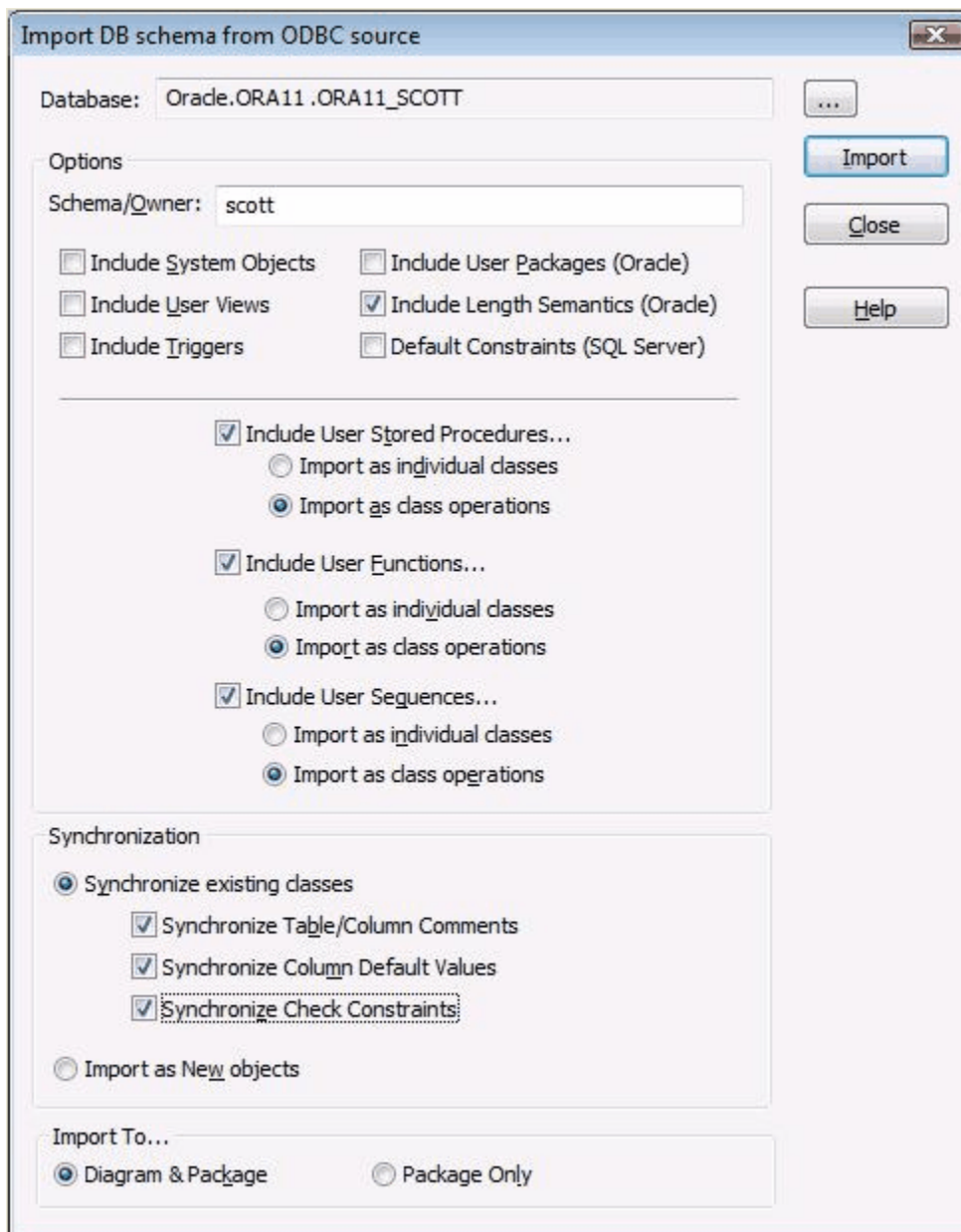

3. In the **Database** field, click on the [ ... ] (Browse) button and [select a suitable ODBC data source](#)<sup>[1365]</sup> from the **ODBC** dialog (ODBC must be installed and configured on your machine for this to work correctly).

When you have selected the data source, the **Database** field shows the DBMS, the database server ID and the database name, separated by full stops; that is:  
*dbms.dbserver.database.*

4. If importing from Oracle, to restrict the import to a specific owner, type the owner name in the **Schema/Owner** field. By default, Enterprise Architect inserts the Oracle user name in this field.

For imports from other types of database, leave this field blank.

5. In the **Filter** panel, select the appropriate checkboxes for additional items to include in the import.

Select the appropriate checkboxes to import system tables and views, user views, triggers and/or Oracle packages.

If you select to import *User Functions* and/or *User Sequences* as individual Classes, then they are imported as separate elements and the **Properties** dialog is solely concerned with the Function or Sequence definition. For *Stored Procedures*, always select this option



If you select to import *User Functions* and/or *User Sequences* as Class operations, then they are imported as operations (methods) and you view and edit them through the **Operations Properties** dialog of the parent Class.

- When synchronizing existing Classes, select the appropriate checkbox in the **Synchronization** panel to determine whether the model comments, default values or constraints are to be synchronized with the ODBC tables, or as new objects.

**Note:**

It is only possible to import into a diagram if it is in the selected package. If a diagram from another package is open, a message displays to give the option to cancel the import or to continue importing into the package only. The **Import DB Schema from ODBC Source** dialog includes checkbox options to import into the diagram and package, or into the package only.

If no diagram is open, the **Package Only** radio button defaults to selected and the options are disabled. If the open diagram is in the selected package, you can select either option.

- Click on the **Import** button to start the import.
  - [Select the tables](#)<sup>[1367]</sup> and - if appropriate - stored procedures to import.
- This completes the procedure. See the [Imported Class Elements](#)<sup>[1367]</sup> topic.

### 7.3.1.1 Select a Data Source

To import DDL from existing data sources, you must have a [suitable ODBC connection installed and configured](#)<sup>[147]</sup>. From the **Import DB Schema from ODBC Source** dialog you can select the ODBC data source using the standard windows **ODBC set-up** dialog. Click on the data source name and then click on the **OK** button.

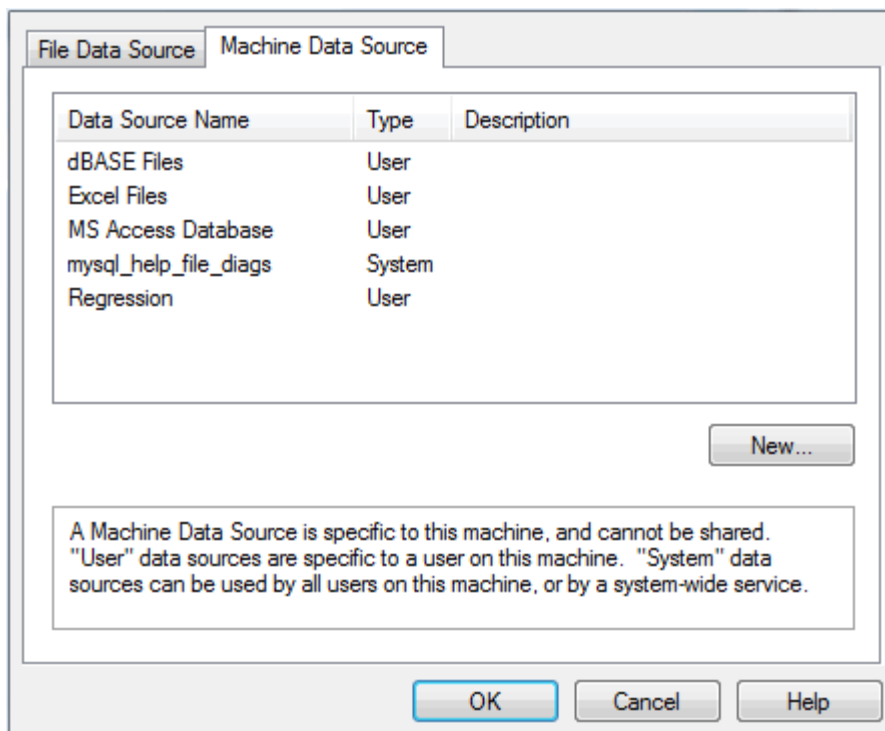

### 7.3.1.2 Select Tables

When you have opened the ODBC data source, Enterprise Architect acquires a list of tables and stored procedures suitable for importing. This is presented in a list form for you to select from.

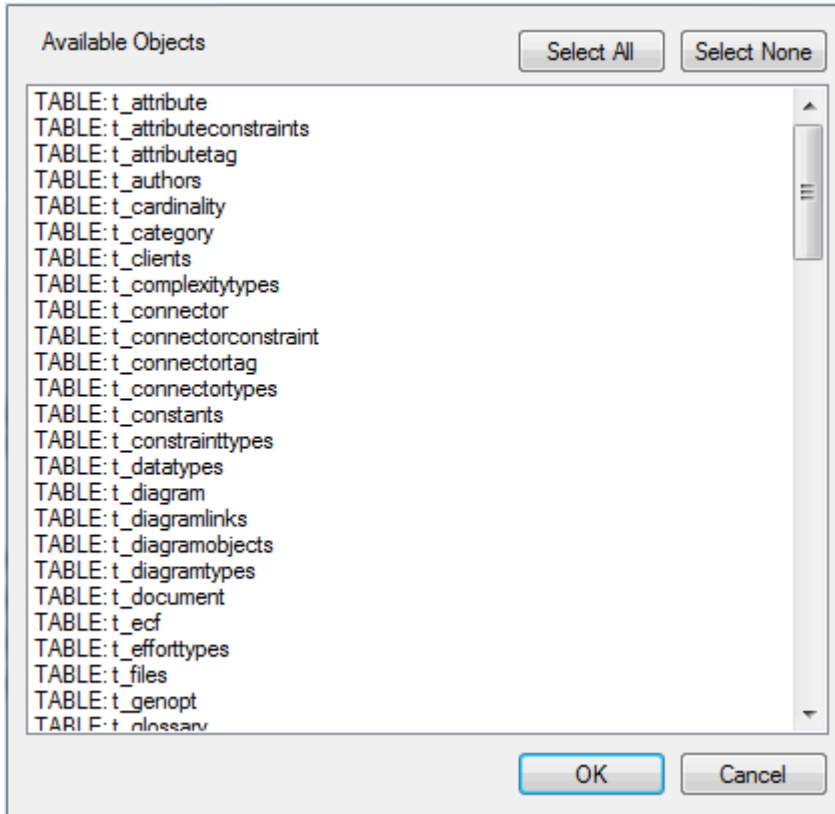

Highlight the tables and stored procedures to import and clear those you do not require.

Selection shortcuts:

- To select all tables and procedures, click on the **Select All** button
- To clear all tables and procedures, click on the **Select None** button
- Hold down **[Ctrl]** while clicking on tables and procedures to select multiple objects
- Hold down **[Shift]** and click on tables and procedures to select a range.

When you have selected the tables and procedures, click on the **OK** button.

### 7.3.1.3 The Imported Class Elements

When you import DDL table definitions they are converted to stereotyped Classes according the *UML Data Modeling Profile*.

The image below shows some example tables imported into the model using an ODBC data connection.

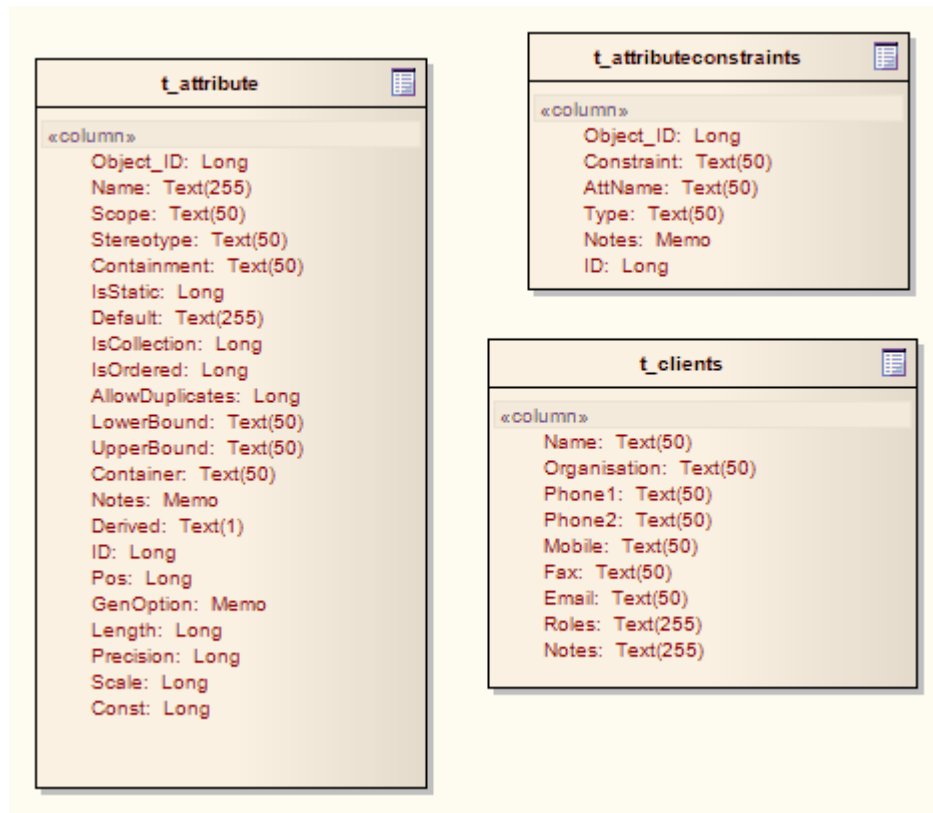

## 7.3.2 Generate DDL

The following topics describe how to generate DDL from your model for:

- [Tables](#) <sup>1367</sup> and
- [Packages](#) <sup>1369</sup>.

### 7.3.2.1 Generate DDL For a Table

#### Note:

In the Corporate, Business and Software Engineering, System Engineering and Ultimate editions of Enterprise Architect, if security is enabled you must have [Generate Source Code and DDL](#) <sup>198</sup> permission to generate DDL.

To generate simple DDL scripts to create the tables in your model, follow the steps below:

1. In the diagram, right-click on the table for which to generate DDL. The context menu displays.
2. Select the **Generate DDL** option. The **Generate DDL** dialog displays.

Table:

Path:  ...

Options

Comment Level  Use  and  as comment

Create Primary/Foreign Key Constraints  Generate Packages (Oracle)

Generate Index/Constraints  Generate Table Properties (Oracle)

Generate Triggers  Generate Length Semantics (Oracle)

Generate Stored Procedures  Generate Functions

Generate Views  Generate Sequences

Create Drop SQL Default Constraints (SQL Server):

Use  as SQL Terminator  on the same line.

Use  and  around names

Generate Table Owner

Use Database

Use Alias if Available

Use NULL for nullable columns

- In the **Path** field, use the [ ... ] (Browse) button to select the filename of the script to create.
- To include comments in the DDL, in the **Comment Level** field select the appropriate level. For example, **Column** for comments on columns, or **All** for comments on all structures.
- Select the checkboxes for the appropriate inclusions. For example, to include a 'drop table' command in the script, select the **Create Drop SQL** checkbox. Deselect the checkboxes for inclusions you do not require.

#### Notes:

- Some checkboxes display only if the appropriate database is defined for the table. For example, **IF EXISTS** displays only if the database for the table is PostgreSQL.
- For a PostgreSQL database, you must select the **Generate Sequences** checkbox to enable auto increment columns to be created.
- If generating Oracle sequences, you must always select the **Generate Triggers** and **Generate Sequences** checkboxes; this ensures that a pre-insert trigger is generated to select the next sequence value to populate the column. Also set the **AutoNum** <sup>1027</sup> property to **True** in the column properties.

- To create the DDL, click on the **Generate** button.
- To view the output, click on the **View** button (you must configure a DDL viewer in the **Local Settings** dialog first).

**Note:**

You can transport these DDL scripts between models, using the [Export Reference Data](#)<sup>[223]</sup> and [Import Reference Data](#)<sup>[223]</sup> options on the **Tools** menu.

### 7.3.2.2 Generate DDL for a Package

**Note:**

In the Corporate, Business and Software Engineering, System Engineering and Ultimate editions of Enterprise Architect, if security is enabled you must have [Generate Source Code and DDL](#)<sup>[198]</sup> permission to generate DDL.

In this procedure, you can generate DDL for a package, and also compare the DDL with the database.

### Generate DDL

To generate DDL for a package, follow the steps below:

1. Right-click on the required package in the **Project Browser**. The context menu displays.
2. Select the **Code Engineering | Generate DDL** menu option. The **Generate Package DDL** dialog displays.

Root Package:

**Options**

Comment Level  Use  and  as comment

Create Primary/Foreign Key Constraints

Generate Index/Constraints

Generate Triggers  Generate Packages (Oracle)

Generate Stored Procedures  Generate Table Properties (Oracle)

Generate Views  Generate Functions

Create Drop SQL  Generate Sequences

Use  as SQL Terminator  on the same line.

Use  and  around names

Generate Table Owner

Use Database

Use Alias if Available

Use NULL for nullable columns

**File Generation**

Single File

Individual file for each table

Select Objects to Generate   Include all Child Packages

Object	Type	Target File
Account	table	
LineItem	table	
Order	table	
OrderStatus	table	
ShoppingBasket	table	
StockItem	table	
Transaction	table	

**Note:**

Alternatively you can select the **Project | Database Engineering | Generate Package DDL** menu option.

3. Select the checkbox against each inclusion required. Deselect the checkboxes for inclusions you do not require.

**Notes:**

- Some checkboxes display only if the appropriate database is defined for the tables in the package. For example, **IF EXISTS** displays only if the database for the tables is PostgreSQL.
  - If generating Oracle sequences, you must always select the **Generate Triggers** and **Generate Sequences** checkboxes; this ensures that a pre-insert trigger is generated to select the next sequence value to populate the column. Also set the **AutoNum** property to **True** in the column properties.
4. To recursively generate DDL, select the **Include All Child Packages** checkbox.
  5. Click on the **Generate** button to proceed. Enterprise Architect prompts you for file names as the process executes.

## Compare DDL For a Database

When you have generated the DDL, you can compare it with the database. To do this, follow the steps below:

1. On the **Generate Package DDL** dialog, click on the **Compare** button. The **Compare With Database** dialog displays.

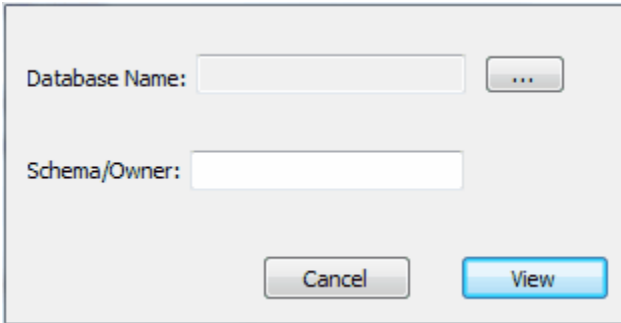

2. Click on the [ ... ] button and locate the required database on the **Select Data Source** dialog.
3. For an Oracle database, if required you can also specify the Owner in the **Schema/Owner** field.
4. Click on the **View** button to perform the comparison. The **Comparison Database** dialog displays with the results of the comparison. Click on each table name to review information on that table.

Type	Name	Owner	Status	Suggest Action
Table	OrderStatus		!=	CREATE TABLE OrderStatus(closed Integer NULL, orderSt..
Table	Order		!=	CREATE TABLE Order(date DATE NOT NULL, lineItemID In..
Table	LineItem		!=	CREATE TABLE LineItem(lineItemID Integer NOT NULL, qu..
Table	Account		!=	CREATE TABLE Account(accountID Integer NOT NULL, na..
Table	usystables		!=	DROP TABLE usystables
Table	usysqueries		!=	DROP TABLE usysqueries
Table	usysoldtables		!=	DROP TABLE usysoldtables
Table	usys_system		!=	DROP TABLE usys_system

Compare Current Item Columns

ODBC

Status	Item	Datatype	Nullable	Default
There are no items to show in this view.				

GenDDL

Status	Item	Datatype	Nullable	Default
!=	deliveryAd...	VARCHAR2 (50)	NULL	
!=	closed	Boolean	NULL	
!=	emailAddress	NVARCHAR2 (...)	NULL	
!=	billingAddr...	VARCHAR2 (50)	NULL	
!=	shoppingB...	Integer	NULL	
!=	orderID	Integer	NULL	
!=	name	VARCHAR2 (50)	NULL	
!=	PK accountID	Integer	NOT NULL	



## 7.4 XML Engineering



This section explains how to import:

- [XSD](#)<sup>[1373]</sup>
- [WSDL](#)<sup>[1376]</sup>

and how to generate:

- [XSD](#)<sup>[1376]</sup>
- [WSDL](#)<sup>[1379]</sup>

It also describes how to generate and export *Meta-Object Facility* ([MOF](#)<sup>[1380]</sup>) models.

### 7.4.1 Import XSD

The **XML Schema Import** facility is used to reverse engineer a W3C XML Schema (XSD) file as a UML Class model. An XSD file is imported into Enterprise Architect as a UML package. To import an XSD file, follow the steps below:

1. In the **Project Browser**, right-click on the package to contain the imported XSD package. The context menu displays.
2. Select the **Code Engineering | Import XML Schema** menu option. The **Import XML Schema** dialog displays.

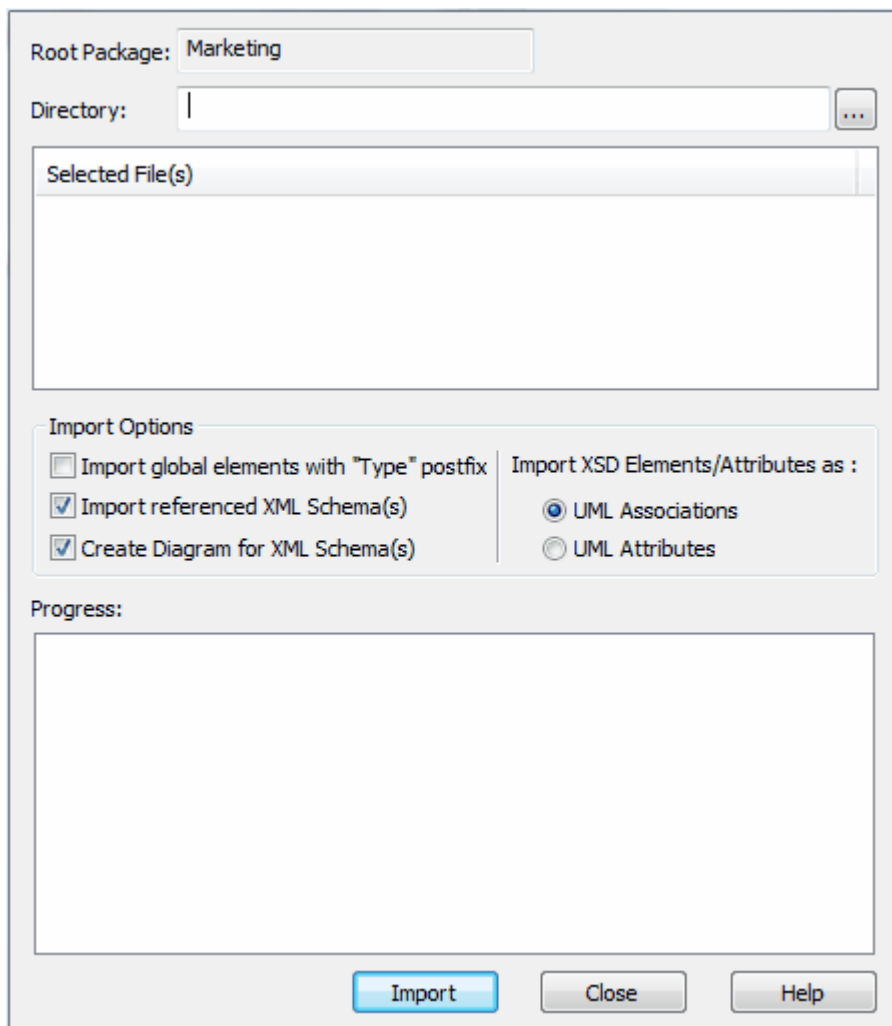

3. In the **Directory** field, click on the [ ... ] (Browse) button. The **Select XML Schema(s)** dialog displays.
4. Click on the required input file. To select several individual files, press **[Ctrl]** as you click on each one. To select a range of files, press **[Shift]** and click on the first and last file in the range.
5. Click on the **Open** button to return to the **Import XML Schema** dialog, which now shows the selected files in the **Selected File(s)** field.
6. The **Import global elements with "Type" postfix** <sup>[1375]</sup> checkbox defaults to unselected to import a global element, and the *ComplexType* to which it refers, as a single *ComplexType Class*.
7. The **Import referenced XML Schema(s)** checkbox defaults to selected, to import any other Schema file referenced by the selected input XML Schema file or files.

**Note:**

If an XML Schema file being imported already exists in the model, Enterprise Architect skips importing the file.

8. The **Create Diagram for XML Schema(s)** checkbox defaults to selected, to display the imported elements on the diagram. If necessary, deselect the checkbox.
9. For the **Import XSD Elements/Attributes as:** field, select the appropriate radio button to import elements and attributes in the XML Schema as:
  - UML Association connectors or
  - UML Class attributes.
10. Click on the **Import** button to import the schema.
11. The progress of the schema import is shown in the **Progress** status bar.

**Tip:**

The **Import XML Schema** dialog can also be accessed for the active diagram by selecting the **Project | XML Schema | Import XML Schema** menu option.

**Note:**

Enterprise Architect uses the *schemaLocation* attribute in the Import and Include elements of an XML Schema to determine the dependencies between the files. Ensure that this attribute is set to a valid file path (and not a URL) for the dependent XML Schema(s) to be imported correctly.

### 7.4.1.1 Global Element and ComplexType

Some XML Schemas have *ComplexType* elements with the same name as the referring global elements, but with the suffix *Type* as shown below:

```
<xs:element name="Address" type="AddressType"/>
<xs:complexType name="AddressType">
  <xs:sequence/>
</xs:complexType>
```

On XSD import, Enterprise Architect treats this global element and its bounding *ComplexType* as a single entity and creates a single *XSDcomplexType* stereotyped Class with the same name as the global element as shown below:

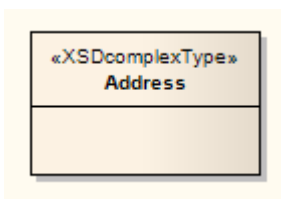

You can change this default behaviour by selecting the **Import global elements with "Type" postfix** checkbox. When you select this option, Enterprise Architect treats the global element and the *ComplexType* it is referring to as two separate entities. So, for the above example, Enterprise Architect creates an *XSDtopLevelElement* stereotyped Class for the global element and an *XSDcomplexType* stereotyped Class for the *ComplexType*, and connects them as follows:

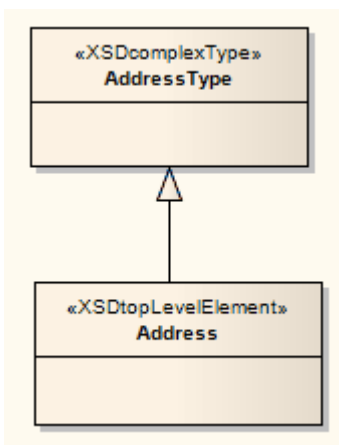
**Note:**

Enterprise Architect treats the following as two separate entities irrespective of whether the **Import global elements with "Type" postfix** checkbox is selected or unselected:

```
<xs:element name="HomeAddress" type="AddressType"/>
<xs:complexType name="AddressType">
  <xs:sequence/>
</xs:complexType>
```

## 7.4.2 Import WSDL

The *WSDL Import* facility is used to reverse engineer WSDL files into UML Class models.

### Note:

Enterprise Architect cannot import a WSDL file that references WSDL constructs existing outside the target file. For example, Enterprise Architect can import a WSDL as shown in [http://www.w3.org/TR/wsd.html#\\_example1](http://www.w3.org/TR/wsd.html#_example1) but not a file as shown in [http://www.w3.org/TR/wsd.html#\\_style](http://www.w3.org/TR/wsd.html#_style). Attempting to import the second WSDL file would result in the following error message:

*Cannot Import Split Files.*

To avoid this limitation, combine the split WSDL files into a single file and then import it into Enterprise Architect.

To import a WSDL file, follow the steps below:

1. In the **Project Browser**, right-click on the package to contain the imported WSDL package. The context menu displays.
2. Select the **Code Engineering | Import WSDL** menu option. The **Import WSDL** dialog displays.

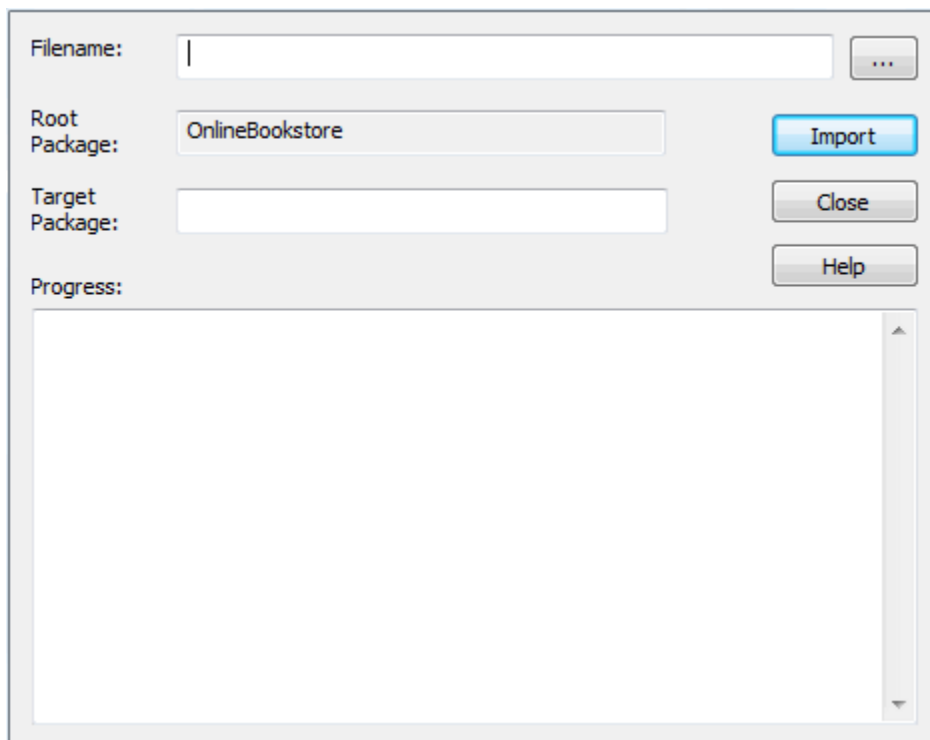

3. In the **Filename** field, select the input file.
4. The **Target Package** field is automatically set to the name of the selected input file. If required, change this name.
5. Click on the **Import** button to import the schema.
6. The progress of the WSDL import is shown in the **Progress** status bar.

## 7.4.3 Generate XSD

The *Generate XML Schema* feature forward engineers a UML Class model to a W3C XML Schema (XSD) file. An XML schema corresponds to a UML package in Enterprise Architect, therefore XML schema generation is a package-level operation. To generate an XML schema from a package, follow the steps below:

1. In the **Project Browser**, right-click on the package to be converted to XSD. The context menu displays.
2. Select the **Code Engineering | Generate XML Schema** menu option. The **Generate XML Schema** dialog displays, showing the name of the selected package in the **Source Package** field.

Source Package: ClassLibrary2

Encoding: ISO-8859-1

**XSD Style**

- Generate global element for all global ComplexTypes

**Referenced Package Options**

- Generate XSD for Referenced packages
- Prompt when missing Filename

**Child Package Options**

- Generate XSD for Child packages
- Include all packages
- Include <XSDschema> packages

Package	Filename
<input checked="" type="checkbox"/> ClassLibrary2	ClasslibSchema.xsd

Progress: View Schema Generate Close Help

3. In the **Encoding** field, set the required XML encoding.
4. In the **XSD Style** panel, the **Generate global element for all global ComplexTypes** checkbox is selected by default to generate schema in the [Garden of Eden style](#)<sup>[1378]</sup>.
5. In the **Referenced Package Options** panel, select the:
  - **Generate XSD for Referenced packages** checkbox to generate schema for packages that are referenced by any of the packages selected in the list box
  - **Prompt when missing Filename** checkbox to enable Enterprise Architect to prompt for a filename for a referenced package during schema generation, if the filename is missing.
6. In the **Child Package Options** panel, select the:
  - **Generate XSD for Child Packages** checkbox to generate schema for child packages of the selected package
  - **Include all packages** radio button to list all child packages under the parent package in the list box
  - **Include <XSDschema> packages** radio button to list only those packages that have the stereotype «XSDschema».

The list box displays, for each package, the package name and the file path where the schema file is to be generated.
7. If it is necessary to change the file path for a package, double-click on the entry in the list box and, on the **Select XML File** dialog, type or select the appropriate file path.

8. Ensure that the checkbox is selected for each package required for generation.
9. Click on the **Generate** button to generate the schema for each of the selected packages.
10. The progress of the schema generator is shown in the **Progress** box.
11. When schema generation is complete, click on an entry in the list box and click on the **View Schema** button to review the generated schema.

**Tip:**

The **Generate XML Schema** dialog can also be accessed from the active diagram by selecting the **Project | XML Schema | Generate XML Schema** menu option.

### 7.4.3.1 Generate Global Element

Enterprise Architect, by default, generates XML Schema in the *Garden of Eden* style. For every global *XSDcomplexType* stereotyped Class, Enterprise Architect generates a global element. For example, the following model by default generates the XSD shown:

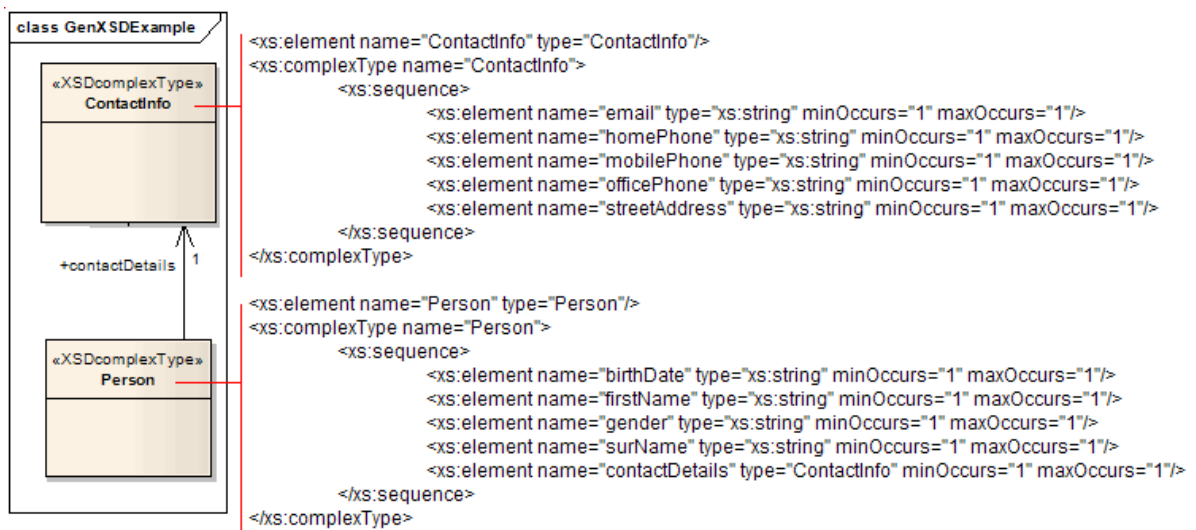

You can change this default behaviour by deselecting the **Generate global element for all global ComplexTypes** checkbox on the [Generate XML Schema](#) <sup>[1378]</sup> dialog. Then, the generated XSD no longer contains the global element, as shown below:

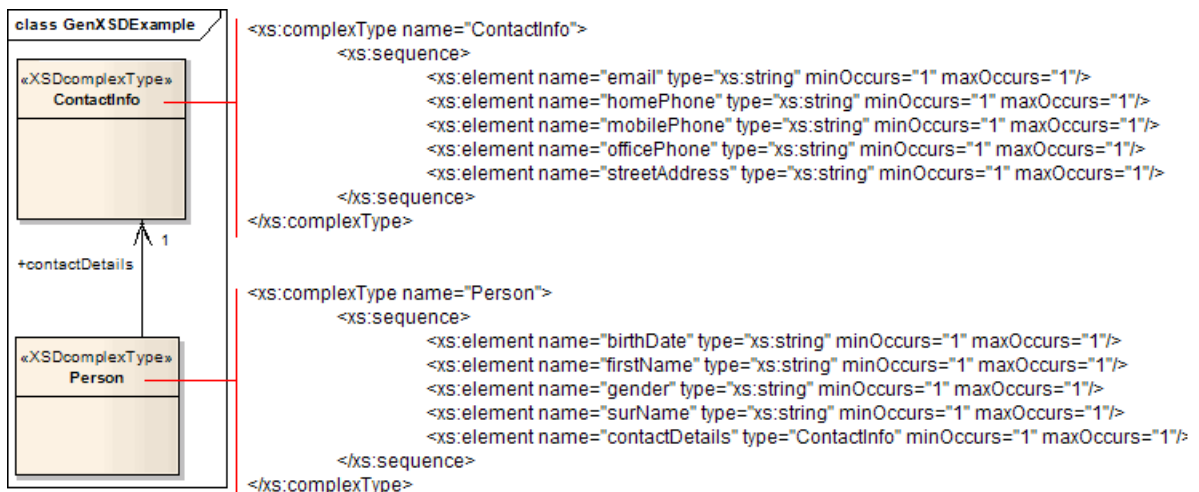

### 7.4.4 Generate WSDL

The *Generate WSDL* feature forward engineers a UML model to a Web Service Definition Language (WSDL) file. The Generate WSDL feature acts on a package stereotyped with *WSDLnamespace*. It is used to generate any or all of the WSDL stereotyped components owned by the target *WSDLnamespace* structure. To generate one or more WSDL files from a *WSDLnamespace*, follow the steps below:

1. In the **Project Browser**, right-click on the target *WSDLnamespace* package to display the context menu.
2. Select the **Code Engineering | Generate WSDL** menu option. The **Generate WSDL** dialog displays.

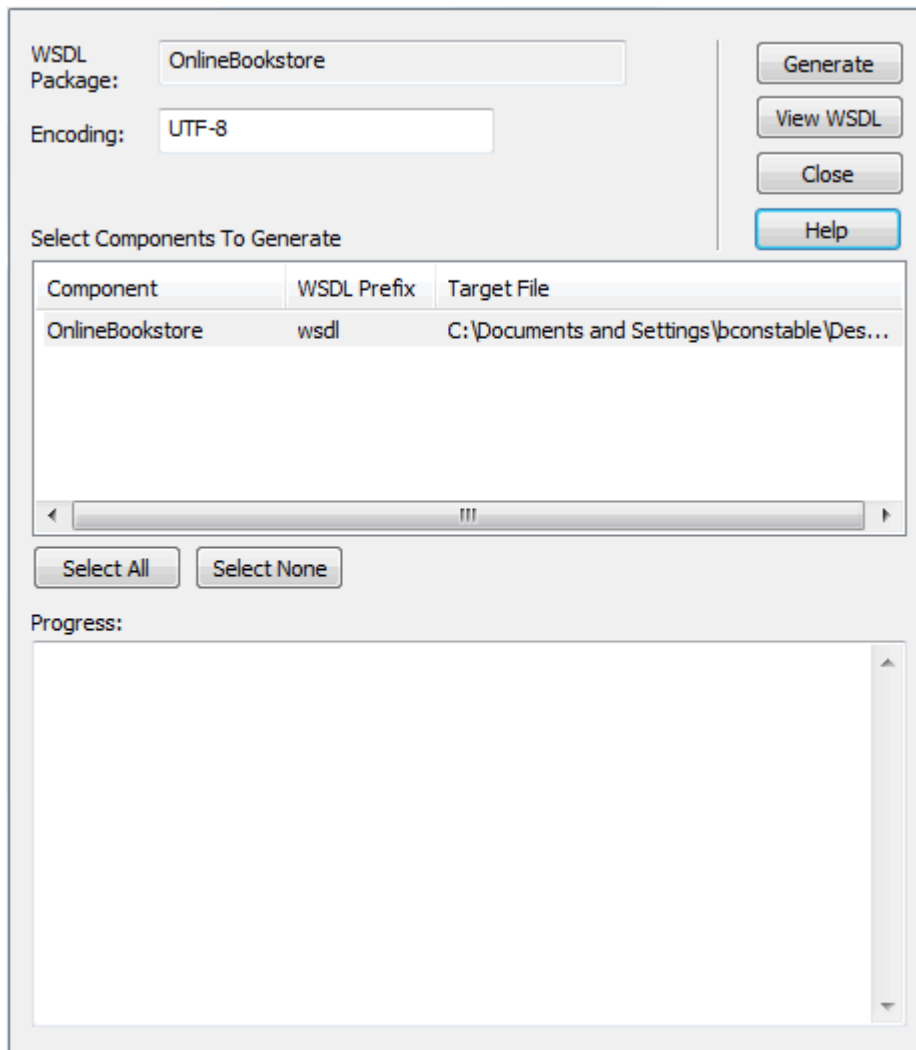

3. For each WSDL component, set the required output file using the **Target File** column.
4. Using the **Encoding** field, set the required XML encoding.
5. Click on the **Generate** button to generate the WSDL files.
6. The progress of the WSDL generator is shown in the **Progress** edit box.

**Tip:**

The **Generate WSDL** dialog can also be accessed from the active diagram by selecting the **Project | Generate WSDL** menu option.

### 7.4.5 Generate MOF

Enterprise Architect offers support for exporting packages to XMI under the *Meta-Object Facility (MOF)* 1.3 and 1.4 standards. MOF models are created by assigning the stereotype *metamodel* to the package. MOF models can be exported to MOF 1.3 or MOF 1.4 XMI file specification.

#### Background Knowledge

MOF is an Object Management Group (OMG) standard that originated in the UML, when the OMG required a Meta-Modeling architecture to define the UML. MOF is designed as a four-layered architecture, as illustrated in the following diagram.

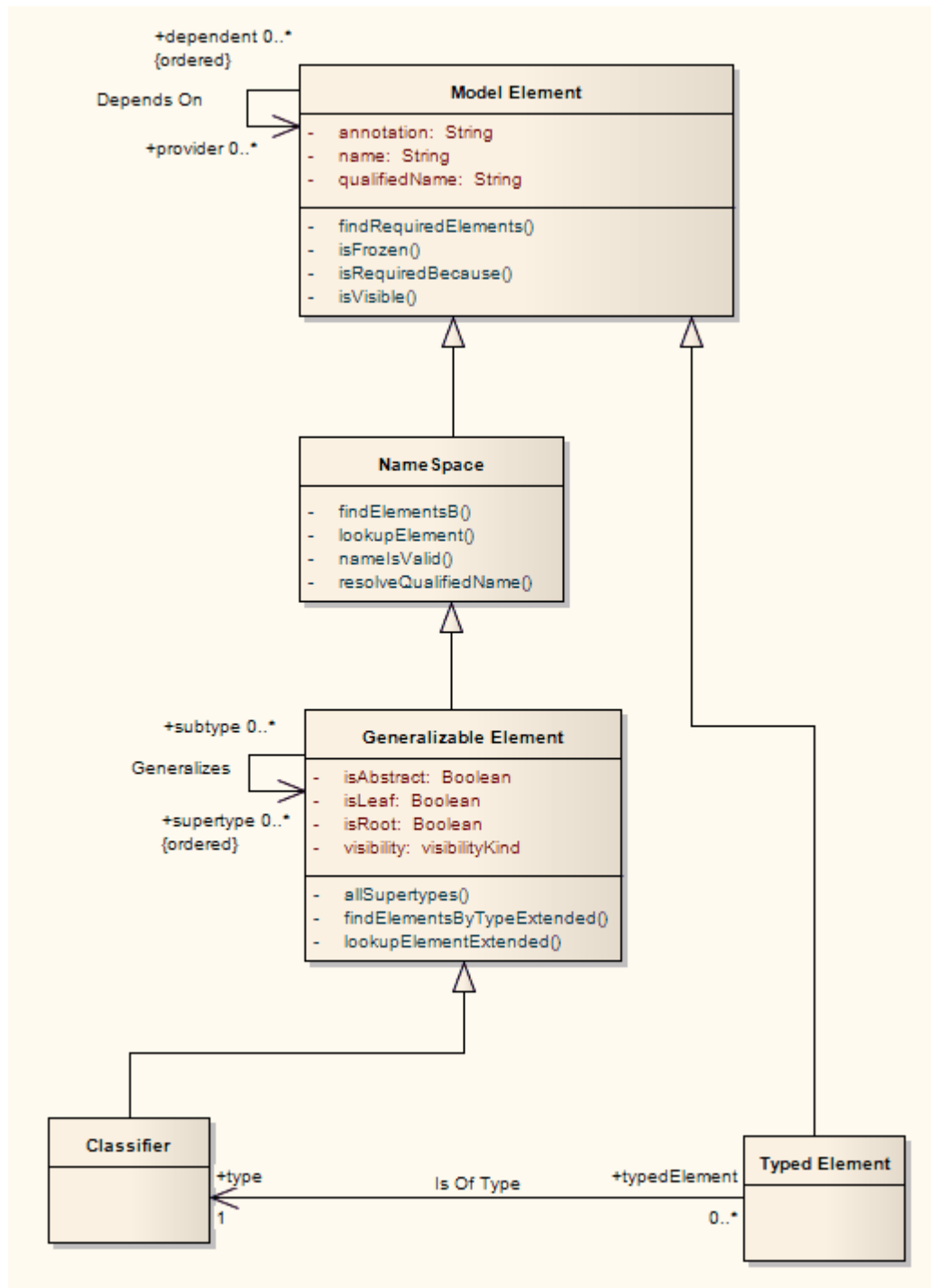



Because of the similarities between the MOF-model and UML structure models, MOF meta-models are usually modeled as UML [Class diagrams](#)<sup>[72]</sup>. You can also use the [Metamodel](#)<sup>[415]</sup> page of the [Toolbox](#) to create MOF model elements and connectors. A supporting standard of MOF is XMI, which defines an XML-based exchange format.

MOF is a closed, strict meta-modeling architecture; every model element on every layer is strictly an instance of a model element of the layer above. MOF only provides a means to define the structure or abstract syntax of a language or of data.

Simplified, MOF uses the notion of Classes, as known from object orientation, to define concepts (model elements) on a meta-layer. These Classes (concepts) can then be instantiated through objects (instances) of the model layer below. Because an element on the M2 layer is an object (instance of an M3 model element) as well as a Class (an M2 layer concept) the notion of a *clabject* is used. *Clabject* is a merge of the words *Class* and *object*.

Another related standard is OCL, which describes a formal language that can be used to define model constraints by means of predicate logic.

#### See Also

- [Getting Started](#)<sup>[138]</sup>
- [Export MOF to XMI](#)<sup>[138]</sup>

### **7.4.5.1 Getting Started**

MOF diagrams are [Class](#)<sup>[72]</sup> diagrams that are contained in packages with a metamodel stereotype. To create a MOF diagram, follow the steps below.

1. Create a package to contain your MOF elements.
2. Double-click on the package name to display the [Properties](#) dialog.

The screenshot shows a dialog box with the following fields and values:

- Name:** PackageMOF
- Stereotype:** metamodel (with an 'Abstract' checkbox that is unchecked)
- Author:** Frederick Walter
- Status:** Proposed
- Scope:** Public
- Complexity:** Easy
- Language:** C#
- Keywords:** (empty)
- Phase:** 1.0
- Version:** 1.0
- Notes:** (empty text area with a rich text editor toolbar)

At the bottom of the dialog are buttons for **OK**, **Cancel**, **Apply**, and **Help**.

3. In the **Stereotype** field type the value **metamodel**.
4. Click on the **OK** button.
5. Right-click on the package in the **Project Browser** and select the **Add | Add Diagram** context menu option. Create a Class diagram (the default diagram).
6. Give your MOF Class diagram an appropriate name.
7. In the **Toolbox**, select the **More tools | Metamodel** menu option and add the required [Metamodel](#)<sup>[415]</sup> elements to the diagram.

The following is an example of a MOF diagram. A MOF diagram can typically contain Package, Class, Enumeration and Primitive elements, and Generalization, Association, Compose and Aggregate relationships.

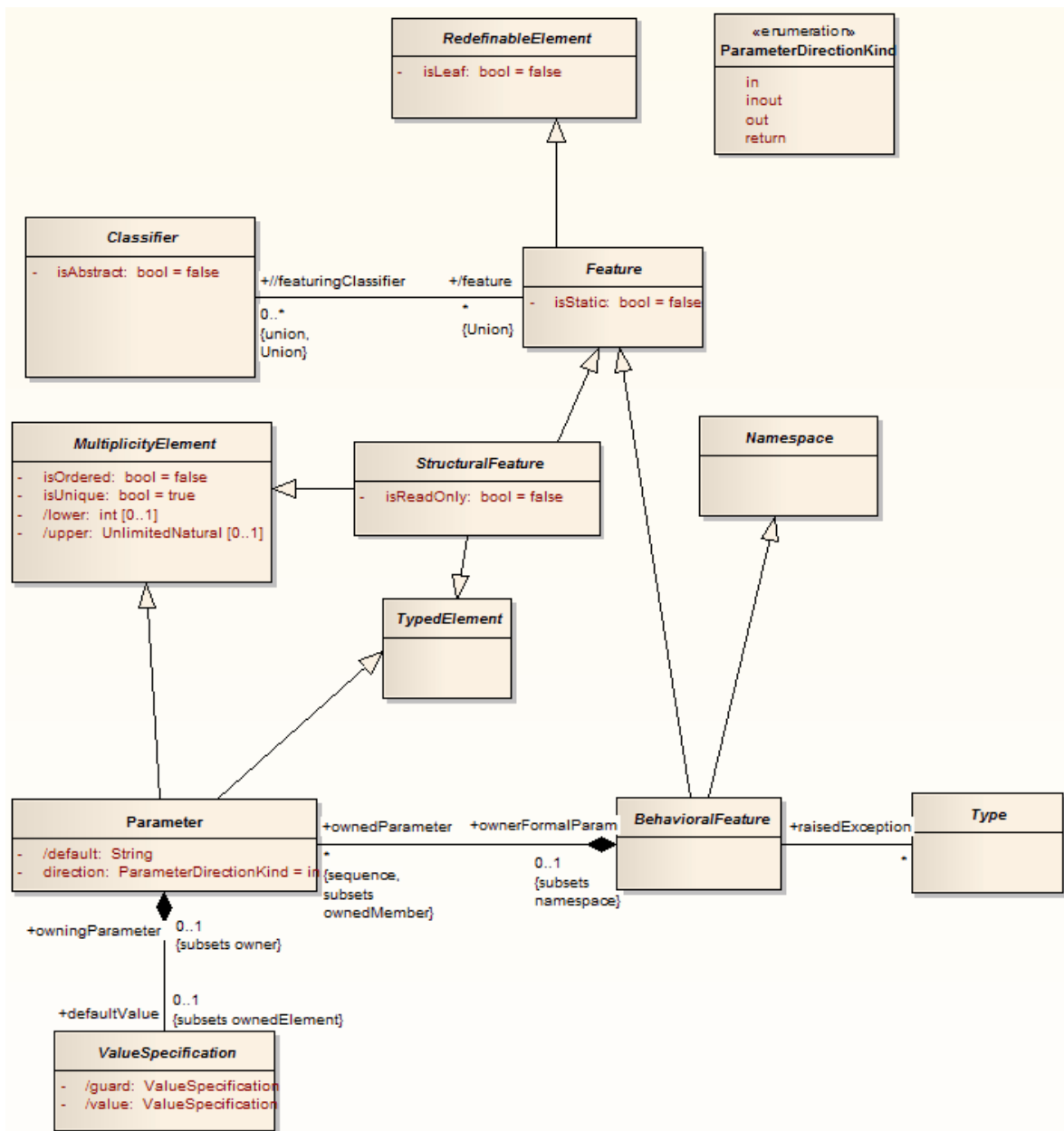

### 7.4.5.2 Export MOF to XMI

Once you have created your MOF diagram you can export the diagram to XMI, specifying the MOF 1.3 or MOF 1.4 standard.

1. Right-click on the package in the **Project Browser**. The context menu displays.
2. Select the **Import/Export | Export Package to XMI file** menu option. The **Export Package to XMI** dialog displays:

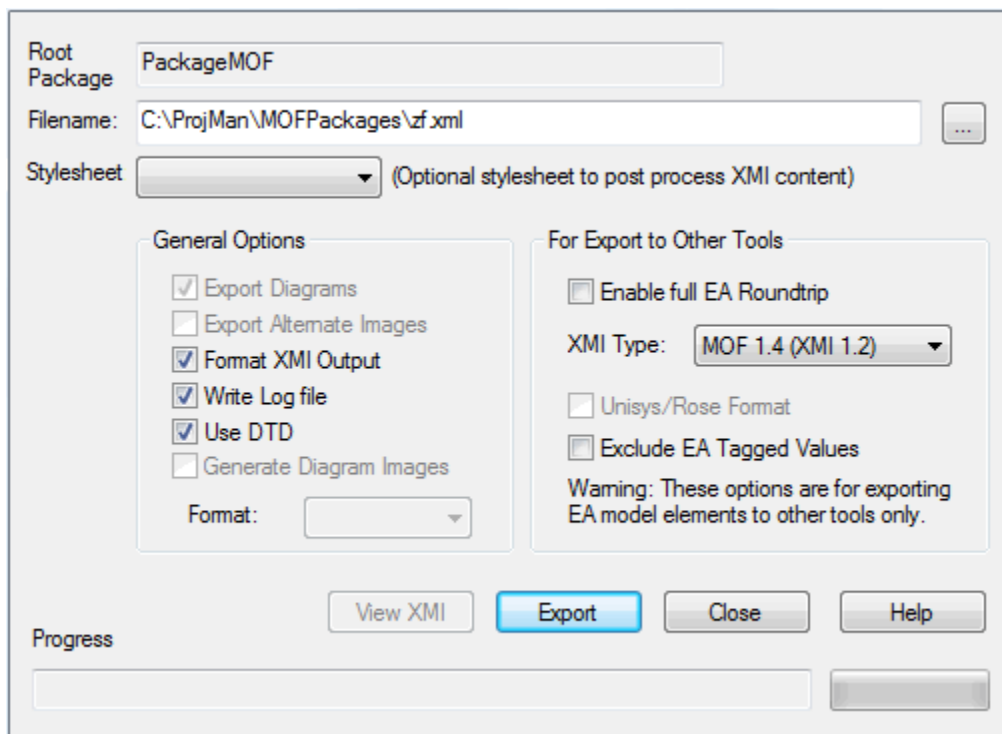

3. In the **Filename** field, type a name for the XMI file.
4. De-select the **Enable full EA Roundtrip** checkbox.
5. In the **XMI Type** field, click on the drop-down arrow and select **MOF 1.3** or **MOF 1.4**.
6. Click on the **Export** button and wait until the **Progress** bar reads **100%**.
7. Once your file has been created, you can view it by clicking on the **View XMI** button.

MOF diagrams exported to XMI can be imported using the regular import XMI features of Enterprise Architect. See [Import from XMI](#) <sup>[290]</sup>.

## 7.5 Model Transformations - MDA

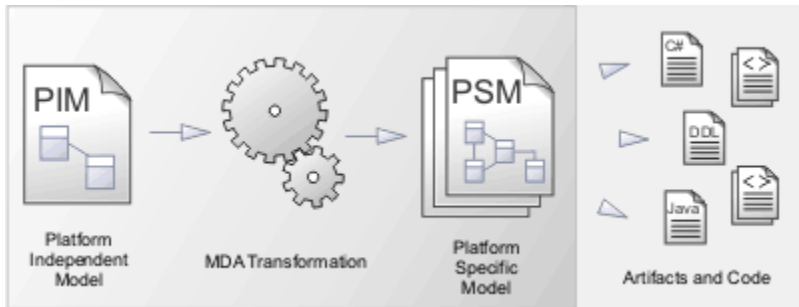

Model Driven Architecture (MDA) Transformations provide a fully configurable way of converting model elements and model fragments from one domain to another. This typically involves converting Platform-Independent Model (PIM) elements to Platform-Specific Model (PSM) elements. A single element from the PIM can be responsible for creating multiple PSM elements across multiple domains.

Transformations are a huge productivity boost, and reduce the necessity of manually implementing stock Classes and elements for a particular implementation domain: for example, database tables generated from persistent PIM Classes. Enterprise Architect includes some basic built-in Transformations, such as PIM to Data Model, PIM to C#, PIM to Java and PIM to XSD. Sparx Systems will make further Transformations available over time, either as built in Transformations or as downloadable modules from the Sparx Systems website.

For a further productivity boost, Enterprise Architect can automatically generate code for your transformed Classes that target code languages. See the [Generate Code on result](#) <sup>[1388]</sup> option on the **Model Transformation** dialog.

A Transformation is defined using Enterprise Architect's simple code generation template language, and involves no more than writing a template to create a simple intermediary source file. Enterprise Architect reads the source file and binds that to the new PSM.

Enterprise Architect also creates internal bindings (*Transformation Dependencies*) between each PSM created and the original PIM. This is essential, as it enables you to forward synchronize from the PIM to the PSM many times, adding or deleting features as you go. For example, adding a new attribute to a PIM Class can be forward synchronized to a new column in the Data Model. You can observe the Transformation Dependencies for a package using the **Traceability** window. This enables you to check the impact of changes to a PIM element on the corresponding elements in each generated PSM, or to verify where a change required in a PSM should be initiated in the PIM (and also to reflect back in other PSMs). The Transformation Dependencies are a valuable tool in managing the [traceability](#) <sup>[1245]</sup> of your models.

Enterprise Architect does not delete or overwrite any element features that were not originally generated by the transform. Therefore, you can add new methods to your elements, and Enterprise Architect does not act on them during the forward generation process.

### Note:

If you are using the Corporate, Business and Software Engineering, System Engineering or Ultimate edition, if security is enabled you must have [Transform Package](#) <sup>[198]</sup> access permission to perform an MDA Transform on a package.

The following diagram highlights how Transformations work and how they can significantly boost your productivity:

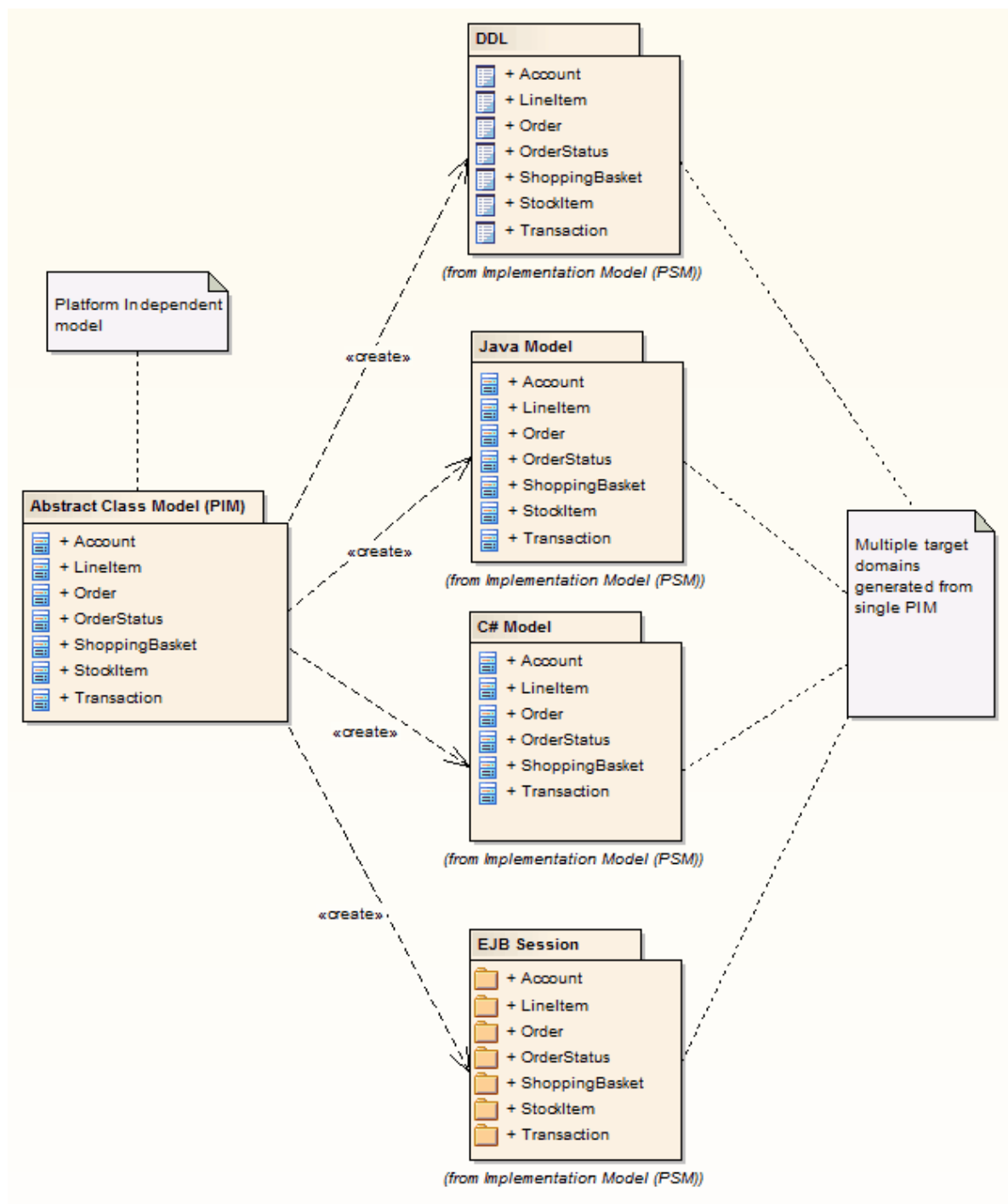

Transformations that are currently built-in include:

- **C#** - Converts a PIM to a standard C# implementation set
- **Data Model to ERD** - Transforms a Data Model to an Entity Relationship Diagram (ERD)
- **DDL** - Transforms platform-independent Class elements to platform-specific table elements
- **EJB Entity** - Transforms platform-independent Class elements to packages containing the Class and Interface elements that comprise an EJB Entity Bean
- **EJB Session** - Transforms platform-independent Class elements to packages containing the Class and Interface elements that comprise an EJB Session Bean
- **ERD to Data Model** - Transforms an Entity Relationship Diagram into a Data Model
- **Java** - Transforms platform-independent elements to Java language elements

- **JUnit** - Converts a Java model to a model where test methods are created for each public method of any original Class
- **NUnit** - Converts a .Net language specific model to a model where test methods are created for each public method of any original Class
- **WSDL** - Converts a simple representation of a WSDL interface into the elements required to generate that interface
- **XSD** - Transforms platform-independent elements to XSD elements.

Transformations are described in the following topics:

- [Transform Elements](#)<sup>[1387]</sup>
- [Import Transformations](#)<sup>[1414]</sup>
- [Transformation Templates](#)<sup>[1412]</sup>
- [Built-in Transformations](#)<sup>[1388]</sup>
- [Write Transformations](#)<sup>[1414]</sup>
- [Chaining Transformations](#)<sup>[1388]</sup>

### 7.5.1 Transform Elements

There are two modes for initiating a Model Transformation, each of which can be started in two ways.

- To transform selected elements on a diagram, either:
  - Select the **Project | Transformations | Transform Selected Elements** menu option, or
  - From the context menu for the Classes on the diagram, select the **Transform** option.
- To transform elements in the package currently selected in the **Project Browser**, either:
  - Select the **Project | Transformations | Transform Current Package** menu option, or
  - From the context menu of the package in the **Project Browser**, select the **Transform Current Package** option.

The **Model Transformation** dialog displays.

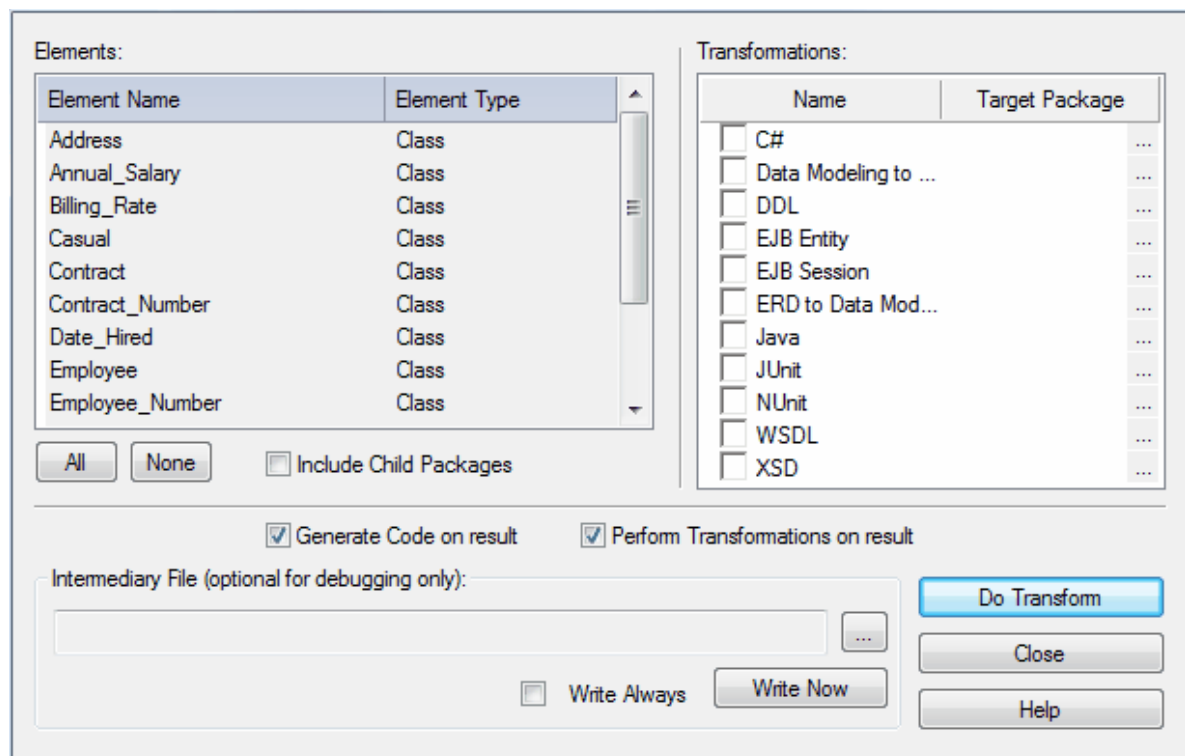

When the dialog displays, all elements are selected and all transformations previously performed from any of these Classes are checked.

Option	Use to
<b>Elements</b>	Select (click on) the individual elements to be included in the transformation.
<b>All</b>	Select all of the elements from the list to be included in the transformation.
<b>None</b>	Deselect all of the elements from the list.
<b>Include child packages</b>	Select to include elements in child packages of the selected package.
<b>Transformations</b>	Select which transformations to perform and the package each of them should be transformed to. (Use the [ ... ] button to select the package in which the transformed elements are being created.)
<b>Generate Code on result</b>	Specify whether or not to automatically generate code for transformed Classes that target code languages.  Automatically generating code helps boost productivity in development. With this option selected, the first time you transform to the selected Class Enterprise Architect enables you to select a filename to generate to. Subsequent transformations automatically generate any Class with a filename set.
<b>Perform Transformations on result</b>	Specify if transformations previously done on target Classes should be automatically executed. See <a href="#">Chaining Transformations</a> <sup>[1388]</sup> for more information.
<b>Intermediary File</b>	Specify the filename of the intermediary file (if any).
<b>Write Always</b>	Write the intermediary file to disk.
<b>Write Now</b>	Generate the intermediary file but do not perform the transform.
<b>Do Transform</b>	Execute the transform command.

### 7.5.1.1 Chaining Transformations

Chaining transformations provide an extra degree of flexibility and power to transformations. For example, you might have a situation where two transformations have a common element. This can be separated out into one transformation, and then the original transformations can be transformed from the common point. The separated transform could even produce a useful model itself.

Enterprise Architect provides for chaining transformations, by enabling transformations that have already been performed on target Classes to be performed automatically next time that Class is transformed to. To enable this, select the **Perform Transformations on result** checkbox in the **Model Transformation** dialog.

### 7.5.2 Built-in Transformations

Enterprise Architect provides a number of built-in transformation types. These transformations have been designed to be useful to as many users as possible, acting as a good base to modify to include the specifics of your custom domain, and to be good examples of how to write transformations.

The following transformations are included in Enterprise Architect.

- [C#](#)<sup>[1389]</sup>
- [DDL](#)<sup>[1393]</sup>
- [Data Model to ERD](#)<sup>[1390]</sup>
- [EJB Entity](#)<sup>[1397]</sup>
- [EJB Session](#)<sup>[1397]</sup>
- [ERD to Data Model](#)<sup>[1395]</sup>
- [Java](#)<sup>[1403]</sup>
- [JUnit](#)<sup>[1405]</sup>
- [NUnit](#)<sup>[1407]</sup>
- [WSDL](#)<sup>[1408]</sup>
- [XSD](#)<sup>[1409]</sup>



### 7.5.2.1 C# Transformation

The **C# transformation** converts Platform-Independent Model (PIM) elements to language-specific C# Class elements. The transformation converts PIM model types to C# types and creates encapsulation according to Enterprise Architect's options for creating properties from C# attributes, which you set on the [C# Specifications](#) [1350] [page](#) [1350] of the **Options** dialog.

**The Platform-Independent Model (PIM):**

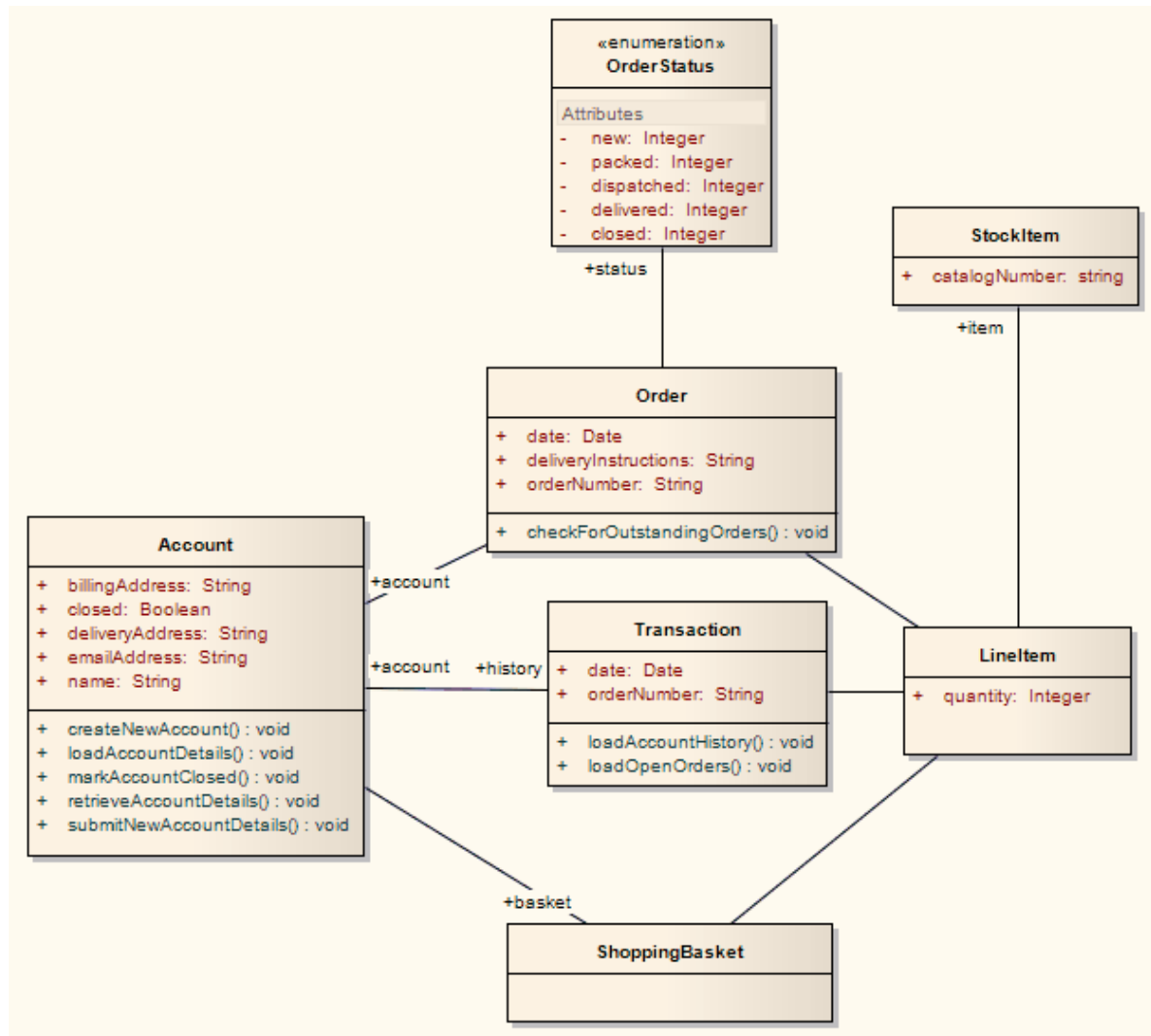

After transformation, becomes the PSM:

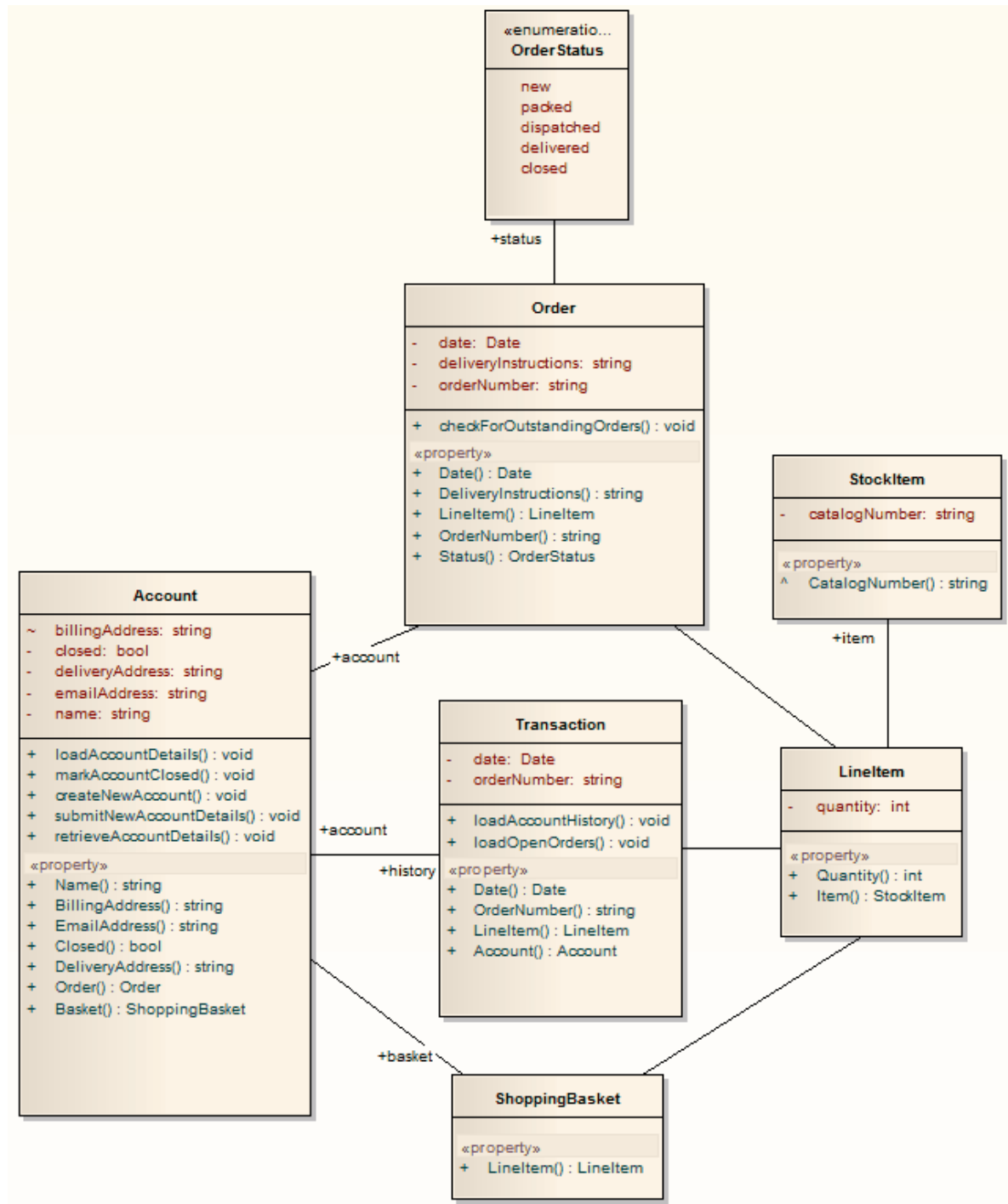

### 7.5.2.2 Data Model To ERD Transformation

The Data Model to ERD transformation is a reverse engineering of the [ERD to Data Model](#) <sup>1390</sup> transformation.

The transformation uses and demonstrates support in the intermediary language for the following database-specific concepts:

<b>Entity</b>	Mapped one-to-one onto table elements.
---------------	--

<b>Attribute</b>	Mapped one-to-one onto columns.
<b>Primary Key</b>	Comes from the PrimaryKey type of column.

The source Data Model diagram:

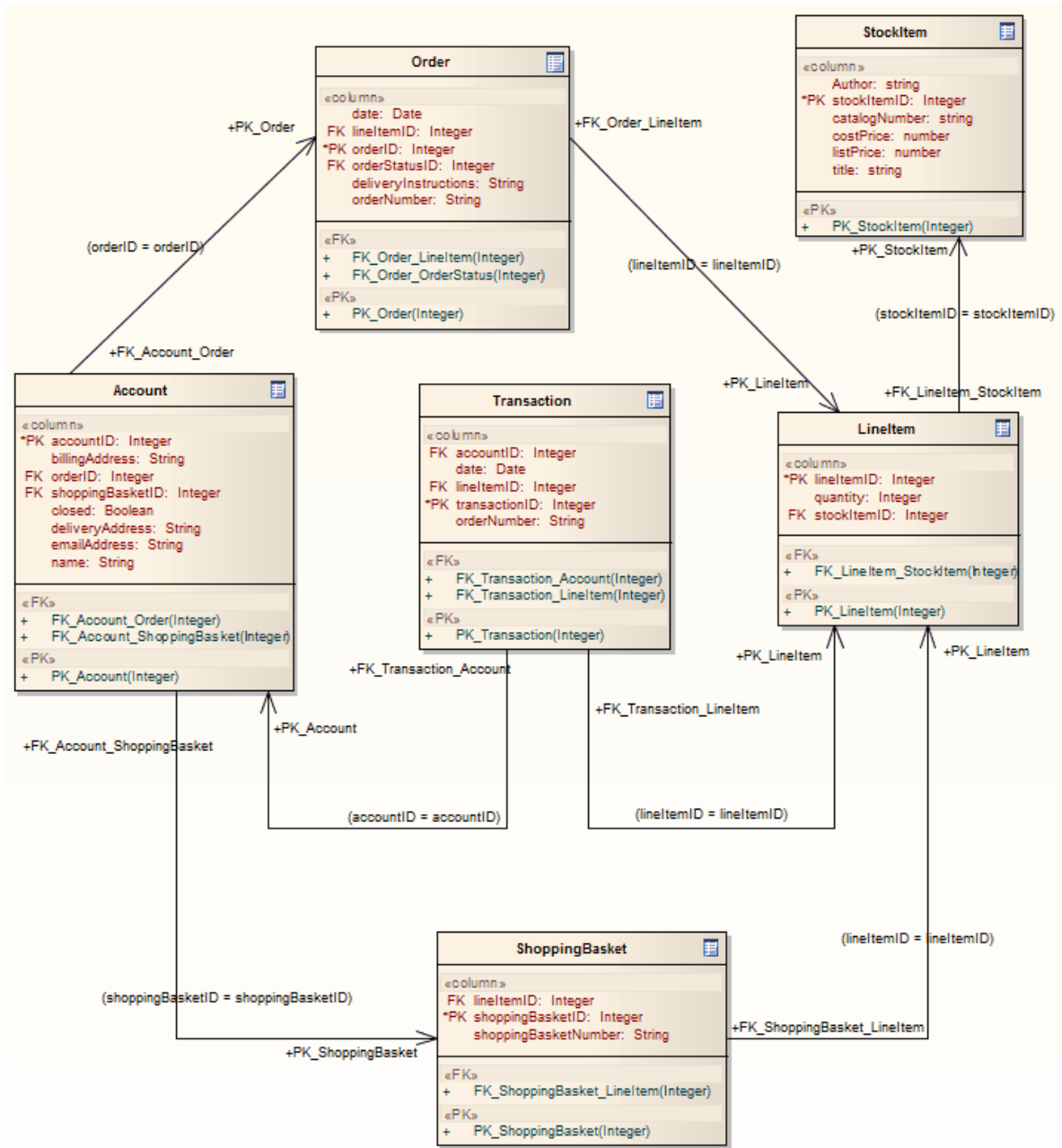

After transformation becomes the Entity Relationship Diagram:

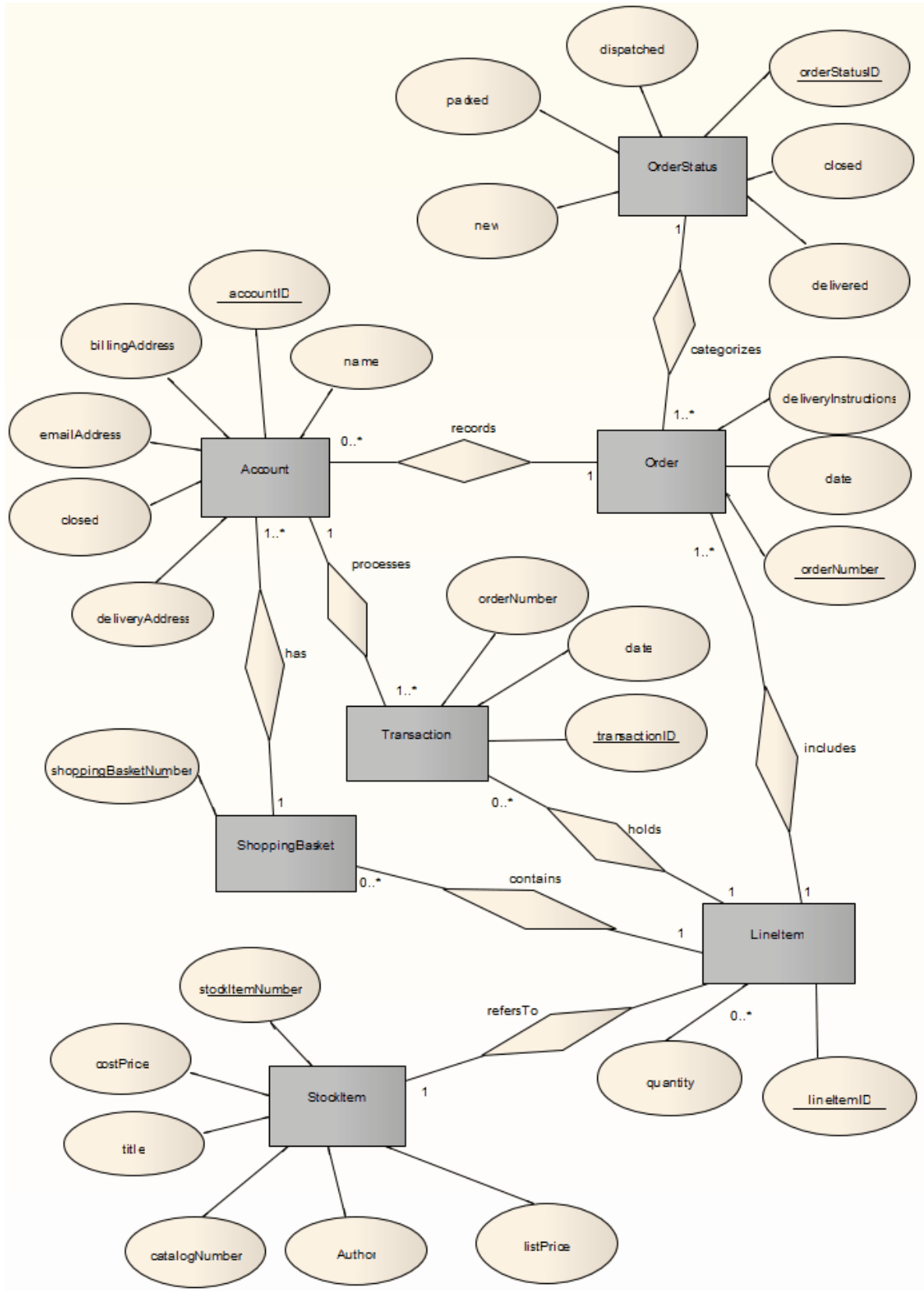

**Tip:**

Sometimes you might want to limit the stretch of the diamond-shape Relationship connectors. Simply pick a Relationship connector, right-click to display the context menu, and select the **Bend Line at Cursor** option.

### 7.5.2.3 DDL Transformation

The purpose of the **DDL transformation** is to create a data model from the logical model, generating a model targeted at the default database type that is ready for DDL generation. The data model can then be used to automatically generate DDL statements to run in one of the Enterprise Architect supported database products.

The DDL Transformation uses and demonstrates support in the [intermediary language](#) <sup>[1415]</sup> for the following database-specific concepts:

<b>Table</b>	Mapped one-to-one onto Class elements.
<b>Column</b>	Mapped one-to-one onto attributes.
<b>Primary Key</b>	Lists all the columns involved; this ensures that they exist in the Class and creates a primary key method for them.
<b>Foreign Key</b>	This is a special sort of connector. The <i>Source</i> and <i>Target</i> sections list all of the columns involved; this ensures that they exist and that a matching primary key exists in the destination Class, and that the transformation creates the appropriate foreign key.

The following two diagrams show a typical PIM to Data Model Transformation.

## The Platform-Independent Model (PIM):

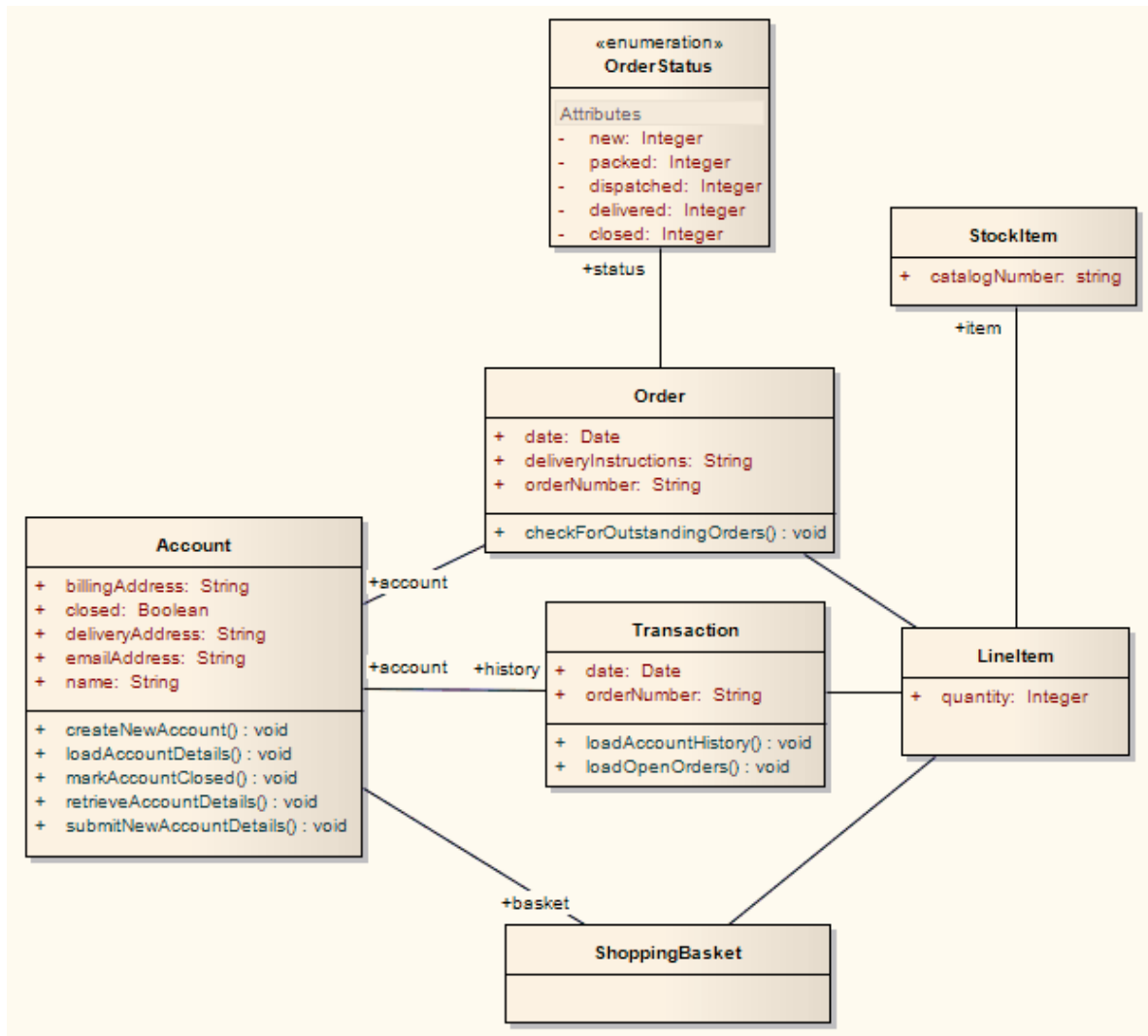

After transformation becomes the PSM:

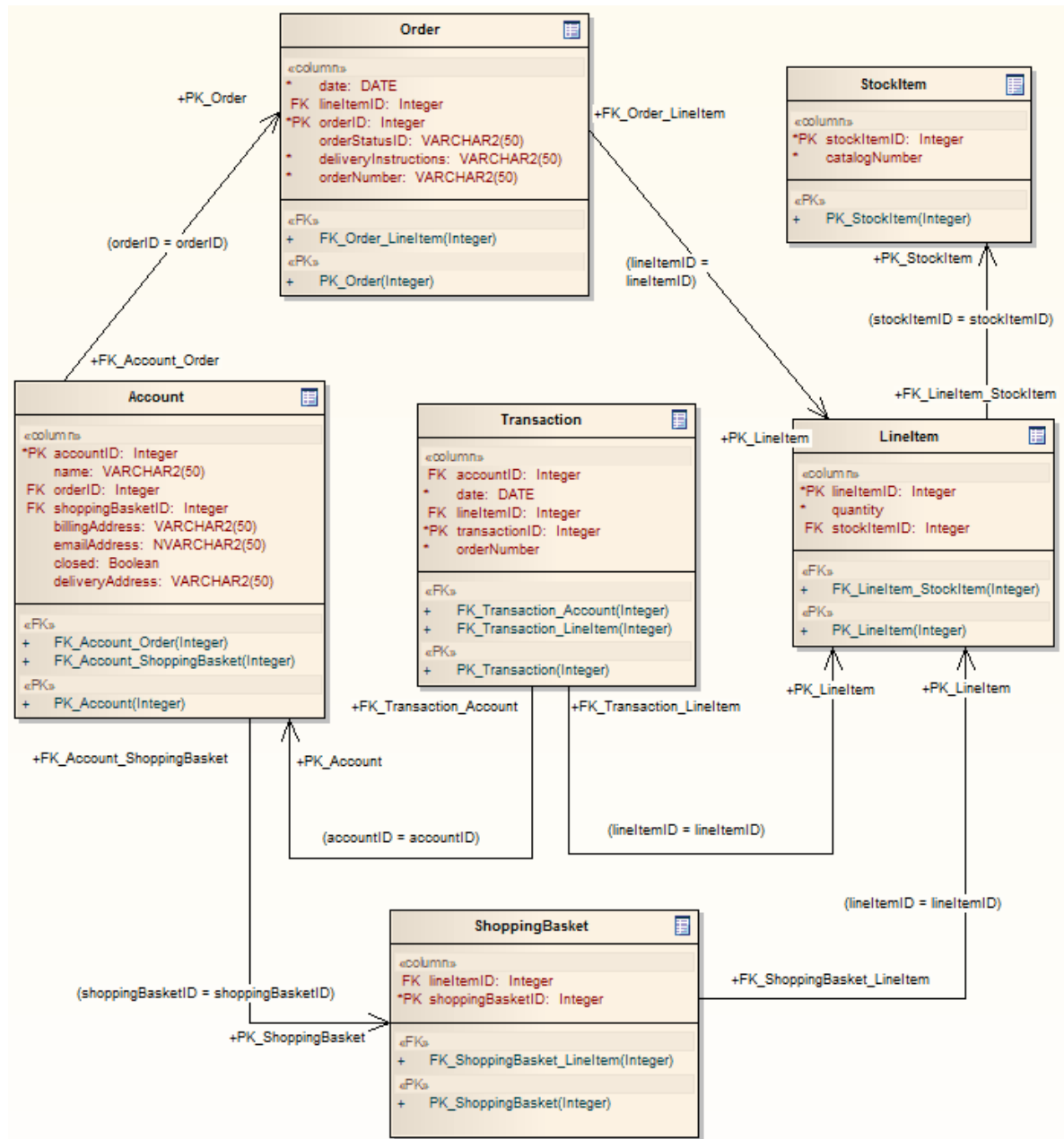

Generalizations are handled by providing the child element with a foreign key to the parent element, as in the following diagram. Copy-down inheritance is not supported.

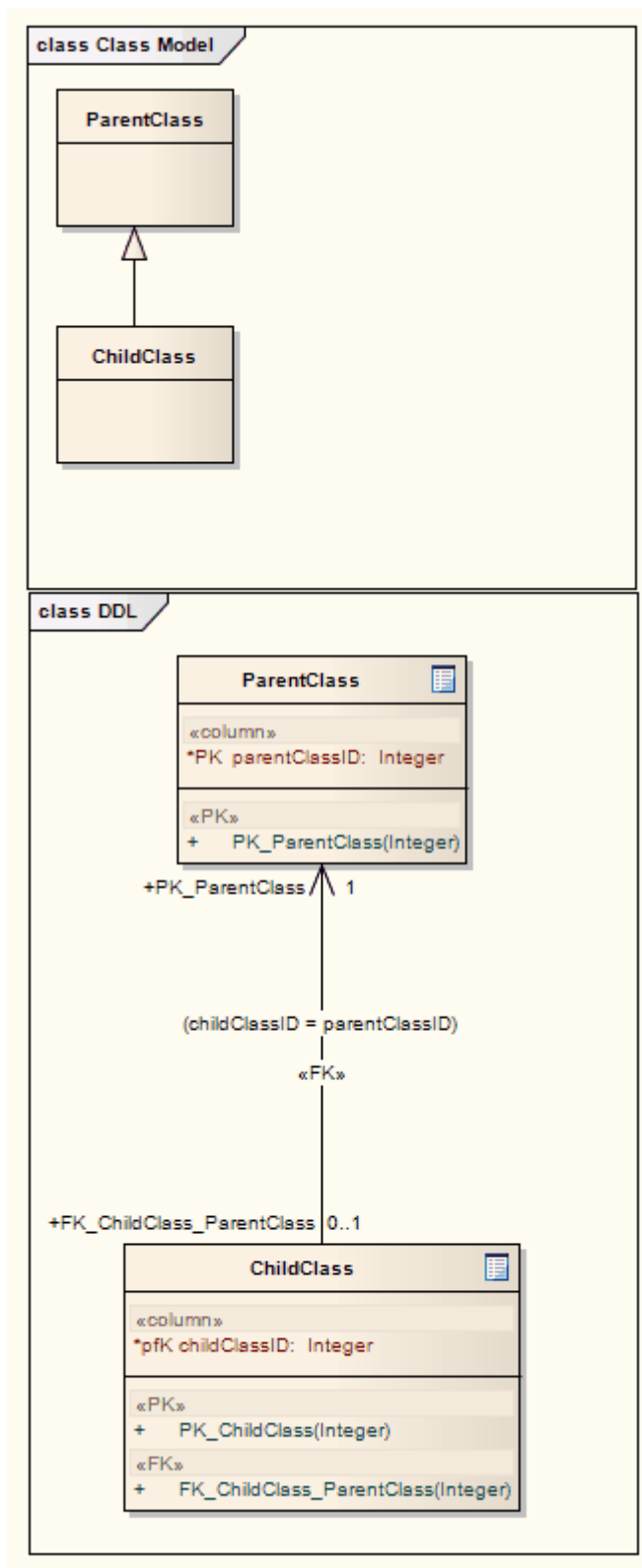



### 7.5.2.4 EJB Transformations

The purpose of the **EJB Session Bean transformation** and the **EJB Entity Bean transformation** is to reduce the work required in generating the internals of Enterprise Java Beans, thus enabling you to concentrate on modeling at a higher level of abstraction.

The **EJB Session Bean transformation** generates the following from a single Class element containing the attributes, operations and references required for code generation by the *javax.ejb.\** package:

- An implementation Class element
- A home interface element
- A remote interface element.

The **EJB Entity Bean transformation** generates the following from a single Class element containing the attributes, operations and references required for code generation by the *javax.ejb.\** package:

- An implementation Class element
- A home interface element
- A remote interface element
- A primary key element.

Both transformations also generate a META-INF package containing a deployment descriptor element.

#### The Platform-Independent Model (PIM):

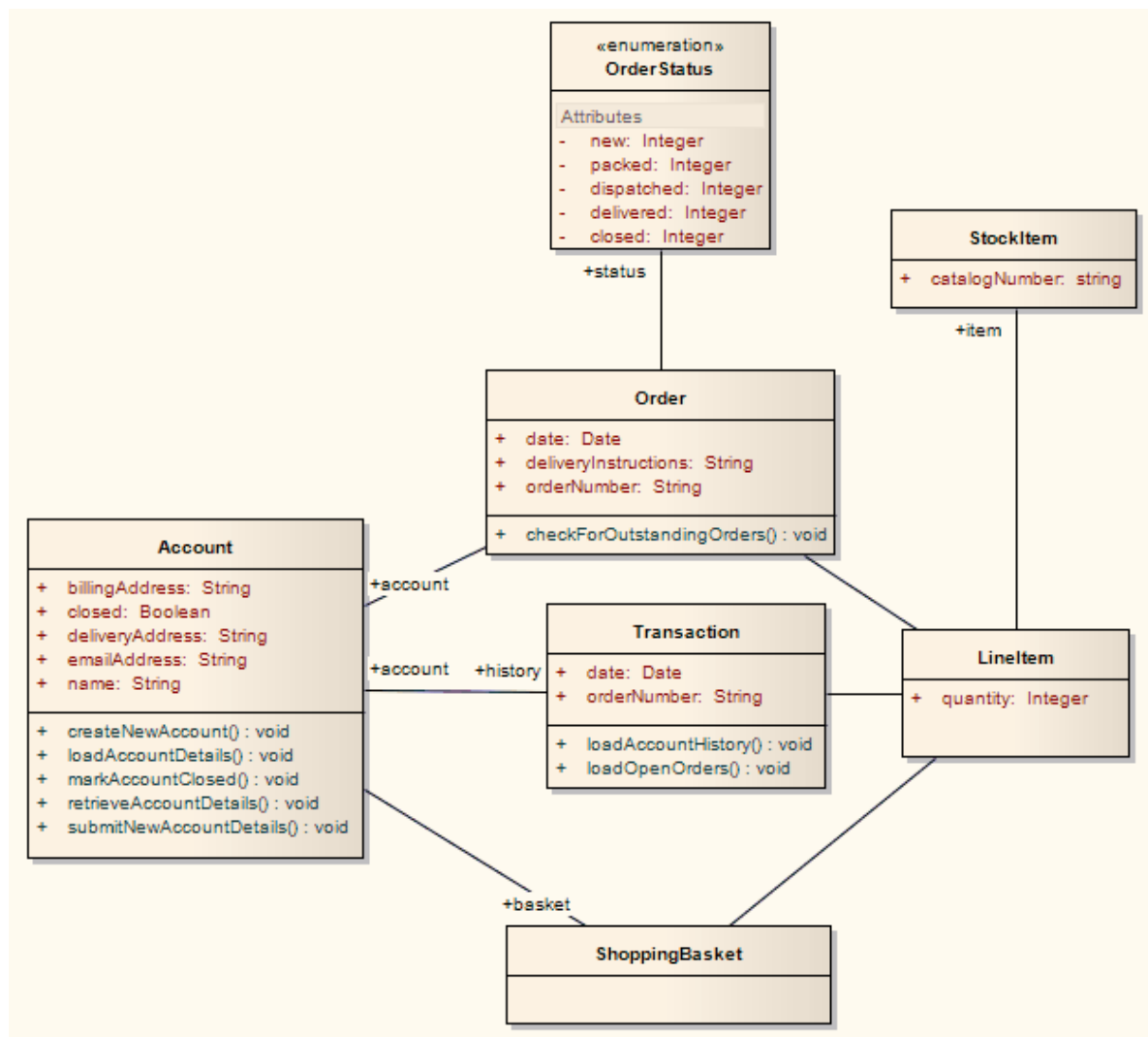

After transformation generates a set of Entity Beans, where each one takes the following form (for the

## Account Class:

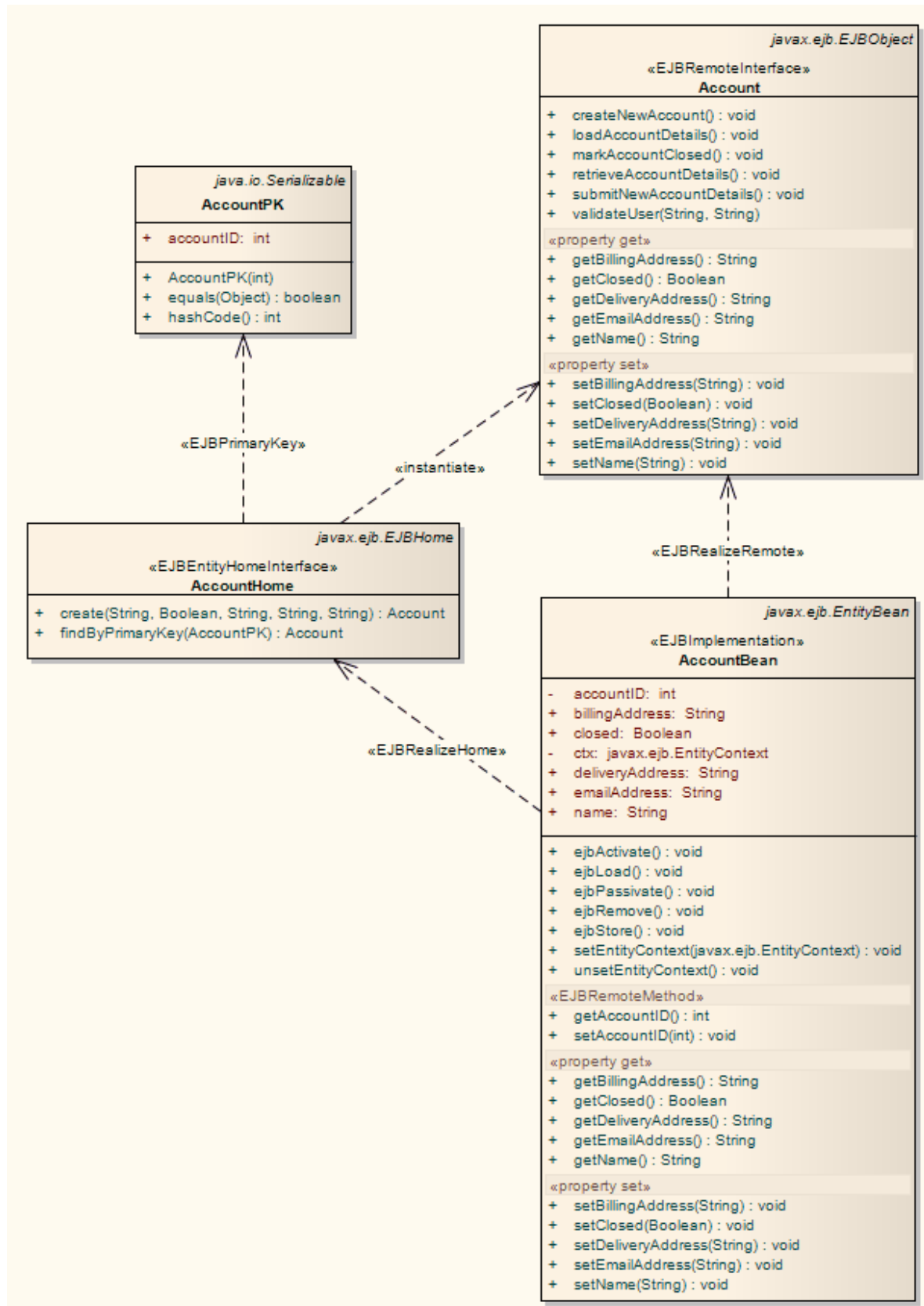

### 7.5.2.5 ERD To Data Model Transformation

The purpose of the **Entity Relationship Diagram (ERD) to Data Model transformation** is to create a data model from the ERD logical model, generating a model targeted at the default database type ready for DDL generation. Before doing the transformation, make sure you have defined the common data type for each attribute and selected a database type as the default database. The data modeling diagram can then be automatically generated. This data model can be used for generating DDL statements to run in one of the Enterprise Architect supported database products.

The transformation uses and demonstrates support in the intermediary language for the following database-specific concepts:

<b>Table</b>	Mapped one-to-one onto Entity elements.
<b>Column</b>	Mapped one-to-one onto attributes.
<b>Primary Key</b>	Comes from the <i>primaryKey</i> type of attribute.
<b>Foreign Key</b>	Make sure the primary key exists in the source Entity; the transformation then creates the appropriate foreign key.

The Source Entity Relationship Diagram:

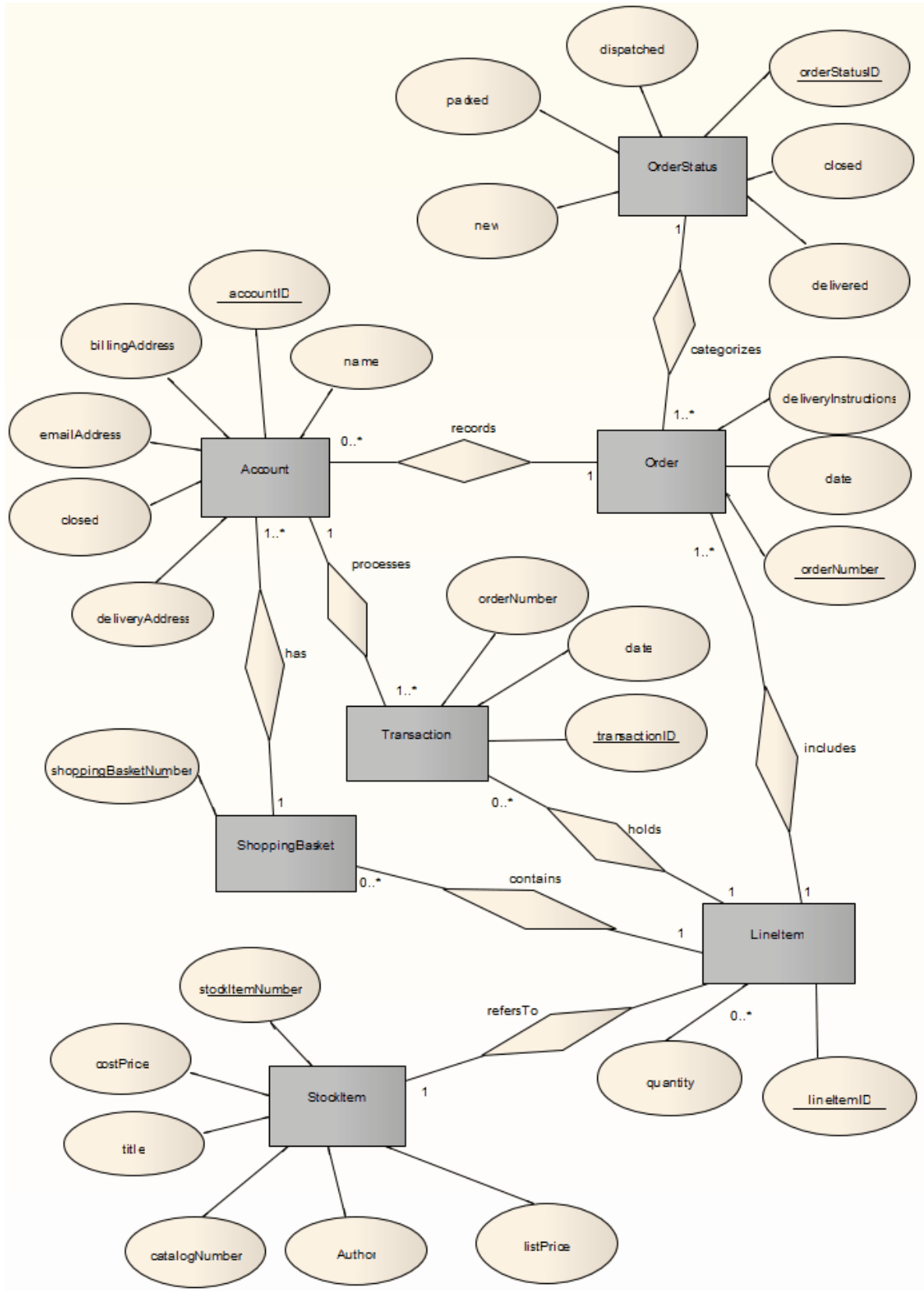

After transformation becomes the Data Model Diagram (for an Oracle DBMS):

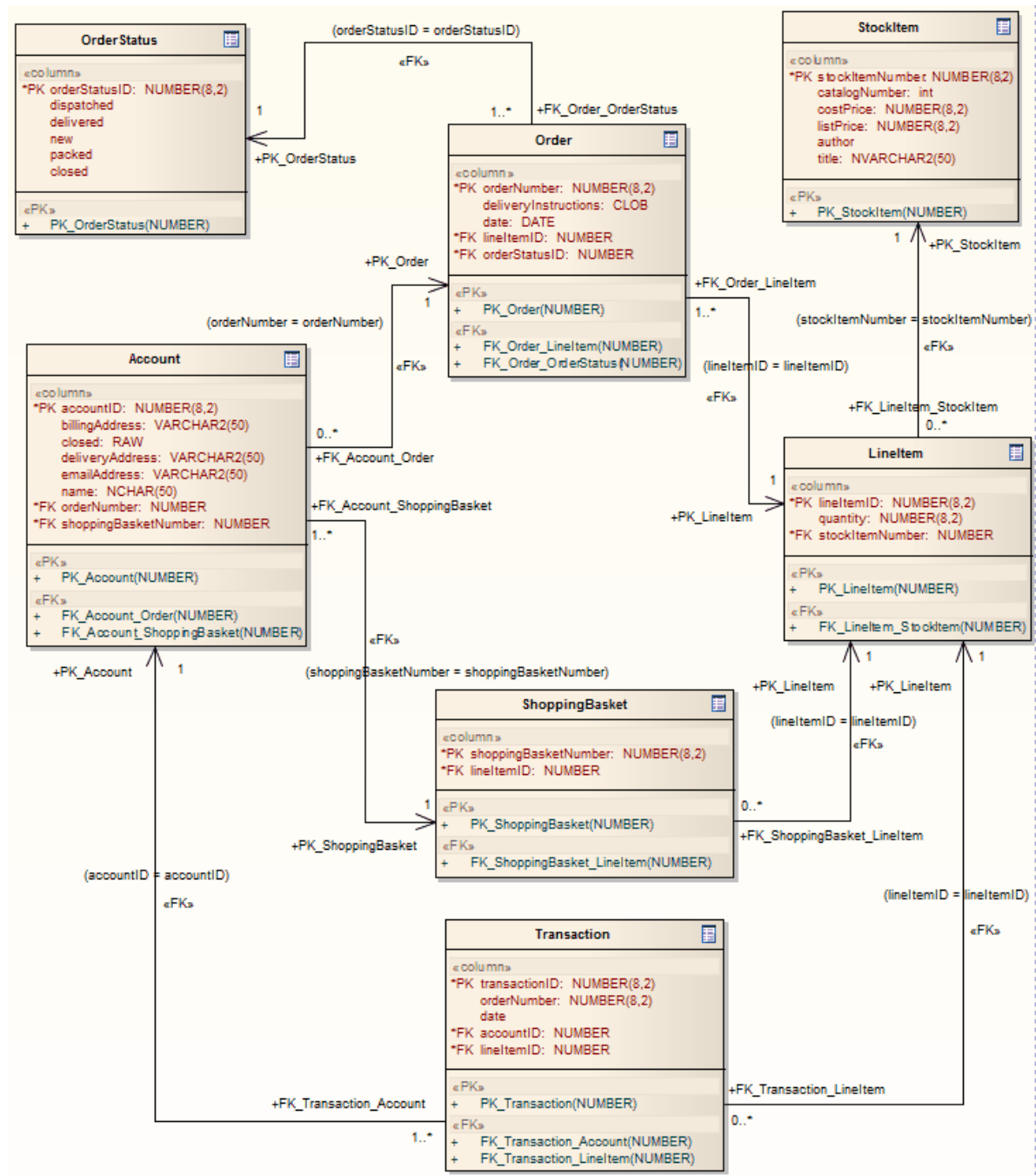

#### Tip:

Sometimes you might go back to the ERD, make some changes and then want to do another transformation. To achieve better results, always delete the previous transformation package before doing the next transformation.

#### Generalization

Generalization can be handled in ERD technology, as illustrated by the following example. Note that the copy-down inheritance is currently supported with two levels only.

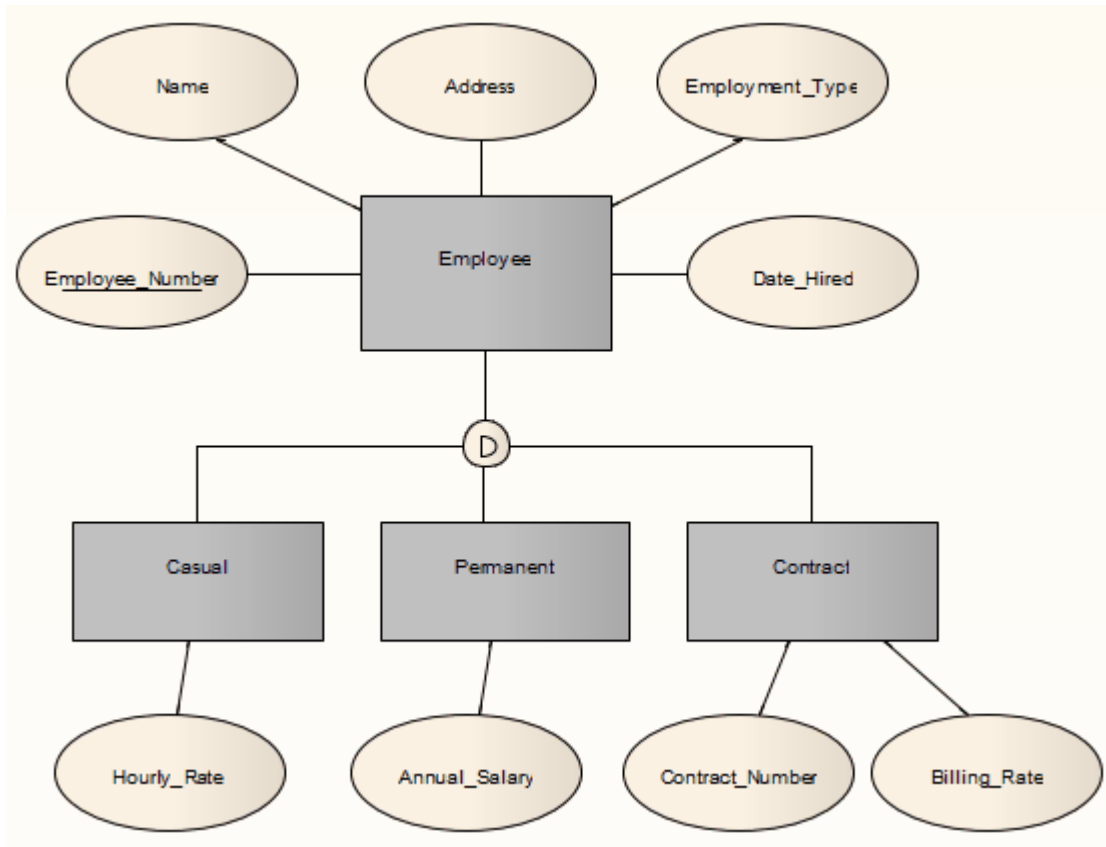

This transforms to:

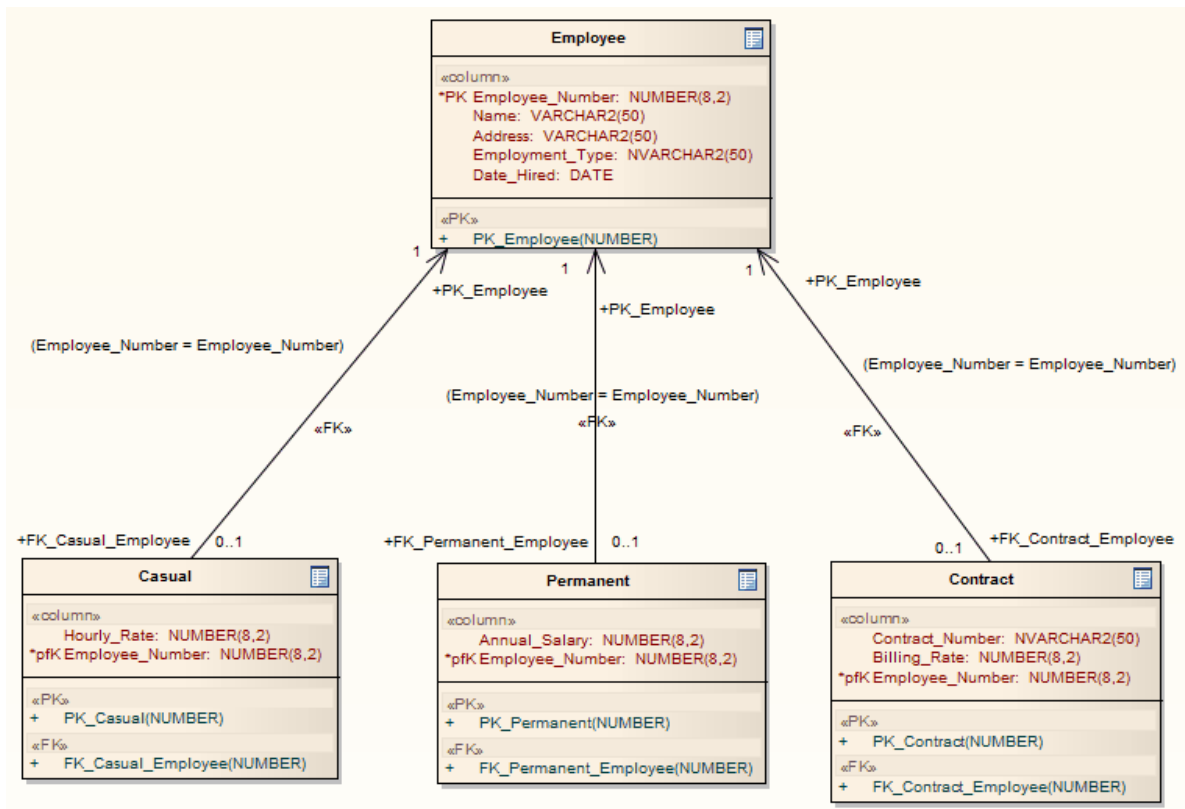

### 7.5.2.6 Java Transformation

The purpose of the **Java transformation** is to convert Platform-Independent Model (PIM) elements to language-specific Java Class elements. The transformation converts the PIM model types to Java types and creates encapsulation according to Enterprise Architect's options for creating properties from Java attributes; that is, producing the getters and setters according to the rules you have defined. Notice that the *public* attributes in the PIM are converted to *private* attributes in the PSM.

You set the code generation options for Java code generation on the [Java Specifications](#) <sup>(1355)</sup> page of the **Options** dialog.

#### The Platform-Independent Model (PIM):

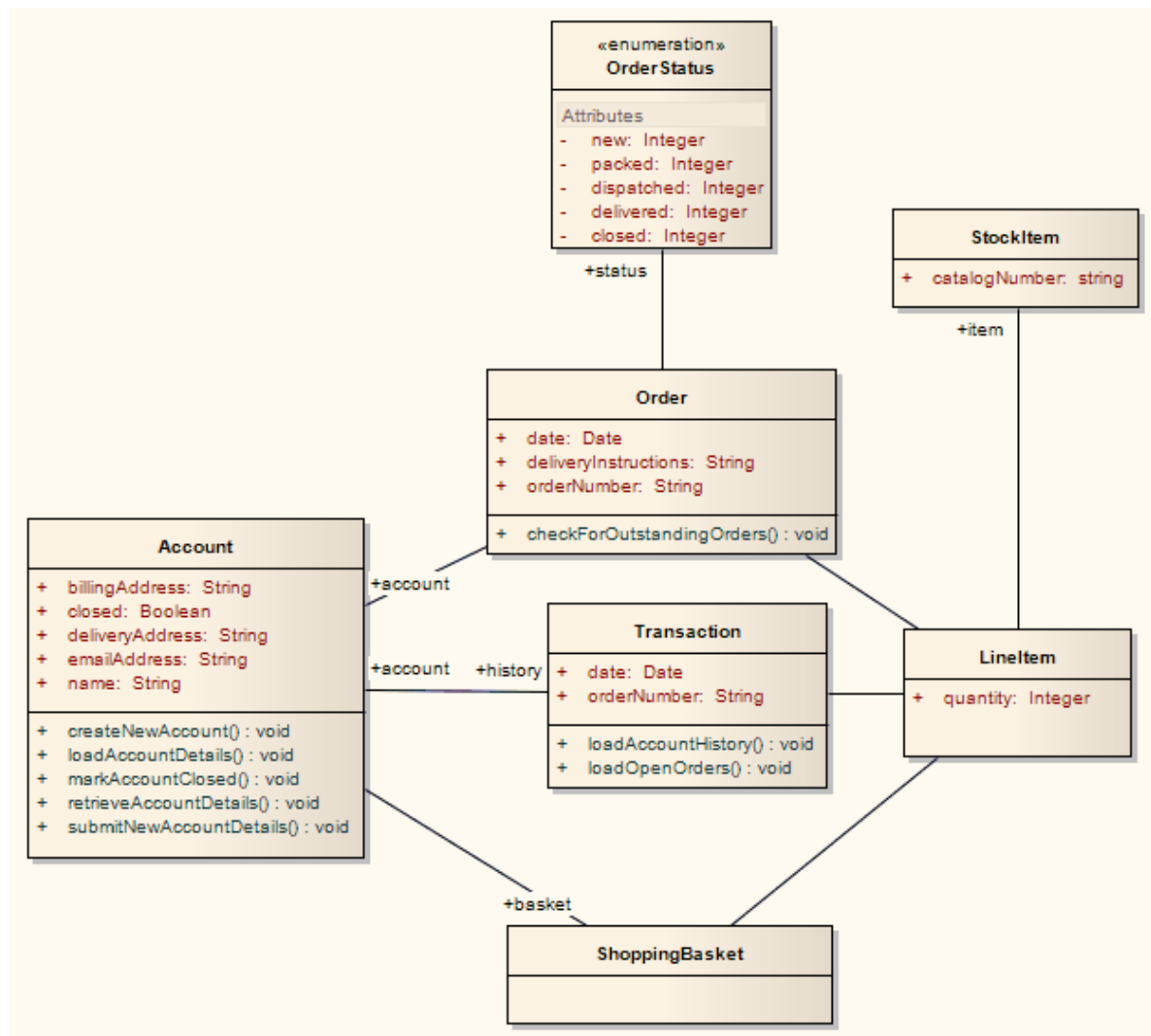

After transformation becomes the PSM:

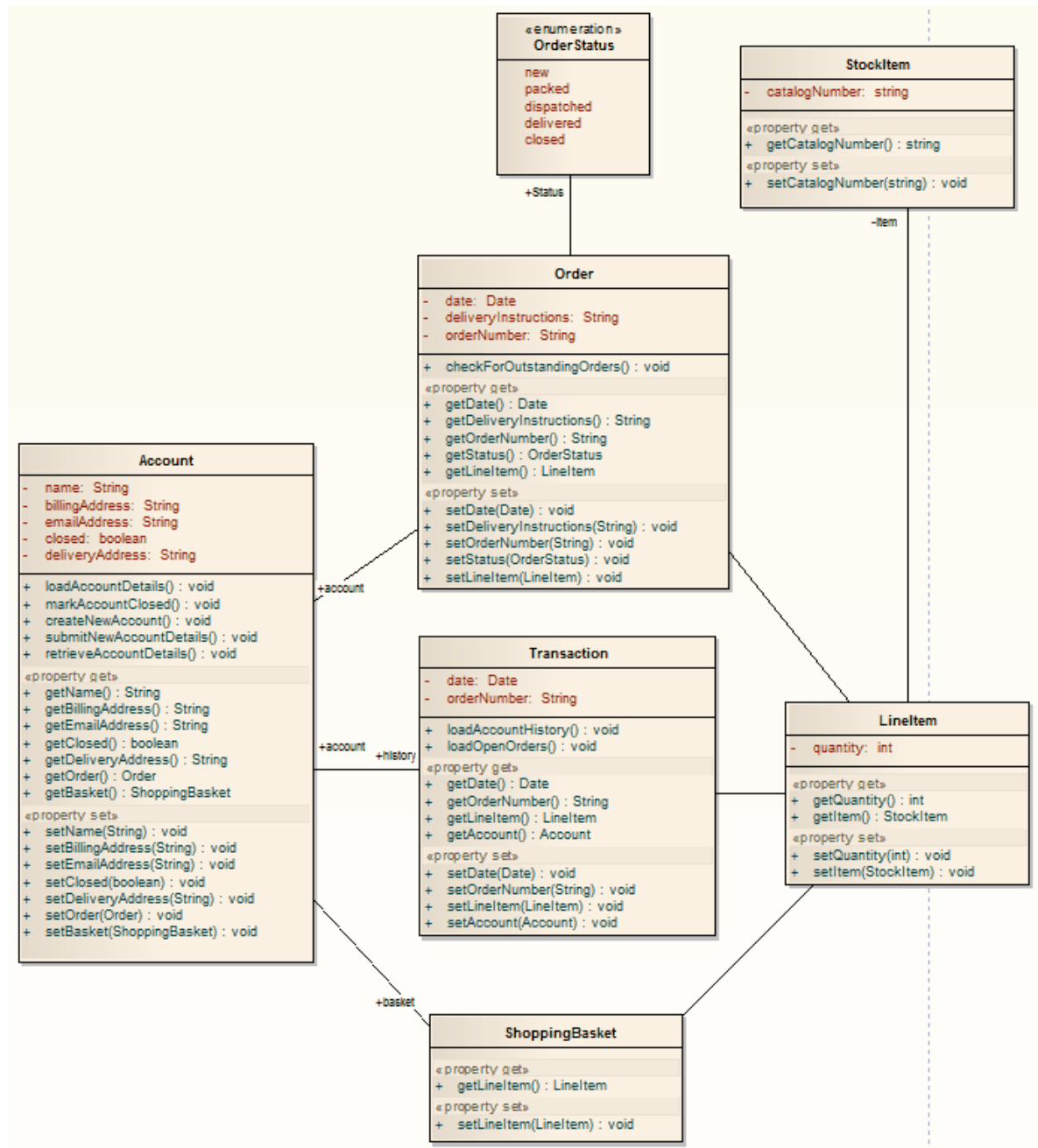



### 7.5.2.7 JUnit Transformation

The purpose of the **JUnit transformation** is to create a Class with test methods for all public methods of an existing Java Class. The resulting Class can then be generated and the tests filled out and run by JUnit.

The Java model originally transformed from the PIM:

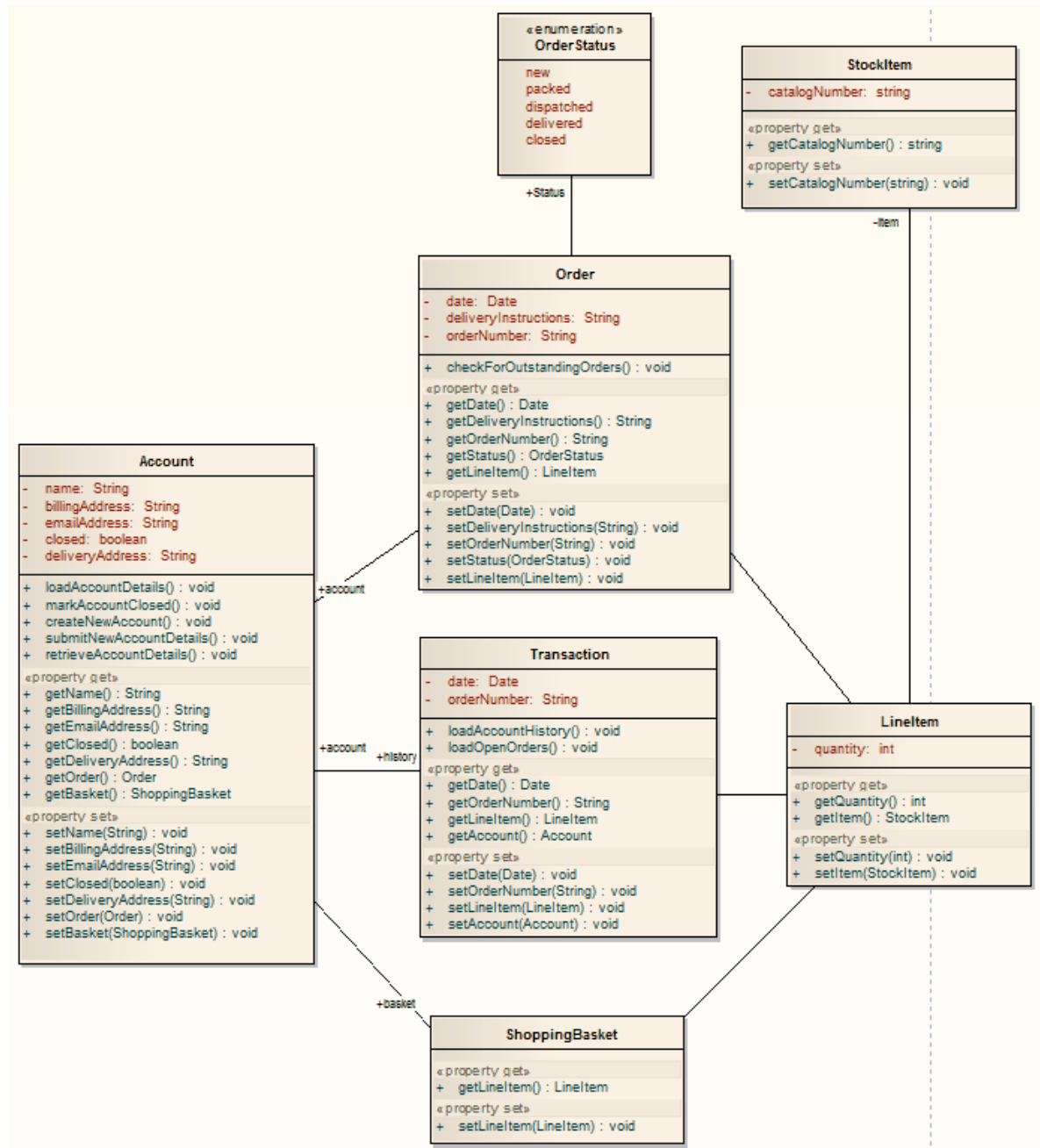

After transformation becomes the PSM:

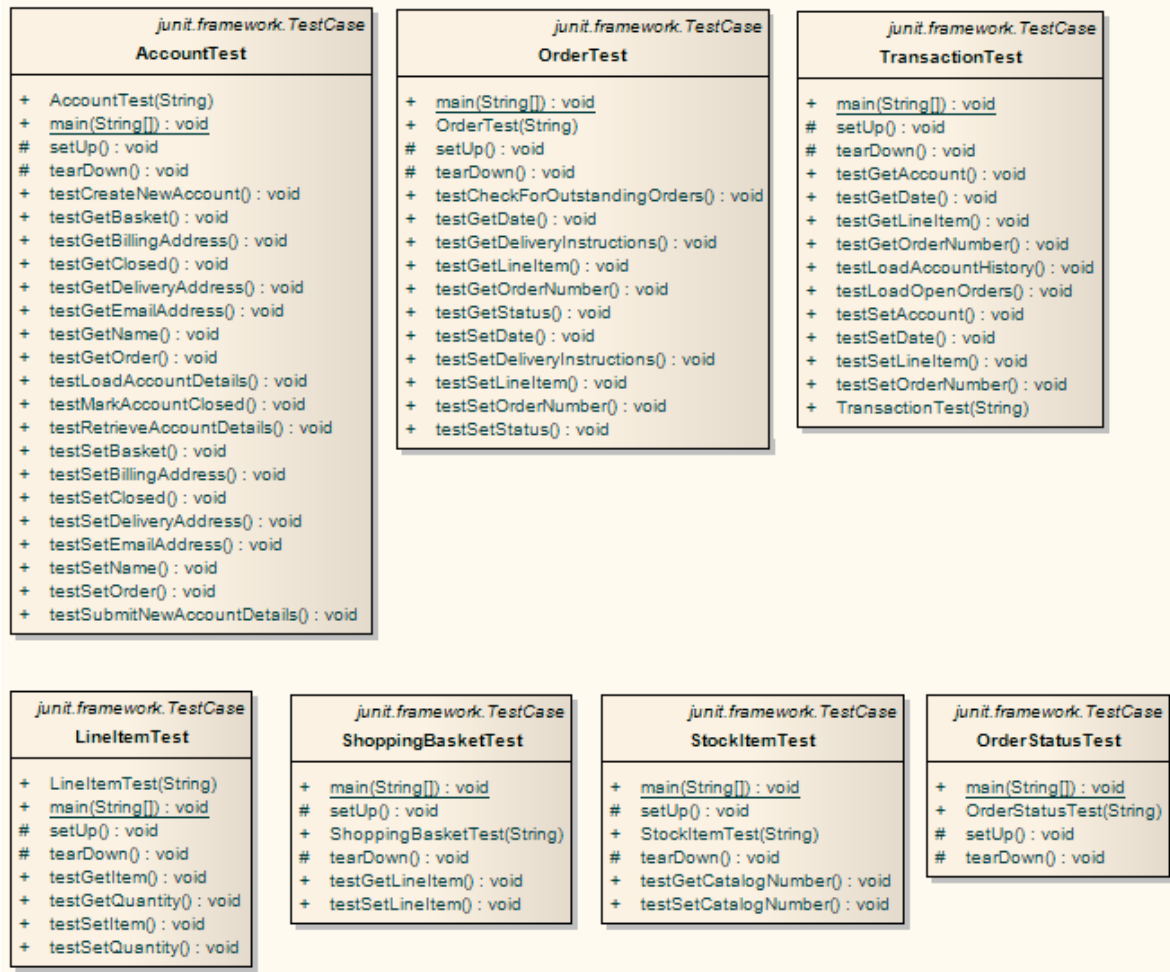

Note that for each Class in the Java model, a corresponding test Class has been created. Each of these test Classes contains a test method for every public method in the source Class, plus the methods required to appropriately set up the [tests](#)<sup>[15]</sup>. It is your responsibility to fill in the details of each test.

### 7.5.2.8 NUnit Transformation

The purpose of the **NUnit transformation** is to create a Class with test methods for all public methods of an existing .Net compatible Class. The resulting Class can then be generated and the tests filled out and run by NUnit.

The C# model originally transformed from the PIM:

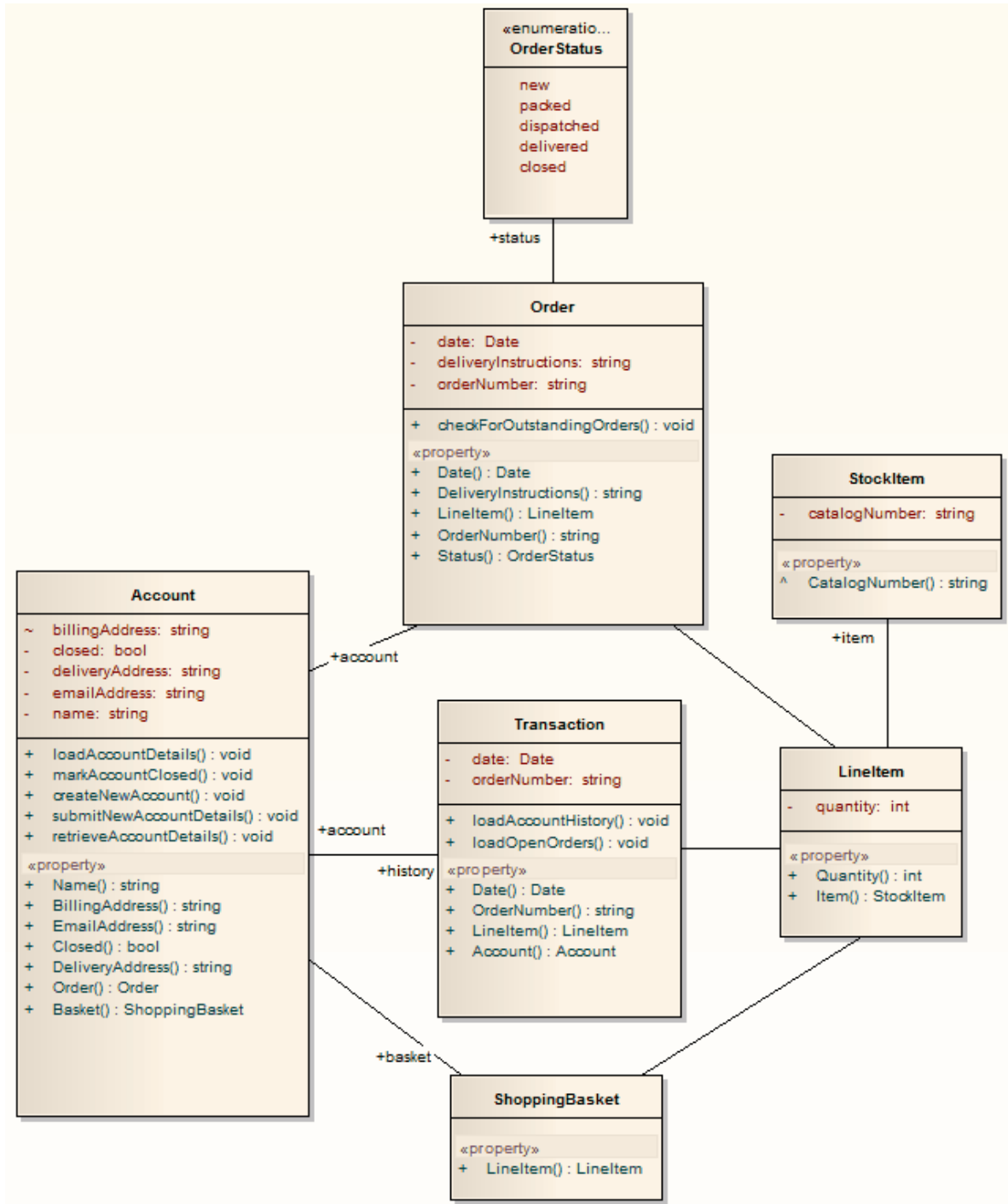

After transformation becomes the PSM:

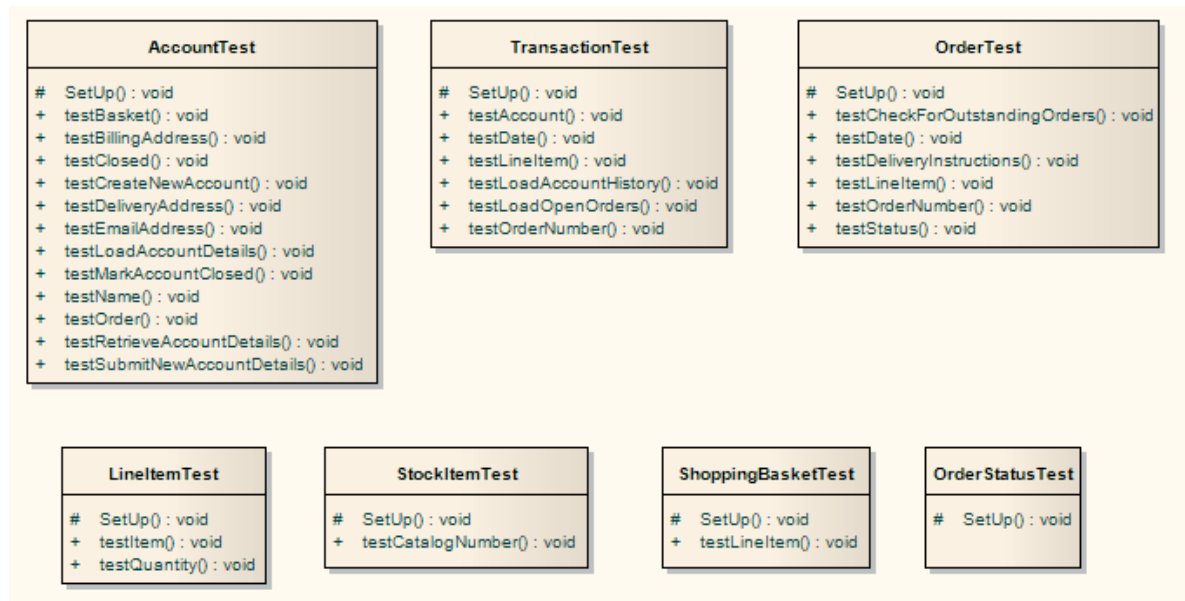

Note that for each Class in the C# model, a corresponding test Class has been created. Each of these test Classes contains a test method for every public method in the source Class, plus the methods required to appropriately set up the [tests](#) <sup>[1512]</sup>. It is your responsibility to fill in the details of each test.

### 7.5.2.9 WSDL Transformation

The purpose of the **WSDL transformation** is to create from a simple model an expanded [model of a WSDL interface](#) <sup>[1050]</sup> that is suitable for generation.

Take the following example interface:

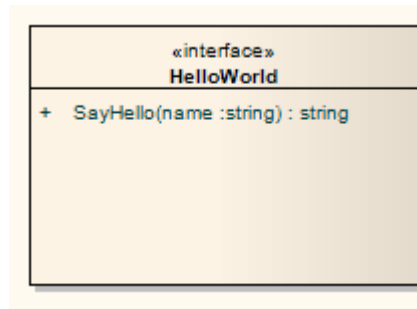

This generates the corresponding WSDL component, service, port type, binding and messages as follows.

- Classes are handled in the same way as the [XSD Transformation](#) <sup>[1408]</sup>
- All in parameters are transformed into *messageParts* in the Request message
- The *return* value and all *out* and *return* parameters are transformed into *messageParts* in the Request message
- All methods where a value is returned are transformed into *Request-Response* operations while all methods not returning a value are transformed into *OneWay* operations
- The transformation does not handle generation of *Solicit-Response* and *Notification* methods or faults.

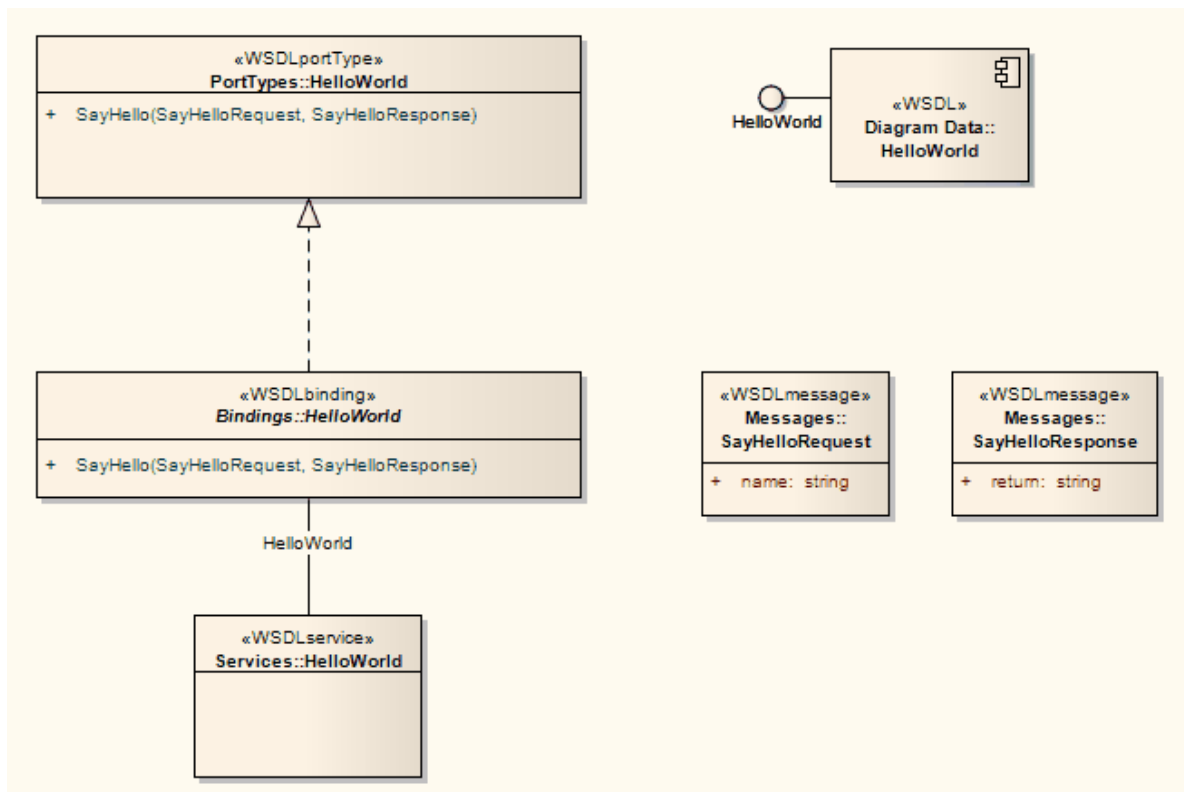

The resulting package can then have the specifics filled out using the WSDL editing capabilities of Enterprise Architect, and finally be generated using [WSDL generation](#)<sup>[1379]</sup>.

### 7.5.2.10 XSD Transformation

The purpose of the **XSD transformation** is to convert Platform-Independent Model (PIM) elements to UML Profile for XML elements as an intermediary step to creating an XML Schema. Each selected PIM Class element is converted to an `«XSDcomplexType»` element.

For more information, see the [Generate XSD](#)<sup>[1376]</sup> topic.

## The Platform-Independent Model (PIM):

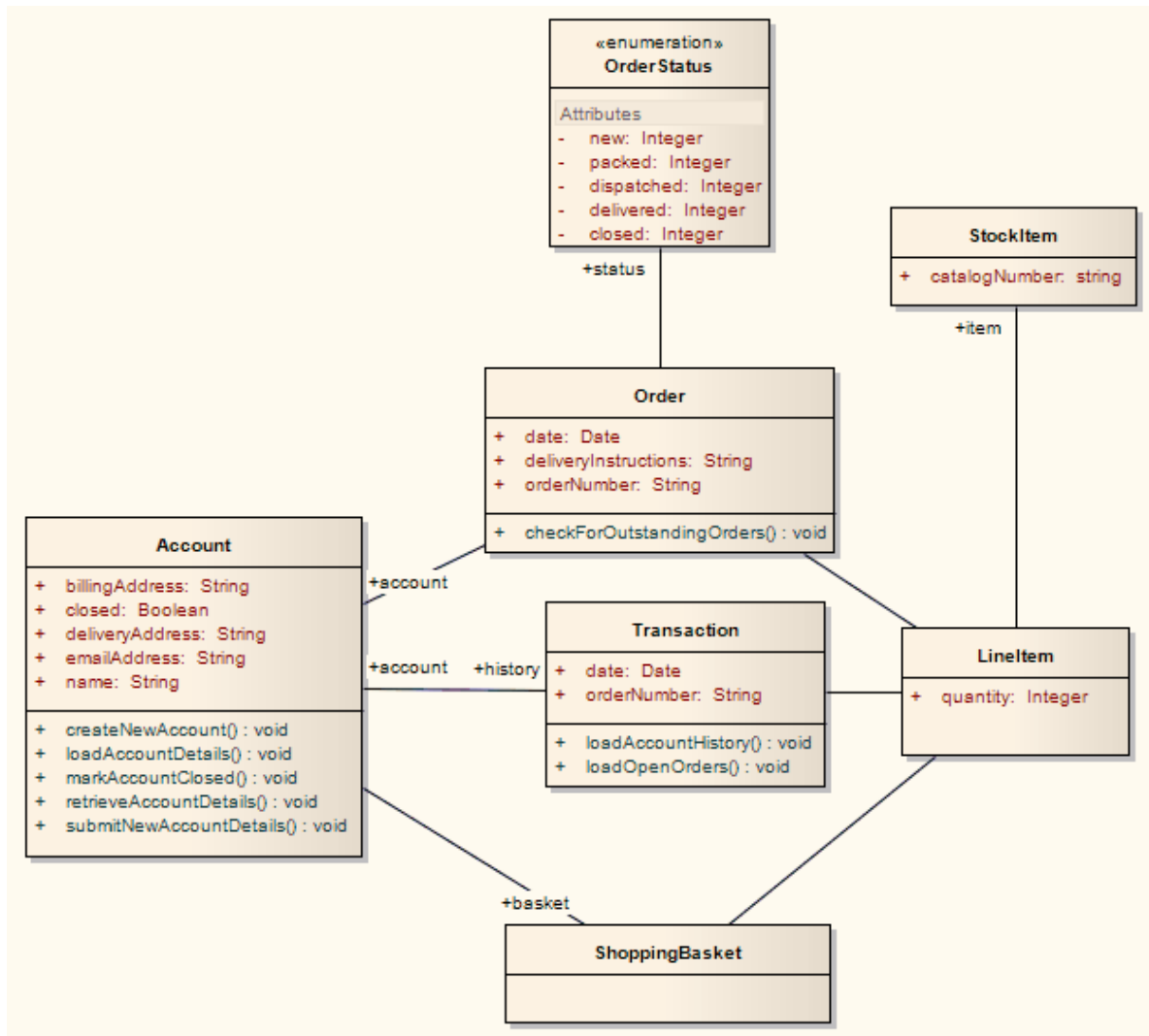

After transformation becomes the PSM:

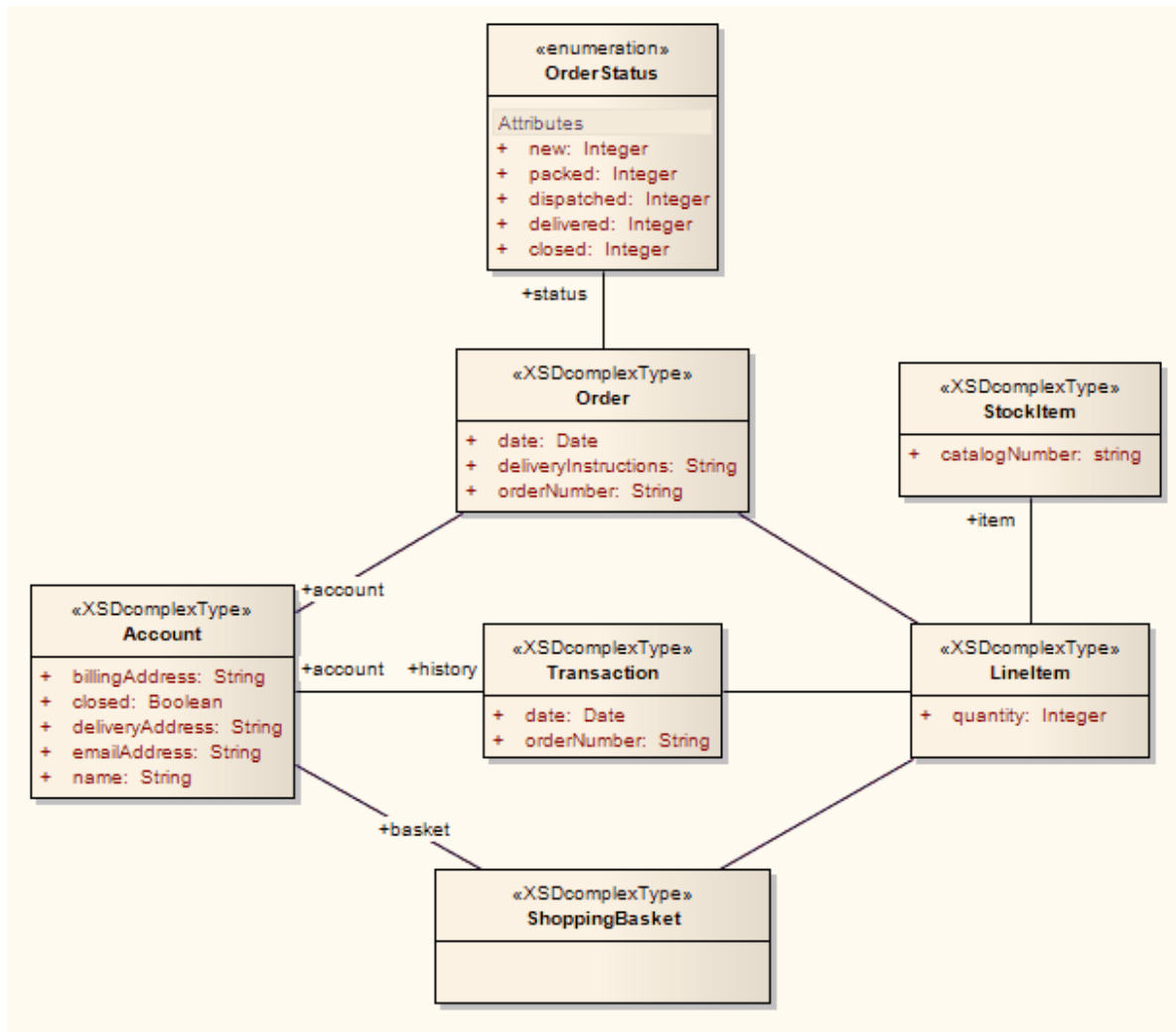

Which in turn generates the following XSD:

```
<?xml version="1.0" encoding="ISO-8859-1"?>
<xs:schema xmlns:xs="http://www.w3.org/2001/XMLSchema">
  <xs:element name="Account" type="Account"/>
  <xs:complexType name="Account">
    <xs:sequence>
      <xs:element name="name" type="xs:string"/>
      <xs:element name="billingAddress" type="xs:string"/>
      <xs:element name="emailAddress" type="xs:string"/>
      <xs:element name="closed" type="xs:boolean"/>
      <xs:element name="deliveryAddress" type="xs:string"/>
      <xs:element ref="Order"/>
      <xs:element ref="ShoppingBasket"/>
    </xs:sequence>
  </xs:complexType>
  <xs:element name="LinelItem" type="LinelItem"/>
  <xs:complexType name="LinelItem">
    <xs:sequence>
      <xs:element name="quantity" type="xs:integer"/>
      <xs:element ref="StockItem"/>
    </xs:sequence>
  </xs:complexType>
  <xs:element name="Order" type="Order"/>
  <xs:complexType name="Order">
    <xs:sequence>
      <xs:element name="date" type="xs:date"/>
      <xs:element name="deliveryInstructions" type="xs:string"/>
      <xs:element name="orderNumber" type="xs:string"/>
    </xs:sequence>
  </xs:complexType>
  <xs:element name="StockItem" type="StockItem"/>
  <xs:complexType name="StockItem">
    <xs:sequence>
      <xs:element name="catalogNumber" type="xs:string"/>
    </xs:sequence>
  </xs:complexType>
  <xs:element name="Transaction" type="Transaction"/>
  <xs:complexType name="Transaction">
    <xs:sequence>
      <xs:element name="date" type="xs:date"/>
      <xs:element name="orderNumber" type="xs:string"/>
    </xs:sequence>
  </xs:complexType>
  <xs:element name="ShoppingBasket" type="ShoppingBasket"/>
  <xs:complexType name="ShoppingBasket">
    <xs:sequence>
      <xs:element name="basket" type="ShoppingBasket"/>
    </xs:sequence>
  </xs:complexType>

```

```

        <xs:element ref="LineItem"/>
        <xs:element name="status" type="OrderStatus"/>
    </xs:sequence>
</xs:complexType>
<xs:simpleType name="OrderStatus">
    <xs:restriction base="xs:string">
        <xs:enumeration value="new"/>
        <xs:enumeration value="packed"/>
        <xs:enumeration value="dispatched"/>
        <xs:enumeration value="delivered"/>
        <xs:enumeration value="closed"/>
    </xs:restriction>
</xs:simpleType>
<xs:element name="ShoppingBasket" type="ShoppingBasket"/>
<xs:complexType name="ShoppingBasket">
    <xs:sequence>
        <xs:element ref="LineItem"/>
    </xs:sequence>
</xs:complexType>
<xs:element name="StockItem" type="StockItem"/>
<xs:complexType name="StockItem">
    <xs:sequence>
        <xs:element name="catalogNumber" type="xs:string"/>
    </xs:sequence>
</xs:complexType>
<xs:element name="Transaction" type="Transaction"/>
<xs:complexType name="Transaction">
    <xs:sequence>
        <xs:element name="date" type="xs:date"/>
        <xs:element name="orderNumber" type="xs:string"/>
        <xs:element ref="Account"/>
        <xs:element ref="LineItem"/>
    </xs:sequence>
</xs:complexType>
</xs:schema>

```

### 7.5.3 Transformation Templates

Note that the Transformation Template mechanism is based very strongly on the Code Generation Template mechanism. For further information on Transformation Templates see the [Code Template Editor](#)<sup>[1305]</sup> section and also - for information on the Common Code Editor and intellisense - the [Code Editors](#)<sup>[1428]</sup> topic.

To modify Transformation templates:

1. Select the **Settings | Transformation Templates** menu option. The **Transformation Templates Editor** displays.
2. In the **Language** field, type or select the name of the transformation to modify.
3. Select a template from the **Templates** list, and edit its contents in the editor pane.
4. Click on the **Save** button.



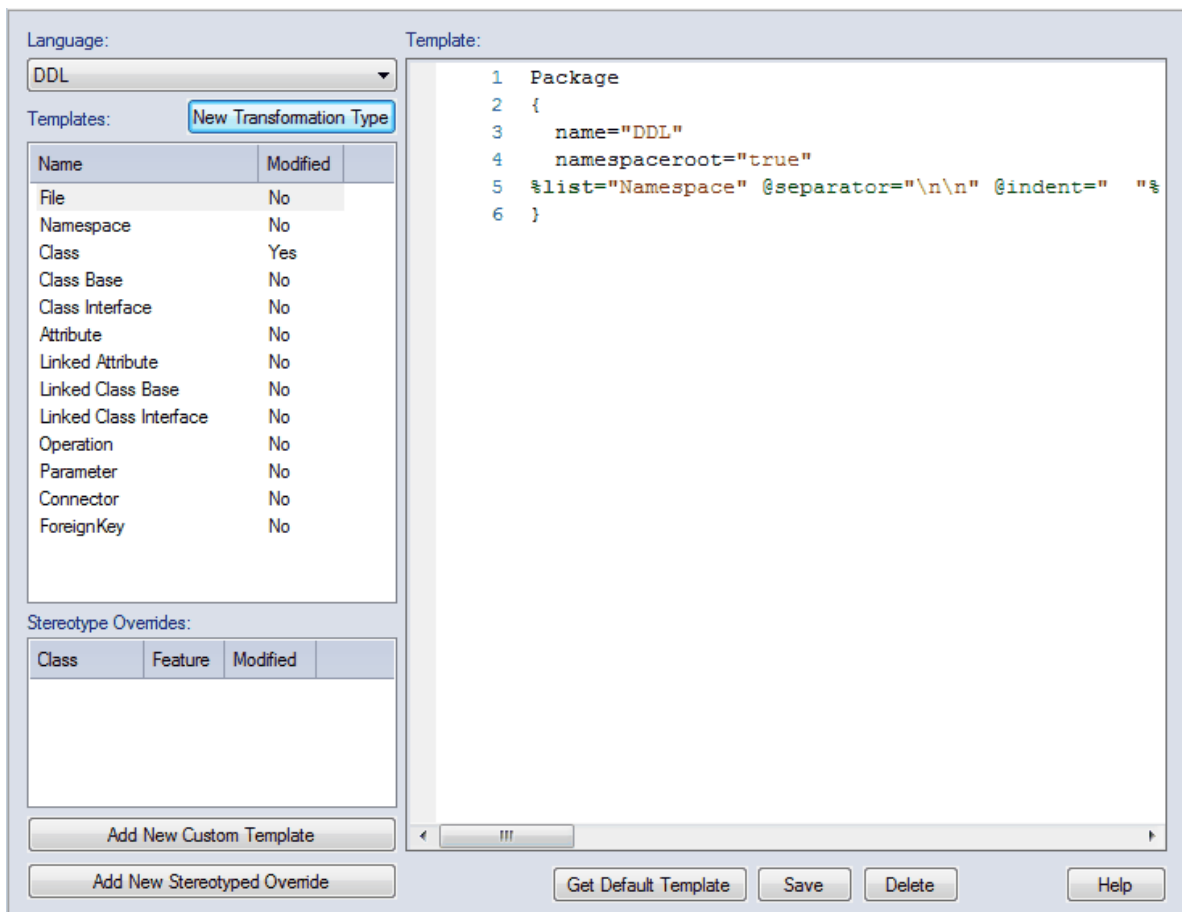

Option	Use to
<b>Language</b>	Select the name of the transformation.
<b>Template</b>	Display the contents of the active template. Provide the editor for modifying templates.
<b>Templates</b>	List the base transformation templates. The active template is highlighted. The <b>Modified</b> field indicates whether you have changed the default template for the current transformation.
<b>New Transformation Type</b>	Create a new transformation.
<b>Stereotype Overrides</b>	List the stereotyped templates, for the active base template. The <b>Modified</b> field indicates whether you have modified a default stereotyped template.
<b>Add New Stereotyped Override</b>	Invoke a dialog for adding a stereotyped template, for the currently selected base template.
<b>Add New Custom Template</b>	Invoke a dialog for creating a custom stereotyped template.
<b>Help</b>	Launch the Enterprise Architect Help topic for this dialog.
<b>Get Default Template</b>	Update the editor display with the default version of the active template.
<b>Save</b>	Overwrite the active templates with the contents of the editor.
<b>Delete</b>	If you have overridden the active template, delete the override and replace it

Option	Use to
	with the corresponding default transformation template.

### 7.5.3.1 Import Transformations

You can transfer Transformation templates between models. To import a Transformation template, follow the steps below:

1. Select the **Tools | Import Reference Data** menu option. The **Import Reference Data** dialog displays.

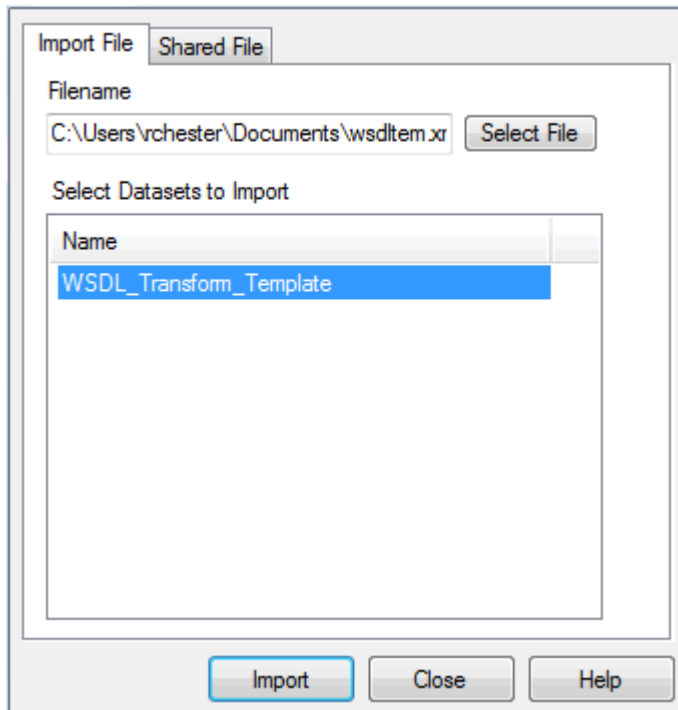

2. Click on the **Select File** button and browse to a .XML file containing the required Transformation template.
3. Select the name of one or more template datasets and click on the **Import** button.

### 7.5.4 Write Transformations

This topic provides help in writing your own transformations. Subjects covered are:

- [Default Transformation Templates](#) <sup>[1415]</sup>
- [General Syntax for the Intermediary Language](#) <sup>[1415]</sup>
- [Syntax for Creating Objects](#) <sup>[1415]</sup>
- [Syntax for Creating Connectors](#) <sup>[1419]</sup>
- [Transforming Duplicate Information](#) <sup>[1421]</sup>
- [Converting Types](#) <sup>[1421]</sup>
- [Converting Names](#) <sup>[1427]</sup>
- [Cross References](#) <sup>[1423]</sup>

Further hints and tips can be gleaned from a close study of the Transformation Templates provided with Enterprise Architect. Note also that writing transformations is very similar to writing code generation templates, so an understanding of the [Code Template Framework](#) <sup>[1301]</sup> can greatly assist in understanding transformations.

The Transformation Template editor provides the facilities of the *Common Code Editor*. For more information on the Common Code Editor, see the [Code Editors](#) <sup>[1428]</sup> topic.

Transformation Templates are accessed from the **Settings | Transformation Templates** menu option.

### 7.5.4.1 Default Transformation Templates

In most transformations, there is a lot of information that is simply copied to the target model. In order to make writing new transformations simpler Enterprise Architect provides a default set of transformation templates. These templates perform a simple copy of the source model to the target model. This means that in order to write a new transformation you can modify the default templates to make the required changes.

#### Note:

When creating a new transformation you must modify at least one template before the transformation becomes available.

### 7.5.4.2 Intermediary Language

All transformations in Enterprise Architect work by generating a text form of the model to generate.

Any element is represented in this language by the type of element (for example, Class, Action, Method, Generalization or Tag) followed by the properties of the element and the elements that it is made from. The grammar for this resembles the following.

```

element:
    elementName { (elementProperty | element)* }

elementProperty:
    packageName
    stereotype
    propertyName = " propertyValueSymbol* "

packageName:
    name = " propertyValueSymbol* " ( . " propertyValueSymbol* " )*
stereotype:
    stereotype = " propertyValueSymbol* " ( , " propertyValueSymbol* " )*

propertyValueSymbol:
    \|
    \"
    Any character except " (U+0022), \ (U+005C)
  
```

- *elementName* is any one of the set of element types as described in [Objects](#) <sup>[1415]</sup> and [Connectors](#) <sup>[1415]</sup>
- *propertyName* is any one of the set of properties as described in [Objects](#) <sup>[1415]</sup> and [Connectors](#) <sup>[1415]</sup>.

Literal strings can be included in property values by escaping a quote character. For example:

```
default = "\"Some string value.\""
```

### 7.5.4.3 Objects

Objects are created in Enterprise Architect by generating text in the following form:

```

objectType
{
    objectProperties
}
  
```

where:

objectType is one of the following object types:

- *Action*
- *ActionPin*
- *Activity*
- *ActivityParameter*
- *ActivityPartition*
- *ActivityRegion*
- *Actor*
- *Association*
- *Change*
- *Class*
- *Collaboration*
- *CollaborationOccurrence*

- *Component*
- *DeploymentSpecification*
- *DiagramFrame*
- *Decision*
- *EntryPoint*
- *Event*
- *ExceptionHandler*
- *ExecutionEnvironment*
- *ExitPoint*
- *ExpansionNode*
- *ExpansionRegion*
- *ExposedInterface*
- *GUIElement*
- *InteractionFragment*
- *InteractionOccurrence*
- *InteractionState*
- *Interface*
- *InterruptibleActivityRegion*
- *Issue*
- *Iteration*
- *Object*
- *ObjectNode*
- *MessageEndpoint*
- *Node*
- *Package*
- *Parameter*
- *Part*
- *Port*
- *ProvidedInterface*
- *RequiredInterface*
- *Requirement*
- *Sequence*
- *State*
- *StateMachine*
- *StateNode*
- *Synchronization*
- *Table*
- *TimeLine*
- *Trigger*
- *UMLDiagram*
- *UseCase.*

objectProperties is zero, or one or more of the following properties:

- *Abstract*
- *Alias*
- *Arguments*
- *Author*
- *Cardinality*
- *Classifier*
- *Complexity*
- *Concurrency*

- *Filename*
- *Header*
- *Import*
- *IsActive*
- *IsLeaf*
- *IsRoot*
- *IsSpecification*
- *Keyword*
- *Language*
- *Multiplicity*
- *Name*
- *Notes*
- *Persistence*
- *Phase*
- *Scope*
- *Status*
- *Stereotype*
- *Version*
- *Visibility*.

and zero, or one or more of the following elements:

- *Attribute*
- *Classifier*
- *Parameter*
- *Operation*
- *Parent*
- *Tag*
- *XRef*
- Any object.

#### Notes:

- Some of the above only apply to certain object types.
- Every object created in a transformation should include an [XRef element](#)<sup>[1423]</sup>, as it enables Enterprise Architect to synchronize with the element and makes it possible to create a connector to that Class in a transformation.

## Classes

A simple Class can be created as follows:

```
Class
{
    name = "Example"
}
```

It is then easy to add to this. The following example sets the language to C++, and adds a Tagged Value and an attribute:

```
Class
{
    name = "Example"
    language = "C++"
    Tag
    {
        name = "defaultCollectionClass"
        value = "List"
    }
    Attribute
    {
        name = "count"
    }
}
```

```
        type = "int"  
    }  
}
```

## Attributes

Attributes are created with the same structure as objects, and include the following properties:

- *Alias*
- *Classifier*
- *Collection*
- *Container*
- *Containment*
- *Constant*
- *Default*
- *Derived*
- *LowerBound*
- *Name*
- *Notes*
- *Ordered*
- *Scope*
- *Static*
- *Stereotype*
- *Type*
- *UpperBound*
- *Volatile*.

and the following elements:

- *Classifier*
- *Tag*
- *XRef*.

## Operations

Operations are created with the same structure as objects, and include the following properties:

- *Abstract*
- *Alias*
- *Behavior*
- *Classifier*
- *Code*
- *Constant*
- *IsQuery*
- *Name*
- *Notes*
- *Pure*
- *ReturnArray*
- *Scope*
- *Static*
- *Stereotype*
- *Type*.

and the following elements:

- *Classifier*
- *Parameter*
- *Tag*
- *XRef*.

## Parameters

Parameters are created with the same structure as objects, and include the tag element and the following properties:

- *Classifier*
- *Default*
- *Fixed*
- *Name*
- *Notes*
- *Kind*
- *Stereotype*.

## Packages

Packages differ from other objects in the following ways:

- A reduced set of properties of *alias*, *author*, *name*, *namespaceRoot*, *notes*, *scope*, *stereotype* and *version*
- The extra property *namespaceRoot*
- Must have a name specified
- *Name* can be a qualified name; when a qualified name is specified the properties given are applied only to the final package
- Can contain other packages
- Can't contain attributes and operations.

## Tables

Tables are a special sort of object, with the following differences from other object types:

- Can include columns and primary keys
- Can't include attributes.

## Columns

Columns are similar to attributes, but have an *autonumber* element containing *Startnum* and increment, and the following added properties:

- *Length*
- *NotNull*
- *Precision*
- *PrimaryKey*
- *Scale*
- *Unique*.

### Note:

In the column definition, you cannot assign a value to the **NotNull**, **PrimaryKey** or **Unique** properties.

### 7.5.4.4 Connectors

Creating connectors in a transformation can be complex, but the process has the same form as creating elements. The difference is that you must also specify each end.

The different connectors that can be created are as follows.

- Aggregation
- Assembly
- Association
- Collaboration
- ControlFlow
- Connector
- Delegate
- Dependency

- Deployment
- ForeignKey
- Generalization
- InformationFlow
- Instantiation
- Interface
- InterruptFlow
- Manifest
- Nesting
- NoteLink
- ObjectFlow
- Package
- Realization
- Sequence
- Transition
- UseCase
- Uses

#### Note:

- *ForeignKey* is a special case where not just a connector is created; you must also list the columns involved in the transformation. In addition, tags specified on the connector are actually created on the foreign key operation in the source Class, and a cascade property can be added; for example, *cascade="update","delete"*.
- Each connector is transformed at both end objects, therefore the connector might appear twice in the transformation. This is nothing to be concerned about, but you should check carefully that the connector is generated exactly the same way, regardless of which end is on the current Class.

There are two different types of Class that you can use as a connector end: one created by a transformation, and one for which you already know the GUID.

### Connect to a Class Created by a Transformation

The most common connection is to connect to a Class created by a transformation. To do this you must have three items of information:

- The original Class GUID
- The name of the transformation
- The name of the transformed Class.

This type of connector is created using the [TRANSFORM\\_REFERENCE](#)<sup>1423</sup> function macro. When the element is in the current transformation, it can be safely omitted from the transformation. The simplest example of this is when you have created multiple Classes from a single Class in a transformation and want a connector between them. Consider this example from the EJB Entity transformation:

```

Dependency
{
  %TRANSFORM_REFERENCE("EJBRealizeHome",classGUID)%
  stereotype="EJBRealizeHome"
  Source
  {
    %TRANSFORM_REFERENCE("EJBEntityBean",classGUID)%
  }
  Target
  {
    %TRANSFORM_REFERENCE("EJBHomeInterface",classGUID)%
  }
}

```

There are three uses of the **TRANSFORM\_REFERENCE** macro: one to identify this connector for synchronization purposes and the other two to identify the ends. All three use the same source GUID, because they all come from the one original Class. None of the three have to specify the transformation because the two references are referencing something in the current transformation. Each of them then only has to identify the transform name.



Of course it is also possible to create a connector from another connector.

You can create a connector template and list over all connectors connected to a Class from the Class level templates. You don't have to worry about only generating it once, because if you have created a **TRANSFORM\_REFERENCE** for the connector then Enterprise Architect automatically synchronizes them. The following copies the source connector.

```
%connectorType%
{
  %TRANSFORM_CURRENT()%
  %TRANSFORM_REFERENCE("Connector",connectorGUID)%
  Source
  {
    %TRANSFORM_REFERENCE("Class",connectorSourceGUID)%
    %TRANSFORM_CURRENT("Source")%
  }
  Target
  {
    %TRANSFORM_REFERENCE("Class",connectorDestGUID)%
    %TRANSFORM_CURRENT("Target")%
  }
}
```

### Connecting to a Class For Which You Know the GUID

The second type of Class that you can use as a connector end is one for which you know the current GUID. To do this, specify the GUID of the target Class in either the source or target end. The following example creates a dependency from a Class created in a transformation, to the Class it was transformed from.

```
Dependency
{
  %TRANSFORM_REFERENCE("SourceDependency",classGUID)%
  stereotype="transformedFrom"
  Source
  {
    %TRANSFORM_REFERENCE("Class",classGUID)%
  }
  Target
  {
    GUID=%qt%%classGUID%%qt%
  }
}
```

#### 7.5.4.5 Copy Information

In many transformations there is a substantial amount of information to be copied. It would be tedious to type all of the common information into a template so that it is copied to the transformed Class. The alternative is to use the **TRANSFORM\_CURRENT** function macro to do exactly this.

- **TRANSFORM\_CURRENT(<listOfExcludedItems>)** - Generates an exact copy of all the properties of the current item, except for the items named in <listOfExcludedItems>.

Another form of this is available when transforming connectors that enables either end of the connector to be copied:

- **TRANSFORM\_CURRENT(<connectorEnd>,<listOfExcludedItems>)** - Generates an exact copy of the connector end specified by <connectorEnd> except for the items named in <listOfExcludedItems>, where <connectorEnd> is either *Source* or *Target*.

#### 7.5.4.6 Convert Types

Different target platforms almost certainly require different types, so you often require a method of converting between types. The following macro offers this.

- **CONVERT\_TYPE(<destinationLanguage>, <originalType>)** - Converts <originalType> to the corresponding type in <destinationLanguage> using the datatypes and common types defined in the model, where <originalType> is assumed to be a platform independent common type.

A similar macro is available when transforming common datatypes to the datatypes for a specified database.

- **CONVERT\_DB\_TYPE(<destinationDatabase>, <originalType>)** - Converts <originalType> to the corresponding datatypes in <destinationDatabase>, which is defined in the model. The <originalType> refers to a platform independent common datatype.

### 7.5.4.7 Convert Names

Different target platforms use different naming conventions. As a result you might not want to copy the names of your elements directly into the transformed models. To facilitate this requirement, Enterprise Architect's transformation templates provide a [CONVERT\\_NAME](#)<sup>[1422]</sup> function macro.

Another way in which you can transform a name is to remove a prefix from the original name, with the [REMOVE\\_PREFIX](#)<sup>[1422]</sup> macro.

#### CONVERT\_NAME(<originalName>, <originalFormat>, <targetFormat>)

This macro converts <originalName>, which is assumed to be in <originalFormat>, to <targetFormat>.

The supported formats are:

- Camel Case: New words start with a capital letter *except* for the first word, which begins with a lower case letter; for example, *myVariableTable*
- Pascal Case: Same as Camel Case but the first letter of the first word is upper case; for example, *MyVariableTable*
- Spaced: Words are separated by spaces; the case of letters is ignored
- Underscored: Words are separated by underscores; the case of letters is ignored.

#### Note:

Acronyms are not supported when converting from Camel Case or Pascal Case.

The original format might also specify a list of delimiters to be used. For example a value of ' \_ ' breaks words whenever either a space or underscore is found.

The target format might also use a format string that specifies the case for each word and a delimiter between them. It takes the following form:

<firstWord>(<delimiter>)<otherWords>

- <firstWord> controls the case of the first word (see below)
- <delimiter> is the string generated between words
- <otherWords> applies to all words after the first word.

<firstWord> and <otherWords> are both a sequence of two characters. The first character represents the case of the first letter of that word, and the second character represents the case of all subsequent letters. An upper case letter forces the output to upper case, a lower case letter forces the output to lower case, and any other character preserves the original case.

**Example 1:** To capitalize the first letter of each word and separate multiple words with a space:

"Ht( )Ht" to output "My Variable Table"

**Example 2:** To generate the equivalent of Camel Case, but reverse the roles of upper and lower case; that is, all characters are upper case except for the first character of each word *after* the first word:

"HT( )hT" to output "MY VARIABLE tABLE"

#### REMOVE\_PREFIX(<originalName>, <prefixes>)

This macro removes any prefix found in <prefixes> from <originalName>. The prefixes are specified in a semi-colon separated list.

The macro is often used in conjunction with the `CONVERT_NAME` macro. For example, this code creates a *get property name* according to the options for Java.

```
$propertyName=%REMOVE_PREFIX(attName,genOptPropertyPrefix)%
%if genOptGenCapitalisedProperties=="T"%
$propertyName=%CONVERT_NAME($propertyName, "camel case", "pascal case")%
%endif%
```

### 7.5.4.8 Cross References

Cross References are an important part of transformations. They are used to:

- Find the transformed Class to synchronize with
- Create connectors between transformed Classes
- Specify a classifier of a type
- Determine where to transform to for future transformations.

Each cross reference has three different parts:

- A *Namespace*, corresponding to the transformation that generated the element
- A *Name*, which is a unique reference to something that can be generated in the above transformation
- A *Source*, which is the GUID of the element that this element was created from.

When writing the templates for a transformation, it is easiest to create the cross references using the **TRANSFORM\_REFERENCE** macro that is defined for this purpose. It has three optional parameters.

#### **TRANSFORM\_REFERENCE(<name>, <sourceGuid>, <namespace>)**

Generates a reference that can be used in the ways described above. It resembles the following.

```
XRef{namespace="<namespace>" name="<name>" source="<sourceGuid>"}
```

Where:

- If <name> is not specified it gets the name of the current template
- If <sourceGUID> is not specified it gets the GUID of the current Class
- If <namespace> is not specified it gets the name of the current transformation.

#### **Note:**

The only time that this should be specified is when creating a connector to a Class created in a different transformation.

A good example of the use of cross references is in the [DDL](#) templates provided with Enterprise Architect. In the Class template a cross reference is created with the name table. Then up to two different connectors can be created, each of which must identify the two Classes it connects using cross references while having its own unique cross reference.

### Specify Classifiers

Objects, attributes, operations and parameters can all reference another element in the model as their type. When this type is created from a transformation you must use a cross reference to specify it, using the **TRANSFORM\_CLASSIFIER** macro.

#### **TRANSFORM\_CLASSIFIER(<name>, <sourceGuid>, <namespace>)**

Generates a cross reference within a classifier element, where the parameters are identical to the **TRANSFORM\_REFERENCE** macro but the name *Classifier* is generated instead of *XRef*.

If the target classifier already exists in the model before the transformation, a **TRANSFORM\_CLASSIFIER** is inappropriate and instead the GUID can be given directly to a classifier attribute.

#### **Note:**

If a classifier is specified for any type it overrides the type specified.

## 7.6 Integrated Development



This section discusses the Enterprise Architect Integrated, or Model Driven, Development Environment (MDDE).

It describes:

- [Getting started](#)<sup>[1424]</sup> with the prerequisites and tools of the MDDE
- How to [set up](#)<sup>[1425]</sup> the scripts to control actions
- How to use the [code editors](#)<sup>[1425]</sup> across the development environment
- How to [build](#)<sup>[1443]</sup>, [debug](#)<sup>[1446]</sup>, [run](#)<sup>[1482]</sup>, [test](#)<sup>[1483]</sup> and [deploy](#)<sup>[1484]</sup> your application code
- How to [search files](#)<sup>[1485]</sup> for data names and structures.

### 7.6.1 Getting Started

To quickly start development in the Model Driven Development Environment, check through the following topics:

- [Prerequisites](#)<sup>[1424]</sup>
- [Available Tools](#)<sup>[1424]</sup>
- [Workspace Layouts](#)<sup>[1424]</sup>
- [General Workflow](#)<sup>[1425]</sup>

#### 7.6.1.1 Prerequisites

Before using the Model Driven Development Environment:

- You should be using the correct edition: Enterprise Architect Professional, Corporate or Suite Editions.
- You should be connected to the required model.
- Relevant source code should be imported into the model.
- [Basic Setup](#)<sup>[1425]</sup> should be complete.

#### 7.6.1.2 Available Tools

This section describes the tools available in the Model Driven Development Environment:

- [Workspace Layouts](#)<sup>[1424]</sup>
- [Code Engineering](#)<sup>[1281]</sup>
- [Using Code Editors](#)<sup>[1425]</sup>
- [Intellisense](#)<sup>[1432]</sup>
- [Application Management](#)<sup>[1425]</sup>
- [Debugger Management](#)<sup>[1446]</sup>

#### 7.6.1.3 Workspace Layout

You can choose from many predefined [workspace layouts](#)<sup>[86]</sup> depending on the tasks you perform. When you are familiar with the environment and controls available to you, you can create your own.

##### Workspace Toolbar

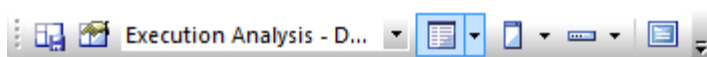

## Predefined Workspace Layouts

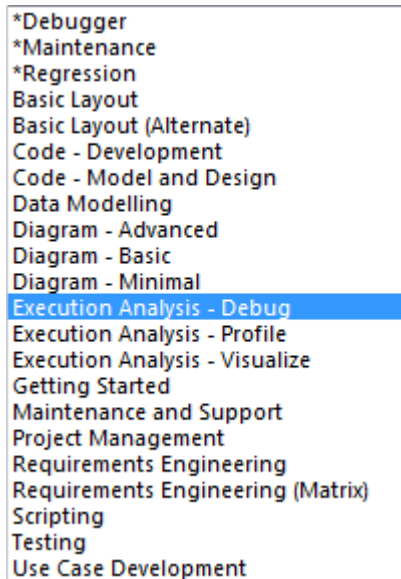

### 7.6.1.4 General Workflow

In working with the Model Driven Development Environment, you apply the following workflow as a circular process, refining as necessary in each iteration.

- [Configure and set up scripts](#) <sup>[1426]</sup>
- Model - Edit - Build - Debug - Test - Profile - Deploy - Document and Analyze.

### 7.6.1.5 Code Generation and Synchronization - Safeguards

It is important that the model and source code are kept synchronized for the Visual Execution Analyzer to produce useful results.

Use the Code Generation tools to [synchronize](#) <sup>[1327]</sup> your model after any design changes or code editing.

Always build the application prior to any Execution Analysis session - debugging, recording or profiling.

### 7.6.1.6 Code Editing For MDDE

See the [Code Editors](#) <sup>[1428]</sup> topic.

## 7.6.2 Setup

To use the execution tools of the Model Driven Development Environment - debugging, build and recording - it is necessary to record information about the application. This is achieved in Enterprise Architect through the use of Package Scripts.

A Package Script, when created, is naturally associated with the package that is currently selected.

A Package Script houses all the information the MDDE requires in order to provide support for tasks such as building the application, debugging and performing unit testing. A model can contain many Package Scripts. Each can build a separate application, or perhaps the same application but with different compilation options.

When you select a package or child Class in the **Project Explorer**, the **Debug Management** window displays any Package Scripts associated with that package. When you select a package root, the **Debug Management** window displays the scripts for the first package it finds under the root that has Scripts.

When you selected another package, the scripts displayed in the **Debug Management** window change also. You can force the scripts for a particular package to remain visible at all times by [pinning](#) <sup>[1429]</sup> the package in the **Debug Management** window.

## External Tools and Environment

If you plan on using any of the debugging features of the MDDE, you must have the appropriate Framework

installed on your machine:

- The Java Runtime Environment for Java
- The .NET Framework for managed applications

Any Operating System Environment Variables such as \$PATH required by these kits should also be established.

### 7.6.2.1 Managing Scripts

In Enterprise Architect, any package within the UML Model can be configured to act as the 'root' of a source code project. By setting compilation scripts, xUnit commands, debuggers and other configuration settings for a package, all contained source code and elements can be built, tested or debugged according to the currently active configuration. Each package can have multiple scripts, but only one is active at any one time. The **Package Build Scripts** dialog enables you to create and manage those scripts.

To access the **Package Build Scripts** dialog, either:

- Press **[Shift]+[F12]**
- On the **Debug** toolbar, click on the drop-down arrow on the **Scripts** icon (the first icon on the left) and select the **Package Build Scripts** option
- Select the **Project | Execution Analyzer | Package Build Scripts** menu option, or
- Right-click on a package in the **Project Browser**, and select the **Execution Analyzer | Package Build Scripts** context menu option.

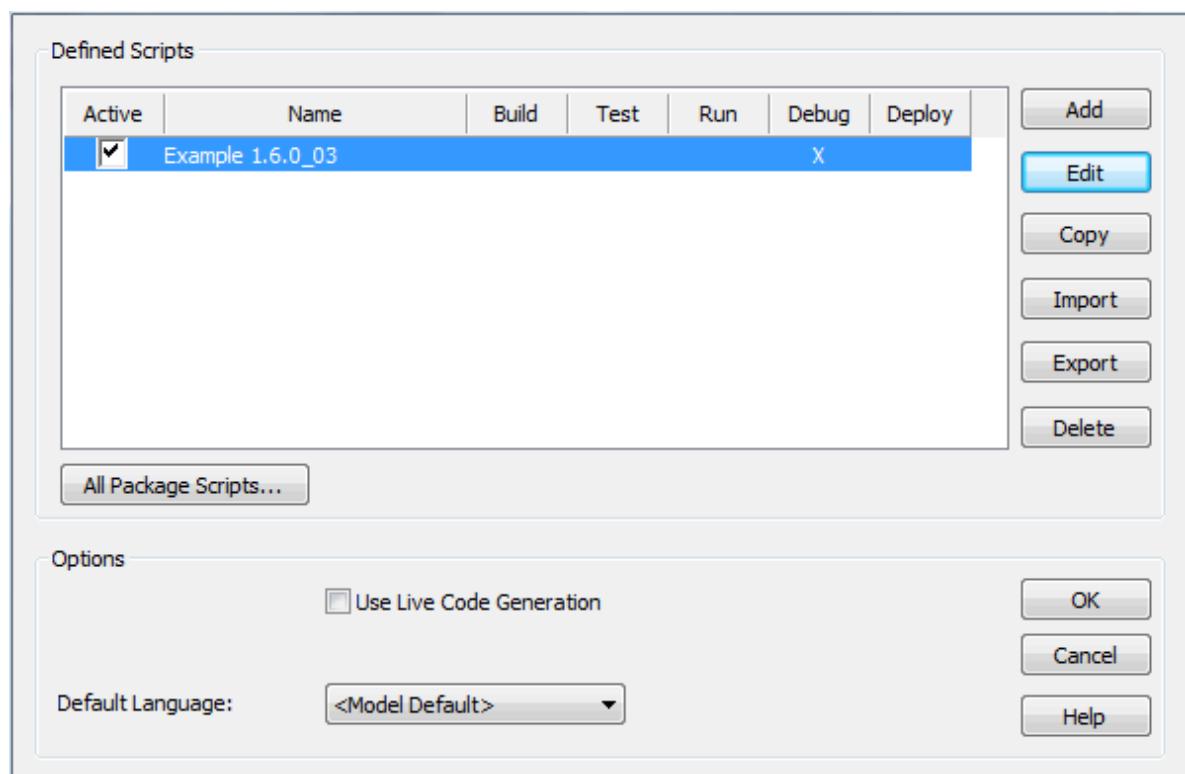

The **Package Build Scripts** dialog shows which script is active for the current package, and whether or not the script contains Build, Test, Run, Debug and Deploy components. The current package is as selected in the **Project Browser**; if a different package is selected, different scripts are available and different breakpoints and markers are applied.

Note that you must close the **Package Build Scripts** dialog to select a different package in the **Project Browser**. However, if the **Debug** window is open (**[Alt]+[8]**) you can see which debugging configuration is available and selected, and which breakpoints and markers are displayed, as you change packages in the **Project Browser**.

- To create a new script, click on the **Add** button; the **Build Script dialog** displays.
- To modify an existing script, highlight the script name in the list and click on the **Edit** button.
- To copy a script with a new name, highlight the script name to copy and click on the **Copy** button; Enterprise Architect prompts you to enter a name for the new copy. Enter the new name in the dialog and

click on the **OK** button. The new copy appears in the list and can be modified as usual.

- To delete a script, highlight the script name to delete, click on the **Delete** button, and click on the **OK** button.
- To export your scripts, click on the **Export** button to choose the scripts to export for this package.
- To import build scripts, click on the **Import** button to choose a .xml file of the scripts to import.

The **Default Language** field enables you to set the default language for generating source code for all new elements within this package and its descendents.

Select the **Use Live Code Generation** checkbox to update your source code instantly as you make changes to your model.

Click on the **All Package Scripts** button to open a new window that displays all scripts in the current project.

Once you have created new scripts or made changes to existing ones, click on the **OK** button to confirm the changes, otherwise click on the **Cancel** button to quit the **Package Build Scripts** dialog without saving any changes.

### 7.6.2.2 Defining Script Actions

Scripts are associated with a Package. When you create a Package Script you can define a number of actions.

If you plan to use any of the features of the Execution Analyzer, you must complete at least the **Build** and **Debug** tabs.

- [Build](#) <sup>[1443]</sup>
- [Debug](#) <sup>[1446]</sup>
- [Test](#) <sup>[1483]</sup>
- [Run](#) <sup>[1482]</sup>
- [Deploy](#) <sup>[1484]</sup>

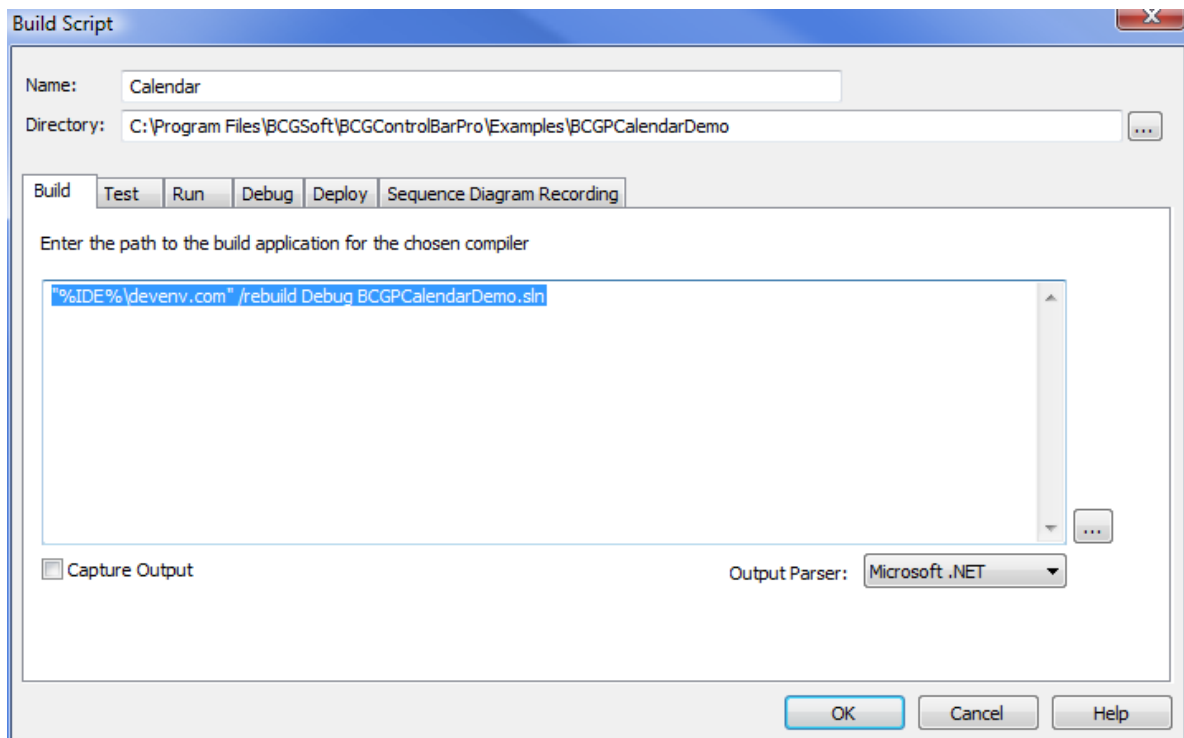

### 7.6.2.3 Setting the Default Script

Normally the target for any debugging session changes, tracking the package selected in the **Project Explorer**.

You can change this behaviour so that the scripts for a package remain selected in the **Debug** window. Use the context menu on the *Scripts* folder in the **Debug** window to either Pin or Unpin the currently-selected package.

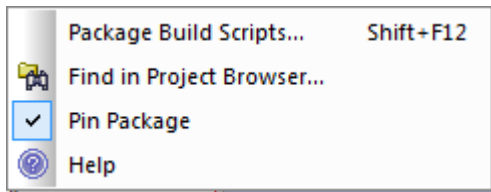

When a package is pinned, the **Debug** window always displays the scripts defined for that package, and the debugger always uses the selected Package Script.

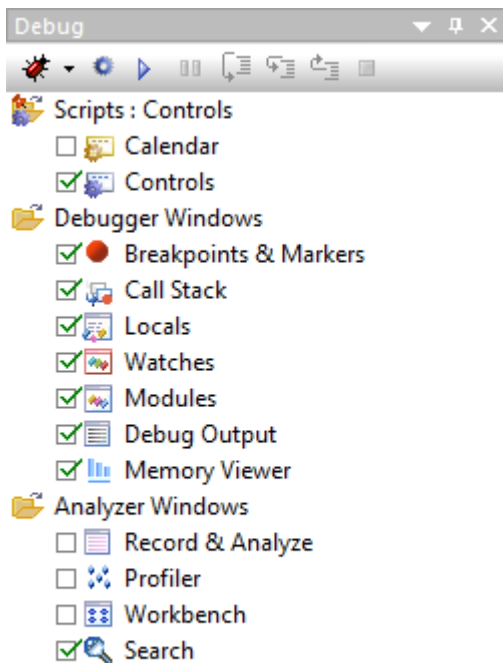

### 7.6.3 Code Editors

Enterprise Architect provides a number of editors that you can use to maintain scripts, code and templates. Specifically, these are the:

- [Shape Script Editor\\*](#)<sup>[1150]</sup>
- [Code Generation Template Editor\\*](#)<sup>[1305]</sup>
- [Transformation Template Editor\\*](#)<sup>[1412]</sup>
- [Custom SQL Search Filter Editor\\*](#)<sup>[1235]</sup>
- [Database View Editor\\*](#)<sup>[1032]</sup>
- [HTML Report Template Editor\\*](#)<sup>[1649]</sup>
- [Source Code Viewer\\*](#)<sup>[1441]</sup>
- [Script Editor\\*](#)<sup>[1435]</sup>

Each editor has its own features, but they are all based on a common *Code Editor control*.

You can have several code editors (or files within a code editor) open at the same time, as separate [tabs](#)<sup>[397]</sup>



in the central view area of the Enterprise Architect work area. You can also close the editors individually or all together, leaving views of other types (such as diagrams or RTF reports) still open.

The Code Editor provides a variety of functions to assist with the code editing process, including:

- [Syntax Highlighting](#) <sup>[1429]</sup>
- [Bookmarks](#) <sup>[1430]</sup>
- [Cursor history](#) <sup>[1430]</sup>
- [Brace matching](#) <sup>[1430]</sup>
- [Automatic indentation](#) <sup>[1431]</sup>
- [Commenting selections](#) <sup>[1431]</sup>
- [Scope guides](#) <sup>[1431]</sup>
- [Zooming](#) <sup>[1432]</sup>
- [Line selection](#) <sup>[1432]</sup>
- [intellisense](#) <sup>[1432]</sup>
- [File Search](#) <sup>[1485]</sup>

A range of these functions is available through keyboard key combinations and/or context menu options; see the [Code Editor Key Bindings](#) <sup>[1433]</sup> and [Code Editor Context Menu](#) <sup>[1437]</sup> topics.

You can customize several of the Code Editor features by setting properties in the Code Editor configuration files. For example, by default the line containing the cursor is always highlighted, but you can turn the highlighting off. For more information see the *Code Editor Configuration Guide*, located as a PDF file in the *Config* directory under your Enterprise Architect installation directory.

### 7.6.3.1 Syntax Highlighting

The Code Editor highlights - in colored text - the standard code syntax of most language file formats supported by Enterprise Architect, namely:

- Ada (.ada, .ads, .adb)
- ActionScript (.as)
- BPEL Document (.bpel)
- C++ (.h, .hh, .hpp, .c, .cpp, .cxx)
- C# (.cs)
- Delphi/Pascal (.pas)
- Diff/Patch Files (.diff, .patch)
- Document Type Definition (.dtd)
- DOS Batch Files (.bat)
- DOS Command Scripts (.cmd)
- HTML (.html)
- Interface Definition Language (.idl, .odl)
- Java (.java)
- Javascript (.javascript)
- JScript (.js)
- Modified Backus-Naur Form Grammar (.mbnf)
- PHP (.php, .php4, .inc)
- Python (.py)
- Standard Generalized Markup Language (.sgml)
- Structured Query Language (.sql)
- SystemC (.sc)
- Visual Basic 6 (.bas)
- VB.NET (.vb)
- VBScript (.vbs)
- Verilog (.v)
- VHSIC Hardware Description Language (.vhdl)
- Visual Studio Resource Configuration (.rc)
- eXtensible Markup Language (.xml)

You can [define](#) <sup>1338</sup> how the Code Editor implements syntax highlighting, through the [Code Editors](#) page of the [Options](#) dialog.

### 7.6.3.2 Bookmarks

Bookmarks denote a line of interest in the document. You can toggle them on and off for a particular line by pressing **[Ctrl]+[F2]**. Additionally, you can press **[F2]** and **[Shift]+[F2]** to navigate to the next or previous bookmark in the document.

In the following diagram, a bookmark has been set on line 17.

```

12
13 interface
14
15 type
16
17 TTestClass2 = class
18     private
19         FTestField: Integer;
20         m_Name: String;
21
22         function GetPublicPropertyTest2: string;
23         function PrivateFunctionTest: string;
24         procedure PrivateProcedureTest(a: Integer);
25         procedure SetPublicPropertyTest2(a: string);
26     protected
27         function GetPublishedPropertyTest4: Extended;
28         function ProtectedFunctionTest: boolean;
29         procedure ProtectedProcedureTest(a: WideString);
30         function SetPublishedPropertyTest4: Extended;
31     public
32         function GetName: String;
33         function ProtectedFunctionTest: Boolean;
34         function PublicFunctionTest: Word;
35         procedure PublicProcedureTest(a: Double);
36         procedure SetName(a: String);

```

### 7.6.3.3 Cursor History

The Code Editor Control keeps a history of the previous 50 cursor positions. An entry in the history list is created when:

- The cursor is moved more than 10 lines from its previous position
- The cursor is moved in a find/replace operation.

You can navigate to an earlier point in the cursor history by pressing **[Ctrl]+[-]**, and a later point by pressing **[Ctrl]+[Shift]+[-]**.

### 7.6.3.4 Brace Matching

When you place the cursor over a brace or bracket, the Code Editor highlights its corresponding partner. You can then navigate to the matching brace by pressing **[Ctrl]+[E]**.

```

27 |         function GetPublishedPropertyTest4: Extended;
28 |         function ProtectedFunctionTest: boolean;
29 |         procedure ProtectedProcedureTest(a: WideString);
30 |         function SetPublishedPropertyTest4: Extended;

```

### 7.6.3.5 Automatic Indentation

For each supported language, the Code Editor adjusts the indentation of a new line according to the presence of control statements or scope block tokens in the lines leading up to the cursor position.

For more information on customizing automatic indentation for a language, see the [Configuration](#) <sup>[1429]</sup> Guide.

### 7.6.3.6 Commenting Selections

For languages that support comments, the Code Editor can comment entire selections of code. The Code Editor recognizes two types of commenting:

- Line Commenting - entire lines are commented from the start (for example, // This is a comment)
- Stream Commenting - sections of a line are commented from a specified start point to a specified end point (for example, /\* This is a comment \*/).

You can toggle comments on the current line or selection by pressing **[Ctrl]+[Shift]+[C]** for line comments, or **[Ctrl]+[Shift]+[X]** for stream comments.

```

52 |     public DNSPacket processPacket(DNSPacket receivedPacket)
53 |     {
54 |         DNSPacket responsePacket = null;
55 |
56 |         switch ( receivedPacket.opCode )
57 |         {
58 |             case DNSConstants.OPCODE_QUERY :
59 |                 responsePacket = this.processQuery( receivedPacket );
60 |                 break;
61 |             // case DNSConstants.OPCODE_IQUERY :
62 |             // responsePacket = this.processInverseQuery( receivedPacket );
63 |             // break;
64 |             default :
65 |                 System.out.println("Ignoring packet due to unknown opCode "
66 |                                     + receivedPacket.opCode);
67 |                 break;
68 |         }
69 |
70 |         return responsePacket;
71 |     }

```

For more information on customizing selection commenting for each language, see the [Configuration](#) <sup>[1429]</sup> Guide.

### 7.6.3.7 Scope Guides

If the mouse is placed over an indentation marker, the Code Editor performs a 'look back' to find the line that started the scope at that indentation level. If the line is found and is currently on screen, it is highlighted in light blue.

```

93 |     // If there were any answers, then return a packet, if not then just return nul
94 |     // to indicate the server has no response
95 |     if ( answers.size() > 0 )
96 |     {
97 |         DNSPacket responsePacket = Helpers.createResponsePacket( answers, this.theS
98 |         responsePacket.queryID = receivedPacket.queryID;
99 |
100 |         return responsePacket;
101 |     }
102 |     else
103 |     {
104 |         return null;
105 |     }

```

Alternatively if the line is off screen, a calltip is displayed advising of the line number and contents.

```

93     // If there were any answers, then return a packet, if not then just return null
94     // to indicate the server has no response
95     if ( answers.size() > 0 )
96     Line 73: private DNSPacket processQuery(DNSPacket receivedPacket)
97         DNSPacket responsePacket = Helpers.createResponsePacket( answers, this.theSt
98         responsePacket.queryID = receivedPacket.queryID;
99
100        return responsePacket;
101    }
102    else
103    {
104        return null;
105    }

```

### 7.6.3.8 Zooming

You can zoom into and out of the contents of the Code Editor using **[Ctrl]+mousewheel** or **[Ctrl]+keypad[+]** / **[Ctrl]+keypad[-]**.

Zoom can be restored to 100% by using **[Ctrl]+keypad[/]**.

### 7.6.3.9 Line Selection

If you want to move the cursor to a specific line of code, press **[Ctrl]+[G]** and, in response to the prompt, type in the line number. Press the **OK** button. The editor displays the specified line of code with the cursor at the left.

### 7.6.3.10 Intellisense

Intellisense is a feature that provides choices of code items and values as you type. Not all code editors use intellisense; those that do are indicated by an asterisk in the [list](#)<sup>[1428]</sup> of Enterprise Architect code editors. Intellisense provides you with context-based assistance through autocompletion lists, calltips and mouseover information.

Intellisense is also disabled while you record a macro in the [Source Code Viewer](#)<sup>[1443]</sup>.

## Autocompletion List

An autocompletion list provides a list of possible completions for the current text. The list is automatically invoked when you enter an accessor token (such as a period or pointer accessor) after an object or type that contains members.

```

57     public void memoryRecall ()
58     {
59         this.
60     }
61
62     public
63
64     }
65
66     public
67     {
68         in
69         re
70     }
71

```

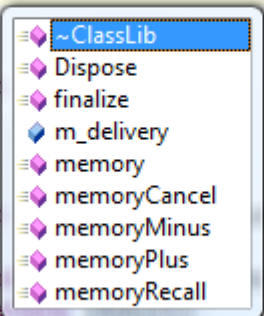

You can also invoke the autocompletion list manually by pressing **[Ctrl]+[Spacebar]**; the Code Editor then searches for matches for the word leading up to the invocation point.

Select an item from the list and press **[Enter]** or **[Tab]** to insert the item into the code. To dismiss the autocompletion list, press **[Escape]**.

### Calltips

Calltips display the current method's signature when you type the parameter list token (for example, opening parenthesis). If the method is overloaded, the calltip displays arrows that you can use to navigate through the different method signatures.

```

20      //PostDraw Adornments
21      //Stereotyped Static Adornments
22      //Add Stakeholder's STAKE
23      setpenwidth(
24          // Add a the SetPenWidth(int penwidth)
25      startpath();
26          moveto(25,37);
27          lineto(25,52);
28      endpath();
29      strokepath();
30      //Add tip
    
```

### Mouseover Information

You can display supporting documentation for code elements (for example, attributes and methods) by hovering the cursor over the element in question.

```

11      dockable = "none";
12      string
13      / Dock elements together. Tagged V
14      / Valid Values: none, standard
15      //PreDraw Derived Attribute I
    
```

#### 7.6.3.11 Code Editor Key Bindings

**Note:**

In addition to the following keys, you can [assign](#)<sup>[1338]</sup> **[Ctrl]+[Alt]+[n]** key combinations to macros that you [define](#)<sup>[1442]</sup> within the **Source Code Editor**.

Key	Description
<b>[Ctrl]+[G]</b>	Move cursor to a specified line
<b>[↓]</b>	Move cursor down one line
<b>[Shift]+[↓]</b>	Extend selection down one line
<b>[Ctrl]+[↓]</b>	Scroll down one line
<b>[Alt]+[Shift]+[↓]</b>	Extend rectangular selection down one line
<b>[↑]</b>	Move cursor up one line
<b>[Shift]+[↑]</b>	Extend selection up one line

Key	Description
[Ctrl]+[↑]	Scroll up one line
[Alt]+[Shift]+[↑]	Extend rectangular selection up one line
[Ctrl]+[ [ ]	Move cursor up one paragraph
[Ctrl]+[Shift]+[ [ ]	Extend selection up one paragraph
[Ctrl]+[ ] ]	Move cursor down one paragraph
[Ctrl]+[Shift]+[ ] ]	Extend selection down one paragraph
[←]	Move cursor left one character
[Shift]+[←]	Extend selection left one character
[Ctrl]+[←]	Move cursor left one word
[Ctrl]+[Shift]+[←]	Extend selection left one word
[Alt]+[Shift]+[←]	Extend rectangular selection left one character
[→]	Move cursor right one character
[Shift]+[→]	Extend selection right one character
[Ctrl]+[→]	Move cursor right one word
[Ctrl]+[Shift]+[→]	Extend selection right one word
[Alt]+[Shift]+[→]	Extend rectangular selection right one character
[Ctrl]+[/]	Move cursor left one word part
[Ctrl]+[Shift]+[/]	Extend selection left one word part
[Ctrl]+[\\]	Move cursor right one word part
[Ctrl]+[Shift]+[\\]	Extend selection right one word part
[Home]	Move cursor to the start of the current line
[Shift]+[Home]	Extend selection to the start of the current line
[Ctrl]+[Home]	Move cursor to the start of the document
[Ctrl]+[Shift]+[Home]	Extend selection to the start of the document
[Alt]+[Home]	Move cursor to the absolute start of the line
[Alt]+[Shift]+[Home]	Extend rectangular selection to the start of the line

Key	Description
[End]	Move cursor to the end of the current line
[Shift]+[End]	Extend selection to the end of the current line
[Ctrl]+[End]	Move cursor to the end of the document
[Ctrl]+[Shift]+[End]	Extend selection to the end of the document
[Alt]+[End]	Move cursor to the absolute end of the line
[Alt]+[Shift]+[End]	Extend rectangular selection to the end of the line
[Page Up]	Move cursor up a page
[Shift]+[Page Up]	Extend selection up a page
[Alt]+[Shift]+[Page Up]	Extend rectangular selection up a page
[Page Down]	Move cursor down a page
[Shift]+[Page Down]	Extend selection down a page
[Alt]+[Shift]+[Page Down]	Extend rectangular selection down a page
[Delete]	Delete character to the right of the cursor
[Shift]+[Delete]	Cut selection
[Ctrl]+[Delete]	Delete word to the right of the cursor
[Ctrl]+[Shift]+[Delete]	Delete until the end of the line
[Insert]	Toggle overtype
[Shift]+[Insert]	Paste
[Ctrl]+[Insert]	Copy selection
[Backspace]	Delete character to the left of the cursor
[Shift]+[Backspace]	Delete character to the left of the cursor
[Ctrl]+[Backspace]	Delete word to the left of the cursor
[Ctrl]+[Shift]+[Backspace]	Delete from the start of the line to the cursor
[Alt]+[Backspace]	Undo delete
[Tab]	Indent cursor one tab
[Ctrl]+[Shift]+[I]	Indent cursor one tab

Key	Description
[Shift]+[Tab]	Unindent cursor one tab
[Ctrl]+keypad[+]	Zoom in
[Ctrl]+keypad[-]	Zoom out
[Ctrl]+keypad[/]	Restore Zoom
[Ctrl]+[Z]	Undo
[Ctrl]+[Y]	Redo
[Ctrl]+[X]	Cut selection
[Ctrl]+[C]	Copy selection
[Ctrl]+[V]	Paste
[Ctrl]+[L]	Cut line
[Ctrl]+[Shift]+[L]	Delete line
[Ctrl]+[T]	Transpose line
[Ctrl]+[Shift]+[T]	Copy line
[Ctrl]+[A]	Select entire document
[Ctrl]+[D]	Duplicate selection
[Ctrl]+[U]	Convert selection to lowercase
[Ctrl]+[Shift]+[U]	Convert selection to uppercase
[Ctrl]+[E]	Move cursor to matching brace
[Ctrl]+[Shift]+[E]	Extend selection to matching brace
[Ctrl]+[Shift]+[C]	Toggle line comment on selection
[Ctrl]+[Shift]+[X]	Toggle stream comment on selection
[Ctrl]+[F2]	Toggle bookmark
[F2]	Go to next bookmark
[Shift]+[F2]	Go to previous bookmark



Key	Description
[Ctrl]+[Shift]+[W]	Toggle whitespace characters
[Ctrl]+[Shift]+[L]	Toggle EOL characters
[Ctrl]+[Spacebar]	Invoke autocomplete
[Ctrl]+[-]	Go backwards in cursor history
[Ctrl]+[Shift]+[-]	Go forwards in cursor history
[F12]	Start/Cancel search for keyword in file(s).
[Ctrl]+[F]	Find text
[Ctrl]+[R]	Replace

### 7.6.3.12 Code Editor Context Menu

When working on a file with a code editor, you can access a number of options through the context menu. Right-click on a text string to display the menu.

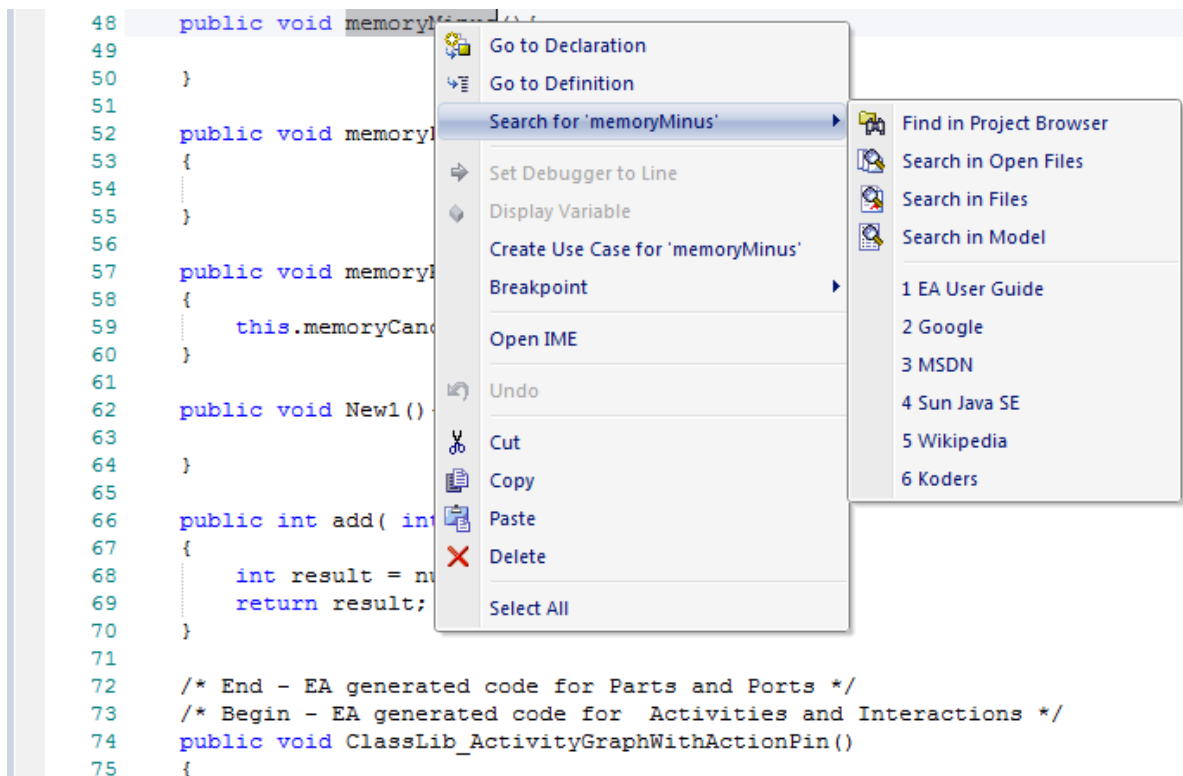

The first six context menu options provide simple editing functions. Other options on the menu can vary depending on [which editor](#)<sup>[1428]</sup> you are using, but should include most or all of the following:

- **Search for '<string>'** - Displays a submenu that enables you to locate the search string in a range of locations:
  - **Find in Project Browser** finds the object containing the selected text in the **Project Browser**

- **Go to Declaration** locates the declaration of a symbol in the source code
- **Go to Definition** locates the definition of a symbol in the source code (applicable to languages where symbols are declared and defined in separate places e.g. C++, Delphi)
- **Search in Open Files** opens the Execution Analyzer [File Search](#)<sup>[1485]</sup> facility, then searches for the selected text string in other code files of the same type and in the same folder as the current file that are open, displaying the results in *Tree View*; you can change the folder path, search text and file type as required within the **File Search** window
- **Search in Files** performs the same search as **Search in Open Files**, except that the search is in all comparable files whether they are open or not
- **Search in Model** performs an [Element Name](#)<sup>[1241]</sup> search in the [Model Search](#)<sup>[1231]</sup> facility, and displays the results on the **Model Search** tab
- **EA User Guide** displays the description of the code item in the *Enterprise Architect User Guide*
- **Google** displays the results of a search on the text from a Google search
- **MSDN** displays the results of a search on the text in the Microsoft Developer Network (MSDN)
- **Sun Java SE** displays the results of a search on the text in the Sun Microsystems 'Sun Search' facility
- **Wikipedia** displays any entry on the object on the Wikipedia web site.
- **Koders** displays the results of the search for the text string on *Koders.com*

#### Note:

The options in the lower half of the menu (after **Search in Model**) are configurable. You can add new search tools or remove existing ones by editing the *searchProviders.xml* file in the *Sparx Systems > EA > Config* folder. This file is in [OpenSearch description document format](#).

- **Open (Close) IME** - opens the *Input Method Editor* to enable you to enter text in your selected foreign language script (such as Japanese); you set the keyboard language using the *Windows Control Panel - Regional and Language Options* facility
- **Line Numbers** - shows or hides the line numbers against the lines of code
- **Structure Tree** - (in the **Source Code** viewer only) shows or hides the element hierarchy panel
- **Set Debugger to Line** - (if the debugger is executing and has reached a breakpoint) moves the execution point to the current line; ensure that you do not skip over any code or declarations that affect the next section of code being debugged
- **Display Variable** - (if the debugger is executing) opens the [Locals](#)<sup>[1474]</sup> window and highlights the local variable for the current point in the code.

## Script Editor

If you select the **Search for '<string>'** context menu option while working in the [Script Editor](#)<sup>[1439]</sup>, a slightly different submenu displays:

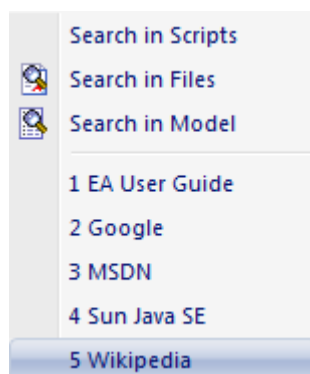

The **Search in Scripts** option opens the Execution Analyzer [File Search](#)<sup>[1485]</sup> facility, setting the **Search Path** field to **Search in Scripts** and the **Search Text** field to the selected text, then searching all scripts for the text string and displaying the results of the search in *Tree View*.

### 7.6.3.13 Script Editor

The *Script Editor* enables you to edit scripts, and to run and stop an open script.

**Note:**

This facility is available in the Corporate, Business and Software Engineering, Systems Engineering and Ultimate editions.

The editor is based on, and provides the facilities of, the common [Code Editor](#)<sup>[1428]</sup>.

To open the Script Editor, double-click on the required script in the **Scripts** tab of the [Scripter window](#)<sup>[1667]</sup>. The editor opens in the main work area.

The VBScript example below is a script that iterates all the packages in the current model and prints their names.

**Note:**

In the example, note the syntax of declaring variables representing Enterprise Architect's script objects. This syntax enables the editor to present [intellisense](#)<sup>[1440]</sup>, but is not necessary for executing the script.

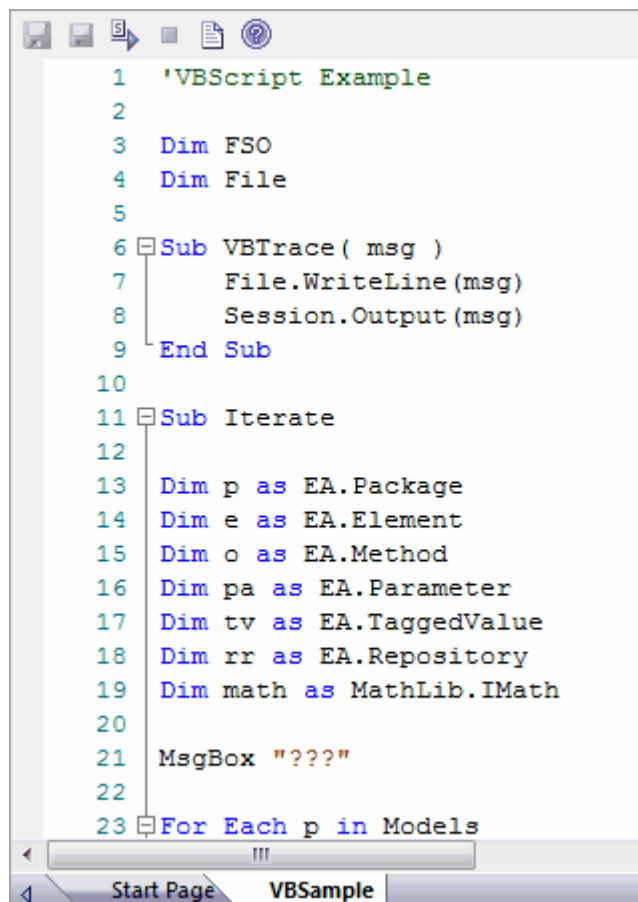

```
1 'VBScript Example
2
3 Dim FSO
4 Dim File
5
6 Sub VBTrace( msg )
7     File.WriteLine (msg)
8     Session.Output (msg)
9 End Sub
10
11 Sub Iterate
12
13 Dim p as EA.Package
14 Dim e as EA.Element
15 Dim o as EA.Method
16 Dim pa as EA.Parameter
17 Dim tv as EA.TaggedValue
18 Dim rr as EA.Repository
19 Dim math as MathLib.IMath
20
21 MsgBox "???"
22
23 For Each p in Models
```

The toolbar options enable you to:

- Save changes to the current script
- Save the current script under a different name
- Run the script
- Stop the executing script
- View the script output in the **Scripts** tab of the **Output** window.

## Enterprise Architect Script Objects

Enterprise Architect adds to the available functionality and features of the editor script language by providing inbuilt objects. These are either *Type Libraries*, providing intellisense for editing purposes, or *Runtime objects*, providing access to objects of the types described in the Type Libraries.

The available intellisense scripting objects are:

- EA
- MathLib
- System
- The runtime scripting objects (below).

The available runtime scripting objects are:

- Repository [Type: IDualRepository] - this is the Enterprise Architect [automation interface](#) <sup>1668</sup>
- Maths [Type: IMath ]
- Session [Type: ISession ].

## Script Editing Intellisense (Required Syntax)

Intellisense is available not only in the Script Editor, but also in the Script Console. Intellisense at its most basic is presented for the inbuilt functionality of the script engine. For intellisense on the additional Enterprise Architect scripting objects listed above, you must declare variables according to syntax that specifies a type. It is not necessary to use this syntax to execute a script properly. It is only present so that the correct intellisense can be displayed for an item. The syntax can be seen in the above diagram in, for example:

```
Dim e as EA.Element
```

Then, when you type, in this case, **e.** the editor displays a list of member functions and properties of **e**'s type.

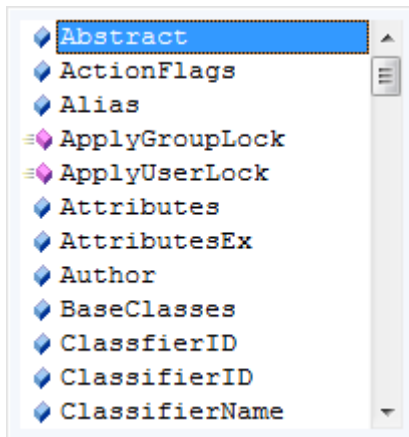

You select one of these to complete the line of script. You might, therefore, type:

```
VBTrace( e.
```

As you type the period, the editor presents the appropriate list and you might double-click on, for example, **Abstract**. This is inserted in the line, and you continue to type or select the rest of the statement. In this case, adding the end space and parenthesis.

```
VBTrace( e.Abstract )
```

### Keystrokes

In the Script Editor or Console, intellisense is presented on the following keystrokes.

- Press **[.]** (period) after an item to list any members for that item's type.
- Press **[Ctrl]+[Spacebar]** on a word to list any intellisense items with a name starting with the string at the point keystroke was pressed.
- Press **[Ctrl]+[Spacebar]** when not on a word to display any available top level intellisense items - these are the intellisense objects described above plus any built-in methods and properties of the current scripting language.

### 7.6.3.14 The Source Code Viewer

Access: **View | Other Element Tools | Source Code.**

Use the **Source Code** viewer to view any source code files for an element. If a Class is selected, the **Source Code** viewer shows the source code for that Class, provided it has already been [generated](#)<sup>[1308]</sup>. For C++ a second tab displays to show the implementation file.

The **Source Code** viewer also displays any DDL generated for a selected table in your diagram.

#### Note:

You view source code for an element by selecting menu options in a number of places, or by pressing either **[Ctrl]+[E]** or **[F12]**. If the element does not have a generation file (that is, code has not been or cannot be generated, such as for a Use Case), Enterprise Architect checks whether the element has a [link](#)<sup>[617]</sup> to either an operation or an attribute of another element. If such a link exists, and that other element has source code, the code for that element displays.

A number of options change the way the **Source Code** viewer works. They can be altered via the **Options** dialog (select the **Tools | Options | Source Code Engineering | Code Editors**<sup>[1337]</sup> menu option). There are also many options for developing the code, available through the code editor [context menu](#)<sup>[1437]</sup> and through the [Toolbar](#)<sup>[1442]</sup>.

By default the **Source Code** viewer is set to:

- Parse all opened files, and show a tree of the results
- Show line numbers.

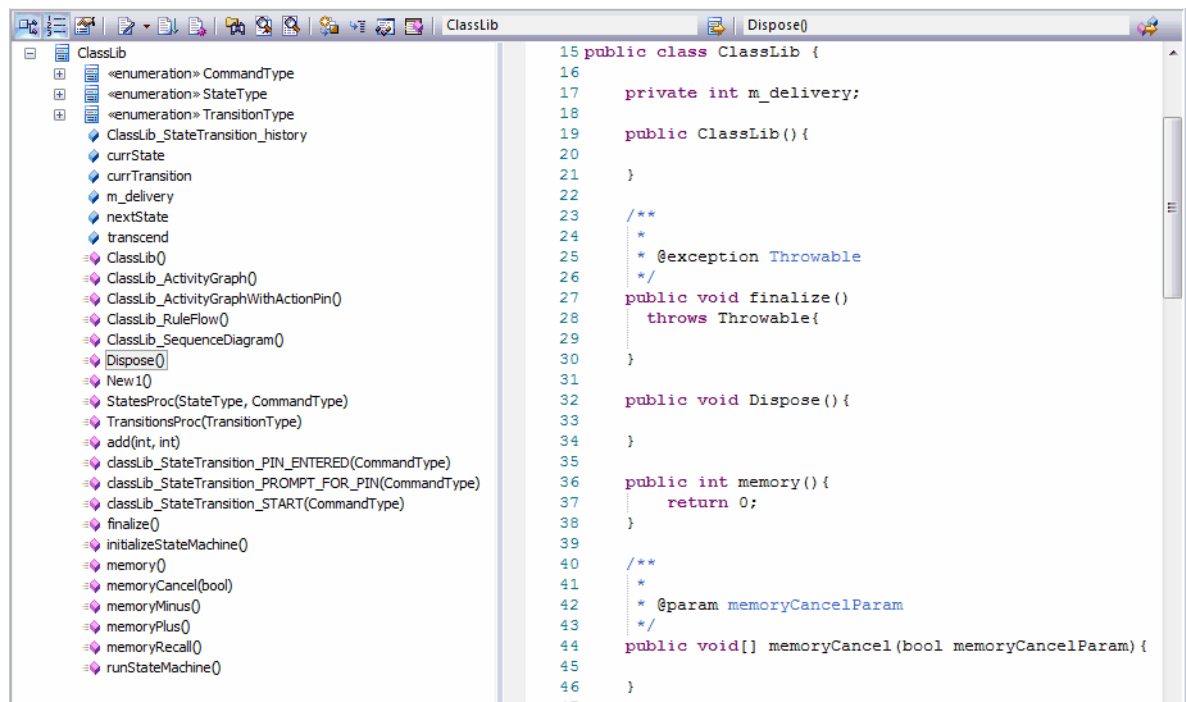

If you are editing an XML file, the structure tree is presented in a folder hierarchy rather than a Class structure hierarchy, as follows:

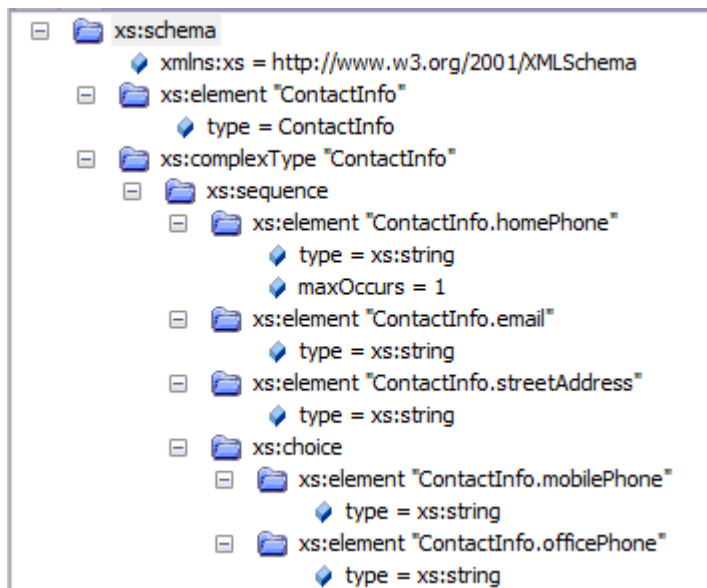

### External File Editor

If you intend to edit external code, XML and DDL files (that is, code not selected from the **Project Browser**) use the **File | Open Source File** menu option, or press **[Ctrl]+[Alt]+[O]**.

If you try to close the window or select another file, the editor prompts you to save your changes.

### File Parsing

The **Source Code** viewer parses files for a number of reasons. The first is to enable it to jump to the location in the file at which the currently selected item is found (but not when editing external files).

Additionally, parsing displays a structure tree showing an overview of the file in a similar fashion to the main **Project Browser**. You can also select anything in that and jump to the appropriate line in the editor.

The viewer cannot parse DDL, and therefore does not show the structure tree for a DDL file.

#### 7.6.3.14.1 Source Code Viewer Toolbar

The toolbar buttons in the **Source Code** viewer enable you to edit, view and interact with the code contained in the **Source Code** viewer. The function of each button, from left to right, is described below:



- **Structure Tree** - shows or hides the element hierarchy panel (the left panel of the **Source Code** viewer)
- **Line Numbers** - shows or hides the line numbers against the lines of code
- **Source Code Engineering Properties** - displays the [Source Code Engineering](#) <sup>1336</sup> page of the **Options** dialog, from which you can configure display and behavior options for source code engineering
- **Editor Functions** - provides quick access to the following functions:
  - **Open Corresponding File** - opens the header or implementation file associated with the currently-open file
  - **Go to Matching Brace** - for a selected opening or closing brace, highlights the corresponding closing or opening brace in the pair
  - **Go to Line** - displays a small dialog on which you select the number of the line to highlight; click on the **OK** button to move the cursor to that line
  - **Cursor History Previous** - the **Source Code** viewer keeps a history of the previous 50 cursor positions, creating a record when the cursor is moved either more than 10 lines away from its previous position, or in a find-and-replace operation; the menu option moves the cursor to the position in the immediately-previous cursor history record
  - **Cursor History Next** - moves the cursor to the position in the immediately-following cursor history record

- **Record Macro** - record the subsequent keystrokes to be saved as a macro
- **Stop Recording and Save Macro** - stop recording the keystrokes and specify a name for the macro, on the **Save Macro** dialog
- **Play Macro** - execute the macro to repeat the saved keystrokes, if necessary selecting the macro from the **Open Macro** dialog

**Notes:**

- The **Record Macro** function disables **Intellisense** while the macro is being recorded.
- You can **assign key strokes** to execute the macro, instead of using the toolbar drop-down and **Open Macro** dialog.
- **Toggle Line Comment** - comments out (//) or re-establishes the code for each full line in which text is highlighted
- **Toggle Stream Comment** - inserts a stream comment (/\* \*/) at the cursor position or comments out the highlighted characters and lines, or re-establishes the commented text as code
- **Toggle Whitespace Characters** - shows or hides the spacing characters: --> (tab space) and · (character space)
- **Toggle EOL Characters** - shows or hides the end-of-line characters: **CR** (carriage return) and **LF** (line feed)
- **Save Source and Resynchronize Class** - saves the source code and resynchronizes the Class
- **Code Templates** - accesses the **Code Templates Editor**
- **Find in Project Browser** - for a selected line of code, highlights the appropriate structure in the **Project Browser**; if there is more than one possibility the **Possible Matches** dialog displays, listing the occurrences of the appropriate structure from which you can select the required one
- **Search in Files** - searches for the selected object name in associated files and displays the results of the search on the **File Search** window
- **Search in Model** - searches for the selected text throughout the model, and displays the results of the search on the **Model Search** window.
- **Go to Declaration** - locates the declaration of a symbol in the source code
- **Go to Definition** - locates the definition of a symbol in the source code (applicable to languages where symbols are declared and defined in separate files e.g. C++, Delphi)
- **Autocomplete List** - displays the autocompletion list of possible values; double-click on a value to select it
- **Parameter Information** - when the cursor is between the parentheses of an operation's parameter list, displays the operation's signature, highlighting the current parameter
- **Find Current Class in Project Browser** - displays the name of the currently-selected Class in the code, and highlights that name in the **Project Browser**; if there is more than one possibility the **Possible Matches** dialog displays, listing the occurrences of the Class from which you can select the required one
- **Find Member** - displays the name of the currently-selected attribute or method in the code, and highlights that name in the **Project Browser**; if there is more than one possibility the **Possible Matches** dialog displays, listing the occurrences of the feature from which you can select the required one.

## 7.6.4 Build

The topics in this section describe how you specify the commands to build the project / package:

- [Add Comands](#)
- [Recursive Builds](#)

### 7.6.4.1 Add Commands

The **Build** tab enables you to enter multiple commands for building the current package. These commands are executed when you select the **Project | Execution Analyzer | Build** menu option. The following examples are for Java and .NET respectively.

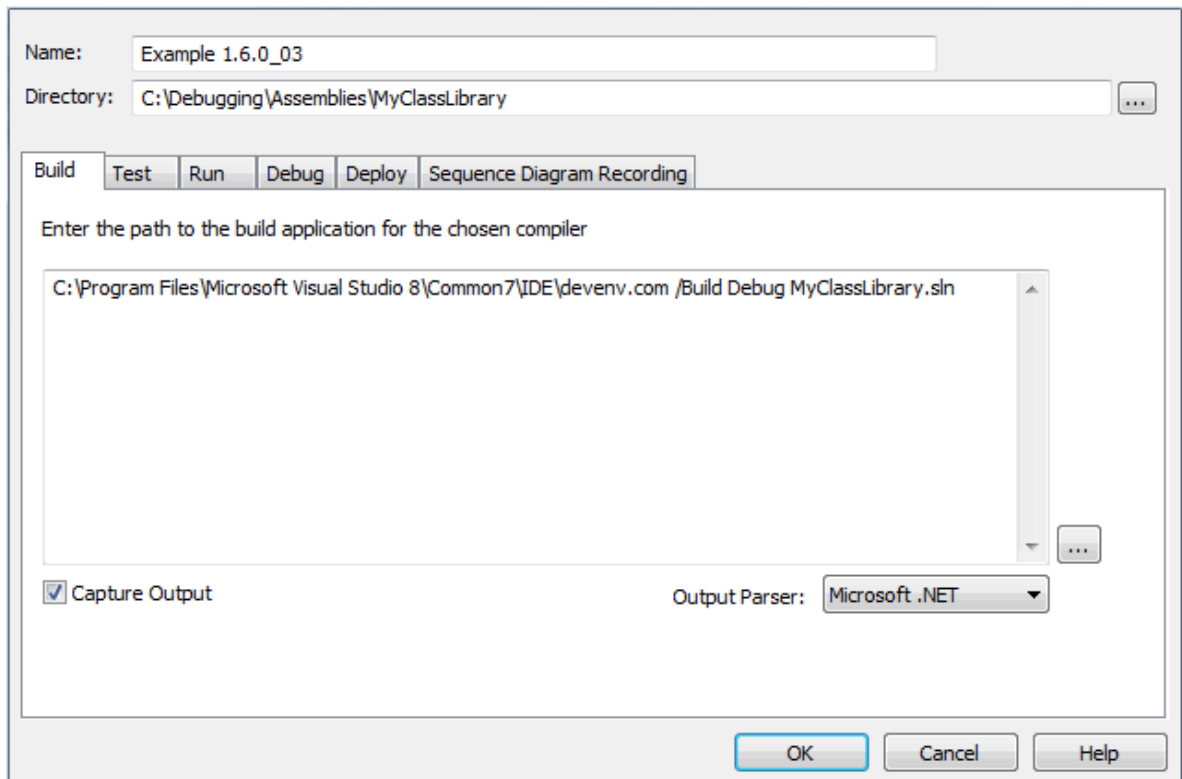
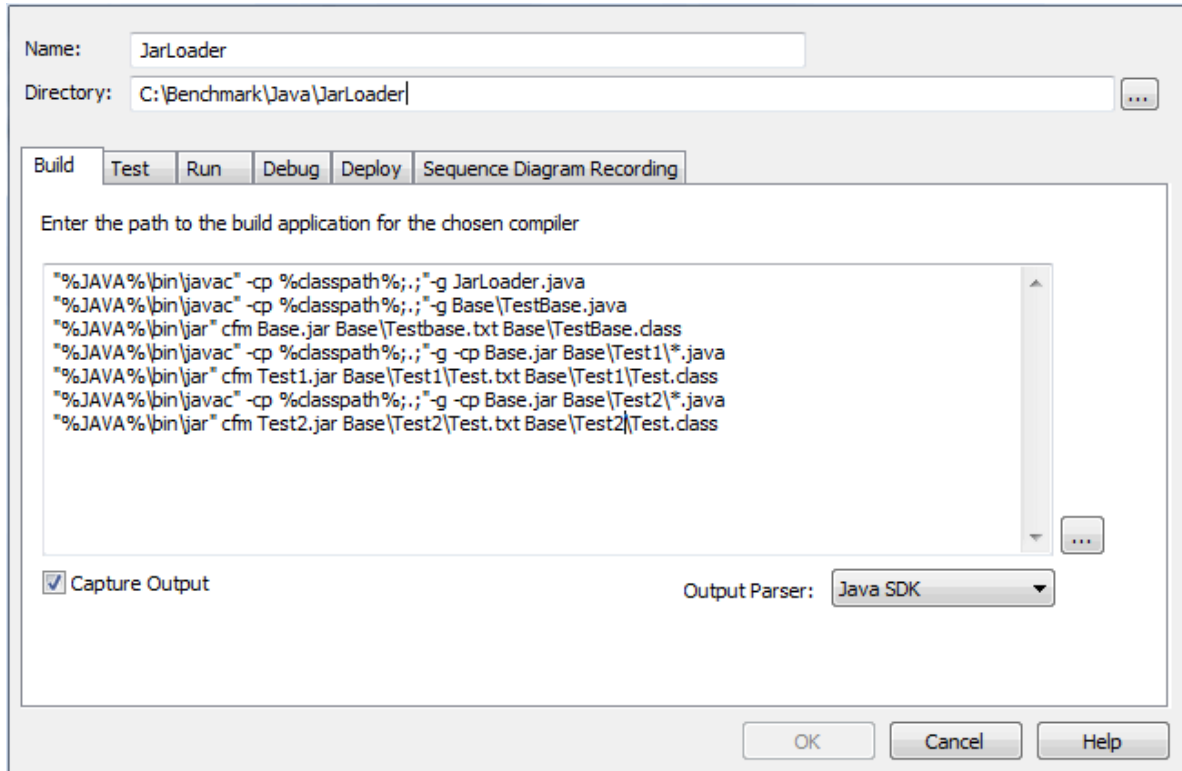



Write your script in the large text box using the standard *Windows Command Line* commands. You can specify, for example, compiler and linker options, and the names of output files. The format and content of this section depends on the actual compiler, make system, linker and so on that you use to build your project. You can also wrap up all these commands into a convenient batch file and call that here instead.

If you select the **Capture Output** checkbox, output from the script is logged in Enterprise Architect's **Output** window. This can be activated by selecting the **View | System Output** menu option.

The **Output Parser** field enables you to define a method for automatically parsing the compiler output. If you have selected the **Capture Output** checkbox, Enterprise Architect parses the output of the compiler so that by clicking on an error message in the **Output** window, you directly access the corresponding line of code.

#### Notes:

- The command listed in this field is executed as if from the command prompt. Therefore, if the executable path or any arguments contain spaces, they must be surrounded by quotes.
- Throughout this dialog, you can use [Local Paths](#) <sup>[1343]</sup> in specifying paths to executables.

When you run the compile command inside Enterprise Architect, output from the compiler is piped back to the **Output** window and displayed as in the following illustration:

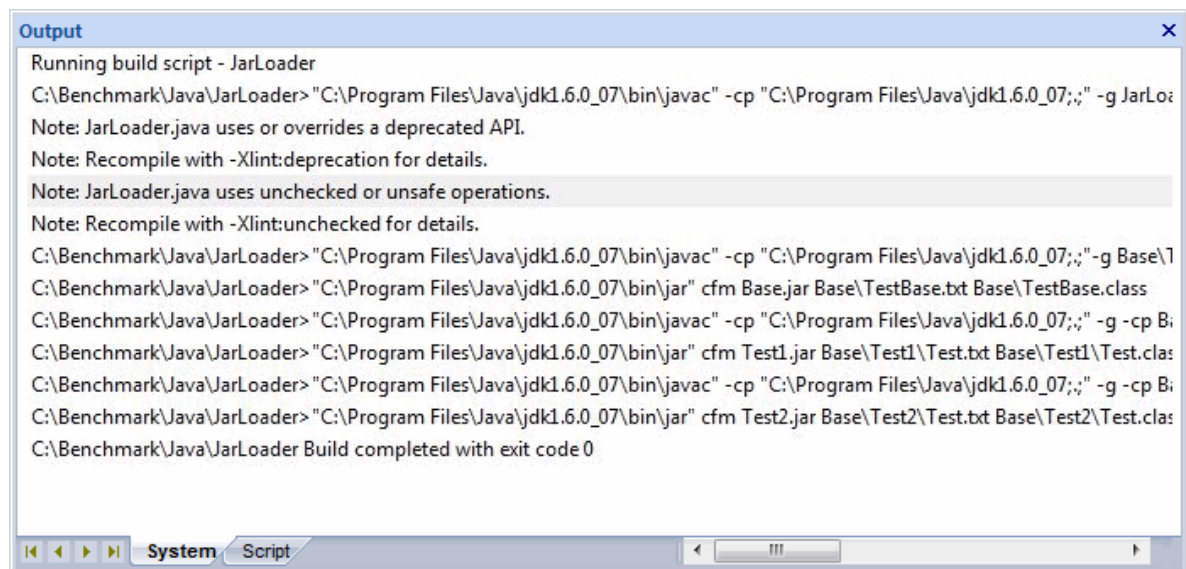

```
Output
Running build script - JarLoader
C:\Benchmark\Java\JarLoader>"C:\Program Files\Java\jdk1.6.0_07\bin\javac" -cp "C:\Program Files\Java\jdk1.6.0_07\;" -g JarLo:
Note: JarLoader.java uses or overrides a deprecated API.
Note: Recompile with -Xlint:deprecation for details.
Note: JarLoader.java uses unchecked or unsafe operations.
Note: Recompile with -Xlint:unchecked for details.
C:\Benchmark\Java\JarLoader>"C:\Program Files\Java\jdk1.6.0_07\bin\javac" -cp "C:\Program Files\Java\jdk1.6.0_07\;" -g Base\1
C:\Benchmark\Java\JarLoader>"C:\Program Files\Java\jdk1.6.0_07\bin\jar" cfm Base.jar Base\TestBase.txt Base\TestBase.class
C:\Benchmark\Java\JarLoader>"C:\Program Files\Java\jdk1.6.0_07\bin\javac" -cp "C:\Program Files\Java\jdk1.6.0_07\;" -g -cp B:
C:\Benchmark\Java\JarLoader>"C:\Program Files\Java\jdk1.6.0_07\bin\jar" cfm Test1.jar Base\Test1\Test.txt Base\Test1\Test.clas
C:\Benchmark\Java\JarLoader>"C:\Program Files\Java\jdk1.6.0_07\bin\javac" -cp "C:\Program Files\Java\jdk1.6.0_07\;" -g -cp B:
C:\Benchmark\Java\JarLoader>"C:\Program Files\Java\jdk1.6.0_07\bin\jar" cfm Test2.jar Base\Test2\Test.txt Base\Test2\Test.clas
C:\Benchmark\Java\JarLoader Build completed with exit code 0
```

If you double-click on an error line, Enterprise Architect loads the appropriate source file and positions the cursor on the line where the error has been reported.

### 7.6.4.2 Recursive Builds

For any project you can apply the command entered in the build script to all sub folders of the initial directory by specifying the token `%r` immediately preceding the files to be built. The effect of this is Enterprise Architect iteratively replaces the token with any subpath found under the root and executes the command again.

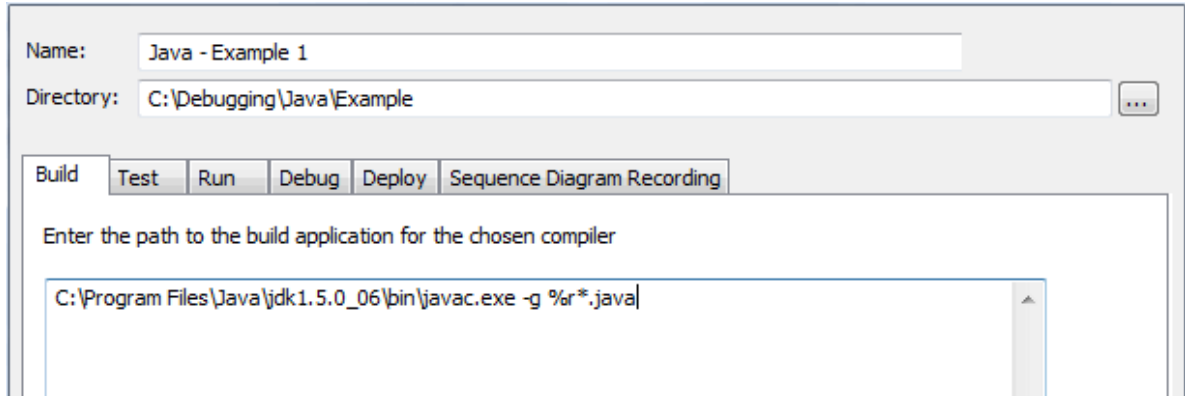

The output from this Java example is shown below:

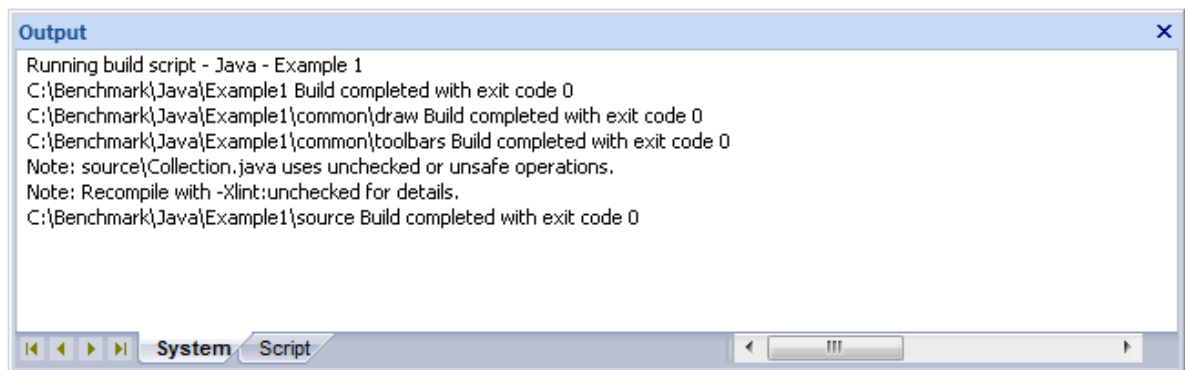

#### Note:

The path being built is displayed along with the exit code.

## 7.6.5 Debugging

This section describes how you define the debugging actions:

- [How it works](#) <sup>[1446]</sup>
- [Setup for Debugging](#) <sup>[1447]</sup>
- [Breakpoint and Marker Management](#) <sup>[1468]</sup>
- [Debugging Actions](#) <sup>[1470]</sup>
- [Recording Actions](#) <sup>[1480]</sup>

### 7.6.5.1 How it Works

The Model Driven Development Environment provides Debuggers for the following frameworks:

- Microsoft Native Code applications
- Microsoft .NET applications
- Java applications

To begin debugging:

1. Ensure the model is open.
2. Ensure [Basic Setup](#) <sup>[1425]</sup> has been completed for the Package or Project.

3. Ensure any source code for the areas of interest have been generated, or imported into the Model.
4. Ensure the application has been built. You can do this internally using the [Build](#) Script or you can build the application externally. The important thing is that the application is built on the latest versions of the source.
5. Ensure that the model and source are [synchronized](#).
6. [Set breakpoints](#).
7. [Start](#) the Debugger.

### 7.6.5.2 Setup for Debugging

To begin debugging you must specify

- The Debugger to use
- The Application path
- Runtime options, if applicable

The following example shows a .NET Debug script.

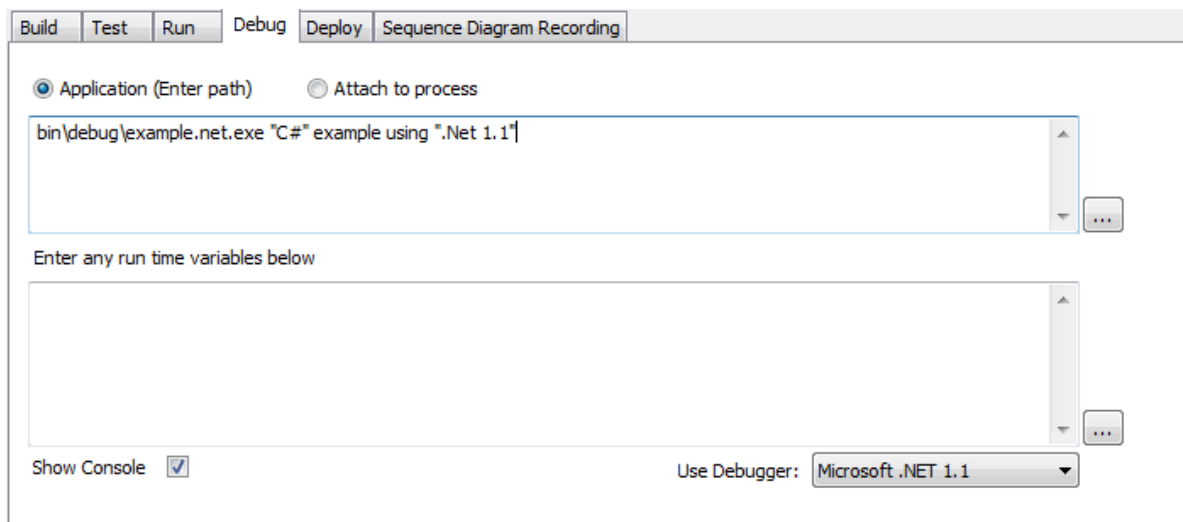

#### 7.6.5.2.1 Operating System Specific Requirements

##### Important:

Please read the information provided in this topic.

### Prerequisites

Creation of a Package Build Script and configuration of the **Debug** command in that script.

### Supported Platforms

Enterprise Architect supports debugging on these platforms:

#### .Net

- Microsoft™ .NET Framework 1.1 and later
- Language support: C, C#, C++, J#, Visual Basic

#### Note:

Debugging under Windows Vista (x64) - If you encounter problems debugging with Enterprise Architect on a 64-bit platform, you should build a Win32 platform configuration in Visual Studio; that is, do not specify **ANY-CPU**, specify **WIN32**.

### Java

- Java 2 Platform Standard edition (J2SE) version 5.0
- J2EE JDK 1.4 and above
- Requires previous installation of the Java Runtime Environment and Java Development Kit from Sun Microsystems™.

Debugging is implemented through the Java Virtual Machine Tools Interface (JVMTI), which is part of the Java Platform Debugger Architecture (JPDA). The JPDA is included in the J2SE SDK 1.3 and later.

### Windows for Native Applications

Enterprise Architect supports debugging native code (C, C++ and Visual Basic) compiled with the Microsoft™ compiler where an associated PDB file is available. Select **Microsoft Native** from the list of debugging platforms in your package script.

You can import native code into your model, and record the execution history for any Classes and methods. You can also generate Sequence diagrams from the resulting execution path.

#### Note:

Enterprise Architect currently does not support remote debugging.

#### 7.6.5.2.1.1 UAC-Enabled Operating Systems

The Microsoft operating systems *Windows Vista* and *Windows 7* provide User Account Control (UAC) to manage security for applications.

The Enterprise Architect Visual Execution Analyser is UAC-compliant, and users of UAC-enabled systems can perform operations with the Visual Execution Analyser and related facilities under accounts that are members of only the *Users* group.

However, when attaching to processes running as services on a UAC-enabled operating system, it might be necessary to log in as an Administrator. To do this, follow the step below:

1. Before you run Enterprise Architect, right-click on the Enterprise Architect icon on the desktop and select the **Run as administrator** option.

Alternatively, edit or create a link to Enterprise Architect and configure the link to run as an administrator; follow the steps below:

1. Right-click on the Enterprise Architect icon and select the **Properties** menu option. The **Enterprise Architect Properties** dialog displays.

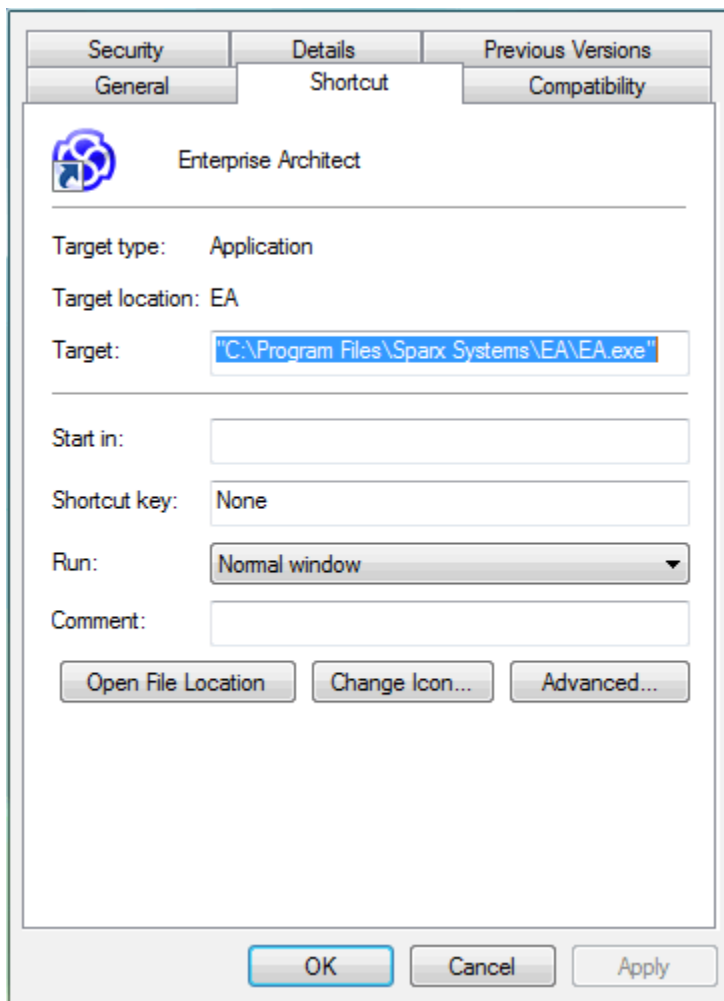

2. Click on the **Advanced** button. The **Advanced Properties** dialog displays.

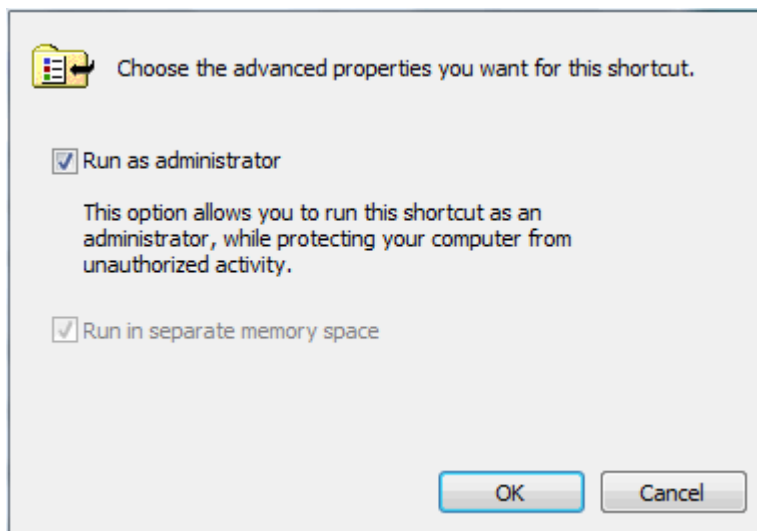

3. Select the **Run as administrator** checkbox.
4. Click on the **OK** button, and again on the **Enterprise Architect Properties** dialog.

### 7.6.5.2.1.2 WINE Debugging

At the command line, run `$ winecfg`.

Set the library overrides for `dbghelp` to (*native*, *builtin*), and accept the warning about overriding this DLL:

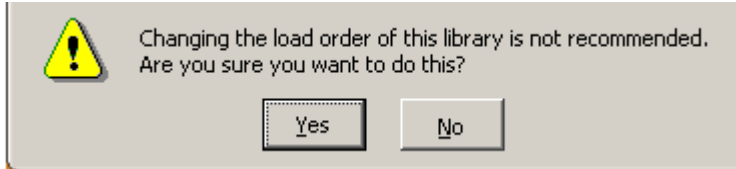

#### Note:

If WINE crashes, the back traces may not be correct.

1. Set `dbghelp` to **native** by using `winecfg`.
2. Copy the application source code plus executable(s) to your bottle. (The path must be the same as the compiled version; that is:

If Windows source = `C:\Source\SampleApp`, under Crossover it must be `C:\Source\SampleApp`.)

3. Copy any Side-By-Side assemblies that are used by the application.
4. Import the source code into Enterprise Architect. (Optional.)
5. [Create a build script](#) <sup>[1443]</sup> on a package.

Set the path of the application on the **Debug** tab, and set **Use Debugger** to **Microsoft Native**.

6. Open the [Profiler](#) <sup>[1514]</sup> (**View | Execution Analyzer | Profiler**).
7. Click on the **Launch** button (first button on the **Profiler** window).

If the sample didn't start, click on the **Sampling** button (third button on the **Profiler** window).

8. Once you have finished profiling, shut down the application (not Enterprise Architect).
9. View the Sampler report by clicking the **View Report** button (fifth button on the **Profiler** window).

#### Tips:

- If you are using MFC remember to copy the debug side-by-side assemblies to the `C:\window\winsxs` directory.
- To add a windows path to WINE, modify the Registry entry:

```
HKEY_LOCAL_MACHINE\System\CurrentControlSet\Control\Session Manager\Environment
```

#### Access Violation Exceptions

Due to the manner in which WINE handles direct drawing and access to DIB data, an additional option is provided on the **Debug** window toolbar drop-down menu to ignore or process access violation exceptions thrown when your program directly accesses DIB data.

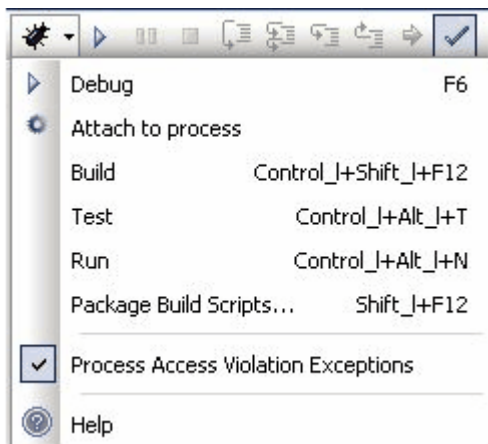

Select this option to catch genuine (unexpected) access violations; deselect it to ignore expected violations. As the debugger cannot distinguish between expected and unexpected violations, you might have to use `try` and `error` to capture and inspect genuine program crashes.

#### 7.6.5.2.2 Microsoft C++ and Native (C, VB)

The example script below is configured to enable debugging of a **C++** project built in Microsoft Visual Studio 2005 or 2008.

You can debug native code only if there is a corresponding PDB file for the executable. You normally create the PDB file as a result of building the application.

The build should include full debug information and there should be no optimizations set.

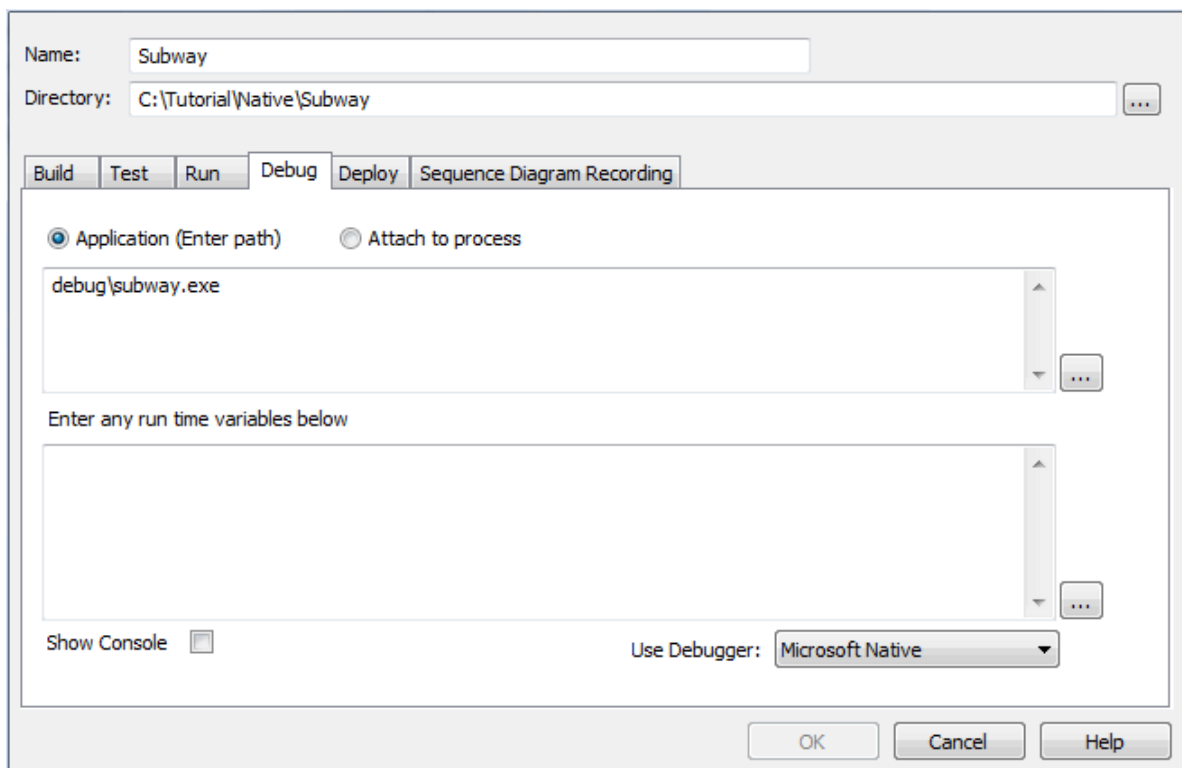

The script must specify two things to support debugging:

- The path to the executable
- **Microsoft Native** as the debugging platform.

### 7.6.5.2.2.1 Debug Symbols

For Applications built using *Microsoft Platform SDK* Debug Symbols are written to an Application PDB file when the Application is built.

The *Debugging Tools for Windows*, an API used by the Visual Execution Debugger, uses these symbols to present meaningful information to Execution Analyzer controls.

These symbols can easily get out of date and cause errant behaviour. The debugger might highlight the wrong line of code in the editor whilst at a breakpoint. It is therefore best to ensure the application is built prior to any debugging or recording session.

The debugger must inform the API how to reconcile addresses in the image being debugged. It does this by specifying a number of paths to the API that tell it where to look for PDB files. The API automatically picks up the path to the main image PDB from the image itself.

For system DLLs (kernel32, mfc90ud ...) for which no debug symbols are found, the **Call Stack** shows some frames with module names and addresses only .

You can supplement the symbols translated by passing additional paths to the API. To do this there must be a Package Script selected and it must have the Native debugger specified.

You pass additional symbol paths in a semi-colon separated list in the **Enter any runtime variables...** field of the **Debug** tab, as illustrated below.

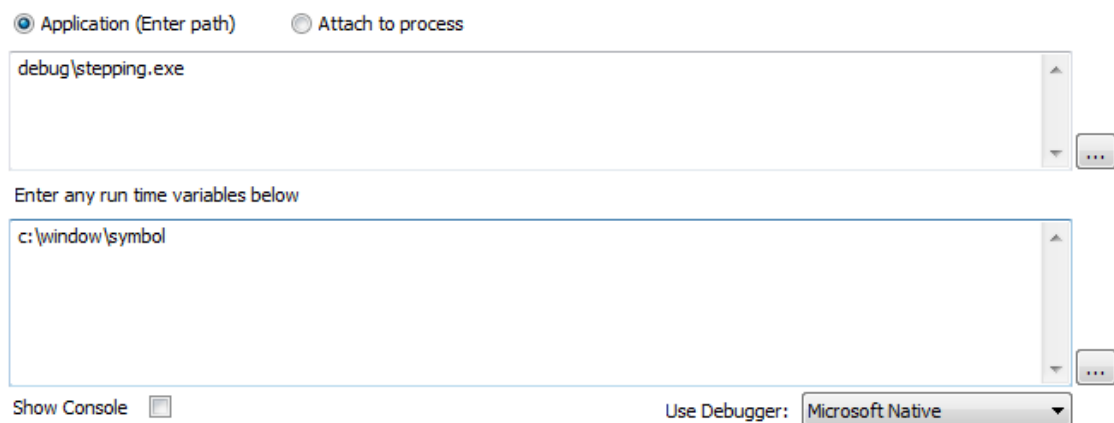

### 7.6.5.2.3 Java

This section describes how to [set up](#)<sup>[1453]</sup> Enterprise Architect for debugging Java applications and [Web Servers](#)<sup>[1456]</sup>.



### 7.6.5.2.3.1 General Setup for Java

This is the general setup for debugging Java applications:

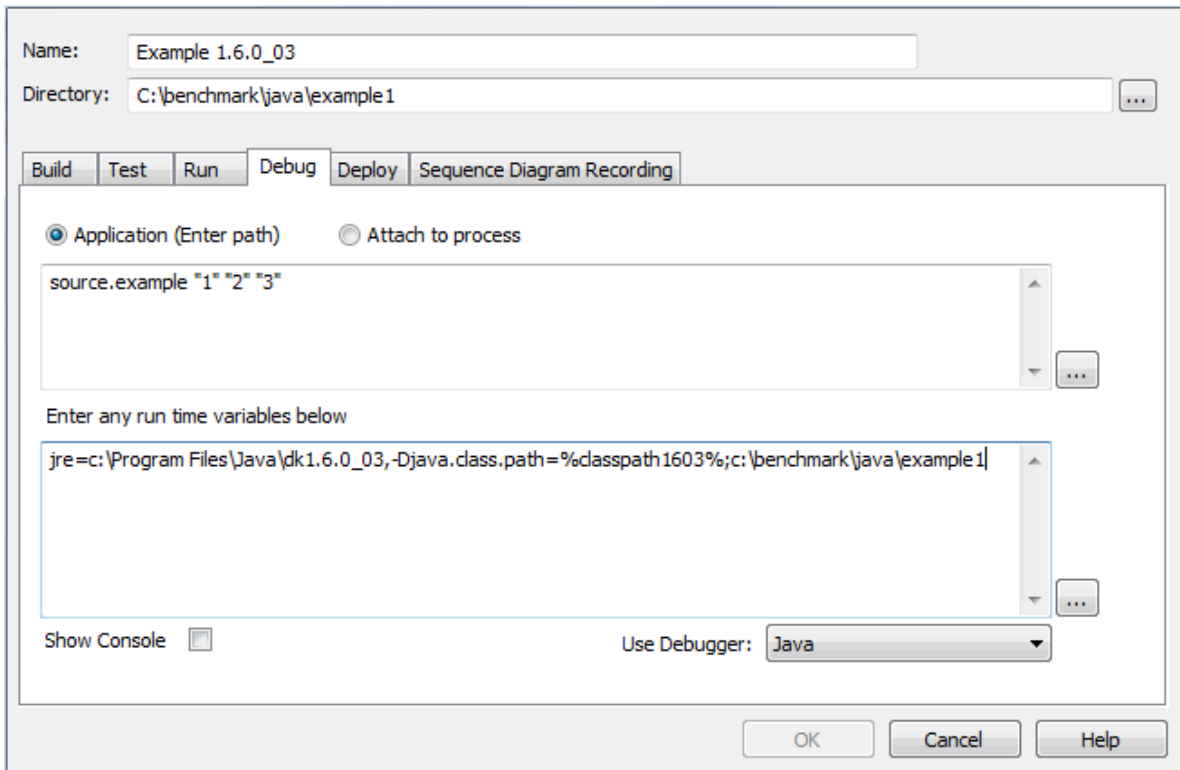

Option	Use to
<b>Application (Enter path)</b>	<p>Identify the fully qualified Class name to debug, followed by any arguments. The Class must have a method declared with the following signature:</p> <pre>public static void main(String[]);</pre> <p>The debugger calls this method on the Class you name. In the example above, the parameters <b>1</b>, <b>2</b> and <b>3</b> are passed to the method.</p> <p>You can also debug a Java application by <a href="#">attaching to an existing Java process</a> <sup>[1454]</sup>.</p>
<b>Enter any run time variables below</b>	<p>Type any required command line options to the Java Virtual Machine.</p> <p>You also must provide a parameter (<b>jre</b>) that is a path to be searched for the jvm.dll. This is the DLL supplied as part of the Java runtime environment or Java JDK from Sun Microsystems™ (see <a href="#">Debugging</a> <sup>[1490]</sup>).</p> <p>In the example above, a virtual machine is created with a new Class path property that comprises any paths named in the environment variable <i>classpath 1603</i> plus the single path "C:\benchmark\java\example1".</p> <p>If no Class path is specified, the debugger always creates the virtual machine with a Class path property equal to any path contained in the environment variable plus the path entered in the default working directory of this script.</p> <p><b>Note:</b></p> <p>If source files and .class files are located under different directory trees, the Class path property <b>MUST</b> include both root path(s) to the source and root path(s) to binary class files.</p>
<b>Show Console</b>	Create a console window for Java. If no console window is required, leave

Option	Use to
	blank.
Use Debugger	Select <b>Java</b> .

### 7.6.5.2.3.2 Advanced Techniques

In addition to the standard Java debugging techniques, you can also:

- [Attach to a Virtual Machine](#) <sup>[1454]</sup>
- [Debug Internet Browser Java Applets](#) <sup>[1454]</sup>

You can debug a Java application by attaching to an existing Java process.

However, the Java process requires a specific startup option specifying the Sparx Systems Java Agent. The format of the command line option is:

```
-agentlib:SSJavaProfiler75
```

or:

```
-agentpath:"c:\program files\sparx systems\ea\SSJavaProfiler75"
```

The example below is for attaching to the *Tomcat Webserver*. Select the **Attach to process** radio button, and then the keyword **Attach** is all that you have to enter. This keyword causes the debugger to prompt you for a process at runtime.

#### Note:

The **Show Console** checkbox has no effect when attaching to an existing virtual machine.

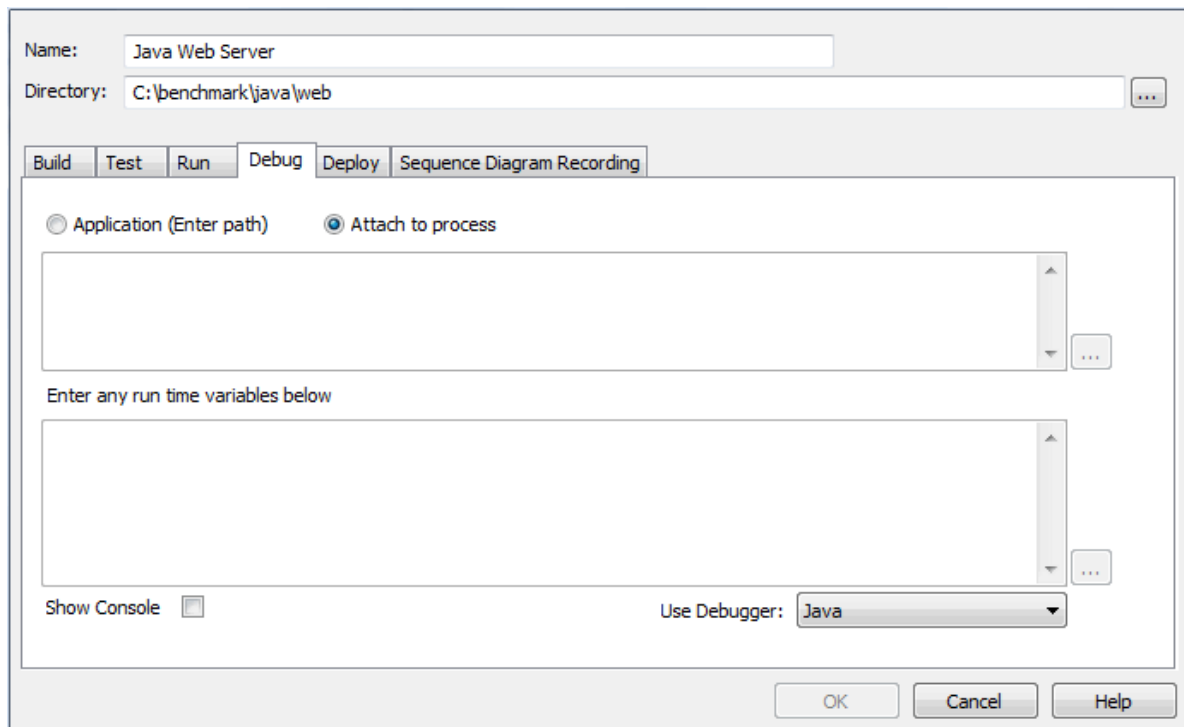

No run time variables are necessary when attaching as these are specified as startup parameters to the process.

This topic describes the configuration requirements and procedure for debugging Java Applets running in a browser from Enterprise Architect.

The procedure requires you to attach to the browser process hosting the Java Virtual Machine (JVM) from Enterprise Architect, as summarized below:

1. Ensure binaries for the applet code to be debugged have been built with debug information.
2. Configure the JVM using the [Java Control Panel](#).

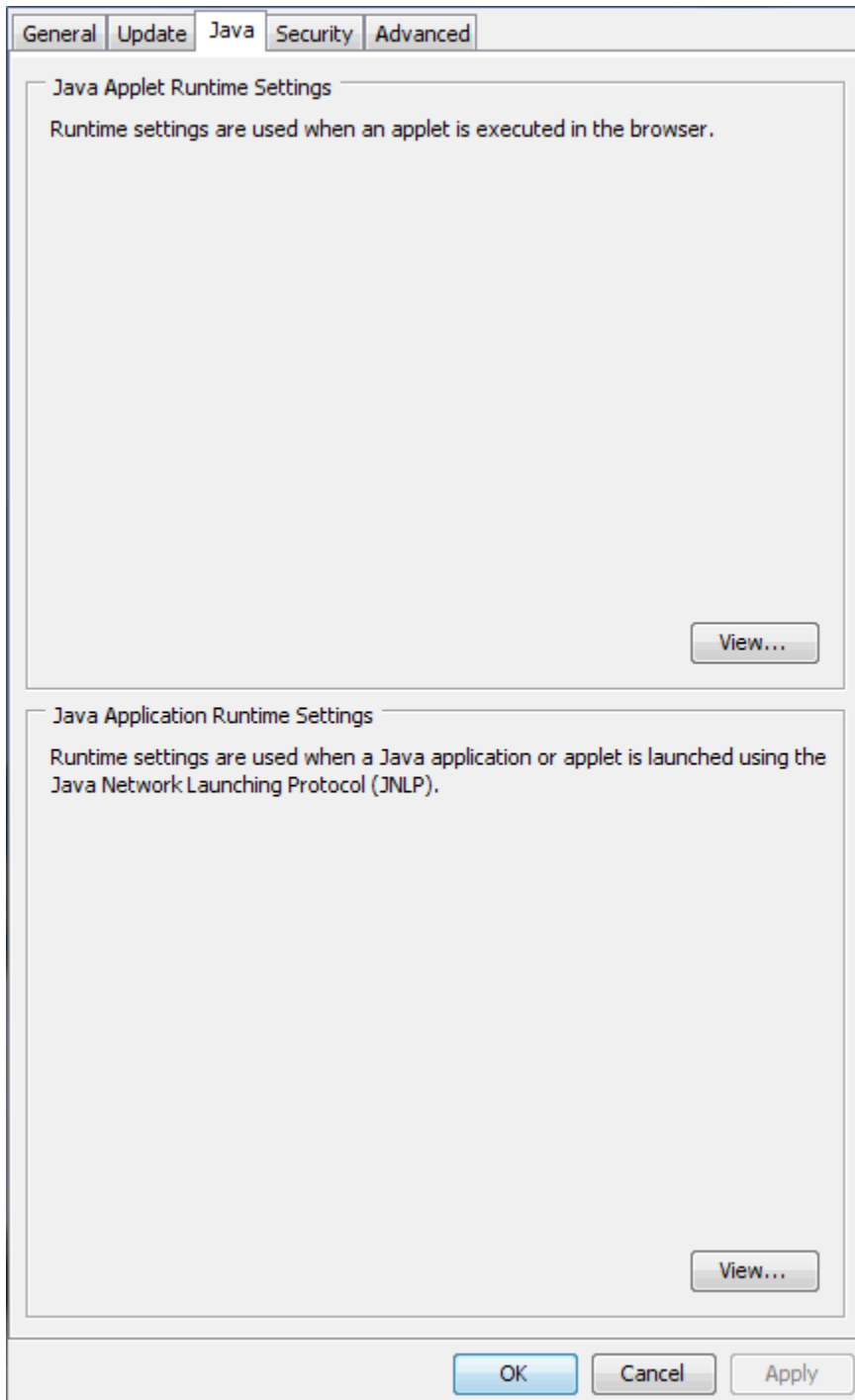

3. In the [Java Applet Runtime Settings](#) panel, click on the **View** button. The [Java Runtime Settings](#) dialog displays.

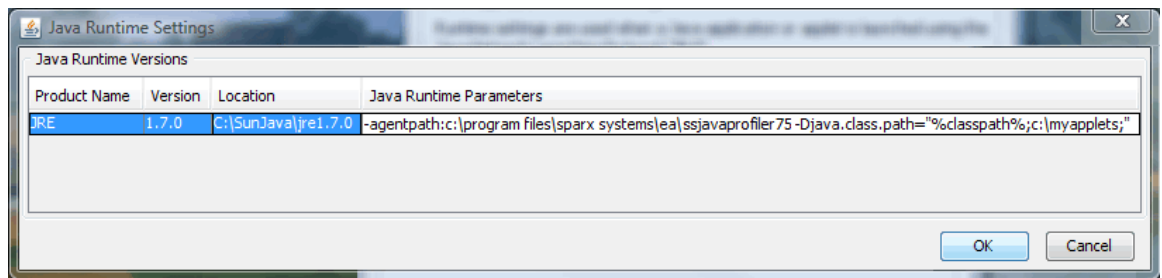

4. Click on the appropriate entry and click on the **OK** button to load the Sparx Systems Agent.
5. [Import source code](#) <sup>[1329]</sup> into the Enterprise Architect model, or [synchronize existing code](#) <sup>[1327]</sup>.
6. Create or modify the [Package Build Script](#) <sup>[1425]</sup> to specify the option for attaching to the process.
5. Set [breakpoints](#) <sup>[1468]</sup>.
6. Launch the browser.
7. Attach to the browser process from Enterprise Architect.

Note that the *class.path* property specified for the JVM includes the root path to the applet source files. This is necessary for the Enterprise Architect debugger to match the execution to the imported source in the model.

### 7.6.5.2.3.3 Working with Java Web Servers

This topic describes the configuration requirements and procedure for debugging Java web servers such as [JBoss](#) <sup>[1458]</sup> and Apache Tomcat (both [Server](#) <sup>[1459]</sup> configuration and [Windows Service](#) <sup>[1460]</sup> configuration) in Enterprise Architect.

The procedure involves attaching to the process hosting the Java Virtual Machine from Enterprise Architect, as summarized below:

1. Ensure binaries for the web server code to be debugged have been built with debug information.
2. Launch the server with the Virtual Machine [startup option](#) <sup>[1456]</sup> described in this topic.
3. Import source code into the Enterprise Architect Model, or synchronize existing code.
4. Create or modify the [Package Build Script](#) <sup>[1456]</sup> to specify the **Debug** option for attaching to the process.
5. Set [breakpoints](#) <sup>[1468]</sup>.
6. Launch the client.
7. Attach to the process from Enterprise Architect.

## Server Configuration

The configuration necessary for the web servers to interact with Enterprise Architect must address the following two essential points:

- Any VM to be debugged, created or hosted by the server must have the Sparx Systems Agent SSJavaProfiler75 command line option specified in the VM startup option (that is: `-agentlib:SSJavaProfiler75`)
- The CLASSPATH, however it is passed to the VM, must specify the root path to the package source files.

The Enterprise Architect debugger uses the `java.class.path` property in the VM being debugged, to locate the source file corresponding to a breakpoint occurring in a Class during execution. For example, a Class to be debugged is called:

a.b.C

This is located in physical directory:

C:\source\alb

So, for debugging to be successful, the CLASSPATH must contain the root path:

c:\source.

## Package Script Configuration

Using the [Debug tab](#) <sup>[1453]</sup> of the **Build Script** dialog, create a script for the code you have imported and specify the following:

- Select the **Attach to process** radio button, and in the field below type **attach**.
- In the **Use Debugger** field, click on the drop-down arrow and select **Java**.

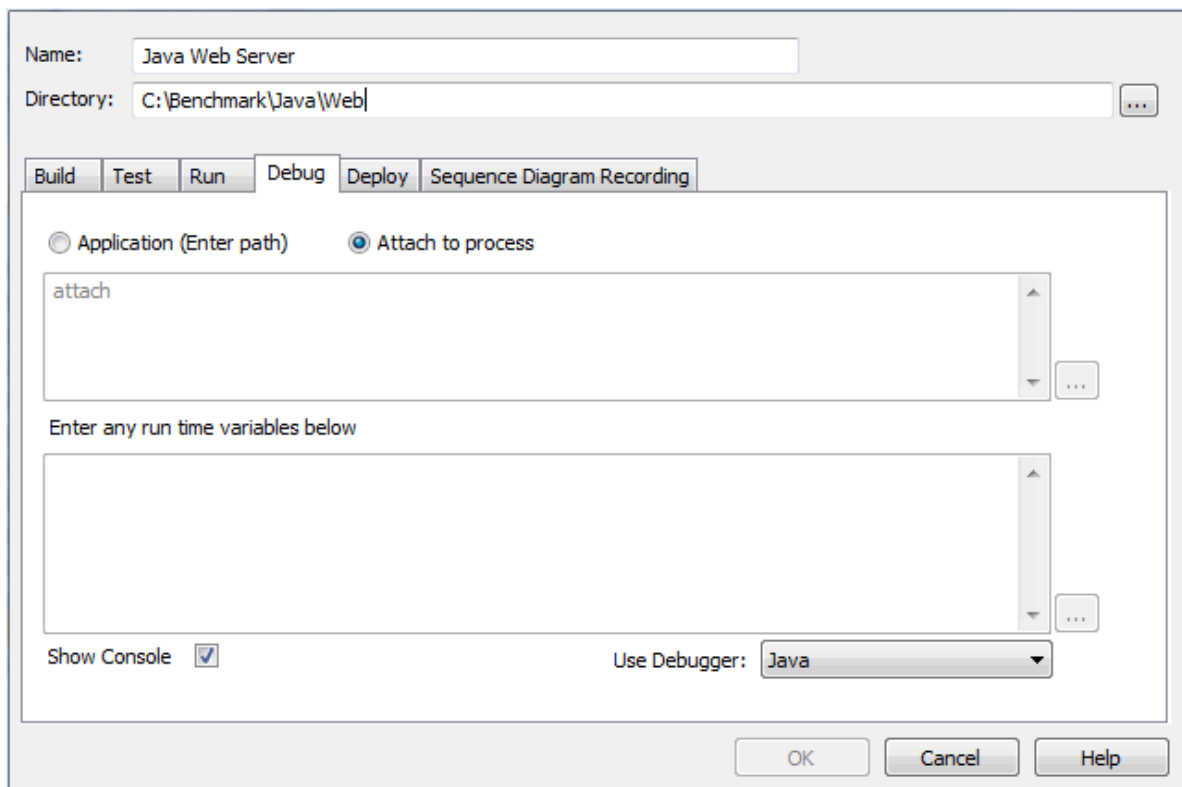

All other fields are unimportant. The **Directory** field is normally used in the absence of any Class path property.

## Debugging

First ensure that the server is running, and that the server process has loaded the Sparx Systems Agent DLL `SSJavaProfiler75.DLL` (use *Process Explorer* or similar tools to prove this).

Launch the client and ensure the client executes. This must be done before attaching to the server process in Enterprise Architect.

After the client has been executed at least once, return to Enterprise Architect, open the source code you imported and set some [breakpoints](#) <sup>[1465]</sup>.

Click on the [Run Debugger](#) <sup>[1471]</sup> button in Enterprise Architect. The **Attach To Process** dialog displays.

PID	Name	Path
344	inetinfo.exe	C:\Windows\System32\inetinfo.exe
936	sqlservr.exe	C:\Program Files\Microsoft SQL Server\MSSQL.1\MSSQL\Binn\sqlservr.exe
1356	nod32krn.exe	C:\Program Files\Eset\nod32krn.exe
1908	svchost.exe	C:\Windows\System32\svchost.exe
648	sqlbrowser.exe	C:\Program Files\Microsoft SQL Server\90\Shared\sqlbrowser.exe
1500	sqlwriter.exe	C:\Program Files\Microsoft SQL Server\90\Shared\sqlwriter.exe
1668	svchost.exe	C:\Windows\System32\svchost.exe
2036	vds.exe	C:\Windows\System32\vds.exe
2056	vmnat.exe	C:\Windows\System32\vmnat.exe
2084	svchost.exe	C:\Windows\System32\svchost.exe
5368	w3wp.exe	C:\Windows\System32\inethttp\w3wp.exe
2100	svchost.exe	C:\Windows\System32\svchost.exe
2136	vmnetdhcp.exe	C:\Windows\System32\vmnetdhcp.exe
2220	vmware-authd.exe	C:\Program Files\VMware\VMware Player\vmware-authd.exe
3752	WmiApSrv.exe	C:\Windows\System32\wbem\WmiApSrv.exe
2128	explorer.exe	C:\Windows\Explorer.EXE
3872	SearchIndexer.exe	C:\Windows\System32\SearchIndexer.exe
2956	SMSvcHost.exe	C:\Windows\Microsoft.NET\Framework\v3.0\Windows Communication Fou..
2568	iexplore.exe	C:\Program Files\Internet Explorer\iexplore.exe
5668	avant.exe	C:\Program Files\Avant Browser\avant.exe

Click on the **OK** button. A confirmation message displays in the Debug **Output** window, stating that the process has been attached.

The breakpoints should remain enabled (bright red). If the breakpoints fail, and contain either an exclamation mark or a question mark, then either the process is not hosting the SSJavaprofiler75 Agent or the binaries being executed by the server are not based on the source code. If so, check your configuration.

Consider the JBoss example below. The source code for a simple servlet is located in the directory location:



The binaries executed by JBOSS are located in the JAW.EAR file in this location:

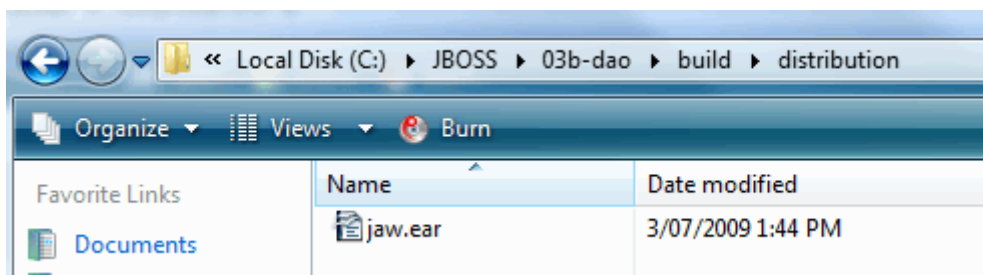

The Enterprise Architect debugger has to be able to locate source files during debugging. To do this it also uses the CLASSPATH, searching in any listed path for a matching JAVA source file, so the CLASSPATH must include a path to the root of the package for Enterprise Architect to find the source during debugging.

The following is an excerpt from the command file that executes the JBOSS server. Since the Class to be debugged is at com/inventory/dto/carDTO, the root of this path is included in the *JBOSS* classpath.

RUN.BAT

```

-----
set SOURCE=C:\Benchmark\Java\JBoss\Inventory

set JAVAC_JAR=%JAVA_HOME%\lib\tools.jar

if "%JBoss_CLASSPATH%" == ""
(
    set JBoss_CLASSPATH=%SOURCE%;%JAVAC_JAR%;%RUNJAR%;
)
else
(
    set JBoss_CLASSPATH=%SOURCE%;%JBoss_CLASSPATH%;%JAVAC_JAR%;%RUNJAR%;
)

set JAVA_OPTS=%JAVA_OPTS% -agentpath:"c:\program files\sparx systems\ssjavaprofiler75"

```

This configuration is for the same application as outlined in the [JBoss server](#)<sup>[1458]</sup> configuration topic.

There are two things to notice of importance.

- The Java VM option: -agentpath:c:\program files\sparx systems\ea\ssjavaprofiler75
- The addition to the Class path property of the path to the source code: C:\JBoss\03b-dao\common\src;

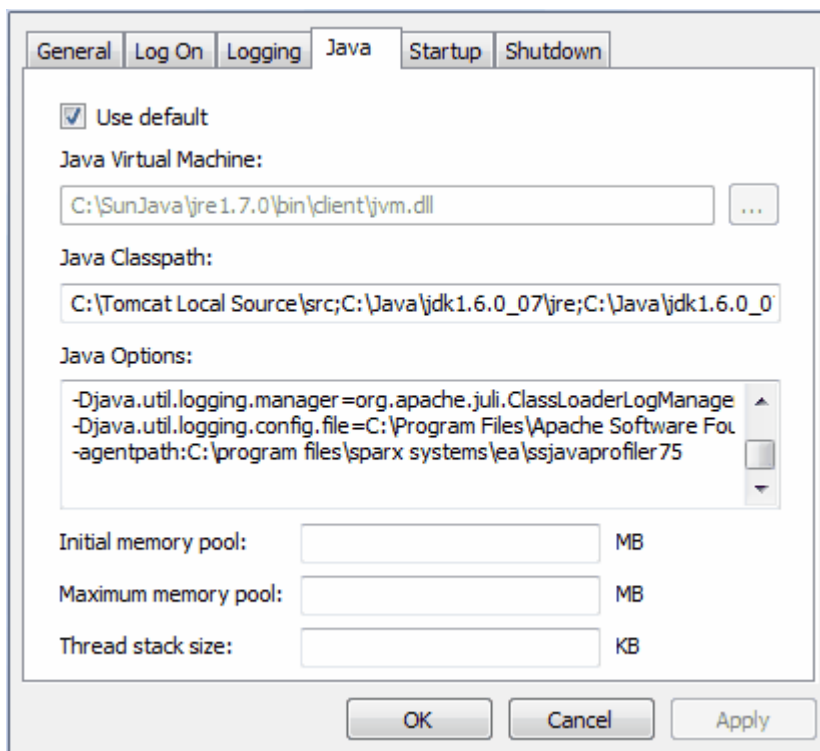

For users running Apache Tomcat as a Windows™ service, it is important to configure the service to enable interaction with the Desktop. Failure to do so causes debugging to fail within Enterprise Architect.

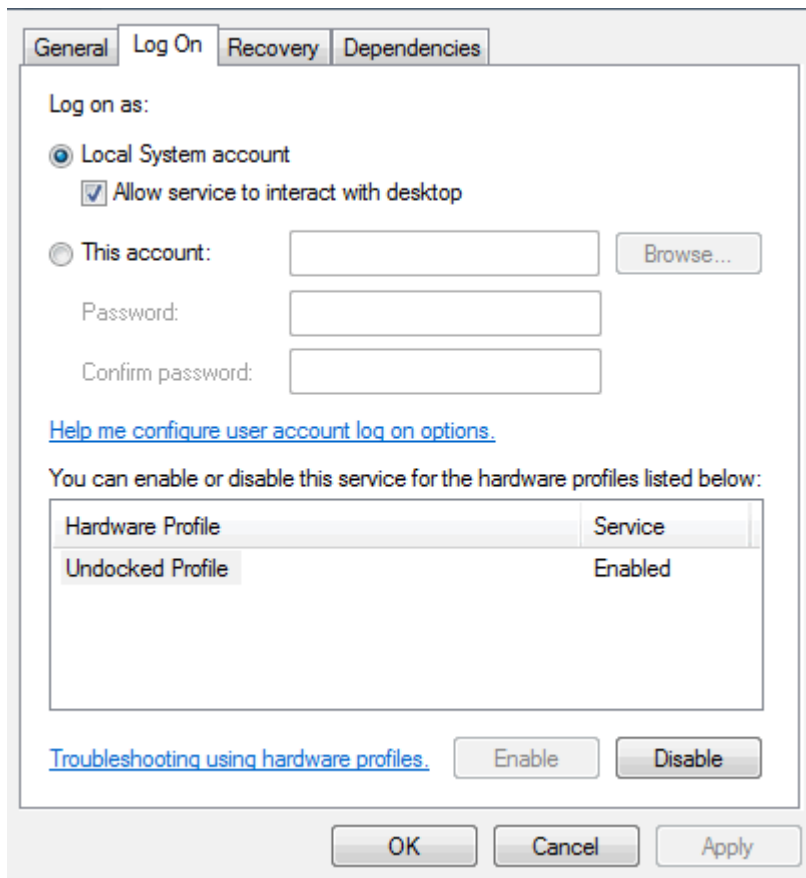

Select the **Allow service to interact with desktop** checkbox.

#### 7.6.5.2.4 .NET

This section describes how to configure Enterprise Architect for debugging .NET applications. It covers:

- [General Setup](#)<sup>[1461]</sup>
- [Debug Assemblies](#)<sup>[1461]</sup>
- [Debug CLR Versions](#)<sup>[1462]</sup>
- [Debug COM Interop](#)<sup>[1463]</sup>
- [Debug ASP .NET](#)<sup>[1463]</sup>



### 7.6.5.2.4.1 General Setup for .NET

This is the general setup for debugging .NET applications:

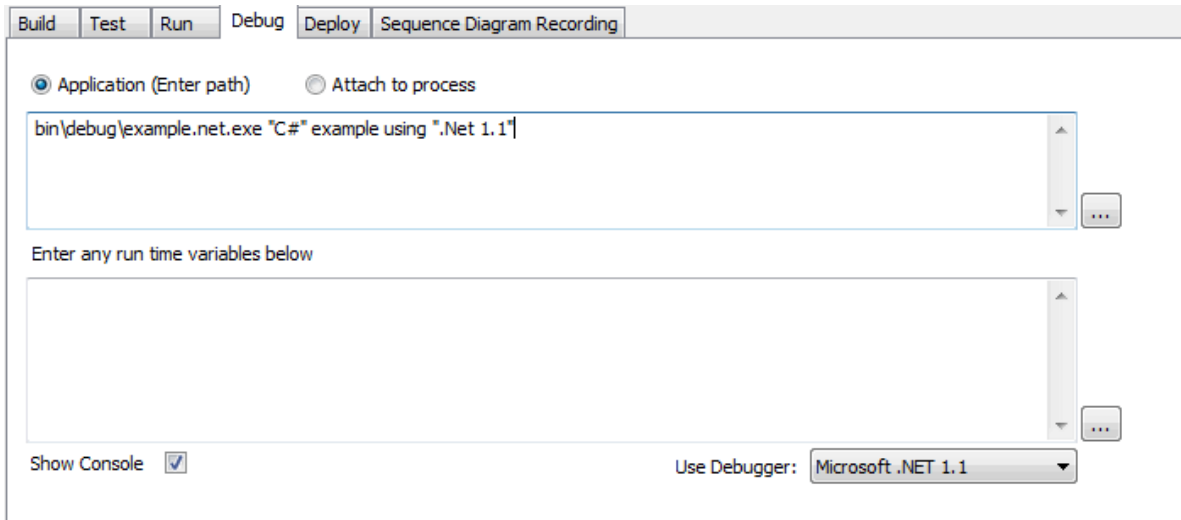

Option	Use to
<b>Application (Enter path)</b>	Select and enter either the full or the relative path to the application executable, followed by any command line arguments.
<b>Enter any runtime variables below</b>	Type any required command line options, if debugging a single <a href="#">.NET Assembly</a> <sup>[1461]</sup> .
<b>Show Console</b>	Create a console window for the debugger. Not applicable for attaching to a process.
<b>Use Debugger</b>	Select the debugger to suit the .NET Framework under which your application runs.

**Note:**

If you intend to debug managed code using an unmanaged application, please see the [Debug - CLR Versions](#)<sup>[1462]</sup> topic.

### 7.6.5.2.4.2 Debug Assemblies

Enterprise Architect permits debugging of individual assemblies.

The assembly is loaded and a specified method invoked. If the method takes a number of parameters, these can be passed.

### Constraints

Debugging of assemblies is only supported for .NET version 2.

The following image is of a **Build Script** configured for debugging a .NET assembly.

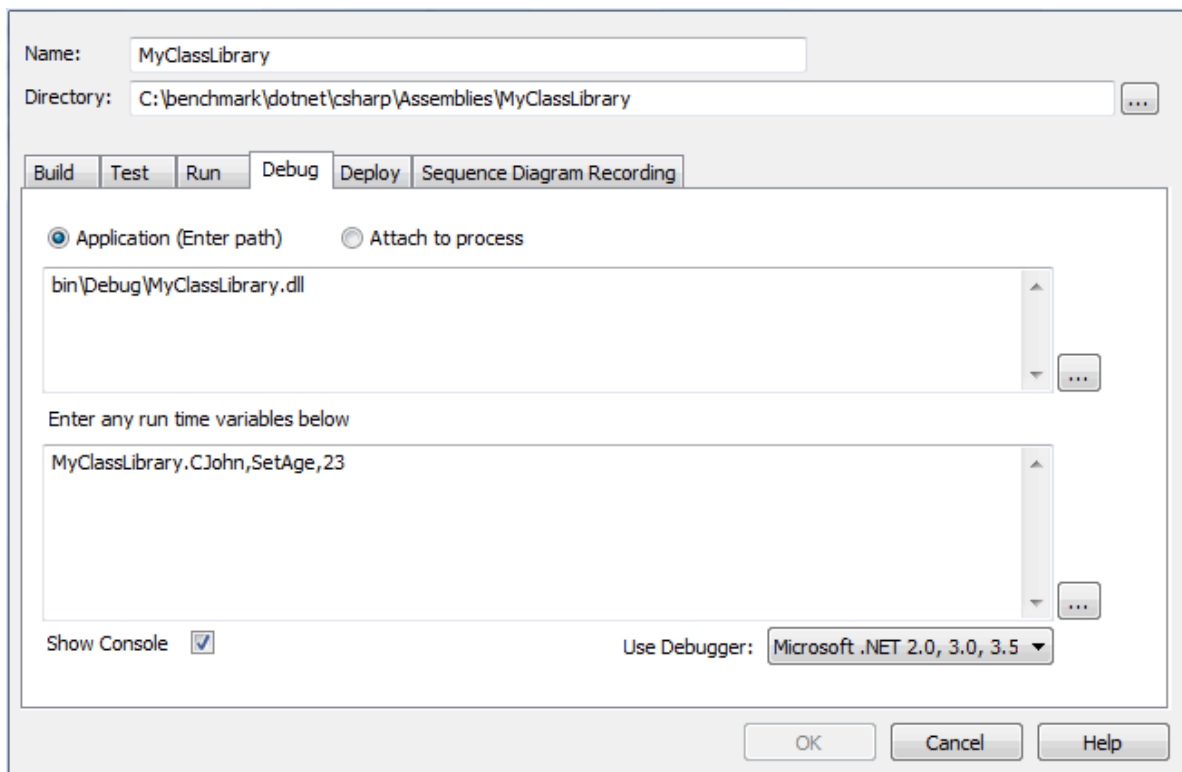

Notice the **Enter any run time variables below** field. This field is a comma-delimited list of values that must present in the following order:

*type\_name, method\_name, { method\_argument\_1, method\_argument2,...}*

where:

- *type\_name* is the qualified type to instantiate
- *method\_name* is the unqualified name of the method belonging to the type that is invoked
- the *argument list* is optional depending on the method invoked.

The information in this field is passed to the debugger.

#### 7.6.5.2.4.3 Debug - CLR Versions

Please note that if you are debugging managed code using an unmanaged application, the debugger might fail to detect the correct version of the Common Language Runtime (CLR) to load. You should specify a config file if you don't already have one for the debug application specified in the *Debug* command of your script. The config file should reside in the same directory as your application, and take the format:

```
name.exe.config
```

where *name* is the name of your application.

The version of the CLR you should specify should match the version loaded by the managed code invoked by the debuggee.

Sample config file:

```
<configuration>
  <startup>
    <requiredRuntime version="version" />
  </startup>
</configuration>
```

where *version* is the version of the CLR targeted by your plugin or COM code.

For further information, see <http://www.msdn2.microsoft.com/en-us/library/9w519wzk.aspx>.

#### 7.6.5.2.4.4 Debug COM Interop

Enterprise Architect enables you to debug .NET managed code executed using COM in either a Local or an In-Process server.

This feature is useful for debugging Plugins and ActiveX components.

1. Create a package in Enterprise Architect and import the code to debug. See [Software Engineering](#).
2. Ensure the COM component is built with debug information.
3. Create a Script for the Package.
4. In the **Debug** tab, you can elect to either attach to an unmanaged process or specify the path to an unmanaged application to call your managed code.

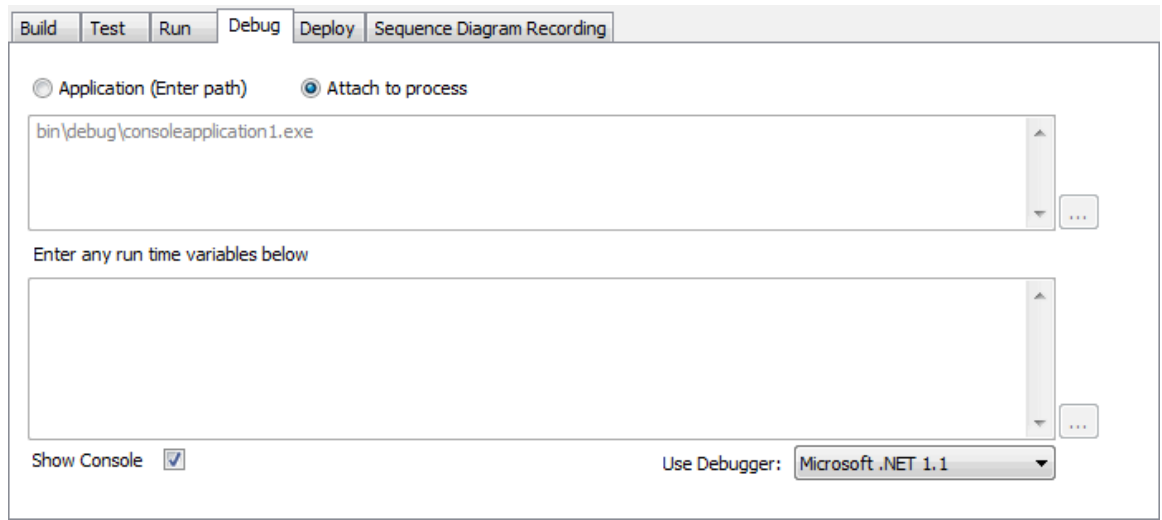

5. Add breakpoints in the source code to debug.

#### Attach to an Unmanaged Process

- If an In-Process COM server, attach to the client process or
- If a Local COM Server, attach to the server process.

Click on the **Debug** window **Run** button (or press **[F6]**) to display a list of processes from which you can choose.

#### Important:

Detaching from a COM interop process you have been debugging terminates the process. This is a known issue for Microsoft .NET Framework, and information on it can be found on many of the MSDN .NET blogs.

#### 7.6.5.2.4.5 Debug ASP .NET

Debugging for web services such as ASP requires that the Enterprise Architect debugger is able to attach to a running service.

Begin by ensuring that the directory containing the ASP .NET service project has been imported into Enterprise Architect and, if required, the web folder containing the client web pages. If your web project directory resides under the website hosting directory, then you can import from the root and include both ASP code and web pages at the same time.

The following image shows the project tree of a web service imported into Enterprise Architect.

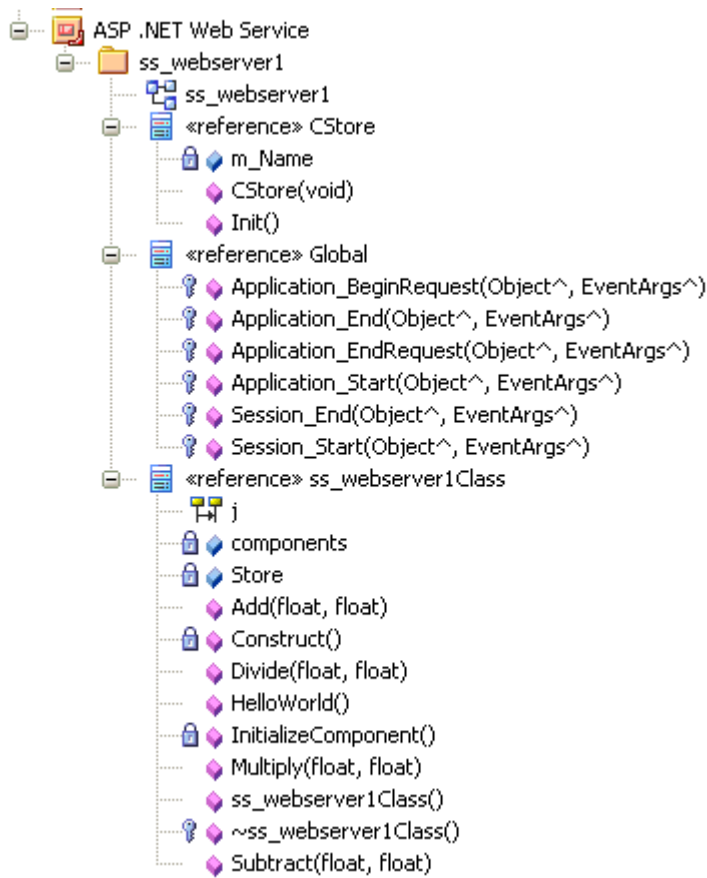

It is necessary to launch the client first, as the ASP .NET service process might not already be running. Load the client by using your browser. This ensures that the web server is running. The only difference to a debug script for ASP is that you specify the **attach** keyword in your script, as follows:

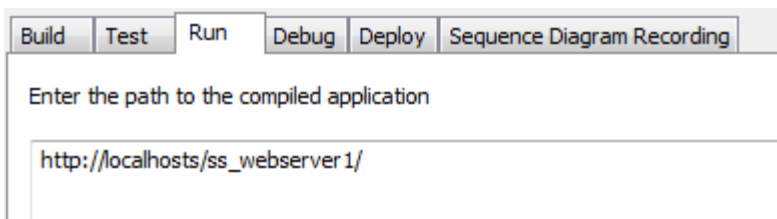
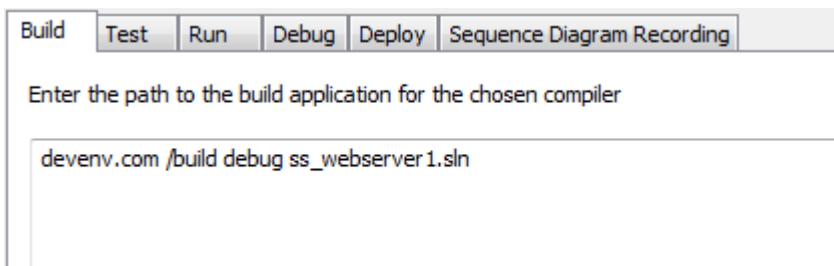
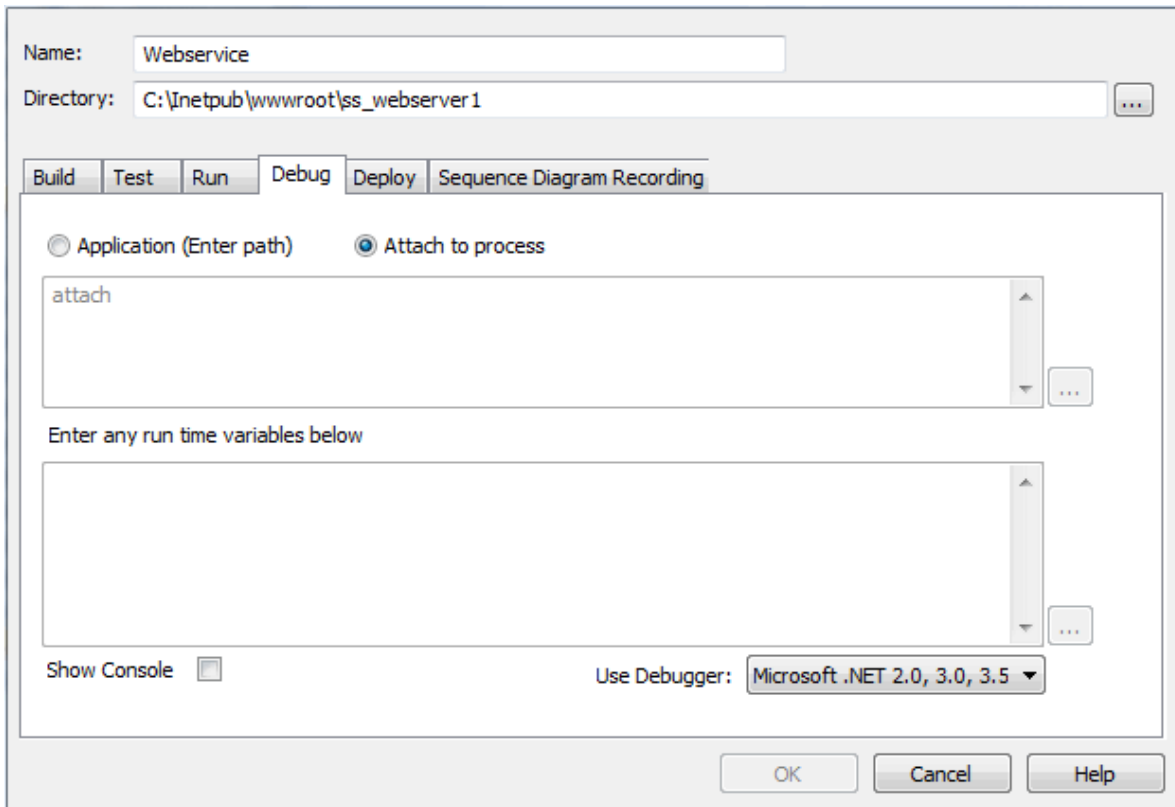

When you start the debugger (click on the [Debug window](#) <sup>1471</sup> **Run** button) the **Attach To Process** dialog displays.

PID	Name	Path
344	inetinfo.exe	C:\Windows\System32\inetinfo.exe
936	sqlservr.exe	C:\Program Files\Microsoft SQL Server\MSSQL.1\MSSQL\Binn\sqlservr.exe
1356	nod32krn.exe	C:\Program Files\Eset\nod32krn.exe
1908	svchost.exe	C:\Windows\System32\svchost.exe
648	sqlbrowser.exe	C:\Program Files\Microsoft SQL Server\90\Shared\sqlbrowser.exe
1500	sqlwriter.exe	C:\Program Files\Microsoft SQL Server\90\Shared\sqlwriter.exe
1668	svchost.exe	C:\Windows\System32\svchost.exe
2036	vds.exe	C:\Windows\System32\vds.exe
2056	vmnat.exe	C:\Windows\System32\vmnat.exe
2084	svchost.exe	C:\Windows\System32\svchost.exe
5368	w3wp.exe	C:\Windows\System32\inethttp\w3wp.exe
2100	svchost.exe	C:\Windows\System32\svchost.exe
2136	vmnetdhcp.exe	C:\Windows\System32\vmnetdhcp.exe
2220	vmware-authd.exe	C:\Program Files\VMware\VMware Player\vmware-authd.exe
3752	WmiApSrv.exe	C:\Windows\System32\wbem\WmiApSrv.exe
2128	explorer.exe	C:\Windows\Explorer.EXE
3872	SearchIndexer.exe	C:\Windows\System32\SearchIndexer.exe
2956	SMSvcHost.exe	C:\Windows\Microsoft.NET\Framework\v3.0\Windows Communication Fou..
2568	iexplore.exe	C:\Program Files\Internet Explorer\iexplore.exe
5668	avant.exe	C:\Program Files\Avant Browser\avant.exe

Note that the name of the process varies across Microsoft operating systems.; check the *ASP .NET SDK* for more information. The image above shows the IIS process *w3wp.exe*, which is the name of the process that runs under Windows Vista.

On Windows XP, the name of the process is something like *aspnet\_wp.exe*, although the name could reflect the version of the .NET framework that it is supporting. There can be multiple ASP.NET processes running under XP; you must ensure that you attach to the correct version, which would be the one hosting the .NET framework version that your application runs on. Check the *web.config* file for your web service to verify the version of .NET framework it is tied to.

The **Debug** window **Stop** button should be enabled and any [breakpoints](#) <sup>1468</sup> should be red, indicating they have been bound.

#### Note:

Some breakpoints might not have bound successfully, but if none at all are bound (indicated by being dark red with question marks) something has gone out of sync. Try rebuilding and re-importing source code.

You can set breakpoints at any time in the web server code. You can also set breakpoints in the ASP web page(s) if you imported them.

### 7.6.5.3 The Debug Window

The **Debug** window gives access to the scripts and windows of the debug facility.

To access the **Debug** window, select the **View | Execution Analyzer | Debugger** menu option.

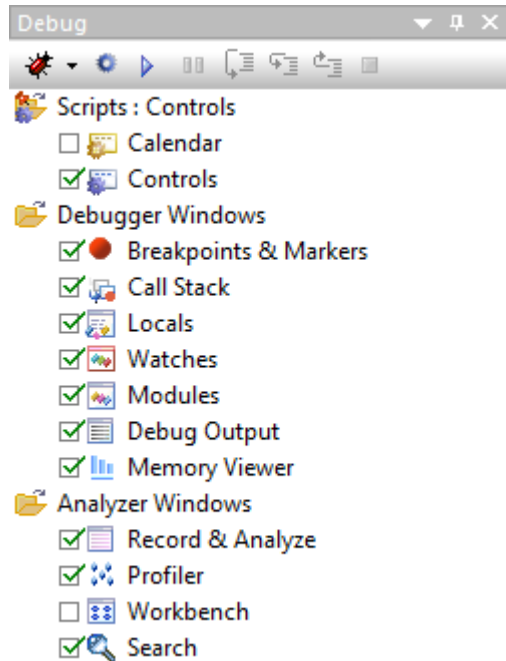

The **Debug** window has three top-level folders:

- The *Scripts <Package Name>* folder lists the scripts available for the currently-selected package, the first in the list being, by default, the active script that is executed when you start debugging, as indicated by the selected checkbox. If you are using recording markers, this is also the script that determines what [recording options are applied](#)<sup>[1492]</sup>. If you want to execute a different script, select the appropriate checkbox. The context menu for each script provides further scripting options, such as **Debug**, **Build**, **Test** and **Edit**.

You can pin the package scripts so that they remain listed in the **Debug** window even if you select a different package. To do this, right-click on the folder title and select the **Pin Package** context menu option; the Scripts folder icon changes. To unpin the scripts, right-click on the folder title and deselect the **Pin Package** option.

You can also drag a script onto a diagram to automatically create a [hyperlink](#)<sup>[842]</sup> that executes the script.

- The *Debugger Windows* folder lists the debug windows, which you can display or hide by selecting or deselecting the checkbox against each one. If the window is docked, you can bring it to the front by clicking on the window name:
  - [Breakpoints & Markers](#)<sup>[1468]</sup> - lists any breakpoints placed in the package source code, along with their status (enabled/disabled), line number, and the physical source file in which they are located
  - [Call Stack](#)<sup>[1473]</sup> - shows the position of the debugger in the code; clicking on the > button advances the stack through the code until the next breakpoint is reached
  - [Locals](#)<sup>[1474]</sup> - shows the local variables defined in the current code segment, their type and value
  - [Watches](#)<sup>[1475]</sup> - shows the values of static and globally scoped expressions you have entered
  - [Modules](#)<sup>[1478]</sup> - displays all the modules loaded during a debug session
  - [Debug Output](#)<sup>[1476]</sup> - displays output from the debugger including any messages output by the debugged process, such as writes to standard output.
- The *Analyzer Windows* folder lists the advanced control windows of the Execution Analyzer, which you can display or hide by selecting or deselecting the checkbox against each one:
  - [Record & Analyze](#)<sup>[1506]</sup> - records any activity that takes place during a debug session; once the activity has been logged, Enterprise Architect can use it to create a new Sequence diagram

- [Profiler](#)<sup>[1514]</sup> - opens the **Profiler** window to sample an application
- [Workbench](#)<sup>[1519]</sup> - enables you to create instances of .NET and Java Classes
- [Search](#)<sup>[1485]</sup> - enables you to search for text in files.

You can [dock and combine](#)<sup>[76]</sup> the windows to suit your working requirements.

#### 7.6.5.4 Breakpoint and Marker Management

Breakpoints work in Enterprise Architect much like in any other debugger. Adding a breakpoint notifies the debugger to trap code execution at the point you have specified. When a breakpoint is encountered by a thread of the application being debugged, the source code is displayed in an editor window, and the line of code where the breakpoint occurred is highlighted.

Selecting a different package in the project affects which breakpoints are displayed.

##### Note:

The debugger does not stop automatically. It runs to completion unless it encounters a breakpoint.

An Enterprise Architect model maintains breakpoints for every package having a *Build Script - Debug* command. Breakpoints themselves are listed in their own **Breakpoints & Markers** window (**View | Execution Analyzer | Breakpoints & Markers**).

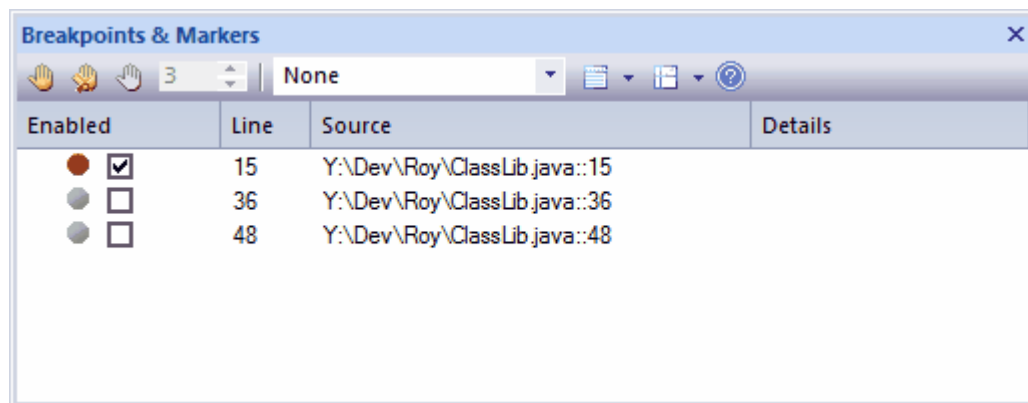

#### Breakpoint States

DEBUGGER STATE		
	Running	Not running
	Bound	Enabled
	Disabled	Disabled
	Not bound - this usually means that the DLL is not yet loaded or was not built with debug information	N/a
	Failed - this usually means a break could not be set at this time (see <i>Breakpoint Failures</i> below).	N/a

#### Breakpoint Failures

A breakpoint failure occurs if there is a problem in binding the breakpoint. A warning message displays in the **Details** column of the **Breakpoints & Markers** window, identifying the type of problem. For example:

- The source file for the breakpoint does not match the source file used to build the application image
- The time date stamp on the file is greater than that of the image.



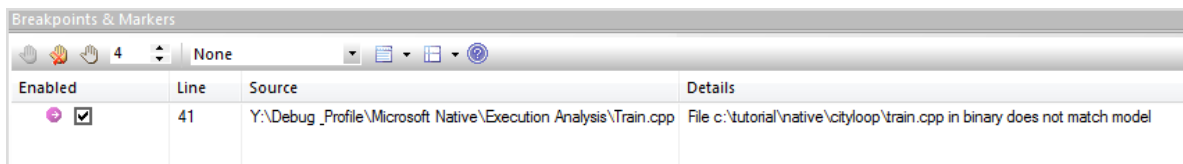

A warning message is also output to the **Debug Output** window.

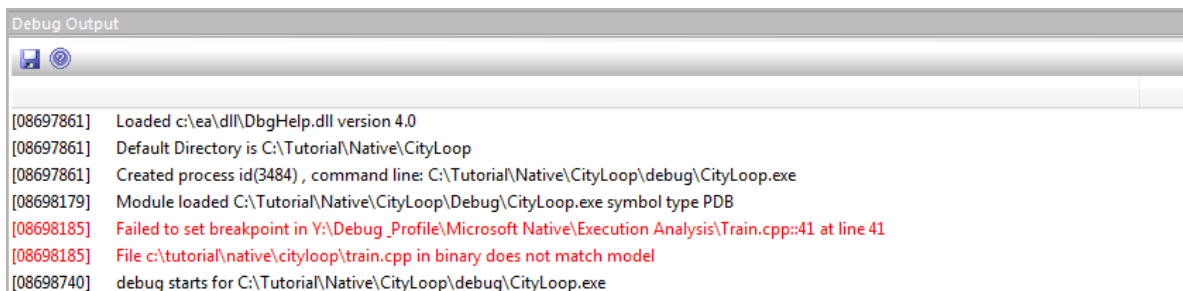



## Delete, Disable and Enable Breakpoints

To delete a specific breakpoint, either:

- If the breakpoint is enabled, click on the red breakpoint circle in the left margin of the **Source Code Editor**
- Right-click on the breakpoint marker in the editor and select the appropriate context menu option, or
- Select the breakpoint in the **Breakpoints & Markers** tab and press **[Delete]**.

Whether you are viewing the *Breakpoints* folder or the **Breakpoints & Markers** window, you can right-click on an existing breakpoint and select a context menu option either to delete it or to convert it to a [start recording marker or end recording marker](#)<sup>[1498]</sup>.

You can also delete all breakpoints by clicking on the **Delete all breakpoints** button on the **Breakpoints & Markers** window toolbar (.

To disable a breakpoint, deselect its checkbox on the **Breakpoints & Markers** window or, to disable all breakpoints, click on the **Disable all breakpoints** button in the toolbar (). The breakpoint is then shown as an empty grey circle. Select the checkbox or use the **Enable all breakpoints** button to enable it again (.

### 7.6.5.4.1 How Markers are Stored

Breakpoints created that are not part of any set are maintained in an external file for the current model.

The file format is as follows:

path\guid.brkpt

where:

- *path* = The O/S application data directory for each user
- *guid* = model Guid.

Marker Sets are stored in the model and are available to all users of the Model.

### 7.6.5.4.2 Setting Code Breakpoints

To set breakpoints for a code segment:

1. Open the model code to debug.
2. Find the appropriate code line and click in the left margin column. A solid red circle in the margin indicates that a breakpoint has been set at that position.

```

12 CTest::CTest(LPCWSTR name, TTestType type)
13 {
14     m_Name = name;
15     m_Type = type;
16     theTest = this;
17 }

```

If the code is currently halted at a breakpoint, that point is indicated by a blue arrow next to the marker.

```

6 int _tmain(int argc, _TCHAR* argv[])
7 {
8     CTest Test(_T("Model"), CTest::Regression);
9     return Test.Run();
10 }

```

### 7.6.5.4.3 Setting Data Breakpoints

Data breakpoints can currently only be set by right-clicking on the variable in the [Locals](#) window and selecting the **Set Data Breakpoint** context menu option. This means that in order to establish a data breakpoint you must first set a [normal breakpoint](#) at a point in the code that presents the required scope of local variables to choose from.

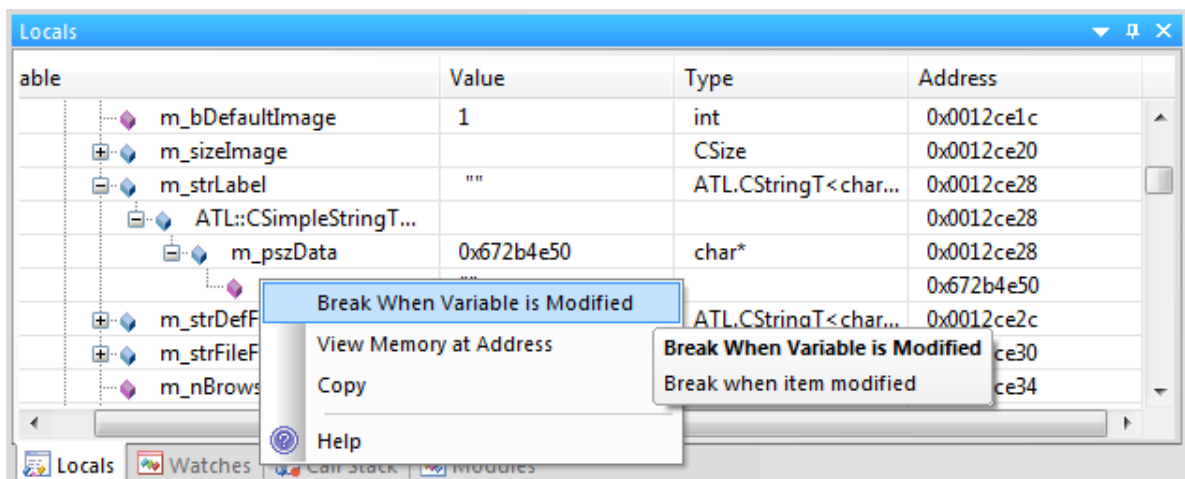

### 7.6.5.5 Debugging Actions

This section describes the actions you perform in running a debug session. It covers:

- [Displaying Windows](#)
- [Starting and Stopping the Debugger](#)
- [Debugging a Subsequent Process](#)
- [Stepping Over Lines of Code](#)
- [Stepping Into Function Calls](#)
- [Stepping Out of Functions](#)
- [Viewing the Call Stack](#)
- [Viewing the Local Variables](#)
- [Viewing the Content of Long Strings](#)
- [Viewing Variables in Other Scopes](#)
- [Inspecting Process Memory](#)
- [Setting Breaks for When a Variable Changes Value](#)
- [Showing Loaded Modules](#)

- [Showing Output from the Debugger](#)<sup>[1478]</sup>
- [Debugging Tooltips in Code Editors](#)<sup>[1479]</sup>

### 7.6.5.5.1 Displaying Windows

#### Debugger Actions - Displaying Windows

The [Debugger windows](#)<sup>[1467]</sup> are available from the **View | Execution Analyzer** menu options.

These windows can also be displayed and hidden from the debug management control checkboxes shown below:

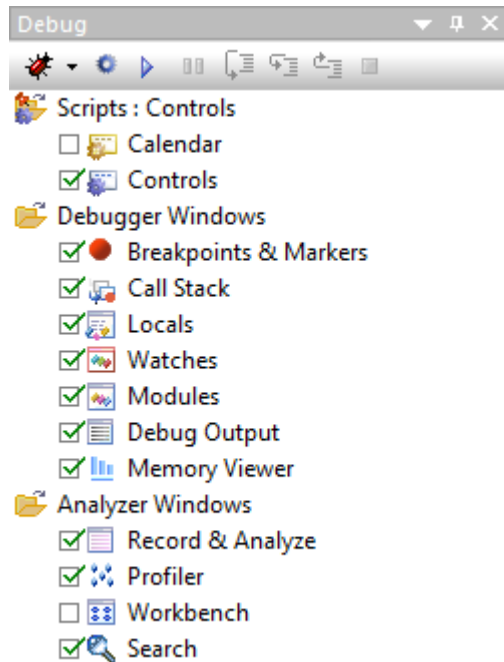

### 7.6.5.5.2 Start & Stop Debugger

#### Debugging Actions - Start & Stop

If [Basic Setup](#)<sup>[1425]</sup> has been completed, pressing **[F6]** starts the application using the configured Debugger.

If not, debugging is still possible by using the **Attach** button on either one of the **Debugger** toolbars.

To stop debugging, click on the **Stop** button  in the **Debug** window toolbar, or press **[Ctrl]+[Alt]+[F6]**.

#### Notes:

In most situations, the debugger ends:

- when it encounters breakpoints (which should be set beforehand)
- when the debug process terminates or
- when the Java Class thread exits.

However, due to the nature of the Java Virtual Machine, it is necessary at times for Java developers to stop the debugger manually with the **Stop** button.

### 7.6.5.5.3 Debug Another Process

#### Debugging Actions - Debug Another Process

When debugging another process, the **Attach To Process** dialog is displayed.

You can limit the processes displayed using the radio buttons at the top of the dialog. To find a service such as Apache Tomcat or ASP.NET, select the **System** radio button.

You must choose the debugger when you select a process. However, if the selected Package has already been configured for debugging then the Debugger listed is the one specified in the Script.

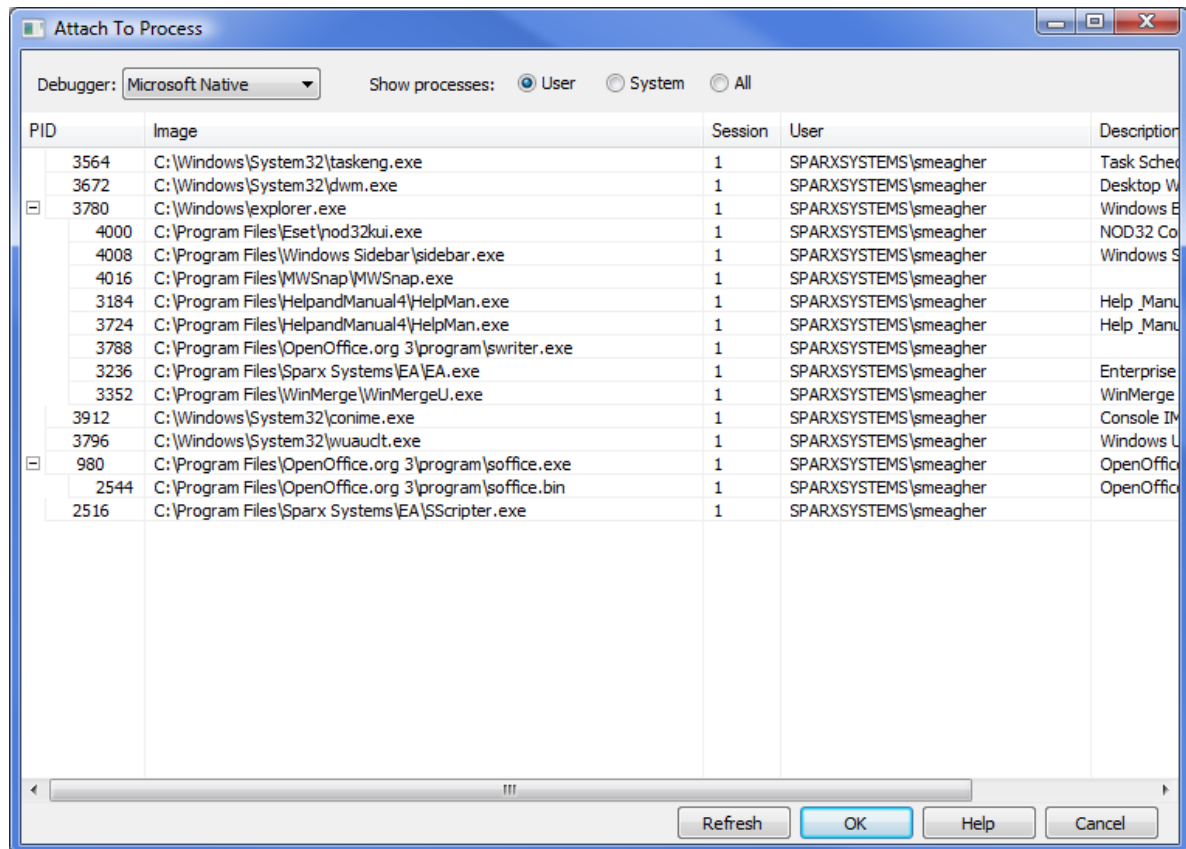

Once Enterprise Architect is attached to the process, any breakpoints encountered are detected by the debugger and the information is available in the **Debugger** windows.

To detach from a process, click on the **Debug Stop** button.

### 7.6.5.5.4 Step Over Lines of Code

#### Debugging Actions - Step Over

You can step over the lines of a function using the **Debug** toolbar buttons.

When you step to the end of the function, you step back to the caller.



Alternatively, press **[Alt]+[F6]** or select the **Project | Execution Analyzer | Step Over** context menu option.

### 7.6.5.5.5 Step Into Function Calls

#### Debugging Actions - Step In

The *Step In* function is executed by clicking on the **Step In** button.

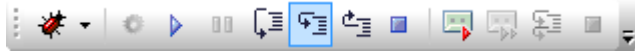

Alternatively, press **[Shift]+[F6]** or select the **Project | Execution Analyzer | Step In** context menu option.

If no source is available for the function then the debugger continues stepping until it either enters a new function or reaches the next line of the current one.

### 7.6.5.5.6 Step Out of Functions

#### Debugging Actions - Step Out

The Step Out function is executed by clicking on the **Step Out** button.

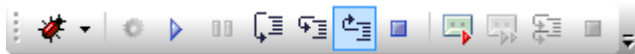

Alternatively, press **[Ctrl]+[F6]** or select the **Project | Execution Analyzer | Step Out** context menu option.

If no source is available for the function then the debugger will continue stepping till it either enters a new function or reaches the

next line of the current one.

### 7.6.5.5.7 View the Call Stack

#### Debugging Actions - View the Call Stack

The **Call Stack** window shows all currently running threads. A Stack trace is displayed whenever a thread is suspended, through one of the step actions or through encountering a [breakpoint](#)<sup>14681</sup>.

- A green or yellow arrow highlights the current stack frame
- A blue arrow indicates a thread that is running
- A red arrow indicates a thread for which a stack trace history is being recorded
- Double-clicking a frame takes you to that line of code in the **Source Code Editor**; local variables are also refreshed for the selected frame.

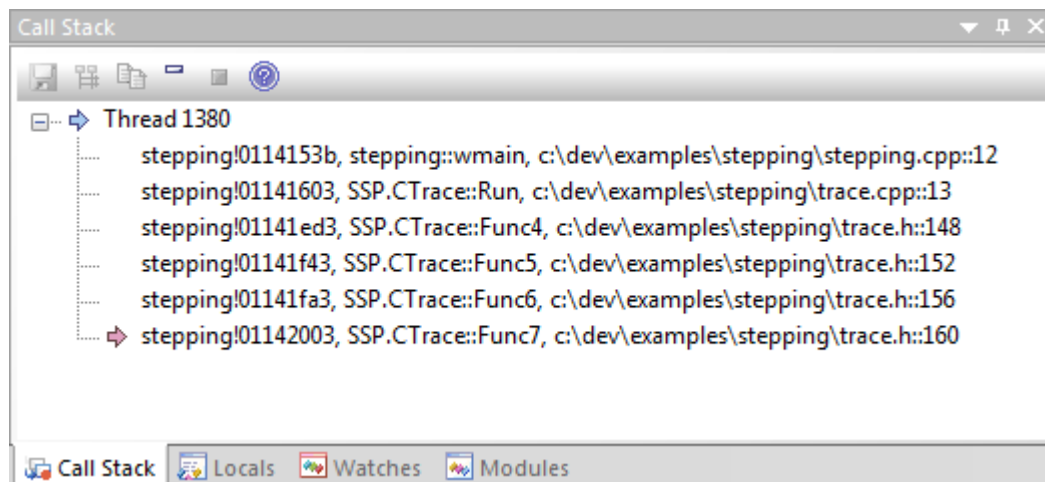



#### Toolbar



- Save Stack to file

 - Generate Sequence diagram from Stack

 - Copy Stack to recording history

 - Toggle Stack View

 - Stop recording

### 7.6.5.5.8 View the Local Variables

#### Debugging Actions - Viewing Local Variables

Whenever a thread encounters a [breakpoint](#)<sup>[1468]</sup>, this window displays all the local variables for the thread at its current [stack](#)<sup>[1473]</sup> frame.

The value and the type of any in-scope variables are displayed in a tree, as shown in the following screen:

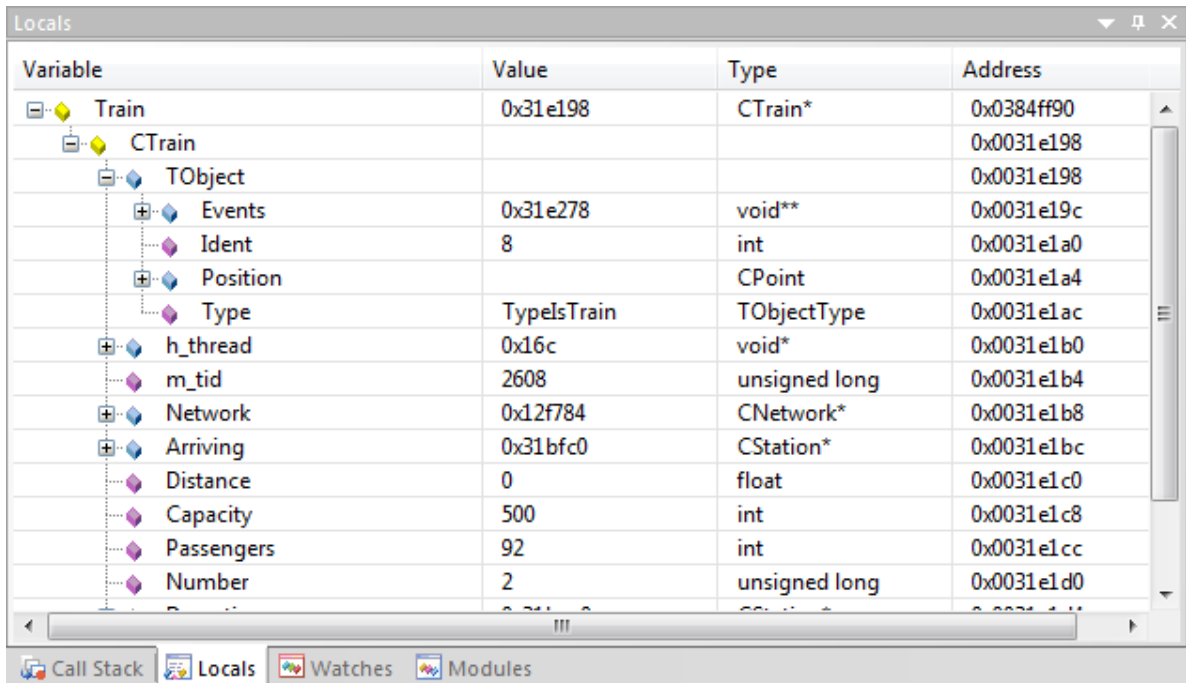

Variable	Value	Type	Address
Train	0x31e198	CTrain*	0x0384ff90
CTrain			0x0031e198
TObject			0x0031e198
Events	0x31e278	void**	0x0031e19c
Ident	8	int	0x0031e1a0
Position		CPoint	0x0031e1a4
Type	TypeIsTrain	TObjectType	0x0031e1ac
h_thread	0x16c	void*	0x0031e1b0
m_tid	2608	unsigned long	0x0031e1b4
Network	0x12f784	CNetwork*	0x0031e1b8
Arriving	0x31bfc0	CStation*	0x0031e1bc
Distance	0	float	0x0031e1c0
Capacity	500	int	0x0031e1c8
Passengers	92	int	0x0031e1cc
Number	2	unsigned long	0x0031e1d0

Local variables are displayed with colored box icons with the following meanings:

- Blue            Object with members
- Green          Arrays
- Pink           Elemental types
- Yellow         Parameters
- Red            Workbench Instance

### 7.6.5.5.9 View Content Of Long Strings

#### Debugging Actions - View Entire Content Of Long Strings

For efficiency, the **Locals** window only shows partial strings. The size of any variable value displayed in the window can be up to 256 characters.

To view the entire value of a variable, right-click on it and select the **View in Editor** context menu option. The

String Viewer dialog displays.

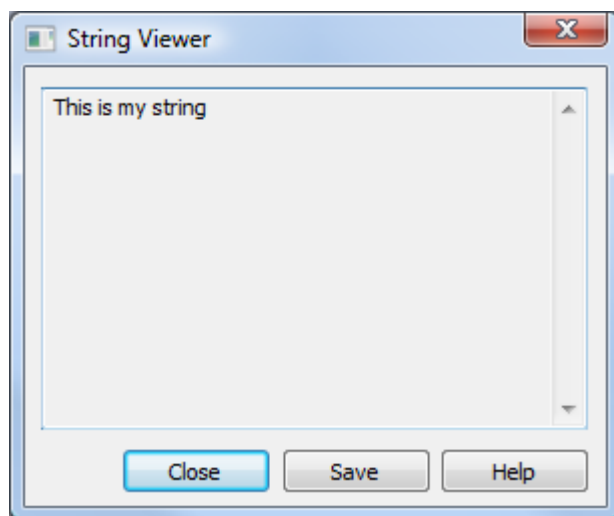
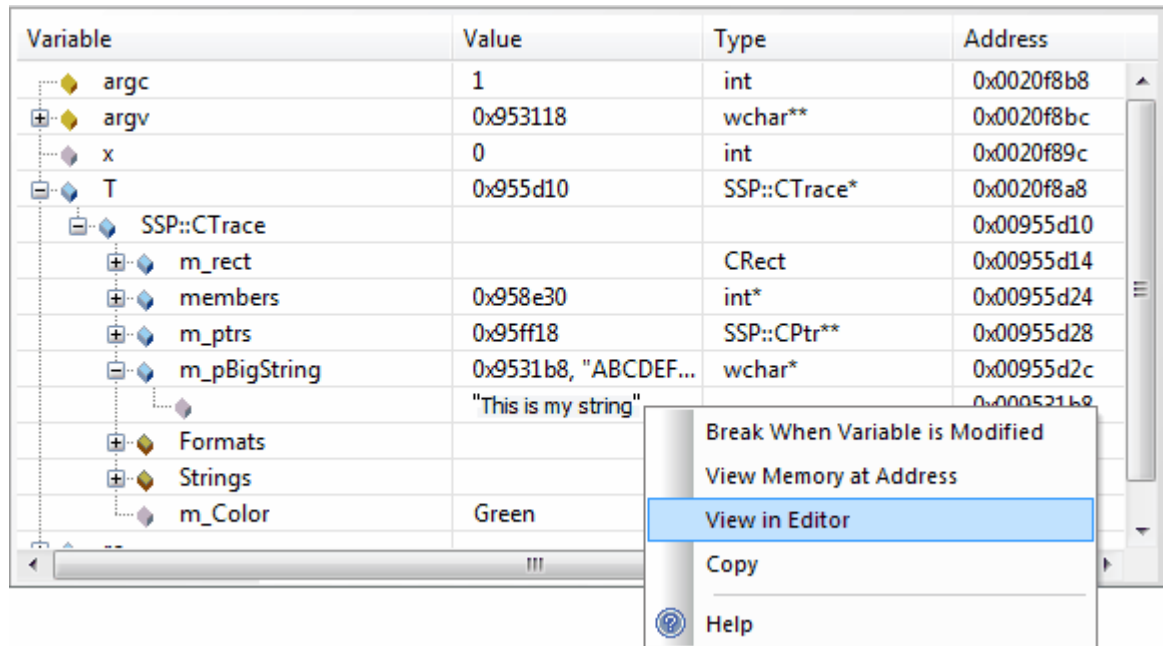

#### 7.6.5.5.10 View Variables in Other Scopes

##### Debugging Actions - Viewing the Variables in Other Scopes

The **Watches** window is most useful for native code (C, C++, VB) where it can be used to evaluate data items that are not available as [Local Variables](#) - data items with module or file scope and static Class member items.

You can also use the window to evaluate static Class member items in Java and .NET.

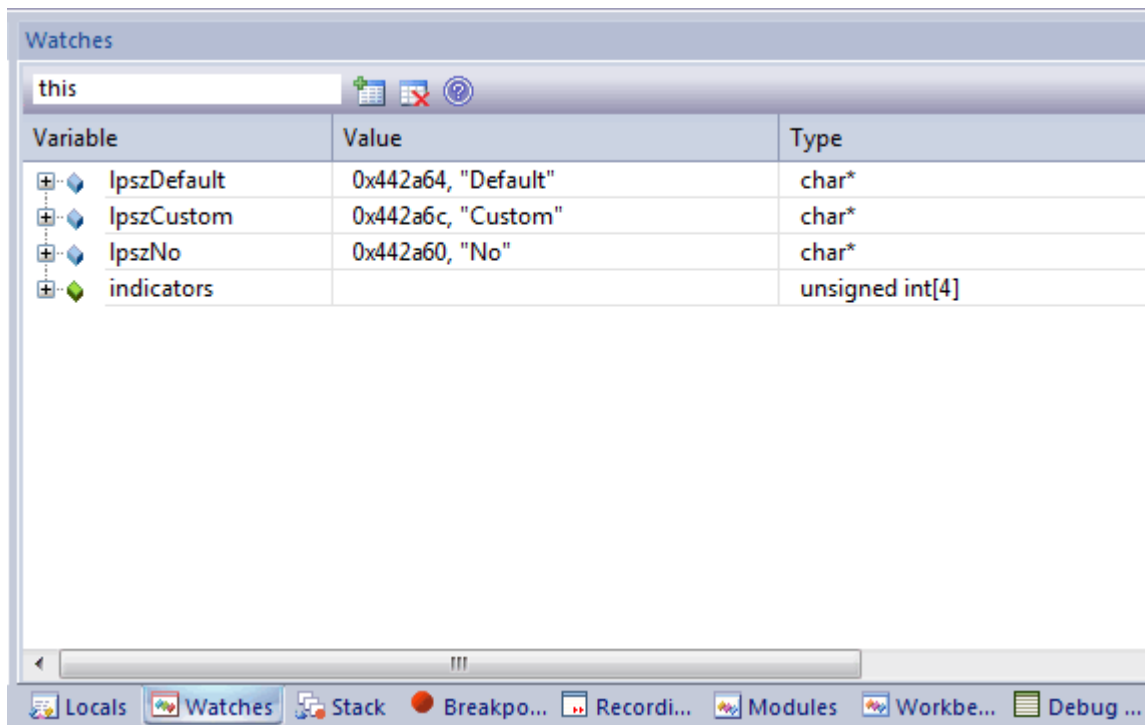

To use the **Watches** window, type the name of the variable to examine in the field in the window toolbar, and either press **[Enter]** or click on the **Add new watched item** icon.

To examine a static Class member variable in C++, Java or Microsoft .NET enter its fully qualified name. For example:

```
CMyClass::MyStaticVar
```

To examine a C++ data symbol with module or file scope, just enter its name. Note, items are evaluated only if the package in whose scope the item resides is currently loaded by the process being debugged. If the debugger is not running, no items are listed.

The names of the items to evaluate persist for the package and user ID, so the next time *you* debug the same project, the items evaluate automatically whenever a breakpoint occurs. They do not appear if another user debugs the same code.

If necessary, you can delete items using the **Delete all watched items** icon in the toolbar, or the right-click context menu options inside the window.

### 7.6.5.5.11 Inspect Process Memory

#### Debugging Actions - Inspecting Process Memory Debugging

You can display the raw values at a memory address or for a variable in a window using the **Memory Viewer** - select the **View Memory at Address** context menu option.



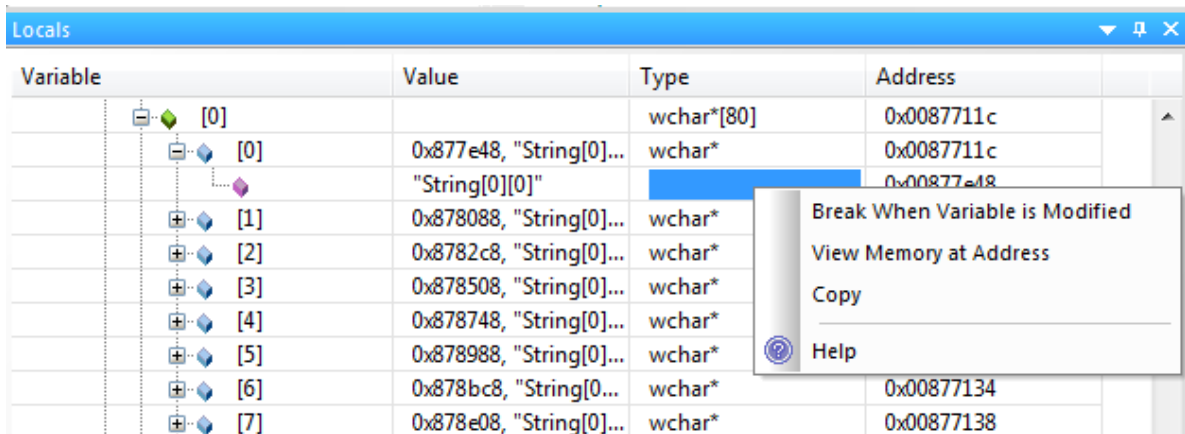

The **Memory Viewer** displays the raw values at a memory address

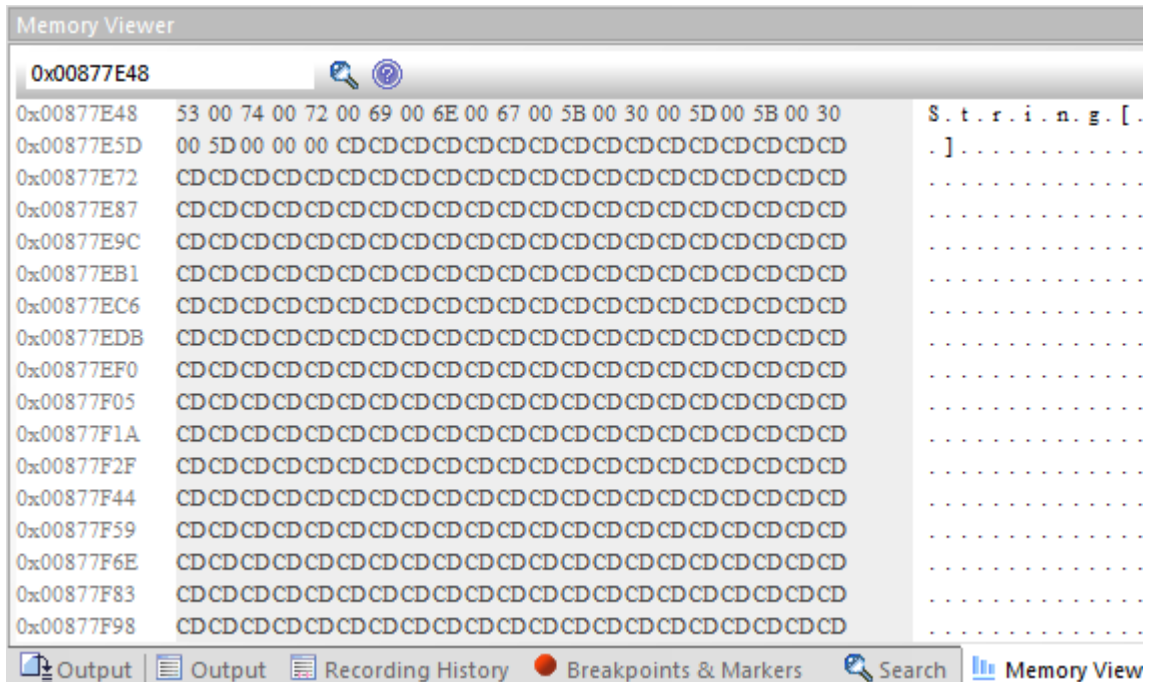

The **Memory Viewer** is available for debugging Microsoft Native Code Applications (C,C++,VB) running on Windows or within WINE on Linux.

**7.6.5.12 Break When a Variable Changes Value**

**Debugging Actions - Break when a Variable Changes Value**

An invalid or uninitialised variable can cause the program behaviour to differ from expected. This tool enables you to halt execution whenever a certain variable has its value changed.

**Note:**  
This feature is not presently supported by the Microsoft .NET platform.

The example below creates a notification on a variable from the **Watches** window. The item being watched is an integer in the **SSP** namespace scope.

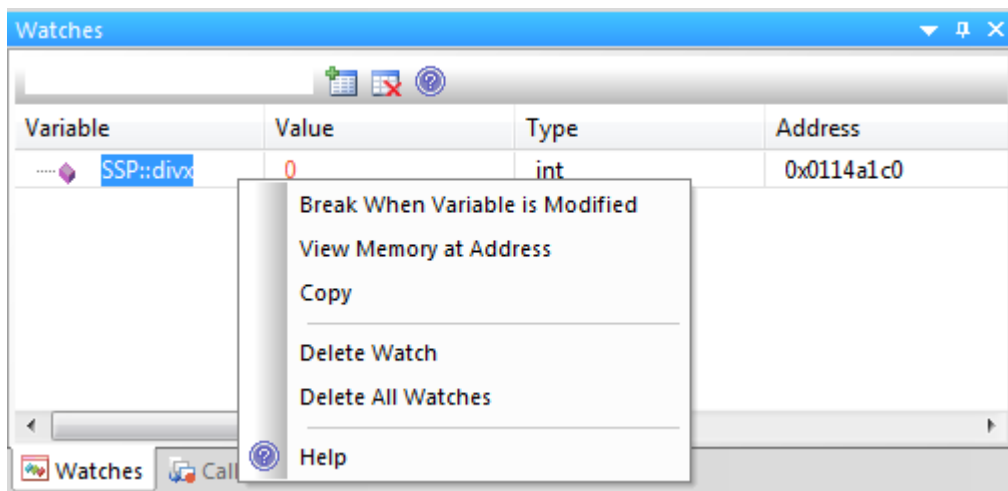

### 7.6.5.5.13 Show Loaded Modules

#### Debugging Actions - Show loaded modules

The debugger **Modules** window lists the modules loaded by the process being debugged.

Modules					
Path	Modified Date	Debug Sym...	Symbol File Match	Symbol Path	Modified Date
ntdll.dll		Export,False	True		
C:\Windows\system32\kernel32.dll	21/01/2008 2:24	Export,False	True		
C:\Benchmark\Native\TwoDLLs\Console.exe	19/01/2009 5:45	PDB,True,Lines	True	c:\Benchmark...	19/01/2009 5:45
C:\Benchmark\Native\TwoDLLs\Files.dll	19/01/2009 5:45	PDB,True,Lines	True	c:\Benchmark...	19/01/2009 5:45

The columns on this window are described below:

Column	Use To
<b>Path</b>	Determine the file path of the loaded module.
<b>Modified Date</b>	Determine the local file date and time the module was modified.
<b>Debug Symbols</b>	Establish the debug symbols type, whether debug information is present in the module and whether line information is present for the module (required for debugging).
<b>Symbol File Match</b>	Check the validity of the symbol file; if the value is false, the symbol file is out of date.
<b>Symbol Path</b>	Determine the file path of the symbol file, which must be present for debugging to work.
<b>Modified Date</b>	Determine the local file date and time the symbol file was created.

### 7.6.5.5.14 Show Output from Debugger

#### Debugging Actions - Show Output From Debugger

During a debug session the **Debugger** emits messages detailing both startup and termination of session, to its **Output** tab. Details of exceptions and any errors are also output to this tab. Any trace messages such as those output using *Java System.out* or *.NET System.Diagnostics.Debug* are also captured and displayed here.

```
Output
05/08/2009 09::49 Warning: no filters defined for package script; debugger will record every call
05/08/2009 09::49 Default Directory is Y:\Dev\Builds\Test Model Data\Debug & Profile\Microsoft .NET\
05/08/2009 09::49 Y:\Dev\Builds\Test Model Data\Debug & Profile\Microsoft .NET\Delegates\Delegate
05/08/2009 09::49 Debugger CLR runtime version is v2.0.50727
05/08/2009 09::49 Process created \Device\Mup\SPARXSYS02\SparxShare\Dev\Builds\Test Model Data\
05/08/2009 09::49 Debug process in domain DefaultDomain
05/08/2009 09::49 Debug process in domain Delegates2.exe
05/08/2009 09::49 Hello, A!
05/08/2009 09::49 Invoking delegate b:
05/08/2009 09::49 Goodbye, B!
```

### 7.6.5.5.15 Debug Tooltips in Code Editors

#### Debugging Actions - Viewing Variable Values in Code Editors

During debugging, whenever a thread is suspended at a line of execution, you can inspect member variables in the **Editor** window.

To evaluate a member variable, use the mouse to move the cursor over the variable in the **Editor** window, as shown in the following examples.

```
public void Print()
{
    int n = 0;
    while (names[n].Length > 0)
    {
        names = {[4] names[0]=book, names[0]=book, names[1]=novel, names[2]=film}, ...}
        Document d = new Document (names[n++]);
        d.Print();
    }
}
```

```
public void Print()
{
    int n = 0;
    while (32-bit signed integer n=0) 0)
    {
        Document d = new Document (names[n++]);
        d.Print();
    }
}
```

### 7.6.5.6 Recording Actions

This section describes how to perform the following debug recording actions:

- [Step through function calls](#) <sup>[1480]</sup>
- [Create a Sequence diagram of the Call Stack](#) <sup>[1480]</sup>
- [Save the Call Stack.](#) <sup>[1482]</sup>

#### 7.6.5.6.1 Step Through Function Calls

##### Debugging Actions - Step Through

The Step Through function can be executed by clicking on the **Step Through** button on the **Record & Analyze** window toolbar.



Alternatively, press **[Shift]+[F6]** or select the **Project | Execution Analyzer | Step Into** context menu option.

The *Step Through* command causes a *Step Into* command to be executed. If any function is detected, then that function call is recorded in the **History** window. The debugger then steps out, and the process can be repeated.

This button enables you to record a call without having to actually step into a function. The button is only enabled when at a breakpoint and in manual recording mode.

#### 7.6.5.6.2 Create Sequence Diagram of Call Stack

##### Debugging Actions - Create Sequence Diagram from Current Call Stack

To generate a Sequence diagram from the current Stack, click on the **Generate Sequence Diagram of Stack** button on the **Call Stack** window toolbar.

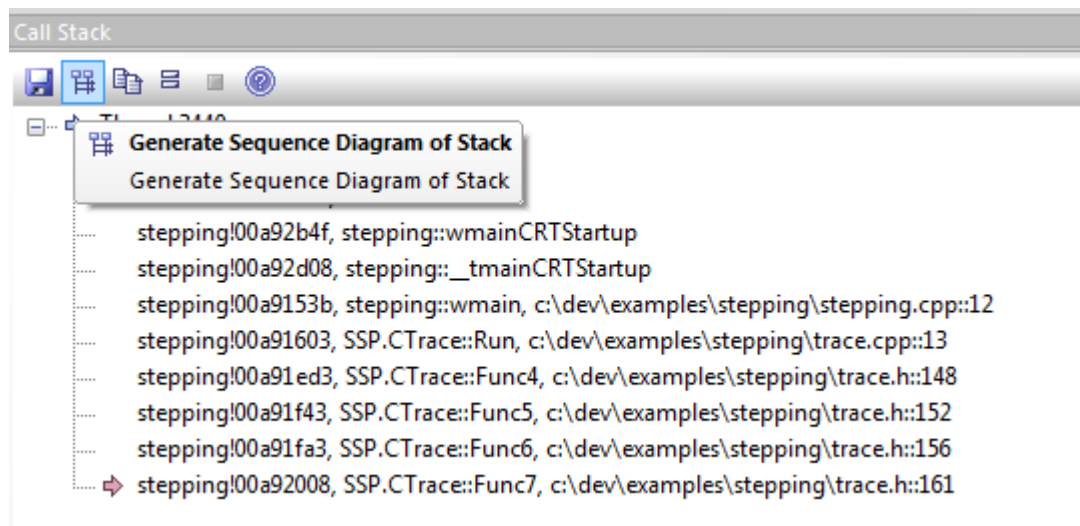

This immediately generates a Sequence diagram in the **Diagram View**.

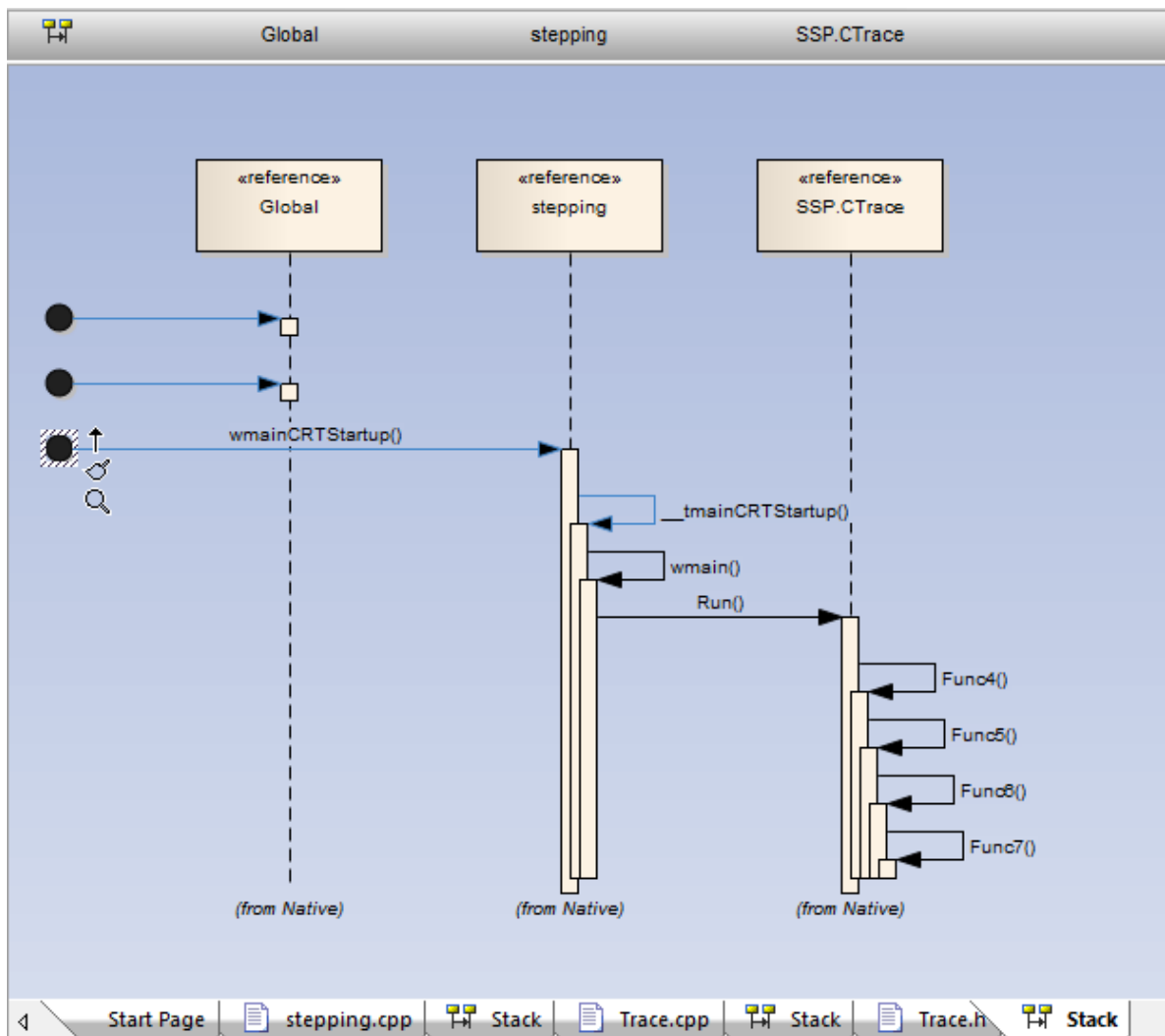

### 7.6.5.6.3 Saving the Call Stack

#### Debugging Actions - Saving the Call Stack

On the **Call Stack** window, you can save the current Stack to file or copy the Stack to the recording history.

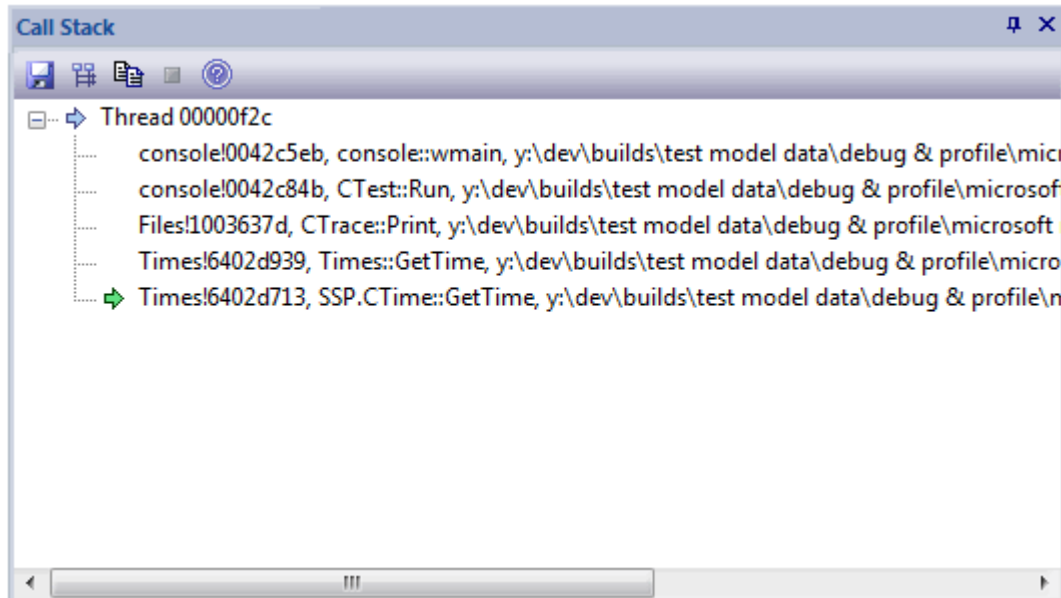

#### Toolbar



- Save Stack to file



- Copy Stack to recording history

## 7.6.6 Run

This section describes how to create a [command for running](#) <sup>[1482]</sup> your executable code.

### 7.6.6.1 Add Run Command

This topic explains how you enter a command for running your executable.

This is the command that is executed when you select the **Project | Execution Analyzer | Run** menu option. At its simplest, the script would contain the location and name of the file to be run.

#### Note:

Enterprise Architect provides the ability to start your application normally OR with debugging from the same script. The **Execution Analyzer** menu has separate options for starting a normal run and a debug run.

The following two examples show scripts configured to run a .Net and a Java application in Enterprise

Architect.

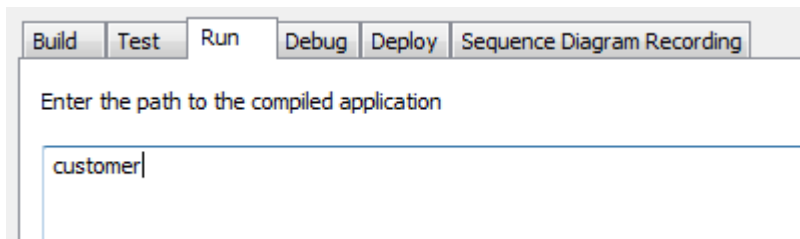
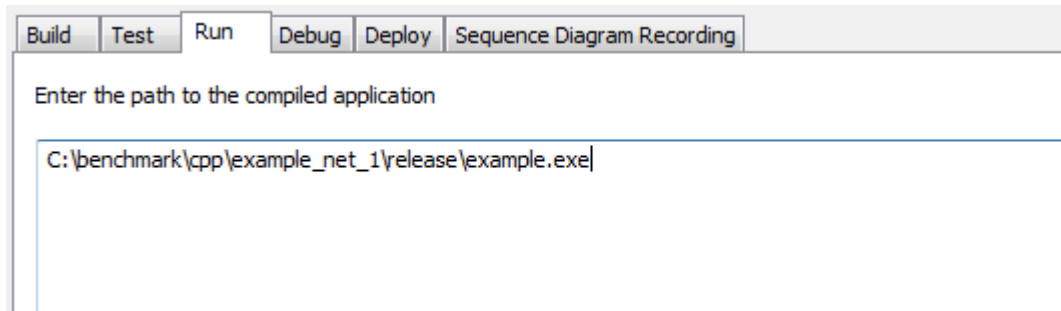

**Note:**

The command listed in this field is executed as if from the command prompt. As a result, if the executable path or any arguments contain spaces, they must be surrounded in quotes.

## 7.6.7 Testing

This section describes how to create a [command for performing unit testing](#)<sup>1483</sup> on your code.

### 7.6.7.1 Add Testing Command

This topic explains how you enter a command for performing unit testing on your code.

The command is entered in the text box using the standard *Windows Command Line* commands. A sample script would contain a line to execute the testing tool of your choice, with the filename of the executable produced by the **Build** command as the option. To execute this test select the **Project | Execution Analyzer | Test** menu option.

Testing could be integrated with any test tool using the command line provided, but in these examples you can see how to integrate *NUnit* and *JUnit* testing with your source code. Enterprise Architect provides an inbuilt MDA Transform from source to Test Case, plus the ability to capture *xUnit* output and use it to go directly to a test failure. *xUnit* integration with your model is now a powerful means of delivering solid and well-tested code as part of the complete model-build-test-execute-deploy life-cycle.

**Note:**

NUnit and JUnit must be downloaded and installed prior to their use. Enterprise Architect does not include these products in the base installer.

The **Capture Output** checkbox enables Enterprise Architect to show the output of the program in the **Output** window, while the **Output Parser** field specifies what format output is expected. When parsing is enabled, double-clicking on a result in the **Output** window opens the corresponding code segment in Enterprise Architect's code window.

Selecting the **Build before Test** checkbox ensures that the package is recompiled each time you run the test.

Two example test scripts are included below. The first is an NUnit example that shows the **Build before Test** checkbox selected. As a result, every time the test command is given it runs the build script first.

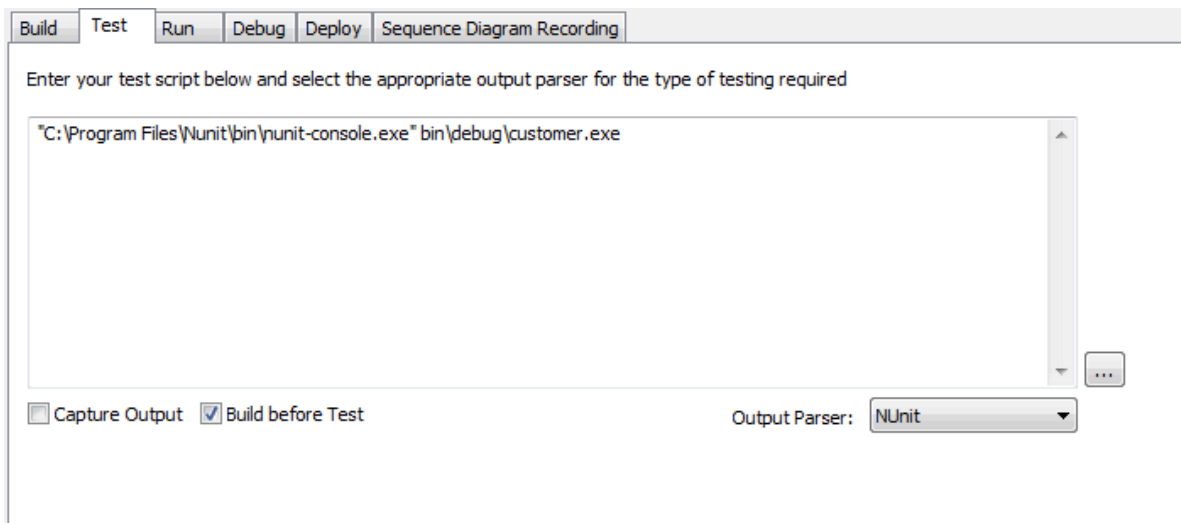
**Note:**

The command listed in this field is executed as if from the command prompt. As a result, if the executable path or any arguments contain spaces, they must be surrounded in quotes.

The second example is for JUnit. It doesn't have the **Build before Test** checkbox selected, so the build script won't be executed before every test, but as a result it could test out of date code. This also shows the use of %N, which is replaced by the fully namespace-qualified name of the currently selected Class when the script is executed.

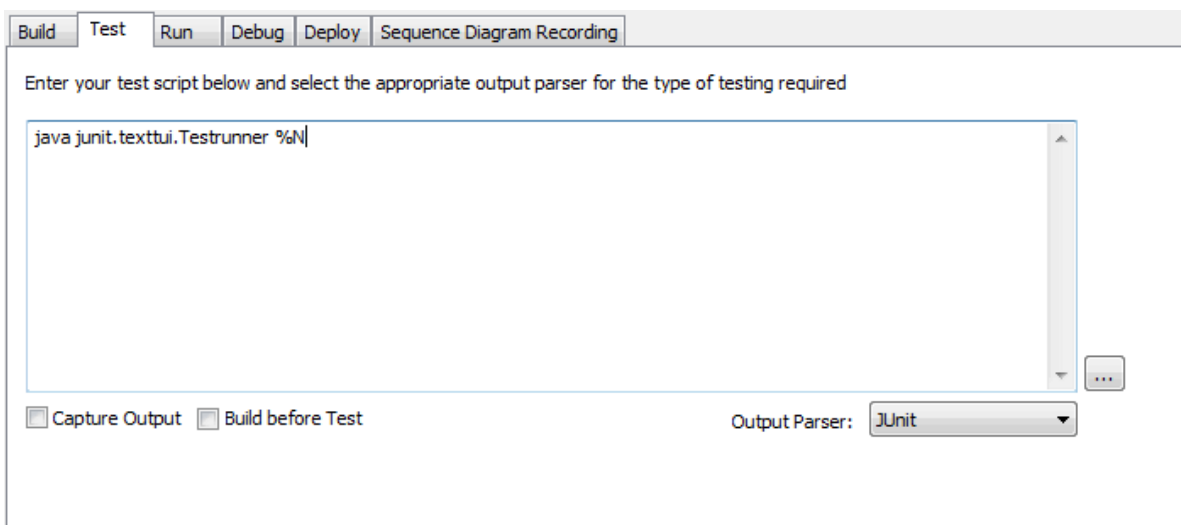

## 7.6.8 Deploying

This section describes how to create a [command for deploying](#)<sup>1484</sup> the current package.

### 7.6.8.1 Add Deploy Command

This topic enables you to create a command for deploying the current package.

These are the commands that are executed when you select the **Project | Execution Analyzer | Deploy** menu option.

Write your script in the large text box using the standard *Windows Command Line* commands.



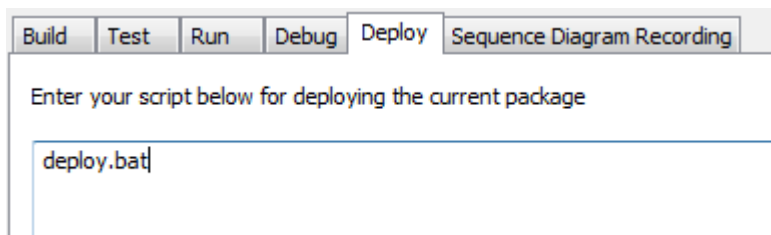

## 7.6.9 Searching Files

This topic describes how to use the [File Search](#) <sup>1485</sup> facility.

### 7.6.9.1 Search in Files

This topic describes the **File Search** control.

File Text Searches are provided by the **Search** Window and from within the Code Editors.

The **Search** window enables you to search for text in code files and scripts. You can select to display the results of the search in one of two formats:

- **List View** - each result line consists of the file path and line number, followed by the line text; multiple lines from one file are listed as separate entries

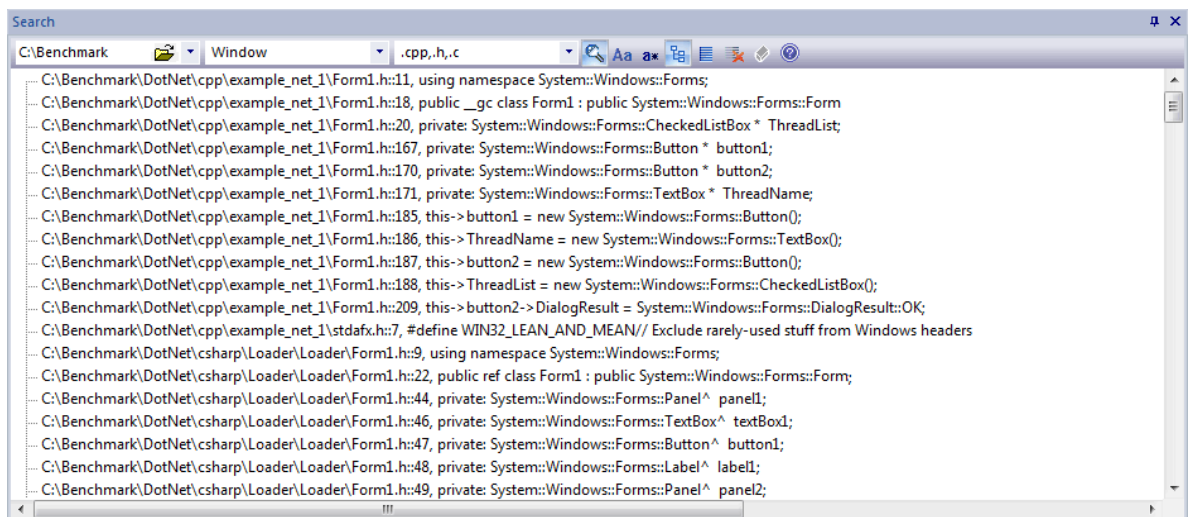

- **Tree View** - each result line consists of the file path that matches the search criteria, and the number of lines matching the search text within that file; you can expand the entry to show the line number and text of each line.

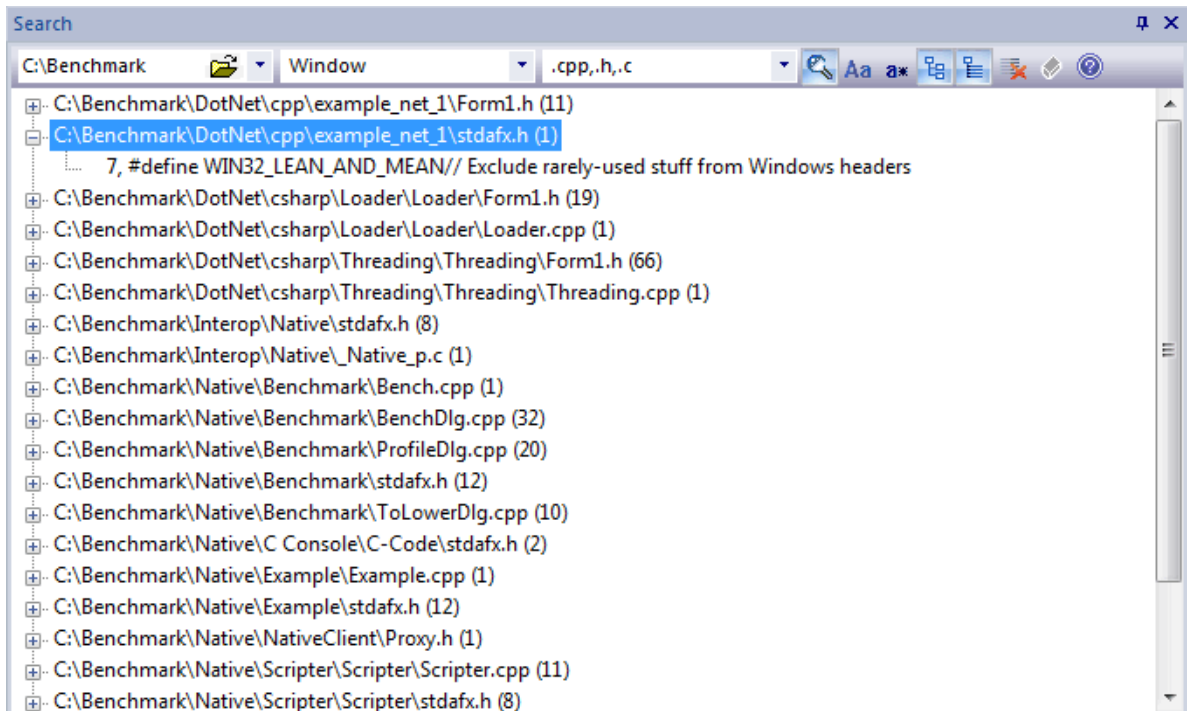

### Search Toolbar

You can use the toolbar options in the **Search** window to control the search operation. The state of all buttons persists over time to always reflect your previous search criteria.

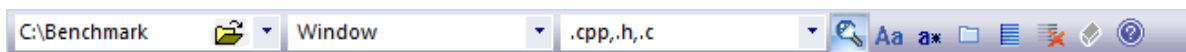

The options, from left to right, are as follows:

Option	Use to
<b>Search Path</b> list box	<p>Specify the folder to search.</p> <p>You can type the path to search directly into the text box, or click on the folder icon to browse for the path. Any paths you enter are automatically saved in the drop-down list, up to a maximum of ten; paths added after that overwrite the oldest path in the list.</p> <p>A fixed option in the drop-down list is <b>Search in Scripts</b>, which sets the search to operate on all local and user-defined scripts in the <b>Scripts</b> tab of the <b>Scripter</b> window. This option disables the <b>Search File Types</b> list box.</p>
<b>Search Text</b> list box	<p>Specify the text to look for.</p> <p>You can type the text directly into the text box or click on the drop-down arrow to select from a previous entry in the list. The search text you enter is automatically saved in the list when you click on the <b>Search</b> button.</p> <p>The list box saves up to ten search queries. Search queries added after that overwrite the oldest query in the list.</p>
<b>Search File Types</b> list box	<p>Limit the search to specific types of files. You can select multiple file types in a string, separated by either a comma or a semi-colon as shown in the image above.</p>
<b>Search</b> button	<p>Begin the search.</p> <p>During the course of the search all other buttons in the toolbar are disabled. You can cancel the search at any time by clicking on the <b>Search</b> button again.</p> <p>If you switch any of the toggle buttons below, you must run the search again to change the output.</p>

Option	Use to
<b>Case Sensitivity</b> button	Toggle the case sensitivity of the search. The tooltip message identifies the current status of the button.
<b>Word Match</b> button	Toggle between searching for any match and searching for only those matches that form an entire word. The tooltip message identifies the current status of the button.
<b>SubFolders</b> button	Toggle between limiting the search to a single path and including all subfolders under that path. The tooltip message identifies the current status of the button.
<b>Result View</b> button	Select the presentation format of the search results - List View or Tree View format.
<b>Clear Results</b> button	Clear the results.
<b>Clear Search Criteria</b> button	Remove all the entries in the <b>Search Path</b> , <b>Search Text</b> and <b>Search File Types</b> list boxes, if required.
<b>Help</b> button	Display this Help topic.

## 7.7 Visual Execution Analysis



The *Visual Execution Analyzer* provides facilities to model, develop, debug, profile and manage an application from within the modeling environment.

The Visual Execution Analyzer can generate a number of outputs, including:

- Sequence Diagrams, recording live execution of an application, or specific call stacks
- State Transition Diagrams, a Sequence diagram with states, illustrating changes in data structures
- Profiler reports, showing application sequences and operation call frequency.

These outputs provide a better understanding of how your system works, enabling you to document system features and providing information on the sequence of events that lead to an erroneous event or an unexpected system behavior.

### Note:

The Visual Execution Analyzer is available in the Enterprise Architect Professional, Corporate, Business and Software Engineering, System Engineering, and Ultimate editions.

### 7.7.1 Introducing the Visual Execution Analyzer



With the Visual Execution Analyzer, you can create and store custom scripts that specify how to build, test, run and deploy code associated with a package. You can investigate and manipulate the output of the debug process. The Analyzer also includes an *Execution Profiler*, which enables you to determine how the functions in an application are called and executed.

You access the Visual Execution Analyzer using the **Project | Execution Analyzer** menu option, or the context menu of the required package in the **Project Browser**. These menus provide a number of options to facilitate debugging, such as setting recording options or breakpoints.

The Visual Execution Analyzer can be used to:

- Optimize existing system resources and understand resource allocation
- Ensure that the system is following the rules as designed
- Produce high quality documentation that more accurately reflects system behavior
- Understand how and why systems work
- Train new employees in the structure and function of a system
- Provide a comprehensive understanding of how existing code works
- Identify costly or unnecessary function calls
- Illustrate interactions, data structures and important relationships within a system
- Trace problems to a specific line of code, system interaction or event
- Visualize why a sequence of events is important
- Establish the sequence of events that occur immediately prior to system failure.

## 7.7.2 Structure of the Visual Execution Analyzer



The Visual Execution Analyzer comprises a Model Driven Development Environment and an Execution Analyzer.

The [Model Driven Development Environment](#) <sup>[1277]</sup> (MDDE) provides tools to design, build and debug an application:

- [UML technologies](#) <sup>[1066]</sup> and tools to [model software](#) <sup>[370]</sup>
- [Code generation](#) <sup>[1308]</sup> tools to generate/reverse engineer source code
- Tools to import [source code](#) <sup>[1329]</sup> and [binaries](#) <sup>[1334]</sup>
- [Code editors that support different programming languages](#) <sup>[1425]</sup>
- [Intellisense to aid coding](#) <sup>[1432]</sup>
- [Package scripts that enable a user to describe how to build, debug, test and deploy the application](#) <sup>[1426]</sup>

```

BCGPCalendarDemoView.cpp
BCGPCalendarDemoView CreateDemo(BOOL)
1295         CLR_DEFAULT,
1296         RGB(0, 0, 255)
1297     ),
1298     FALSE, FALSE
1299 );
1300
1301 dt += COleDateTimeSpan(1, 0, 0, 0);
1302
1303 //-----
1304 // Create single appointment: 3-d day of week, 2:00 PM:
1305 //-----
1306 pApp = new CBCGPAAppointmentDemo
1307
1308
1309
1310
1311     RGB(165, 222, 99),
1312     CLR_DEFAULT,
1313     RGB(128, 0, 128)
1314 );

```

Tooltip: 2 of 2 CBCGPAAppointmentDemo::CBCGPAAppointmentDemo(COleDateTime& dtStart, COleDateTime& dtFinish, CString& strText, COLORREF clrBackground, COLORREF clrForeground, COLORREF clrDuration)

The [Execution Analyzer](#) <sup>[1490]</sup> (EA) provides tools to visualize an existing application's behaviour:

- [Record sequence diagrams of application activities](#) <sup>[1490]</sup>
- [Capture State Transitions for a particular State Machine](#) <sup>[1507]</sup>
- [Capture Stacktraces at points in execution](#) <sup>[1468]</sup>
- [Profiling tool to sample application activity](#) <sup>[1514]</sup>
- [Object Workbench](#) <sup>[1519]</sup>
- [Unit Testing](#) <sup>[1512]</sup>

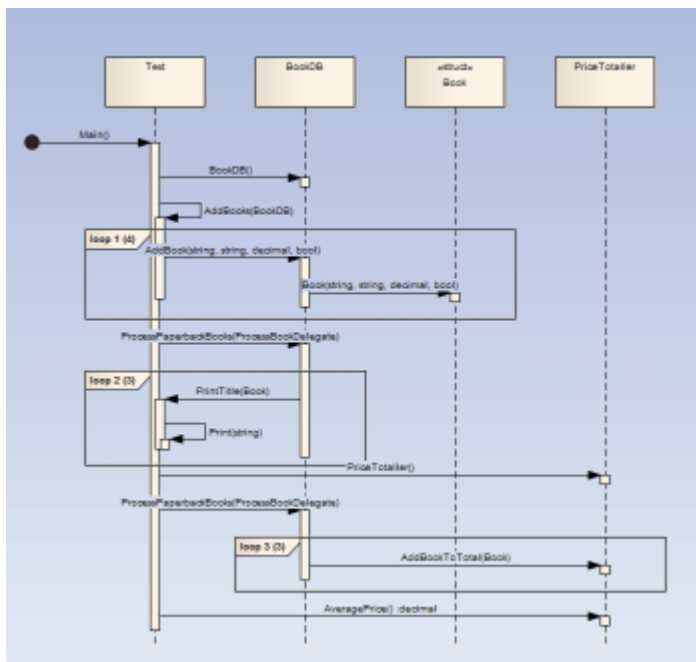

### 7.7.3 Execution Analysis



This section describes the Visual Analysis of executing applications by recording application execution and generating:

- Sequence Diagrams
- Sequence/State Diagrams
- Profile (execution) Reports

Execution analysis is configured by creating a [debug script](#)<sup>[1447]</sup> for the packages to be tested. One of the primary objectives of this feature is to enable you to perform a debug walk-through executing code, and capture your stack trace for direct conversion into a Sequence diagram. This is a great way to document and understand what your program is doing during its execution phase.

Execution Analysis debugging and recording are supported for the following platforms / languages:

- Microsoft Windows Native C
- Microsoft Windows Native C++
- Microsoft Windows Visual Basic
- Microsoft .NET Family (C#, J#, VB)
- Sun Microsystems Java.

#### 7.7.3.1 Recording Sequence Diagrams

This section explains how to use the Visual Execution Analyzer to record execution data in the form of a Sequence Diagram. It covers:

- [An overview of how the process works](#)<sup>[1491]</sup>
- [Setup for recording](#)<sup>[1492]</sup>
- [Placing recording markers](#)<sup>[1499]</sup>
- [Controlling the recording session](#)<sup>[1504]</sup>

- [Generating Sequence diagrams](#) <sup>[1505]</sup>
- [Adding State Transitions.](#) <sup>[1507]</sup>

### 7.7.3.1.1 How it Works

The Visual Execution Analyzer enables you to generate a Sequence Diagram. The diagram below illustrates the output of a Sequence Diagram for a program that calculates the price of books. The diagram creates a visual representation of the execution of an application, outlining what functions are being called, types of messages being sent, key data structure used and the relationships between different classes. The diagram makes it much simpler to Understand how information is moved throughout the system and what values are being passed by various functions. The first loop structure is executed four times and is being used to add four books to the book database. The arrows indicate information flow and demonstrate the change of states over time.

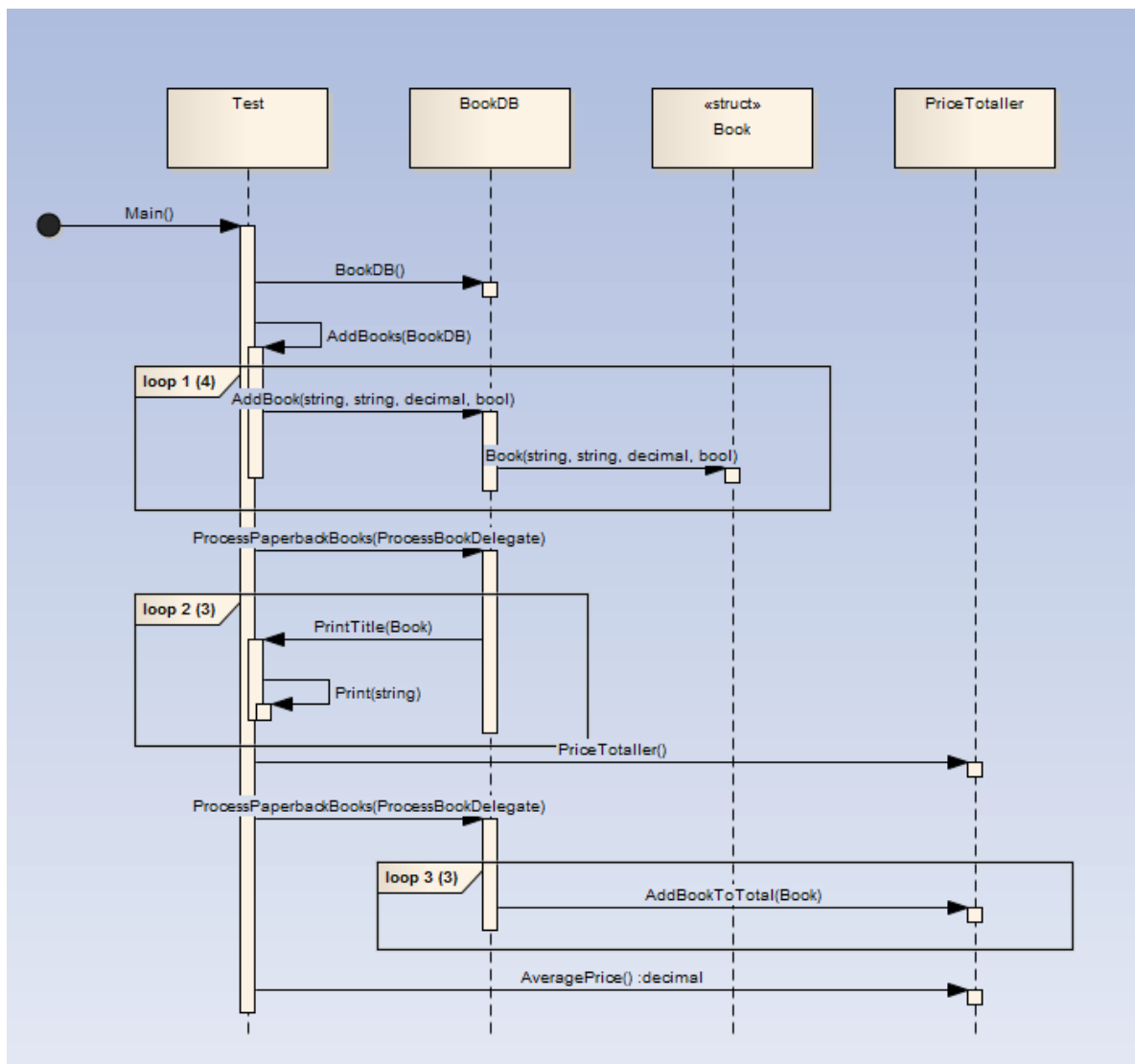

A Sequence diagram provides easy to understand visual information including:

- An understanding of how information is passed throughout a system.
- The sequence of various functions and their corresponding parameters.
- A clear understanding of how different classes interact to create behavior.
- A visual overview of how data structures are used to produce results.

If an application crashes, data corruption such as a stack overflow can prevent you from diagnosing and rectifying the problem. However the Visual Execution Analyzer allows you to record a given execution sequence and provide a reliable source of information that may further explain why a crash occurred. Enterprise Architect can record arguments to functions, record calls to external modules or capture state

transitions based on any given constraint. This information can be integrated with existing system knowledge and test data to optimize code execution, reduce errors and understand why application failure and system crashes occur.

A Sequence Diagram extends traditional analysis to help identify errors in logic, explain unexpected system behavior and identify data flow inconsistencies. The Visual Execution Analyzer extends analysis through the use of a comprehensive array of reports that detail everything from state transitions through to the contents of the stack at a given time. A Sequence Diagram can convey more detail and provide greater understanding than reading unfamiliar code that has potentially been written by someone else. It also makes it easier to document existing code when a Sequence Diagram illustrates functions are being called and the specific sequence of events that occur to produce a particular type of system behavior.

### 7.7.3.1.2 Setup for Recording

This section explains how you prepare to record execution of the application. It covers:

- [Prerequisites](#) <sup>[1492]</sup>
- [Configuring Recording Detail](#) <sup>[1492]</sup>
- [Advanced Techniques](#) <sup>[1497]</sup>

#### 7.7.3.1.2.1 Pre-Requisites

Recording is available to users of all editions of Enterprise Architect except the Desktop edition.

[Basic setup](#) <sup>[1425]</sup> must be completed.

You should first be able to successfully [debug](#) <sup>[1445]</sup> the application.

#### 7.7.3.1.2.2 Configure Recording Detail

The **Sequence Diagram Recording** tab enables you to set various options for generating Sequence diagrams from the debugger.

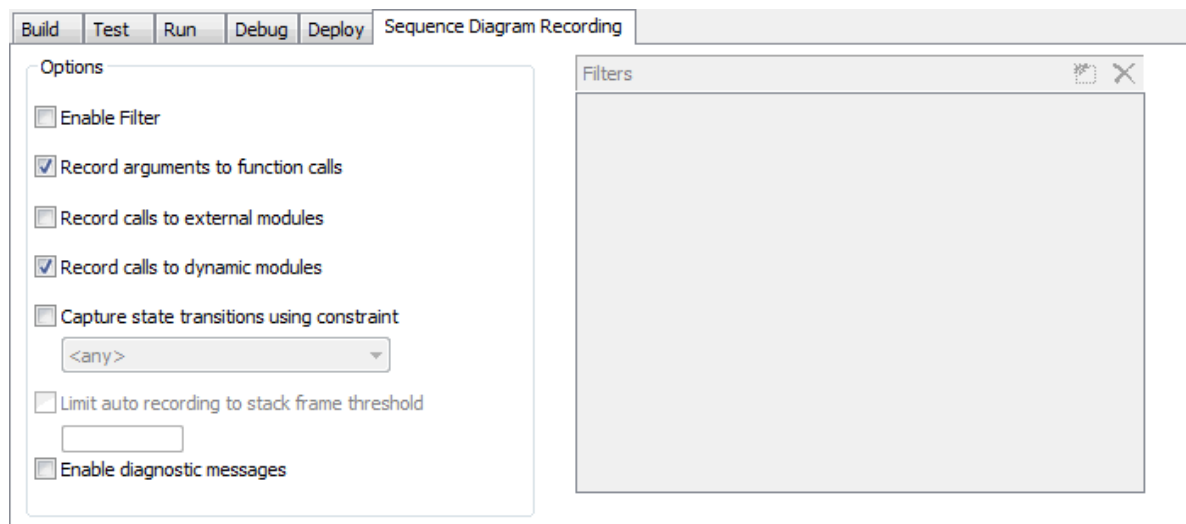

These options are not all available for each platform, as indicated in the following table:

Option	.NET	Java	Native
<a href="#">Enable Filter</a> <sup>[1493]</sup>	X	X	X
<a href="#">Record arguments to function calls</a> <sup>[1494]</sup>	X	X	X
<a href="#">Record calls to external modules</a> <sup>[1494]</sup>	X	X	X
<a href="#">Record calls to dynamic modules</a> <sup>[1495]</sup>	X	-	-
<a href="#">Capture state transitions using constraint</a> <sup>[1507]</sup>	X	X	X



Option	.NET	Java	Native
<a href="#">Limit auto recording to stack frame threshold</a> <small>1496</small>	X	X	X
<a href="#">Enable diagnostic messages</a> <small>1496</small>	X	X	X

If the **Enable Filter** option is selected on the **Sequence Diagram Recording** tab, the debugger excludes calls to matching methods from the generated sequence history and diagram. The comparison is case-sensitive.

To add a value, click on the **New** (Insert) icon in the right corner of the **Filters** box, and type in the comparison string. Each filter string takes the form:

```
class_name_token::method_name_token
```

The *class\_name\_token* excludes calls to all methods of a Class or Classes having a name that matches the token. The string can contain the wildcard character \* (asterisk). The token is optional.

The *method\_name\_token* excludes calls to methods having a name that matches token. The string can contain the wildcard character \*. The token is optional.

Where no Class token is present, the filter is applied only to global or public functions; that is, methods not belonging to any Class.

To Filter	Use Filter Entry
All public functions having a name beginning with <b>Get</b> from the recording session ( <i>GetClientRect</i> for example in Windows API).	::Get*
All methods beginning with <b>Get</b> for every Class member method.	*::Get*
All methods beginning with <b>Get</b> from the Class <i>CClass</i> .	CClass::Get*
All methods for Class <i>CClass</i> .	CClass::*
All methods for Classes belonging to Standard Template and Active Template Libraries.	<ul style="list-style-type: none"> <li>• ATL*</li> <li>• std*</li> </ul>
The specific method <i>GetName</i> for Class <i>CClass</i> .	CClass::GetName

In the Java example in the screen below, the debugger would exclude:

- Calls to the *OnDraw* method for the Class *Example.common.draw.DrawPane*
- Calls to any method of any Class having a name beginning with *Example.source.Collection*
- Calls to any constructor for any Class (ie: *<clint>* and *<init>*).

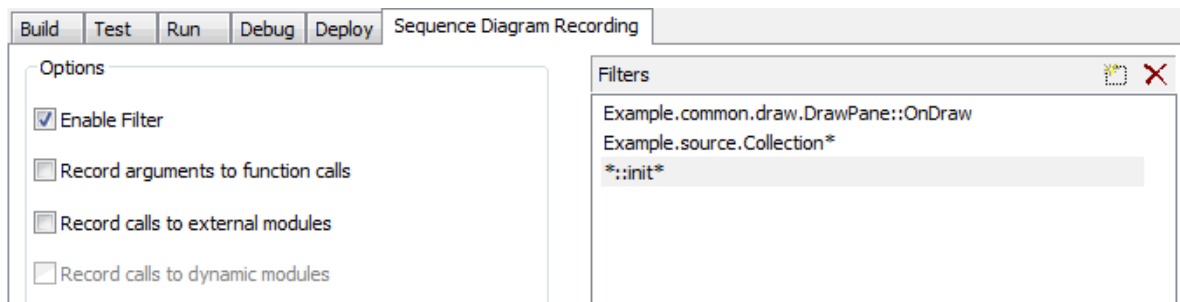

In the Native code example below, the debugger would exclude:

- Calls made to Standard Template Library namespace
- Calls to any Class beginning with **TOb**
- Calls to any method of Class *CLock*
- Calls to any Global or Public Function with a name beginning with **Get**
- Calls to the method *GetLocation* for Class *Ctrain*.

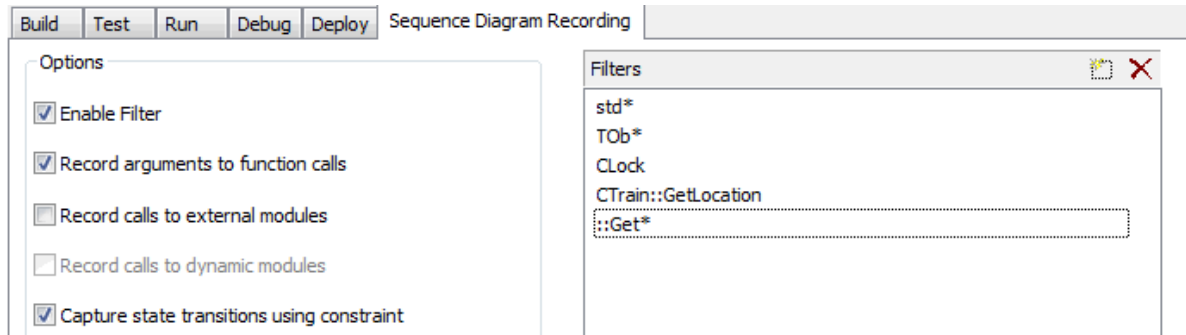

When recording the sequence history, Enterprise Architect can record the arguments passed to method calls.

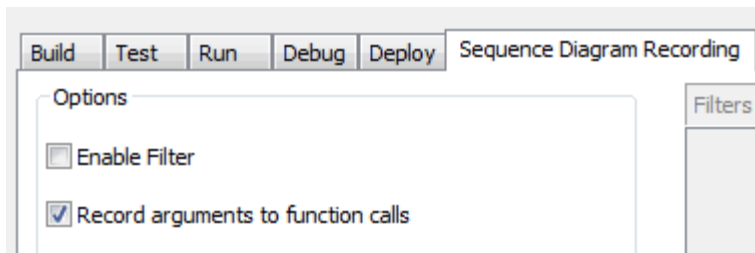

When the **Record Arguments to function calls** option is selected on the **Build Script dialog Sequence Diagram Recording** tab, the resulting Sequence diagram shows the values of elemental and string types passed to the method. See the following Java example.

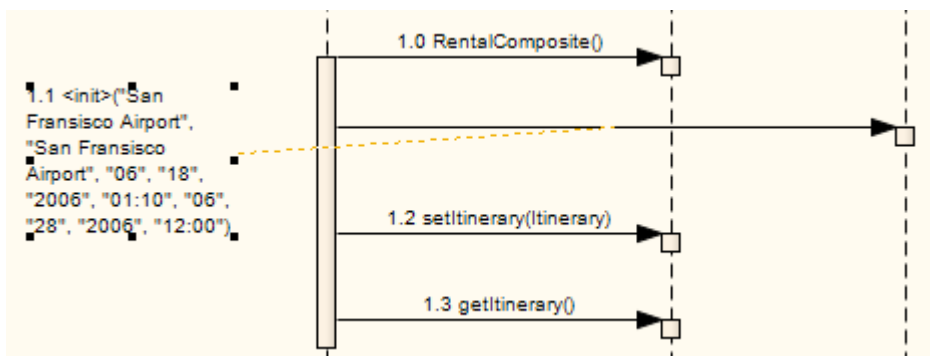

Where the argument is not an elemental type, the type name is recorded instead.

On the **Sequence Diagram Recording** tab, the **Record calls to external modules** option causes function calls to external modules outside the model to be included in the sequence history and generated diagram.

For applications built in a Microsoft Native code (C, C++) you can record calls to the WIN32 API if required, using the **Record calls to external modules** option. This option can also be used to record calls to functions in modules that have a PDB file but for which there is no source.

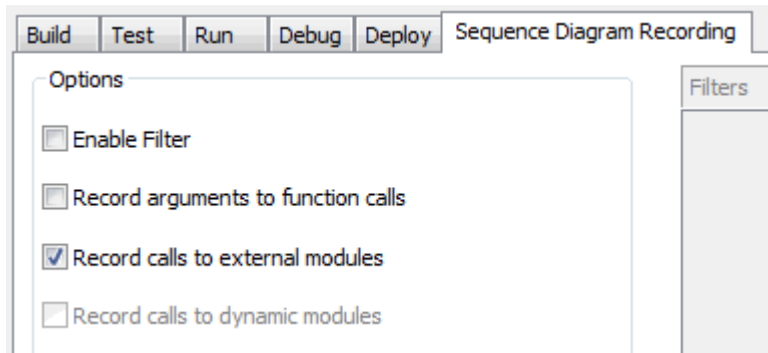

Only calls originating within the model to functions external to the model are recorded.

**Note:**

External calls are displayed with a blue connector, as shown below.

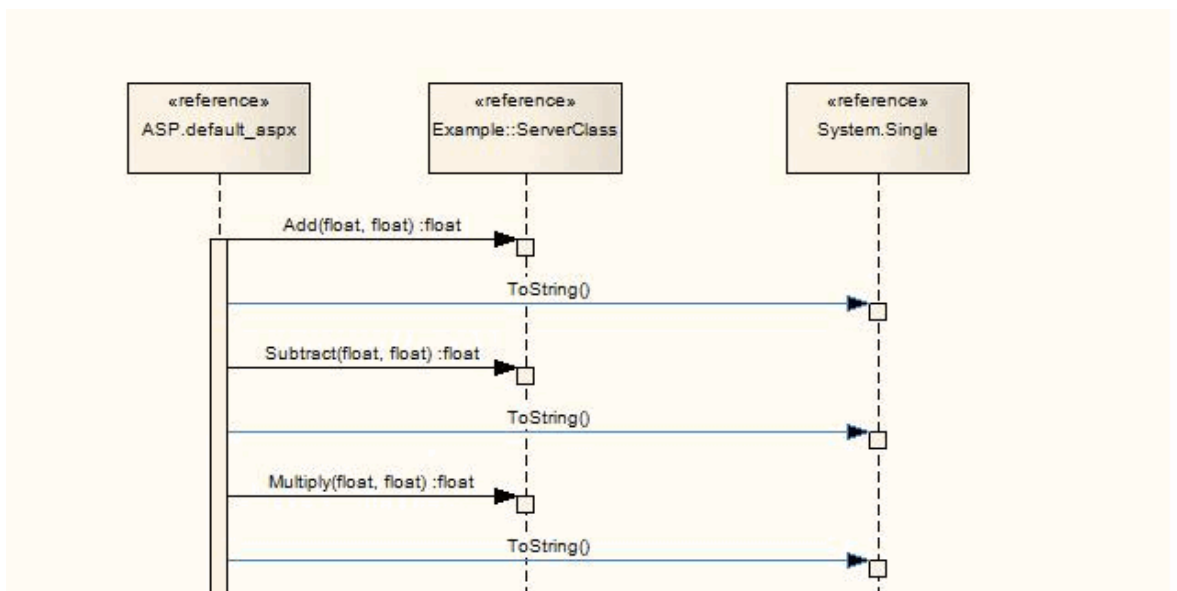

This example shows three external calls (*ToString()*) to the Microsoft .NET framework assembly function *System.Single*.

(Available only for .NET platforms.)

On the **Sequence Diagram Recording** tab, the **Record calls to dynamic modules** option causes the debugger to record execution of dynamic or 'In Memory' function calls, in transitions between normal assemblies and those emitted dynamically.

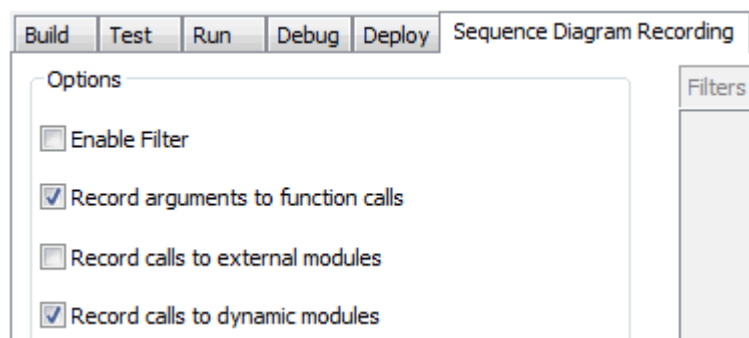

Where the **Stack** window shows recording to be involved in function calls that are not particularly useful, and that are not being excluded in a filter, you can achieve a quicker and more general picture of a sequence by limiting the stack depth being recorded. You can do this on the **Sequence Diagram Recording** tab, by selecting the **Limit auto recording to stack frame threshold:** option.

If you use this option, be aware that the threshold value you set is a relative frame count; that is, the count is relative to the frame at which recording begins. For example:

A breakpoint has occurred, and the **Stack** window shows five frames. If the stack frame threshold is set to 3 and you begin auto-recording at this breakpoint, the debugger records all function calls between the current frame 5 and a maximum stack frame depth of 8 inclusive.

For situations during auto-recording where the stack is very large, it is recommended that you first use a low stack frame threshold of 2 or 3, gradually increasing it if necessary to expand the picture. You can also use the threshold to work out which filters you could add to the script in order to further clarify the Sequence diagram that is ultimately produced.

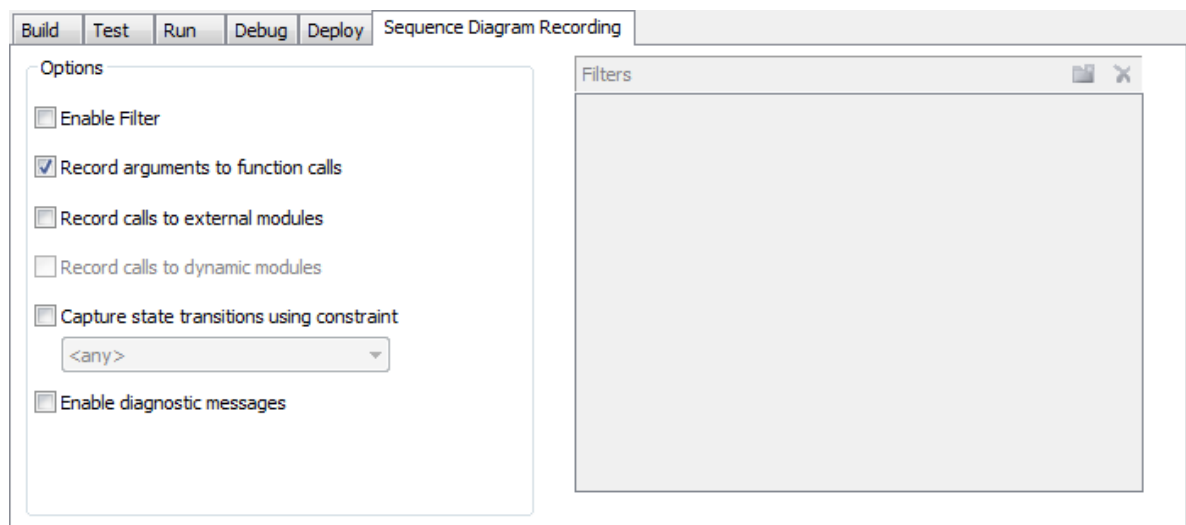

The **Enable diagnostic messages** checkbox triggers the debugger to output more self-reporting, diagnostic messages as it executes. For example, the debugger might output messages about method calls that are being excluded from the recording history due to a filter also having been set in the **Sequence Diagram Recording** tab of the **Build Script** dialog.

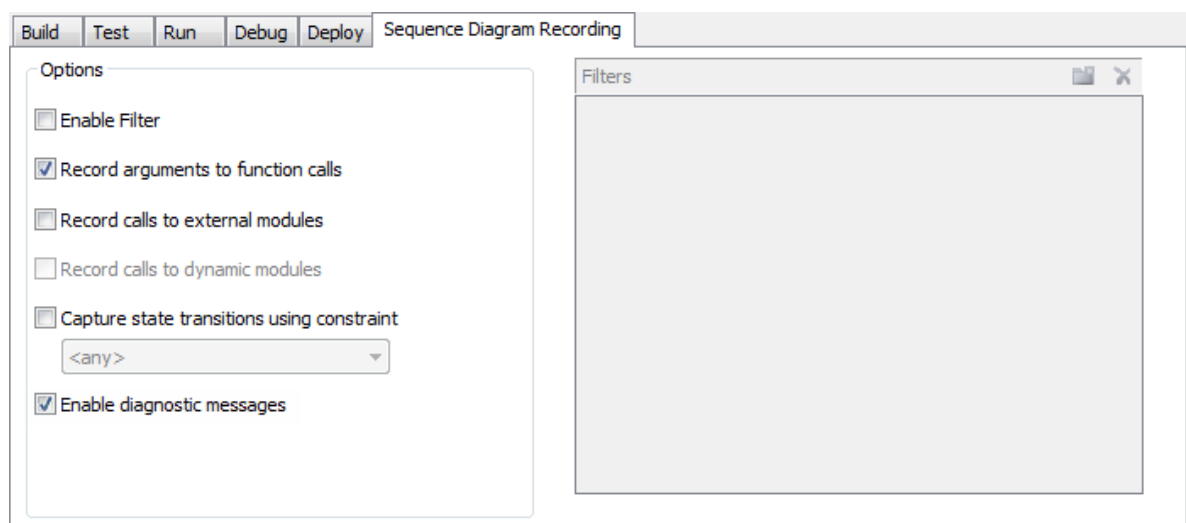

### 7.7.3.1.2.3 Advanced Techniques

This section describes the advanced techniques for configuring recording detail:

- [Recording Activity for a Class](#)<sup>[1497]</sup>
- [Recording Activity for a single method](#)<sup>[1498]</sup>

In addition to setting breakpoints and markers in the code editor, you record all the operations of a class, or a subset by using the *Class Markup* Feature.

This feature is available from the **Project Browser** context menu while on a Class. Select the operations to record, choose the marker type and enter a name for the set. When you click on the **OK** button the markers are stored as a marker set using the name you specify.

This set can then be loaded either before or during a session.

The marker type specifies the action to take when the process encounters that marker.

- Record function
- Record Stack Trace
- Break execution

You can also specify a recording depth. This limits the recording, which if uncontrolled can ultimately produce Sequence Diagrams that are too complicated to read. When you specify a depth, the Debugger does not record beyond this depth.

The depth is relative to the stack depth where the Debugger first encountered the recording marker. So, if the stack depth is 7 when recording begins, and the Limit Depth is set to 3, the Debugger does not record beyond a Stack depth of 10.

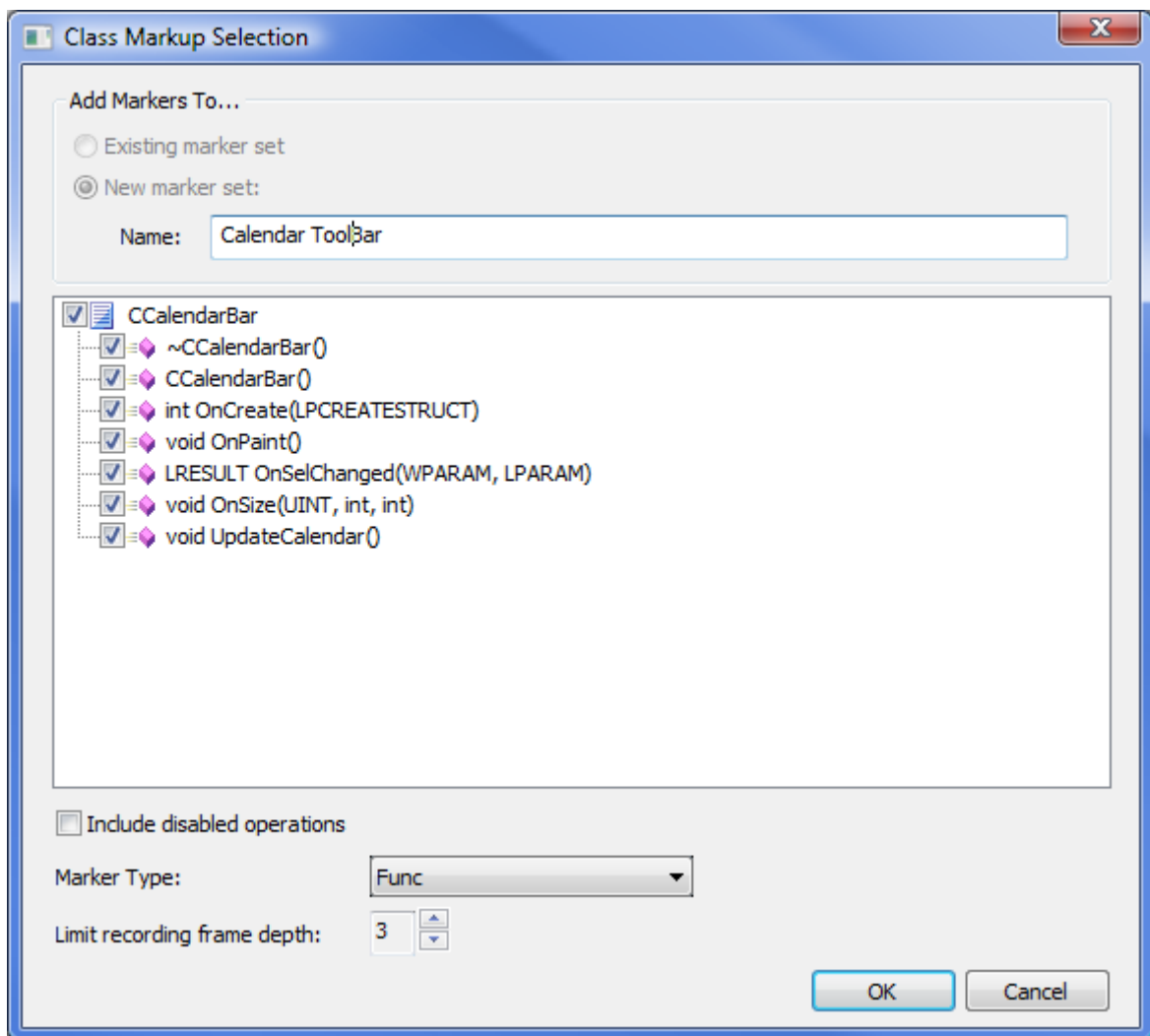

A [Method Auto Record](#)<sup>[1499]</sup> marker enables you to record activity for a particular function during a debug session. The debugger records any function calls executed after the marker point, and always stops recording when this function exits. The function marker combines a Start Recording marker and an End Recording marker in one.

```

185 ///////////////////////////////////////////////////////////////////////////////////////////////////////////////////////////////////
186 // CRecurrenceDlg message handlers
187
188 BOOL CRecurrenceDlg::OnInitDialog()
189 {
190     CBCGPDialog::OnInitDialog();
191
192     UINT nMask =
193         CBCGPDateTimeCtrl::DTM_SPIN           |
194         CBCGPDateTimeCtrl::DTM_DATE          |
195         CBCGPDateTimeCtrl::DTM_TIME          |
196         CBCGPDateTimeCtrl::DTM_CHECKBOX      |
197         CBCGPDateTimeCtrl::DTM_DROPCALENDAR |
198         CBCGPDateTimeCtrl::DTM_CHECKED;
199
200     UINT nFlags = CBCGPDateTimeCtrl::DTM_CHECKED | CBCGPDateTimeCtrl::DI
201     //-----
202     // Setup date fields:

```

### 7.7.3.1.3 Place Recording Markers

This section explains how to deploy recording markers:

- [Marker types](#) <sup>[1499]</sup>
- [Setting Recording Markers](#) <sup>[1502]</sup>
- [The Breakpoint and Markers window](#) <sup>[1503]</sup>
- [Activate and Disable Markers](#) <sup>[1503]</sup>
- [Working with Marker Sets](#) <sup>[1503]</sup>
- [Differences between breakpoints and markers.](#) <sup>[1503]</sup>

#### 7.7.3.1.3.1 Marker Types

Trace marking is a feature that enables you to silently record code executed between two points, and incorporate it in a Sequence diagram. The feature also enables you to capture the execution of multiple threads. It can be particularly useful in capturing event driven sequences (such as mouse and timer events) without any user intervention.

The recording markers are breakpoints; however, instead of stopping, the debugger behaves according to the type of marker. If the marker is denoted as a recording *start point*, the debugger immediately begins to trace all executed calls from that point for the breaking thread. Recording is stopped again when either the thread that is being captured terminates or the thread encounters a *recording end point*.

Recording markers are set in the source code editor. If you right-click on the breakpoint margin at the point to begin recording, a context menu displays:

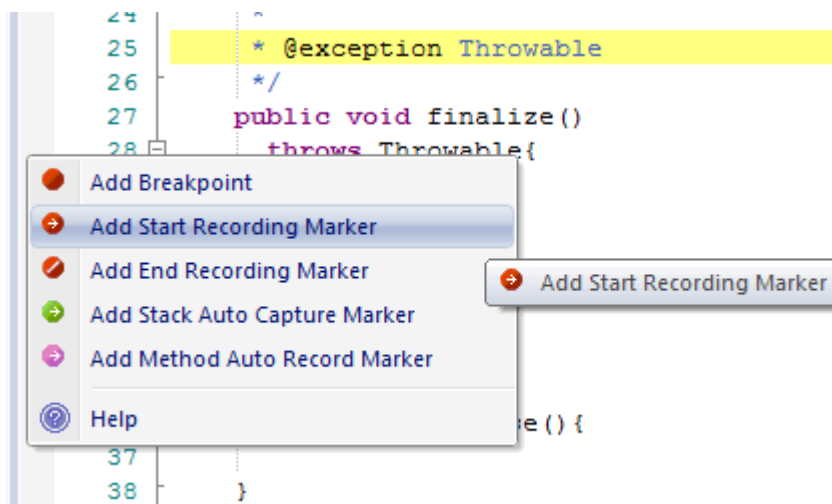

Select the **Add Start Recording Marker** option, then right-click on the breakpoint margin at the point to stop recording and select the **Add End Recording Marker** context menu option. The markers are shown below:

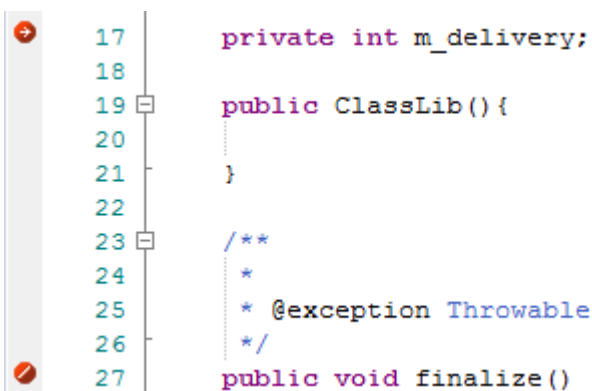

When the debugger is run it continues to run the thread, recording a stack history, until either the **End**

**Recording** marker is encountered or the thread terminates, unlike normal breakpoints where the debugger halts and displays the line of code.

It is useful to [limit the stack depth](#) <sup>[1496]</sup> when recording particularly high-level points in an application, as the stack frame count can result in too much information being collected. You can limit stack depth using the [Sequence Diagram Recording](#) tab on the [Build Script](#) dialog.

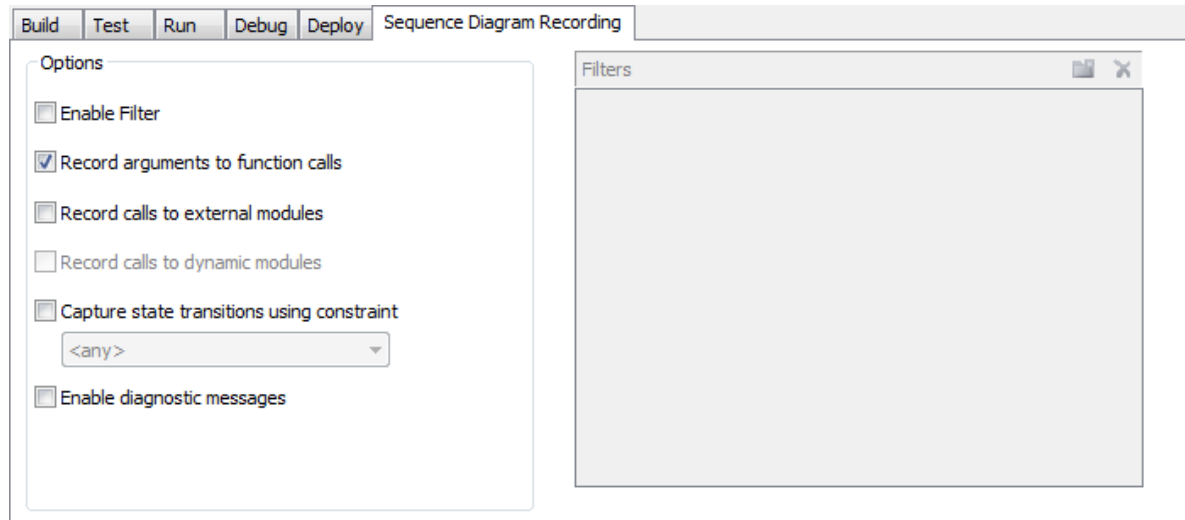

Running this Calendar example with the one function record marker in *CRecurrenceDlg::OnInitDialog()* produced the following output in the [Recording History](#) window:

Sequence	Insta...	Method	Direction	Method
00000001			Call	CRecurrenceDlg.OnInitDialog
00000002		CRecurrenceDlg.OnInitDialog	Call	CBCGPDIALOG.OnInitDialog
00000003		CBCGPDIALOG.OnInitDialog	Call	CBCGPDIALOG.IsVisualManagerStyle
00000004			Return	CBCGPDIALOG.OnInitDialog
00000005		CBCGPDIALOG.OnInitDialog	Call	CBCGPDIALOG.IsVisualManagerNCArea
00000006			Return	CBCGPDIALOG.OnInitDialog
00000007		CBCGPDIALOG.OnInitDialog	Call	CBCGPDIALOGImpl.EnableVisualManagerStyle
00000008		CBCGPDIALOGImpl.EnableVisualManagerStyle	Call	CBCGPDIALOGImpl.GetThisClass
00000009			Return	CBCGPDIALOGImpl.EnableVisualManagerStyle
00000010		CBCGPDIALOGImpl.EnableVisualManagerStyle	Call	ATL.operator==
00000011			Return	CBCGPDIALOGImpl.EnableVisualManagerStyle
00000012		CBCGPDIALOGImpl.EnableVisualManagerStyle	Call	ATL.operator==
00000013			Return	CBCGPDIALOGImpl.EnableVisualManagerStyle
00000014		CBCGPDIALOGImpl.EnableVisualManagerStyle	Call	CBCGPDIALOGImpl.CBCGPGROUP
00000015			Return	CBCGPDIALOGImpl.EnableVisualManagerStyle

## Stack Auto-Capture Marker

```

76 | /* End - EA generated code for Parts and Ports */
77 | /* Begin - EA generated code for Activities and I
78 | public void ClassLib_ActivityGraphWithActionPin()
79 | {

```

(Native Code only.) Stack markers enable you to capture any unique stack traces that occur at a point in an application. To insert a marker at the required point in code, right-click on the line and select the **Add Stack Auto Capture Marker** context menu option.

Each time the debugger encounters the marker it performs a stack trace. If the stack trace is not in the recording history, it is copied. The application then continues running. Stack markers provide a quick and useful picture of where a point in an application is being called from.



Sequence	Instance	Method	Direction	Method	In
00000001		stepping.__tmainCRTStartup	Call	stepping.wmain	
00000002		stepping.wmain	Call	SSP.CTrace.Run	
00000003		SSP.CTrace.Run	Call	SSP.CTrace.Get	
00000004		SSP.CTrace.Get	Call	SSP.CTrace.SetRect	
00000005			Return	SSP.CTrace.Get	
00000006			Return	SSP.CTrace.Run	
00000007		SSP.CTrace.Run	Call	SSP.CTrace.Func3	
00000008		SSP.CTrace.Func3	Call	SSP.CTrace.SetRect	
00000009			Return	SSP.CTrace.Func3	
00000010			Return	SSP.CTrace.Run	
00000011		SSP.CTrace.Run	Call	SSP.CTrace.Func4	
00000012		SSP.CTrace.Func4	Call	SSP.CTrace.Func5	
00000013		SSP.CTrace.Func5	Call	SSP.CTrace.Func6	
00000014		SSP.CTrace.Func6	Call	SSP.CTrace.Func7	
00000015			Return	SSP.CTrace.Func6	

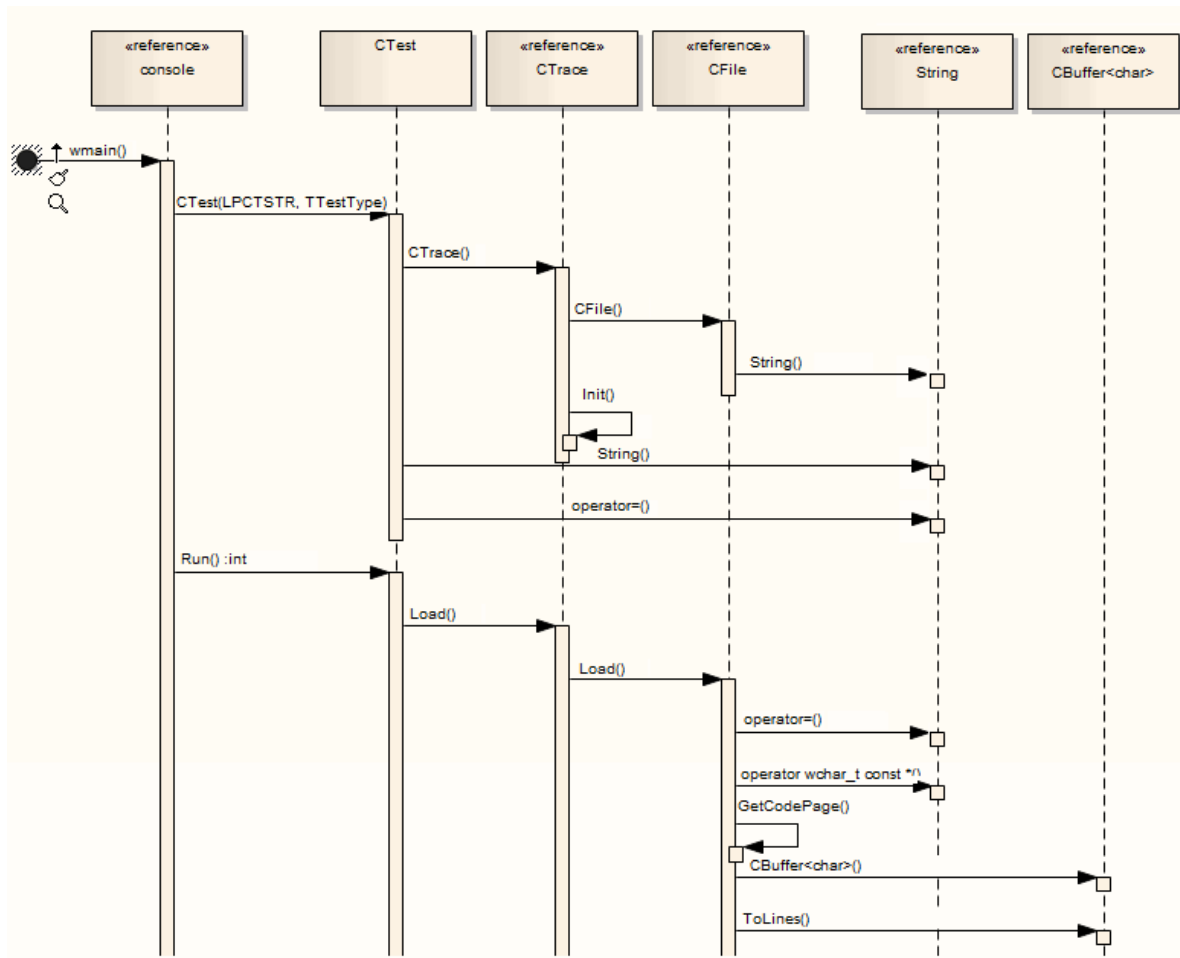

### 7.7.3.1.3.2 Setting Recording Markers

Recording markers are set in the source code editor. If you right-click on the breakpoint margin at the point to begin recording, a context menu displays:

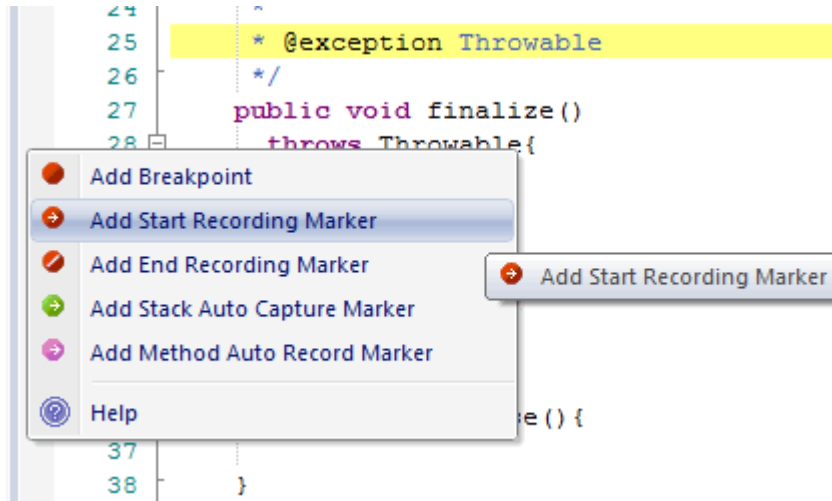

Select the **Add Start Recording Marker** option, then right-click on the breakpoint margin at the point to stop recording and select the **Add End Recording Marker** context menu option. The markers are shown below:

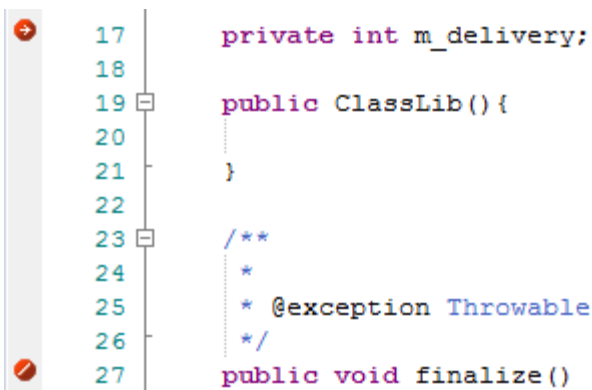

When the debugger is run it continues to run the thread, recording a stack history, until either the **End Recording** marker is encountered or the thread terminates, unlike normal breakpoints where the debugger halts and displays the line of code.

### 7.7.3.1.3.3 The Breakpoints and Markers Window

The **Breakpoints and Markers** window allows you to manage control of the process. Here you can enable, disable, delete markers and also manage them as sets. You can organize how they are displayed, either in list view or grouped by file or class.

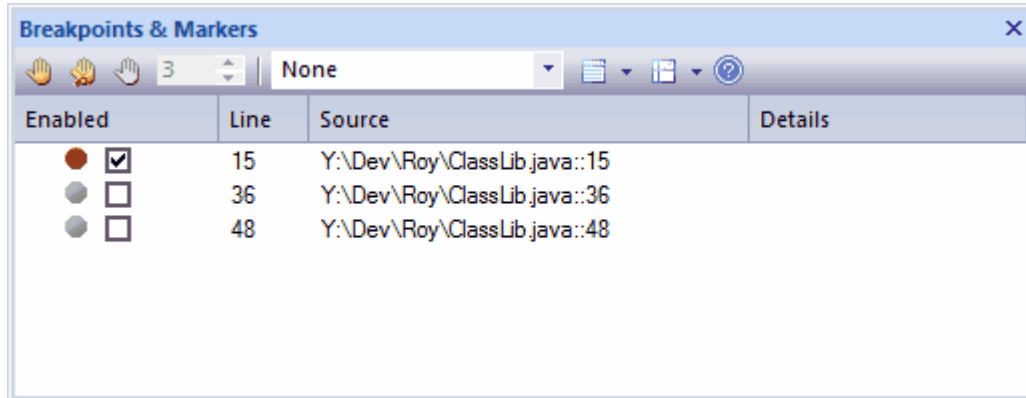



### 7.7.3.1.3.4 Activate and Disable Markers

To delete a specific breakpoint, either:

- If the breakpoint is enabled, click on the red breakpoint circle in the left margin of the **Source Code Editor**
- Right-click on the breakpoint marker in the editor and select the appropriate context menu option, or
- Select the breakpoint in the **Breakpoints & Markers** tab and press **[Delete]**.

Whether you are viewing the **Breakpoints** folder or the **Breakpoints & Markers** window, you can right-click on an existing breakpoint and select a context menu option either to delete it or to convert it to a [start recording marker or end recording marker](#)<sup>[1499]</sup>.

You can also delete all breakpoints by clicking on the **Delete all breakpoints** button on the **Breakpoints & Markers** window toolbar ()

To disable a breakpoint, deselect its checkbox on the **Breakpoints & Markers** window or, to disable all breakpoints, click on the **Disable all breakpoints** button in the toolbar (). The breakpoint is then shown as an empty grey circle. Select the checkbox or use the **Enable all breakpoints** button to enable it again ()

### 7.7.3.1.3.5 Working with Marker Sets

Marker sets enable you to group markers into collections.

A set can be used to record a specific Use Case, which might involve the operations of various Classes. Once a set is created it is saved with the Model. Any other user using the Model has access to that set.

Sets are normally loaded prior to the point at which an action is to be captured. For example, to record a sequence involving a particular dialog, you might set markers for the areas to record, saving the markers as a set. When you begin debugging, prior to invoking the dialog you would then load the set. Once you bring up the dialog in the application, the operations you have marked are recorded. Review the recording history and create a Sequence diagram.

### 7.7.3.1.3.6 Differences to Breakpoints

Breakpoints differ from Markers in that they always break execution whereas Markers operate silently without intervention.

### 7.7.3.1.4 Control the Recording Session

This section describes how you control the recording session:

- [Auto Recording](#) <sup>[1504]</sup>
- [Manual Recording](#) <sup>[1504]</sup>
- [Pause Recording](#) <sup>[1505]</sup>
- [Resume Recording](#) <sup>[1505]</sup>
- [Stop Capture](#) <sup>[1505]</sup>

#### 7.7.3.1.4.1 Auto-Recording

Auto-Recording is available when the process being debugged is at a breakpoint.

You can use the record button on the **Record & Analyze** window toolbar.



Alternatively, select the thread in the stack window:

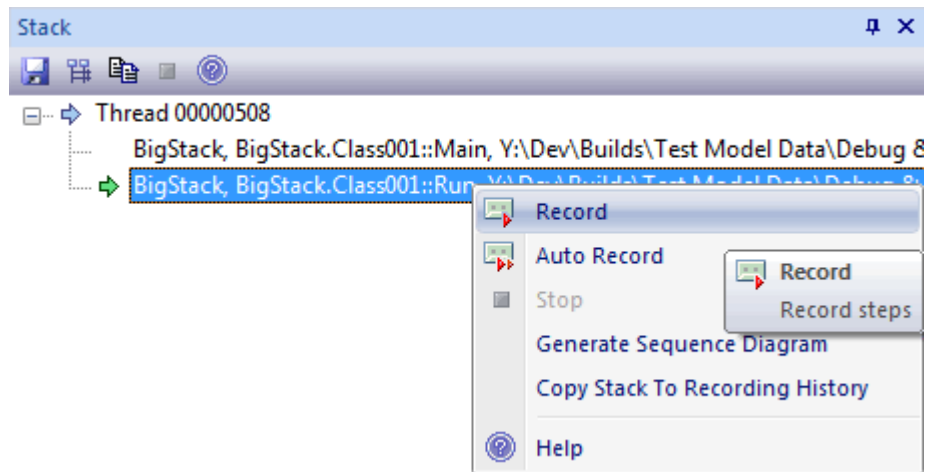

#### 7.7.3.1.4.2 Manual Recording

Manual Recording is available when the process being debugged is at a breakpoint.

Display the **Stack** window and use the context menu to switch to record mode.

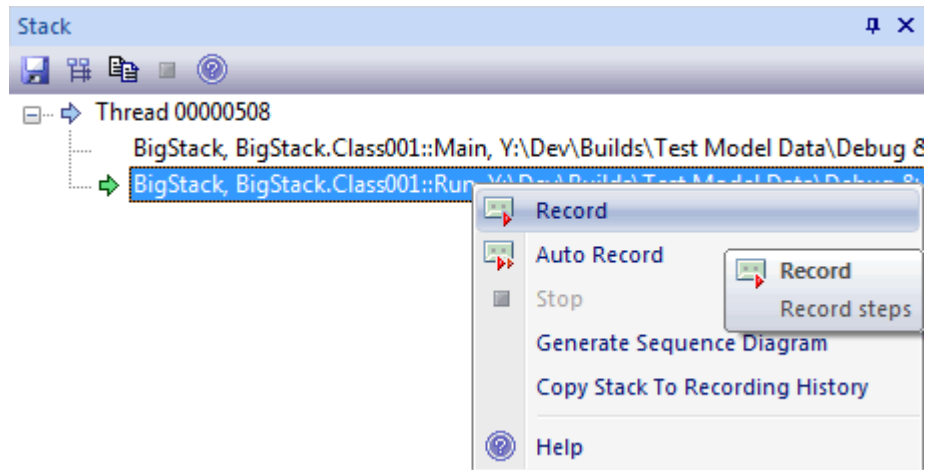

Thereafter you must issue debug commands {StepIn, StepOver, StepOut, Stop} manually.

Each time you issue a step command and the thread stack changes, the sequence of execution is logged.

When you have finished tracing, click on the **Stop** button (  ).

#### 7.7.3.1.4.3 Pause Recording

You can pause recording by using the **Pause/Resume Execution** button on the **Debug** window toolbar or in the **Debug Management** window ([Alt]+[8]).

#### 7.7.3.1.4.4 Resume Recording

You can resume recording using the **Pause/Resume Execution** button on the **Debug** window toolbar or in the **Debug Management** window ([Alt]+[8]).

#### 7.7.3.1.4.5 Stop Capture

To stop recording at any time click on the **Stop Recording** button on the **Record & Analyze** window toolbar.

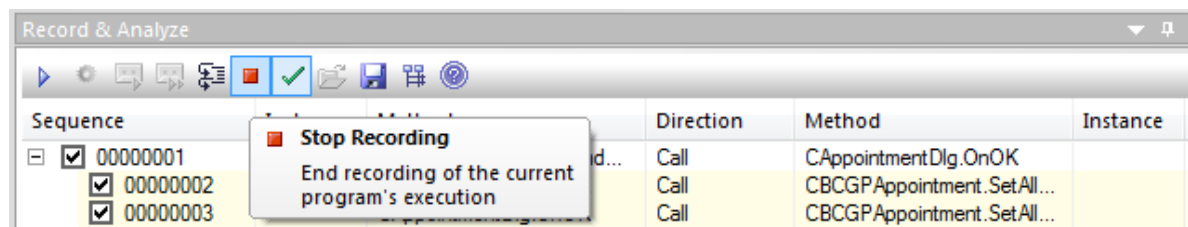

#### 7.7.3.1.5 Generating Sequence Diagrams

Once you have captured activity and are about to generate the diagram, firstly select a package in the **Project Browser** where you intend the Sequence diagram to be stored. Then use the toolbar on the **Record & Analyze** window to generate the diagram.

### 7.7.3.1.5.1 The Recording History

All information recorded as a result of the application encountering recording markers set by the user is held in the **Record & Analyze** window.

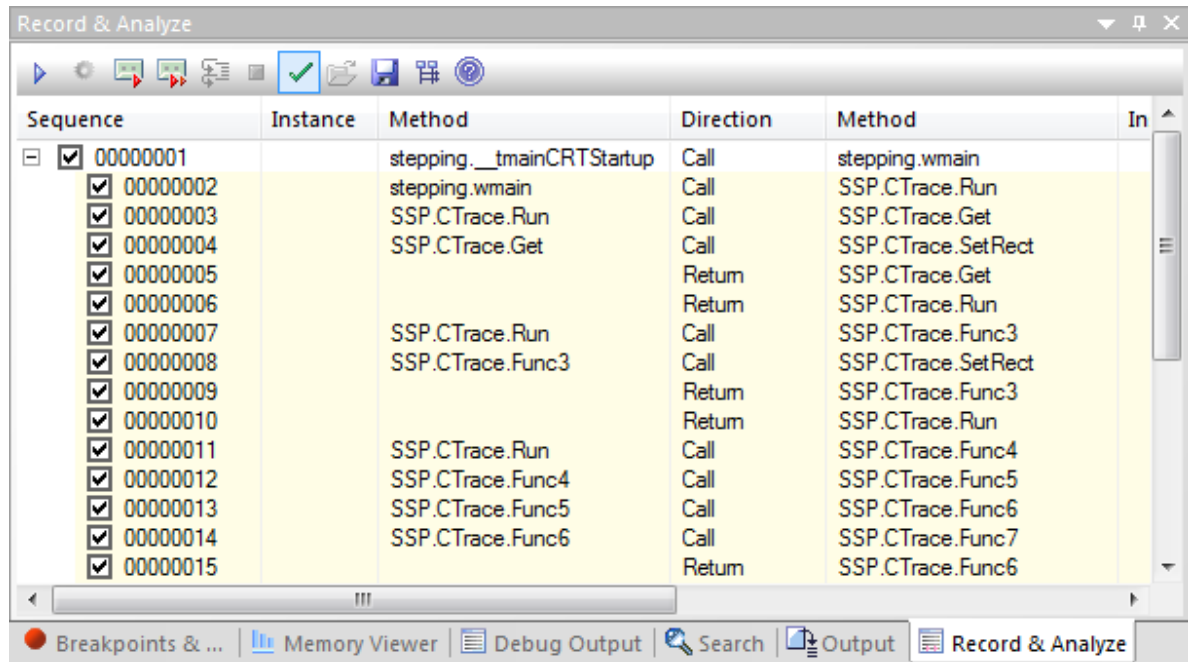

The columns in this window are as follows:

- **Sequence** - The unique sequence number

#### Note:

The checkbox against each number is used to control whether or not this call should be used to create a Sequence diagram from this history. In addition to enabling or disabling the call using the checkbox, you can use context menu options to enable or disable an entire call, all calls to a given method, or all calls to a given Class.

- **Threads** - The operating system thread ID
- **Delta** - The elapsed thread CPU time since the start of the sequence
- **Method** - There are two **Method** columns: the first shows the caller for a call or for a current frame if a return; the second shows the function called or function returning
- **Direction** - Stack Frame Movement, can be *Call*, *Return*, *State*, *Breakpoint* or *Escape* (*Escape* is used internally when producing a Sequence diagram, to mark the end of an iteration)
- **Depth** - The stack depth at the time of a call; used in the generation of Sequence diagrams
- **State** - The state between sequences
- **Source** - There are two **Source** columns: the first shows the source filename and line number of the caller for a call, or for a current frame if a return; the second shows the source filename and line number of the function called or function returning.
- **Instance** - There are two **Instance** columns; these columns only have values when the Sequence diagram produced contains State transitions. The values consist of two items separated by a comma - the first item is a unique number for the instance of the Class that was captured, and the second is the actual instance of the Class.

For example: supposing a Class *CName* has an internal value of 4567 and the program created two instances of that Class; the values might be:

- 4567,1
- 4567,2

The first entry shows the first instance of the Class and the second entry shows the second instance.

### 7.7.3.1.5.2 Generate a Diagram

To generate a Sequence diagram for all history click on the toolbar **Create Sequence Diagram** icon ()

To generate a Sequence diagram for a single sequence, select it and then click the toolbar **Create Sequence Diagram** icon ()

### 7.7.3.1.5.3 Diagram Features

The Sequence diagram produced includes the following:

#### References

When the Visual Execution Analyzer cannot match a function call to an operation within the model, it still creates the sequence, but it creates a reference for any Class that it cannot locate. It does this for all languages.

#### Fragments

Fragments displayed in the Sequence diagram represent loops or iterations of a section(s) of code. The Visual Execution Analyzer attempts to match function scope with method calls to as accurately as possible represent the execution visually.

#### States

If a State Machine has been used during the recording process, any transitions in State are presented after the method call that caused the transition to occur. States are calculated on the return of every method to its caller.

### 7.7.3.1.5.4 Saving Recording

To save a sequence to an XML file, click on the sequence and on the toolbar **Save** button ()

To access an existing sequence file, either:

- Click on the toolbar **Open** icon () , or
- Right-click on a blank area of the screen and click on the **Load Sequence From File** context menu option.

The Windows **Open** dialog displays, from which you select the file to open.

### 7.7.3.1.6 Add State Transitions

This topic describes how to add State Transitions. It covers:

- [Setup for Capturing State Changes](#) <sup>[1508]</sup>
- [The State Machine](#) <sup>[1509]</sup>
- [Recording and Mapping State Changes](#) <sup>[1511]</sup>

### 7.7.3.1.6.1 Setup for Capturing State Changes

You can generate Sequence diagrams that show transitions in state as a program executes. The illustration below shows a project that has, in its State Machine, a number of States that correspond to stations in the Melbourne underground railway system.

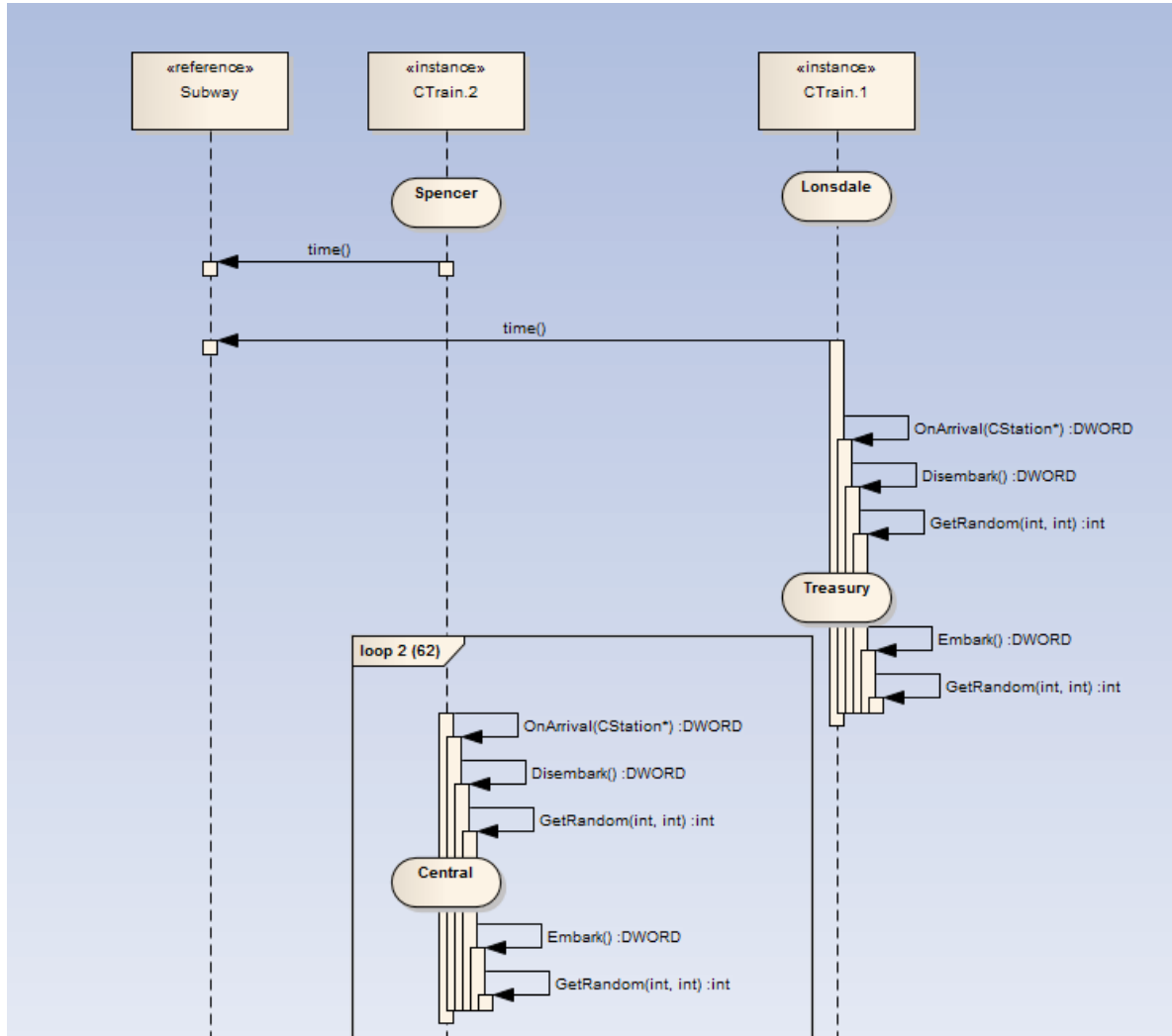

Showing State transitions on your debug-generated Sequence diagrams is optional; you set an option in the package script associated with the Class for which you intend to record States.

#### Note:

If you do not have a package script for the Class or package you must create one. Sequence diagrams can only be generated for a package that has been configured for debug.

Next, you create a *State Machine* under the Class. On the State Machine you create the *State* elements that correspond to any states to be captured for your Class. The debugger evaluates your States by checking *constraints* on the States you create. The States on this diagram are then used by the debugger and State transitions are incorporated into the diagram.



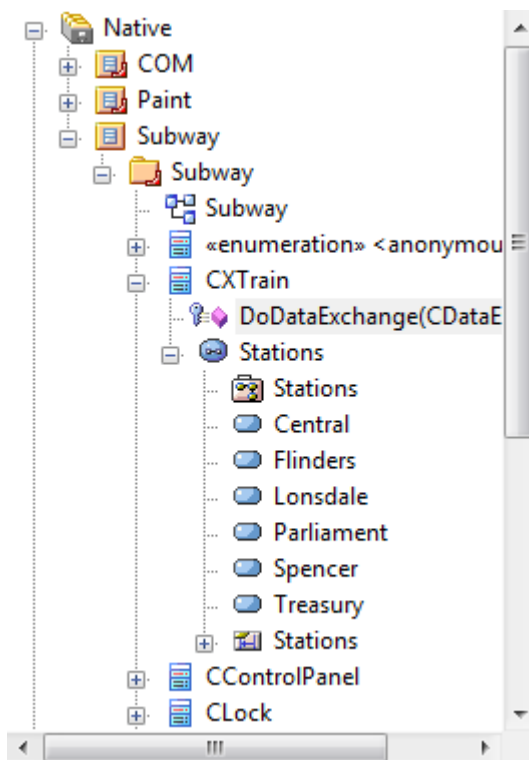

This figure shows the Class `CXTrain` with a State Machine called `Stations`. It has a child diagram also called `Stations`, on which the States `{Central, Flinders, Lonsdale...}` are placed.

#### 7.7.3.1.6.2 The State Machine

A State Transition diagram can be used to illustrate how States change during the execution of an application. The Visual Execution Analyzer can build a State Machine to model all the valid system states and explicitly describe the transitions between each state. The diagram below is a State Machine that shows the different States within the Melbourne Underground Loop subway system. A train traveling on the subway network can be stopped at any of the stations represented on the State Machine below.

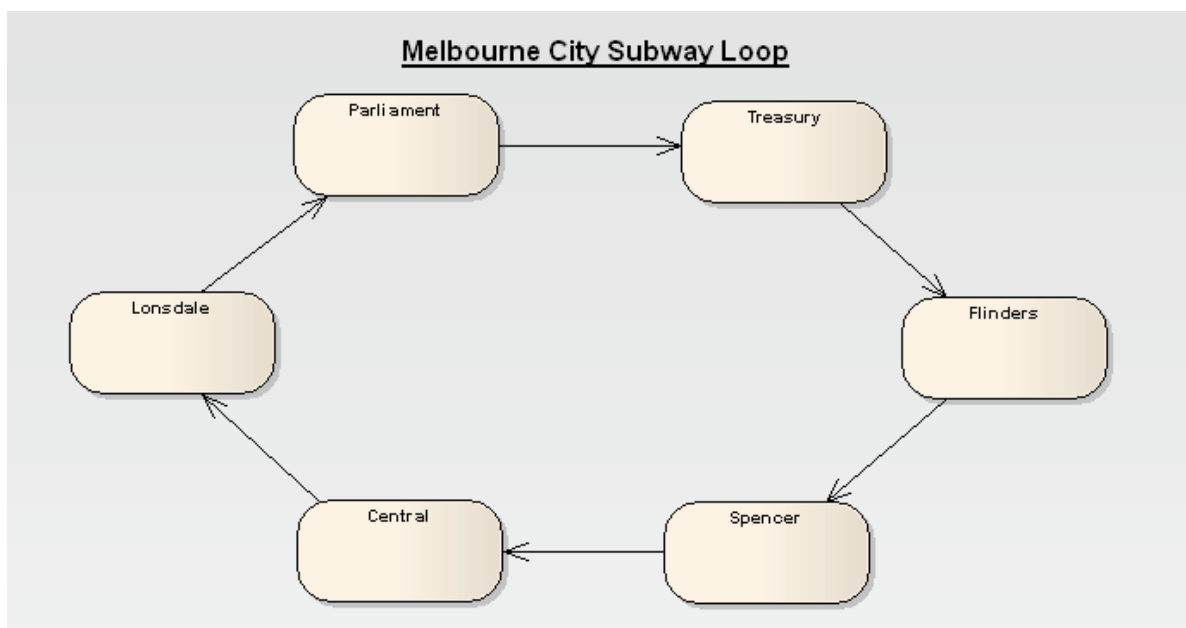

This State Machine diagram is a child of the *CXTrain* Class.

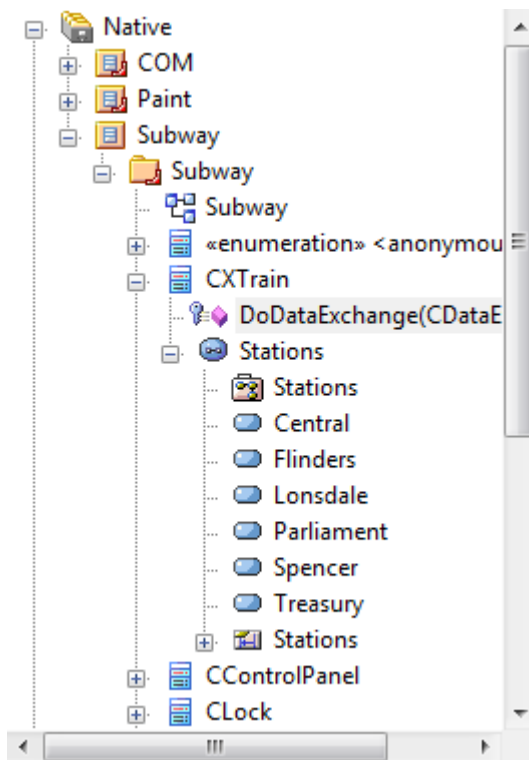

### 7.7.3.1.6.3 Recording and Mapping State Changes

The **State Properties** dialog below is for the State *Parliament*. The **Constraints** tab is open to show how the State is linked to the Class *CXTrain*. A State can be defined by a single constraint or by many; in the example below the State *Parliament* has two constraints.

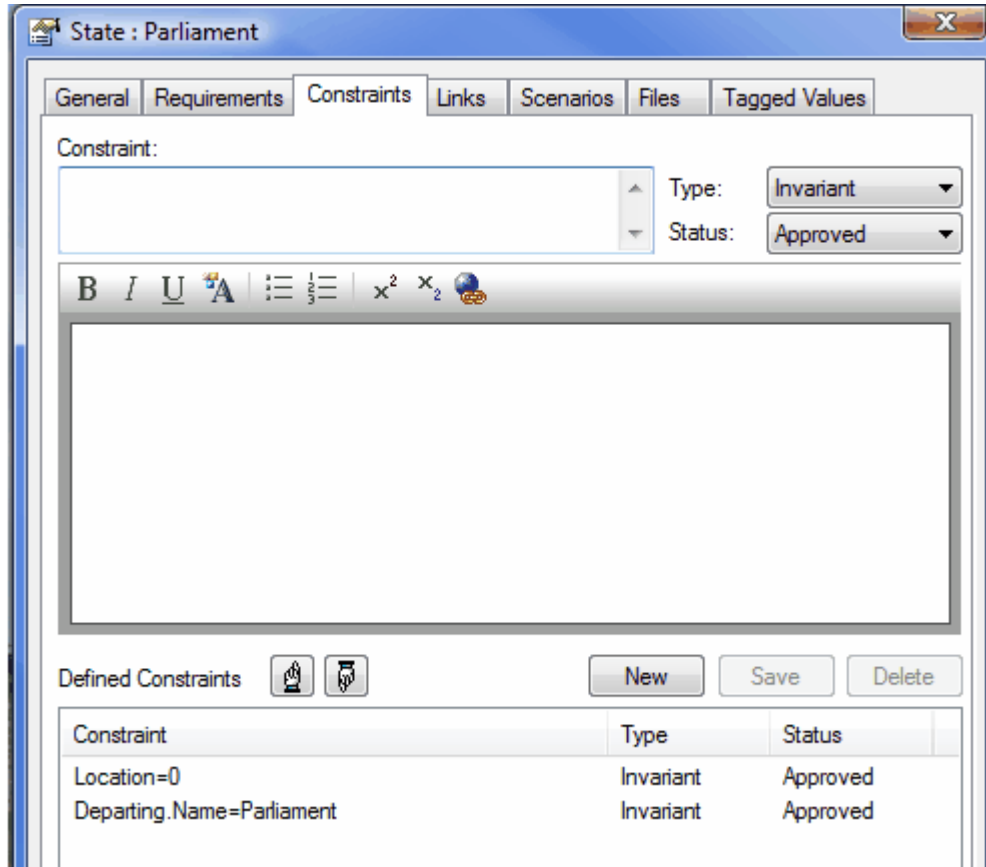

The *CXTrain* Class has a member called *Location* of type *int*, and a member called *Departing.Name* of type *CString*.

The values of constraints can only be compared for *elemental*, *enum* and *string* types. What this constraint means is:

- when an instance of the *CXTrain* Class exists and
- its member variable *Location* has the value **0** and
- the member variable *Departing.Name* has the value **Parliament** then
- this State is evaluated to **true**.

### Operators in Constraints

There are two types of operators you can use on constraints to define a State:

- Logical operators AND and OR can be used to combine constraints
- Equivalence operators {= and !=} can be used to define the conditions of a constraint.

All the constraints for a State are subject to an AND operation unless otherwise specified. You can use the OR operation on them instead, so you could rewrite the constraints in the above example as:

Location=0 OR

Location=1 AND

Departing.Name!=Central

Below are some examples of using the equivalence operators:

Departing.Name!=Central AND

Location!=1

**Note:**

Quotes around strings are optional. The comparison for strings is always case-sensitive in determining the truth of a constraint.

### 7.7.3.2 Unit Testing

Enterprise Architect supports integration with unit testing tools in order to make it easier to develop good quality software.

Firstly, Enterprise Architect helps you to create test Classes with the [JUnit](#) and [NUnit](#) transformations. Then you can [set up](#) a [test script](#) against any package and [run](#) it. Finally, all tests results are automatically [recorded](#) inside Enterprise Architect.

#### 7.7.3.2.1 Set Up Unit Testing

In order to use unit testing in Enterprise Architect, you must first set it up. This happens in two parts.

Firstly the appropriate [tests must be defined](#). Enterprise Architect is able to help with this. By using the [JUnit](#) or [NUnit](#) transformations and [code generation](#) you can create test method stubs for all of the public methods in each of your Classes.

The following is an *NUnit* example in *C#* that is followed through the rest of this topic, although it could also be any other .Net language or Java and JUnit.

```
[TestFixture]
public class CalculatorTest
{
    [Test]
    public void testAdd(){
        Assert.AreEqual(1+1,2);
    }

    [Test]
    public void testDivide(){
        Assert.AreEqual(2/2,1);
    }

    [Test]
    public void testMultiply(){
        Assert.AreEqual(1*1,1);
    }

    [Test]
    public void testSubtract(){
        Assert.AreEqual(1-1,1);
    }
}
```

This code can be reverse engineered into Enterprise Architect so that Enterprise Architect can record all test results against this Class.

Once the unit tests are set up, you can then set up the Build and Test scripts to run the tests. These scripts must be set up against a package.

The sample above can be called by setting up the [Package Build Scripts](#) dialog as follows.

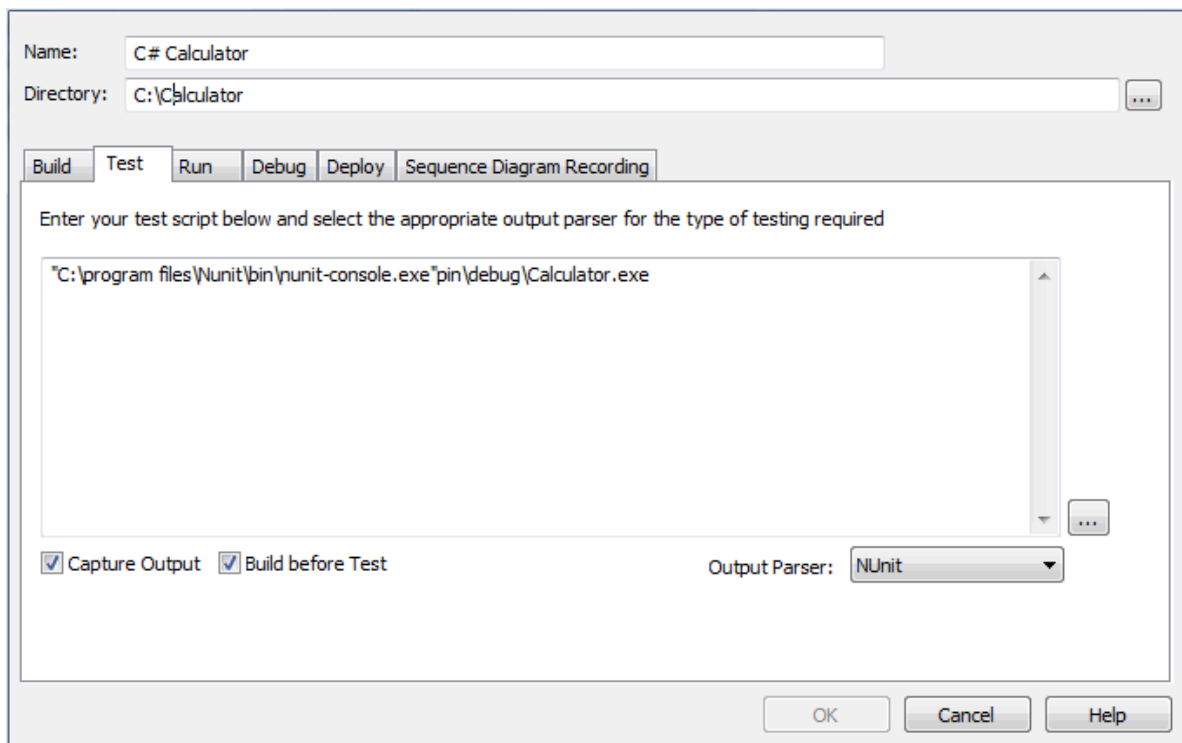

If Enterprise Architect is to handle unit testing, it is important that you select the **Capture Output** checkbox and select the appropriate **Output Parser** for the testing. Without doing this you won't see the program output and therefore you cannot open the source at the appropriate location.

### 7.7.3.2.2 Run Unit Tests

You can run the test script you set up previously, by selecting the **Project | Execution Analyzer | Test** menu option.

The following output is generated.

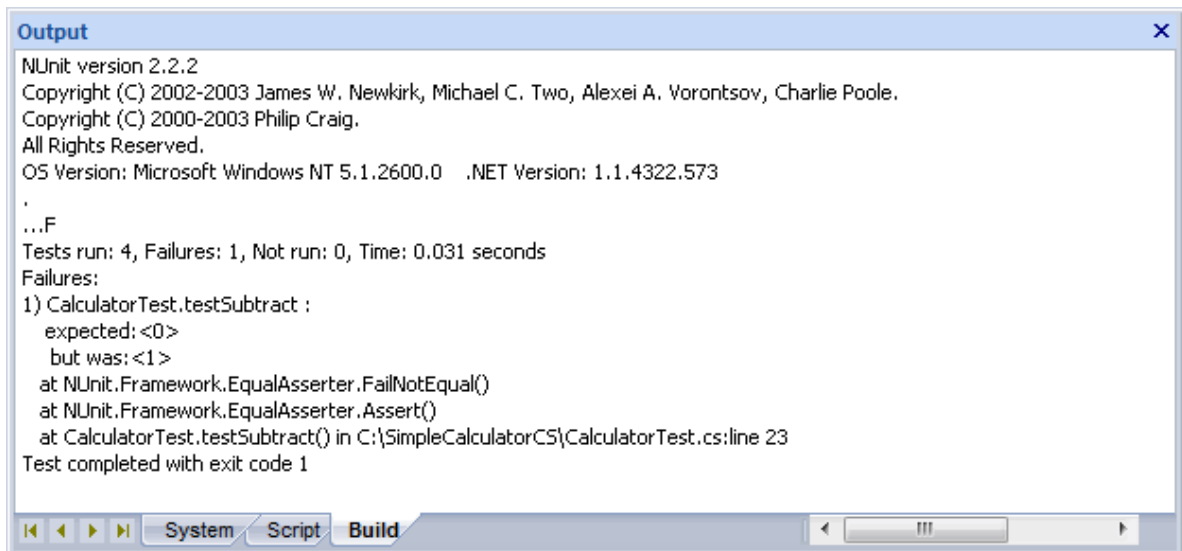

Notice how NUnit reports that four tests have run, including one failure. It also reports what method failed and the file and line number the failure occurred at. If you double-click on that error, Enterprise Architect opens the editor to that line of code.

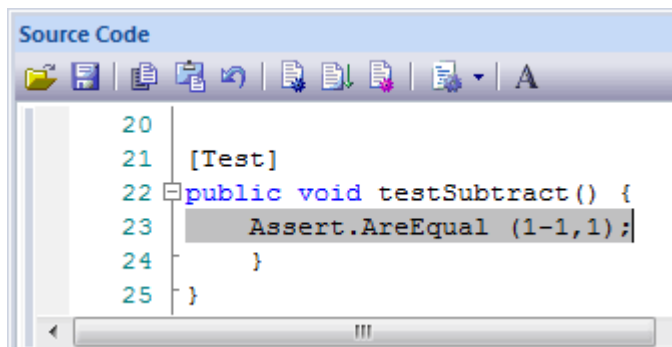

```

20
21 [Test]
22 public void testSubtract() {
23     Assert.AreEqual (1-1,1);
24 }
25 }

```

This enables you to quickly find and fix the error.

Enterprise Architect also records the run status of each test as described in [Record Test Results](#)<sup>[1514]</sup>.

### 7.7.3.2.3 Record Test Results

Enterprise Architect is able to automatically record all results from tests by a [testing script](#)<sup>[1512]</sup> in Enterprise Architect. In order to use this feature, you just [reverse engineer](#)<sup>[1328]</sup> the test Class into the package containing your test script.

Once your model contains your test Class, on the next [run of the test script](#)<sup>[1513]</sup> Enterprise Architect adds test cases to the Class for each test method found. On this and all subsequent test runs all test cases are updated with the current run time and if they passed or failed as shown in the following illustration.

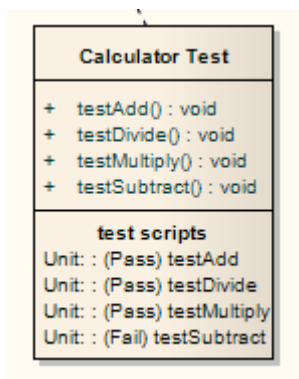

Calculator Test	
+	testAdd() : void
+	testDivide() : void
+	testMultiply() : void
+	testSubtract() : void
<b>test scripts</b>	
Unit :	(Pass) testAdd
Unit :	(Pass) testDivide
Unit :	(Pass) testMultiply
Unit :	(Fail) testSubtract

The error description for each failed test is added to any existing results for that test case, along with the current date and time. Over time this provides a log of all test runs where each test case has failed. This can then be included in generated documentation and could resemble the following.

```

Failed at 05-Jul-2006 1:02:08 PM
expected: <0>
but was: <1>

```

```

Failed at 28-Jun-2006 8:45:36 AM
expected: <0>
but was: <2>

```

### 7.7.3.3 Profiling Native Applications

The Visual Execution Profiler enables you to quickly report on:

- The most frequently called functions in a running application
- Tasks in an application that are taking more time than expected
- Which functions are taking the most time in an application.

The Profiler, or sampler, is available in the Enterprise Architect Professional, Corporate, Business and Software Engineering, System Engineering and Ultimate editions.

**Note:**

The Profiler only works with MS Native Windows applications, but can be used under WINE (Linux and Mac) to debug standard Windows applications deployed in a WINE environment.

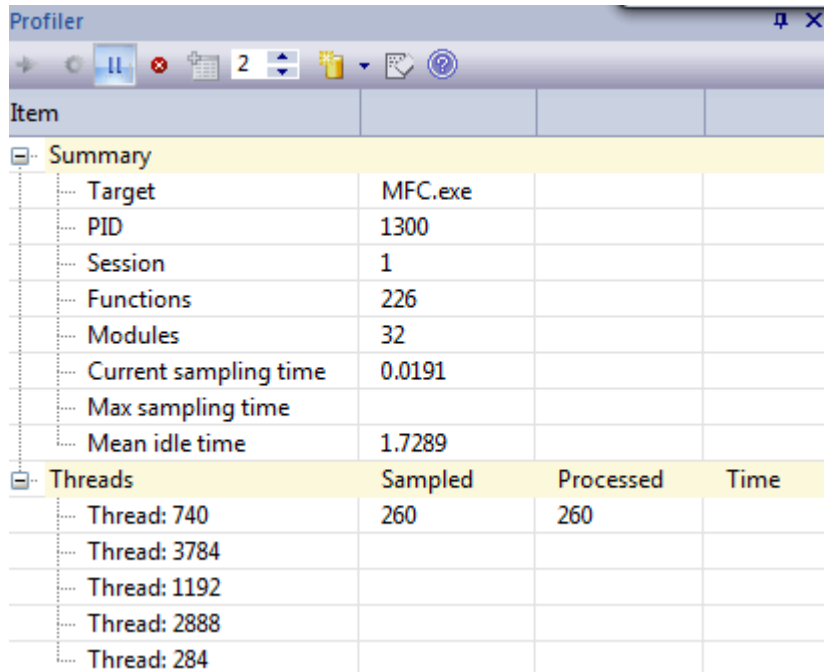

Item			
<b>Summary</b>			
Target	MFC.exe		
PID	1300		
Session	1		
Functions	226		
Modules	32		
Current sampling time	0.0191		
Max sampling time			
Mean idle time	1.7289		
<b>Threads</b>			
	Sampled	Processed	Time
Thread: 740	260	260	
Thread: 3784			
Thread: 1192			
Thread: 2888			
Thread: 284			

The Profiler can generate a report that shows how these functions are called in relation to the application, as illustrated below:

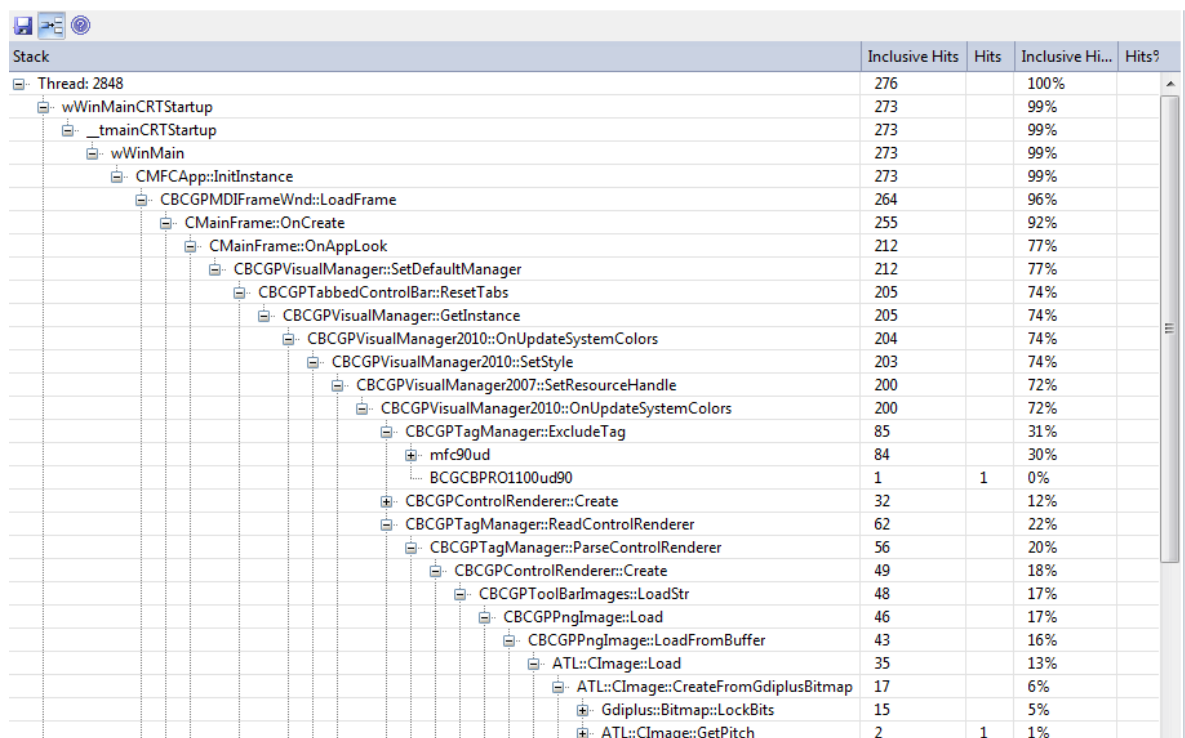

Stack	Inclusive Hits	Hits	Inclusive Hi...	Hits?
Thread: 2848	276		100%	
wWinMainCRTStartup	273		99%	
_tmainCRTStartup	273		99%	
wWinMain	273		99%	
CMFCApp::InitInstance	273		99%	
CBCGPMDFrameWnd::LoadFrame	264		96%	
CMainFrame::OnCreate	255		92%	
CMainFrame::OnAppLook	212		77%	
CBCGPVisualManager::SetDefaultManager	212		77%	
CBCGPTabbedControlBar::ResetTabs	205		74%	
CBCGPVisualManager::GetInstance	205		74%	
CBCGPVisualManager2010::OnUpdateSystemColors	204		74%	
CBCGPVisualManager2010::SetStyle	203		74%	
CBCGPVisualManager2007::SetResourceHandle	200		72%	
CBCGPVisualManager2010::OnUpdateSystemColors	200		72%	
CBCGPTagManager::ExcludeTag	85		31%	
mfc90ud	84		30%	
BCGCBPRO1100ud90	1	1	0%	
CBCGPControlRenderer::Create	32		12%	
CBCGPTagManager::ReadControlRenderer	62		22%	
CBCGPtagManager::ParseControlRenderer	56		20%	
CBCGPControlRenderer::Create	49		18%	
CBCGPToolBarImages::LoadStr	48		17%	
CBCGPPngImage::Load	46		17%	
CBCGPPngImage::LoadFromBuffer	43		16%	
ATL::CImage::Load	35		13%	
ATL::CImage::CreateFromGdiplusBitmap	17		6%	
Gdiplus::Bitmap::LockBits	15		5%	
ATL::CImage::GetPitch	2	1	1%	

**See Also**

- [Profiler System Requirements](#) <sup>[1516]</sup>

- [Profiler Operation](#) <sup>[1517]</sup>

### 7.7.3.3.1 System Requirements

#### Prerequisites

The [Profiler window](#) <sup>[1514]</sup> becomes available when a model is opened. [Options](#) <sup>[1516]</sup> on the **Profiler** window toolbar enable you to attach to an existing process or launch a new application if a Package Script been specified.

#### Supported Platforms

Enterprise Architect supports profiling on native Windows applications (C, C++ and Visual Basic) compiled with the Microsoft™ native compiler where an associated PDB file is available. Select **Microsoft Native** from the list of debugging platforms in your package script.

The Profiler can sample both Debug and Release configurations of an application, providing the PDB for each executable exists and is up to date.







### 7.7.3.3.2 Getting Started

The **Profiler** window can be accessed by selecting the **View | Execution Analyzer | Profiler** menu option, or by selecting it from the *Analysis Windows* folder on the **Debugger** window (**[Alt]+[8]**). The toolbar options are explained in the table below.



The Profiler operates by taking samples of a process at intervals of up to 250 milliseconds. At these intervals the Profiler interrupts the process and collects stack information for all threads running at that time. This information is sent back to Enterprise Architect where it is collected sorted and and stored.

You can Pause and Resume profiling at any time during the session. You can also clear any sample data collected and begin again.

If you stop the Profiler and the process is still running, you can quickly attach to it again.

Icon	Use to
	(When an application is <a href="#">configured for the package</a> ) <sup>[1426]</sup> create the Profiler process, which launches the configured application.
	Profile an application that is already running.
	When the application is running, pause and resume sample capture. Pausing sampling enables the <b>Report</b> and <b>Erase</b> buttons.
	Stop the Profiler process. If any samples have been collected, the <b>Report</b> button is enabled.
	Generate a <a href="#">report</a> <sup>[1514]</sup> on the current number of samples collected.
	Set the <a href="#">interval</a> <sup>[1518]</sup> , in milliseconds, at which samples are taken of the target process. The range of possible values is <b>1 - 250</b> .
	Set Profiler options, using a drop-down menu. The options are: <ul style="list-style-type: none"> <li>• <b>Load Report from Disk</b> - load and display a previously-generated report from an xml disk file</li> <li>• <b>Package Build Scripts ([Shift]+[F12])</b> - display the <a href="#">Build Script</a> <sup>[1443]</sup> dialog to enable creation or editing of package scripts and debug configuration</li> <li>• <b>Start Sampling Immediately</b> - begin sample collection immediately upon either process start (main thread entry point executed) or attachment of process by Profiler</li> <li>• <b>Capture Debug output</b> - capture any appropriate debug output and redirect it to the Enterprise Architect <b>Output</b> window</li> </ul>



Icon	Use to
	<ul style="list-style-type: none"> <li>• <b>Stop Process on Exit</b> - select to terminate the target process when the Profiler is stopped.</li> </ul>
	Erase the collected data.
	Display the Help topic for this window.



### 7.7.3.3 Start & Stop the Profiler

For most debugging operations it is necessary to have first configured a Package Script that typically defines the application to build, test and debug as well as sequence recording options.

It is possible to use the Profiler without doing any of this by using the **Attach to Process** button.

If the Application to Profile is the one defined in the current Package, use the **Launch** button.



	(When an application is <a href="#">configured for the package</a> ) <sup>[1426]</sup> create the Profiler process, which launches the configured application.
	Profile an application that is already running.
	Stop the Profiler process.

### 7.7.3.4 Profiler Operation

Enterprise Architect creates a Profiler process whenever you click on the **Launch** or **Attach to Process** button on the **Profiler** window toolbar. This process operates by collecting samples from the stacks of every thread in the target process.

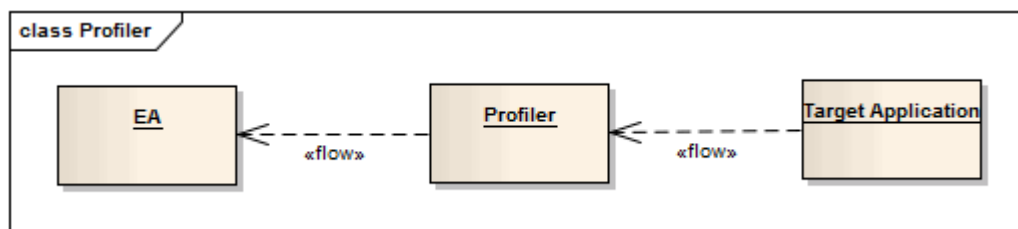

The sampler process exits if you click on the **Stop** button, if the target application terminates, or if you close the current model.

You can turn sample collection on and off at any time during a session. When sampling is turned on or resumed, the Profiler process becomes active and samples are collected from the target. Resuming sampling collects completely new samples.



The Profiler process idles if sampling is turned off or paused during a session. The **Report** and **Erase** buttons then become enabled.

Click on the **Report** button to produce a call graph summary similar to that in the [Profile Native Applications](#)<sup>[1514]</sup> topic. This report can be saved to file.

Click on the **Erase** button to discard any samples currently collected for the target.

### 7.7.3.3.5 Setting Options

#### Interval

	Set the interval, in milliseconds, at which samples are taken of the target process. The range of possible values is <b>1 - 250</b> .
	<p>Set Profiler options, using a drop-down menu. The options are:</p> <ul style="list-style-type: none"> <li>• <b>Start Sampling Immediately</b> - begin sample collection immediately upon either process start (main thread entry point executed) or attachment of process by Profiler</li> <li>• <b>Capture Debug output</b> - capture any appropriate debug output and redirect it to the Enterprise Architect <b>Output</b> window</li> <li>• <b>Stop Process on Exit</b> - select to terminate the target process when the Profiler is stopped.</li> </ul>

### 7.7.3.3.6 Save and Load Reports

The Profiler Reports can be saved in either binary format or xml format. Save the report using the toolbar above the report (**Stack**) view.

Stack	Inclusive Hits	Hits	Inclusive Hi...	Hits?
Thread: 2848	276		100%	
wWinMainCRTStartup	273		99%	
_tmainCRTStartup	273		99%	
wWinMain	273		99%	
CMFCApp::InitInstance	273		99%	
CBCGPMDIFrameWnd::LoadFrame	264		96%	
CMainFrame::OnCreate	255		92%	
CMainFrame::OnAppLook	212		77%	
CBCGPVisualManager::SetDefaultManager	212		77%	
CBCGPTabbedControlBar::ResetTabs	205		74%	
CBCGPVisualManager::GetInstance	205		74%	
CBCGPVisualManager2010::OnUpdateSystemColors	204		74%	
CBCGPVisualManager2010::SetStyle	203		74%	
CBCGPVisualManager2007::SetResourceHandle	200		72%	
CBCGPVisualManager2010::OnUpdateSystemColors	200		72%	
CBCGPTagManager::ExcludeTag	85		31%	
mfc90ud	84		30%	
BCGCBPRO1100ud90	1	1	0%	
CBCGPControlRenderer::Create	32		12%	
CBCGPTagManager::ReadControlRenderer	62		22%	
CBCGPTagManager::ParseControlRenderer	56		20%	
CBCGPControlRenderer::Create	49		18%	
CBCGPToolBarImages::LoadStr	48		17%	
CBCGPPngImage::Load	46		17%	
CBCGPPngImage::LoadFromBuffer	43		16%	
ATL::CImage::Load	35		13%	
ATL::CImage::CreateFromGdiplusBitmap	17		6%	
Gdiplus::Bitmap::LockBits	15		5%	
ATL::CImage::GetPitch	2	1	1%	

To load a report use the **Profiler Toolbar Options** button  and select the **Load Report From Disk** option.

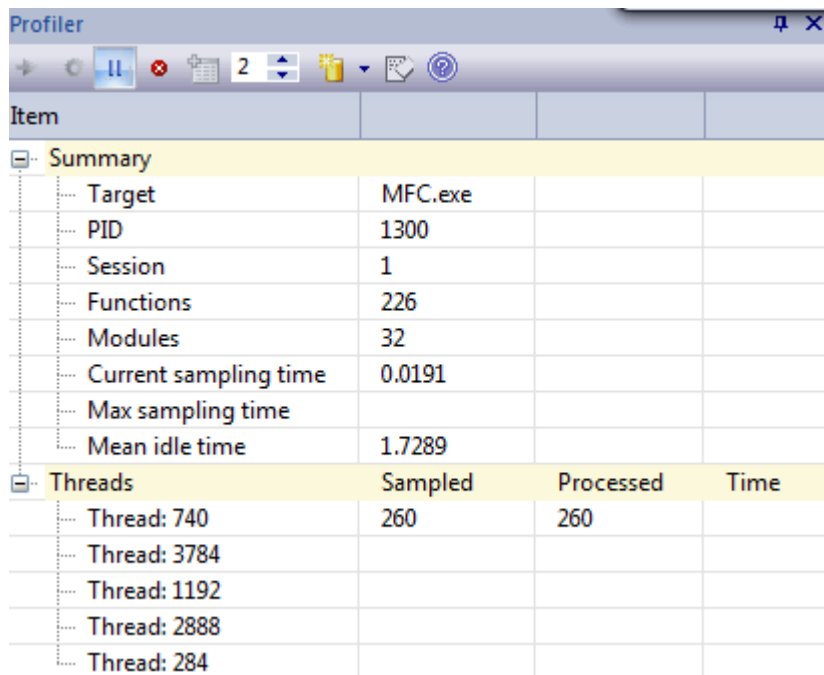

Item			
<b>Summary</b>			
Target	MFC.exe		
PID	1300		
Session	1		
Functions	226		
Modules	32		
Current sampling time	0.0191		
Max sampling time			
Mean idle time	1.7289		
<b>Threads</b>			
	Sampled	Processed	Time
Thread: 740	260	260	
Thread: 3784			
Thread: 1192			
Thread: 2888			
Thread: 284			

### 7.7.3.3.7 Save Report in Team Review

You can save any current report as a resource for a Category, Topic or Post in the **Team Review**. The report can then be shared and reviewed at any time as it is saved with the model.

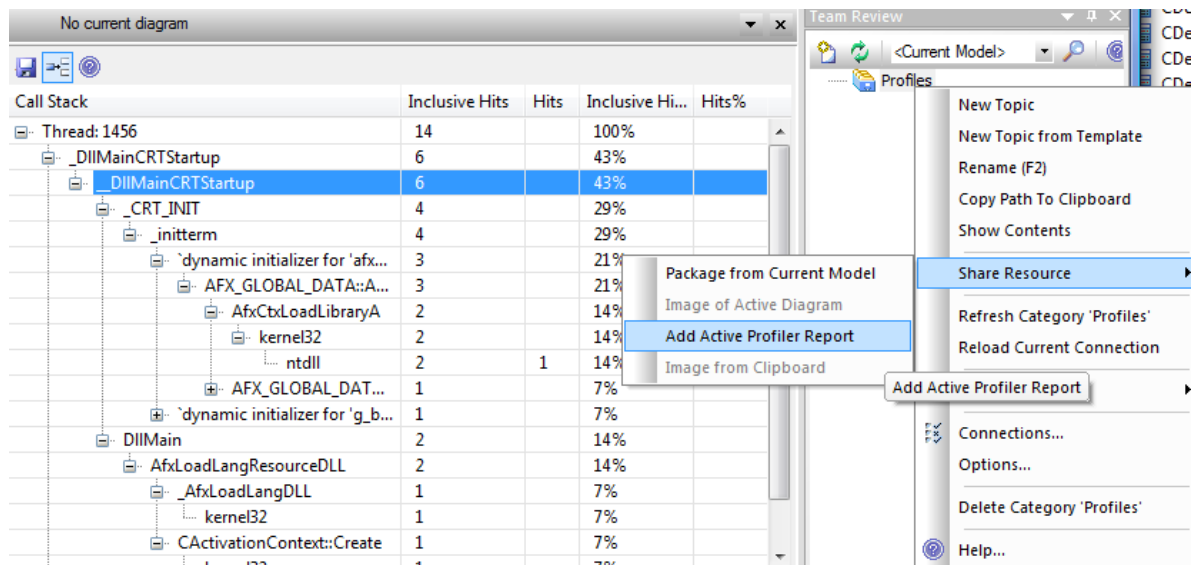

Call Stack	Inclusive Hits	Hits	Inclusive Hi...	Hits%
Thread: 1456	14		100%	
_DllMainCRTStartup	6		43%	
DllMainCRTStartup	6		43%	
_CRT_INIT	4		29%	
_initterm	4		29%	
'dynamic initializer for 'afx...	3		21%	
AFX_GLOBAL_DATA::A...	3		21%	
AfxCbxLoadLibraryA	2		14%	
kernel32	2		14%	
ntdll	2	1	14%	
AFX_GLOBAL_DAT...	1		7%	
'dynamic initializer for 'g_b...	1		7%	
DllMain	2		14%	
AfxLoadLangResourceDLL	2		14%	
_AfxLoadLangDLL	1		7%	
kernel32	1		7%	
CActivationContext::Create	1		7%	
kernel32	1		7%	

The context menu for the selected item includes the following options:

- Package from Current Model
- Image of Active Diagram
- Add Active Profiler Report**
- Image from Clipboard

The Team Review window also shows a menu with the following options:

- New Topic
- New Topic from Template
- Rename (F2)
- Copy Path To Clipboard
- Show Contents
- Share Resource**
- Refresh Category 'Profiles'
- Reload Current Connection
- Add Active Profiler Report
- Connections...
- Options...
- Delete Category 'Profiles'
- Help...

### 7.7.3.4 Object Workbench

This section describes the **Object Workbench**:

- [How it works](#) <sup>[1520]</sup>
- [Workbench Variables](#) <sup>[1521]</sup>
- [Create Workbench Variables](#) <sup>[1521]</sup>
- [Invoke Methods](#) <sup>[1522]</sup>

### 7.7.3.4.1 How it Works

The Workbench is a tool in Enterprise Architect Debugging, enabling you to [create your own variables](#) and [invoke methods](#) on them. Stack trace can be recorded and Sequence diagrams produced from the invocation of such methods. It provides a quick and simple way to debug your code.

### Platforms Supported

The Workbench supports the following workbench platforms:

- Microsoft .NET (version 2.0 or later)
- Java (JDK 1.4 or later)

#### Note:

The Workbench does not currently support the creation of Class instances written in native C++, C or VB.

### Mode

The Workbench operates in two modes:

#### Idle mode

When the Workbench is in idle mode, instances can be created and viewed and their members inspected.

#### Active mode

When methods are invoked on an instance, the Workbench enters *Active* mode, and the variables displayed change if the debugger encounters any breakpoints. If no breakpoints are set, then the variables do not change. The Workbench immediately returns to *Idle* mode.

### Logging

The results of creating variables and the results of calls on their methods are displayed in the Debug **Output** window.

### 7.7.3.4.2 Workbench Variables

You can create (and delete) workbench variables from any Class in your model. When you do so, you are asked to name the variable. It then displays in the **Workbench** window. It shows the variable in a hierarchy, displaying its type and value and those of any members.

Variable	Value	Type
Rob		MyClassLibrary.CRobert
MyClassLibrary.CPerson		
AverageAge	0	float
FriendCount	1	int
Age	2	int
Friends		MyClassLibrary.CPerson[]
[0]		MyClassLibrary.CPerson
Town	"Daylesford"	String
Name	"Robert"	String
occupation	"Programmer"	String
Fred		MyClassLibrary.CFred
MyClassLibrary.CPerson		
AverageAge	0	float
FriendCount	0	int
Age	2	int
Friends		[]
Town	"hepburn"	String
Name	"Fred"	String
occupation	"Programmer"	String

### Workbench Requirements

- NET framework version 2 is required to workbench any .NET model.
- The package from which the variable is created must have a debugger configured (see the [Set Up For Debugging](#) topic).

### Constraints (.NET)

- Members defined as *struct* in managed code are not supported.
- Classes defined as *internal* are not supported.

### Delete Workbench Variables

You can delete variables using the **Delete** shortcut menu on any instance on the Workbench. If all instances are deleted the debugger is shut down, and the **Workbench** window is closed.

### 7.7.3.4.3 Create Workbench Variables

Right-click on the required Class node in the **Project Browser** and select the **Create Workbench Instance** context menu option, or press **[Ctrl]+[Shift]+[J]**. The menu option is also available from within a Class diagram.

### Naming the Workbench

When you elect to create an instance of a type Enterprise Architect prompts you with the **Workbench** dialog to name the variable. Each instance name must be unique for the workbench.

A dialog box with a light gray background. It has two text input fields. The first is labeled 'Name' and contains the text 'William'. The second is labeled 'Value' and contains the text 'MyClassLibrary.CPerson'. At the bottom of the dialog, there are three buttons: 'Create' (highlighted in blue), 'Help', and 'Cancel'.

### Choosing a Constructor

Having given the variable a name, you must now choose which constructor to use.

If you do not define a constructor, or define a single constructor taking no arguments, the default constructor or the defined constructor is automatically invoked.

Otherwise the following dialog displays. Select the constructor from the drop-down list and fill in any parameters required.

A dialog box titled 'William(MyClassLibrary::CPerson)'. It features a list box containing three constructor signatures: 'CPerson()', 'CPerson(MyClassLibrary.CPerson)', and 'CPerson(string,string,int)'. The first option, 'CPerson()', is selected and highlighted in blue. At the bottom, there are three buttons: 'Invoke' (highlighted in blue), 'Help', and 'Cancel'.

#### 7.7.3.4.4 Invoke Methods

On the **Workbench** window, right-click on the instance on which to execute a method, and select the **Invoke** context menu option.

The screenshot shows the 'Workbench' window with a table of variables. The 'William' instance is selected, and a context menu is open over it. The menu options are 'Invoke', 'Delete', 'Reset workbench', and 'Help'. A sub-menu is also visible, containing 'Invoke' and 'Upgrade Wizard'.

Variable	Value	Type
Rob		MyClassLibrary.CRobert
Fred		MyClassLibrary.CFred
John		MyClassLibrary.CPerson
William		MyClassLibrary.CPerson
		float
		int
		int
		[]
	unknown	String
	unknown	String
occupation	"Programmer"	String

### Choose Method

A list of methods for the type are presented in a dialog. Select a method from the list and click on the **Invoke**

button. Note that all methods listed are public; private methods are not available.

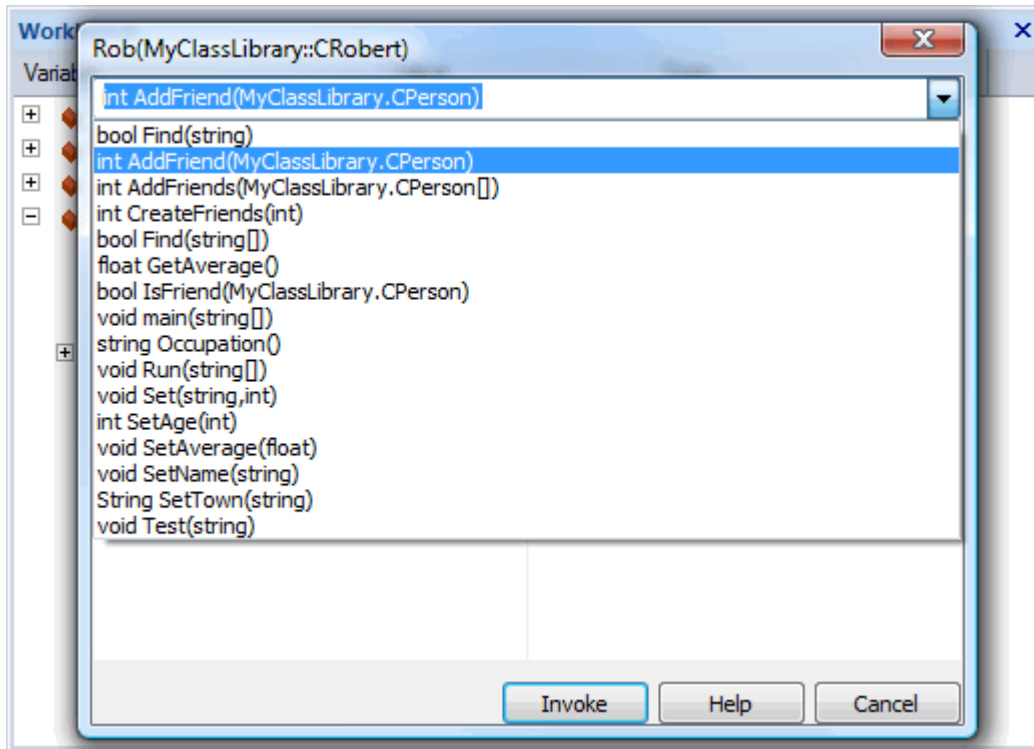

### Supply Arguments

In this example, you have created an instance or variable named *Rob* of type *MyClassLibrary.CRobert*, and have invoked a method named *AddFriends* that takes an array of *CPerson* objects as its only argument. What you now supply to it are the three other Workbench instances *Fred*, *John* and *William*.

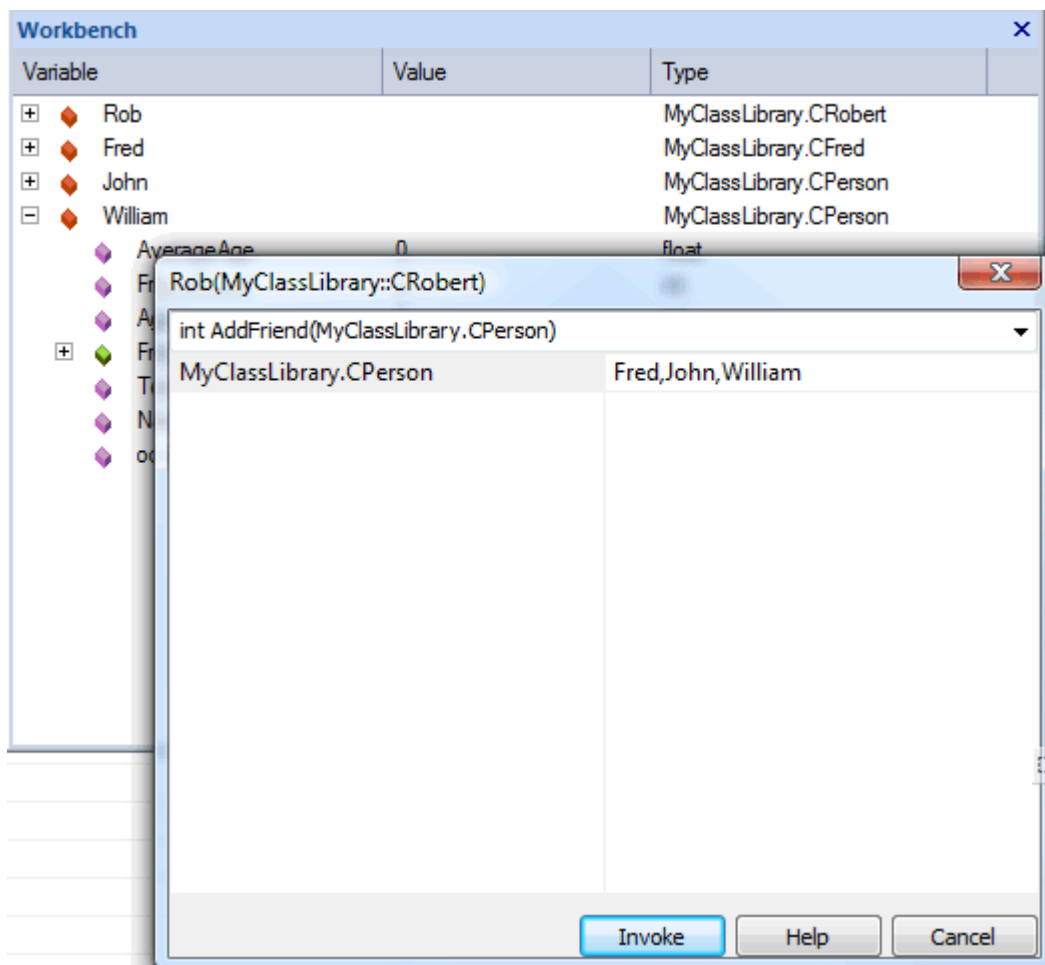

## Arguments

In the dialog above, type any parameters required by the constructor.

- **Literals as arguments**

- Text: abc or "abc" or "a b c"
- Numbers: 1 or 1.5

- **Objects as arguments**

If an argument is not a literal then you can supply it in the list only if you have already created an instance of that type in the workbench. You do this by typing the name of the instance as the argument. The debugger checks any name entered in an argument against its list of workbench instances, and substitutes that instance in the actual call to the method.

- **Strings as arguments**

Surrounding strings with quotes is unnecessary as anything you type for a string argument becomes the value of the string; for example, the only time you should surround strings with quotes is in supplying elements of a string array, or where the string is equal to the name of an existing workbench instance.

```
"A b c"
"a b $ % 6 4"
A b c d
As 5 7 ) 2 === 4
```

- **Arrays as arguments**

Enter the elements that compose the array, separated by commas.

Type	Arguments
String[]	one,two,three,"a book","a bigger book"
CPerson[]	Tom,Dick,Harry



**Note:**

If you enter text that matches the name of an existing instance, surround it in quotes to avoid the debugger passing the instance rather than a string.

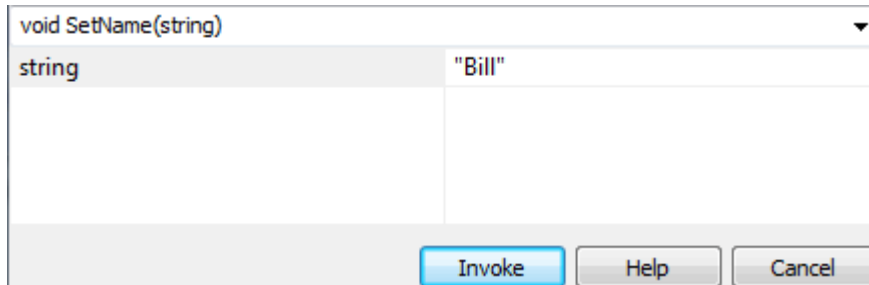

The screenshot shows a debugger interface for a method call. At the top, a dropdown menu displays 'void SetName(string)'. Below this, a table lists the arguments for the method. The first row shows the parameter 'string' and its value '"Bill"'. At the bottom of the interface, there are three buttons: 'Invoke' (highlighted in blue), 'Help', and 'Cancel'.

Parameter	Value
string	"Bill"

**Invoke**

Having chosen the constructor and supplied any arguments, click on the **Invoke** button to create the variable. Output confirming this action is displayed in the [Output tab](#) <sup>[1478]</sup>.

**Part**

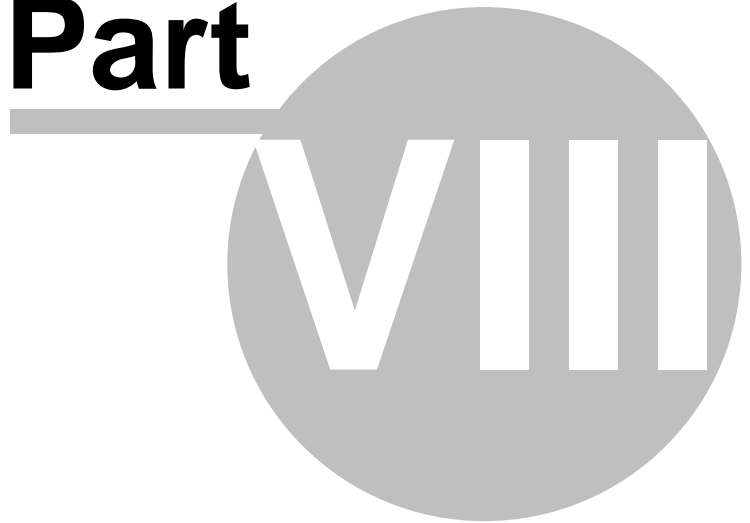

## 8 Test and Quality Control



This section discusses quality control in your project with Enterprise Architect, describing:

- [Model Validation](#)<sup>[1528]</sup> checks
- [Testing](#)<sup>[1536]</sup>
- [Spell Checking](#)<sup>[1552]</sup>.

## 8.1 Model Validation



You use Model Validation to check UML models against known [UML rules](#)<sup>[1530]</sup> (which you identify in [configuring validation](#)<sup>[1530]</sup>) as well as any constraints defined within the model, using the Object Constraint Language (OCL).

You can run Model Validation against a single UML element, a diagram or an entire package. Validating a UML:

- **Element** validates the element and its children, features (attributes and operations) and relationships (connectors)
- **Diagram** validates the diagram itself (for correctness) as well as any elements and connectors within the diagram
- **Package** validates the package and all subpackages, elements, connectors and diagrams within it.

To use Model Validation, follow the steps below:

1. Select the package, diagram or element either from the **Project Browser** or within an open diagram.
2. Select the **Project | Model Validation | Validate Selected** menu option, or press **[Ctrl]+[Alt]+[V]**.

Enterprise Architect performs the validation, and displays the results in the [Output](#)<sup>[102]</sup> window (if the **Output** window does not automatically display, select the **View | System Output** menu option).

While performing the validation, Enterprise Architect also displays a progress window containing the **Cancel Validation** button, which enables you to cancel the validation process at any time.

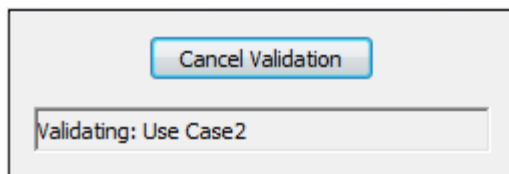

Alternatively, select the **Project | Model Validation | Cancel Validation** menu option.

### Example Model Violations

The following UML diagram contains several basic violations.

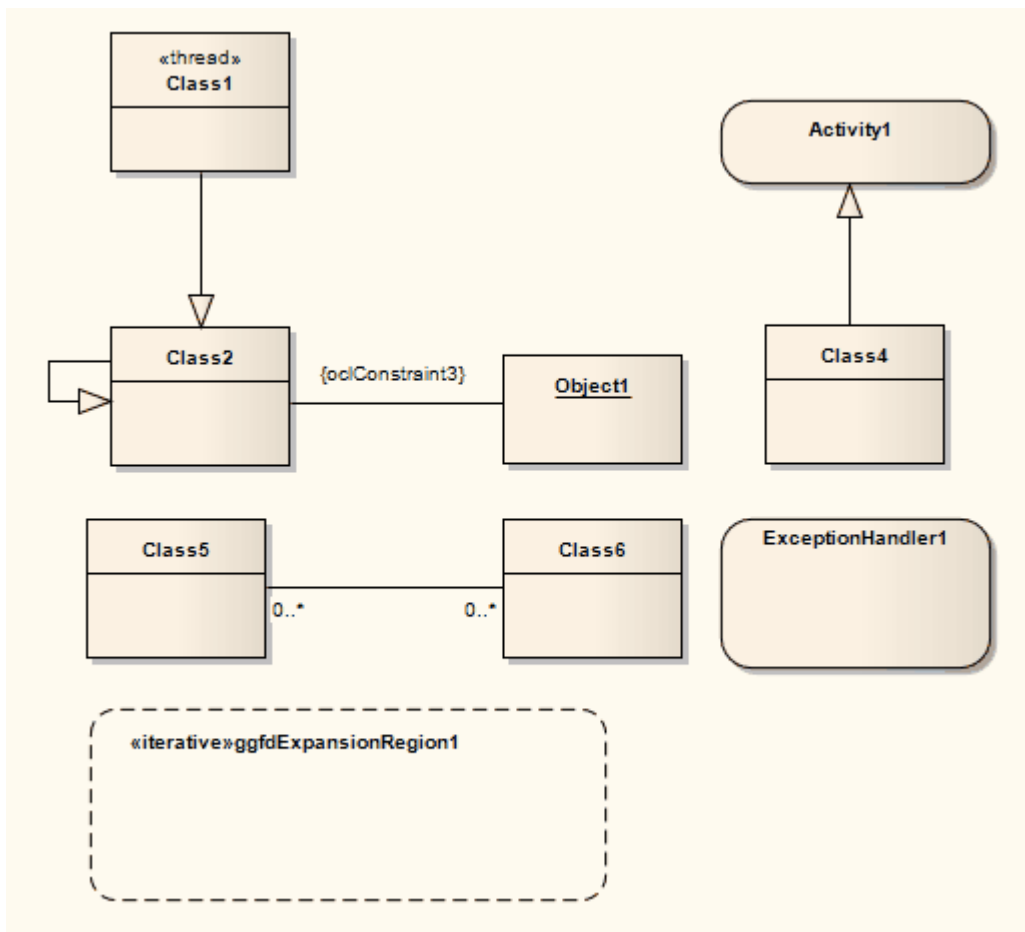

If you run Model Validation on this diagram, Enterprise Architect lists the following violations in the **Output** window:

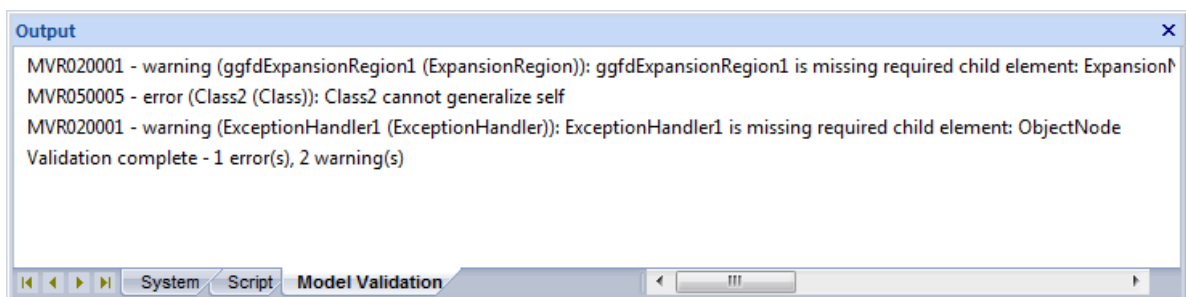

The validation results show that the diagram:

- Contains a UML ExpansionRegion (*ExpansionRegion1*) that is missing its child input ExpansionNode
- Contains an invalid self-generalization on *Class2* (UML elements cannot be self-generalized)
- Contains an OCL violation for the anonymous Association (between *Class2* and *Object1*)
- Contains a UML ExceptionHandler (*ExceptionHandler1*) that is missing its child input ObjectNode.

**Note:**

If you double-click on an error in the **Output** window, you select the diagram element that the error message refers to.

### 8.1.1 Configure Model Validation

Use the **Model Validation Configuration** dialog to enable and disable the [rules](#) that are run with the model validator. You can define additional rules in this dialog from any additional Add-Ins that might be installed besides Enterprise Architect.

To display the **Model Validation Configuration** dialog, select the **Project | Model Validation | Configure** menu option.

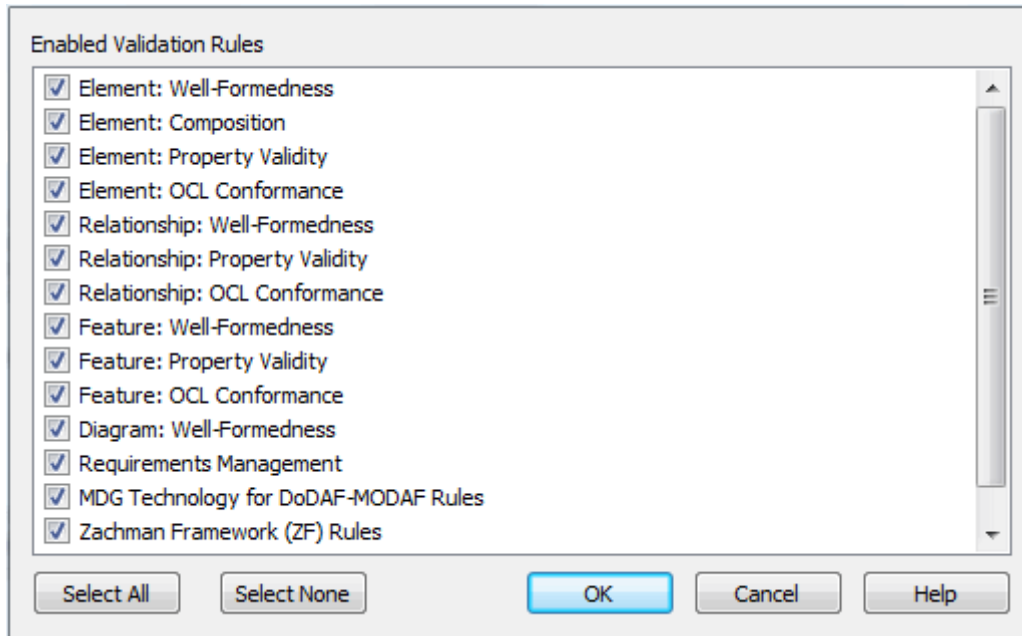

Click on the checkbox against each Validation Rule to apply in performing a [model validation](#).

#### Tip:

To disable UML syntax ("The requested connection is not UML compliant"), select the **Tools | Options** menu option, click on **Diagram** in the hierarchy, and in the **General** panel deselect the **Strict UML Syntax** checkbox.

When you perform a validation, each violation listed on the [Output](#) window has a violation ID of the format *MVRxxnnnn*, where:

- *MVR* stands for Model Validation Rule
- *xx* is a hexadecimal number corresponding to the position of the validation rule in the **Model Validation Configuration** dialog, thus indicating which rule is applied and violated
- *nnnn* is the number of the violation message.

Therefore, messages with the ID *MVR01nnnn* indicate that the **Element: Well-Formedness** checkbox is selected and a violation of that rule has been detected. Messages with the ID *MVR0Annnn* indicate that the **Feature: OCL Conformance** checkbox (10<sup>th</sup> in order on the dialog, or A<sup>th</sup> in hexadecimal) is selected and a violation of that rule has been detected.

### 8.1.2 Rules Reference

Model Validation works against a set of validation rules, arranged in the following groups:

- [\(Element, Relationship, Feature, Diagram\): Well-Formedness](#) Checks whether or not an element, relationship, feature or diagram is well-formed. This group of rules includes checks such as whether the item is a valid UML item and whether a diagram contains valid elements within it
- [Element: Composition](#) Checks whether or not a UML element contains valid children, whether it contains the right number of valid children, and whether or not the element is missing any required children
- [\(Element, Relationship, Feature\): Property Validity](#)

Checks whether or not the item has the correct UML properties defined, and whether the properties contain incorrect or conflicting values; for more information on these properties see the [Custom Properties](#)<sup>[550]</sup> topic

- [\(Element, Relationship, Feature\): OCL Conformance](#)<sup>[1532]</sup>  
Validates an item against any defined constraints in OCL.

### 8.1.2.1 Well-Formedness

The well-formedness group of rules checks whether or not an element, relationship, feature or diagram is well formed.

The rules includes checks such as whether the item is a valid UML item and whether a diagram contains valid elements within it. Reported violations include:

Violation ID	Description	Information
MVR010001	«Element» is not a valid UML Element	The element is not a recognized UML 2.3 element.
MVR050001	«Relationship» is not a valid UML Relationship	The relationship is not a recognized UML 2.3 relationship.
MVR050002	«Relationship» is not legal for «Start Element» --> «End Element»	The relationship between the given start and end elements is not valid for those elements.
MVR050003	«Parent Element»:isLeaf=true and cannot be generalized by «Child Element»	The Generalization relationship cannot exist between parent and child elements because the parent element is defined as a leaf element.
MVR050004	«Child Element»:isRoot=true and cannot generalize «Parent Element»	The Generalization relationship cannot exist between parent and child elements because the child element is defined as a root element.
MVR050005	«Element» cannot generalize self	The element cannot be self-generalized.
MVR0B0001	Statechart violation: «extended information»	The State diagram contains a UML violation; see the extended information for more information about the detected violation.

### 8.1.2.2 Element Composition

The element composition group of rules checks whether or not a UML element contains valid children, whether it contains the right number of valid children, and whether or not the element is missing any required children.

Error ID	Description	Information
MVR020001	«Element» is missing required child element «Child Element».	The element is missing a child element of type <i>Child Element</i> .
MVR020002	Invalid UML package child.	The element cannot be a direct package child and must be a child of another element (for example: Ports must be children of other elements, and not direct UML package members).
MVR020003	Invalid child «Child Element name» («Child Element Type»).	The child element is invalid on the tested parent element.

### 8.1.2.3 Property Validity

The property validity group checks whether or not an element, relationship or feature has the correct UML properties defined for it and whether they contain incorrect or conflicting values.

For more information about these properties see the [Custom Properties](#)<sup>[1730]</sup> topic.

Error ID	Description	Information
MVR030001	«Element»:«Property» property is undefined	The element property contains no value.
MVR030002	«Element»:«Property» property has invalid value: "«Value»"	The element property contains an invalid value.
MVR030003	«Element»:isLeaf=true and cannot be abstract	The element's <i>isLeaf</i> and <i>isAbstract</i> properties are both set to <b>true</b> , which is invalid.
MVR060001	«Relationship»:«Property» property is undefined	The relationship property contains no value.
MVR060002	«Relationship»:«Property» property has invalid value: "«Value»"	The relationship property contains an invalid value.
MVR090001	Attribute/AssociationEnd mismatch, «Attribute»: «Mismatch description»,...	The given attribute has an <i>associationEnd</i> of the same name but they differ in the listed details.

### 8.1.2.4 OCL Conformance

The OCL conformance group validates an element, relationship or attribute against any defined constraints in the Object Constraint Language (OCL).

OCL is used to describe expressions on UML models, and to express side-effect free constraints. You can add OCL constraints to any element, relationship or attribute in Enterprise Architect.

Error ID	Description	Information
MVR040001	OCL violation: «violated OCL»	The element violates the OCL constraint specified.
MVR070001	OCL violation: «violated OCL»	The relationship violates the OCL constraint specified.
MVR0A0001	OCL violation: «violated OCL»	The attribute violates the OCL constraint specified.

#### Important:

To have a valid OCL constraint, the syntax must be correctly formed. If the expression is not correct, Enterprise Architect displays a message stating that the OCL constraint is not valid.

### Define OCL Constraints for an Element

You can add OCL constraints to an element using the **Properties** dialog (**Element | Properties**). Select the **Constraints** tab, click on the **Type** drop-down arrow and select **OCL**.



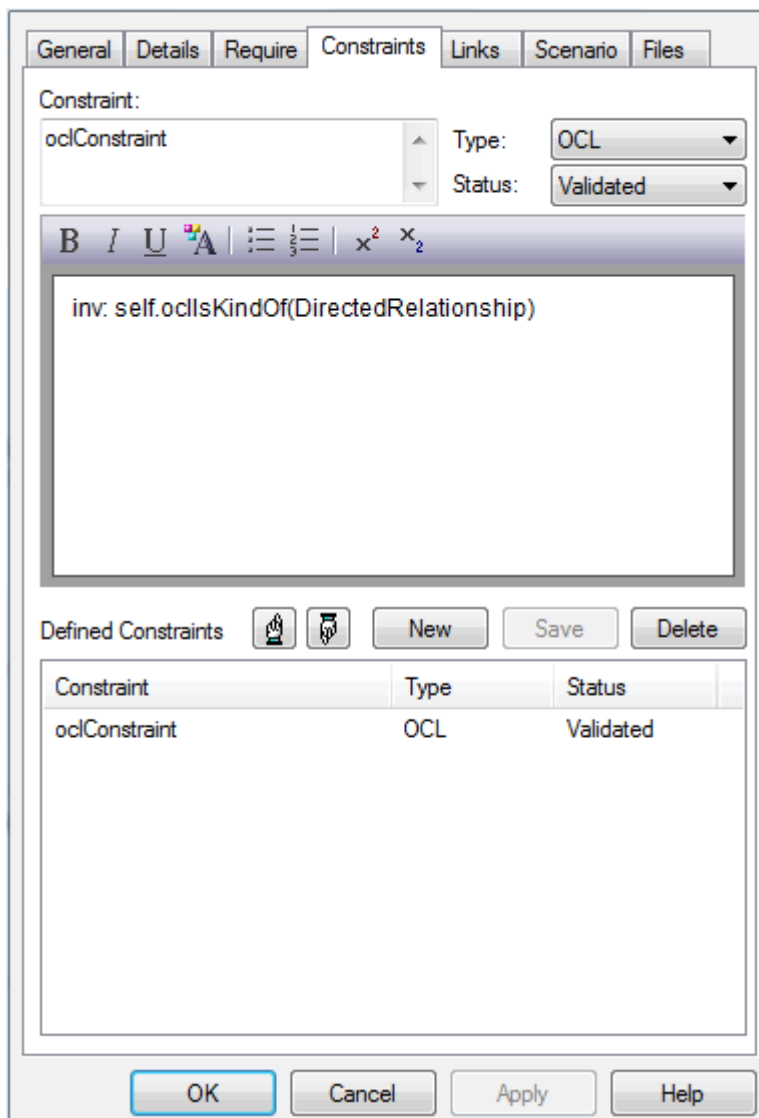

To perform an OCL Validation, display the [Model Validation Configuration](#) <sup>[1530]</sup> dialog and select the **Element: (OCL) Conformance** checkbox. Any OCL violations are recorded in the **Model Validation** tab of the [Output](#) <sup>[1529]</sup> window.

### Define OCL Constraints for a Relationship

You can add OCL constraints to a relationship using the **Properties** dialog (right-click and select the **<type> Properties** context menu option). Select the **Constraints** tab, click on the **Type** drop-down arrow and select **OCL**.

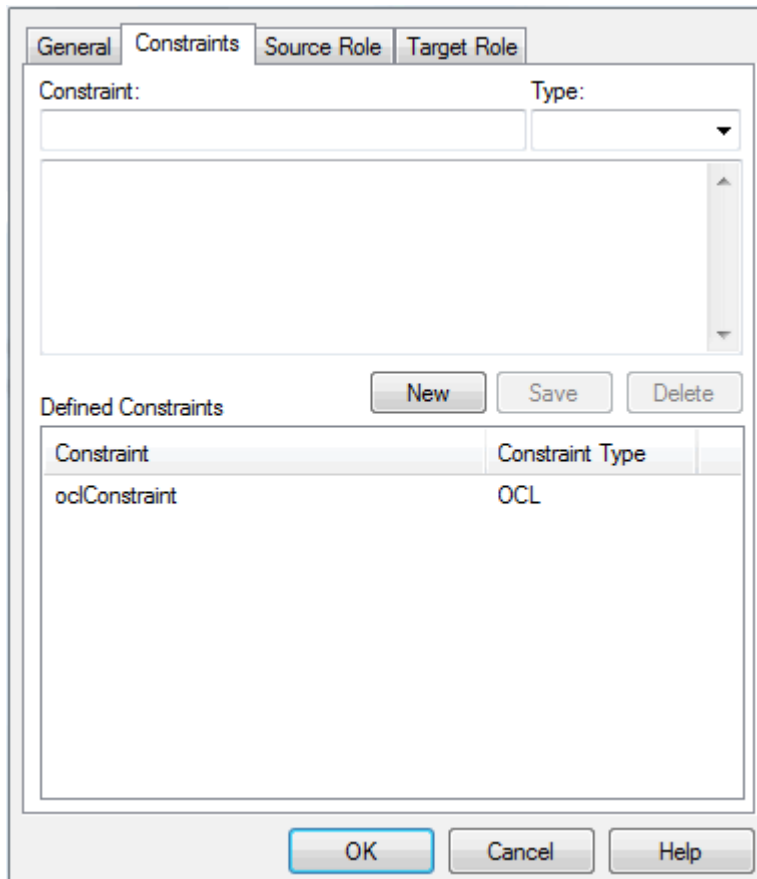

To perform an OCL Validation, display the **Model Validation Configuration** dialog and select the **Relationship: (OCL) Conformance** checkbox. Any OCL violations are recorded in the **Model Validation** tab of the **Output** window.

### Define OCL Constraints for an Attribute

You can add OCL constraints to a feature using the **Properties** dialog (**Element | Attributes**). Select the **Constraints** tab, click on the **Type** drop-down arrow and select **OCL**.

General Detail Constraints

Constraints for:

Constraint: oclConstraint Type: OCL

inv: self.oclIsKindOf(DirectedRelationship)

New Save Delete

Constraint	Type
oclConstraint	OCL

Close Cancel Help

To perform an OCL Validation, display the **Model Validation Configuration** dialog and select the **Feature: (OCL) Conformance** checkbox. Any OCL violations are recorded in the **Model Validation** tab of the **Output** window.

## 8.2 Testing

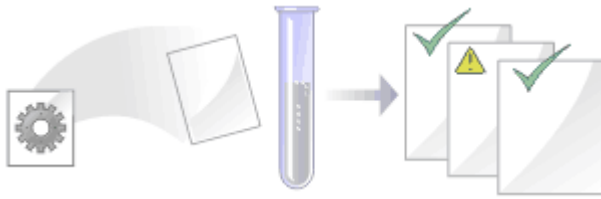

### Introduction to Testing

In addition to the integrated [JUnit and NUnit testing](#) <sup>[1512]</sup> capabilities, Enterprise Architect enables you to create and manage test scripts for model elements, covering unit, integration, scenario, system and acceptance tests.

You can import tests from other elements, generate them from scenarios, and generate test documentation and reports. You can also indicate the presence of tests on an element by displaying test information on the element in a diagram.

Enterprise Architect enables you to attach arbitrarily complex tests to any model element. Keeping the model elements and the testing documentation in one integrated model significantly improves the communication between the test-team and the software developers and architects. The detailed search facilities make it easy to find failing test cases, test cases not run and tests cases that have been passed. Using the testing and search capabilities, it is easy to navigate through the model and quickly locate problem spots, design flaws and other critical issues. Enterprise Architect is not only a UML Modeling environment, it is also a complete Test Management environment.

### Basic Tasks

Simple tasks that you might perform include:

- [Open the Testing Workspace](#) <sup>[1537]</sup>
- [Use the Test Details Dialog](#) <sup>[1538]</sup>.

### Categories

Typically you create:

- [Unit tests](#) <sup>[1539]</sup> for things that are being built, such as Classes and components
- [Integration tests](#) <sup>[1540]</sup> to test how components work together
- [System tests](#) <sup>[1541]</sup> to ensure the system meets business requirements
- [Acceptance tests](#) <sup>[1542]</sup> to test user satisfaction, and
- [Scenario tests](#) <sup>[1543]</sup> to test the end-to-end suitability and functionality of the application.

### Using Tests

Other tasks that you might perform when working with tests include:

- [Import a Scenario as a Test](#) <sup>[1544]</sup>
- [Move or Copy Tests Between Test Types](#) <sup>[1544]</sup>
- [Import a Test from Other Elements](#) <sup>[1546]</sup>
- [Import a Responsibility or Constraint as a Test](#) <sup>[1547]</sup>
- [Create a Maintenance Item from a Test](#) <sup>[1548]</sup>
- [Generate Test Details Report](#) <sup>[1549]</sup>
- [Show Test Script Compartments](#) <sup>[1549]</sup>
- [Create Test Documentation](#) <sup>[1550]</sup>.

#### Note:

Most of the tasks identified above relate to a tests for a single element. You can make a set of tests available to a number of elements by performing the above tasks on a [Test Case](#) <sup>[848]</sup> element and then associating that Test Case with each of the other elements. The Test Case element also helps to make tests more visible in diagrams, the [Project Browser](#), windows and searches.

### 8.2.1 The Testing Workspace

The **Testing** window, or Workspace, provides a quick and convenient method of working with element tests.

When you select an element in a diagram or in the **Project Browser**, if the **Testing** window is visible the lists of tests for that element are loaded ready for modification or addition.

**Note:**

In the Corporate, Business and Software Engineering, System Engineering and Ultimate editions of Enterprise Architect, if security is enabled you must have [Manage Tests](#)<sup>[198]</sup> permission to update and delete test records.

To open the **Testing** window, select the **View | Testing** menu option. Alternatively, press **[Alt]+[3]**. The window can be docked to the application workspace.

The window has two formats, as illustrated below - *Item* mode and *List* mode respectively.

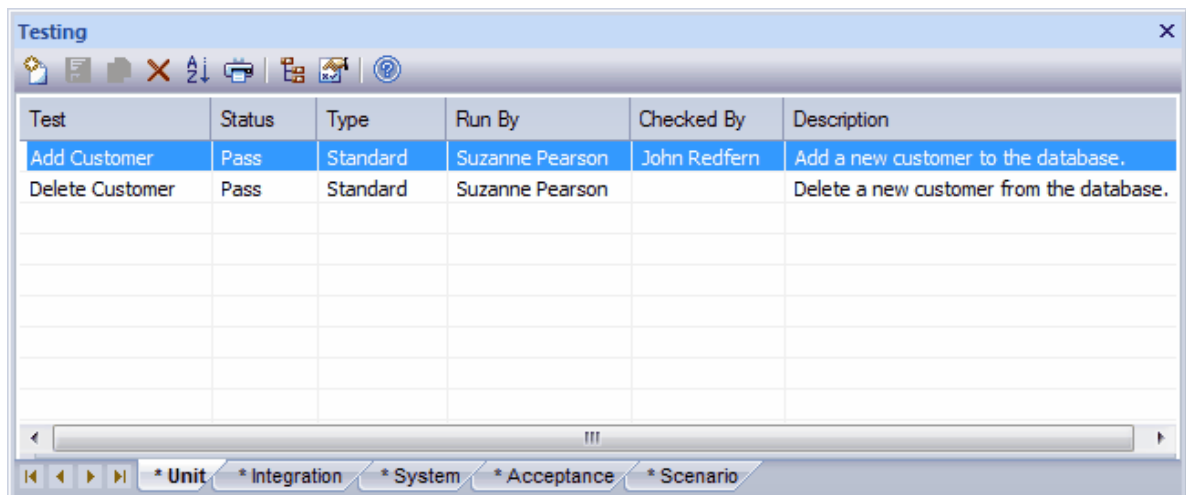
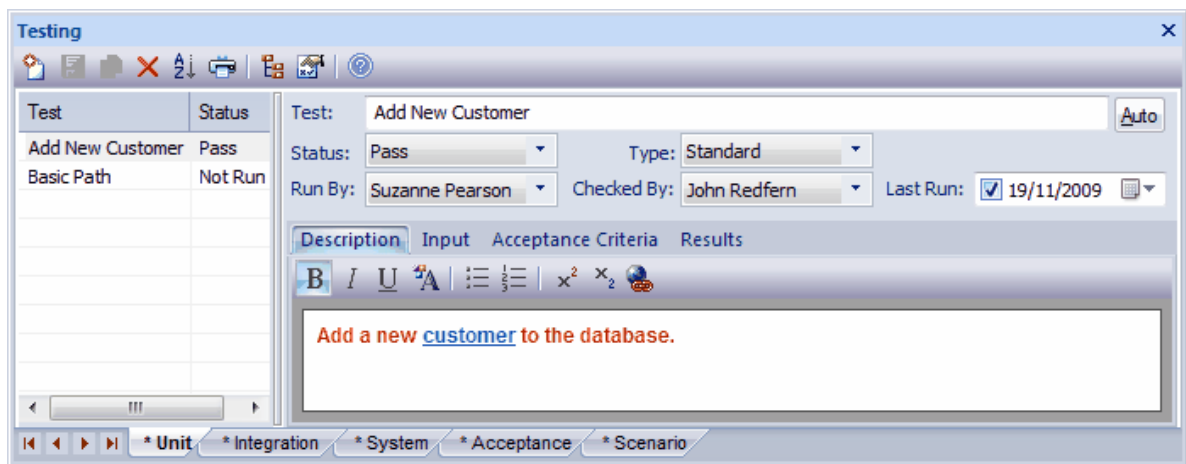

To toggle between the modes, click on the **Show/Hide Properties** button in the window toolbar.

Click on the **New** icon in the window toolbar to add new items. In Item mode, this clears the fields for new data. In List mode, this displays the [Test details](#)<sup>[1538]</sup> dialog. By clicking on the **Auto** button in Item mode or on the [Test details](#) dialog, you can apply an automatic naming/numbering nomenclature that you have [previously defined](#)<sup>[525]</sup>.

There are five tabs along the base of the window; one for each of the following types of testing:

- [Unit testing](#)<sup>[1539]</sup>
- [Integration testing](#)<sup>[1540]</sup>

- [System testing](#) <sup>[1541]</sup>
- [Acceptance testing](#) <sup>[1542]</sup>
- [Scenario testing](#) <sup>[1543]</sup>

The asterisk on a tab indicates that the tab contains saved information. If there is no information for a type of test, or the information has not yet been saved, its tab has no asterisk.

The tabs toggle between Item mode and List mode independently.

## 8.2.2 The Test Details Dialog

The **Test details** dialog opens from the **Testing** window in *List* mode. (The **Testing** window displays as shown below in List mode. If it does not display like this, click on the **Show/Hide Properties** icon in the window toolbar.)

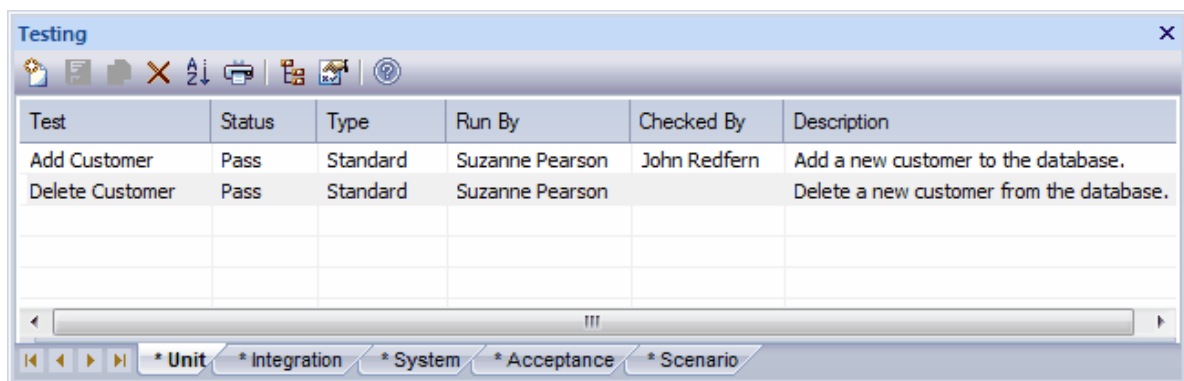

Double-click on an existing test case or click on the **New** icon in the window toolbar. The **Test Details** dialog displays.

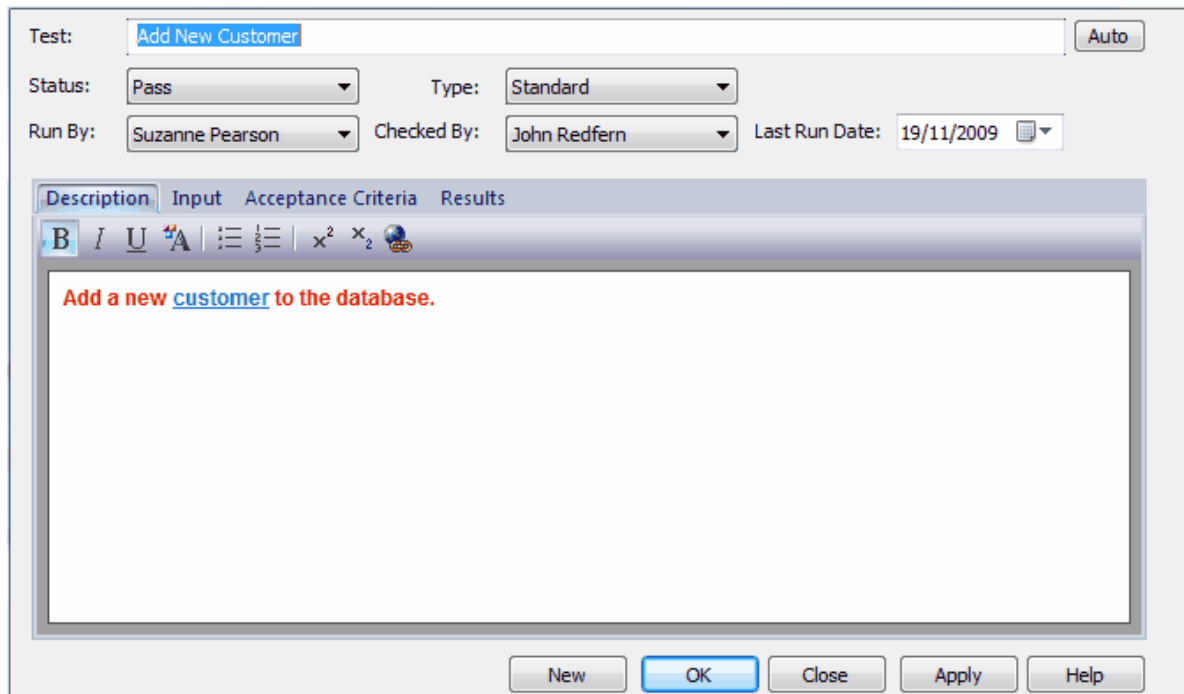

### Notes:

- Add multiple test cases in one batch by using the **New** and **Apply** buttons.
- You can format the text in the **Description**, **Input**, **Acceptance Criteria** and **Results** tabs using the **Notes** <sup>[642]</sup> toolbar at the top of the field. This text is also reflected in the **Notes** window, but cannot be edited there.

### 8.2.3 Unit Testing

Use Unit Testing to test Classes, Components and other elements as programmers build them.

The **Unit** testing tab displays in the **Testing** window by default. To open the **Testing** window, select the **View | Testing** menu option. Open a diagram or the **Project Browser** and select the required element.

If any Unit tests exist, the first Test item for the element is shown in the **Testing** window in Item mode, and all items are listed either in the panel to the left of the window, or in the window in List mode.

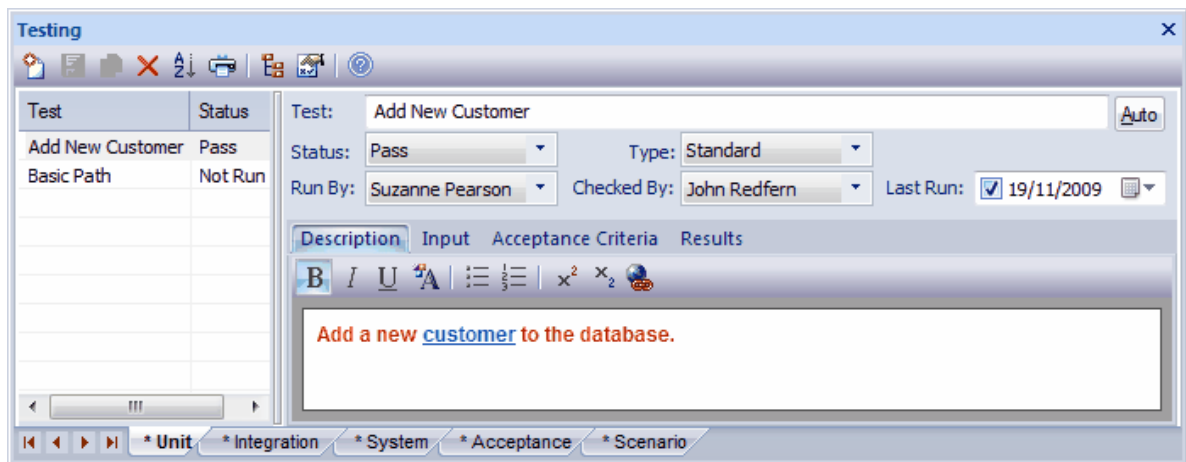

Option	Use to
<b>Test</b>	Specify the name of the test.
<b>Status</b>	Click on the drop-down arrow and select the current status of the test.
<b>Type</b>	Click on the drop-down arrow and select the type of test.
<b>Run By</b>	Click on the drop-down arrow and select the name of the person who ran the test.
<b>Checked By</b>	Click on the drop-down arrow and select the name of the person who checked the test run.
<b>Last Run</b>	Click on the drop-down arrow and select the date on which the test was last run.
<b>Description</b>	Type a description of the test. You can format the text using the <a href="#">Notes</a> [642] toolbar at the top of the field. This text is also reflected in the <b>Notes</b> window, but cannot be edited there.
<b>Input</b>	Type in the input data.
<b>Acceptance Criteria</b>	Type the acceptance or test success conditions.
<b>Results</b>	Type the results of the last test.

To edit existing Unit Test items for this element:

- Click on the item in the left-hand panel in Item mode
- Double-click on the item in List mode to display the [Test Details](#) [1538] dialog, or
- Click on the required item in the **Testing** folder in the [Element Browser](#) [510] window; if this window is not displayed, click on the  icon in the **Testing** window toolbar. Unit Test item icons have a **U** in the bottom right corner.

To change the element for which to create test items, click on the required element in the **Project Browser**.

## 8.2.4 Integration Testing

Use Integration Testing to test how the constructed components work together.

To display Integration Testing details select the **View | Testing** menu option to display the **Testing** window. Open a diagram or the **Project Browser** and select the required element. Click on the **Integration** tab.

If any Integration tests exist, the first Test item for the element is shown in the **Testing** window in Item mode, and all items are listed either in the panel to the left of the window, or in the window in List mode.

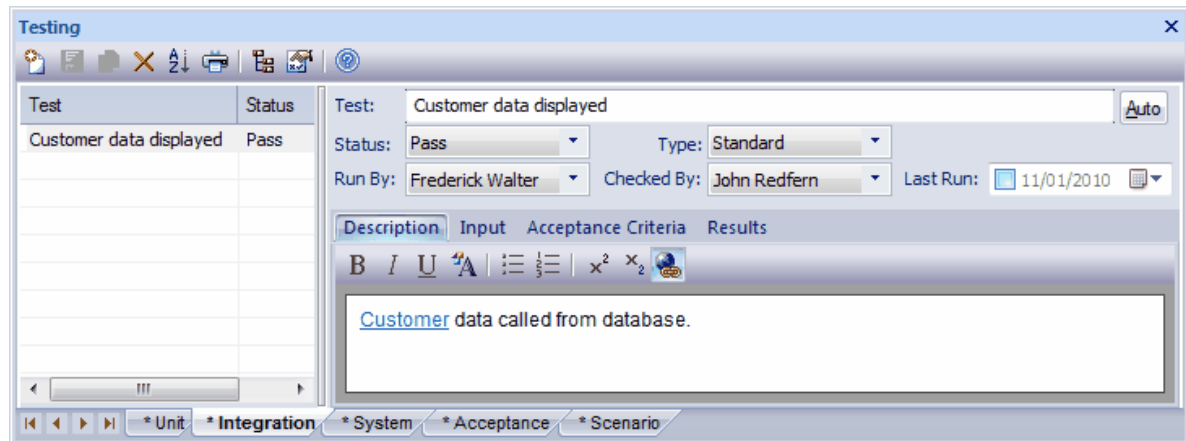

Option	Use to
<b>Test</b>	Specify the name of the test.
<b>Status</b>	Click on the drop-down arrow and select the current status of the test.
<b>Type</b>	Click on the drop-down arrow and select the type of test.
<b>Run By</b>	Click on the drop-down arrow and select the name of the person who ran the test.
<b>Checked By</b>	Click on the drop-down arrow and select the name of the person who checked the test run.
<b>Last Run</b>	Click on the drop-down arrow and select the date on which the test was last run.
<b>Description</b>	Type a description of the test. You can format the text using the <a href="#">Notes</a> <sup>[642]</sup> toolbar at the top of the field. This text is also reflected in the <b>Notes</b> window, but cannot be edited there.
<b>Input</b>	Type in the input data.
<b>Acceptance Criteria</b>	Type the acceptance or test success conditions.
<b>Results</b>	Type the results of the last test.

To edit existing Integration Test items for this element:

- Click on the item in the left-hand panel in Item mode
- Double-click on the item in List mode to display the [Test Details](#) <sup>[1538]</sup> dialog, or
- Click on the required item in the **Testing** folder in the [Element Browser](#) <sup>[510]</sup> window; if this window is not displayed, click on the  icon in the **Testing** window toolbar. Integration Test item icons have an **I** in the bottom right corner.

To change the element for which to create test items, click on the required element in the **Project Browser**.



### 8.2.5 System Testing

Use System Testing to test that the system performs the right business functions correctly.

To display System Testing details select the **View | Testing** menu option to display the **Testing** window. Open a diagram or the **Project Browser** and select the required element. Click on the **System** tab.

If any System Tests exist, the first Test item for the element is shown in the **Testing** window in Item mode, and all items are listed either in the panel to the left of the window, or in the window in List mode.

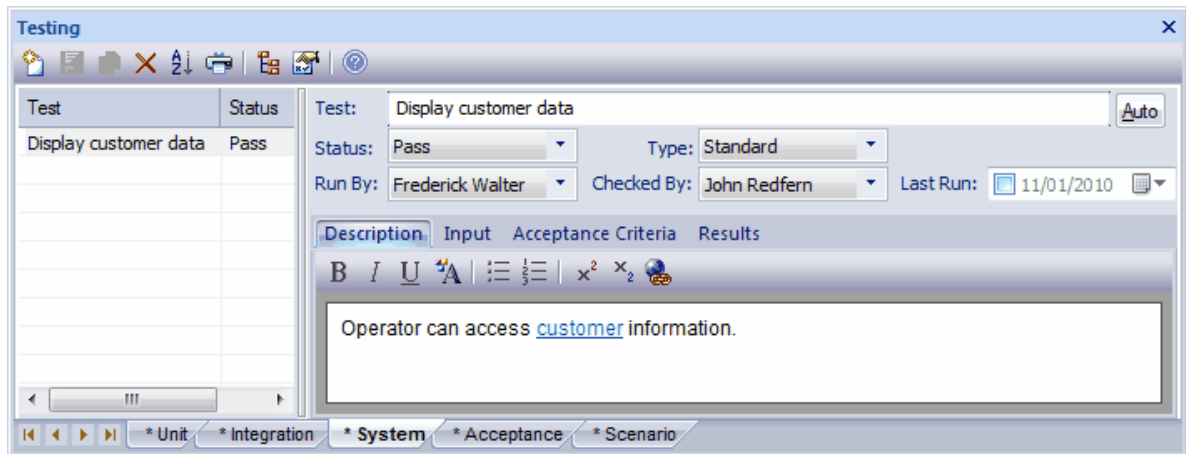

Option	Use to
Test	Specify the name of the test.
Status	Click on the drop-down arrow and select the current status of the test.
Type	Click on the drop-down arrow and select the type of test.
Run By	Click on the drop-down arrow and select the name of the person who ran the test.
Checked By	Click on the drop-down arrow and select the name of the person who checked the test run.
Last Run	Click on the drop-down arrow and select the date on which the test was last run.
Description	Type a description of the test. You can format the text using the <b>Notes</b> <sup>[642]</sup> toolbar at the top of the field. This text is also reflected in the <b>Notes</b> window, but cannot be edited there.
Input	Type in the input data.
Acceptance Criteria	Type the acceptance or test success conditions.
Results	Type the results of the last test.

To edit existing System Test items for this element:

- Click on the item in the left-hand panel in Item mode
- Double-click on the item in List mode to display the **Test Details** <sup>[1538]</sup> dialog, or
- Click on the required item in the **Testing** folder in the **Element Browser** <sup>[510]</sup> window; if this window is not displayed, click on the  icon in the **Testing** window toolbar. System Test item icons have an **Sy** in the bottom right corner.

To change the element for which to create test items, click on the required element in the **Project Browser**.

## 8.2.6 Acceptance Testing

Use Acceptance Testing to ensure that users are satisfied with the system.

To display Acceptance Testing details select the **View | Testing** menu option to display the **Testing** window. Open a diagram or the **Project Browser** and select the required element. Click on the **Acceptance** tab.

If any Acceptance Tests exist, the first Test item for the element is shown in the **Testing** window in Item mode, and all items are listed either in the panel to the left of the window, or in the window in List mode.

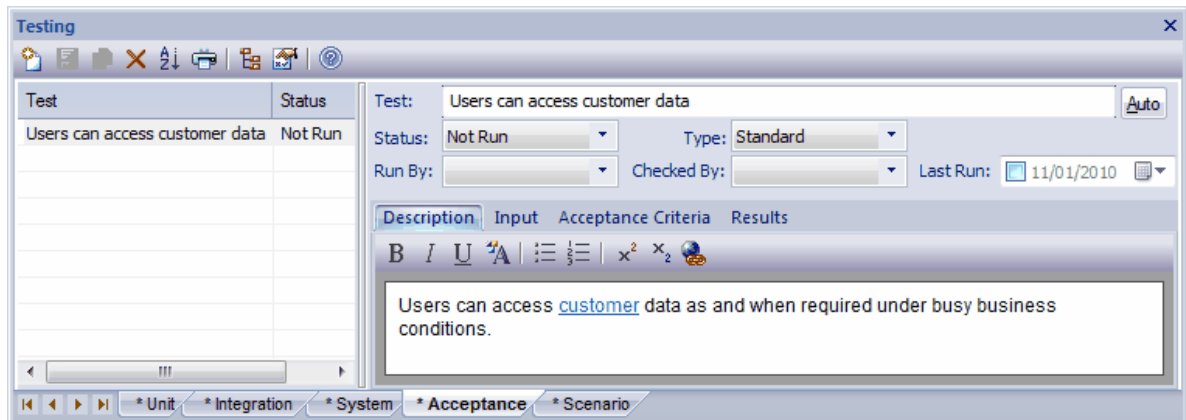

Option	Use to
<b>Test</b>	Specify the name of the test.
<b>Status</b>	Click on the drop-down arrow and select the current status of the test.
<b>Type</b>	Click on the drop-down arrow and select the type of test.
<b>Run By</b>	Click on the drop-down arrow and select the name of the person who ran the test.
<b>Checked By</b>	Click on the drop-down arrow and select the name of the person who checked the test run.
<b>Last Run</b>	Click on the drop-down arrow and select the date on which the test was last run.
<b>Description</b>	Type a description of the test. You can format the text using the <a href="#">Notes</a> <sup>[642]</sup> toolbar at the top of the field. This text is also reflected in the <b>Notes</b> window, but cannot be edited there.
<b>Input</b>	Type in the input data.
<b>Acceptance Criteria</b>	Type the acceptance or test success conditions.
<b>Results</b>	Type the results of the last test.

To edit existing Acceptance Test items for this element:

- Click on the item in the left-hand panel in Item mode
- Double-click on the item in List mode to display the [Test Details](#) <sup>[1538]</sup> dialog, or
- Click on the required item in the *Testing* folder in the [Element Browser](#) <sup>[510]</sup> window; if this window is not displayed, click on the  icon in the **Testing** window toolbar. Acceptance Test item icons have an **A** in the bottom right corner.

To change the element for which to create test items, click on the required element in the **Project Browser**.

### 8.2.7 Scenario Testing

Use Scenario Testing to test the application with real-world situations and scenarios. An end-to-end test of all functions.

To display Scenario Testing details select the **View | Testing** menu option to display the **Testing** window. Open a diagram or the **Project Browser** and select the required element. Click on the **Scenario** tab.

If any Scenario Tests exist, the first Test item for the element is shown in the **Testing** window in Item mode, and all items are listed either in the panel to the left of the window, or in the window in List mode.

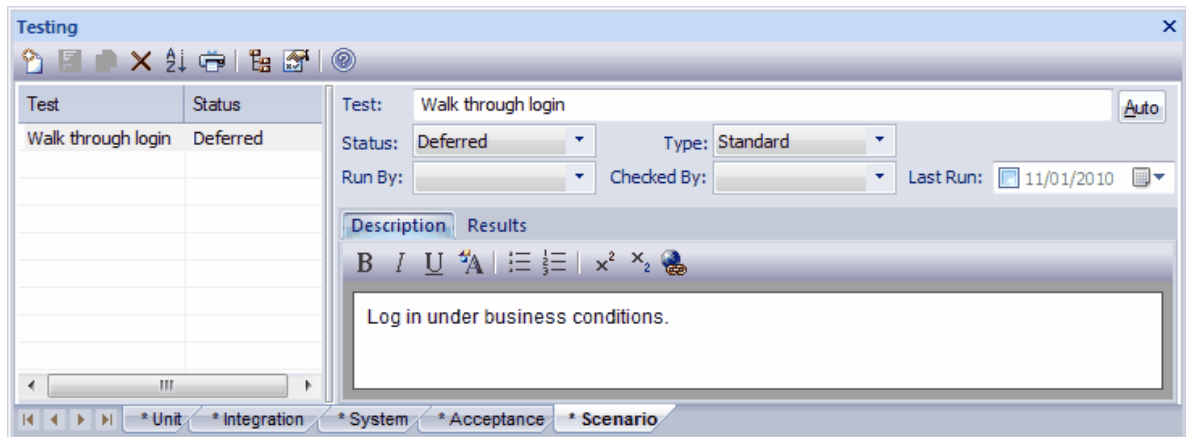

Option	Use to
Test	Specify the name of the test.
Status	Click on the drop-down arrow and select the current status of the test.
Type	Click on the drop-down arrow and select the type of test.
Run By	Click on the drop-down arrow and select the name of the person who ran the test.
Checked By	Click on the drop-down arrow and select the name of the person who checked the test run.
Last Run	Click on the drop-down arrow and select the date on which the test was last run.
Description	Type a description of the test. You can format the text using the <a href="#">Notes</a> [642] toolbar at the top of the field. This text is also reflected in the <b>Notes</b> window, but cannot be edited there.
Input	Type in the input data.
Acceptance Criteria	Type the acceptance or test success conditions.
Results	Type the results of the last test.

To edit existing Scenario Test items for this element:

- Click on the item in the left-hand panel in Item mode
- Double-click on the item in List mode to display the [Test Details](#) [1535] dialog, or
- Click on the required item in the **Testing** folder in the [Element Browser](#) [510] window; if this window is not displayed, click on the  icon in the **Testing** window toolbar. Scenario Test item icons have an **Sc** in the bottom right corner.

To change the element for which to create test items, click on the required element in the **Project Browser**.

## 8.2.8 Move or Copy Tests Between Categories

When you define a test on the **Unit**, **Integration**, **System**, **Acceptance** or **Scenario** tab of the **Testing** window, you might decide that the test either is better suited to another category of tests, or forms a good template for tests in other categories. Enterprise Architect enables you to move or copy tests between categories.

To move or copy a test, follow the steps below:

1. Open either:
  - The **Testing** window, and the tab that contains the test you want to move or copy, or
  - The *Testing* folder of the **Element Browser**  window.
2. Right-click on the required test item in the list. The item context menu displays.
3. Click on the appropriate option - **Move to** or **Copy to**. A list of test categories displays.
4. Click on the test category to which to move or copy the test. A confirmatory prompt displays.

### Note:

If you move or copy a test into the Scenario category, some unassociated data could be lost.

5. Click on the **Yes** button to confirm the move or copy.
6. Click on the target tab of the **Testing** window to ensure that the test has been added, and make any required changes.

## 8.2.9 Import Scenario as Test

You can import a scenario from a Use Case or other element, or from all elements in a package, into the **Testing** window **Scenario** tab. This avoids having to duplicate the scenario information manually.

The scenario description is copied to the Scenario Test **Description** tab in the **Testing** window. If a scenario contains a Structured Specification, its Action steps are also copied to the **Description** tab under the heading **Structured Specification**.

## Import Element Scenarios

To import one or more scenarios from a specific element, follow the steps below:

1. Open a diagram or the **Project Browser** and select the element into which to import the scenario.
2. Open either:
  - The **Testing** window and the **Scenario** tab, or
  - The *Testing* folder of the **Element Browser**  window.
3. Right-click on the list of tests to display the context menu, and select the **Import element scenario(s)** menu option. The **Import Scenario** dialog displays.

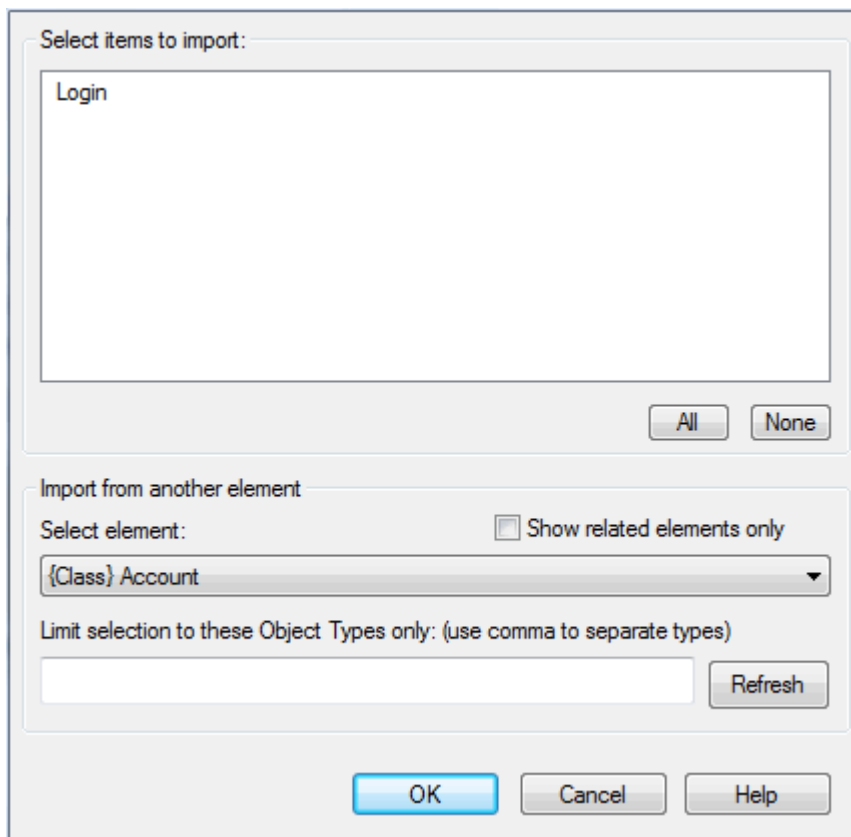

4. You can import scenarios from any element in the model by clicking on the **Select element** drop-down arrow and selecting the required element. Select the scenarios to import from the **Select items to import** list.
5. Click on the **OK** button to import the selected scenario(s).

The **Import Scenario** dialog has the following additional options:

Option	Use to
<b>Show related elements only</b>	Filter selection to apply only to related elements.
<b>Limit selection to these Object Types only</b>	Type in specific element types, separated by commas, to filter for only those element types.
<b>Refresh</b>	Refresh the list of available scenarios.

### Import Package Scenarios

To import scenarios from all elements in a package, follow the steps below:

1. Open a diagram or the **Project Browser** and select the parent package element or an element within the package.
2. Open either:
  - The **Testing** window and the **Scenario** tab, or
  - The **Testing** folder of the **Element Browser** window.
3. Right-click on the list of tests to display the context menu, and select the **Import Package Scenario(s)** menu option. The **Import Scenario** dialog displays.

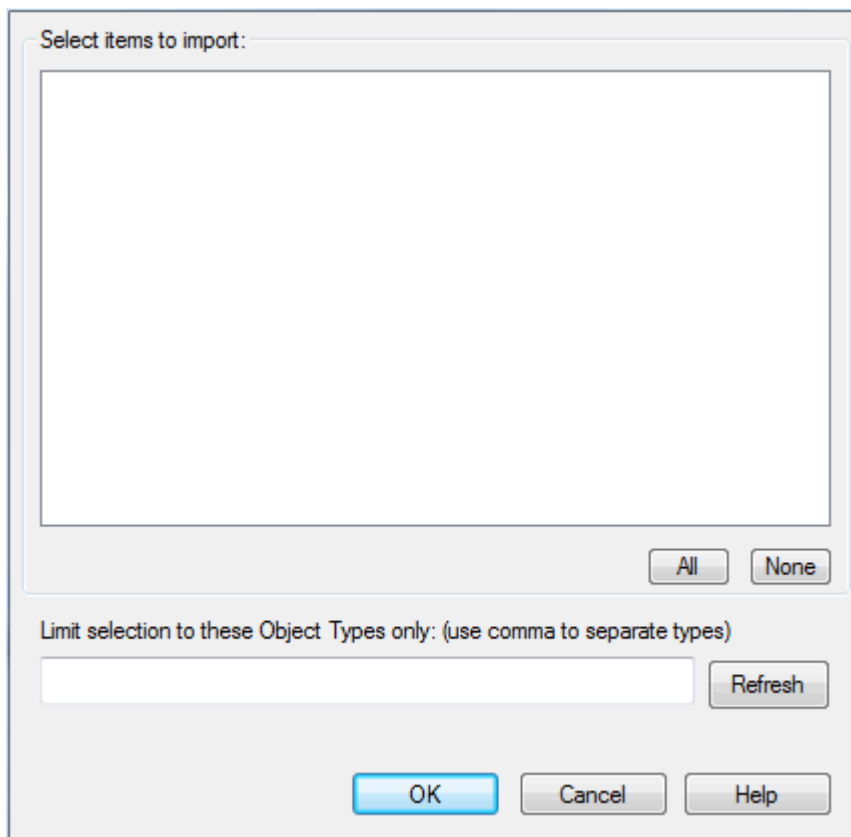

This version of the **Import Scenario** dialog lists all scenarios against all elements in the package. It does not enable you to select a specific element, but does enable you to filter the list of scenarios to those from specific types of element.

4. In the **Limit selection to these Object Types only** field, type a comma-separated list of the object types for which to show scenarios. Click on the **Refresh** button.
5. Click on the **OK** button to import the scenarios from each element as test scenarios for that element.

### 8.2.10 Import Test From Other Elements

You can import any test from a Use Case or other element into the **Testing** window. This avoids having to duplicate the test information manually.

#### Import a Test

To import a test, follow the steps below:

1. Open a diagram or the **Project Browser** and select the element into which to import the tests.
2. Open either:
  - The **Testing** window, or
  - The **Testing** folder of the **Element Browser** window.
3. Right-click on the list of tests to display the context menu, and select the **Import Tests from Other Element** menu option. The **Import Element Tests** dialog displays.

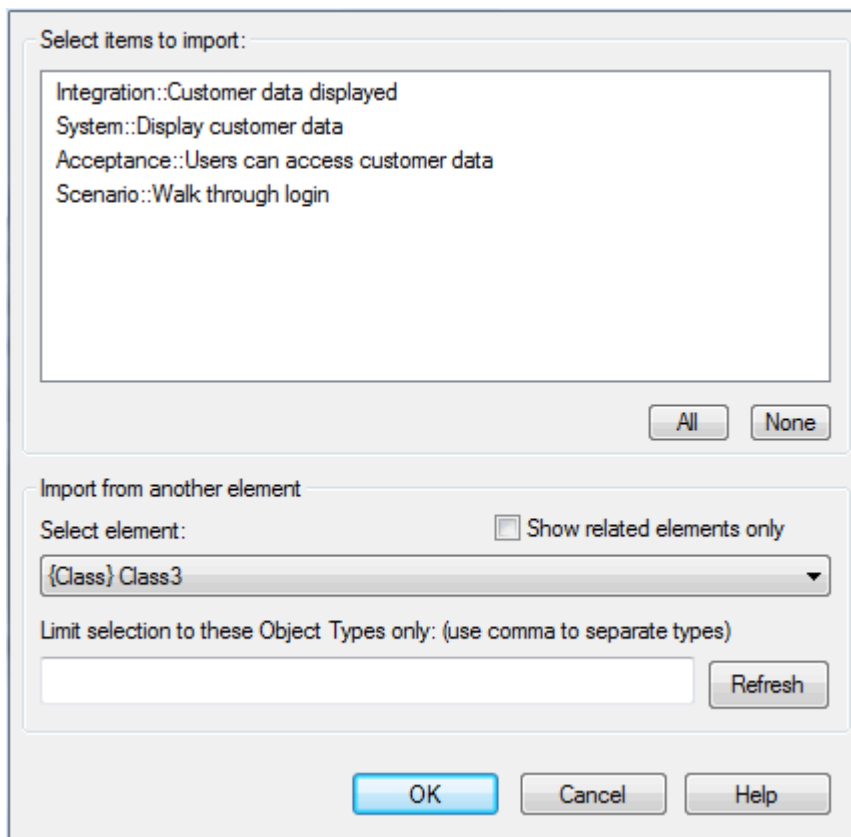

4. You can import tests from any element in the model by clicking on the **Select element** drop-down arrow and selecting the required element. Select the test to import from the **Select items to import** list.
5. Click on the **OK** button to import the selected test(s).

The **Import Element Tests** dialog has the following additional options:

Option	Use to
<b>Show related elements only</b>	Filter selection to apply only to related elements.
<b>Limit Selection to these Object Types only</b>	Type in specific element types, separated by commas, to filter for only those element types.
<b>Refresh</b>	Refresh available options.

### 8.2.11 Import Responsibility or Constraint as Test

In the same way as you can import a scenario from an element as a test, you can also import an internal requirement (responsibility) or internal constraint as a test.

To import a requirement or constraint as a test, follow the steps below:

1. Open a diagram or the **Project Browser** and select the element into which to import the responsibility or constraint.
2. Open either:
  - The **Testing** window and the tab into which to import the test, or
  - The *Testing* folder of the **Element Browser** window.
3. Right-click on the list of tests to display the context menu (if in the **Element Browser**, click on a test of the appropriate type).
4. Click on the appropriate option, either:
  - **Import element constraint(s)** or
  - **Import element requirement(s)**.

The **Import Constraint** or **Import Requirements** dialog displays (the two dialogs are identical):

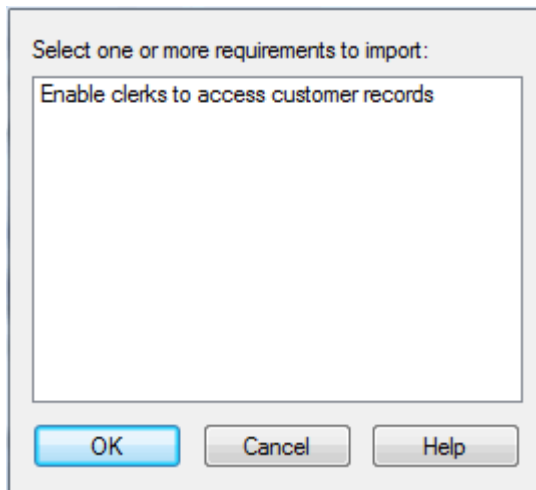

The dialog lists all of the internal requirements or constraints in the selected element.

5. Select one or more of the items to import as tests, and click on the **OK** button. Each item is added to the list of tests in the **Testing** window, as a standard, 'Not Run' test.
6. Edit the items to complete their definition as tests.

### 8.2.12 Create Maintenance Item From Test

If an element fails a test, one likely consequence is that a Defect (Issue) item has to be raised in model maintenance to correct the problem. You can generate this Defect item directly from the test that failed.

To create a Maintenance item from a test, follow the steps below.

1. In the **Testing** window, or the *Testing* folder of the **Element Browser** window, right-click on the test item from which to generate the Maintenance item.
2. On the context menu, select the **Create a Maintenance Defect from this test** menu option. The following message box displays.

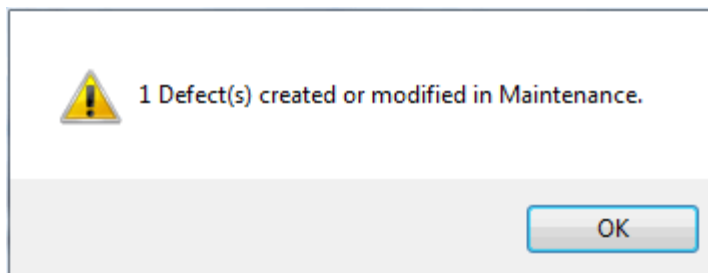

3. Click on the **OK** button to clear the message.
4. Open the **Maintenance** window and select the **Defects** tab. Notice that the window displays a defect item having the same name as the test, and the test Description, Input, Acceptance Criteria and Results texts are displayed in the defect **Description** tab.
5. [Update the defect item as required](#) (1559)

#### Note:

You can create Maintenance Defect items from several Test items at once. Press and hold **[Shift]** as you select the Test items, and then right-click and proceed as above. Each selected Test item then generates a Defect item.



### 8.2.13 Testing Details Report

You can view the **Testing Details** dialog for a package, which enables you to run filtered reports on all elements in the package hierarchy under your selection. You can also print the report details.

To access the **Testing Details** dialog, right-click on a package in the **Project Browser** to display the context menu, and select the **Documentation | Testing Details** menu option.

Test	Type	Status	Run By	Checked By	Date Run
Delete Customer	Unit	Pass	Suzanne Pearson	John Redfern	24/06/2009
Add New Customer	Unit	Pass	Suzanne Pearson	John Redfern	15/02/2009

The **Testing Details** dialog includes the following options:

Options	Use to
<b>Run By</b>	Select a name to filter for tests run by that person. Click on the <b>x</b> button to clear the field.
<b>Checked By</b>	Select a name to filter for tests checked by that person. Click on the <b>x</b> button to clear the field.
<b>Test Type</b>	Select the radio button for the required test type.
<b>Status</b>	Select the radio button for the required status.
<b>Locate Object</b>	(After clicking on an element in the <b>Test Details</b> list) locate the element in the <b>Project Browser</b> .
<b>Refresh</b>	Re-run the report query.
<b>Print</b>	Print a summary of the test results.

### 8.2.14 Show Test Script Compartments

Any element that is capable of displaying a compartment can be used to show test scripts in a diagram. To make use of the feature the element must have an attached test. To use this feature follow the steps below:

1. Open a diagram containing the element with the attached test items.
2. Double-click on the diagram background to display the **Diagram Properties** dialog. Click on the **Elements** tab.

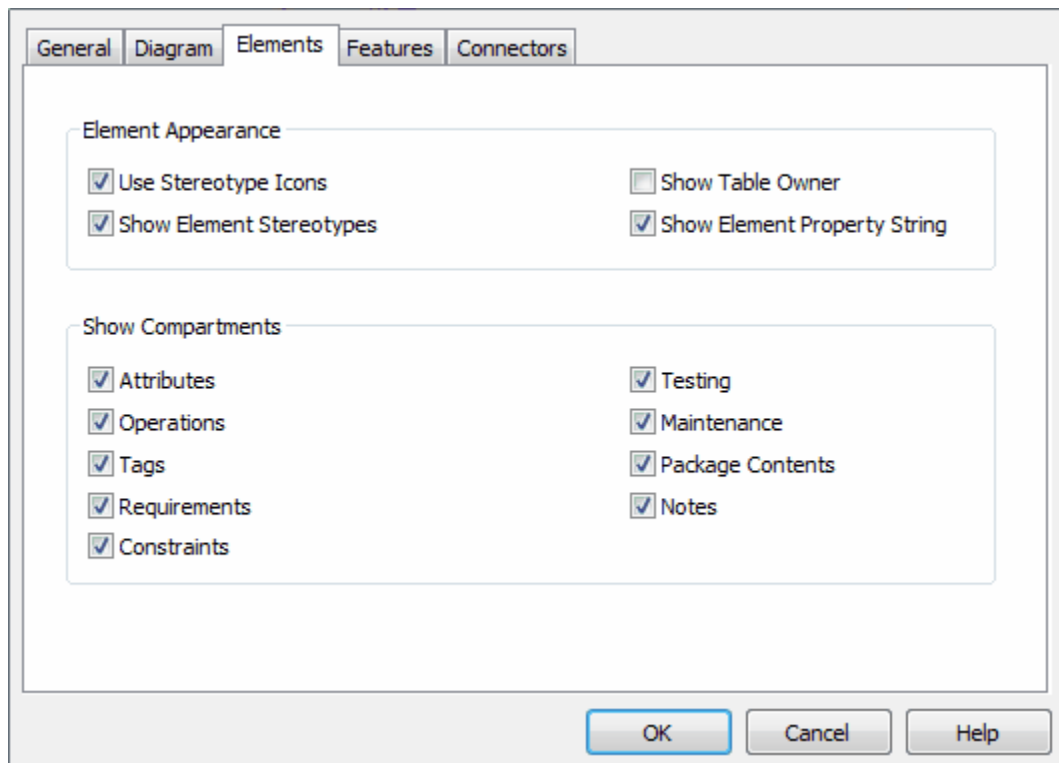

3. In the **Show Compartments** panel, select the **Testing** checkbox.
4. Click on the **OK** button to save the setting.

The tests now appear as an item in the test scripts compartment of the diagram element.

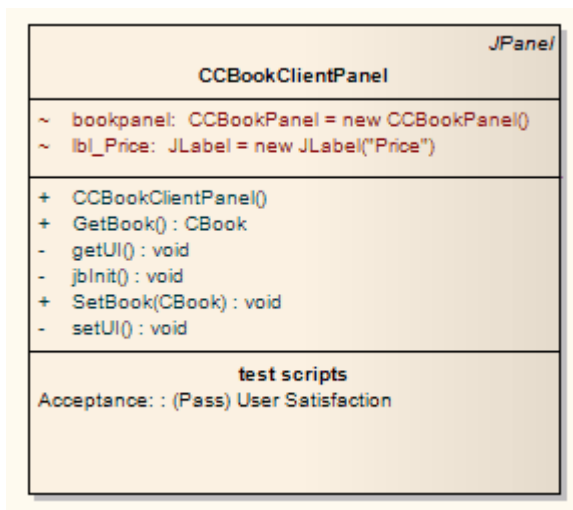

### 8.2.15 Test Documentation

Enterprise Architect enables you to output the test scripts and results you have entered against elements in the model, in Rich Text format. For more information on entering test scripts and details see the previous sections of the [Testing](#)<sup>[1536]</sup> topic.

To create the documentation, right-click on a package in the **Project Browser** and select the **Documentation | Testing Report** context menu option. The **Generate Test Documentation** dialog displays.

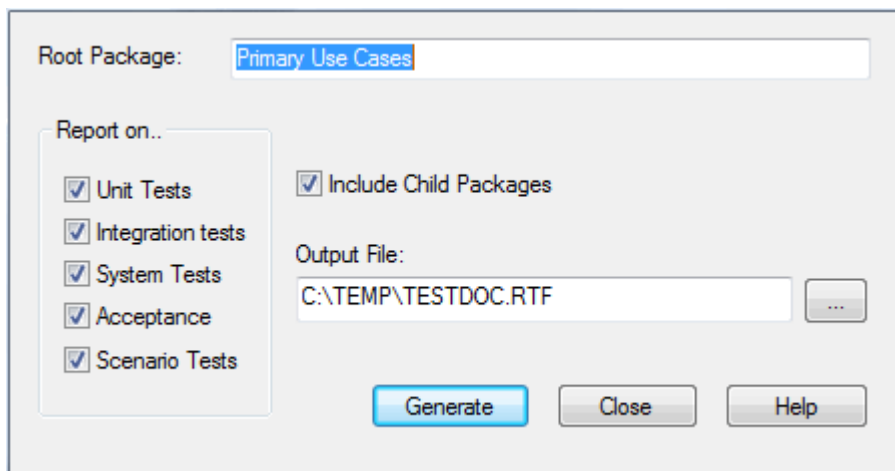
**Note:**

You can also access the **Generate Test Documentation** dialog by selecting the **Project | Documentation | Testing Report** menu option.

The **Generate Test Documentation** dialog enables you to set up your report. You can configure which tests to include or exclude in the report, whether to include child packages and what file to output to.

## 8.3 Spell Checking



Enterprise Architect provides a powerful spell checking facility. This operates at the project level and enables you to quickly spell check an entire project.

The spell checker can be set to run automatically, so that it highlights possible errors in text as it is created or pasted in. To turn automatic spell checking on and off, select the **Tools | Options** menu option, click on the **Objects** option in the page hierarchy, and then deselect or select the **Disable spelling** checkbox.

### See Also

- [Using the Spell Checker](#) <sup>[1552]</sup>
- [Correcting Words](#) <sup>[1553]</sup>
- [Select a Different Language](#) <sup>[1554]</sup>

### 8.3.1 Using the Spell Checker

Enterprise Architect has an inbuilt spell checker.

#### Notes:

- Enterprise Architect currently supports checking an entire model, and spell checking by single package. A future release will support more detailed spell checking at the element and diagram level.
- In the Corporate, Business and Software Engineering, Systems Engineering and Ultimate editions of Enterprise Architect, if security is enabled you must have [Spell Check](#) <sup>[198]</sup> permission to spell check a package and set the spell check language.

To perform a spell check, follow the steps below:

1. Select the **Tools | Spell Check Project** or **Tools | Spell Check Current Package** menu option, depending on which level of spell check you require. The **Spell Check** dialog displays.

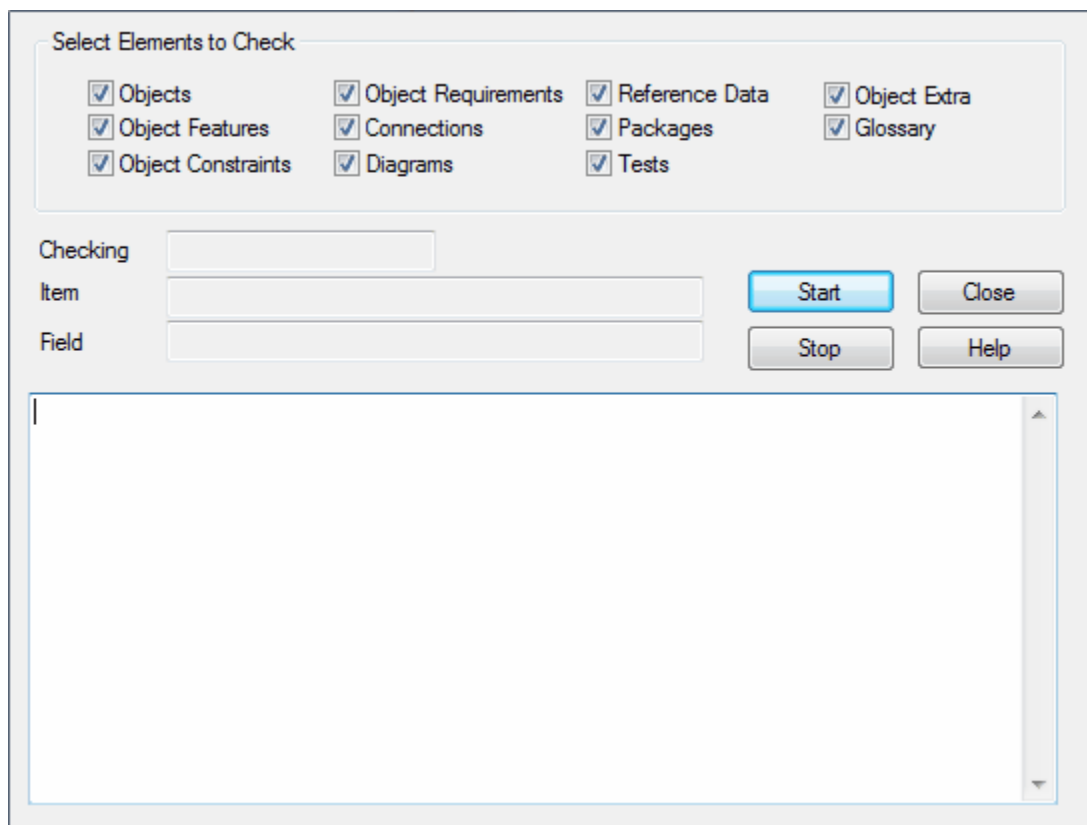
**Note:**

The **Spell Check Project** menu option enables you to check spelling for the entire project, whereas the **Spell Check Current Package** option only checks the package currently open, and does not enable you to select the options shown above.

2. Select the checkbox against each of the items to spell check within your model.
3. Click on the **Start** button to begin the spell check.
4. As the spell check proceeds, the text being checked displays in the text panel at the bottom of the screen. If an error is detected, the **Check Spelling** dialog displays, offering several [options](#) <sup>[1553]</sup> to correct the error.

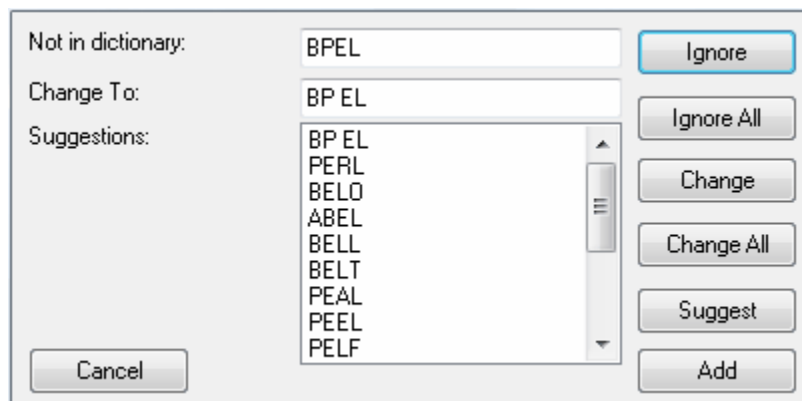

### 8.3.2 Correcting Words

As the spell check progresses, Enterprise Architect highlights any errors or unknown words in the **Check Spelling** dialog. This enables you to correct the spelling of a word, ignore the error, add the word to the User Dictionary, suggest alternatives or otherwise assist in the spelling correction process.

The inbuilt spell check stores user-defined words in the User Dictionary (*userdict.tlx*) stored in the Enterprise

Architect installation directory. During the spell check process, if you add a word, it is written into this file for later reference.

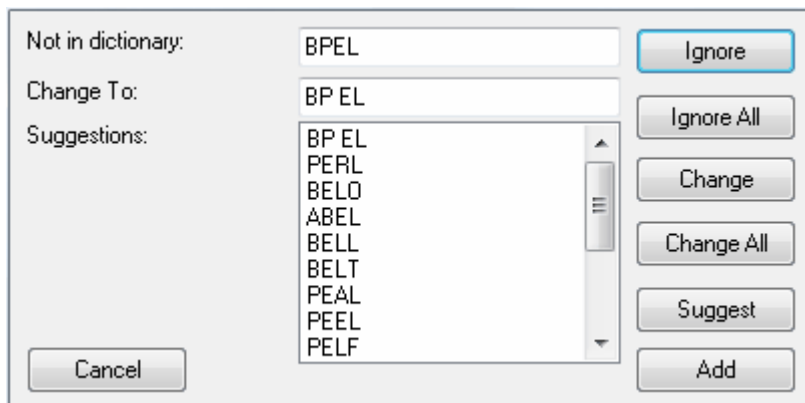

To correct the current word you can:

- Modify the spelling by hand and click on the **Change** or **Change All** button to change the word to that spelling
- Click on a suggested alternative and click on the **Change** or **Change All** button to change the word to that spelling
- Click on the **Ignore** or **Ignore All** button to exclude the word from the spell check
- Click on the **Add** button to add the word to the user dictionary
- Click on the **Suggest** button to list alternative spellings or words
- Click on the **Cancel** button to abort the spell check entirely.

### 8.3.3 Select a Different Language

Enterprise Architect is supplied with two dictionaries, for US English and British English. Additional dictionaries are available as a set, for download from the registered area of the Sparx Systems website. Once you have downloaded and installed the language pack of dictionaries, you can select another language in which to perform the spell check.

To download the additional language dictionary pack:

1. Access [this registered user page](#) on the Sparx Systems web site.
2. At the end of the page, download the (*EADict.zip*) file from the Enterprise Architect Dictionary section.
3. Unzip the file into the Enterprise Architect install directory (*C:\Program Files\Sparx Systems\EA*).

This makes the non-English spelling dictionaries available to the Enterprise Architect spell checker.

To select another language for the spell checker in Enterprise Architect, follow the steps below:

1. Select the **Tools | Spelling Language** menu option. The **Spell Check Language** dialog displays.



2. Click on the radio button for the required language dictionary to use.
3. Click on the **OK** button. The selected language remains the current language until changed.

**Part**

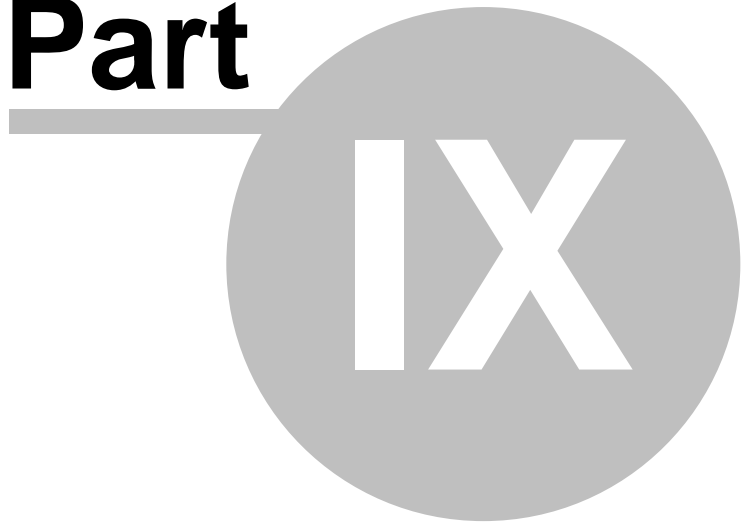

**IX**



## 9 Maintenance and Bug Tracking

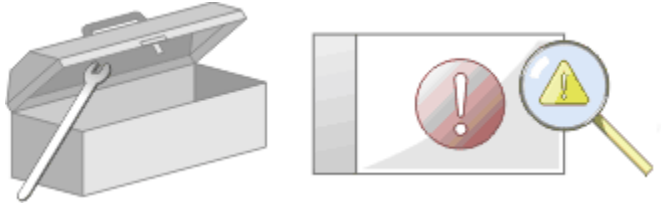

This section discusses the Enterprise Architect facilities for:

- Creating and monitoring [maintenance](#) items on project elements
- Creating and monitoring [change and issue](#) items on the project.

## 9.1 Maintenance



### Maintenance Items

*Maintenance* items are defects, changes, issues and tasks. They all apply to individual model elements and can be used to record and capture problems, changes, issues and tasks as they arise, and document the solution and associated details. They are defined as follows:

- A **defect** can be considered as a failure to meet a requirement for the current model element
- A **change** can be considered as a change in requirement for the current model element
- An **issue** records a risk factor that might affect the project being recorded for the current model element
- A **task** is a means of recording work in progress and work outstanding for the current model element.

Note that each of these maintenance items applies at the model element level. For *changes*, *defects* and *issues* that apply to the whole system, see the [Changes and Defects](#)<sup>[1563]</sup> topic; for *tasks* that apply to the whole system, see the [Project Tasks](#)<sup>[329]</sup> topic.

The following topics explain how to create and edit Maintenance items:

- [The Maintenance Workspace](#)<sup>[1558]</sup> - describes the **Maintenance** window
- [Maintenance Item Properties](#)<sup>[1559]</sup> - describes how to complete the **Maintenance** window tabs for the various maintenance items
- [Move or Copy Maintenance Items](#)<sup>[1561]</sup> - describes how to move items between maintenance categories or generate items from an item in a different category
- [Create Elements From Maintenance Items](#)<sup>[1561]</sup> - describes how to generate elements from maintenance items
- [Show Maintenance Script in Diagram](#)<sup>[1561]</sup> - describes how to display maintenance items in elements on diagrams
- [Insert Maintenance Feature](#)<sup>[594]</sup> - describes how to add a maintenance item directly to an element via in-place editing.

### 9.1.1 The Maintenance Workspace

Enterprise Architect makes it easy to record and capture problems and issues as they arise, and document the solution and associated details. The **Maintenance** window provides a quick method of viewing and modifying the [changes, issues defects and 'to do' items](#)<sup>[1558]</sup> associated with a particular model element. You can include the maintenance items in the main RTF documentation and HTML produced by Enterprise Architect. The **RTF Setup** dialog has checkboxes to show or hide element maintenance items.

You access the **Maintenance** window by selecting the **View | Other Element Tools | Maintenance** menu option, or by pressing **[Alt]+[4]**. Click on the required tab - **Defects**, **Changes**, **Issues** or **Tasks** - and select model elements in diagrams or in the **Project Browser** to see the associated maintenance items.

You can also use the [Element Browser](#)<sup>[510]</sup> window to select and display specific items on the **Maintenance** window. Click on the  icon in the **Maintenance** window toolbar to display the **Element Browser**, open the **Maintenance** folder and select the required item. In the folder, the 'page' icon contains a **C** for Change items, **D** for Defect items, **T** for Task items, or **I** for Issue items.

The window has two formats, as illustrated below - *Item* mode and *List* mode respectively.

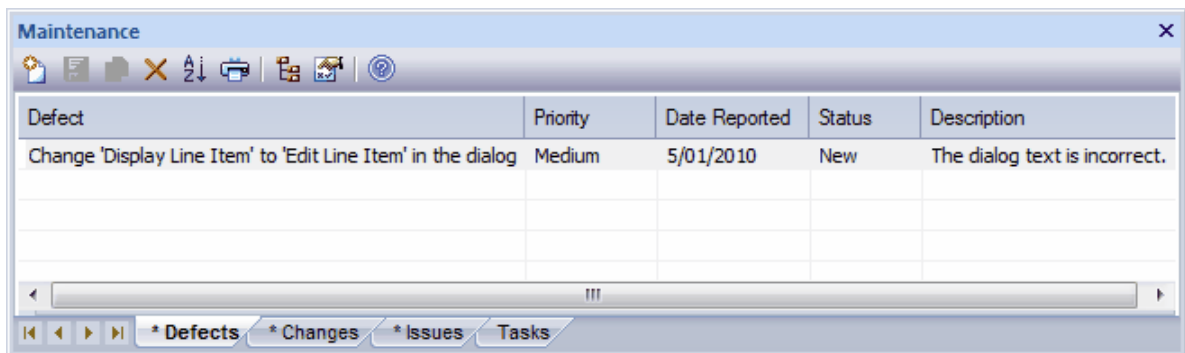
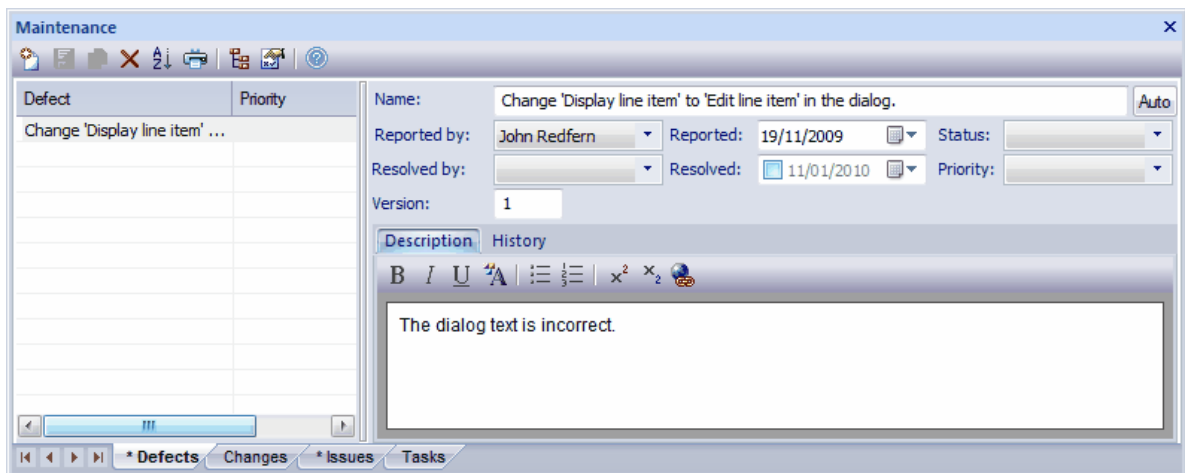

To toggle between the modes, click on the **Show/Hide Properties** button in the window toolbar. Item mode displays a single item with others of the same type listed in the left-hand panel. You can also either switch to List mode or select another item from the **Element Browser** window. List mode displays all items of one type in the selected element; it does not, however, display as much detail on an item as Item mode does.

Using the toolbar, you can [add or delete](#) items and show or hide the **Properties** window to enable you to [edit](#) each item in the list. Click on the **New** icon in the window toolbar to add new items. In Item mode, this clears the fields for new data. In List mode, this displays the **<item type> details for <element type> <element name>** dialog. By clicking on the **Auto** button in Item mode or on the **details** dialog, you can apply an automatic naming/numbering nomenclature that you have [previously defined](#).

An asterisk on a tab (as for the **Defects** tab, above) indicates that the tab contains saved information. If the tab has no information or the information has not yet been saved, there is no asterisk, as shown for the **Tasks** tab.

You can also display the maintenance items in a [compartment](#) of each appropriate element in a diagram.

## 9.1.2 Maintenance Item Properties

### Note:

For information on element-level Defects, Issues, Changes and Tasks, see the [Maintenance](#) topic. For information on the **Maintenance** window, see the [Maintenance Workspace](#) topic.

To create, edit or delete maintenance items, follow the steps below:

1. Select the **View | Other Element Tools | Maintenance** menu option. The **Maintenance** window displays.

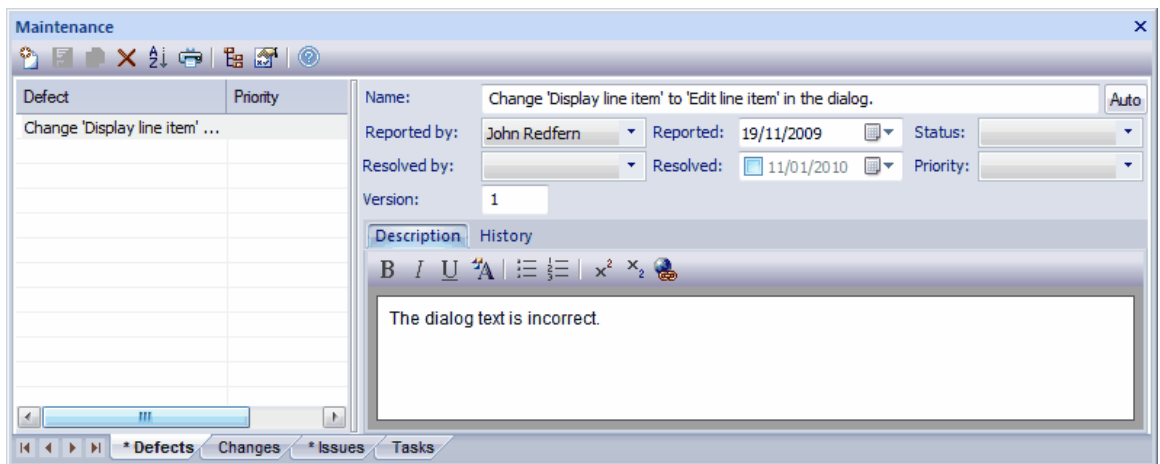

2. Open a diagram or the **Project Browser** and select an element. In Item mode, the oldest maintenance item of each type for that element is shown in the **Maintenance** window, on the appropriate tab. The other items are listed either in the left hand panel or in List mode.
3. Click on the **Browse Element** icon in the window toolbar. The **Element Browser** window displays.
4. To:
  - Add a new item, select the appropriate tab, click on the **New** icon in the **Maintenance** window toolbar and complete the fields as described in the table below
  - Modify an existing item, select the item from the left-hand list panel or from the **Maintenance** folder of the **Element Browser** window and edit the fields as described in the table below
  - Delete an existing item, select the item from the left-hand list panel or the **Maintenance** folder of the **Element Browser** window and click on the **Delete** icon in the **Maintenance** window toolbar.
5. Click on the **Save** button in the window toolbar.

Complete or edit the following fields on the **Maintenance** window

**Note:**

This table describes the fields of the **Defects** tab of the **Maintenance** window. The **Changes**, **Issues** and **Tasks** tabs differ only in minor details.

Option	Use to
<b>Name</b>	Type the name or a short description of the defect.
<b>Reported by</b>	Select the name of the person who reported the defect.
<b>Reported</b>	Select the date on which the defect was reported.
<b>Status</b>	Select the defect status, such as <b>New</b> or <b>Complete</b> .
<b>Resolved by</b>	Select the name of the person who fixed the defect.
<b>Resolved</b>	Select the date on which the defect was resolved.
<b>Priority</b>	Select the priority assigned to resolving the defect.
<b>Version</b>	Type the version number associated with this fix.
<b>Description</b>	Type a longer description of the defect. You can format the text using the <a href="#">Notes</a> <sup>642</sup> toolbar at the top of the field. This text is also reflected in the <b>Notes</b> window, but cannot be edited there.
<b>History</b>	Enter any notes or references to previous occurrences of this defect. You can format the text using the <a href="#">Notes</a> <sup>642</sup> toolbar at the top of the field. This text is also reflected in the <b>Notes</b> window, but cannot be edited there.

### 9.1.3 Move or Copy Maintenance Items

When you define an item on the **Defects**, **Changes**, **Issues** or **Tasks** tab of the **Maintenance** window, you might decide that the item either is better suited to another Maintenance category, or forms a good template for items in other categories. Enterprise Architect enables you to move or copy items between categories.

To move or copy a maintenance item, follow the steps below:

1. [Open the Maintenance window](#) <sup>[1558]</sup> and select the tab that contains the item you want to move or copy.
2. Right-click on the required maintenance item. The item context menu displays.
3. Click on the appropriate option - **Move to** or **Copy to**. A list of maintenance categories displays.
4. Click on the category to which to move or copy the item. A confirmatory prompt displays.
5. Click on the **Yes** button to confirm the move or copy.
6. Click on the target tab to ensure that the item has been added, and [make any required changes](#) <sup>[1559]</sup>.

### 9.1.4 Create Elements From Maintenance Item

A maintenance item identifies a defect, change, issue or task concerning an element. The maintenance item could itself be represented by an element if it has wider implications for the project or identifies - for example - an actor, activity or action that requires further definition.

You can create one or more elements from any maintenance item, using the **Maintenance** window. The new element is connected to the maintenance item's parent element by a Dependency connector. The item itself remains unchanged as a characteristic of its parent element.

To create an element from a maintenance item, follow the steps below:

1. [Open the Maintenance window](#) <sup>[1558]</sup> and select the tab that contains the item you want to create the element from.
2. Right-click on the required maintenance item. The item context menu displays. select the **Create as new Element** context menu option. The [New Element](#) <sup>[524]</sup> dialog displays.
3. In the **Name** field, type a name for the new element.
4. In the **Type** field, click on the drop-down arrow and select the required element type. For example, you might create an Issue element for a Defect or Issue maintenance item, a Change element for a Change item, or an Action for a Task item.

You can, however, create a wide range of other element types should any of these be appropriate, and use the **Select Group** button to select a profile, MDG Technology or Add-In to create an element specific to that element group.

5. If necessary, in the **Stereotype** field click on the drop-down arrow and select a stereotype to apply to the new element.
6. If you want to immediately define the properties of the element, select the **Open Properties Dialog on Creation** checkbox.
7. If you are adding multiple elements in one session, deselect the **Close dialog on OK** checkbox.
8. If you want to add the element to the currently-open diagram, select the **Add to Current Diagram** checkbox.
9. Click on the **OK** button to create the element.

The element is added to the **Project Browser** and - if requested - to the current diagram.

### 9.1.5 Show Maintenance Script in Diagram

Any element that is capable of displaying a compartment can show [maintenance scripts](#) <sup>[1558]</sup> in a diagram. To make use of the feature the element must have an attached maintenance item.

To use this feature follow the steps below:

1. Open a diagram containing the element with the attached maintenance items.
2. Double-click on the diagram background to display the **Diagram Properties** dialog. Click on the **Elements** tab.

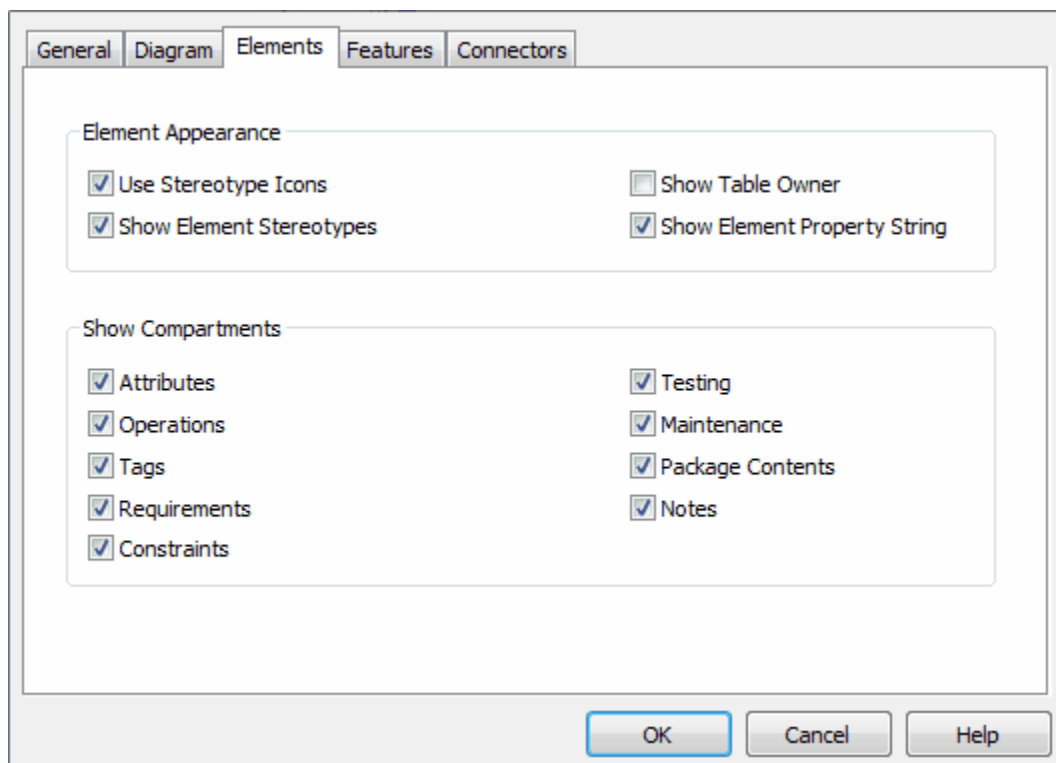

3. In the **Show Compartments** panel, select the **Maintenance** checkbox.
4. Click on the **OK** button to save the setting.

The maintenance Items now appear as items in the maintenance scripts compartment of the diagram element.

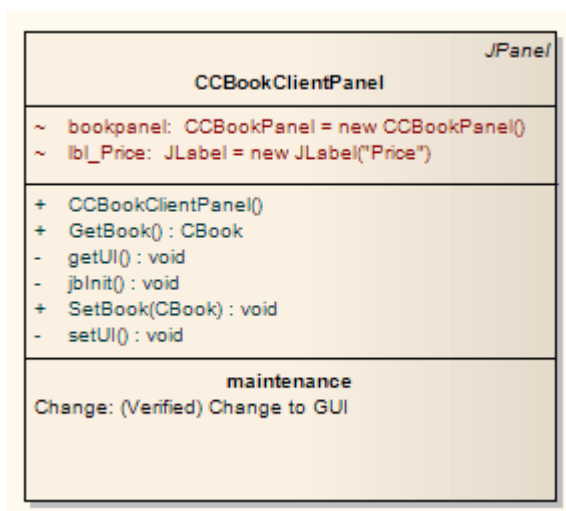

## 9.2 Changes and Defects



### Change and Defect Elements

[Changes](#)<sup>[1564]</sup> and [Defects](#)<sup>[1563]</sup> are structured comments that can be used in managing change in a project. A *Defect* element (also known as an *Issue* element) corresponds to a failure to match the requirements for the current system. A *Change* element corresponds to a change in requirements for the current system.

### Using Structured Comments

You can track changes and defects (issues) in an Enterprise Architect model. Change and Defect elements can be created in UML diagrams and connected using Realization, Dependency, Aggregation and other relationships to show what model element each affects and how each is resolved. You can edit the element [properties](#)<sup>[1565]</sup>, and [assign people](#)<sup>[1566]</sup> (as *Actor* elements) to changes and defects.

#### 9.2.1 Defects (Issues)

A *Defect* (or *Issue*) element is a structured comment that contains information about defects and issues that relate to the system or model. This corresponds in some sense to a failure to meet defined requirements for the current system. An Issue element looks the same as a Requirement element:

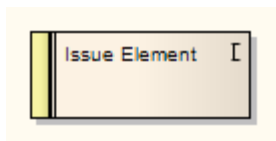

Enterprise Architect enables you to generate and handle issues in much the same way as you can handle and [color code](#)<sup>[920]</sup> Requirements. For more information, see the [Requirements](#)<sup>[917]</sup> topic.

You can link Issues using *Realize* connectors to model elements that are responsible for the defect. You can even structure a hierarchy of Issues using aggregation.

#### Note:

Issue elements can be created with or without an identifying I in the top right corner of the element. To toggle the display of this letter, select or deselect the **Show stereotype icon for requirements** checkbox on the [Options](#) dialog, [Objects](#)<sup>[362]</sup> page.

### Add an Issue Using the Toolbox

To add an Issue to the model using the **Toolbox**:

1. Open a *Custom* diagram.
2. From the [Custom](#)<sup>[417]</sup> pages or [Common](#)<sup>[405]</sup> page of the **Toolbox**, drag the *Issue* icon onto the diagram.
3. Enter the details as required.

### Add an Issue Using the Insert New Element Dialog

To add an Issue to the model using the **Insert New Element** dialog, follow the steps below:

1. Right-click on a package in the **Project Browser**.
2. Select the **Insert | New Element** context menu option. The **New Element** dialog displays.

The screenshot shows a dialog box for creating a new element. It contains the following fields and controls:

- Name:** A text input field with an 'Auto' button to its right.
- Type:** A dropdown menu currently showing 'Action', with a 'Select Group' button to its right.
- Stereotype:** A dropdown menu.
- Open Properties Dialog on Creation
- Close dialog on OK
- Add to Current Diagram
- Buttons at the bottom: 'Create' (highlighted in blue), 'Cancel', and 'Help'.

3. In the **Type** field, click on the drop-down arrow and select **Issue**.
4. In the **Name** field, type a name for the element.
5. Click on the **OK** button.

## 9.2.2 Changes

A *Change* element is a structured comment that contains information about requested changes to the system/model. This corresponds in some sense to a change in requirements for the current system. A Change element looks the same as a Requirement element:

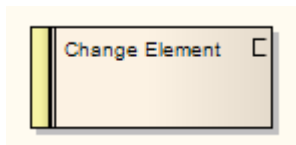

Enterprise Architect enables you to generate and handle Changes in much the same way as you can handle and [color code](#) Requirements. For more information, see the [Requirements](#) topic.

You can connect *Changes* using *Realization* connectors to model elements that implement the Change, and you can structure a hierarchy of changes using Aggregation.

### Note:

Change elements can be created with or without an identifying **C** in the top right corner of the element. To toggle the display of this letter, select or deselect the **Show stereotype icon for requirements** checkbox on the [Options](#) dialog, [Objects](#) page.

### Add a Change Using the Toolbox

To add a Change to the model using the **Toolbox**:

1. Open a *Custom* diagram.
2. From the [Custom](#) pages or [Common](#) page of the **Toolbox**, drag the *Change* icon onto the diagram.
3. Enter the details as required.

### Add a Change Using the Insert New Element Dialog

To add a Change to the model using the **Insert New Element** dialog, follow the steps below:

1. Right-click on a package in the **Project Browser**.
2. Select the **Insert | New Element** context menu option. The **New Element** dialog displays.



The dialog box has the following fields and options:

- Name: [ ] [Auto]
- Type: [Action] [Select Group]
- Stereotype: [ ]
- Open Properties Dialog on Creation
- Close dialog on OK
- Add to Current Diagram
- [Create] [Cancel] [Help]

3. In the **Type** field, click on the drop-down arrow and select **Change**.
4. In the **Name** field, type a name for the element.
5. Click on the **OK** button.

### 9.2.3 Element Properties

The **Properties** dialog for Changes and Issues is similar to that used by Requirements. It has a **Properties** tab containing the name of the Issue and relevant management details (such as owner and dates). You can also [associate files](#)<sup>[507]</sup> with the issue and [add Tagged Values](#)<sup>[634]</sup>.

The dialog box has the following fields and options:

- Properties | Files | Tagged Values
- Short Description: [Incompatibility]
- Alias: [ ]
- Status: [Proposed] Type: [Functional]
- Difficulty: [Medium] Phase: [1.0]
- Priority: [Medium] Version: [1.0]
- Author: [Frederick Walter] Last Update: [19/11/2009]
- Key Words: [ ] Created: [19/11/2009]
- Notes: [Rich text editor with toolbar]
- [OK] [Cancel] [Help]

### 9.2.4 Assign People to Defects or Changes

As an example of how you might use the **Relationship Matrix** to monitor issues or changes, the screen below illustrates staff (actors) being linked through *Realization* connectors to *Issues*. Each highlighted square indicates a responsibility of a staff member to work on or correct a named issue. This same approach can be used for any mix of model elements.

Source: Resources		Type: <All>	Link Type: Realisation							
Target: UC01-1: User Management		Type: <All>	Direction: Source -> Target							
	UC01-1: User Management::Collaborations	UC01-1: User Management::Customer	UC01-1: User Management::Data Entry	UC01-1: User Management::Incompatibility	UC01-1: User Management::Incompatibility	UC01-1: User Management::Login Screen	UC01-1: User Management::Registration	UC01-1: User Management::Security	UC01-1: User Management::UpdateVersions	UC01-1: User Management::Workbench
Resources::Andrew Sutton									↑	
Resources::Claire Owens	↑				↑					

**Part**

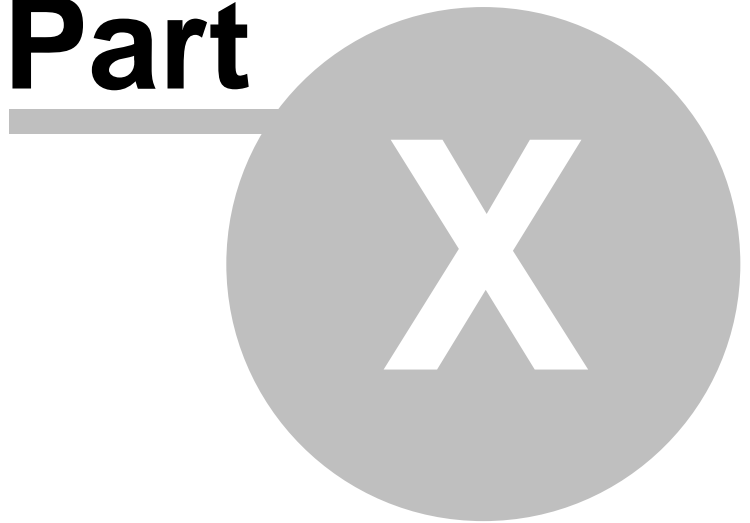

## 10 Report Generation

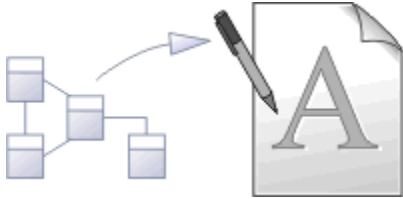

Model documentation is essential to realizing the full benefit of Enterprise Architect. Enterprise Architect provides a powerful mechanism for generating high quality, customized documentation directly from your model, in either RTF or HTML format.

There are many ways to specify the Enterprise Architect content being documented. You can:

- Document a package and/or its child packages by manually highlighting the package and selecting a documentation control
- Specify embedded packages for [exclusion](#) <sup>[1573]</sup> if child packages are recursively documented
- Link a package to an RTF document template to simplify generating consistent types of documentation (eg Use Case Reports) using the [Documents feature](#) <sup>[1636]</sup>
- Select, group and order packages together in a *different manner* from the **Project Browser** by creating ' [Virtual Documents](#) <sup>[1616]</sup>, either linked through a master document with headers, footers and contents list, or as separate individual documents.

### RTF Documentation

Rich text reports are documents produced by Enterprise Architect in Rich Text Format (RTF). RTF formatting can be modified directly with RTF Style templates to alter the look and feel of generated output. Using MS Word you can further enhance the separate RTF documents output from the model by connecting and interweaving them into a linked [master document](#) <sup>[1638]</sup> with headers, footers and contents list.

Enterprise Architect has a fully-featured RTF Document Generator that features:

- Powerful WYSIWYG RTF style template editor support
- An easy-to-use document generator
- An embedded RTF viewer that enables you to view RTF documents generated by Enterprise Architect within Enterprise Architect.

For further information, see:

- [RTF Documents](#) <sup>[1569]</sup>
- [Use MS Word.](#) <sup>[1638]</sup>

### RTF Reports

You can also generate a number of RTF reports on different aspects of your model. See the [Other Documents](#) <sup>[1624]</sup> topic.

### HTML Documentation

Enterprise Architect provides automated web-based publishing of models, making it simple to explore large models efficiently on-line. Enterprise Architect enables the export of an entire model or a single branch of the model to HTML Web pages. You can also create web style templates to customize the HTML output.

For further information, see the [HTML Reports](#) <sup>[1647]</sup> topic.

## 10.1 RTF Documents



### Rich Text Format Documentation

Rich text reports are documents produced by Enterprise Architect in Rich Text Format (RTF), a format common to many word processors.

RTF is particularly targeted at Microsoft Word™, which enables you to link a number of rich text documents into a single [master document](#)<sup>[1638]</sup>.

Typically you create a Word master document, then some Enterprise Architect RTF reports. You link the reports back into sub-sections of the master document, and refresh them as required during project development. In this way the project document becomes an easily-managed and feature-rich work product.

You can also populate a Word document from specific *sections* of reports, based on [bookmarks](#)<sup>[1639]</sup>. For example, a Word document might have a section for a small part of your component model. Using bookmarks you can generate a full component model, and then link into just one section of the report. This way you can maintain a complex Word document from parts of Enterprise Architect reports. The RTF Generator performs one pass for one template, but using a Word master document and Enterprise Architect bookmarks enables you to incorporate material from several RTF documents with different formats based on different templates.

By adding tables of contents, figure tables, sections, and headers and footers, you can manage a complex document with relative ease. Simply update the Enterprise Architect RTF reports then refresh the links in MS Word.

You can also maintain complex documents by creating [virtual documents](#)<sup>[1616]</sup> in Enterprise Architect, setting up a *Master Document* (package) element and/or *Model Document* elements (*Class* elements of stereotype *Model Document*) and linking packages into the document, in whatever order or combination is most appropriate to your requirements. You can select packages from different areas of the model, arrange them in any order, and edit or delete the packages. The virtual document automatically incorporates the changes each time you generate it.

You can have several RTF reports open at the same time, as separate [tabs](#)<sup>[397]</sup> in the central view area of the Enterprise Architect work area. You can also close the reports individually or all together, leaving views of other types (such as diagrams or code editors) still open.

#### Note:

In the Corporate, Business and Software Engineering, System Engineering and Ultimate editions of Enterprise Architect, if security is enabled you must have [Generate Documents](#)<sup>[198]</sup> permission to generate RTF documents.

### The RTF Generator

Enterprise Architect has an enhanced RTF Document Generator that features:

- Powerful WYSIWYG RTF style template editor support, enabling:
  - Headers and Footers
  - Images
  - Indexes
  - Tabular Sections
  - Nested Sections
  - All model elements, connectors, diagrams and their properties
  - Template import and export using XML
  - Basic templates supplied for customization.
- A document generator that:
  - Provides simplified options

- Generates complex documents based on RTF templates.
- An embedded RTF viewer that you use to view RTF documents generated in Enterprise Architect directly within Enterprise Architect.

## More Information

A tutorial on using the RTF Generator and creating RTF documentation is provided on the Sparx Systems website. Click on the following link:

<http://www.sparxsystems.com/resources/whitepapers/>

For more information, see:

- [Generate RTF Documents](#) <sup>[1570]</sup>
- [Generate RTF Documentation Dialog](#) <sup>[1573]</sup>
- [RTF Document Options](#) <sup>[1607]</sup>
- [RTF Templates Tab](#) <sup>[1576]</sup>
- [Custom Language Settings](#) <sup>[1637]</sup>
- [Include or Exclude a Package from Report](#) <sup>[1573]</sup>

### 10.1.1 Generate RTF Documents

Creating a Rich Text Format (RTF) document is a simple and flexible process. An RTF document is based on a package or an element in your project (more usually a package). To produce a document, you must select the package or element to report on in the **Project Browser**, **Element List** or **Model Search**.

#### Tip:

Reports can be configured to include all packages within a parent package, or just the top level.

You should also set the [diagram properties](#) <sup>[1571]</sup> to determine how the diagrams in the package are set out in the RTF document. When you have prepared and selected your package, use the context menu to open the **Generate RTF Documentation** dialog and configure the details of your document. The next topic guides you through creating a rich text report.

## Open the Generate RTF Documentation Dialog

Use one of the following methods:

- Select the **Project | Documentation | Rich Text Format (RTF) Report** menu option
- In the **Project Browser**, right-click on the required package and, on the context menu, select the **Documentation | Rich Text Format (RTF) Report** menu option
- In the **Project Browser** or a diagram, click on the required package or element and press **[F8]**
- In a diagram, click on a specific element and select the **Element | Rich Text Format (RTF) Report** menu option
- In the **Element List** or **Model Search**, select one or more items, right-click and, from the context menu, select either the **RTF Report | Generate report for each selected object** option or the **RTF Report | Generate one report for all selected** option.

See the [Generate RTF Documentation Dialog](#) <sup>[1573]</sup> topic for more information.

## Quick Start

To generate and view an example RTF report right now, follow the steps below:

1. Open the *EAExample* project.
2. Open the *QA Model* package and right-click on the *Testing* package.
3. Select the **Documentation | Rich Text Format (RTF) Report** context menu option. The **Generate RTF Documentation** dialog displays.
4. In the **Output to file** field, select a convenient file location in which to hold the generated report.
5. In the **Use Template** field, click on the drop-down arrow and select **(basic template)**.
6. Click on the **Generate** button.
7. When the report has been generated, click on the **View** button.

## Generate RTF Report From Element List or Model Search

When you select to create an RTF Report from the [Element List](#)<sup>[1255]</sup> or [Model Search](#)<sup>[1237]</sup> tools, you can generate an element-level report rather than a package-level report, and you have additional flexibility in selecting:

- The type of element to report on
- The specific elements to report on, together or separately, whether in the same package or not.

For example, you might want to find all elements with test cases, with the intention of reporting on some or possibly all such elements. With the [Element List](#), you would identify these elements yourself within the list of all elements in a selected package, but with the [Model Search](#) you could specifically identify the elements across a section of the model or across the whole model, as required. The search filtering could be for specific test cases; however, the results are by element so if there are test cases outside the range in any element that has a filtered test, these elements are listed as well.

Having generated the list of elements, you can select individual elements, blocks of elements, or all elements, and then (as above) use the context menu to generate a report on all of the elements, or separate reports on each element.

### 10.1.1.1 Diagram Options

This topic refers to options on the [Diagram](#) page of the [Diagram Properties](#) dialog, used when generating RTF reports for a particular diagram (using either the [extended](#)<sup>[1573]</sup> or [Legacy](#)<sup>[1628]</sup> RTF Report Generator). Display the dialog page by double-clicking on the diagram background, and select the [Diagram](#) tab.

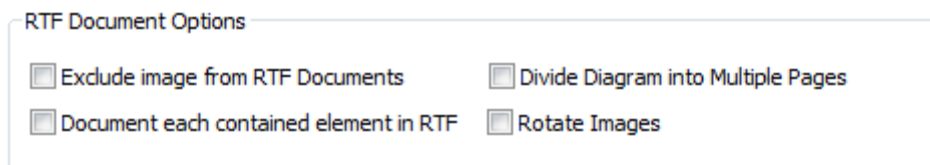

### Exclude Image from RTF Documents

Select this checkbox to exclude the image of the current diagram from any RTF reports.

### Document Each Contained Element in RTF

Select this checkbox to ensure the RTF report generator includes details of elements that belong in other - external - packages but that are linked into *this* diagram within the package being reported on. The report includes external elements for each diagram on which you have selected the checkbox.

On the [Generate RTF Documentation](#)<sup>[1573]</sup> dialog, the **Include all Diagram Elements in Report** checkbox defaults to selected, to include external elements for *every* diagram covered by the report. Therefore, to include external elements only for selected diagrams, deselect this checkbox.

In either case, you must enable the *Package.Diagram.Element* or *Package.Element* section in your (customized) document generation templates in order to include this external element information in the report. To enable the template section:

1. Select the **Project | Documentation | Rich Text Format (RTF) Report** menu option.
2. Select the appropriate customized template (not a system-provided one) in the **Use Template** field.
3. Click on the **Edit Template** button to display the [RTF Template Editor](#).
4. In the [Sections](#) panel on the left-hand side of the editor window, select the **Package::Diagram::Element** checkboxes.

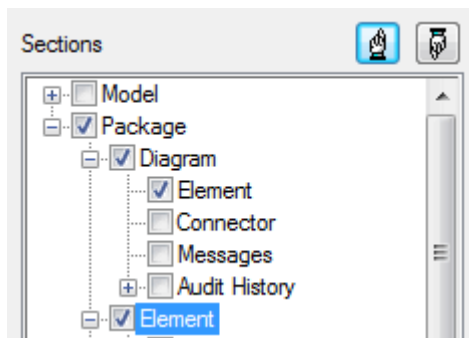

#### Notes:

- If using the Legacy RTF generator, the *Element* checkbox is automatically checked in your customized template, when you select the **Document each contained element in RTF** checkbox.
- **Package::Diagram::Element**, if left blank, replicates the format of **Package::Element** including sub-element sections (for example, **Package::Element::Scenario**). **Package::Diagram::Element** does not have an option to add these sections.

Selecting the checkboxes adds the following set of sections to your report template:

```

package->|
[right-click-to-insert-Package-field(s)]|
diagram->|
[right-click-to-insert-Diagram-field(s)]|
element->|
[right-click-to-insert-Element-field(s)]|
<-element|
<-diagram|
<-package|

```

To report on the linked elements in:

- the same style as defined in the **Package::Elements** section, delete the *[right-click-to-insert-Element-field(s)]* text to leave a blank area
- a different style to the elements within the selected package, set up the style as appropriate.

### Divide Diagram Into Multiple Pages

Select this checkbox to divide each large diagram into separate pages in the RTF document.

#### Note:

This option is only effective when the **Scaled Printing** <sup>4561</sup> option is set to **None** on the **Print Advanced** dialog.

### Rotate Images

Select this checkbox to rotate each diagram image by 90 degrees in the RTF document.

#### Note:

Only valid for bitmap (.bmp) images.



### 10.1.1.2 Exclude Package from Report

You can exclude a particular package from any RTF reports by marking it for exclusion.

#### Notes:

- By default, packages are included in any RTF reports.
- When you exclude a package from RTF reports, all of the selected package's subpackages are also excluded.

### To Mark a Package for Exclusion

1. In the **Project Browser**, right-click on the required package. The context menu displays.
2. Select the **Documentation | RTF Report Options** menu option. The **RTF Generation Options** dialog displays.

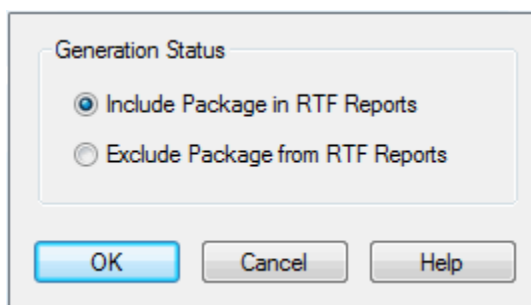

3. Select the **Exclude Package from RTF Reports** radio button.
4. Click on the **OK** button to save changes.

### 10.1.1.3 Generate RTF Documentation Dialog

#### Note:

For an introduction to generating RTF documentation, see [RTF Documents](#)<sup>[1569]</sup>.

The **Generate RTF Documentation** dialog enables you to set the exact contents and look and feel of your report.

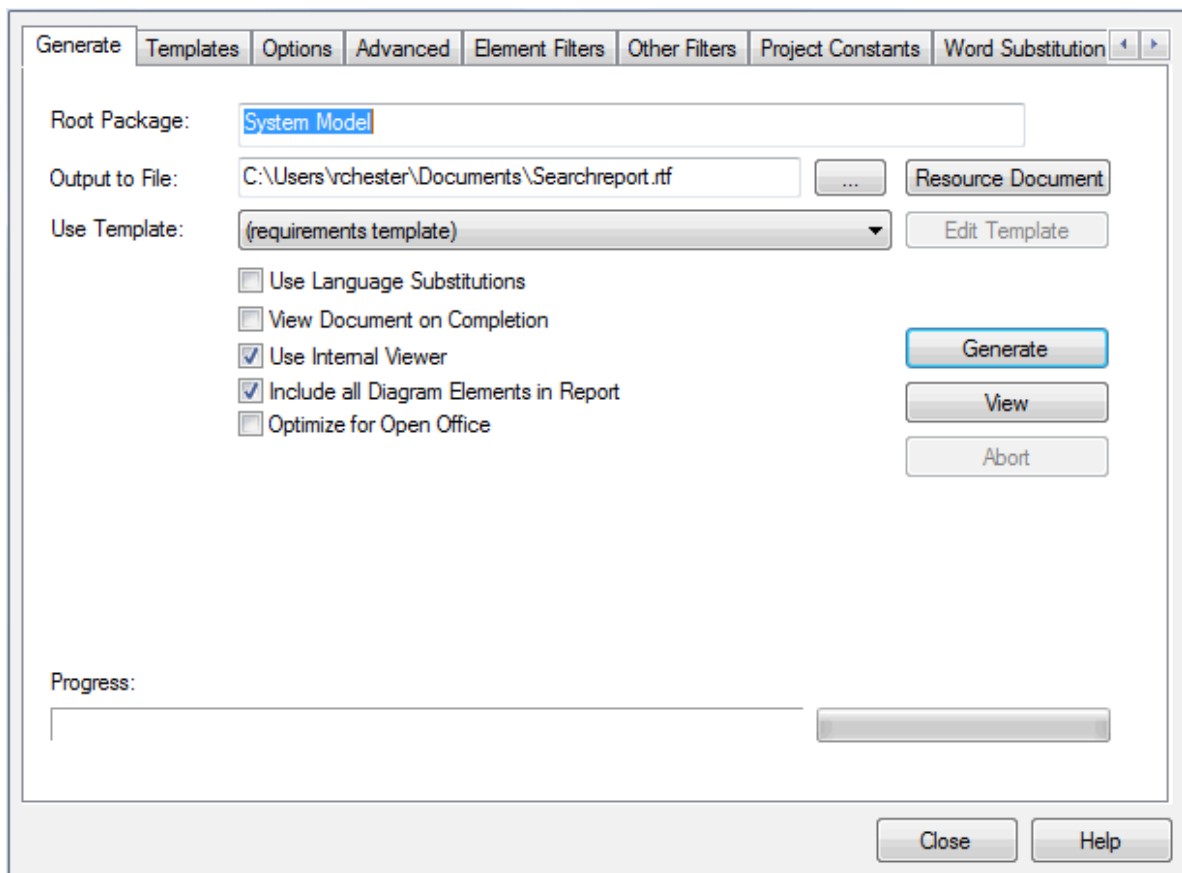

Each tab of the dialog offers a number of RTF document generation options, as described in the following sections:

- **Generate** Tab (see below)
- [RTF Templates](#) <sup>[1576]</sup>
- [Document Options](#) <sup>[1607]</sup>
- [Advanced Options](#) <sup>[1609]</sup>
- [Element Filters](#) <sup>[1611]</sup>
- [Other Filters](#) <sup>[1612]</sup>
- [Project Constants](#) <sup>[1614]</sup>
- [Word Substitution](#) <sup>[1615]</sup>
- [Language Substitution \(Codepage\)](#) <sup>[1615]</sup>

When you have worked through these tabs and set the options you require, return to the **Generate** tab and click on the **Generate** button to produce your report.

#### Note:

If you have never selected the **Optimize for Open Office** checkbox, the document generator prompts you to confirm which document style you want to adopt - Microsoft Office or Sun Open Office. Once you have made a selection in this prompt, the document generator always acts on the status of the checkbox and does not display the prompt again.

## Generate Tab Options

The **Generate** tab of the dialog has the following fields:

Option	Use to
<b>Model Document</b>	Confirm the name of the element selected from the <b>Project Browser</b> , <b>Element List</b>

Option	Use to
<b>Root Element Root Package</b>	<p>or <b>Model Search</b>.</p> <p>If this is the specially-created model document element for a <a href="#">Virtual Document</a> <sup>[1616]</sup>, the field is <b>Model Document</b>.</p> <p>Otherwise, this field identifies the selected element of the hierarchy to be reported on; that is, the <b>Root Element</b> or <b>Root Package</b>.</p>
<b>Output to File</b>	<p>Type or select the location and filename for the generated documentation. The [ ... ] (Browse) button enables you to navigate to the location.</p>
<b>Use Template</b>	<p>Type or select the name of the RTF template to apply to document generation. You can select either a standard template (enclosed in parentheses) or a user-generated template.</p> <p>The standard templates include the following:</p> <ul style="list-style-type: none"> <li>(basic template + audit)</li> <li>(basic template)</li> <li>(data model template)</li> <li>(diagrams template)</li> <li>(effort, metrics &amp; risk template)</li> <li>(interaction messages template)</li> <li>(maintenance template)</li> <li>(model document: basic template)</li> <li>(model document: data model template)</li> <li>(model document: master template)</li> <li>(model glossary template)</li> <li>(project issues template)</li> <li>(requirements template)</li> <li>(resource allocation template)</li> <li>(testing template)</li> <li>(use case scenario template)</li> <li>(use case template)</li> </ul>
<b>Use Language Substitutions</b>	<p>Switch custom language <a href="#">word substitutions</a> <sup>[1615]</sup> on.</p> <p>Deselect to switch custom language word substitutions off.</p>
<b>View Document On Completion</b>	<p>Open the document as soon as it has been generated.</p>
<b>Use Internal Viewer</b>	<p>Enable the <b>View</b> button to launch the generated RTF Documentation in the Enterprise Architect internal viewer.</p> <p>Deselect to enable the <b>View</b> button to launch the generated RTF Documentation in the MS Windows default RTF file viewer.</p> <p><b>Note:</b></p> <p>If you use Open Office as your default document editor, you <b>must</b> select the <b>Overwrite Document Fields</b> checkbox in the <a href="#">document options</a> <sup>[1607]</sup> in order to show field value text. Open Office defaults to showing field codes only, and you cannot toggle to the field values.</p>
<b>Include all Diagram Elements in Report</b>	<p>Include elements in the report from external packages that are referenced from a diagram, for every diagram covered by the report. Defaults to selected. The <i>Package.Diagram.Element</i> or <i>Package.Element</i> checkbox must be selected in the current template.</p> <p>If external elements are to be included only for selected diagrams, deselect this checkbox and select the <b>Document each contained element in RTF</b> checkbox in the <a href="#">diagram properties</a> <sup>[1577]</sup> for each required report.</p> <p>When both options are deselected, or when neither of the <i>Package.Diagram.Element</i> or <i>Package.Element</i> checkboxes are selected in the template, only elements in the current package are documented.</p>

Option	Use to
<b>Optimize for Open Office</b>	<p>Generate reports where diagrams are adjusted for clean rendering in Sun Open Office. The option also overwrites the value fields defined in a document section with the actual value text. If you open a generated report in Word, you can format the text but you cannot display the original field code.</p> <p>If the checkbox is <i>deselected</i>, diagrams displayed in Open Office are less distinct. Value fields remain and are populated with the appropriate values; when you display a generated report in Word, you can right-click on the field and toggle between the value text and the field code.</p> <p><b>Note:</b></p> <p>If you use Open Office as your text editor, you <b>must</b> select this checkbox to show the field values. Open Office defaults to showing the field codes only, and you cannot toggle to the field values.</p>
<b>Generate</b>	Generate the document (after you have set all the options you require, on all tabs of the dialog).
<b>View</b>	Launch the generated RTF Documentation in the MS Windows default RTF file viewer, or in the Enterprise Architect internal viewer if you have selected the <b>Use Internal Viewer</b> checkbox.
<b>Edit Template</b>	<p>Edit the currently-named template using the <a href="#">RTF Style Template Editor</a> <sup>[1578]</sup>.</p> <p>You can only edit <i>user-defined</i> templates, not the standard templates provided with Enterprise Architect. Standard template names are enclosed in parentheses.</p>
<b>Resource Document</b>	Save the current options as a <a href="#">document definition</a> <sup>[1606]</sup> .
<b>Abort</b>	Cancel report generation.

#### 10.1.1.4 RTF Templates Tab

The **Templates** tab of the **Generate RTF Documentation** dialog enables you to create, edit and delete your own RTF style templates. You can also import RTF templates saved as XML files.

In versions of Enterprise Architect later than 7.1, a *Normal.rtf* template is provided as a *system* template, as an external file stored with the Enterprise Architect system directory (in *C:\Program Files\Sparx Systems\EA\DocTemplates*). This provides user-editable defaults of styles, numbering and other base formats. Any styles modified in the *Normal.rtf* file reflect in newly created templates. One useful style is the default list numbering, *MasterList*.

To edit the *Normal.rtf* template, use the [RTF Style Template Editor](#) <sup>[1578]</sup> to create a new template called, for example, *Normal*, and use the [File | Import](#) <sup>[1588]</sup> menu option to import the *Normal.rtf* file into the *Normal* template. Modify the *Normal* template as required, but ensure there is no text when you save it, just style definitions. [Export](#) <sup>[1588]</sup> the modified template back into the *Normal.rtf* file in the *RTFTemplates* folder.

A related feature in the **RTF Style Template Editor** is the [File | Update Styles](#) <sup>[1589]</sup> menu option. This enables you to update existing templates to reflect any changes to *Normal.rtf*.

#### Note:

- In the Corporate, Business and Software Engineering, System Engineering and Ultimate editions of Enterprise Architect, if security is switched on, you must have [Configure Resources](#) <sup>[198]</sup> access permission to create RTF templates.
- In the *Normal.rtf* template, you must not edit the *SSbookmark* style. This defines the section styles and must be preserved.

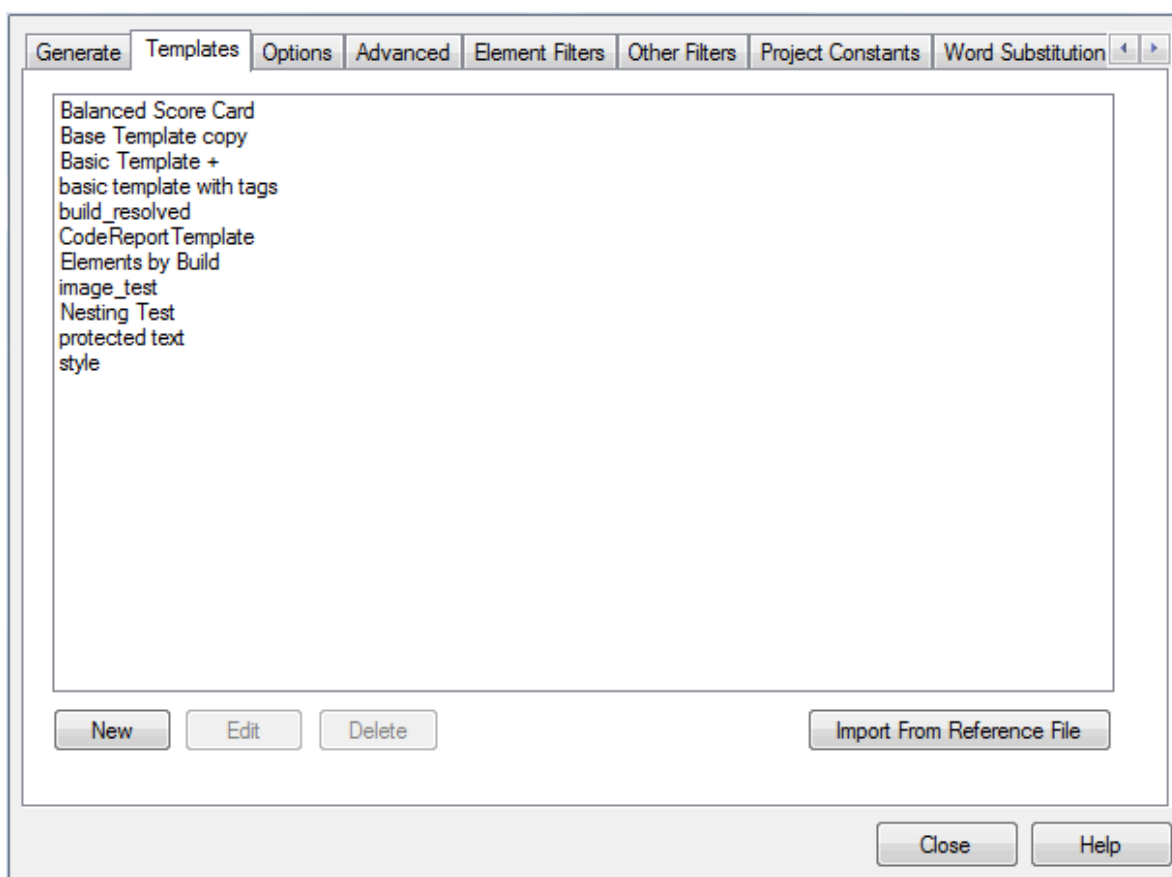

The tab has the following functions:

To	Do this...
Delete a template	Click on the template name and click on the <b>Delete</b> button.
Create a new template	Click on the <b>New</b> button. The <b>New Document Template</b> dialog displays, on which you specify the template name and the name of any existing template to act as the base for the new template.  To make it easier to get up and running, Enterprise Architect provides a basic template with default settings on which you can base new templates.  Modify the template as required, using the <b>RTF Style Template Editor</b> .
Open the <b>RTF Style Template Editor</b>	Click on the template name and click on the <b>Edit</b> button. The <b>Document Template Editor</b> screen displays, presenting the facilities of the <b>RTF Style Template Editor</b> .
Import RTF Templates saved to XML files using the <b>Tools   Export Reference Data</b> menu option	<ol style="list-style-type: none"> <li>1. Click on the <b>Import From Reference File</b> button.</li> <li>2. On the <b>Import Reference Data</b> dialog, click on the <b>Select File</b> button and browse for and select the required file.</li> <li>3. In the <b>Select Datasets to Import</b> panel, click on the required datasets.</li> <li>4. Click on the <b>Import</b> button to import the template.</li> </ol> <p>The imported template displays in the list on the <b>Templates</b> tab of the <b>Generate RTF Documentation</b> dialog.</p>

**Note:**

There are two methods of exporting and importing RTF templates out of and into models:

- If the template is in a batch file, export it using the **Tools | Export Reference Data** menu option and import it using the **Templates** tab, as above.
- If the template is a one-off copy, use the RTF Template Editor **File** <sup>[1587]</sup> menu options, **Export** and **Import**.

#### 10.1.1.4.1 RTF Style Template Editor

The **RTF Style Editor** enables you to create and edit custom RTF templates to define output RTF documentation associated with various sections of the *RTF Report* facility in Enterprise Architect. You typically use this facility to customize the look and feel of a report for your company or client. You access the **RTF Style Editor** by:

- Opening the **Resources** window (**View | Other Project Tools | Resources**), expanding the *Templates > Document Templates > System* or *Model* folders, and selecting to view or modify a template
- Selecting to edit the current template on the **Generate** tab of the **Generate RTF Documentation** dialog, or
- Selecting to edit a style template on the **Templates** tab of the **Generate RTF Documentation** dialog.

You **select particular model** <sup>[1579]</sup> components and specify, from the component type, the fields to include in the generated document. You can define formatting styles in the **RTF Style Template Editor**, and add a range of items such as tables of contents or headers to the document.

For information regarding specific commands to alter the format of the RTF documentation, see the entries under the **RTF Style Template Editor Options** <sup>[1587]</sup> topic.

**Note:**

You can transport these RTF templates between models, using the **Export Reference Data** <sup>[223]</sup> and **Import Reference Data** <sup>[223]</sup> options on the **Tools** menu.

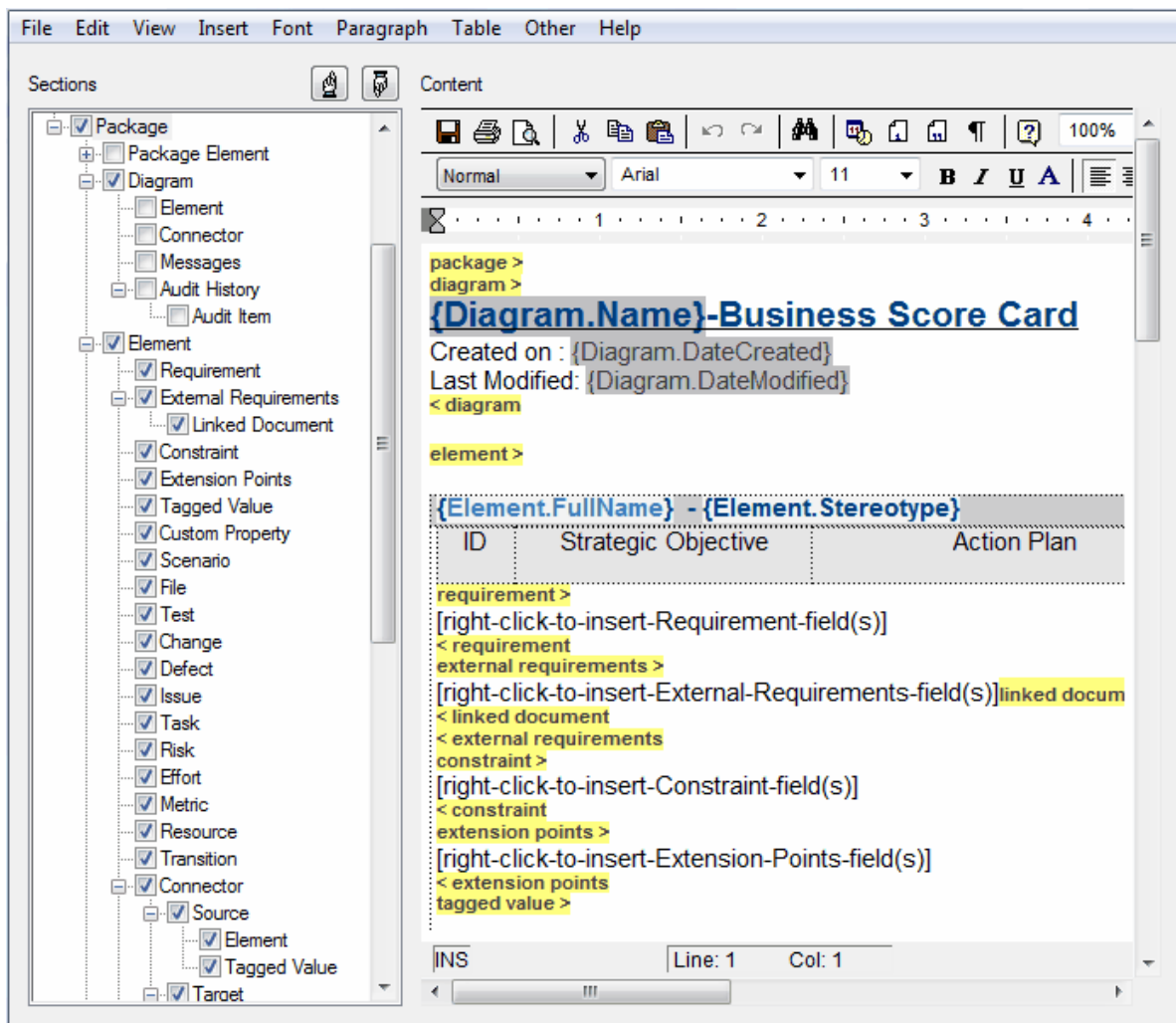



#### 10.1.1.4.2 Select Components for Reporting

To select model components to be documented in the report, using the **RTF Style Template Editor**:

1. Expand the **Sections** tree on the **<template name>** screen.
2. Select the checkbox next to the component name; the component name is then displayed as a section tag in the **Content** panel. Guidance in selecting some of the components is provided in:
  - [Linked Documents and Document Artifact Contents](#) <sup>[1580]</sup>
  - [Tabular Sections](#) <sup>[1581]</sup>
  - [Child Sections](#) <sup>[1584]</sup>
  - [Constraint and Scenario Sections](#) <sup>[1585]</sup>
3. [Add content](#) <sup>[1586]</sup> to each report component.

The position of the section tags within the **Sections** tree determines the position of the model component in the **Content** panel. For encapsulated components, selecting a child component automatically selects the parent also.

To move a model component to a different position in the documentation template:

1. Select the component in the **Sections** panel.
2. Click on  and  to move the component up and down the **Sections** panel.

For example, the section tag for **Package | Diagram | Element** is displayed in the **Sections** panel above the section tag for **Package | Diagram | Connector**.

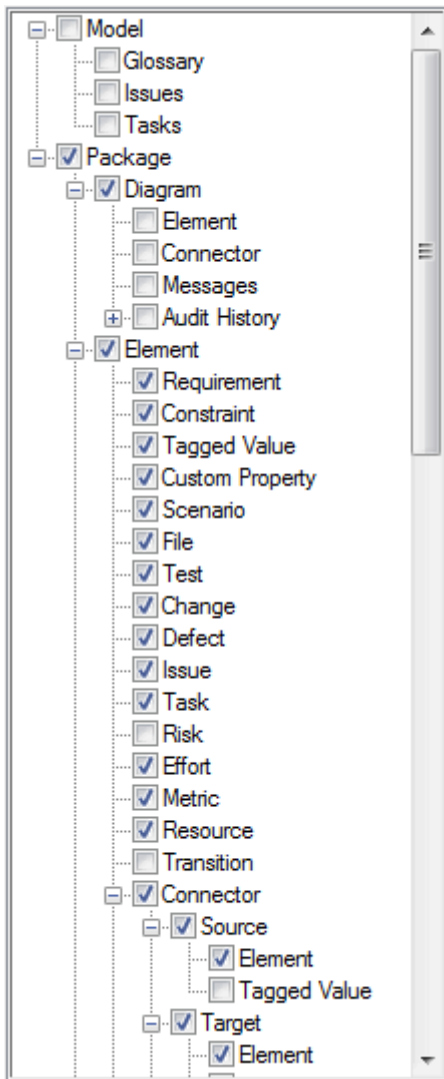
**Note:**

If the *Package.Diagram.Element* checkboxes are selected, you must select either the **Document each contained element in RTF** checkbox in the [Diagram Properties](#) <sup>[1574]</sup> dialog for at least one included diagram, or the **Include all diagram elements in report** checkbox on the [Generate RTF Documentation](#) <sup>[1573]</sup> dialog.

**Linked Documents and Document Artifact Contents**

[Linked documents](#) <sup>[597]</sup> and documents created via the [Document Artifact](#) <sup>[599]</sup> element are rendered into RTF Documentation by selecting the **Linked Document** checkbox in the [RTF Style Template Editor](#).



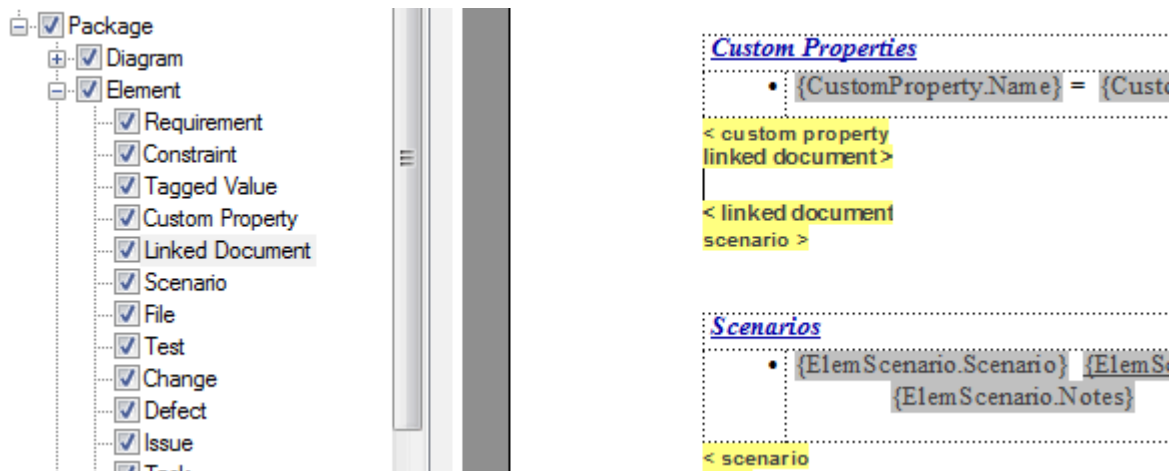

The **Linked Document** checkbox is within the **Element** hierarchy, towards the end. Remember that checkboxes can be moved up and down the hierarchy (as has been done above) to position information in the generated document as you require. In some templates, the **Linked Document** checkbox is only available as a child of the **External Requirements** checkbox.

The linked document is rendered into the RTF documentation at:

```
linked document >
```

```
<linked document
```

#### 10.1.1.4.3 Tabular Sections

The **RTF Style Template Editor** supports rendering a document section as a table. A tabular section is defined as a table containing any number of columns, but with only *two* rows:

- The first row is used to describe the headings of the columns, which you type in and format yourself
- The second row defines the output, which you specify by right-clicking in each cell and selecting the output type from the field list; the output is then generated iteratively for every occurrence of the section in question.

**Notes:**

- Under some circumstances, a table might repeat the header row rather than the output row; if this occurs, create another row in the table between the header row and the output row, and leave this blank.
- If you type a carriage return between the end of the table and the section terminator, the table you generate has a line space between the rows. For example:

```

package>@
@
@
element>@
*      ElementName*      Author*
*      {ElementName}*    {Element.Author}*
@
<@element@
<@package@

```

← Carriage Return

This generates the following table:

	Element Name	Author
	Choose Recipient	John Redfern

Line Space

	Manage Contacts	Walter Frederick
--	-----------------	------------------

To avoid this, ensure that there is no carriage return between the end of the table and the section terminator, as follows:

```

package>@
@
@
element>@
*      ElementName*      Author*
*      {ElementName}*    {Element.Author}*
<@element@
<@package@

```

← No Carriage Return

This generates a table with no space between the rows, as follows:

	Element Name	Author
	Choose Recipient	John Redfern
	Manage Contacts	Walter Frederick

**Example Tabular Section**

In the following example, the *Model> Glossary>* section is defined as a tabular section:

model &gt;

# Model Glossary

glossary &gt;

Term	Type	Meaning
{ModelGlossary.Term}	{ModelGlossary.Type}	{ModelGlossary.Meaning}

&lt; glossary

&lt; model

This renders the following document output:

## Model Glossary

Term	Type	Meaning
Accounting Periods	Business	A defined period of time whereby performance reports may be extracted. (normally 4 week periods).
Association	Technical	A relationship between two or more entities. Implies a connection of some type - for example one entity uses the services of another, or one entity is connected to another over a network link.
Class	Technical	A logical entity encapsulating data and behaviour. A class is a template for an object - the class is the design, the object the runtime instance.
Component Model	Technical	The component model provides a detailed view of the various hardware and software components that make up the proposed system. It shows both where these components reside and how they inter-relate with other components. Component requirements detail what responsibilities a component has to supply functionality or behavior within the system.
Customer	Business	A person or a company that requests an entity to transport goods on their behalf.
Deployment Architecture	Technical	A view of the proposed hardware that will make up the new system, together with the physical components that will execute on that hardware.

#### 10.1.1.4.4 Child Sections

Child sections can be rendered in RTF documentation using one of the following two methods:

- Render model components directly into the RTF as defined by the section's content and fields.
- Render indirectly to the RTF by using a parent section to describe the content.

The second option occurs as a result of creating a section that has a placeholder section tag (that is, no content within the tags). This method is used to create recursive documentation of child packages.

#### Example: Rendered Subsection

This example shows a template with content between the *Child Element* tags. In this example child elements of the parent are rendered using the *Child Elements* section because it contains valid content and fields.

The screenshot displays the Enterprise Architect interface. On the left, the 'Sections' tree shows a hierarchy: Model > Package > Element > Child Elements (selected). On the right, the 'Content' editor shows the RTF template for a package. The template includes the following content:

```

<?xml-stylesheet type="text/xsl" href="rtf.xsl" />
<package>
  {Pkg.Name}
  Type: -> -> Package:{Pkg.Stereotype}
  Status: -> -> {Pkg.Status}..Version:{Pkg.Version}..Phase:{Pkg.Phase}
  Package: -> -> {Pkg.ParentPackage}
  Detail: -> -> Created on: {Pkg.DateCreated}
  {Pkg.Notes}
</package>
<?xml-stylesheet type="text/xsl" href="rtf.xsl" />
<element>
  {Element.Name}
  Type: -> -> {Element.Type}..{Element.BaseClasses}
  Status: -> -> {Element.Status}..Version:{Element.Version}..Phase:{Element.Phase}
  Package: -> -> {Element.ParentPackage}..Keywords:..{Element.Tag}
  Detail: -> -> Created on: {Element.DateCreatedShort}
  {Element.Notes}
  <child element>
    -> Child: {Element.Name}
  </child element>
</element>
</package>

```

#### Example: Non-rendered Subsection

This example shows a template with no content between the child element tags. In this example, child elements of the parent are rendered using the *element* section because the *child element* section is empty. The *child element* section is used as a placeholder.

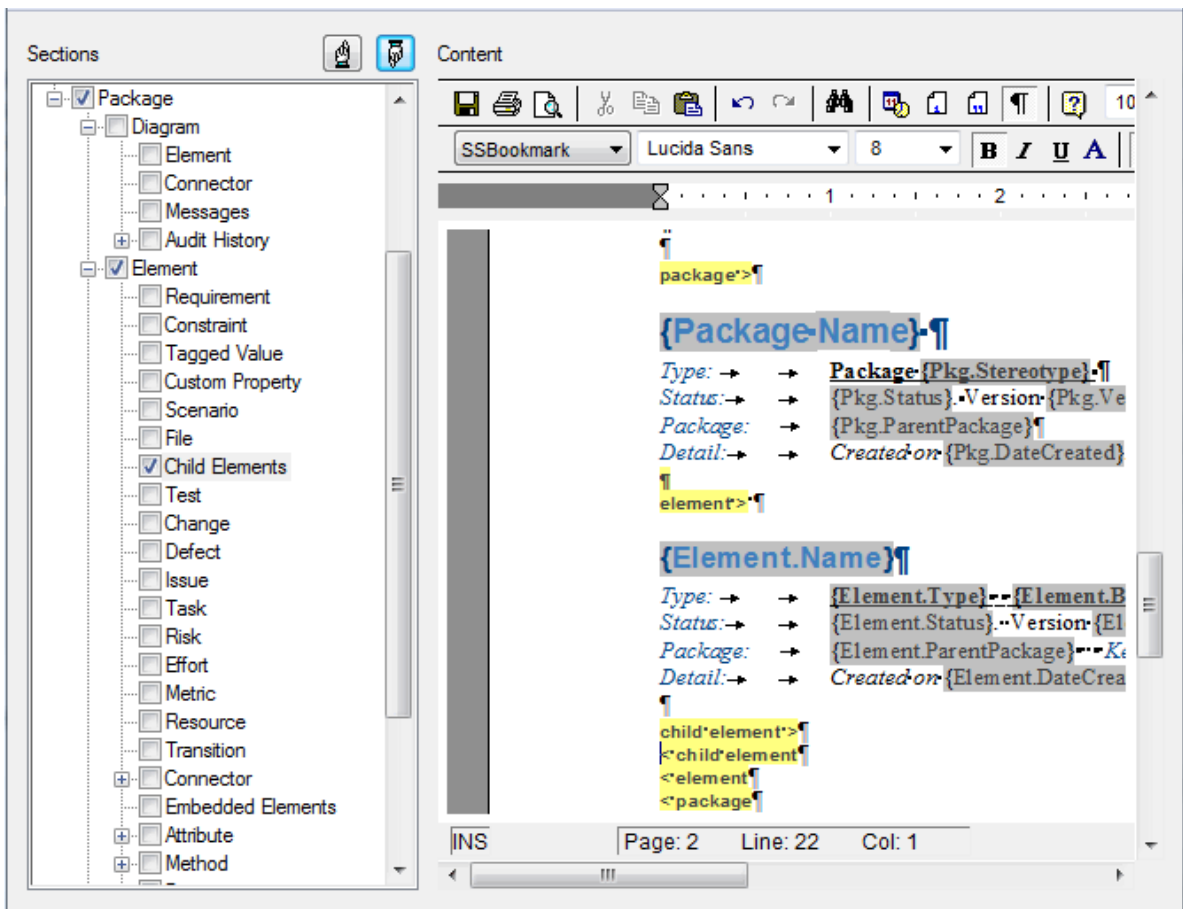

**Child Document Sections and Their Corresponding Parent Sections**

Child Section	Section Rendered when used as a placeholder
Package->Child Package	Package
Package->Element->Child Element	Package->Element
Package->Element->Diagram	Package->Diagram
Package->Diagram->Element	Package->Element
Package->Diagram->Connector	Package->Element->Connector

**10.1.1.4.5 Constraint and Scenario Sections**

The template [content options](#) <sup>1579</sup> enable you to include sections in your reports for:

- *constraints* on Package Elements, Elements, Connectors and Attributes, and
- *scenarios* for Package Elements and Elements.

There are additional options in these types of section that enable you to determine what types of constraint or scenario are included in your reports, as described below.

**Constraints**

The following constraint options are available for selection, as checkboxes in the **Sections** panel of the **RTF Style Template Editor**:

- **Pre-Constraint** - select this checkbox to include all constraints of the type 'pre-condition' in this section of the report.
- **Post-Constraint** - select this checkbox to include all constraints of the type 'post-condition' in this section

of the report.

- **Constraint** - select this checkbox to include all constraints that have not been generated in the Pre-Constraint and Post-Constraint sections of the report.

## Scenarios

The following scenario options are available for selection, as checkboxes in the **Sections** panel of the **RTF Style Template Editor**:

- **Element > Scenario** - select this checkbox to include all scenarios in this section of the report; if any of the following sections are also selected, the report includes all scenarios that are not exception paths.
- **Element > Scenario > Exception** - select this checkbox to include all exceptions for each scenario
- **Element > Scenario > Structured Scenarios** - select this checkbox to include all scenario steps in the scenario sections of the report.
- **Element > Scenario > Structured Scenarios > Exception** - select this checkbox to include the steps for each exception path in the scenario sections of the report.

### 10.1.1.4.6 Add Content

The **RTF Style Template Editor** uses pairs of tags to define the layout of the documentation content. To insert a pair of model component tags into the **Content** section of the Editor, use the **Sections** <sup>[1578]</sup> panel of the **RTF Style Template Editor**.

The beginning of a model component is represented by a yellow highlighted **sectionname >** tag; the end of the model component is represented by **< sectionname**.

To add model component content, right-click in the area between the opening and closing tags. This displays a context menu that enables you to:

- perform simple text editing (cut, copy and paste)
- select from a list of defined **Project Constants** <sup>[1614]</sup> to insert at the cursor position; if no project constants have been defined, the menu option is not available
- select from a context-sensitive list of fields to add to this component section of the RTF Documentation; any additional information entered between the tags is also included in the generated RTF Documentation.

For example, in the **connector >** section shown below, the user has right-clicked in the fourth column of the table, underneath the **<constraint** tag. They can then select to add another field to the Notes on each connector listed in the table.

**connector >**

Connections

Connector	Source	Target	Notes
{Connector.Type}	source >	target >	{Connector.Notes}
{Connector.Name}	{ConnSource.Scope}	{ConnTarget.Scope}	constraint >
{Connector.Direction}	{ConnSource.Role}	{ConnTarget.Role}	{ConnConstraint.Type}
	{ConnSource.RoleNote}	{ConnTarget.RoleNote}	{{ConnConstraint.Name}}
	element >	element >	< constraint
	{Element.Name}	{Element.Name}	
	< element	< element	
	< source	< target	
< connector			

Context menu options:

- Insert Field
  - Direction
  - Guard
  - GUID
  - IsLeaf
  - IsRoot
  - Name
  - Notes
  - Stereotype
  - StereotypeEx
  - Type
  - valueOf
- Project Constants
- Cut
- Copy
- Paste

**Note:**

If you select a field with short date format (such as *Pkg.DateCreatedShort*, *Diagram.DateModifiedShort* or *Element.DateCreatedShort*) the format is actually drawn from the MS Windows settings. To use a different short date format, click on the **Start** icon on the Windows desktop and select the **Control Panel | Regional and Language Options | Customize** option.

## The valueOf Field

For certain sections, you can add a field to capture a special characteristic of a model component, as defined by a specific Tagged Value. This is the **valueOf** field, shown in the list for a connector section in the above graphic. The sections that provide the **valueOf** field are:

- Package
- Element
- Connector
- Attribute
- Operation
- External Requirement.

When you select the **valueOf** field from the context menu, the template editor prompts you to specify the tag (Tagged Value) from which to extract the value for the report output. This tag should be one of the tags associated with the model component, such as *ConnectorAltName* for a connector. When you provide the tag name, the template editor adds the field at the cursor position, in the format:

{Connector.valueOf(*tagname*)}                      for example: {Connector.valueOf(ConnectorAltName)}

For clarity, you could type some lead-in text or the meaning of the Tagged Value immediately preceding the value field; for example:

**Alternative Name:** {Connector.valueOf(ConnectorAltName)}

### 10.1.1.4.7 RTF Style Template Editor Options

The following topics provide assistance on using the RTF Style Template Editor.

- [Scroll Through Text](#) <sup>[1588]</sup>
- [File and Print Options](#) <sup>[1588]</sup>
- [Cut and Paste Options](#) <sup>[1589]</sup>
- [View Options](#) <sup>[1590]</sup>
- [Image and Object Inserts](#) <sup>[1591]</sup>
- [Character Formatting](#) <sup>[1592]</sup>
- [Paragraph Formatting](#) <sup>[1593]</sup>
- [Tab Support](#) <sup>[1595]</sup>
- [Page Breaks and Repagination](#) <sup>[1595]</sup>
- [Headers and Footers](#) <sup>[1596]</sup>
- [Hyperlinks and Bookmarks](#) <sup>[1597]</sup>
- [Table Commands](#) <sup>[1597]</sup>
- [Sections and Columns](#) <sup>[1599]</sup>
- [Stylesheets and Table of Contents](#) <sup>[1600]</sup>
- [User-Defined Section Numbering](#) <sup>[1601]</sup>
- [Frame and Drawing Objects](#) <sup>[1604]</sup>
- [Search/Replace Commands](#) <sup>[1605]</sup>

**Note:**

Throughout your template editing, be aware that:

- To undo one or more immediately previous edits, press **[Ctrl]+[Z]**, or select the **Edit | Undo** menu option. You can still undo a change even after you have saved the change.
- To redo one or more immediately previous undone edits, press **[Ctrl]+[Y]**, or select the **Edit | Redo** menu option.

#### 10.1.1.4.7.1 Scroll Through Text

Scroll Using	Options
Keyboard Keys	<p>Press</p> <ul style="list-style-type: none"> <li>• [↑], [↓], [←] or [→] to scroll up or down a line, or left or right one character</li> <li>• [Home] to move to the beginning of the current line</li> <li>• [End] to move to the end of the current line</li> <li>• [Ctrl]+[Page Up] to move to the beginning of a file</li> <li>• [Ctrl]+[Page Down] to move to the end of a file</li> <li>• [Page Up] to display the previous page</li> <li>• [Page Down] to display the next page</li> <li>• [Ctrl]+[←] to move to the previous word</li> <li>• [Ctrl]+[→] to move to the next word</li> <li>• [Ctrl]+[1] to move to the first column of the current line (if not already on the first column) or the first column of the previous line</li> <li>• [Ctrl]+[2] to move to the first column of the next line</li> <li>• [F10] (or select the <b>Other   Jump</b> menu option), type in a line number to jump to, and click on the <b>OK</b> button.</li> </ul>
Mouse	<p>Click on the vertical and horizontal scroll bar to perform various scrolling functions. These functions are available only if the horizontal or the vertical bar has been enabled by the startup parameters.</p> <p><b>Vertical Scroll Bar:</b> Click on the arrows on either end to scroll the screen up or down by one line.</p> <p>Click above the elevator to scroll the screen up by one page. Similarly, click below the elevator to scroll the screen down by one page.</p> <p>You can also drag the elevator to any position in the bar. As the elevator is dragged, the editor scrolls the screen up or down accordingly.</p> <p><b>Horizontal Scroll Bar:</b> Click on the arrows on either end to scroll the screen left or right by one column. Click on either side of the elevator to scroll the screen left or right by 1/2 screen.</p> <p>You can also drag the elevator to any position in the bar. As the elevator is dragged, the editor scrolls the screen left or right accordingly.</p>

#### 10.1.1.4.7.2 File and Print Options

Menu Option & Function Keys	Use to
<b>New</b>	<p>Clear an existing template from the edit window and start an empty, unnamed template.</p> <p>The editor prompts you to save any modification to the previous template.</p>
<b>Revert</b>	Revert to the previously-saved copy of the template.
<b>Save [Ctrl]+[S]</b>	<p>Save the text to the current file name.</p> <p>If a file is not yet specified, the editor prompts you for a template name.</p>
<b>Save As [Ctrl]+[Shift]+[S]</b>	Similar to <b>Save File</b> , but you specify a new template name for saving the template.
<b>Import</b>	<a href="#">Import an existing RTF document</a> <sup>1606</sup> into the Template Editor, so as to insert model elements from that document into the template.



Menu Option & Function Keys	Use to
	<p><b>Note:</b></p> <p>This option is useful when creating templates from a predefined document with a particular 'look and feel'.</p>
<b>Export</b>	<p>Save the template as an RTF document rather than as a template.</p> <p>This can be useful for saving the template for other models.</p>
<b>Update Styles</b>	<p>Imports the styles from <i>Normal.rtf</i>, found in the Doc Templates directory.</p> <p><b>Note:</b></p> <p>This option is useful when creating a Master Document / Sub Documents that require consistent user-defined styles across multiple templates (including such things as numbering formats).</p>
<b>Document Options</b>	<p>Display the <a href="#">Document Options</a> <small>(1607)</small> dialog which enables you to set the filter and order the elements.</p>
<b>Page Layout</b>	<p>Specify the page layout, before selecting the <b>Print</b> option. You can specify the margins (left, right, top and bottom) in inches.</p>
<b>Printer Setup</b> <b>[Ctrl]+[Shift]+[P]</b>	<p>Invoke a printer-specific dialog for the default printer (the default printer selection is made from the Windows <b>Control</b> panel). You select the parameters from a set of printer-specific options. These options include page size, page orientation, resolution and fonts.</p>
<b>Print [Ctrl]+[P]</b>	<p>Print the contents of the current file. The editor displays a dialog where you can select the scope of the printing. You can also choose to print only a selected part of the file.</p> <p>To print a block of text, highlight the required text before invoking the <b>Print</b> function. This command prints a highlighted:</p> <ul style="list-style-type: none"> <li>• Line block</li> <li>• Character block</li> </ul> <p>The <b>Print</b> function prints on a default printer selected from the Windows <b>Control</b> panel. You can alter the printer setup or page layout prior to invoking the <b>Print</b> function.</p>
<b>Print Preview</b>	<p>Preview the document before printing. The editor displays up to two pages at a time. You can scroll to a different page using <b>[Page Up]</b>, <b>[Page Down]</b> or the scroll bar.</p> <p>By default the preview rectangle is sized to fit the current window. However, you can use the zoom option to enlarge or shrink the preview rectangle as required.</p> <p>Click on the <b>Edit</b> button or the <b>File   Print Preview</b> menu option again to return to editing mode.</p>
<b>Close</b>	<p>Close the Template Editor. The editor prompts you to save any unsaved information.</p>

#### 10.1.1.4.7.3 Cut and Paste Options

To	Do this...
<b>Highlight a word</b>	Double-click on the word.
<b>Highlight a line</b>	Move the cursor onto the line and press <b>[F8]</b> .
<b>Select all file content</b>	Press <b>[Ctrl]+[A]</b> or select the <b>Edit   Select All</b> menu option.

To	Do this...
<b>Copy a block</b>	Highlight the lines of text to be copied and press <b>[Ctrl]+[C]</b> , or select the <b>Edit   Copy</b> menu option.  Move the cursor to the point at which to insert the text and press <b>[Ctrl]+[V]</b> or select the <b>Edit   Paste</b> menu option.
<b>Move a block</b>	Highlight the lines of text to be moved and press <b>[Ctrl]+[X]</b> , or select the <b>Edit   Cut</b> menu option. The selected text is removed from the page.  Move the cursor to the point at which to insert the text and press <b>[Ctrl]+[V]</b> or select the <b>Edit   Paste</b> menu option.
<b>Delete a block</b>	Highlight the lines of text to be deleted and press <b>[Delete]</b>
<b>Delete a line</b>	Press <b>[Shift]+[F9]</b> to delete the current line. The remaining lines close up.
<b>Paste special objects</b>	Select the <b>Edit   Paste Special</b> menu option. The <b>Paste Special</b> dialog displays, listing the appropriate data type formats for pasting the copied object, as listed below.  Click on the <b>Paste</b> button to embed the data into your application, or click on the <b>Paste Link</b> button to create a link to the original file.  <b><u>Native Object Format</u></b>  If available, this is the first format in the list box. You can edit data in this format using the original application, by double-clicking the object.  <b><u>Formatted Text</u></b>  A text format. This option offers the most suitable format if the data is pasted from another text output application, as the font and formatting attributes are reproduced accurately.  <b><u>Unformatted Text</u></b>  Another text format. This option pastes the text without retaining the formatting information.  <b><u>Picture Format</u></b>  The data is available in Picture format. You can later edit the object, by double-clicking on it and invoking the Microsoft MS Draw application.  <b>Note:</b>  This format is preferred over the Bitmap and the Device Independent Bitmap formats.  <b><u>Device Independent Bitmap and Regular Bitmap formats</u></b>  The data is available in bitmap formats. You can later edit the object, by double-clicking on it and invoking the Microsoft MS Draw application.  The editor converts these formats into the Picture format before calling the drawing application.

#### 10.1.1.4.7.4 View Options

Menu Option	Use to
<b>Page Mode</b>	Turn <b>Page Mode</b> on (the equivalent of <i>Print View</i> in Word) or off (the equivalent of <i>Normal View</i> in Word).  In <b>Page Mode</b> , the editor displays one page at a time. It is most useful for documents containing multiple columns, as the columns are displayed side by side.
<b>Fitted View</b>	Turn <b>Fitted View</b> on or off. This is a special case of <b>Page Mode</b> , in which the text wraps to the window width and the soft page breaks are not displayed.  If you select <b>Fitted View</b> , <b>Page Mode</b> is automatically selected too. If you deselect <b>Page</b>

Menu Option	Use to
	<b>Mode, Fitted View</b> is automatically deselected too.
<b>Ruler</b>	Display or hide the ruler at the top of the page. The ruler shows tab stops and paragraph indentation marks; it can also be used to create or delete tab stops.
<b>Tool Bar</b>	Display or hide the tool bar above the ruler. The tool bar provides a convenient method of selecting fonts, point sizes, character styles and paragraph properties. The tool bar also shows the current selection for font, point size and character styles.
<b>Status Ribbon</b>	Display or hide the status ribbon at the bottom of the editing panel. The status ribbon displays the current page number, line number, column number and row number. It also indicates the current insert/overtyping mode.
<b>Paragraph Marker</b>	Display or hide the paragraph marker (an inverted 'P') at the end of each paragraph. This option is useful when working with lines with many different heights.
<b>Hidden Text</b>	Show or hide 'hidden' text. Text formatted with the hidden attribute (see <a href="#">Character Formatting Options</a> <sup>1592</sup> ) is shown with a dotted underline. When the option is turned off, the hidden text is not visible.
<b>Field Names</b>	Insert, show and hide field names. As you develop your RTF document, you right-click on sections to insert field markers. You cannot insert these markers unless you have selected the <b>Field Names</b> option. When you deselect the option, existing field names are obscured.
<b>Page Header/ Footer</b>	Display or hide the text of page headers and footers. If <b>Page Mode</b> is not selected, this option turns <b>Page Mode</b> on. When <b>Page Mode</b> is selected, you cannot edit the header or footer text unless you also select the <b>Edit   Edit Page Header/Footer</b> menu option. See <a href="#">Headers and Footers</a> <sup>1596</sup> . When <b>Page Mode</b> is deselected, you can see and edit page headers and footers at the start of the document.
<b>Page Border</b>	Display or hide a page outline in <b>Page Mode</b> . When <b>Page Mode</b> is deselected, this option is not available. When <b>Page Border</b> is selected, the document contents are shown within a page outline. When <b>Page Border</b> is deselected, the document contents are formatted within the boundaries of the editing screen.
<b>Zoom</b>	Shrink or enlarge the display of the document text, by selecting the appropriate percentage enlargement. The editor supports zoom percentages from 25 to 200.

#### 10.1.1.4.7.5 Image and Object Inserts

To	Do this...
<b>Embed a picture in the document</b>	Position the cursor at the point at which to insert the picture bitmap or Windows metafile, and either: <ul style="list-style-type: none"> <li>• Select the <b>Insert   Embed Picture</b> menu option, or</li> <li>• Press <b>[Alt]+[F8]</b>.</li> </ul> A browser dialog displays, through which you select the picture to embed in the document. The picture displays at the current cursor location.

To	Do this...
	The embedded picture is saved within the document.
<b>Link a picture file to the document</b>	<p>Position the cursor at the point at which to link the picture bitmap or Windows metafile, and select the <b>Insert   Link Picture</b> menu option.</p> <p>A browser dialog displays, through which you select the picture to link to the document. The picture displays at the current cursor location.</p> <p>Linked picture data is not saved with the document, only the filename is stored within the document.</p>
<b>Embed an Ole object in the text</b>	<p>Position the cursor at the point at which to embed the object, and select the <b>Insert   Ole Object</b> menu option. The <b>Insert Object</b> dialog displays, listing the applications that are available to create the object.</p> <p>When you select an application, the editor launches it and you create the required object using this application. When you save the application, the editor inserts an icon that indicates the inserted object. You can later edit the object using the application, by double-clicking on the object.</p> <p><b>Note:</b></p> <p>You can also use the <b>Edit   Paste Special</b>  menu option to import the OLE objects, provided that the object is available in the clipboard.</p>
<b>Edit an embedded picture</b>	Click on the picture and select the <b>Edit   Edit Picture</b> menu option. The <b>Edit Current Picture Parameters</b> dialog displays, through which you can change the width and height of the picture, in inches. You can also align the top, bottom, or middle of the picture with the base line of the text.
<b>Edit an embedded Ole object</b>	Double-click on the icon that indicates the inserted Ole object. Alternatively, position the cursor on the icon and select the <b>Edit   Edit Ole Object</b> menu option. The editor opens the object in the application used to create it, and you can edit the object.
<b>Insert a background picture for the text</b>	<p>Select the <b>Other   Background Picture</b> menu option. A browser dialog displays, through which you select the bitmap or metafile file to insert as a background picture. The picture occupies the entire text area.</p> <p>To remove the background picture, deselect the <b>Background Picture</b> menu option.</p>
<b>Insert an RTF File</b>	Position the cursor at the point at which to insert the file, and select the <b>Insert   Insert RTF File</b> menu option.

#### 10.1.1.4.7.6 Character Formatting

When you change the format of existing text, any new characters you type immediately following automatically assume the formatting characteristics of the existing text.

To	Do this...
<b>Apply character format</b>	<p>Highlight the text to which to apply the format, and use one or more of the following menu options or key combinations, as required:</p> <ul style="list-style-type: none"> <li>• <b>Font   Normal</b>, or press <b>[Alt]+[0]</b></li> <li>• <b>Font   Bold</b>, or press <b>[Ctrl]+[B]</b></li> <li>• <b>Font   Underline</b>, or press <b>[Ctrl]+[U]</b></li> <li>• <b>Font   Double Underline</b>, or press <b>[Ctrl]+[D]</b></li> <li>• <b>Font   Italic</b>, or press <b>[Ctrl]+[I]</b></li> <li>• <b>Font   Superscript</b>, or press <b>[Alt]+[4]</b></li> <li>• <b>Font   Subscript</b>, or press <b>[Alt]+[5]</b></li> <li>• <b>Font   Strike</b>, or press <b>[Alt]+[6]</b> (puts a line through the text)</li> <li>• <b>Font   All Caps</b></li> <li>• <b>Font   Small Caps</b></li> </ul>

To	Do this...
	To reset any character format, highlight the text and select the <b>Font   Normal</b> menu option, or press <b>[Alt]+[0]</b> .
<b>Change font typeface and point size</b>	Highlight the text to change and select the <b>Font   Fonts</b> menu option, or press <b>[Alt]+[F10]</b> . The <b>Font Selection</b> dialog displays, from which you select the required typeface and point size. Click on the <b>OK</b> button.
<b>Change character style</b>	Highlight the text to change and select the <b>Font   Style</b> menu option. The <b>Select a Style</b> dialog displays, listing the currently-defined character styles in the <a href="#">template stylesheet</a> . Select the required style and click on the <b>OK</b> button.
<b>Change the color of text, background (permanent highlight) or underline</b>	Highlight the text to change and select one or more of the following options, as required: <ul style="list-style-type: none"> <li>• <b>Font   Text Color</b></li> <li>• <b>Font   Background Color</b></li> <li>• <b>Font   Underline Color</b></li> </ul> In each case, the <b>Color</b> dialog displays, through which you can select or define the required color. When you have selected a color, click on the <b>OK</b> button.
<b>Change character spacing</b>	Normal character spacing is 20 Twips. If you want to change this (or return to it), highlight the text to adjust, and select the <b>Font   Spacing</b> menu option. The <b>Character Spacing</b> dialog displays. Select the radio button to expand or compress spacing, or to return to normal spacing. If you are changing from normal spacing, enter the number of Twips to set the spacing to. Click on the <b>OK</b> button.
<b>Hide text</b>	Hidden text is not displayed on the screen or printer, but remains in the document and is not deleted. Highlight the text to hide and select the <b>Font   Hidden</b> menu option, or press <b>[Ctrl]+[H]</b> . The highlighted text is not displayed and the rest of the text closes up. To view hidden text, select the <b>View   Hidden Text</b> menu option. You can then make the text normal again by highlighting it and deselecting the <b>Font   Hidden</b> menu option.
<b>Box text</b>	Highlight the text to box and select the <b>Font   Boxed</b> menu option. This creates a broken-line border around the selected text.
<b>Insert a non-breaking space</b>	Move the cursor to the point at which to insert the non-breaking space and select the <b>Insert   Non-breaking Space</b> menu option.
<b>Insert a non-breaking dash</b>	Move the cursor to the point at which to insert the non-breaking dash and select the <b>Insert   Non-breaking Dash</b> menu option.
<b>Insert an optional hyphen</b>	Move the cursor to the point at which to insert the hyphen and select the <b>Insert   Optional Hyphen</b> menu option.

#### 10.1.1.4.7.7 Paragraph Formatting

The functions described below operate on the current paragraph, or on a [highlighted](#) block of text.

To	Do this...
<b>Clear all paragraph formatting</b>	Select the <b>Paragraph   Normal</b> menu option. The editor pushes the paragraph back up to the page margin.
<b>Set text flow in document</b>	To set the text flow for: <ul style="list-style-type: none"> <li>• A selected block of text, select the <b>Paragraph   Text Flow</b> menu option; the <b>Paragraph Text Flow</b> dialog displays</li> <li>• The entire document, select the <b>Edit   Document Text Flow</b> menu option; the</li> </ul>

To	Do this...
	<p><b>Document Text Flow</b> dialog displays.</p> <p>In either case, select the required text flow direction and click on the <b>OK</b> button.</p>
Center text	Select the <b>Paragraph   Center</b> menu option or press <b>[Alt]+[8]</b> .
Right-justify text	Select the <b>Paragraph   Right Justify</b> menu option or press <b>[Alt]+[9]</b> .
Justify both sides of text	Select the <b>Paragraph   Justify Both</b> menu option.
Set double line spacing	Select the <b>Paragraph   Double Space</b> menu option. A double-spaced paragraph has a blank line between each text line.
Indent paragraph left	Select the <b>Paragraph   Indent Left</b> menu option or press <b>[Alt]+[L]</b> . Select the option again to increase the indent.
Indent paragraph right	Select the <b>Paragraph   Indent Right</b> menu option or press <b>[Alt]+[R]</b> . Select the option again to increase the indent.
Create hanging indent	Select the <b>Paragraph   Hanging Indent</b> menu option or press <b>[Alt]+[T]</b> . Select the option again to increase the indent of all lines below the first.
Keep paragraph lines together	Select the <b>Paragraph   Keep Together</b> menu option. The editor attempts to keep all lines within the paragraph on the same page.
Keep paragraph with next	Select the <b>Paragraph   Keep with Next</b> menu option. The editor attempts to keep the last line of the current paragraph and the first line of the next paragraph on the same page.
Prevent 'widow' and 'orphan' lines	Select the <b>Paragraph   Widow/Orphan Control</b> menu option. The editor attempts to avoid having: <ul style="list-style-type: none"> <li>the first line of the paragraph on the previous page ('widow' line)</li> <li>the last line of the paragraph on the next page ('orphan' line).</li> </ul>
Start text on new page	Move the cursor to the point at which to start the new page, and select the <b>Paragraph   Page Break Before</b> menu option.
Insert border and shading for text block	Highlight the required text and select the <b>Paragraph   Border and Shading</b> menu option. The <b>Paragraph Box Parameters</b> dialog displays, on which you specify which sides of the box to display (including a line between text lines), whether the lines are thick or doubled, the degree of gray shading behind the text, and the color of the lines.
Define line spacing	Highlight the required lines and select the <b>Paragraph   Paragraph Spacing</b> menu option. The <b>Paragraph Spacing Parameters</b> dialog displays, on which you specify the line spacing and the point spacing before and after lines.
Set a background color for text space	Highlight a text string or block of text and select the <b>Paragraph   Background Color</b> menu option. The <b>Color</b> dialog displays, on which you select the background color. The editor highlights the full width of the page in that color, for the selected lines.
Create a bulleted list	Highlight the required lines of text and select the <b>Paragraph   Bullet</b> menu option. The editor formats the lines into a simple bullet list.
Create a numbered list	Highlight the required lines of text and select the <b>Paragraph   Numbering</b> menu option. The editor formats the lines into a simple numbered list.
Apply numbering to paragraphs	Set up a <a href="#">numbering list and overrides</a> <sup>[1601]</sup> ( <b>Edit   List and Overrides</b> ) and <a href="#">apply the numbering levels</a> <sup>[1603]</sup> to the template sections ( <b>Paragraph   List Numbering</b> ).
Apply a paragraph style from the template	Select the <b>Paragraph   Style</b> menu option. The <b>Select a Style</b> dialog displays, listing the currently-defined paragraph styles in the <a href="#">template stylesheet</a> <sup>[1601]</sup> .

To	Do this...
stylesheet	Select the required style and click on the <b>OK</b> button.

#### 10.1.1.4.7.8 Tab Support

The RTF Style Template Editor supports *left*, *right*, *center* and *decimal* tabs. Tabs are very useful for creating columns and tables. A paragraph can have as many as twenty tab positions.

A tab usually applies to every line of the current paragraph. However, if you highlight a block of text before setting a tab, the tab then applies to every line in the highlighted text.

You can create tabs quickly and easily using the ruler at the top of the screen. To create a:

- *Left* tab, click on the required tab position on the ruler; the left tab is indicated on the ruler by an **L** shape.
- *Right* tab, right-click on the required tab position on the ruler; the right tab is indicated on the ruler by a reversed **L** shape.
- *Center* tab, press **[Shift]** and click on the required tab position on the ruler; the center tab is indicated on the ruler by an inverted **T** shape.
- *Decimal* tab, press **[Shift]** and right-click on the required tab position on the ruler; the decimal tab stop is indicated on the ruler by an inverted **T** shape with a dot on the right hand side. This tab is for numbers with a decimal point; numbers scroll left from the tab until you type a point, then numbers scroll right.

You can also set tabs using the **Paragraph | Set Tab** menu option, which displays the **Set a Tab Position** dialog. This enables you to specify the tab type, and provides two advantages over the ruler: you can set the tab position with more precision and with a clear value that you can duplicate; and you can add a tab leader line (dot, hyphen, or underline).

- To clear a *single* tab position for selected text, select the **Paragraph | Clear Tab** menu option. The **Clear a Tab Position** dialog displays, on which you select the tab to clear.
- To clear *all* tab stops for selected text, select the **Paragraph | Clear All Tabs** menu option.
- To move a tab position using the mouse, click on the tab symbol on the ruler and drag it to the new position.

#### Note:

The **Other | Snap To Grid** menu option affects the movement of the tabs (and the paragraph indentation markers) on the ruler. When you select this option, the movements of the tab markers are locked on to an invisible grid at intervals of 1/16 inch (half a ruler division).

#### 10.1.1.4.7.9 Page Breaks and Repagination

You can force a page break in the document by selecting the **Insert | Insert Break | Page Break** menu option, or by pressing **[Ctrl]+[Enter]**. The forced page break is indicated by a solid line in the editing window.

If **Page Mode** is off, the editor also marks automatic page breaks when the text overflows a page; these are indicated by a dotted line.

You can repaginate your document, using the **Edit | Repaginate** menu option. This updates the **Page Number** and **Page Count** fields, and recompiles the table of contents.

You insert the **Page Number** and **Page Count** fields as follows:

To	Do this...
Insert the page number	Position the cursor at the point at which to display the page number, and select the <b>Insert   Page Number</b> menu option. The page number is displayed in gray.
Insert the page count	Position the cursor at the point at which to display the total number of pages in the document, and select the <b>Insert   Page Count</b> menu option. The page count is displayed in gray.

### 10.1.1.4.7.10 Headers and Footers

To	Do this...
<b>Edit the page header and footer text</b>	<p>In Page Mode, select the <b>Edit   Edit Page Header/Footer</b> menu option. A paragraph marker displays at the top and bottom of each page, and you can type in, format or delete the appropriate text.</p> <p>If Page Mode is turned off, all page headers and footers are displayed in a block at the start of the document, with identifying labels. You can also edit the text here.</p> <p>Each section in a document can have its own page header and footer.</p>
<b>Create the header and footer for the initial page of the document</b>	<p>In Page Mode, select the <b>Edit   Edit Page Header/Footer</b> menu option and then select the <b>Edit   First Page Header/Footer   Create First Page Header</b> or <b>Create First Page Footer</b> menu option. A paragraph marker displays at the top or bottom of the first page, and you can type in and format the appropriate text.</p> <p>If Page Mode is turned off, all page headers and footers are listed in a block at the start of the document, with identifying labels. You can also edit the text here.</p>
<b>Delete the header and footer for the initial page of the document</b>	<p>Whilst you can delete the first page header or footer text by simple editing, you must specifically delete the 'first page' assignment in order to display the header and footer text of the next section on the first page.</p> <p>In Page Mode, select the <b>Edit   Edit Page Header/Footer</b> menu option and then select the <b>Edit   First Page Header/Footer   Delete First Page Header</b> or <b>Delete First Page Footer</b> menu option. This removes the first page text and assignment, and displays the next-defined header and footer text.</p>
<b>Create a footnote</b>	<p>Move the cursor to the position at which to insert the footnote marker, and select the <b>Insert   Footnote/Endnote   Footnote</b> menu option. The <b>Footnote Parameters</b> dialog displays, on which you enter the footnote marker and footnote text, and select whether to make the marker a superscript.</p> <p>Click on the <b>OK</b> button. The editor inserts the footnote marker at the current cursor location and, in Page Mode, displays the footnote text at the bottom of the page.</p>
<b>Edit footnote text</b>	<p>Select the <b>Edit   Edit Footnote/Endnote   Edit Footnote Text</b> menu option. The text of each footnote displays in the document text where its marker was inserted. Locate the text and make the required changes. In Page Mode, the modified footnote displays at the bottom of the page.</p> <p>When you have finished editing footnote text, <i>deselect</i> the <b>Edit   Edit Footnote/Endnote   Edit Footnote Text</b> menu option. The footnote text is no longer shown in the document text.</p>
<b>Create an endnote</b>	<p>Move the cursor to the position at which to insert the endnote marker, and select the <b>Insert   Footnote/Endnote   Endnote</b> menu option. The <b>Endnote Parameters</b> dialog displays, on which you enter the endnote marker and endnote text, and select whether to make the marker a superscript.</p> <p>Click on the <b>OK</b> button. The editor inserts the endnote marker at the current cursor location and, in Page Mode, displays the endnote text at the end of the section or document.</p>
<b>Edit endnote text</b>	<p>Select the <b>Edit   Edit Footnote/Endnote   Edit Endnote Text</b> menu option. The text of each endnote displays in the document text where its marker was inserted. Locate the text and make the required changes. In Page Mode, the modified endnote displays at the bottom of the page.</p> <p>When you have finished editing endnote text, <i>deselect</i> the <b>Edit   Edit Footnote/Endnote   Edit Endnote Text</b> menu option. The endnote text is no longer shown in the document text.</p>



### 10.1.1.4.7.11 Hyperlinks and Bookmarks

To	Do this...
<b>Manage bookmarks</b>	<p>Each template contains a number of bookmarks that mark the sections. You can apply these bookmarks to related sections, create and assign your own, delete those that are not required, and locate specific bookmarks in the document.</p> <p>In <b>Page Mode</b>, select the <b>Insert   Bookmark</b> menu option. The <b>Bookmark</b> dialog displays.</p> <ul style="list-style-type: none"> <li>To assign a bookmark to the current cursor position, either type a new bookmark in the top field or select one from the list, and click on the <b>Insert</b> button.</li> <li>To delete an existing bookmark, click on it in the list and click on the <b>Delete</b> button.</li> <li>To mark a bookmark with the number of the page it is on, click on the bookmark in the list and click on the <b>Set Page Reference</b> button.</li> <li>To locate a bookmark in the text, click on it in the list and click on the <b>Go to</b> button.</li> </ul>
<b>Insert hyperlinks</b>	<p>Right-click on the point at which to create the hyperlink and select the <b>Insert   Hyperlink</b> context menu option. The <b>Insert Hyperlink</b> dialog displays. You can create a hyperlink within an RTF document to an external document, Help topic or web page.</p> <p>In the <b>Link Text</b> field type the text to be hyperlinked, and in the <b>Link Code</b> field type or paste the web page URL, help topic file or external file path and name.</p> <p><b>Tip:</b></p> <p>To capture the help topic file name, right-click on the displayed topic, select the <b>Properties</b> context menu option, and copy the file name. When you insert the file name in the <b>Link Code</b> field, ensure that the file name has the prefix <code>\$Help:/</code>.</p> <p>Click on the <b>OK</b> button. The hyperlinked text displays in the document. Double-click on the link to display the web page or external document.</p>

### 10.1.1.4.7.12 Table Commands

The **Table** menu enables you to create a new table, or to edit an existing table's attributes.

To	Do This...
<b>Insert a table in the document</b>	<p>Position the cursor at the appropriate point, and select the <b>Table   Insert Table</b> menu option. The <b>New Table Parameters</b> dialog displays, in which you specify the number of table rows and columns.</p> <p>The editor initially creates cells of equal width. You can, however, change the cell width by dragging the cell borders using the mouse. When <b>Page Mode</b> is deselected, the table structure is not visible.</p>
<b>Add a header row</b>	Select the rows to act on, and then select the <b>Table   Header Row</b> menu option. Apply any heading settings and formatting to the rows in the highlighted block.
<b>Insert a new row above the current row</b>	Select the <b>Table   Insert Row</b> menu option.
<b>Insert a new column to the left of the current column</b>	Select the <b>Table   Insert Column</b> menu option.
<b>Merge cells</b>	Select the cells to merge and select the <b>Table   Merge Cells</b> menu option. The width of

To	Do This...
	the resulting cell is equal to the sum of the merged cells. You can merge cells across a row, down a column, and in a block spanning both rows and columns.
<b>Split a cell</b>	Select the cell to split and select the <b>Table   Split Cell</b> menu option. The selected cell is split into two cells of equal width. Any text in the original cell is assigned to the first cell. The second cell is created empty.
<b>Delete cells</b>	Select the cells to delete and select the <b>Table   Delete Cells</b> menu option. The <b>Delete Table Cells</b> dialog displays, on which you specify whether to delete: <ul style="list-style-type: none"> <li>• <b>Cells</b> - deletes the highlighted cells</li> <li>• <b>Columns</b> - deletes all the cells in the highlighted column or columns</li> <li>• <b>Rows</b> - deletes all the cells in the highlighted row or rows.</li> </ul> If you delete all cells in a table, the table itself is automatically deleted.
<b>Position the table on the page</b>	Click on any part of the table and select the <b>Table   Row Position</b> menu option. The <b>Table Row Alignment</b> dialog displays, on which you select to left-align, center or right-align the table on the page. This option has little effect if the table is wide enough to span the page or text column.
<b>Set the height of a row, or all rows</b>	Select the row to adjust and select the <b>Table   Row Height</b> menu option The <b>Row Height Parameters</b> dialog displays, enabling you to set an automatic row height, a minimum row height, or an exact row height. You can apply the setting to the selected rows only, or to all rows in the table.
<b>Keep row text together if it continues over a page</b>	Select the rows to protect (preferably all rows in the table) and select the <b>Table   Keep Row Together</b> menu option. If the row continues over the end of the page, the whole row is moved to the top of the next page.
<b>Set text flow in rows</b>	Select the rows and select the <b>Table   Row Text Flow</b> menu option. The <b>Table Text Flow</b> dialog displays, on which you select the direction of flow of the text and select to apply the setting to the selected rows or all rows in the table. This option also moves the whole row over to the appropriate side of the page or column.
<b>Set the width of selected cells</b>	Select the cells to act on and select the <b>Table   Cell Width</b> menu option. The <b>Set Cell Width</b> dialog displays, on which you set the cell width and text margin and apply them to: <ul style="list-style-type: none"> <li>• All cells in a highlighted block</li> <li>• The selected cells only</li> <li>• All cells in the selected column or columns, or</li> <li>• All cells in the selected row or rows.</li> </ul>
<b>Define the cell border width</b>	Select the cells to act on and select the <b>Table   Cell Border Width</b> menu option. The <b>Set Cell Border</b> dialog displays, on which you set the width of the line at any or all of the top, bottom, left and right of a cell, or whether to draw a uniform border around the cells. You can also set the text margin, and apply all the settings to: <ul style="list-style-type: none"> <li>• All cells in a highlighted block</li> <li>• The selected cells only</li> <li>• All cells in the selected column or columns, or</li> <li>• All cells in the selected row or rows.</li> </ul>
<b>Define the cell border color</b>	Select the cells to act on and select the <b>Table   Cell Border Color</b> menu option. The <b>Set Cell Border Color</b> dialog displays, on which you set the color of the line at any or all of the top, bottom, left and right of a cell, or whether to have a uniformly colored border around the cells. You then apply the settings to: <ul style="list-style-type: none"> <li>• All cells in a highlighted block</li> <li>• The selected cells only</li> <li>• All cells in the selected column or columns, or</li> </ul>

To	Do This...
	<ul style="list-style-type: none"> <li>All cells in the selected row or rows.</li> </ul>
<b>Define the cell shading</b>	<p>Select the cells to act on and select the <b>Table   Cell Shading</b> menu option. The <b>Cell Shading Parameters</b> dialog displays, on which you set the shading percentage. The value <b>0</b> indicates the palest background, whereas the value <b>100</b> indicates a black background. You then apply the setting to:</p> <ul style="list-style-type: none"> <li>All cells in a highlighted block</li> <li>The selected cells only</li> <li>All cells in the selected column or columns, or</li> <li>All cells in the selected row or rows.</li> </ul>
<b>Define the cell background color</b>	<p>Select the cells to act on and select the <b>Table   Cell Color</b> menu option. The <b>Cell Color Parameters</b> dialog displays, on which you set the cell background color. You then apply the color to:</p> <ul style="list-style-type: none"> <li>All cells in a highlighted block</li> <li>The selected cells only</li> <li>All cells in the selected column or columns, or</li> <li>All cells in the selected row or rows.</li> </ul>
<b>Vertically align cells</b>	<p>Select the cells to act on and select the <b>Table   Cell Vertical Align</b> menu option. The <b>Cell Vertical Alignment</b> dialog displays, on which you select to align the selected cells by top, center, bottom or baseline. You then select to align:</p> <ul style="list-style-type: none"> <li>All cells in a highlighted block</li> <li>The selected cells only</li> <li>All cells in the selected column or columns, or</li> <li>All cells in the selected row or rows.</li> </ul>
<b>Rotate cell text</b>	<p>Select the cells to act on and select the <b>Table   Cell Rotate Text</b> menu option. The <b>Cell Text Rotation</b> dialog displays. On which you select to display text horizontally across the cell, vertically up the cell, or vertically down the cell. You then select to apply the rotation to:</p> <ul style="list-style-type: none"> <li>All cells in a highlighted block</li> <li>The selected cells only</li> <li>All cells in the selected column or columns, or</li> <li>All cells in the selected row or rows.</li> </ul>
<b>Select column</b>	<p>Click on a cell and select the <b>Table   Select Current Column</b> menu option. The whole column is highlighted and selected for further formatting.</p>
<b>Show / hide table outline</b>	<p>Click on a table cell and select the <b>Table   Show Gridlines</b> menu option. This displays or hides the grid lines around the table cells. The grid lines are for display purpose only and do not appear on the printed document.</p>

#### 10.1.1.4.7.13 Sections and Columns

The editor enables you to divide a document into multiple sections. A multiple section document is useful to:

- Vary the page margins from one page to another
- Create multiple columns of text.

To	Do this...
<b>Create a new section</b>	<p>Select the <b>Insert   Insert Break   Section Break</b> menu option. This creates a new section on a new page.</p> <p><b>Note:</b></p> <p>This option is not available when <b>Edit   Edit Page Header/Footer</b> is active.</p>

To	Do this...
<b>Edit the section parameters</b>	<p>Select the <b>Edit   Edit Section</b> menu option. The <b>Section Parameters</b> dialog displays. Define:</p> <ul style="list-style-type: none"> <li>• The number of columns and column spacing; text in a multiple column section wraps at the end of the column. When the text reaches the end of the page, it resumes in the next column. When <b>Page Mode</b> is off, the page contains a single very thin and long column. When <b>Page Mode</b> is on, the correct column layout is shown.</li> <li>• The orientation - Portrait or Landscape</li> <li>• Whether to start the new section on the next page</li> <li>• The direction of text flow</li> <li>• Any special printing characteristics for the section.</li> </ul> <p>You can also define any special page margins by selecting the <a href="#">File   Page Layout</a>  menu option.</p>
<b>Delete a section break</b>	Move the cursor onto the section break line and press <b>[Delete]</b> .
<b>Create a column break</b>	<p>Move the cursor to the appropriate point in the text and select the <b>Insert   Insert Break   Column Break</b> menu option.</p> <p>Normally in a multiple column section, the text flows from the end of one column to the top of the next column. A column break forces the text to the next column before the current column is completely filled.</p> <p>A column break is indicated by a line with a 'dot and dash' pattern. To delete the column break, simply position the cursor on the column break line and press <b>[Delete]</b>.</p>

#### 10.1.1.4.7.14 Stylesheets and Table of Contents

The editor supports *Character* and *Paragraph-type* stylesheet style items. The Character stylesheet style constitutes a set of character formatting attributes and is applied to a character string. The Paragraph stylesheet style constitutes both a set of character formatting attributes and a set of paragraph formatting attributes, and is applied to one or more paragraphs.

You can also include special, structured text in the document, such as [page number](#) , date and time and text input fields.

To	Do this...
<b>Use double-byte characters</b>	Select the <b>Edit   Inline Ime</b> menu option. This enables you to enter double-byte characters without using an external IME application
<b>Create and edit styles</b>	<p>Select the <b>Edit   Edit Style</b> menu option. The <b>Edit Stylesheet</b> dialog displays.</p> <p>Select the appropriate radio button to define a character style or a paragraph style.</p> <p>Either select an existing style to modify from the list box, or type in a name for a new style. Click on the <b>OK</b> button to begin recording the style properties. You can use the ruler, toolbar or menu selections to modify the style items. These also reflect the currently-selected properties for the stylesheet item. Please note that the paragraph properties are enabled only for the paragraph stylesheet items.</p> <p>After you have defined the required style, either select the <b>Edit   Edit Style</b> menu option again or click anywhere in the document. If you modified an existing stylesheet item, the document automatically reflects the updated style. If you created a new stylesheet item, you can apply the style to highlighted text by selecting the <b>Font   Style</b> or <b>Paragraph   Style</b> menu options.</p>
<b>Apply character styles</b>	Select the <b>Font   Style</b> menu option to apply a stylesheet style to a highlighted character string.
<b>Apply paragraph styles</b>	Select the <b>Paragraph   Style</b> menu option to apply a stylesheet style to a highlighted paragraph or range of paragraphs.

To	Do this...
<b>Insert a table of contents</b>	<p>Create and apply the required heading styles using the <b>Edit   Edit Style</b> menu option, as above.</p> <p>Move the cursor to the point at which to insert the table of contents and select the <b>Insert   Table of Contents</b> menu option.</p> <p>The table of contents is automatically updated whenever <a href="#">repagination</a><sup>[1595]</sup> occurs.</p>
<b>Insert date and time fields</b>	<p>Move the cursor to the point at which to insert the current date and time, and select the <b>Insert   Date and Time</b> menu option. The <b>Insert Current Date/Time</b> dialog displays, from which you select the required date and time format.</p> <p>The date and time are automatically updated whenever the page text is refreshed.</p>
<b>Insert your own data fields</b>	<p><b>Not Supported In The Enterprise Architect RTF Generator.</b></p> <p>Move the cursor to the point at which to insert the data field and select the <b>Insert   Data Field</b> menu option. The <b>Data Field Parameters</b> dialog displays, in which you enter the field name and data value.</p>
<b>Insert a text entry field</b>	<p>Move the cursor to the point at which to insert the text entry field and select the <b>Insert   Text Input Field</b> menu option. The <b>Input Field Parameters</b> dialog displays, in which you enter the field name, initial value, maximum field length and text font, and specify whether or not the field has a border.</p>
<b>Insert a selectable checkbox</b>	<p>Move the cursor to the point at which to insert the checkbox and select the <b>Insert   Checkbox Field</b> menu option. The <b>Checkbox Field Parameters</b> dialog displays, in which you enter the field name, whether it defaults to selected, and the size of the box surrounding the check.</p>
<b>Define level numbering in generated document</b>	<p>Select the <b>Edit   List and Overrides</b> menu option, <a href="#">set up the numbering list and the list overrides</a><sup>[1601]</sup>, then apply the numbering list to the headings set for packages and elements, using paragraph numbering.</p>

#### 10.1.1.4.7.15 User-Defined Section Numbering

You might want to define the numbering format for the section levels in your generated RTF document.

For example:

1. Package level 1
  - 1.1 Package level 2 (child package)
    - 1.1.1 Element Level 1
      - 1.1.1.1 Element (child element)

To define the numbering format you first create a numbering list and then create a set of list overrides for this list. The overrides must also have the initial 1.0.0 setting altered to 1.1.1. You can then apply the numbering list to the headings set for packages and elements, using paragraph numbering.

(See [Section Numbering in Virtual Documents](#)<sup>[1623]</sup> for further information on applying continuous section numbering throughout a [Virtual Document](#)<sup>[1618]</sup>.)

### Procedure

To define the numbering format, follow the steps below.

1. In the **Template Editor**, select the **Edit | List and Overrides | Create List Item** menu option. The **List Properties** dialog displays.

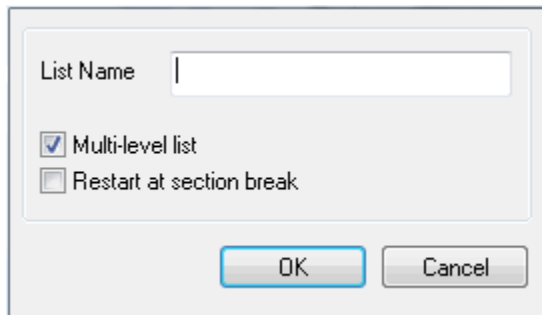

A dialog box titled "List Name" with a text input field for the list name. Below the input field are two checkboxes: "Multi-level list" (checked) and "Restart at section break" (unchecked). At the bottom are "OK" and "Cancel" buttons.

- In the **List Name** field, type a name for the list. Click on the **OK** button to close the dialog.
- Select the **Edit | List and Overrides | Create List Override** menu option. The **List Override Properties** dialog displays.



A dialog box titled "List to Override" with a dropdown menu showing "MasterList". Below the dropdown is a checked checkbox labeled "Override Levels". At the bottom are "OK" and "Cancel" buttons.

- In the **List to Override** field, type or select the name of the list you have just created. Click on the **OK** button to close the dialog.
- To set the list level properties for each level, select the **Edit | List and Overrides | Edit List Level** menu option. The **List Level Properties** dialog displays.

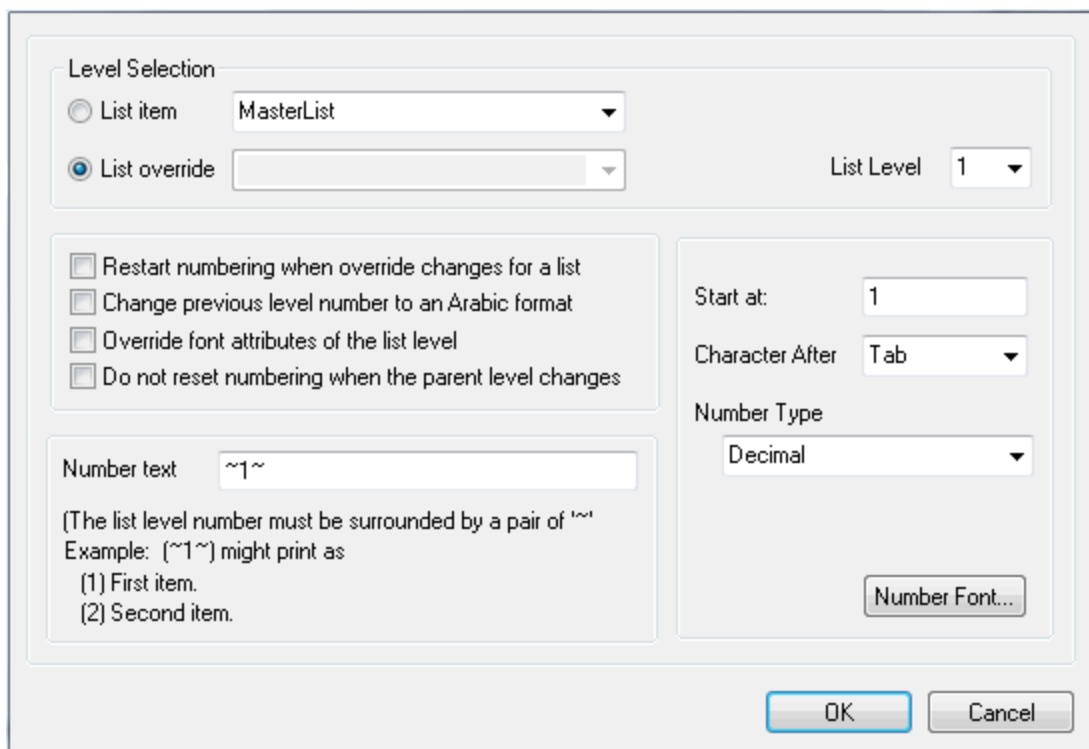

A complex dialog box titled "List Level Properties". It has a "Level Selection" section with two radio buttons: "List item" (unselected) and "List override" (selected). The "List item" radio button has a dropdown menu showing "MasterList". The "List override" radio button has an empty dropdown menu. To the right of these is a "List Level" dropdown menu set to "1". Below this are four checkboxes: "Restart numbering when override changes for a list" (unchecked), "Change previous level number to an Arabic format" (unchecked), "Override font attributes of the list level" (unchecked), and "Do not reset numbering when the parent level changes" (unchecked). To the right of these checkboxes are three input fields: "Start at:" with the value "1", "Character After" with a dropdown menu showing "Tab", and "Number Type" with a dropdown menu showing "Decimal". Below these is a "Number text" input field containing "~1~". Below the input field is a note: "(The list level number must be surrounded by a pair of '~'. Example: (~1~) might print as (1) First item. (2) Second item.)". At the bottom right is a "Number Font..." button. At the very bottom are "OK" and "Cancel" buttons.

- To set the first level numbering (used in the *Package Section*), select the **List override** radio button and type or select the list override item you have just created.
- Ensure that the **List Level** field is set to **1** (for Packages) and the **Number text** field is set to **~1~**. Click

on the **OK** button to save the values and close the dialog.

8. Open the dialog again (**Edit | List and Overrides | Edit List Level**) and set:
  - **List Level** to **2** (for the *Element Section* or *Child Package Section*, for example)
  - **Start at** to **1** (to ensure that numbering at this level begins at 1.1 rather than 1.0).
9. Click on the **OK** button to close the dialog and save the changes.
10. Repeat steps 5 to 9 as required, incrementing the list level number and resetting **Start at** to **1** each time.

## Use Numbering Levels

To apply the numbering levels you have defined (above), follow the steps below:

1. In the **Content** window of the **Template Editor**, select the first item of text to be numbered (for example, *Package*).

```
package->|
Package: {Pkg.Name} ¶
element->|
Element: {Element.Name} ¶
child-elements->|
<child-elements|
<element|
child-packages->|
<child-packages|
<package|
```

2. Set the text style, using the style drop-down field in the **Template Editor** toolbar.

```
package->|
Package: {Pkg.Name} ¶
```

3. Click on the **Paragraph | List Numbering** menu option. The **Apply paragraph numbering using Lists** dialog displays.

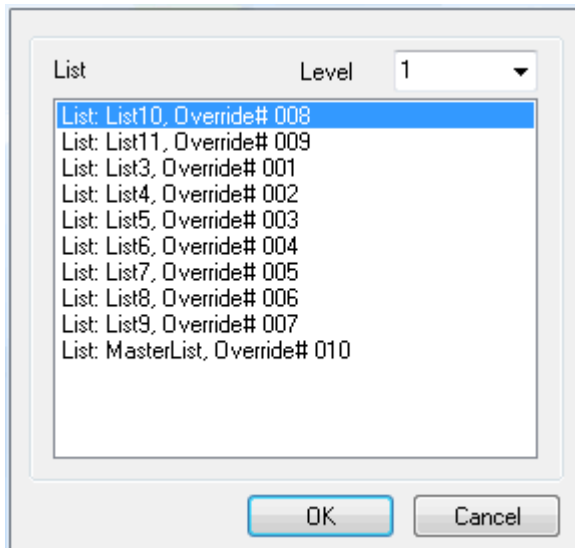

4. Select the required Numbering List and Override, and set the **Level** field to the required level (**1**, for the top level). Click on the **OK** button to close the dialog, and check that the required level has been applied to the selected text.

```
package->|
1. Package: {Pkg.Name} ¶
```

5. Repeat steps 1 to 4 for the next level (*Element*), but at step 4 change the **Level** field to **2**.

**element:>**

## 1.1 Element: **{Element.Name}**

6. Continue applying the overrides for lower section levels as necessary, then save the template and generate your RTF report. The output should now resemble the following example:

1. **Package: Formal Requirements**
  - 1.1 **Package: Manage Users**
    - 1.1.1 Element: REQ011 - Manage User Accounts
    - 1.1.2 Element: REQ016 - Add Users
    - 1.1.3 Element: REQ017 - Remove User
    - 1.1.4 Element: REQ018 - Report on User Account
    - 1.1.5 Element: REQ024 - Secure Access
    - 1.1.6 Element: REQ025 - Store User Details
    - 1.1.7 Element: REQ026 - Validate User
  - 1.2 **Package: Manage Inventory**
    - 1.2.1 Element: REQ019 - Manage Inventory
    - 1.2.2 Element: REQ020 - Receive Books
    - 1.2.3 Element: REQ021 - List Stock Levels
    - 1.2.4 Element: REQ022 - Order Books
    - 1.2.5 Element: REQ023 - Store and Manage Books
    - 1.2.6 Element: REQ027 - Add Books
    - 1.2.7 Element: REQ032 - Update Inventory |

### 10.1.1.4.7.16 Frames and Drawing Objects

A frame is a rectangular area that can contain both text and pictures on the page. The text *outside* the frame flows around it. A drawing object can be a text box, rectangle or a line. The drawing object *overlays* the text around it. You can see frames and drawing objects only if **View | Page Mode** is selected. However, the *content* of a frame or text box is still visible if **Page Mode** is deselected.

To	Do this...
Embed a frame or drawing object at the cursor position	Select the <b>Insert   Frame</b> or <b>Insert   Drawing Object</b> menu option.
Insert text into the frame or drawing object text box	Click inside the outline and type the text at the cursor position.
Rotate text to display it down the side of the frame or text box	Select the <b>Edit   Edit Frame/Drawing Object   Rotate Text</b> menu option and select the text direction.
Insert a picture into a frame or drawing object text box	Copy the picture, click inside the outline and paste the picture at the cursor position.
Size a frame or drawing object	Click inside the outline, click on a sizing tab on the outline and drag the tab to the required position.  If the frame or text box contains only a picture, the picture size is automatically adjusted to fill the outline. Any text inside the outline is automatically wrapped to adjust to the new width.  In a frame the frame height is automatically adjusted, if necessary, to enclose all



To	Do this...
	lines. In a text box, you must adjust the height manually to enclose the text.
Move the frame or drawing object	Click inside the outline and then move the cursor just outside the outline so that the cursor changes to a plus-shape. Drag the plus shape (and hence the outline) to the new location.
Edit the relationship between a frame or drawing object and a point on the page (the vertical base position)	Click on the outline and select the <b>Edit   Edit Frame/Drawing Object   Vertical Base Position</b> menu option. Select the point to lock the outline to. Outlines locked to the top of the page or the top of the margin retain their vertical position when you insert text before them.
Edit the border and the background of a drawing object	Select the <b>Edit   Edit Frame/Drawing Object   Edit Drawing Object</b> menu option. On the <b>Line and fill attributes</b> dialog, select the options for the preferred border, line color, fill color and wrapping effect on the template text.
Delete a frame or drawing object	Click on the outline and press <b>[Delete]</b> . The editor prompts you to confirm the deletion. Click on the <b>OK</b> button. Note that the deletion is actually reversible - press <b>[Ctrl]+[Z]</b> or select the <b>Edit   Undo</b> menu option.

#### 10.1.1.4.7.17 Search and Replace Commands

The first three menu options below all invoke the **Search String Parameters** dialog, if no search term has been defined.

Specify the term to search for, whether to search from the start of the file or forwards or backwards from the current cursor position, and whether the search should exactly match the case of the search term.

To	Do this...
<b>Search for a text string</b>	Select the <b>Other   Search</b> menu option, or press <b>[F5]</b> . The <b>Search String Parameters</b> dialog displays. The editor searches for the first instance of the specified character string as defined by the parameters.
<b>Find the next instance of a previously-defined text string in the file</b>	Select the <b>Other   Search Forward</b> menu option, or press <b>[Ctrl]+[F]</b> . The editor searches forwards for the next instance of the specified text string in the file, and highlights it.
<b>Find the previous instance of the previously-defined text string in the file</b>	Select the <b>Other   Search Backward</b> menu option, or press <b>[Ctrl]+[Shift]+[F]</b> . The editor searches backwards for the previous instance of the text string in the file, and highlights it.
<b>Replace a text string</b>	Select the <b>Other   Replace</b> menu option, or press <b>[F6]</b> . The <b>Replace String Parameters</b> dialog displays, in which you specify the text string to locate and the text string to replace it with, whether to search the whole document or a highlighted block of text, and whether to confirm each replacement before

To	Do this...
	making the change.

### 10.1.1.5 Import RTF Template

Enterprise Architect provides a number of RTF document templates, and enables you to create others. However, you might already have corporate formats and templates in use in your organization, so Enterprise Architect also enables you to import existing templates into the RTF Generator.

To import an external template, follow the steps below:

1. Save the external template as an RTF document.
2. In Enterprise Architect, [create a new blank template](#)<sup>[1577]</sup>. Name the template but do not specify an existing template to copy from.
3. When the template is listed on the **Templates** tab of the **Generate RTF Documentation** dialog, click on the name and click on the **Edit** button. The RTF **Document Template Editor** dialog displays.
4. Select the **File | Import** menu option. The Microsoft Word file **Open** dialog displays.
5. Locate your template RTF file, and click on the **Open** button. The **Open** dialog closes, returning you to the **Document Template Editor** dialog. This now contains your imported template.
6. Select the **File | Save** menu option. If necessary, make any [changes](#)<sup>[1587]</sup> to the template and select **File | Save** again before selecting **File | Close** to exit the dialog.

#### Note:

Standard graphical images (such as a logo in the header, main text or footer) are imported. However, any Word-based meta-file graphics are not imported.

You can select the new template to use in generating an RTF document, either on the [Generate RTF Documentation](#)<sup>[1570]</sup> dialog or in a [Master Document](#)<sup>[1618]</sup> or [Model Document](#)<sup>[1618]</sup> element.

### 10.1.1.6 Resource Documents

The *Resource Document* feature enables a particular documentation configuration to be 'remembered', linking the loaded template within the **Generate RTF Documentation** dialog to the current highlighted package. If a particular template is always used with a specific package, and multiple cases of documentation exist to be propagated, saving these as Resource Documents can ease document generation later.

#### Note:

Resource Documents, saved into the **Resources** window, save only the package, output file destination and template name from the **Generate** tab of the [Generate RTF Documentation](#)<sup>[1573]</sup> dialog. They do not retain the RTF data separately defined in the [Options, Advanced](#)<sup>[1607]</sup> and [Element Filter](#)<sup>[1611]</sup> tabs of the dialog.

To save and re-use the options data, edit the template directly in the template editor and use the [File | Document options](#)<sup>[1588]</sup> option to set the values as part of the template.

To create and use Resource Documents, follow the steps below:

1. Open the [Generate RTF Documentation dialog](#)<sup>[1570]</sup>.
2. Click on the **Resource Document** button. The **Save current as document definition** dialog displays:

3. In the **Enter Value** field, type a name for the document and click on the **OK** button. The document is added to the **Resources** window for easy future access (as for the *usecasedoc* entry in the illustration below).

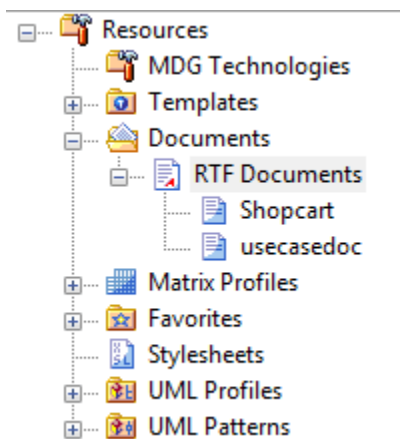

4. To generate documentation from the **Resources** window, right-click on the required document. The context menu displays.
5. Select the required option.

The context menu options are:

- **Open Document** - Opens the corresponding .RTF file, as specified by the RTF template *Filename* property
- **Generate Document** - Opens the **Generate RTF Documentation** dialog, loaded with the specified template
- **Auto Generate Document** - Generates documentation, with the document located at the path specified by the template's *Filename* property
- **Delete Document** - Removes the specified document.

### Batch Generate Resource Documents

To generate a number of RTF documents at the same time, right-click on the *RTF Documents* folder name and select the **Generate Documents** context menu option. The **Batch Document Generation** dialog displays.

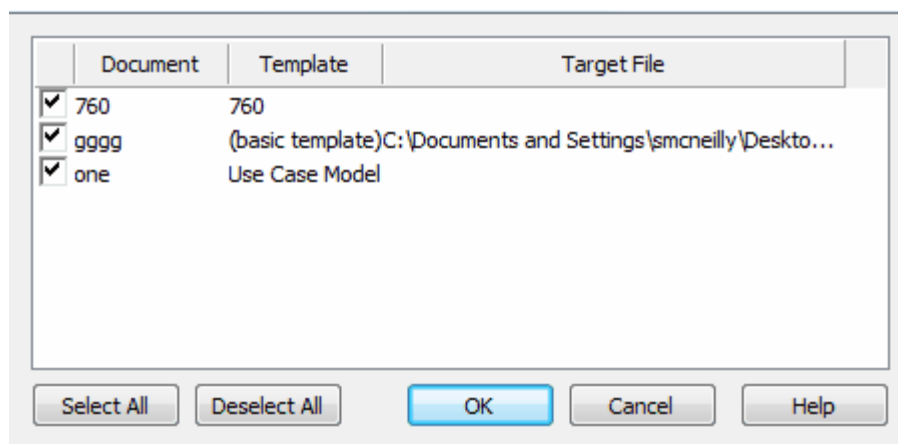

The dialog lists all resource documents in the *RTF Documents* folder, defaulted to selected. Deselect the checkbox against each document that you do not want to generate (or click on the **Deselect All** button to clear all selections, then select those you require). Click on the **OK** button to generate each of the remaining reports into their respective target file locations.

The **Generate All Documents** context menu option automatically generates every document in the *RTF Documents* folder, without displaying the **Batch Document Generation** dialog.

#### 10.1.1.7 Document Options

The RTF report options enable you to set type filters and order the elements. You can access the options from two different places; the start point affects the persistence of options selected:

1. If you access the options on the **Options** and **Advanced** tabs of the [Generate RTF Documentation](#) <sup>1573</sup> dialog, you can define settings for the current report to be run. Selections are non-persistent, and are

reset when you exit the dialog or select a different template.

- If you access the options by clicking on the **File | Document Options** menu option on the **RTF Style Template Editor** dialog, the settings are saved with the template as the default settings for any run of this report; the **Document Options** dialog provides the options from **both** of the **Options** and **Advanced** tabs of the **Generate RTF Documentation** dialog, plus the **Element Filters** and **Other Filters** tabs, with three **minor differences**.

The **Options** tab of the **Generate RTF Documentation** dialog has the following fields:

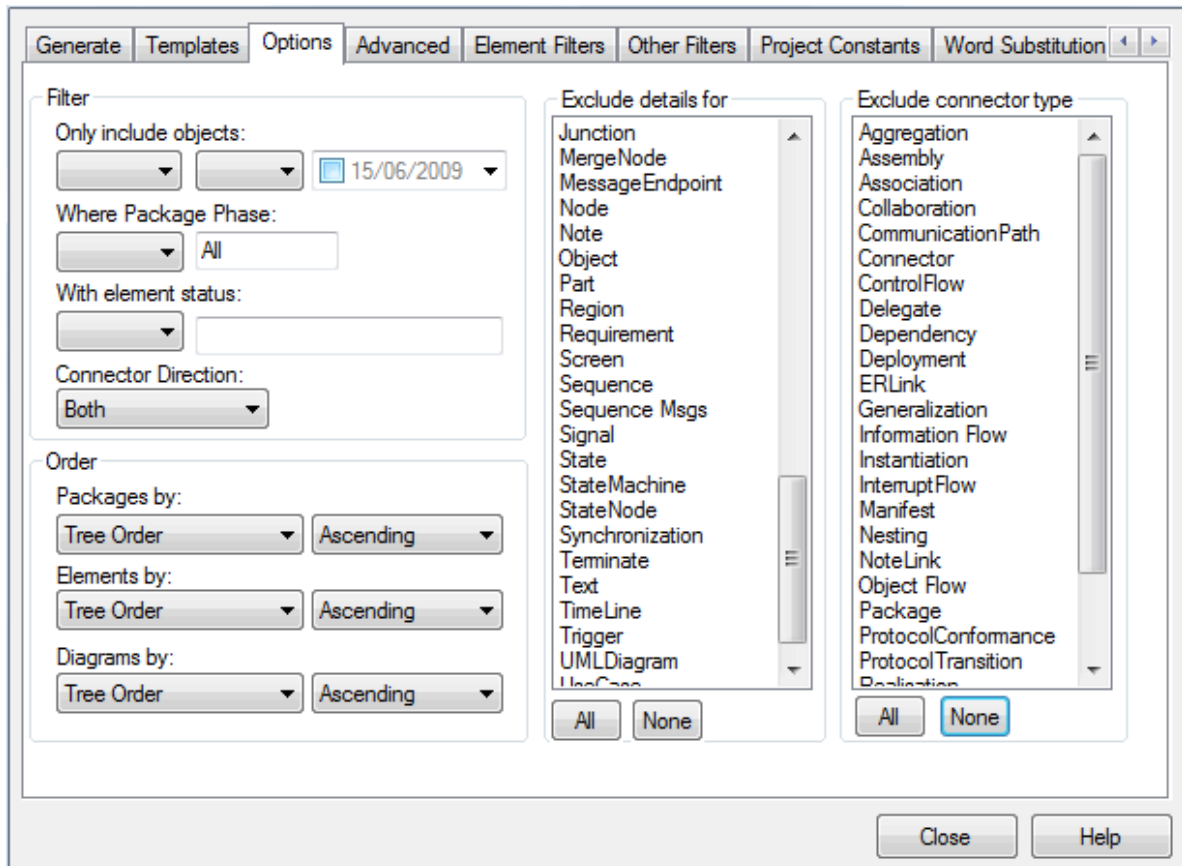

Option	Use to
<b>Filter</b>	
<b>Only include objects</b>	Filter elements according to date created or modified. In the first two fields, select the qualifiers from the drop-down lists. In the third field, select the appropriate date.
<b>Where Package Phase</b>	Filter elements according to the value of the <b>Package Phase</b> field. In the first field select the qualifier, and in the second type the required phase (or leave the default value <b>All</b> ).
<b>With element status</b>	Filter elements according to status. In the first field, select the qualifier ( <b>like, not like, in, not in</b> ) and in the second field type the value to be used. Values should be enclosed in quotes; for example: "Proposed". If you type more than one value, separate them with a comma; for example: "Proposed", "Implemented".
<b>Connector Direction</b>	Filter connectors according to direction.  If you select <b>Both</b> , the connector is documented twice; once for the source element and once for the target. For the remaining two values, the connector is documented only for the source or target element, as appropriate.

Option	Use to
Order	
<b>Packages by</b>	Order packages in the generated documentation in either ascending or descending order of Name, Tree Order, Modified Date or Created Date.
<b>Elements by</b>	Order elements in the generated documentation in either ascending or descending order of Name, Tree Order, Modified Date or Created Date.
<b>Diagrams by</b>	Order diagrams in the generated documentation in either ascending or descending order of Name, Tree Order, Modified Date or Created Date.
Exclude details for	Exclude all elements of the selected type or types from the generated document.
Exclude connector type	Exclude all connectors of the selected type or types from the generated document.

The **Advanced** tab of the **Generate RTF Documentation** dialog has the following fields:

Option	Use to
<b>Hide 'note-less' elements</b>	Exclude all elements without notes from the documentation.
<b>Diagram Format</b>	Set the diagram format for the images included within the documentation to either Metafile or Bitmap.
<b>Skip root package</b>	Exclude the parent package from the documentation and include only the child packages.

Option	Use to
<b>No bookmarks</b>	Stop RTF bookmarks being inserted into the generated document.
<b>Adjust Heading Levels</b>	<p>Enable the RTF Generator to automatically restrict the levels of heading generated for nested sub-packages in a document.</p> <p>The generator reproduces heading levels down to the value you set. For example, if you have four nested levels of sub-packages and you set this field to:</p> <ul style="list-style-type: none"> <li>• <b>Heading 2</b>, all sub-packages in the report are documented under level 2 headings.</li> <li>• <b>Heading 4</b>, the first level of subpackages are documented under level 2 headings, the next level under level 3 headings, and the remainder all under level 4 headings.</li> <li>• <b>Heading 6</b>, the first level of subpackages are documented under level 2 headings, the next level under level 3 headings, the next under level 4 headings, and the next under level 5 headings. If you added further levels of sub-package they would all be documented under level 6 headings.</li> </ul> <p>The field defaults to <b>Heading 9</b> to accommodate the maximum number of levels of nested subpackages.</p>
<b>Hide &lt;Anonymous&gt; elements</b>	Hide anonymous elements in the documentation.
<b>Use style defined in template for notes</b>	<p>Change where the style definition for Notes is drawn from, so that you use the style for notes that is defined in your template, instead of the RTF style applied in the element <b>Notes</b> field.</p> <p>If you use this option, you should have a style for notes defined in your template, otherwise the Notes text is printed in the default font with no formatting.</p>
<b>Disable large OLE file support</b>	Disable support for large Object Linking and Embedding (OLE) files.
<b>Insert page breaks when generating a Master Document</b>	Insert a page break after each <a href="#">Model Document in a Master Document</a> <sup>[1616]</sup> .
<b>Switch generator</b>	<p>Switch from this <b>Generate RTF Documentation</b> dialog (the Enhanced Template Driven Generator) to the <a href="#">Rich Text Format Report dialog</a> <sup>[1628]</sup> (Legacy Generator).</p> <p><b>Note:</b></p> <p>This button is not available if you displayed the dialog from the <b>Element List</b> or <b>Model Search</b>.</p>

The **Document Options** dialog provides both sets of options, except for:

- The **Switch generator** button
- The **Disable large OLE file support** option
- The **Insert page breaks when generating a Master Document** option.

The dialog also contains the **Optimize for Open Office** option, as described for the [Generate RTF Documentation](#) <sup>[1573]</sup> dialog, and tabs for setting [Element Filters](#) <sup>[1611]</sup> and [Other Filters](#) <sup>[1612]</sup>.

Click on the **OK** button to save your changes.

### 10.1.1.8 Element Filters

The **Element Filters** tab enables you to define a set of filters to restrict your report to specific elements. If an element does not have the defined characteristic, it is not reported.

As with the **Document Options** tabs, you can access the filter details from two different places; the start point affects the persistence of the filter definition.

1. If you define the filters on the **Element Filters** tab of the **Generate RTF Documentation** <sup>[1573]</sup> dialog, you can create filter settings for the current report to be run. Selections are non-persistent, and are reset when you close the dialog or select a different template.
2. If you access the filter definitions by clicking on the **File | Document Options** <sup>[1588]</sup> menu option on the **RTF Style Template Editor** <sup>[1578]</sup> dialog, the settings are saved with the template as the default settings for any run of this report.

You add filters by clicking on the **Add Filters** <sup>[1242]</sup> button. To edit the filters, either double-click on the panel contents or click on the **Edit Filter** button, to display the **Edit Filters** dialog. The format is the element field name, the conditions placed on the field value, any actual value or delimiting value to search on, and whether the filter item is required (mandatory).

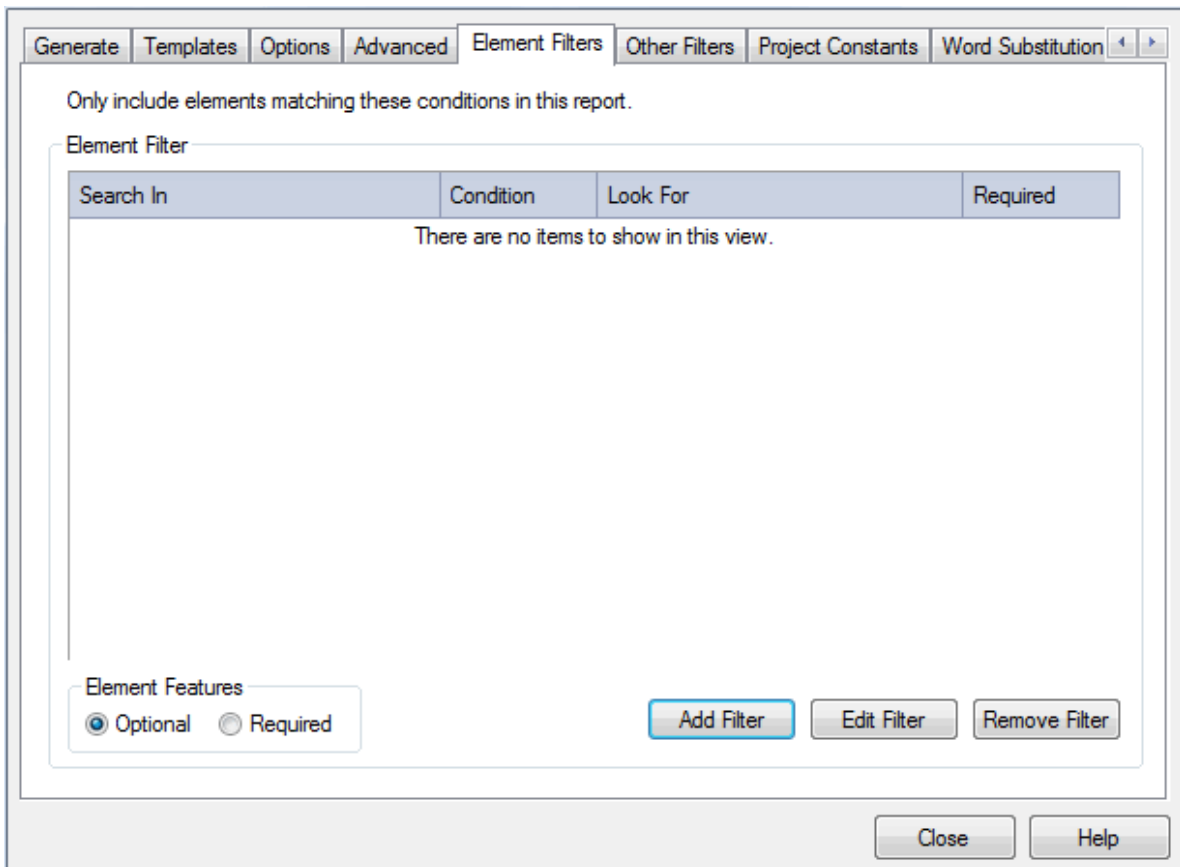

The fields and options on this dialog are described below.

Column/Button	Use to
<b>Search In</b>	Select the type and name of each element field to search on.
<b>Condition</b> <sup>[1243]</sup>	Select the condition of the search parameter. The available options are <b>Contains</b> , <b>Equal To</b> , <b>Not Equals</b> and <b>One Of</b> .
<b>Look For</b> <sup>[1243]</sup>	Specify the search term to perform the conditional search on. This value can pertain to the selected element field. For example, the value could be a date for <i>DateCreated</i> or a text value for other fields. The search term can contain multiple values, separated by commas.

Column/Button	Use to
<b>Required</b>	<p>Indicate that the search results must include elements with your search term in that field. You select these checkboxes on the <a href="#">Add Filters</a><sup>[1242]</sup> dialog</p> <p><b>Important:</b></p> <p>The fields listed as filters have an OR relationship when no <b>Required</b> checkboxes are selected; that is, if the search term is found in any one of those fields, then the element is displayed.</p> <p>Any field having the <b>Required</b> checkbox ticked overrides fields where the <b>Required</b> checkbox is not ticked.</p>
<b>Element Features</b> - Optional - Required	<p>Specify whether element features are optional or required. These appear as a new branch underneath the root element term in the <b>Search In</b> column.</p> <p>If you scroll down the <b>Search In</b> column, you see sub-branches such as <i>Attribute</i>, <i>Change</i> and <i>Custom Property</i>. These are the element features.</p> <p>You can add these features by clicking on the <b>Add Filter</b> button. The <b>Add Filters</b> dialog displays, with a list of all the filters you can choose for an element or element feature. Click on the <b>Search On</b> drop-down arrow to see a list of the element features you can search on. Each feature has its own set of filters such as <i>Name</i>, <i>Notes</i> and <i>Alias</i>, which you can add to your search. To search on an element attribute name, you would add the <i>Attribute</i> feature with a <i>Name</i> filter to your search.</p> <p>The <b>Optional</b> radio button enables you to generate a list of elements that meet <i>one</i> of the element features (<i>Element Type = Object</i>), or one of the feature filters (<i>Attribute Name = Class1</i>). For example, if your search is:</p> <p><i>Element Name = Class11, Attribute Name = m_Att1 or Scope = Public</i></p> <p>the search results would list all the elements that have the <i>name</i> of <i>Class11</i> and all the elements that have an <i>Attribute Name</i> of <i>m_Att1</i> or a <i>Scope</i> of <i>Public</i>.</p> <p>The <b>Required</b> radio button enables you to generate a list of elements that <i>must</i> have the element features you have added. For example, if your search is:</p> <p><i>Element Name = Class, Attribute Name = m_Att1 or Scope = Public</i></p> <p>you would get elements that must have the <i>name</i> of <i>Class</i> AND an <i>Attribute</i> with a name of <i>m_att1</i> or a <i>Scope</i> of <i>Public</i>.</p>
<b>Add Filter</b>	<a href="#">Add a new set</a> <sup>[1242]</sup> of parameters to filter the search on.
<b>Edit Filter</b>	Open the <b>Edit Filters</b> dialog, which enables you to change the search parameters.
<b>Remove Filter</b>	Remove the selected filter from the search.

### 10.1.1.9 Other Filters

The **Other Filters** tab enables you to define a set of filters to restrict your report to specific features of elements (sub-element components such as attributes, responsibilities or constraints). If the feature does not have the defined characteristics, it is not reported for the element.

As with the **Document Options** tabs, you can access the filter details from two different places; the start point affects the persistence of the filter definition.

1. If you define the filters on the **Other Filters** tab of the [Generate RTF Documentation](#)<sup>[1573]</sup> dialog, you can create filter settings for the current report to be run. Selections are non-persistent, and are reset when you close the dialog or select a different template.
2. If you access the filter definitions by clicking on the [File | Document Options](#)<sup>[1588]</sup> menu option on the [RTF Style Template Editor](#)<sup>[1578]</sup> dialog, the settings are saved with the template as the default settings for any run of this report.



You add filters by clicking on the [Add Filters](#) button. To edit the filters, either double-click on the panel contents or click on the **Edit Filter** button, to display the **Edit Filters** dialog. The format is the feature field name, the conditions placed on the field value, the actual value or delimiting value to search on, and whether the filter item is required (mandatory).

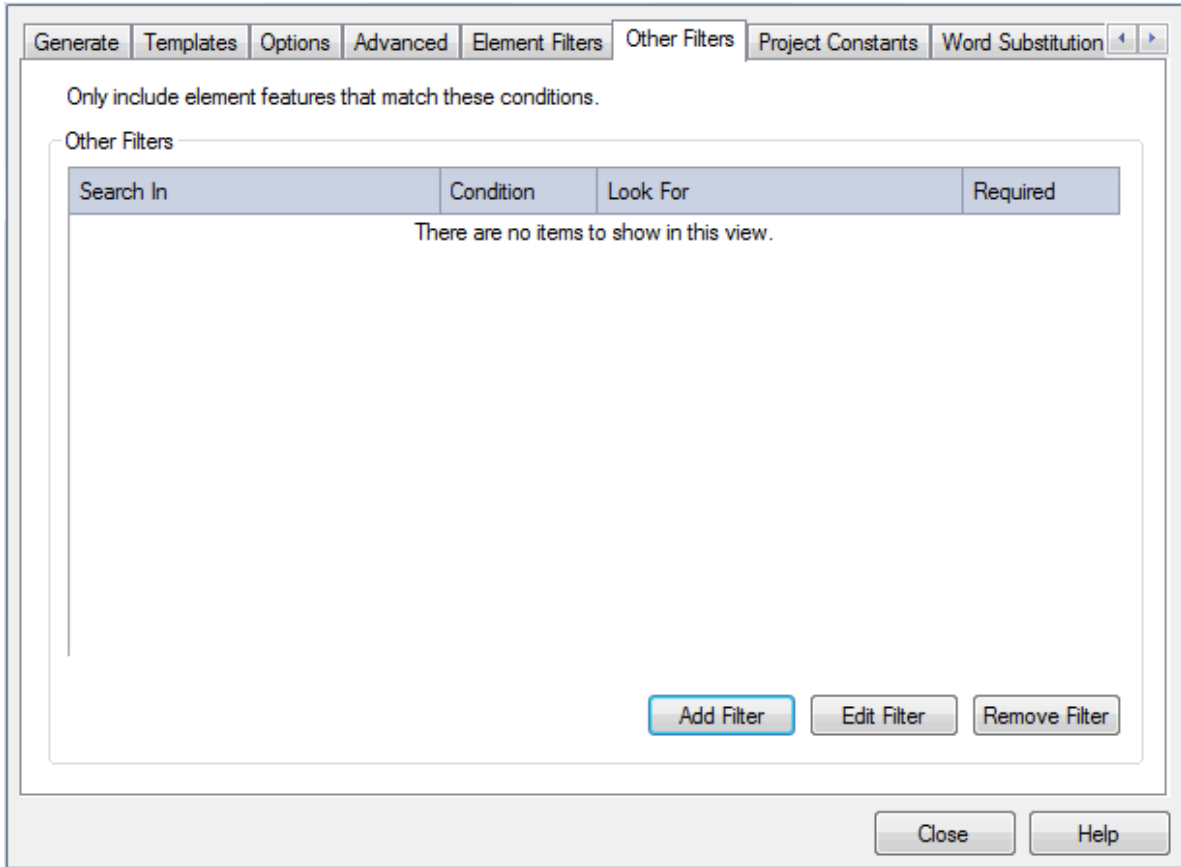

The fields and options on this dialog are described below.

Column/Button	Use to
<b>Search In</b>	Select the name of each feature field to search on.
<a href="#">Condition</a>	Select the condition of the search parameter. The available options are <b>Contains, Equal To, Not Equals</b> and <b>One Of</b> .
<a href="#">Look For</a>	Specify the search term to perform the conditional search on. This value can pertain to the selected field. For example, the value could be a date for <i>DateCreated</i> or a text value for other fields. The search term can contain multiple values, separated by commas.
<b>Required</b>	Indicate that the search results must include elements with your search term in that field. You select these checkboxes on the <a href="#">Add Filters</a> dialog.  <b>Important:</b> The fields listed as filters have an OR relationship when no <b>Required</b> checkboxes are selected; that is, if the search term is found in any one of those fields, then the element is displayed. Any field having the <b>Required</b> checkbox ticked overrides fields where the <b>Required</b> checkbox is not ticked.
<b>Add Filter</b>	<a href="#">Add a new set</a> of parameters to filter the search on.



### 10.1.1.11 Word Substitution

The **Word Substitution** tab of the **Generate RTF Documentation** dialog enables you to define translations of technical terms used in Enterprise Architect, in particular field names, into a language other than English for direct substitution into RTF documentation.

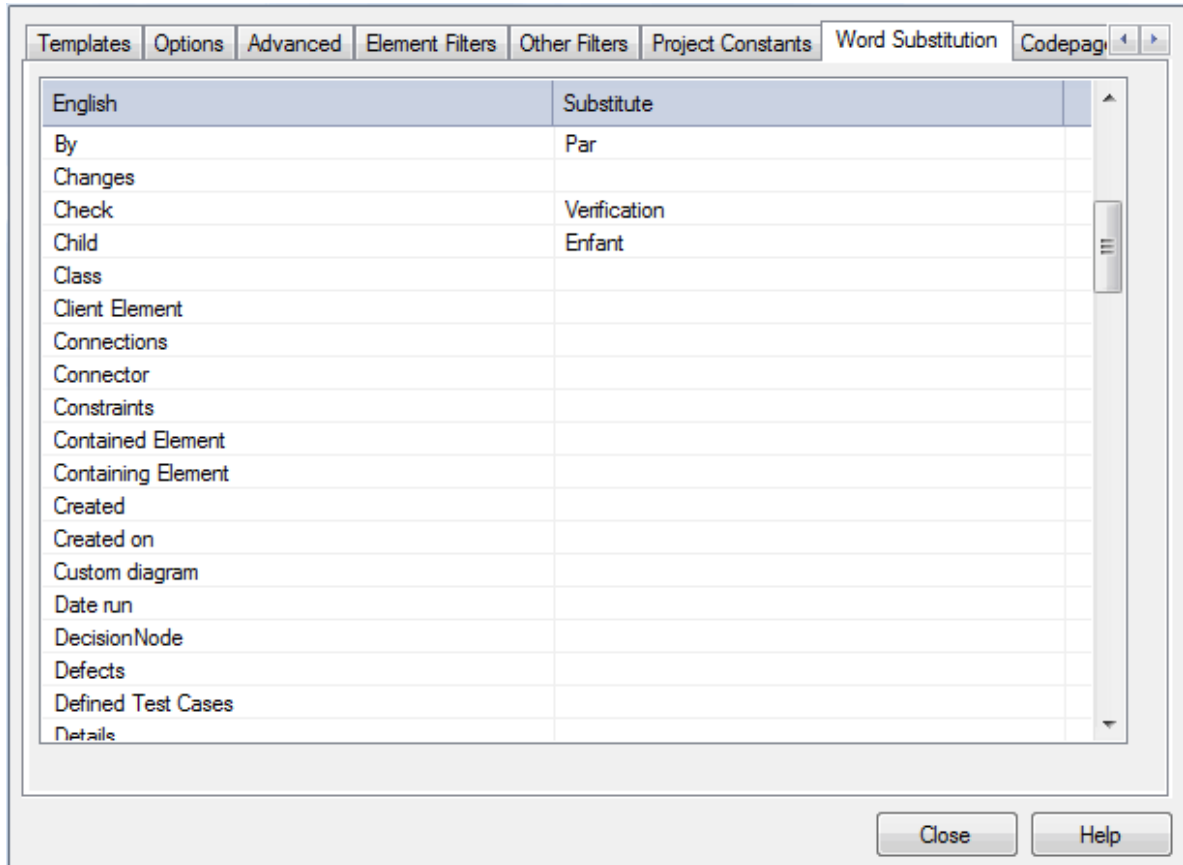

To add a translation for a term:

1. Double-click on the term in the **English** column in the **Word Substitution List**; the **Enter Value** field displays.

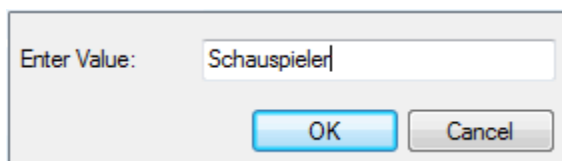

2. Type the foreign language translation in the **Enter Value** field, and click on the **OK** button.

### 10.1.1.12 Language Substitution

The **Codepage** tab of the **Generate RTF Documentation** dialog enables you to define languages other than English for direct substitution into RTF documentation.

If you export RTF-format documents from Enterprise Architect in languages other than English, you can customize the codepage, default language ID and character set that Enterprise Architect uses when generating RTF. This makes it much easier to generate documentation appropriate to your country or locale.

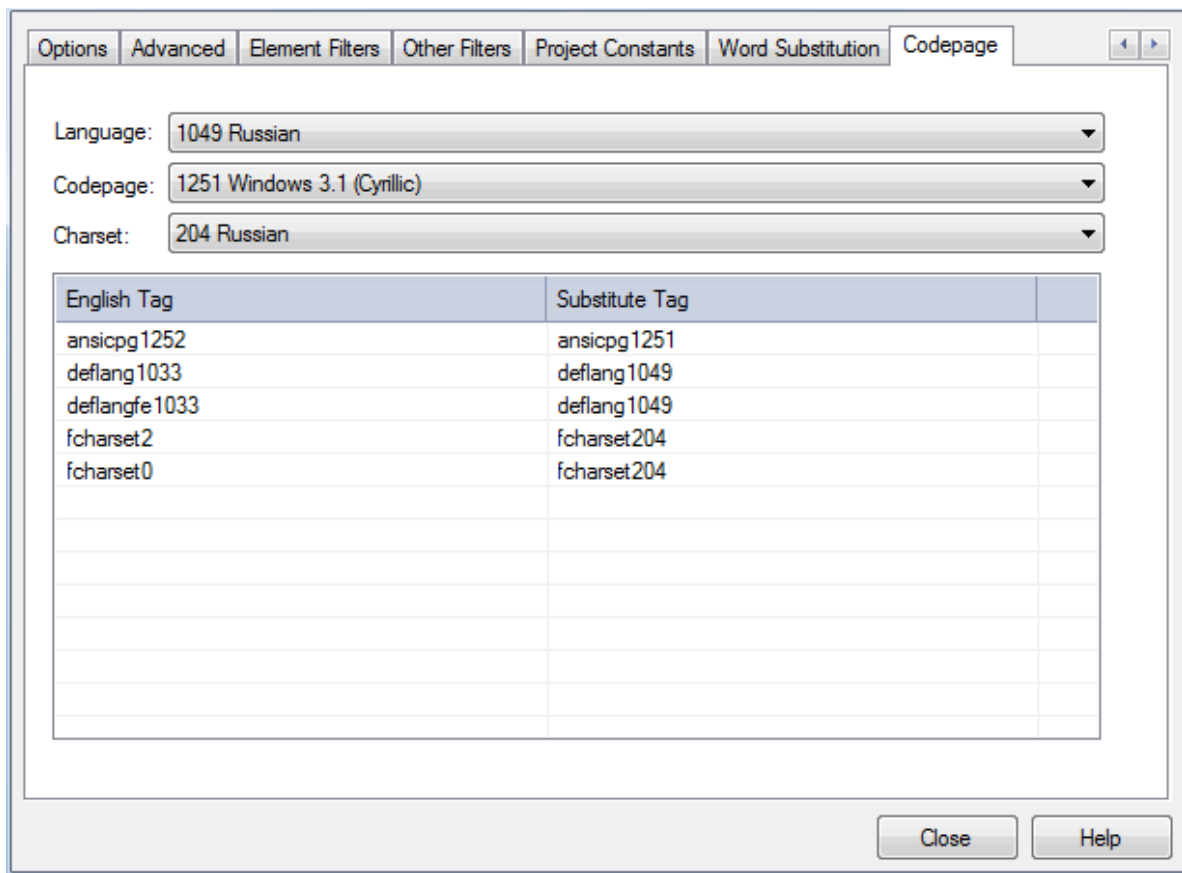

To define the language substitution, follow the steps below:

1. From the drop-down lists in the **Language**, **Codepage** and **Charset** fields, select the language, codepage and character set that most closely match your location.
2. If required, modify the **Substitute Tag** by double-clicking on each and manually setting the value (for advanced use only).
3. To clear the substitution list, double-click on each item in turn and delete the substitute value.

Now when you generate RTF documents, the substitute tags are used in the output.

**Note:**

You can transport these tag definitions between models, using the [Export Reference Data](#)<sup>[223]</sup> and [Import Reference Data](#)<sup>[225]</sup> options on the **Tools** menu.

### 10.1.2 Virtual Documents

*Virtual documents* enable you to structure and filter your RTF reports by selecting, grouping and ordering individual packages independent of the organization of the **Project Browser**. You can create separate virtual documents defining, say, Requirements, Use Cases or Design elements of a project, or you can combine these separate reports - retaining their own different formats - into a single generated document with common headers and footers and a central contents list. This combined document could apply your corporate standards.

You generate virtual documents in Enterprise Architect from individual [Model Document](#)<sup>[1619]</sup> elements. You can also, if required, combine several Model Documents under a [Master Document](#)<sup>[1618]</sup> package element.

Each Model Document element identifies its own template; for example, a specifically-designed Requirements template for a Requirements document, or a Use Case template for a section on Use Cases. The template is identified in a Tagged Value, and defines the content as **either**:

- A list of packages (defined as attributes) in whatever order or combination is most appropriate to your requirements - you can easily [add](#)<sup>[1620]</sup> or [delete](#)<sup>[1621]</sup> packages as necessary; **or**
- A standard model search (defined as Tagged Values) created within the [Model Search](#)<sup>[1235]</sup> facility - note

that diagram searches are not supported; when you generate the document, this search captures the required data throughout the model, and populates the document.

#### Notes:

- In a Model Document, you should not define both a list of packages and a search; if both are present, when you generate the document Enterprise Architect works from the package list only.
- You cannot use [RTF Bookmarking](#)<sup>[1639]</sup> in Master Document elements, which effectively replace RTF Bookmarking in Word.

RTF Bookmarking requires each bookmark to be unique. When you generate a report with a standard RTF template (including in a single Model Document element), each bookmark *is* unique and there is a 1:1 association between the Elements-details being generated and the elements in the repository. As Master Documents are intended to contain multiple sub-documents, the association ceases to be 1:1. There is no simple method that enables the generated data to be uniquely identified directly in association with the original element.

You can control the sequence in which information is presented in the document; see the [Document Order](#)<sup>[1622]</sup> topic.

#### Tip:

You can create as many Model Documents as required, for as many combinations of information as required.

The Master Document element contains its own template Tagged Value, which defines the headers, footers and central contents list. You can [import your corporate standards template](#)<sup>[1606]</sup> and edit the Tagged Value to identify that.

#### Tip:

The template in the Master Document overrides the templates in the Model Documents. For example, headers and footers in the Master Document template override any header and footer definitions in the Model Document templates. This enables you to apply consistent and continuous styles and page numbering throughout the report generated through the Master Document.

If you want the Model Documents to have their own styles, applied through their own RTFTemplate Tagged Values, either leave the Master Document RTFTemplate Tagged Value blank (for completely separate overall styles) or remove the definition of specific styles from the Master Document template.

## Document Elements

The Master Document and Model Document elements are available from the [Documentation](#) page of the [Toolbox](#); on the [Toolbox](#), select **More Tools | Documentation**. (This [Toolbox](#) page also provides the [Document Artifact](#)<sup>[819]</sup> element, used for linked documents.)

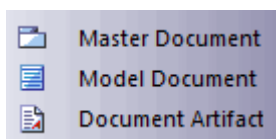

When you drag the Master Document and Model Document elements onto a diagram, the following symbols display, respectively:

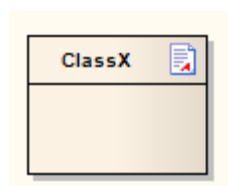
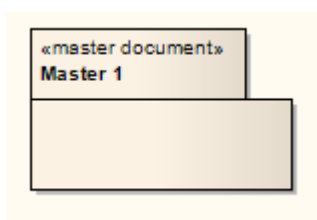

### 10.1.2.1 Create Master Document

Whilst you can create Model Document elements separately and generate individual documents from each one, you have added flexibility and scope if you organize Model Documents under a Master Document. You can generate a document with a [corporate template](#) <sup>[1606]</sup> for the covers, contents, headers and footers, whilst each section (generated from a separate Model Document) has its own appearance defined by a template appropriate to the section content.

To create a Master Document element, follow the steps below:

1. Open or create the diagram in which to create the Master Document.
2. In the **Toolbox**, select **More Tools | Documentation**.
3. Drag the *Master Document* icon onto the diagram. The system prompts you for the name of the Master Document.
4. Type the element name and click on the **OK** button. The system creates the Master Document element and a child Custom diagram of the same name.
5. Open the **Tagged Values** window (**View | Tagged Values**) and click on the Master Document element. The *RTFTemplate* Tagged Value displays in the window.

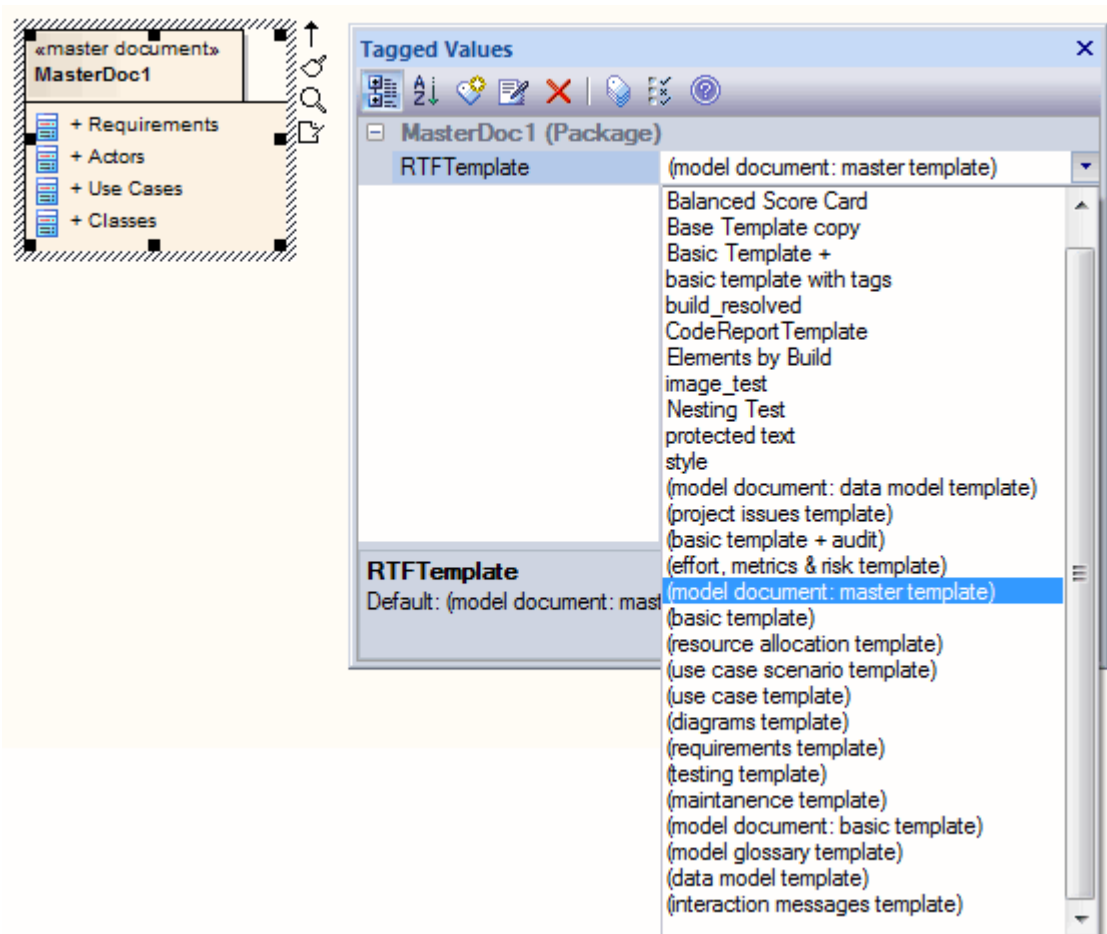

6. The *RTFTemplate* Tagged Value defaults to *(model document: master template)*. If you want to use an alternative master template, click on the drop down arrow at the right of the field and click on that template in the list.
7. Return to the **Project Browser** and open the Master Document child diagram.

At this point, you [create the Model Document](#) <sup>[1619]</sup> elements in the child diagram, to provide the content for the generated document.

When you have added all your Model Document elements to the Master Document diagram, the Master Document element resembles the following:

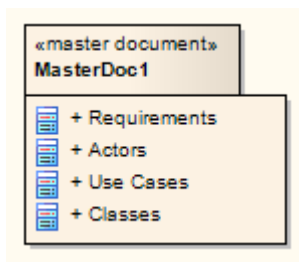

Your completed Master document element and child diagram display in the **Project Browser** as shown below:

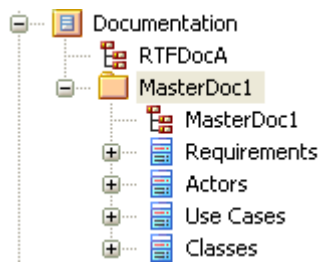

### 10.1.2.2 Create Model Document

You can create as many Model Document elements as are necessary to provide the sections of your generated document (under a Master Document) or to provide the independent documents you require.

To create a Model Document element, follow the steps below:

1. Open the [Master Document child diagram](#) <sup>[1618]</sup> or (if you are creating independent Model Documents) create a new diagram.

#### Tip:

The new diagram can live anywhere outside the packages you are adding to the document; you could create a Class diagram called Documentation within a specific Documentation package, and use this to hold the independent Model Document elements for your virtual documents.

2. From the **Documentation** page of the **Toolbox (More Tools | Documentation)** drag the *Model Document* icon onto the diagram to create a new Model Document element. Give the element an appropriate name: for example, if the documentation is relevant to the shopping cart requirements of a model, you could call it *ShoppingCartReqDocumentation*. Click on the **OK** button.
3. Open the **Tagged Values** window (**View | Tagged Values**) and click on the Model Document element. The *RTFTemplate*, *SearchName* and *SearchValue* Tagged Values display in the window.
4. Click on the drop-down arrow to the right of the **RTFTemplate** field, and click on the template to use for this Model Document.
5. If you are creating a list of packages for the Model Document, go now to [Add Packages to Model Document](#) <sup>[1620]</sup>. Otherwise, click on the drop-down arrow to the right of the **SearchName** field, and click on the model search type to populate this Model Document.

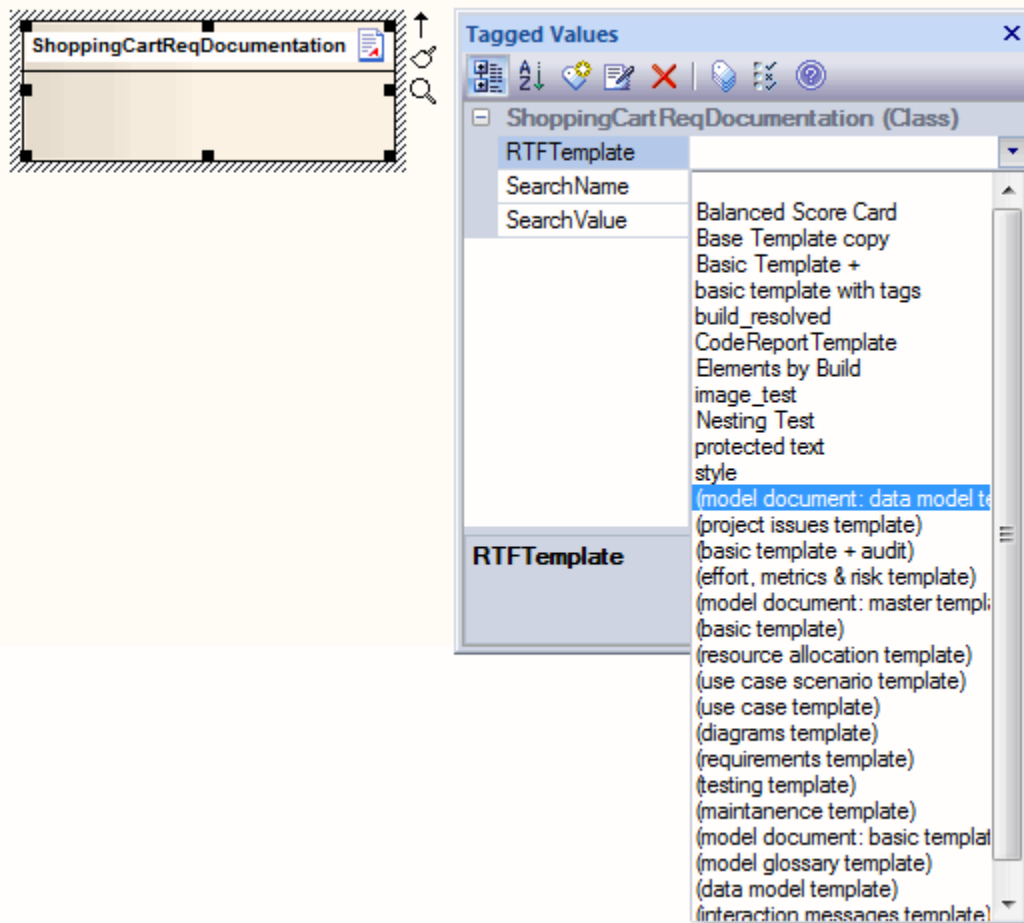
**Notes:**

- Diagram Searches are not supported.
- Custom SQL searches are supported if they are returning elements. The [SQL must include](#) `ea_guid AS CLASSGUID` and the *object type*.

6. If necessary, type a search term in the **SearchValue** field.
7. Create further Model Document elements as required.

Your Model Document element appears in the **Project Browser** with a Class icon, as shown below:

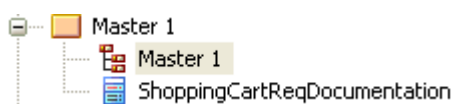

When you have created all the required Model Document elements, see the [Document Order](#) topic.

### 10.1.2.3 Add Packages to Model Document

To add packages to your Model Document element, follow the steps below. As the example Model Document element here is called *ShoppingCartDocumentation*, the steps indicate how to add shopping cart-related packages to the element.

1. Keeping the documentation diagram open, find a package in the **Project Browser** to add to the documentation. For example, a Resources package in a Dynamic view.
2. Drag and drop the package from the **Project Browser** onto the Model Document element as shown below:



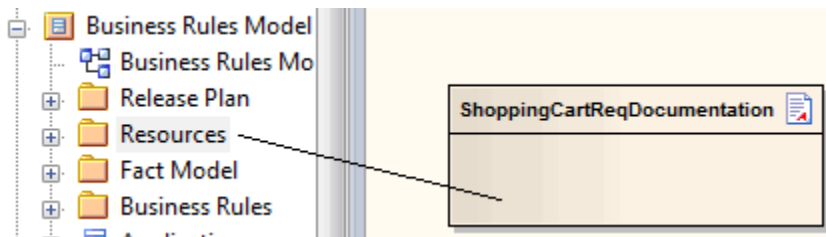

- The title of the package displays in the Model Document element in the *Attributes* compartment, as shown below:

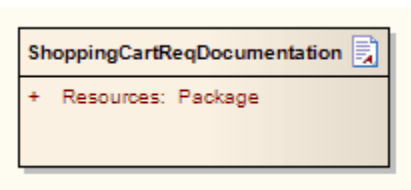

- This means that the Resources package is included in the document when you generate it. Using the above method, you can add as many packages from as many different views as required.

The next step is to [generate your document](#)<sup>[1623]</sup>, but consider the impact of your package list on the [Document Order](#)<sup>[1622]</sup>. You can also [delete packages](#)<sup>[1621]</sup> if required.

#### 10.1.2.4 Delete Package in Model Document

You can delete a package from your Model Document element.

This example includes four packages:

- Resources Package
- Activity Diagram Package
- View Cart Package
- Sequence Diagram Package.

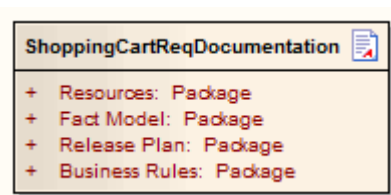

To delete a package from a Model Document element, follow the steps below:

- In the **Project Browser**, expand the element to list the package attributes.
- Right-click on the package to delete, and select the **Delete Attribute** context menu option.

Alternatively:

- In either the **Project Browser** or the diagram, right-click on the Model Document element and select the **Attributes** context menu option. The **Attributes** dialog displays.
- On the **Attributes** list, click on the package to delete.

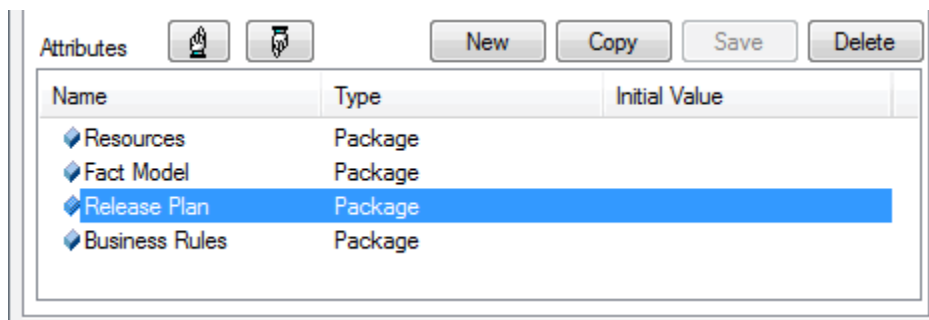

3. Click on the **Delete** button to remove the package from the document element.

### 10.1.2.5 Document Order

The order in which information is compiled into an RTF document depends on:

- The sequence of Model Document elements in a Master Document element
- Whether you define a Model Search in a Model Document element
- Whether you define a package list in a Model Document element.

When you have considered and, if necessary, amended the order in which information is compiled, you can [generate the document](#)<sup>[1623]</sup>.

### Model Document Sequence

When you generate a document from a Master Document element, the sequence in which the sections are generated is determined by the order in which the child Model Document elements are listed in the **Project Browser**. You can create elements anywhere in a diagram, therefore the generator refers to the **Project Browser** sequence.

If necessary, change the sequence using the green Up and Down arrows in the **Project Browser** toolbar to move an element up or down within the package.

### Model Search

A Model Search operates on the database, and accesses records in the order in which they are stored. This order depends on many factors, and can change with database maintenance. Therefore, the sequence of information provided by the search is unpredictable.

### Package Order

When you create a package list in a Model Document element, the sequence of information is determined by the order in which the package attributes are listed within the element. You can change the sequence using the **Attributes** dialog, and if you prefer a package to be in a different section of the document, you can move the attribute from one Model Document element to another. Both these procedures are described below.

### Change Sequence of Packages In List

To rearrange the order of packages in a Model Document element, refer to the example element and follow the steps below:

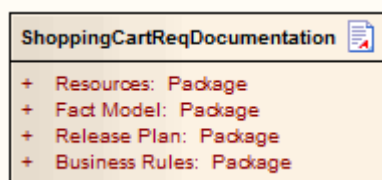

1. Right-click on the Model Document and select the **Attributes** option from the context menu. The **Attributes** dialog displays.
2. On the **Attributes** list, click on a package to move and click on the Up or Down (hand) buttons to change the order in which the packages are included in the documentation.

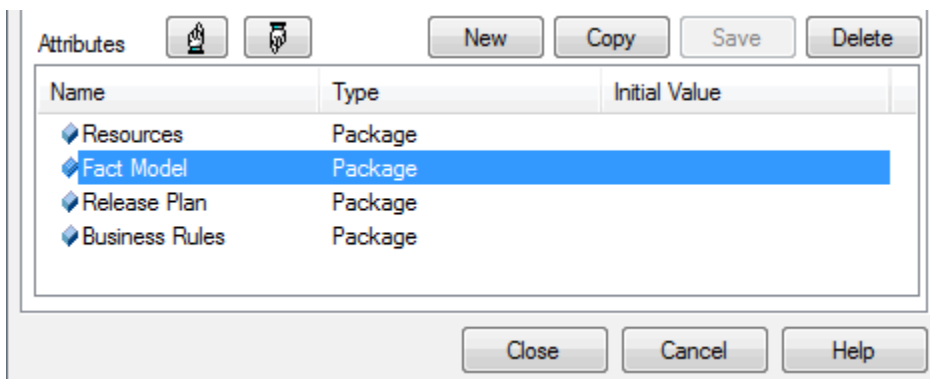

In this case, *Fact Model* is being moved to follow *Release Plan*.

- When you are satisfied with the order of your packages, click on the **Close** button.

### Move Package Between Elements

To move a package attribute from one Model Document to another, follow the steps below:

- Expand the Model Document elements in the **Project Browser**, so that both list their package attributes.
- Click-and-hold on the attribute to move, and drag it onto the name of the target Model Document element.
- Release the mouse button. The attribute is removed from the source element and added to the top of the list of attributes in the target element.
- If necessary, move the attribute down the attribute list, as described in *Change Sequence of Packages in List*, above.

#### 10.1.2.6 Section Numbering in Virtual Documents

Virtual documents can contain several sections based on separate templates. To ensure that section and subsection numbering continues sequentially through the sections, you can either use:

- The *MasterList* style from the [Normal.rtf](#) file (which is the default applied to all new templates, such as those used in each master Document and Model Document element); this provides a simple but consistent list numbering style that you can start off with. Alternatively, use:
- Your own numbering style.

If you design your own styles in the template used in each model document, each template must use the same [List Overrides](#) for section numbering. These have a unique ID, so to propagate the List Overrides across multiple templates, you must:

- Set up the common List Overrides in the *Normal.rtf* template (your own customized override list).
- Within each of the other templates used in the virtual document, using the template editor, select **File | Update Styles** to update the templates to include the common List Overrides.
- In each template use this common List Level for progressive numbering throughout the virtual document.

#### 10.1.2.7 Generate the Document

To generate the documentation defined in the Master Document and/or Model Documents, follow the steps below:

- On the documentation diagram, click on the Master Document element (or on an independent Model Document element).
- Select the **Element | Rich Text Format ( RTF) Report** menu option. The **Generate RTF Documentation** dialog displays.

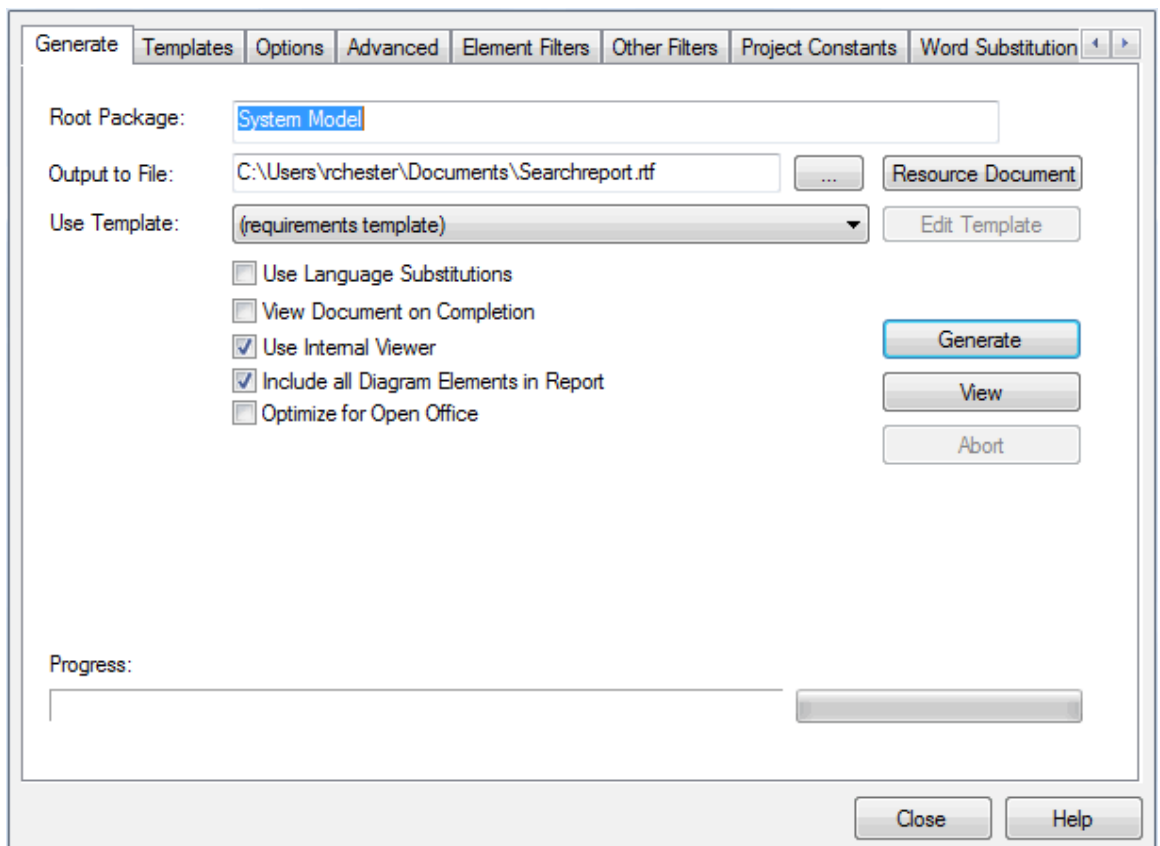

3. Set the options for your RTF document as required. See the [Generate RTF Documentation Dialog](#)<sup>[1573]</sup> and related topics for further information on these settings.
4. Click on the **Generate** button to create the documentation.
5. If you have not selected the **View Document on Completion** checkbox, click on the **View** button to view the documentation.

The RTF Report Generator works through the defined content of the Master Document element and/or the Model Document elements and pulls in the information from either the listed packages or the executed searches, formatted according to the templates identified in the *RTFTemplate* Tagged Value for each document element.

### 10.1.3 Other Documents

Enterprise Architect has other RTF based documentation that you can output:

- [Dependency Report](#)<sup>[1624]</sup>
- [Diagrams Only Report](#)<sup>[1625]</sup>
- [Implementation Report](#)<sup>[1626]</sup>
- [Resource Report](#)<sup>[318]</sup>
- [Testing Report](#)<sup>[1627]</sup>
- [Testing Details Report](#)<sup>[1549]</sup>

#### 10.1.3.1 Dependency Report

A *Dependency Report* shows, for the selected package, a list of any elements that are dependent on another element for their specification. For example, a Use Case derives its specification from the Requirement that it realizes. Each of the elements in the first column is the source or dependent in a [Dependency](#)<sup>[861]</sup> connector to the corresponding target element in the second column.

To view a Dependency report, follow the steps below:

1. In the **Project Browser**, right-click on the package to report on; the report includes all sub-packages of this package. The context menu displays.
2. Select the **Documentation | Dependency Report** menu option.

- The **Dependency Details** dialog displays, showing the results of the report. Save or print the results if required.

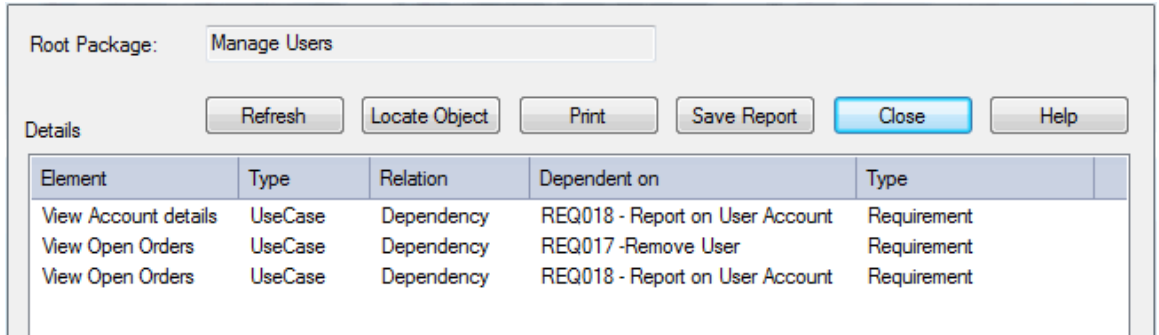

Option	Use to
<b>Root Package</b>	Confirm the root package. All elements and packages under this package appear in the report.
<b>Locate Object</b>	Locate the selected element in the <b>Project Browser</b> .
<b>Refresh</b>	Run the report again.
<b>Details</b>	List dependency details; lists the elements in the current package and the elements that they implement.
<b>Print</b>	Print the list.

### 10.1.3.2 Diagrams Only Report

You can also produce an RTF report that contains only the relevant diagrams from the target package. This is convenient for printing or handling a lot of diagrams in batch, rather than exporting or printing each one at a time.

#### To Produce a Diagrams Only Report

- Right-click on a package in the **Project Browser**. The context menu displays.
- Select the **Documentation | Diagrams Only Report** menu option. The **Export Diagrams to RTF Document** dialog displays.

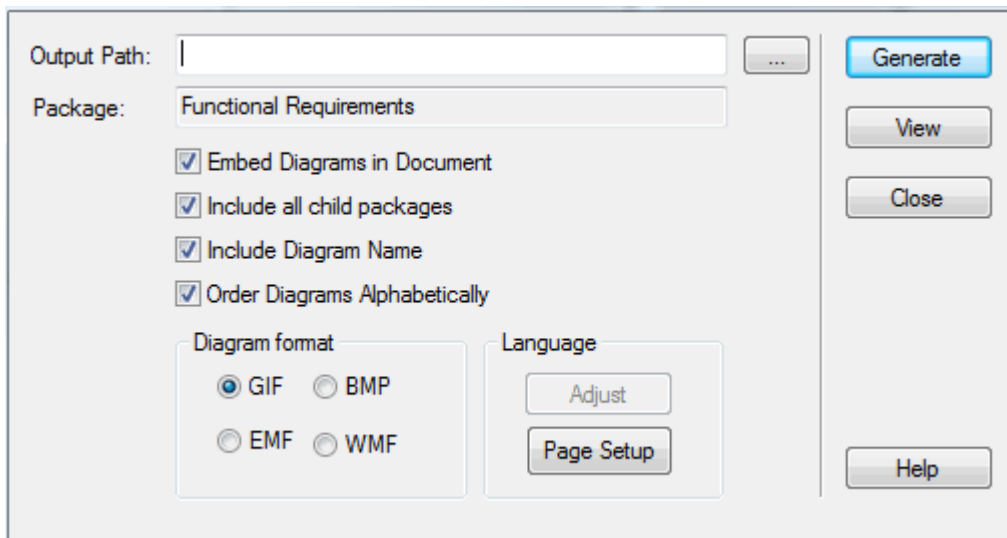

- In the **Output Path** field, type or browse for the output location to create the report in.

4. Select the options you require, as follows:
  - Select the **Embed Diagrams in Document** checkbox to ensure the diagrams are created within the RTF file, not as linked image files
  - Select the **Include all child packages** checkbox to document all of the diagrams included in any child package
  - Select the **Include Diagram Name** checkbox to include the diagram name within the generated documentation
  - Select the **Order Diagrams Alphabetically** checkbox to generate the documentation in alphabetical order.
5. Click on the **Generate** button to run the report.
6. When the report is generated, click on the **View** button to show the RTF output.

### 10.1.3.3 Implementation Report

An *Implementation report* lists, for a specified package, the elements that require implementers, together with any source elements in [Realize](#)<sup>[889]</sup> (Implements) relationships with those elements.

To view an Implementation report, follow the steps below:

1. In the **Project Browser**, right-click on the package to report on; the report includes all sub-packages of this package. The context menu displays.
2. Select the **Documentation | Implementation Report** menu option.
3. The **Implementation Details** dialog displays with the results for the package. Save or print the results if required.

Element	Type	Relation	Implementor	Implementor Type
REQ016 -Add Users	Requirem...	Realization	Create Account	UseCase
REQ025 - Store User Details	Requirem...	Realization	Create Account	UseCase
REQ011 - Manage User Ac...	Requirem...	Realization		
REQ026 - Validate User	Requirem...	Realization	Login	UseCase
REQ018 - Report on User A...	Requirem...	Realization	View Open Orders	UseCase

Option	Use to
<b>Root Package</b>	Confirm the root package. All elements and packages under this package appear in the report.
<b>Show Unimplemented</b>	Show non-implemented elements. Non-implemented elements are those that don't have any other element to realize them (for example, a Use Case has no Component or Class to implement the Use Case behavior).
<b>Show Implemented</b>	Show implemented elements. These are elements that do have some element associated with them in a Realization relationship. For example a Use Case has a Component that implements it.
<b>Locate Object</b>	Locate the selected element in the <b>Project Browser</b> .
<b>Refresh List</b>	Run the report again.
<b>Details</b>	List elements in the current hierarchy and elements that implement them.
<b>Print</b>	Print the list.
<b>Set Target Types</b>	Set the list of types to report on. By default Enterprise Architect only reports on a limited number of element types, such as Use Cases and Requirements. For

Option	Use to
	further information see the <a href="#">Set Target Types Dialog</a> <sup>1627</sup> topic.

### 10.1.3.3.1 Set Target Types Dialog

The **Set Target Types** dialog is accessed by clicking on the **Set Target Types** button on the **Implementation** dialog. This dialog enables you to set the types of elements that appear in the report as requiring implementation. Double-click on an element in either list to move it to the other list.

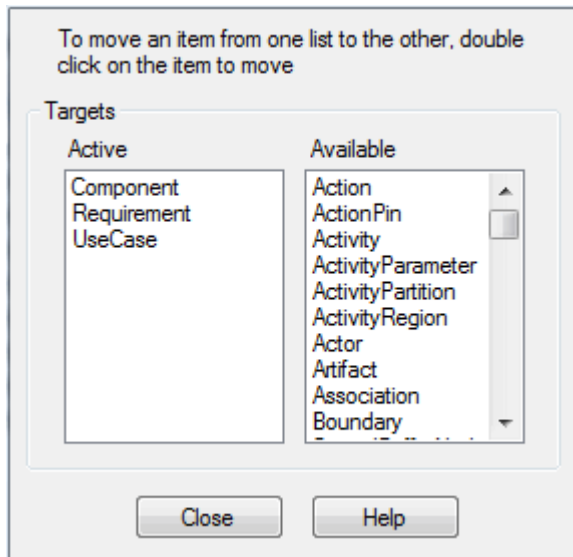

### 10.1.3.4 Testing Report

To view a testing report, follow the steps below:

1. In the **Project Browser**, right-click on the package to report on (you can configure the report to include all sub-packages as well) to open the context menu.
2. Select the **Documentation | Testing Report** menu option.
3. The **Generate Test Documentation** dialog specifies which test types are documented in the report, and the output file location. You can also select the **Include child packages** checkbox to report on all child packages of the selected package. The test data originates in the docked testing window, where tests are created and attached to the respective object.

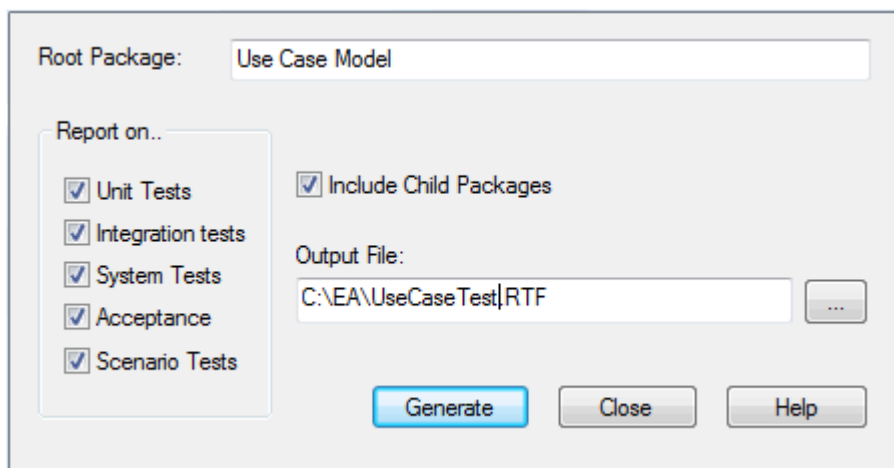

### 10.1.4 The Legacy RTF Report Generator

#### Note:

The Legacy Generator is available if you have RTF templates created in releases of Enterprise Architect prior to 4.1, and you prefer to generate RTF reports using the original generator. However, as you can generate reports from these templates using the post-Enterprise Architect 4.1 RTF Generator, the Legacy Generator and instructions for its use are no longer updated.

However, reports produced using the Legacy RTF Generator do reflect the [Notes](#)<sup>[642]</sup> formatting feature in any text associated with elements.

Creating a Rich Text Format (RTF) document is a simple and flexible process. An RTF document is based on a package or an element in your project (more usually a package). To produce a document, you select the package or element to report on in the [Project Browser](#), [Element List](#) or [Model Search](#), then press **[F8]** to display the [Generate RTF Documentation dialog](#).<sup>[1573]</sup> On the **Advanced** tab, click on the **Switch generator** button to access the Legacy [Rich Text Format Report](#) dialog.

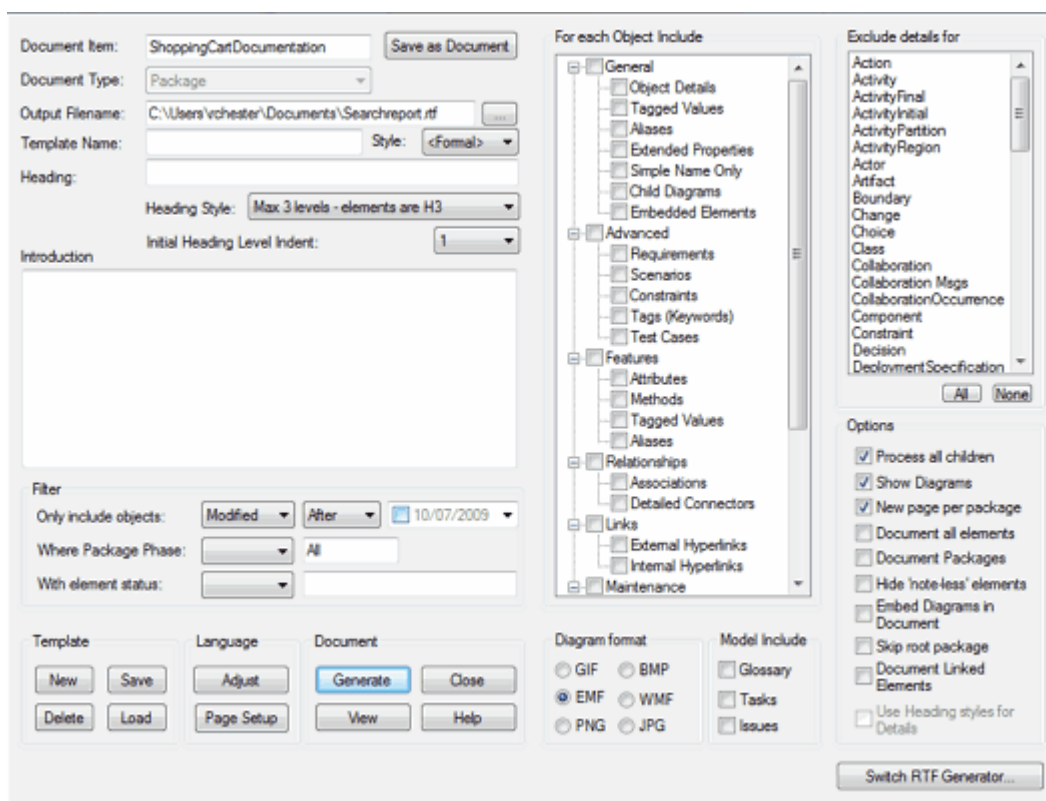

The [Rich Text Format Report](#) dialog enables you to set the exact contents and look and feel of your report. You enter the file name of the report, a heading, additional notes, template name (for saving the set-up) and other options. You can also select the style of the report; either plain or formal.

Optionally, you can set up a filter, the details to include, element types to exclude, whether to process child packages, whether to show diagrams and the diagram format.

You can switch back to the [Generate RTF Documentation](#) dialog by clicking on the **Switch RTF Generator** button.

#### Note:

The [Rich Text Format Report](#) dialog panels are individually described in the subsequent topics of this section (listed below). The dialog has a lot of options; get to know them all to produce output at the level of detail suited to your project.

- [Document a Single Element](#)<sup>[1629]</sup>
- [Set the Main RTF Properties](#)<sup>[1629]</sup>



- [Apply a Filter](#) <sup>[1630]</sup>
- [Exclude Elements](#) <sup>[1630]</sup>
- [RTF Diagram Format](#) <sup>[1631]</sup>
- [Model Include](#) <sup>[1631]</sup>
- [RTF Report Options](#) <sup>[1632]</sup>
- [RTF Report Selections](#) <sup>[1633]</sup>
- [Generate the Report](#) <sup>[1634]</sup>
- [Diagrams Only Report](#) <sup>[1625]</sup>
- [Report Templates](#) <sup>[1634]</sup>
- [Include or Exclude a Package from Report](#) <sup>[1573]</sup>
- [Save as Document](#) <sup>[1635]</sup>

#### 10.1.4.1 Document a Single Element

RTF documentation can also be generated for a single element.

Select the element to generate the documentation for, and then select the **Element | Rich Text Format (RTF) Report** menu option. The [Generate RTF Documentation dialog](#) <sup>[1573]</sup> displays.

Click on the **Switch Generator** button to display the **Rich Text Format Report** dialog. See [The Legacy RTF Report Generator](#) <sup>[1628]</sup> and its related topics for further information.

#### 10.1.4.2 Set the Main RTF Properties

The main section of the **Rich Text Format Report** dialog enables you to set the output location and appearance of the final RTF document.

#### Setting Options for the RTF Document

1. Open the **Rich Text Format Report** dialog (see [The Legacy RTF Report Generator](#) <sup>[1628]</sup> topic for how to do this). The main section of this dialog is shown below.

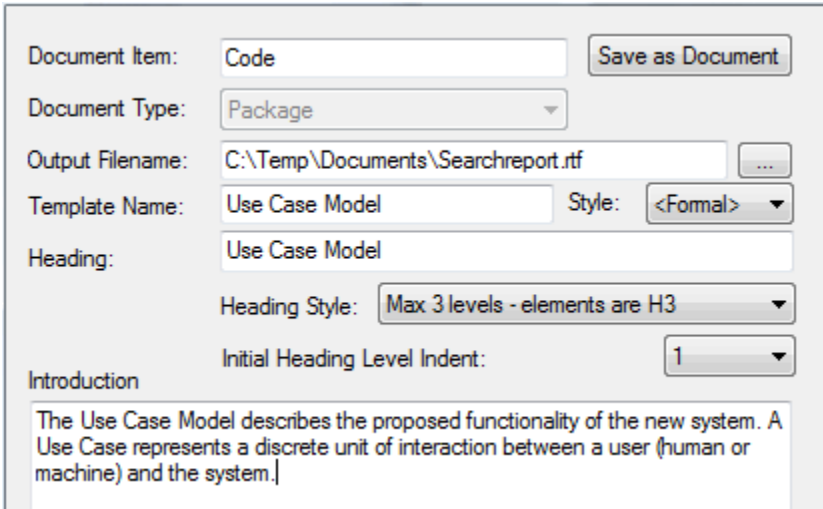

Document Item: Code Save as Document

Document Type: Package

Output Filename: C:\Temp\Documents\Searchreport.rtf ...

Template Name: Use Case Model Style: <Formal>

Heading: Use Case Model

Heading Style: Max 3 levels - elements are H3

Initial Heading Level Indent: 1

Introduction

The Use Case Model describes the proposed functionality of the new system. A Use Case represents a discrete unit of interaction between a user (human or machine) and the system.]

2. Supply an **Output Filename** to save the report into; always include the extension .RTF as part of the filename.
3. Provide a **Template Name** to save this report set-up.
4. Select a report **Style**: Formal or Basic.
5. Type a **Heading** for your report; this appears as the first heading item in your output.
6. Select your required **Heading Style** and **Initial Heading Level Indent** from the drop-down lists.

**Note:**

It is recommended that you enter a full path name for your report. The images in your report are saved externally in an images directory, and supplying the full directory path avoids confusion over the location of these images. Also, if you move your report you must also move the images directory.

### 10.1.4.3 Apply a Filter

You can apply a filter on the **Rich Text Format Report** dialog to include or exclude elements by date modified, phase or status. This helps to track changes and break a document into multiple delivery phases.

Open the **Rich Text Format Report** dialog (see [The Legacy RTF Report Generator](#)<sup>[1628]</sup> for how to do this). The **Filter** section of this dialog is shown below.

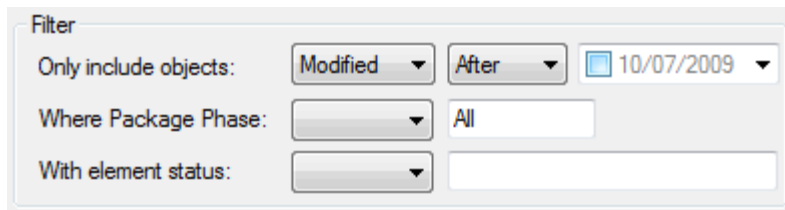

- To enable the date filter, select the checkbox in the date field.
- In the first two **Only include objects** fields, click on the drop-down arrows and select the appropriate criteria (**Modified/Created, Before/After**).
- The package phase filter applies at the package level (not the element level) and ignores the phase of the root package that you are documenting. To enable the phase filter, in the **Where Package Phase** field click on the drop-down arrow and select an operator; Enterprise Architect filters out all packages that do not meet the selection criteria. All elements in the package are ignored, regardless of their individual phase.
- The element status filter enables you to limit the output by element status. Unlike the package phase filter, this filter applies to every element. You can filter against a status of *like* or *unlike* a criterion, for example, *like proposed*, or against the *in* and *not in* operators, such as *in approved*, *not in validated*. When using the *in* and *not in* operators, enter a comma-separated list of status types as your criteria expression.

### 10.1.4.4 Exclude Elements

The **Rich Text Format Report** dialog enables you to exclude elements of any type from your final output. This is useful when you want to highlight particular items and not clutter up a report with too much detail.

Open the **Rich Text Format Report** dialog (see [The Legacy RTF Report Generator](#)<sup>[1628]</sup> for how to do this). Look at the **Exclude details for** panel on the right of the dialog.

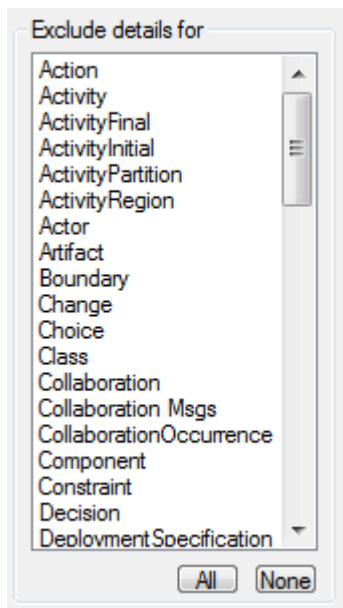

Click on each element to exclude, or click on the **All** button to exclude all elements. Click on the **None** button to clear your selections.

#### 10.1.4.5 RTF Diagram Format

You can output diagrams to Bitmap files, GIF files or Windows Metafiles.

Open the **Rich Text Format Report** dialog (see [The Legacy RTF Report Generator](#)<sup>[1628]</sup> for how to do this). In the **Diagram format** panel (bottom center of the dialog) select the required format for the report.

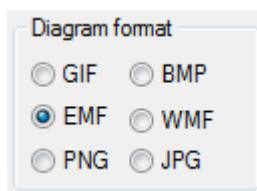

- Bitmap files are raster images with a high level of detail but large size; they do not scale up or down very well
- GIF files are raster images with reasonable detail and small size; they scale a little better than bitmaps
- Metafiles are vector images with high detail and small size (but can have compatibility problems with some printers or software); metafiles scale very well
- PNG files are raster images with reasonable level of detail and smaller file sizes than GIF
- JPEG are lossy raster images with average levels of detail, they do not work very well with line drawings and lose clarity when re sized; JPEG file sizes are typically very small.

#### Note:

Generally metafiles are the best option, although it sometimes pays to experiment.

#### 10.1.4.6 Model Include

The **Model Include** panel of the **Rich Text Format Report** dialog has the following options:

- **Glossary** to include the [project glossary](#)<sup>[323]</sup>
- **Tasks** to include [project tasks](#)<sup>[329]</sup>
- **Issues** to include [project issues](#)<sup>[331]</sup>.

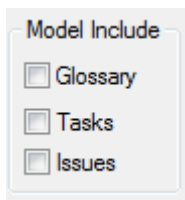

Select the appropriate checkbox to include the items in the generated RTF documentation.

#### 10.1.4.7 RTF Report Options

Additional RTF report options you can select from the **Options** panel on the **Rich Text Format Report** dialog are shown below.

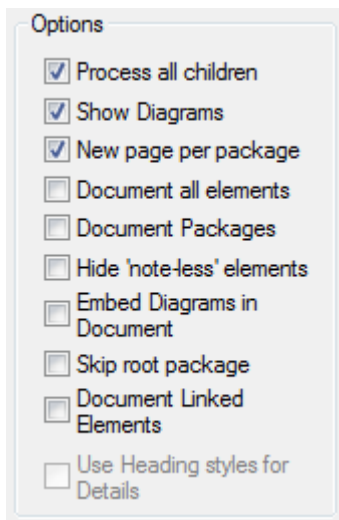

You can select whether or not to recursively document packages, show diagrams or add a page break before each new package. Select the:

- **Process all Children** checkbox to recursively process all child packages within the main package
- **Show Diagrams** checkbox to include diagrams in your document. Clear this item for no diagrams
- **New page per package** checkbox to force a page break on each new package (excepting empty packages)
- **Document all elements** checkbox to include all elements included in the project
- **Document Packages** checkbox to document the package as an element in addition to the documentation that would normally be produced for package documentation
- **Hide 'note-less' elements** checkbox to exclude all elements without notes from the documentation
- **Embed Diagrams in Document** checkbox to ensure that the diagram images are contained within the RTF document rather than stored in a linked external file
- **Skip root package** checkbox to exclude the parent package from the documentation and include only the child packages
- **Document Linked Elements** checkbox to include the object details for linked elements that do not originate from the selected package
- **Use Heading styles for Details** checkbox to ensure that the details are formatted as heading styles rather than formatted text; this option is only available when the **Heading Style** field in the [Main section](#)<sup>[1629]</sup> of the **Rich Text Format Report** dialog is set to **Max 9 levels - elements are package + 1**.

### 10.1.4.8 RTF Report Selections

The **For each Object Include** section of the **Rich Text Format Report** dialog enables you to select the documentation sections to include in your report.

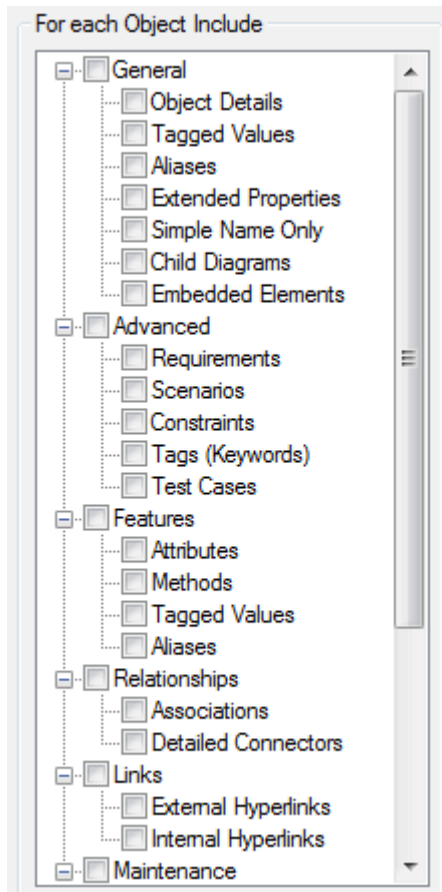

What you include or exclude governs how simple or detailed your report is. You can create multiple reports at different levels of detail for different audiences. Experiment with these options to see what effect inclusion or exclusion has. Most items are self-explanatory.

Selecting the checkbox against a category item in the list selects all of the options that are contained in the category. To expand a category, click on the + symbol next to the category name. To exercise greater control over a category of options expand the top level item and then select the required individual items from the list.

Sometimes an item applies only to a certain type of element; for example, **Attributes** only applies to Class elements and a few other element types. The **Child Diagrams** option shows or hides any diagrams that are attached under a model element; for example, a Use Case might have a Scenario diagram attached.

#### Note:

Use this feature to produce the right level of detail for your audience. Technical readers might want to see everything, whilst management might require only the general outline.

### 10.1.4.9 Generate the Report

Once you have set up the document properties as required, click on the **Generate** button to generate the report. When you have generated the document, click on the **View** button to open the report in MS Word.

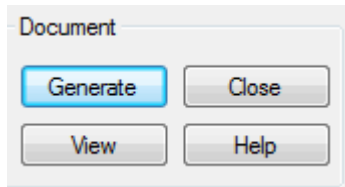

### 10.1.4.10 Legacy RTF Style Templates

The Legacy **RTF Style Editor** enables you to edit the RTF associated with various sections of the RTF Report facility in Enterprise Architect. You would typically use this functionality to customize a report's look and feel for your company or client.

#### Notes:

- The RTF Style Editor discussed here automatically displays when you modify or create a Legacy RTF template. If you select a template created in the enhanced [RTF Style Template Editor](#)<sup>[1578]</sup>, that editor opens automatically instead.
- You can transport these RTF templates between models, using the [Export Reference Data](#)<sup>[223]</sup> and [Import Reference Data](#)<sup>[225]</sup> options on the **Tools** menu.

If you have previously defined and saved a template, click on the **Load** button on the **Rich Text Format Report** dialog to open the list of defined templates. Select one in order to load it as the current template; all the features saved become the current features. This enables you to define a set of standard report types that streamline document production.

### Create or Edit RTF Style Templates

1. Select the **View | Other Project Tools | Resources** menu option to display the **Resources** window.
2. Expand the **Templates** folder.

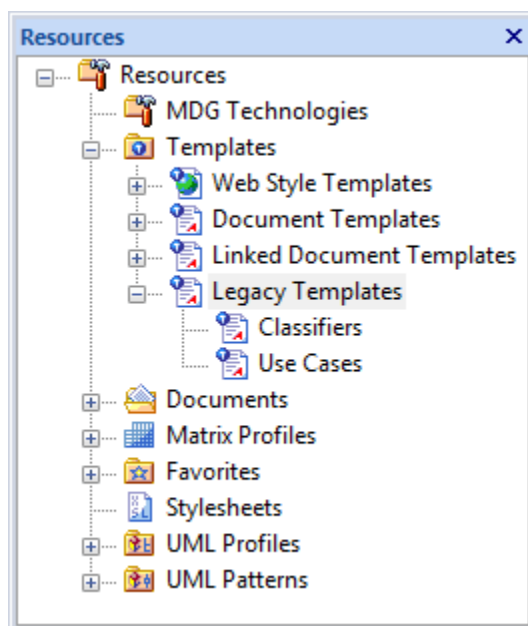

3. To edit an *existing* Legacy template, expand the **Legacy Templates** tree and double-click on the template name, or right-click and select the **Modify Document Template** context menu option. The **RTF Style Editor** displays. See [RTF Style Editor](#)<sup>[1638]</sup> for further details.

4. Alternatively, to create a *new* Legacy template, right-click on **Legacy Templates** and select the **Create RTF Style Template (Legacy)** context menu option. Enterprise Architect displays a prompt for the new template name.
5. Type the name of the new template and click on the **OK** button. The **RTF Style Editor** displays. See [RTF Style Editor](#)<sup>[1635]</sup> for further details.

**Tip:**

To delete a template, right-click on it and select the **Delete Document Template** context menu option.

**RTF Style Editor**

The **RTF Style Editor** contains a list of all available RTF fragments for modification and customization.

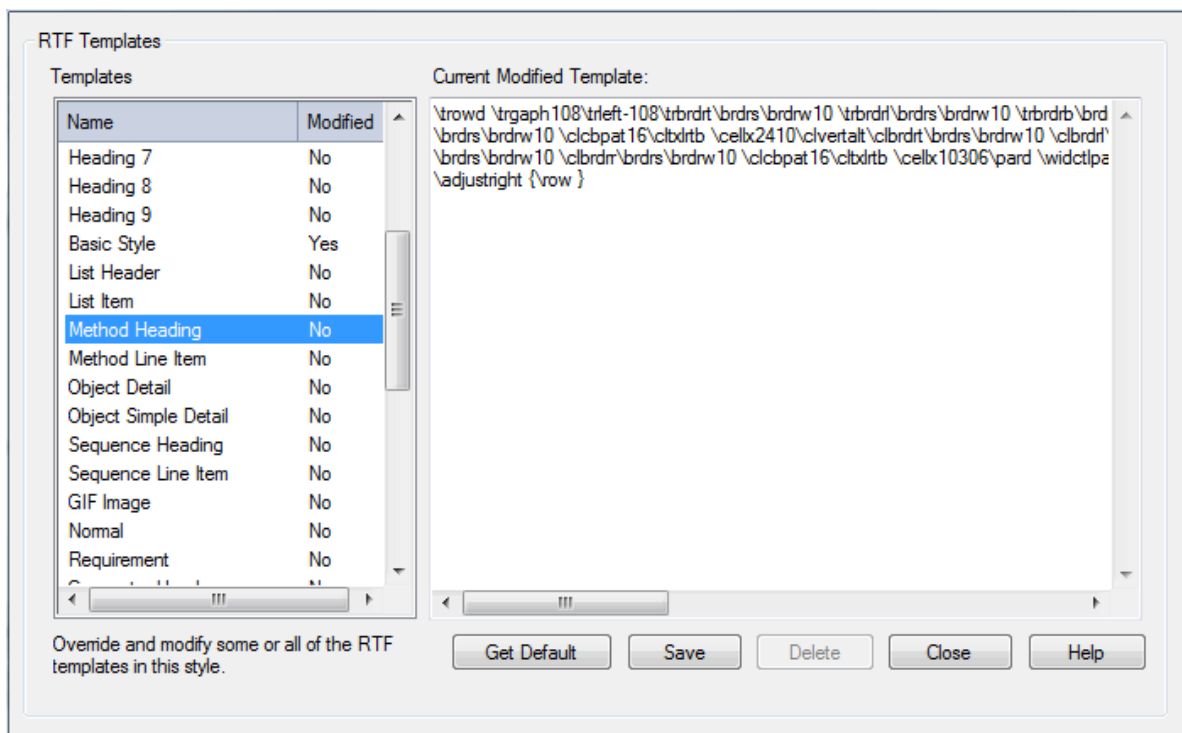

Each fragment typically contains RTF plus one or more special tag names that Enterprise Architect replaces with information during generation. Currently you cannot alter the content within the tag names, but you can omit a complete tag by removing it, or alter its basic display properties in the surrounding RTF.

Special tag names are delimited by # characters; for example, **#NOTES#**

Click on the:

- **Get Default** button to retrieve the default Enterprise Architect template for the currently-selected template item in the left hand list
- **Save** button to save the version of the template for this style only
- **Delete** button to remove your modified version of the template, which causes Enterprise Architect to use the default template during report generation.

To select a template during report generation, click on the **Style** drop-down arrow on the [Rich Text Format Report](#)<sup>[1628]</sup> dialog. Once a style is selected, Enterprise Architect applies that to the current report. Select **<Basic>** for the inbuilt style.

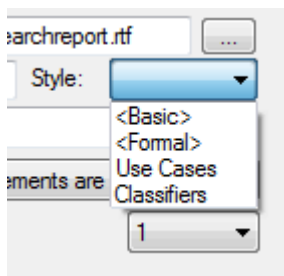
**Tip:**

You can also [alter the custom language settings](#)<sup>[1637]</sup>.

### 10.1.4.11 Save as Document

The *Document* feature enables a particular documentation configuration to be 'remembered', linking the loaded template within the **Rich Text Format Report** dialog to the current highlighted package. If a particular template is always used with a specific package, and multiple cases of documentation exist to be propagated, saving these as Documents can ease document generation later.

To create and use Documents, follow the steps below:

1. Open the **Rich Text Format Report** dialog (see [The Legacy RTF Report Generator](#)<sup>[1628]</sup> for instructions on how to do this).
2. Click on the **Save as Document** button. The **Save current as document definition** dialog displays:

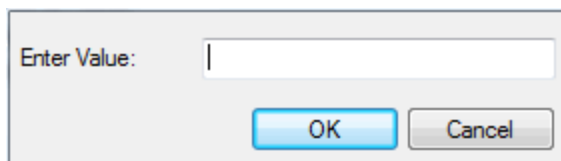

3. In the **Enter Value** field, type a name for the document and click on the **OK** button. The document is added to the **Resources** window for easy future access (as for the *usecasedoc* entry in the illustration below).

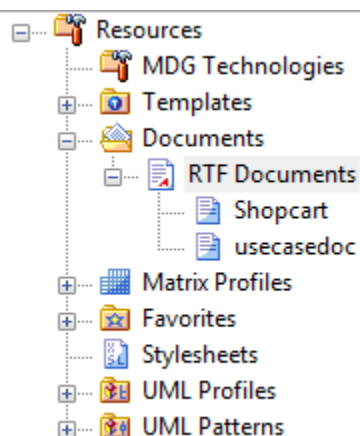

4. To generate documentation from the **Resources** window, right-click on the required document. The context menu displays.
5. Select the required option.

The context menu options are:

- **Open Document** - Opens the corresponding .RTF file, as specified by the RTF template *Filename* property
- **Generate Document** - Opens the **Rich Text Format Report** dialog, loaded with the specified template
- **Auto Generate Document** - Generates documentation, with the document located at the path specified by



the template's *Filename* property

- **Delete Document** - Removes the specified document.

#### 10.1.4.12 Custom Language Settings

If you export RTF-format documents from Enterprise Architect in languages other than English, you can customize the codepage, default language ID and character set that Enterprise Architect uses when generating RTF. This makes it much easier to generate documentation appropriate to your country or locale.

You can also set up a list of word substitutions. For instance, where Enterprise Architect would include the word *Figure*, you can specify another word to replace it that is either in your language or more meaningful to your readers.

#### To Set Up Substitutions

1. Open the **Rich Text Format Report** dialog (see [The Legacy RTF Report Generator](#)<sup>[1628]</sup> for how to do this).
2. In the **Language** panel (bottom left of dialog) click on the **Adjust** button. The **Customize RTF Language** dialog displays.

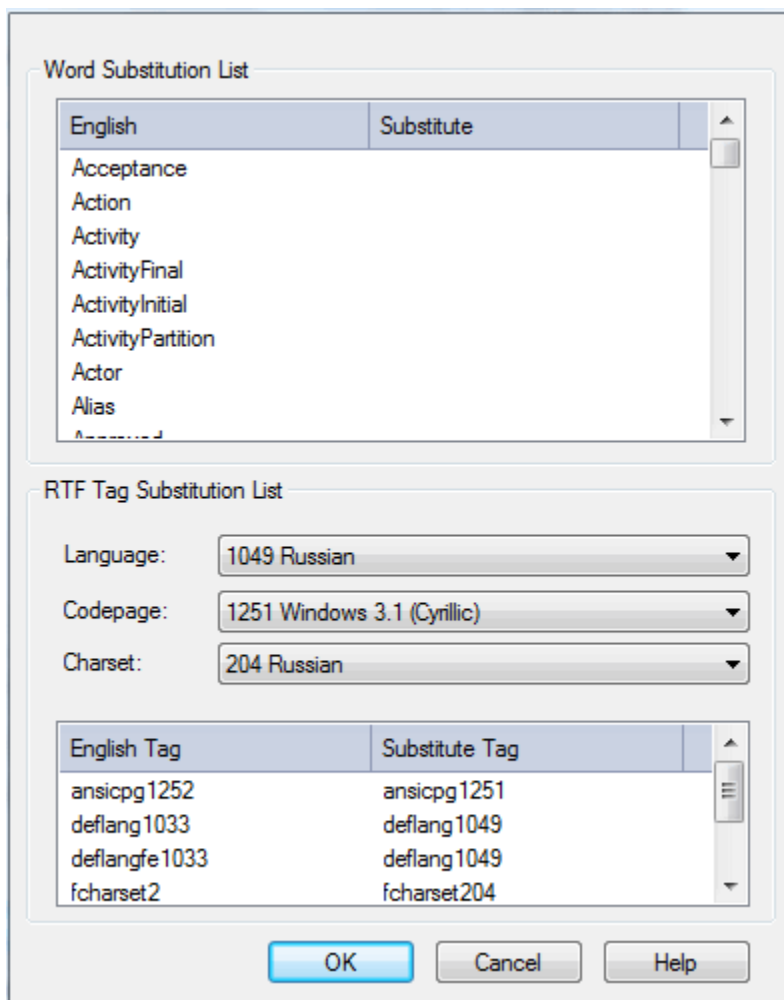

3. Double-click on an item to set or clear its **Substitute** word.
4. When you have finished, click on the **OK** button.

#### To Set Up Codepage and Character Set

1. From the drop-down lists in the **Language**, **Codepage** and **Charset** fields, select the language, codepage and character set that most closely match your location.
2. If required, modify the **Substitute Tags** by double-clicking on each and manually setting the value (for advanced use only).

3. To clear the substitution list, double-click on each item in turn and delete the substitute value.
4. When you have completed the settings, click on the **OK** button to save them.

Now when you generate RTF documents, the substitute tags are used in the output.

**Note:**

You can transport these language and tag definitions between models, using the [Export Reference Data](#) <sup>[223]</sup> and [Import Reference Data](#) <sup>[223]</sup> options on the **Tools** menu.

### 10.1.5 Use MS Word

To further enhance and customize RTF documentation it is possible to create a custom master document, which can be used to add a table of contents, table of figures, headers and footers and to refresh linked files. In addition it is possible to create documents with sustainable links to generated 'pieces' of Enterprise Architect output, pre-divided by Enterprise Architect using [bookmarks](#) <sup>[1638]</sup>.

As an alternative to the *Word* master document, internal to Enterprise Architect, see [Virtual Documents](#) <sup>[1616]</sup>.

In addition to creating Word master documents, you can:

- [Open a Report in Microsoft Word](#) <sup>[1638]</sup>
- [Change Linked Images to Embedded](#) <sup>[1638]</sup>
- [Apply Other Features of Word](#) <sup>[1641]</sup>.

**Note:**

You can develop a report using the combined facilities of Word and Enterprise Architect with few problems, as long as you leave definition of the *section styles* to the final stages in Enterprise Architect just prior to report generation. Word truncates the section bookmarks, as it uses a smaller field length for sections. In Word, you can review and edit reports generated by Enterprise Architect, but you cannot import them back into Enterprise Architect without damaging the section style definition.

#### 10.1.5.1 Open a Report in Microsoft Word

To open an RTF file in MS Word, simply load Word and open the file as a normal document. Word converts the file. If Word is the default handler of RTF files, then double-click on the output file to load up and view the report.

**Tip:**

If you have Word configured to view RTF files, you can also click on the **View Output** button on the **Generate RTF Documentation** dialog.

#### 10.1.5.2 Change Linked Images to Embedded

One of the options available when generating RTF documentation is the ability to store image files in a separate directory to the RTF document. If at a later stage it becomes desirable to embed the images in the RTF documentation, this is especially important when the document is to be distributed. If the images are stored in a separate directory recipients of document see only the placeholder of images rather than the actual images.

If you import an RTF document into Word with the images not embedded into the document, you have the option of breaking the links to the images and saving the image in the document.

#### Break Image Links in Word

1. Open the required RTF file in Word.
2. Select the **Edit | Links** menu option.
3. Highlight all links in the **Links** list.
4. Select the **Save Picture in Document** checkbox.
5. Click on the **Break Link** button.
6. When prompted, click on the **Yes** button to break links.

Word breaks the links and saves copies of the images inside the document. You can distribute this document

without the image directory.

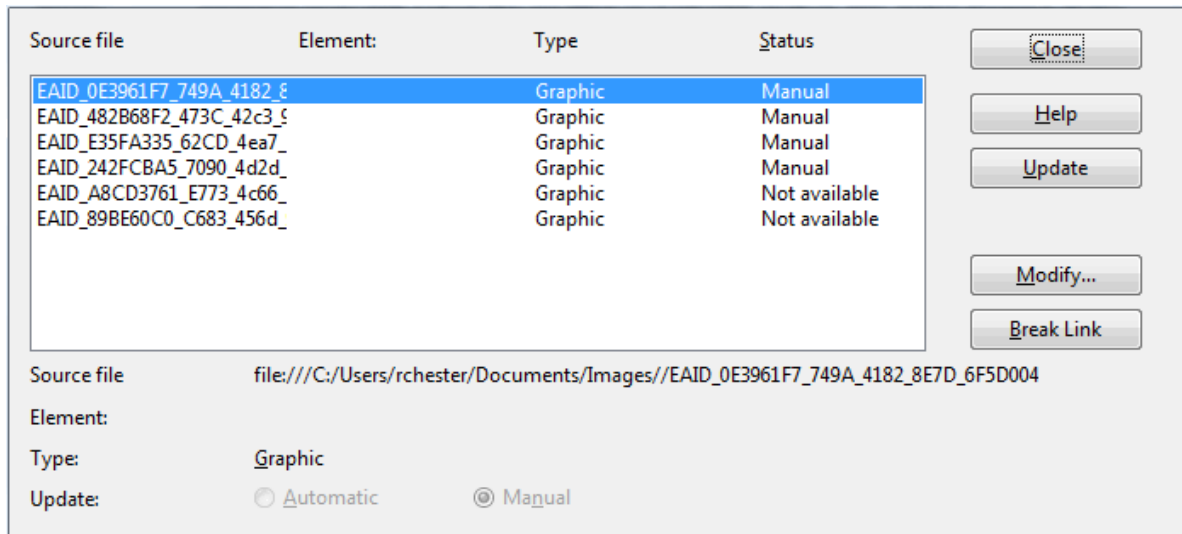

### 10.1.5.3 RTF Bookmarks

Bookmarks are markers that are automatically placed in your rich text document when you generate it. You can create a master document in Word and link to sections of an Enterprise Architect report based on bookmarks. For example, a Word document might have a section for a small part of your component model. Using bookmarks you can generate a full component model, and then link into just one section of the report.

This way you can maintain a complex Word document from parts of Enterprise Architect reports. If you link into Enterprise Architect reports, then you can regenerate the report and refresh Word links to update the master document without having manually changed anything. For more information on refreshing links, see the [Refresh Links](#) <sup>1646</sup> topic.

Bookmarks are GUID-based numbers that can be created for packages, diagrams and elements. A package bookmark applies from the beginning of a package to the end, and includes all child packages and elements underneath.

#### Note:

You cannot use RTF Bookmarking in [Master Document](#) <sup>1648</sup> elements, which effectively replace RTF Bookmarking in Word.

RTF Bookmarking requires each bookmark to be unique. When you generate a report with a standard RTF template (including in a single Model Document element), each bookmark is unique and there is a 1:1 association between the Elements-details being generated and the elements in the repository. As Master Documents are intended to contain multiple sub-documents, the association ceases to be 1:1. There is no simple method that enables the generated data to be uniquely identified directly in association with the original element.

### Bookmark a Section of Enterprise Architect for RTF Documentation

1. In the Enterprise Architect **Project Browser**, right-click on the package to include in the documentation. The context menu displays.
2. Select the **Documentation | Copy RTF Bookmark** menu option to paste the package into the clipboard as a bookmark for use in Word.



### Insert a Bookmarked Section of an Enterprise Architect RTF Document into Word

1. Open the Word document and position the cursor at the point at which to insert the file.
2. Select the Word **Insert | File** menu option. The **Insert** dialog displays.

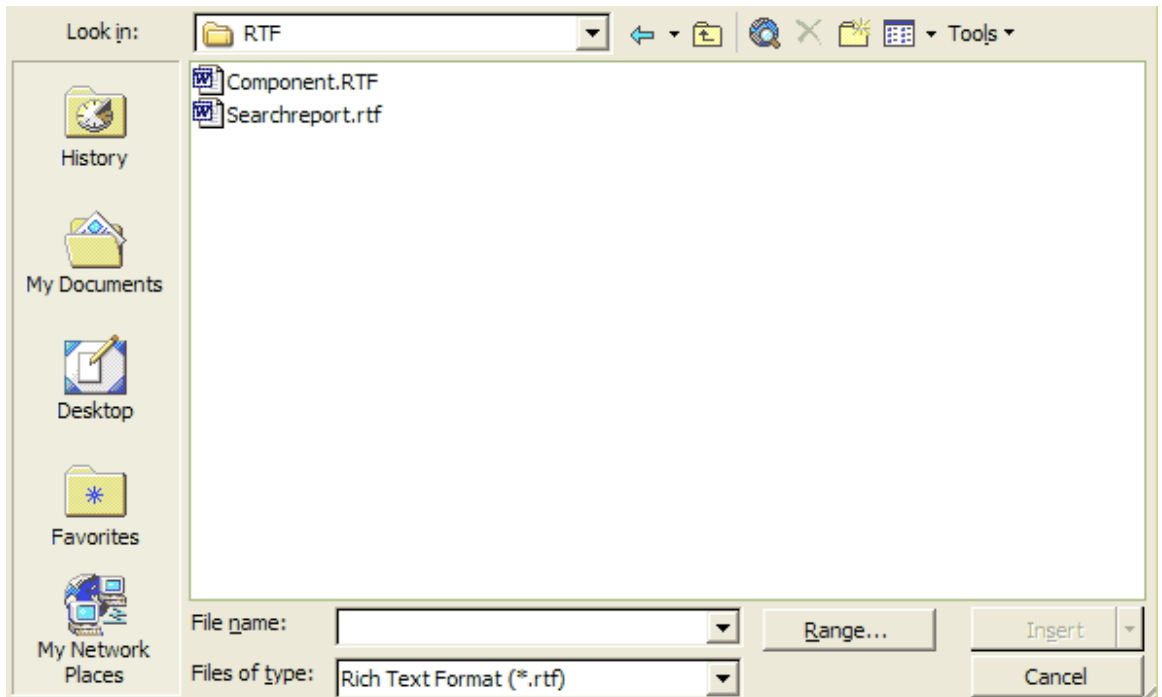

3. Locate and click on the file to insert, then click on the **Range** button.
4. In the **Range** cell type or paste the information from the clipboard.

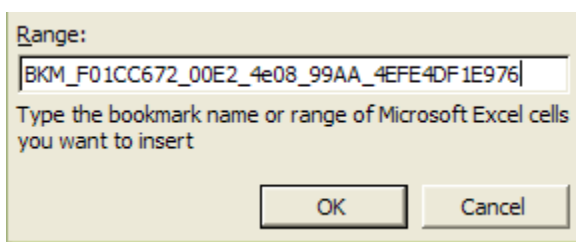

5. Click on the **OK** button.
6. Click on the drop-down arrow next to the **Insert** button. Select the **Insert as Link** option.

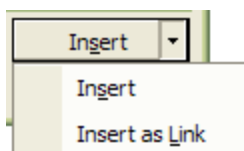

The **Insert** option sets a permanent copy; the **Insert as Link** option creates a link that is updateable on altering the source document. For **Insert as Link** to operate you must first set [Refresh Links](#)<sup>[1646]</sup>.

Every package is bookmarked in the RTF document according to the following rules:

- All alphabetic and numeric characters remain the same
- All other characters (including spaces) are converted to underscores.

For example *UC01: Use Case Model* becomes *UC01\_\_Use\_Case\_Model*.

#### 10.1.5.4 Other Features of Word

Word offers a considerable number of document enhancement tools to complete your project documentation. Here are some of the things you can do with Word in Enterprise Architect generated RTF documentation:

- [Add a Table of Contents](#)<sup>[1641]</sup>
- [Add a Table of Figures](#)<sup>[1642]</sup>
- [Add Headers and Footers](#)<sup>[1643]</sup>
- [Manipulating Tables in Word](#)<sup>[1644]</sup>
- [Refresh Linked Files](#)<sup>[1646]</sup>

#### Tip:

Enterprise Architect provides the basic content for your document - use Word to add the presentation and linkages.

##### 10.1.5.4.1 Add Table of Contents

Among the features of MS word that can be incorporated into generated Enterprise Architect reports is the option to include a table of contents. A table of contents can be used to aid navigation of documentation and enhance the readability of Enterprise Architect RTF reports. This option provides hyperlinks to the diagrams included in the RTF documentation in the electronic version, and page numbers for both the printed and electronic documentation. To include a Table of Contents in the RTF documentation follow the steps below:

1. Open the Enterprise Architect RTF report to which to add a Table of Contents in MS Word.
2. Select the **Insert | Reference | Index and Tables** menu option.
3. Click on the **Table of Contents** tab to set the options that are available for formatting the table of contents.

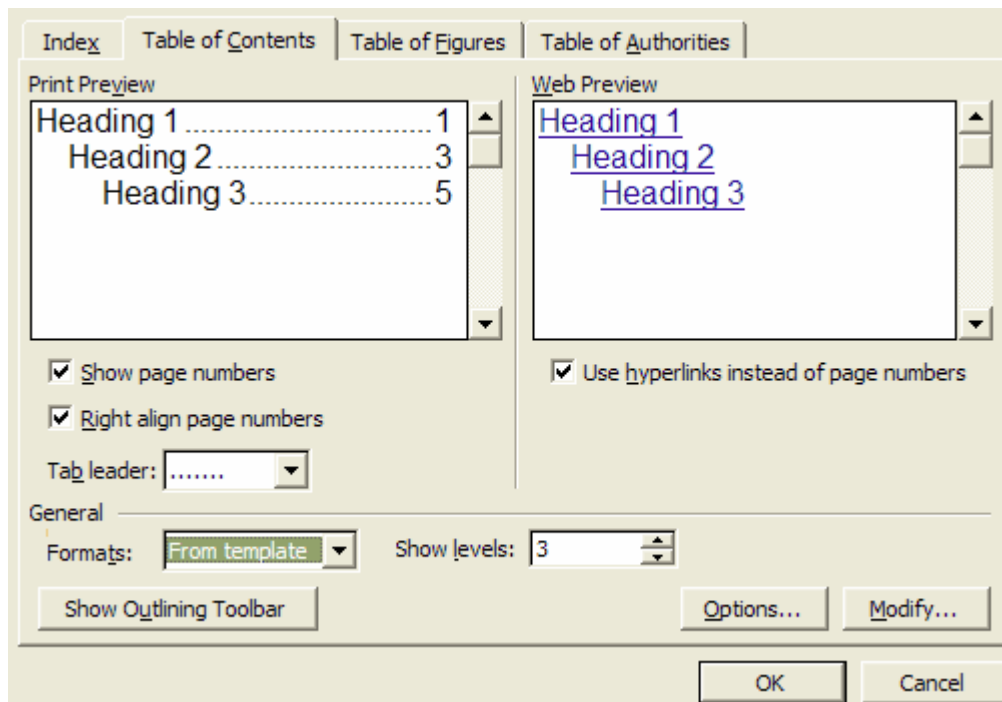

The format of the table of contents is dependant on the heading levels created when the RTF is generated. To set the heading style for details in Enterprise Architect RTF documentation, see the RTF [Document Options](#) topic.

#### 10.1.5.4.2 Add Table of Figures

Among the features of MS word that can be incorporated into generated Enterprise Architect reports is the option to include a table of figures. A table of figures can be used to aid the navigation of the documentation and enhance the readability of Enterprise Architect RTF reports. This option provide hyperlinks to the diagrams included in the RTF documentation in the electronic version and page numbers for both the printed and electronic documentation.

To include a Table of Figures in the RTF documentation, follow the steps below:

1. Open the Enterprise Architect RTF report to which to add a Table of Figures in MS Word.
2. Select the **Insert | Reference | Index and Tables** menu option.
3. Click on the **Table of Figures** tab to set the options that are available for formatting the table of figures.

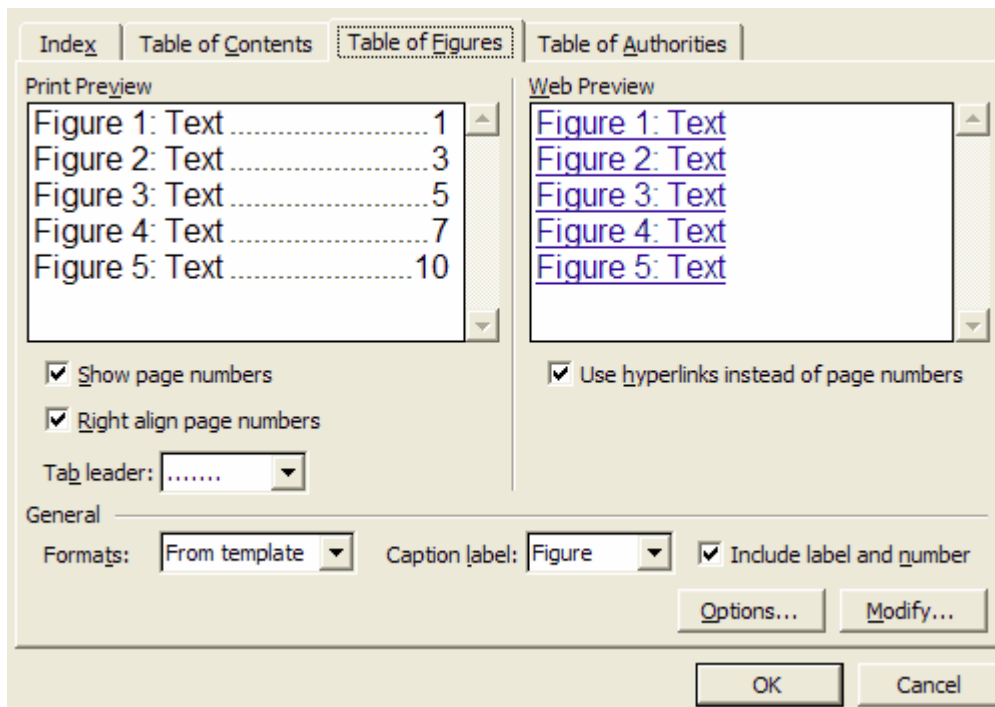

#### 10.1.5.4.3 Add Headers and Footers

Among the features of MS word that can be used to enhance the appearance of Enterprise Architect RTF reports is the ability to add headers and footers to the documentation. To include headers and footers in the RTF documentation follow the steps below:

1. In MS Word, open the Enterprise Architect RTF report to which to add headers and footers.
2. Select the **View | Header and Footer** menu option.

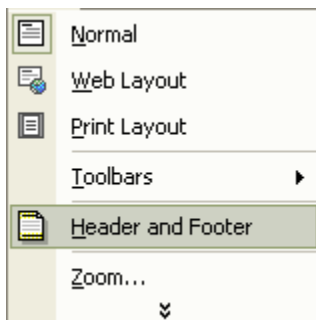

This enables you to enter information into the header section and the footer section of the RTF Documentation.

Header	
Sparx Systems	
<div style="border: 1px solid black; padding: 2px;"> <b>Header and Footer</b> </div>	
Class model:.....	1
Interactions .....	1
Actor1 .....	4
Actor2 .....	4
Actor3 .....	4
Actor4 .....	4
Actor5 .....	4
Staff_Room .....	5
Statecharts .....	5
Figure 1 : Interactions .....	1
Figure 2 : Interactions .....	3
Figure 3 : Statecharts .....	6

## Class Model

The logical model is made up of the Domain Model - a high level model of business objects and relationships between objects suitable for analysing the business process, and the class model - a rigorous model of classes and their inter-relationships, suitable for building a software product.

## Interactions

### 10.1.5.4.4 Manipulate Tables in Word

When generating RTF documentation from Enterprise Architect, tables are included when items such as **Attributes** and **Methods** are selected in the **For each Object** section in the **Rich Text Format Report** dialog. MS Word offers several levels of customization for tables and can be used to tidy the formatting of the tables in situations where the margins of the table exceed the dimensions of the page size selected in Word for printing.

#### Resize Tables

When the amount of detail for a documented item such as an attribute or operation exceeds the margins of the page in MS Word it is necessary to manually resize the table in order to view all of the details. To manually resize the table follow the steps below:

1. Select the table that exceeds the margin size.
2. Mouse over the border of the table until the mouse pointer changes into the icon shown below.



*Message Attributes*

Attribute	Type	Notes
<u>sentTime</u>	protected : <i>Date</i>	
<u>receivedTime</u>	protected : <i>Date</i>	
body	protected : <i>String</i>	

3. Drag the cursor to the left to reduce the width of the table and then select the **File | Print Preview** menu option to confirm that the table borders are within the page margins.
4. Resize all of the tables that overhang the margins of the page by using the steps detailed above.

### Applying Styles to Tables

One of the customizable properties of MS Word when working with tables is the ability to apply a style to a table, which enables you to rapidly change the appearance of the table. To achieve this effect follow the steps below:

1. Open the Enterprise Architect RTF report in which to change the table styles.
2. Locate and select the table for which to adjust the appearance.
3. Select the **Table | Table Auto Format** menu option. The **Table Autoformat** dialog displays.

From here you can specify a predefined table style from the **Table styles** list, or create a new style by clicking on the **New** button. The table styles defined in the **Table Autoformat** dialog only apply to one table at a time so you must apply the style to each table created individually.

Category:  
All table styles

Table styles:

Table Columns 1
Table Columns 2
Table Columns 3
Table Columns 4
Table Columns 5
Table Contemporary
Table Elegant
Table Grid
Table Grid 1
Table Grid 2
Table Grid 3
Table Grid 4

New...  
Delete...  
Modify...  
Default...

Preview

	Jan	Feb	Mar	Total
East	7	7	5	19
West	6	4	7	17
South	8	7	9	24
Total	21	18	21	60

Apply special formats to

Heading rows       Last row  
 First column       Last column

Apply      Cancel

#### 10.1.5.4.5 Refresh Links

If you link into Enterprise Architect reports, then you can regenerate the report and refresh MS Word links to update the Word master document without having manually changed anything.

To ensure that links are refreshed in the master document, you must select the **Update automatic links at Open** checkbox in Word. To ensure that this setting is established follow the steps below:

1. From within MS Word select the **Tools | Options** menu option.
2. Select the **General** tab and select the **Update automatic links at Open** checkbox.

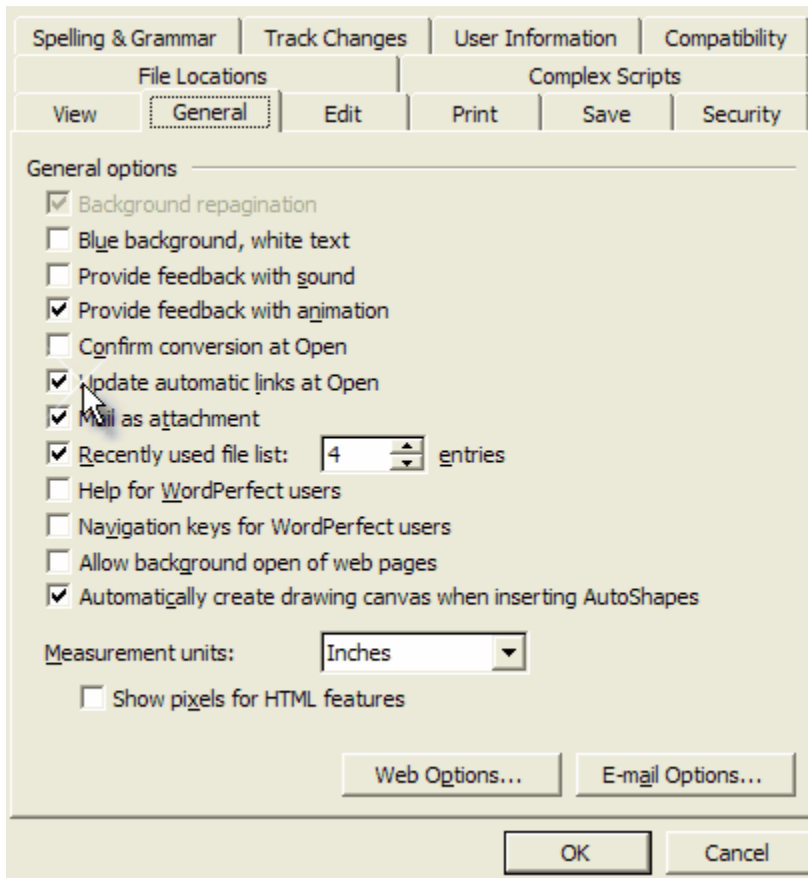

## 10.2 HTML Reports



Enterprise Architect provides automated web-based publishing of models. A new outline structure closely mirrors the model hierarchy and makes it very simple to explore models on-line. With a great new look and the ability to explore very large models efficiently on-line, the new web-publishing capability is a significant enhancement.

Enterprise Architect enables export of an entire model or a single branch of the model to HTML Web pages. The [HTML report](#)<sup>[1647]</sup> provides an easy to use, highly detailed, Javascript based model tree. In addition, hyperlinked elements make browsing to related information very simple.

The current implementation is based on internal and external templates and generated Javascript. The ability to edit all templates is to be added in a future version of Enterprise Architect.

### Tip:

You can create [Web Style Templates](#)<sup>[1649]</sup> to customize your HTML output.

### Note:

In the Corporate, Business and Software Engineering, System Engineering and Ultimate editions of Enterprise Architect, if security is enabled you must have [Generate Documents](#)<sup>[198]</sup> permission to generate HTML documents.

### 10.2.1 Create an HTML Report

To create an HTML report:

1. In the **Project Browser**, right-click on the root package for the report (all child packages are included in the output). The context menu displays.
2. Select the **Documentation | HTML Report** menu option. The [Generate HTML Report dialog](#)<sup>[1648]</sup> displays.
3. In the **Output to** field, select an output directory for your report. Set any other required options.
4. Click on the **Generate** button to generate the report. The **Progress** field shows total percentage complete.
5. Once the report is complete, click on the **View** button to launch your default HTML viewer and view the web pages.

### Note:

If you are using Microsoft Internet Explorer 7.0 or later, and you do not have it open, its security profile might block the report display. Click on the explanation banner at the top of the screen and select the **Allow Blocked Content** context menu option.

The web report produced is compatible with any standard web server, on either Unix or Windows platforms. Simply bundle up the entire output directory and place it within the context of your web server. All path names should be relative and case sensitive.

When you view the HTML report in your HTML viewer, you can switch directly to a page for a specific diagram or element by specifying the appropriate GUID after the report web address. That is:

```
http://path/path/path/Index.htm?guid=xxxxxxxxxxxx
```

The word *guid* must be in lower case, and the value must not include braces { }. For example:

```
http://.../path/Index.htm?guid=DC62B0DA-0D60-4447-85E6-B9BBAE7FC90F
```

You can obtain the GUID for the diagram or element using the **Copy Reference** option on the **Project Browser Diagram**<sup>[1220]</sup>, **Element**<sup>[1218]</sup> and **Package**<sup>[1214]</sup> context menu options.

**Note:**

The page locator does not work directly in Internet Explorer. Firefox automatically converts the path to <file:///C:/path> protocol, and actions it. That protocol also works in Internet Explorer. Therefore, to use the absolute references without a web server you must access the path using the <file:///> protocol.

**Quick Start**

To generate an HTML report right now, follow the steps above on the *System Model* package of the *EAExample* project.

**10.2.2 The Generate HTML Report Dialog**

The **Generate HTML Report** dialog is used to generate documentation about your model in HTML format. There are various settings to choose from to control the output, as described below.

Option	Use to
<b>Package</b>	Display the name of the package you are creating documentation for.
<b>Title</b>	Type the title for your HTML documentation; defaults to <b>Package</b> .
<b>Output to</b>	Type the directory path your documentation is saved to.
<b>Style</b>	Select a <a href="#">web style template</a> <sup>1649</sup> to apply to your documentation (optional).
<b>File</b>	Specify the file extension for your HTML documentation files; the default is <b>.htm</b> .

Option	Use to
<b>Header Image</b>	Enter or select the file path for the header image graphic to display on your HTML output. If you do not specify a file path, the image defaults to the Enterprise Architect logo.
<b>Preserve White space in Notes</b>	Preserve existing white space in your notes; deselect to remove white space.
<b>No page for Note and Text items</b>	Omit the page for your notes and text items in the HTML report.
<b>Default Diagram</b>	Select the diagram the report should open to when the generated documentation is loaded.
<b>Image Format</b>	Select the image file format to save your images in, either PNG or GIF.
<b>Include</b>	Select each area of your model to include in your report.
<b>System</b>	Select each section to generate in your report.

Click on the **Generate** button to generate the HTML report with the settings you have defined.

Click on the **View** button to display the report you have generated.

### 10.2.3 Web Style Templates

The *HTML and CSS Style Editor* enables you to edit the HTML associated with various sections of the HTML Report facility in Enterprise Architect. You would typically use this functionality to customize a report's look and feel for your company or client. The editor is derived from, and provides the facilities of, the common [Code Editor](#)<sup>[1426]</sup>.

To create or edit web style templates, follow the steps below:

1. In the **Resources** window, expand the *Templates* folder.
2. To create a new template, right-click on the *Web Style Templates* folder and select the **Create HTML Template** context menu option. Enter a name for the new template when prompted to do so. The **HTML and CSS Style Editor** displays. See below for further details.
3. To edit an existing template, expand the *Web Style Templates* folder and either double-click on the template name, or right-click and select the **Modify HTML Style Template** context menu option. The **HTML and CSS Style Editor** displays. See below for further details.

#### Note:

To delete a template, right-click on it and select the **Delete HTML Template** context menu option.

The **HTML and CSS Style Editor** contains a list of all available HTML fragments for modification and customization. These fragments are defined in the [HTML Template Fragments](#)<sup>[1657]</sup> topic.

Each fragment typically contains HTML plus one or more special tag names that Enterprise Architect replaces with information during generation. Currently you cannot alter the content within the tag names, but you can omit a complete tag by removing it, or alter its basic display properties in the surrounding HTML.

Special tag names are delimited by # characters - for example, **#NOTES#**.

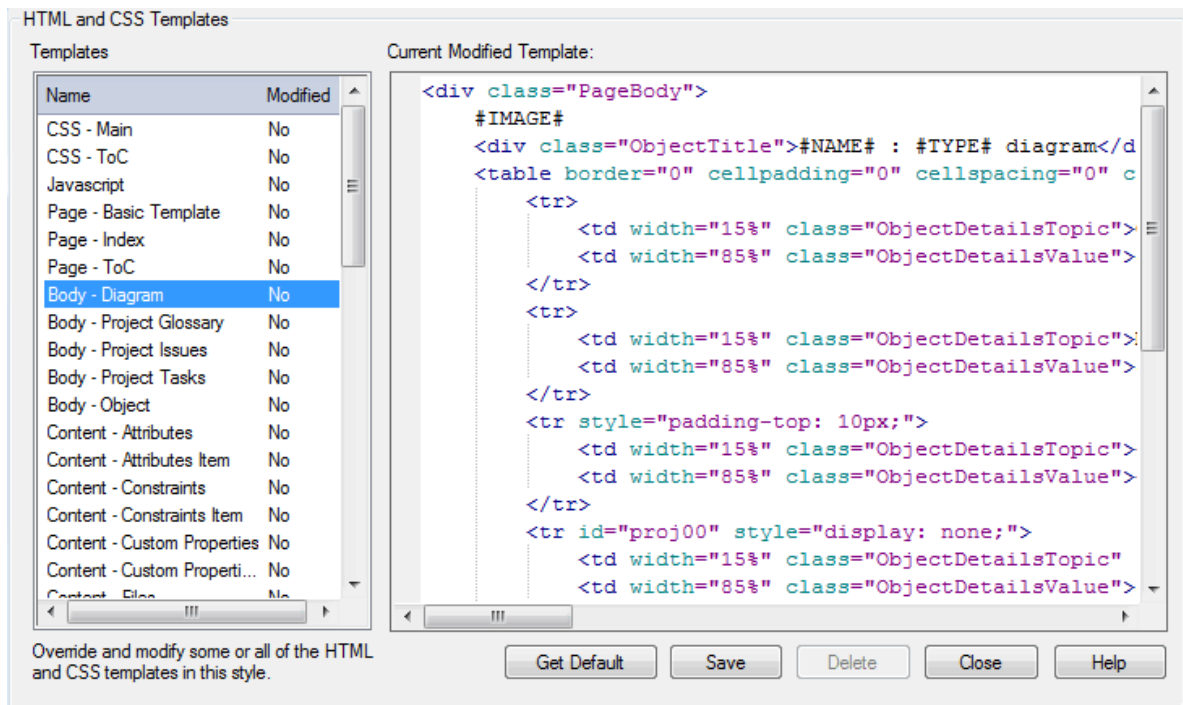

- **Get Default** retrieves the default Enterprise Architect template for the currently selected template item in the left hand list
- **Save** saves your version of the template for this style only
- **Delete** removes your modified version of the template, which causes Enterprise Architect to use the default template during report generation.

To select a template during generation, use the **Style** drop-down arrow on the **Generate HTML Report** dialog. Once a style is selected, Enterprise Architect applies that to the current report. Select `<default>` for the inbuilt style.

Package: Business Process Model

Title: Business Process Model

Output to: C:\Documents and Settings\SimonG\My Documents\Help S ...

Style: <default> File .htm

Header Image: <default> Trial HTML ...

Preserve Whitespace in Notes

No page for Note and Text items

Default Diagram

Model Default

Current Diagram

Other Diagram ...

None

Image Format

PNG

GIF

Include

Test Cases

Maintenance Items

Resource Allocation

Hyperlinked Files

System

Glossary

Model Tasks

Model Issues

Progress

Generate View Close Help

**Note:**

Each time Enterprise Architect generates the web report it overwrites these files, so you must back up your modified versions and copy them back in after every update.

### 10.2.4 HTML Template Fragments

This topic identifies each of the HTML Template fragments available through the [HTML and CSS Style Editor](#) (1649), and defines the fields of each fragment.

Section	Fields
<b>Body - Diagram</b>	<ul style="list-style-type: none"> <li>• #AUTHOR# - Diagram author</li> <li>• #CREATEDATE# - Diagram created date</li> <li>• #CSS# - Style Sheet to use</li> <li>• #GUID# - Diagram GUID</li> <li>• #IMAGE# - Image of the diagram</li> <li>• #IMAGES# - Image path</li> <li>• #LOCKED# - Is the diagram locked (<b>true</b> or <b>false</b>)</li> <li>• #MODDATE# - Diagram modified date</li> <li>• #NAME# - Diagram name</li> <li>• #NOTE# - Diagram notes</li> <li>• #STEREOTYPE# - Diagram stereotype</li> <li>• #TITLE# - Diagram title</li> <li>• #TYPE# - Diagram type</li> <li>• #VERSION# - Diagram version.</li> </ul>

Section	Fields
<b>Body – Object</b>	<ul style="list-style-type: none"> <li>• #ABSTRACT# - Element abstract (if true, = <b>abstract</b>)</li> <li>• #ACTIVE# - Element isActive (<b>true</b> or <b>false</b>)</li> <li>• #ALIAS# - Element alias ("<b>#ALIAS#</b>")</li> <li>• #AUTHOR# - Element author</li> <li>• #BEHAVIOR# - Returns the object behavior.</li> <li>• #CLASSIFIER# - Element classifier</li> <li>• #COMPLEXITY# - Element complexity</li> <li>• #CREATEDATE# - Element created date</li> <li>• #CSS# - Style Sheet to use</li> <li>• #DIAGRAMS# - List of diagrams the element is on</li> <li>• #GUID# - Element GUID</li> <li>• #IMAGES# - Image path</li> <li>• #KEYWORDS# - Element keywords</li> <li>• #LEAF# - Element isLeaf (<b>true</b> or <b>false</b>)</li> <li>• #LEVELNUMBER# - Element level number</li> <li>• #MODDATE# - Element modified date</li> <li>• #MULTIPLICITY# - Element multiplicity ("<b>Multiplicity: #MULTIPLICITY#</b>")</li> <li>• #NAME# - Element name</li> <li>• #NOTE# - Element notes</li> <li>• #PHASE# - Element phase</li> <li>• #ROOT# - Element isRoot (<b>true</b> or <b>false</b>)</li> <li>• #SCOPE# - Element scope</li> <li>• #STATUS# - Element status</li> <li>• #STEREOTYPE# - Element stereotype(s)</li> <li>• #TYPE# - Element type; for example, Class, Object</li> <li>• #VERSION# - Element version.</li> </ul>
<b>Body – Project Glossary</b>	<ul style="list-style-type: none"> <li>• #CONTENT# - Loops <b>Content – Project Glossary Item</b> for each Project Glossary item.</li> </ul>
<b>Body – Project Issues</b>	<ul style="list-style-type: none"> <li>• #CONTENT# - Loops <b>Content – Project Issue Item</b> for each Project Issue item.</li> </ul>
<b>Body – Project Tasks</b>	<ul style="list-style-type: none"> <li>• #CONTENT# - Loops <b>Content – Project Task Item</b> for each Project Task item.</li> </ul>
<b>Content – Attributes</b>	<ul style="list-style-type: none"> <li>• #CONTENT# - Loops <b>Content – Attributes Item</b> for each attribute on an element.</li> </ul>
<b>Content – Attributes Item</b>	<ul style="list-style-type: none"> <li>• #ALIAS# - Attribute alias ("<b>&lt;i&gt;Alias:&lt;/i&gt; #ALIAS#&lt;br&gt;</b>")</li> <li>• #CONST# - Attribute is constant value ("<b>const</b> " &lt;-- Note Space)</li> <li>• #CONSTRAINT# - Attribute constraint</li> <li>• #DEFAULT# - Attribute default value ("<b>&lt;i&gt;Initial:&lt;/i&gt; #DEFAULT&lt;br&gt;</b>")</li> <li>• #NAME# - Attribute name</li> <li>• #NOTE# - Attribute notes</li> <li>• #ORDERED# - Attribute is ordered value ("<b>Ordered &lt;br /&gt;</b>")</li> <li>• #RANGE# - If lower != 1 ("<b>Range:&lt;lower&gt; to &lt;upper&gt;</b>")</li> </ul>



Section	Fields
	<ul style="list-style-type: none"> <li>• #SCOPE# - Attribute scope ("<b>#SCOPE#</b> " &lt;-- Note space)</li> <li>• #STATIC# - Attribute is static value ("<b>static</b> " &lt;-- Note Space)</li> <li>• #STEREOTYPE# - Attribute stereotype(s)</li> <li>• #TAGS# - Attribute tags ("<b>Property Name=Property Value&lt;br&gt;</b>")</li> <li>• #TYPE# - Attribute type (if <b>Column</b>, "<b>#TYPE(Column Precision, Scale)</b>").</li> </ul>
Content – Constraints	<ul style="list-style-type: none"> <li>• #CONTENT# - Loops <b>Content – Constraints Item</b> for each constraint on an element.</li> </ul>
Content – Constraints Item	<ul style="list-style-type: none"> <li>• #CONSTRAINT# - Constraint name</li> <li>• #NOTES# - Constraint notes</li> <li>• #STATUS# - Constraint status</li> <li>• #TYPE# - Constraint type.</li> </ul>
Content – Custom Properties	<ul style="list-style-type: none"> <li>• #CONTENT# - List of all <b>Content – Custom Properties - Item</b>.</li> </ul>
Content – Custom Properties - Item	<ul style="list-style-type: none"> <li>• #PROPERTY# - Custom property name</li> <li>• #VALUE# - Custom property value ( if type equal boolean true or false else #VALUE#).</li> </ul>
Content – Files	<ul style="list-style-type: none"> <li>• #CONTENT# - List of <b>Content - Files Item</b>.</li> </ul>
Content – Files Item	<ul style="list-style-type: none"> <li>• #DATE# - File date</li> <li>• #NAME# - File filename (&lt;a href="#FILENAME#"&lt;/a&gt;)</li> <li>• #NOTES - File notes</li> <li>• #SIZE# - File size</li> <li>• #TYPE# - File type.</li> </ul>
Content – Notes	<ul style="list-style-type: none"> <li>• #VALUE#&gt;- Notes Text.</li> </ul>
Content – Operations	<ul style="list-style-type: none"> <li>• #CONTENT# - List of <b>Content - Operations Item</b>.</li> </ul>
Content – Operations Item	<ul style="list-style-type: none"> <li>• #ABSTRACT# - Operation abstract (<b>abstract</b>)</li> <li>• #ALIAS# - Operation alias ("<b>&lt;i&gt;Alias:&lt;/i&gt; #ALIAS#&lt;br&gt;</b>")</li> <li>• #CONCURRENCY# - Operation concurrency (<b>blank</b> if not set)</li> <li>• #CONST# - Operation constant (<b>const</b>)</li> <li>• #CONSTRAINTS# - List of <b>Method Constraint</b></li> <li>• #ISQUERY# - Operation IsQuery (<b>isQuery</b>)</li> <li>• #NAME# - Operation name</li> <li>• #NOTE# - Operation notes.</li> <li>• #PARAMS# - List of <b>Content – Operations Item Parameters</b></li> <li>• #SCOPE# - Operation Scope</li> <li>• #STATIC# - Operation IsStatic (<b>static</b>)</li> <li>• #STEREOTYPE# - Operation stereotype</li> <li>• #TAGLABEL# - static text (<b>Tags</b>)</li> </ul>

Section	Fields
	<ul style="list-style-type: none"> <li>• #TAGS# - Attribute tags ("<b>Property Name=Property Value&lt;br&gt;</b>")</li> <li>• #TYPE# - Operation type.</li> </ul>
<b>Content – Operations Item Parameters</b>	<ul style="list-style-type: none"> <li>• #DEFAULT# - Op Parameter default</li> <li>• #GUID# - Op Parameter GUID</li> <li>• #KIND# - Op Parameter kind</li> <li>• #NAME# - Op Parameter name</li> <li>• #NOTES# - Op Parameter notes</li> <li>• #STEREOTYPE# - Op Parameter stereotype</li> <li>• #TYPE# - Op Parameter type.</li> </ul>
<b>Content – Project Glossary Item</b>	<ul style="list-style-type: none"> <li>• #MEANING# - Glossary Meaning</li> <li>• #TERM# - Glossary Term</li> <li>• #TYPE# - Glossary Type.</li> </ul>
<b>Content – Project Issues Item</b>	<ul style="list-style-type: none"> <li>• #DATERESOLVED# - Project Issue resolved date (<b>blank</b> if no date entered)</li> <li>• #ISSUE# - Project Issue name</li> <li>• #ISSUEDATE# - Project Issue issue date</li> <li>• #NOTES# - Project Issue notes</li> <li>• #OWNER# - Project Issue owner</li> <li>• #RESOLUTION# - Project Issue resolution</li> <li>• #RESOLVER# - Project Issue resolver</li> <li>• #STATUS# - Project Issue status.</li> </ul>
<b>Content – Project Tasks Item</b>	<ul style="list-style-type: none"> <li>• #ENDDATE# - Project Task end date</li> <li>• #NAME# - Project Task name</li> <li>• #NOTES# - Project Task notes</li> <li>• #OWNER# - Project Task owner</li> <li>• #PHASE# - Project Task phase</li> <li>• #PRIORITY# - Project Task priority</li> <li>• #STARTDATE# - Project Task start date</li> <li>• #STATUS# - Project Task status</li> <li>• #TYPE# - Project Task type.</li> </ul>
<b>Content – Resource Allocation</b>	<ul style="list-style-type: none"> <li>• #CONTENT# - List of <b>Content – Resource Allocation Item</b>.</li> </ul>
<b>Content – Resource Allocation Item</b>	<ul style="list-style-type: none"> <li>• #ACTUAL# - Resource actual time</li> <li>• #ENDDATE# - Resource end date</li> <li>• #EXPECTED# - Resource expected date</li> <li>• #NOTES# - Resource notes</li> <li>• #PERCENT# - Resource percent complete</li> <li>• #RESOURCE# - Resource name</li> <li>• #ROLE# - Resource role</li> <li>• #STARTDATE# - Resource start date</li> <li>• #TIME# - Resource time.</li> </ul>
<b>CSS – Main</b>	<ul style="list-style-type: none"> <li>• None.</li> </ul>

Section	Fields
CSS – ToC	<ul style="list-style-type: none"> <li>None.</li> </ul>
Feature Notes	<ul style="list-style-type: none"> <li>#FIELD#</li> <li>#VALUE#.</li> </ul>
Javascript	<ul style="list-style-type: none"> <li>None.</li> </ul>
Link (Association)	<ul style="list-style-type: none"> <li>#CONTENT#</li> <li>#DIAGRAMS# - List of diagrams the link is on.</li> </ul>
Linked Document	<ul style="list-style-type: none"> <li>#LINKDOC# - Linked Document.</li> </ul>
Linked Requirement	<ul style="list-style-type: none"> <li>#CONTENT# - List of <b>Linked Requirement Item</b>.</li> </ul>
Linked Requirement Item	<ul style="list-style-type: none"> <li>#DIFF# - Linked Requirement difficulty</li> <li>#NAME# - Linked Requirement name</li> <li>#PRIORITY# - Linked Requirement priority</li> <li>#STATUS# - Linked Requirement status.</li> </ul>
Linked Section	<ul style="list-style-type: none"> <li>#ITEMS#</li> <li>#TITLE#.</li> </ul>
Link Line Item	<ul style="list-style-type: none"> <li>#CONNECTION# - Connector type</li> <li>#IMAGE# - The file path of the images</li> <li>#LINK# - (&lt;a href= "path to element"&gt; "Connection Name" &lt;/a&gt;)</li> <li>#NOTES# - The connector notes</li> <li>#NUMBER# - A unique number used to identify div elements</li> <li>#SOURCEROLE# - Source role</li> <li>#SOURCEROLENOTES# - Source role notes</li> <li>#STEREOTYPE# - Connector stereotype</li> <li>#TARGETROLE# - Target role</li> <li>#TARGETROLENOTES# Target role notes</li> <li>#TYPE# - Connector type.</li> </ul>
Maintenance	<ul style="list-style-type: none"> <li>#CONTENT# - List of <b>Maintenance Line Item</b>.</li> </ul>
Maintenance Line Item	<ul style="list-style-type: none"> <li>#DATEREPORTED# - Maintenance date reported</li> <li>#DATERESOLVED# - Maintenance date resolved</li> <li>#IMAGE# - The file path of the images</li> <li>#NOTES# - Maintenance notes</li> <li>#NUMBER# - A unique number used to identify div elements</li> <li>#PRIORITY# - Maintenance priority</li> <li>#PROBLEM# - Maintenance name</li> <li>#REPORTEDBY# - Maintenance reported by</li> <li>#RESOLVEDBY# - Maintenance resolved by</li> <li>#RESOLVERNOTES# - Maintenance resolved notes</li> <li>#STATUS# - Maintenance status</li> <li>#TYPE# - Maintenance type</li> </ul>

Section	Fields
	<ul style="list-style-type: none"> <li>• #VERSION# - Maintenance version.</li> </ul>
<b>Message</b>	<p>(Applies only to Sequence messages.)</p> <ul style="list-style-type: none"> <li>• #CONTENT# - Loops the <b>Message Item</b> for each attribute on an element</li> <li>• #DIRECTION# - Contains the value <b>To</b> or <b>From</b>.</li> </ul>
<b>Message Item</b>	<ul style="list-style-type: none"> <li>• #KIND# - The Message <b>Kind</b> field</li> <li>• #MESSAGE# - Connector Message</li> <li>• #NAME# - Name of the Message (&lt;a href="&lt;path&gt;"&gt;#NAME#) If Message has a classifier: #NAME#="#NAME# :Classifier"</li> <li>• #NOTES# - The Message notes (&lt;strong&gt;Type:&lt;/strong&gt; #Item Type#&lt;br /&gt; #NOTES#)</li> <li>• #SYNCH# - The Message <b>Synch</b> field</li> <li>• #TYPE# - The type of Message.</li> </ul>
<b>Method Constraint</b>	<ul style="list-style-type: none"> <li>• #NAME# - Method Constraint name</li> <li>• #NOTES# - Method Constraint notes</li> <li>• #TYPE# - Method Constraint type.</li> </ul>
<b>Object Requirement</b>	<ul style="list-style-type: none"> <li>• #CONTENT# - List of <b>Object Requirement Item</b>.</li> </ul>
<b>Object Requirement Item</b>	<ul style="list-style-type: none"> <li>• #DIFF# - Requirement difficulty</li> <li>• #NAME# - Requirement name</li> <li>• #NOTES# - Requirement notes</li> <li>• #PRIORITY# - Requirement priority</li> <li>• #STABILITY# - Requirement stability</li> <li>• #STATUS# - Requirement status</li> <li>• #TYPE# - Requirement type.</li> </ul>
<b>Package Content</b>	<ul style="list-style-type: none"> <li>• #CONTENT# - List of <b>Package Content Row</b>.</li> </ul>
<b>Package Content Row</b>	<ul style="list-style-type: none"> <li>• #NAME# - Link to Package (&lt;a href="#Link to file#"&gt;#Package name#&lt;/a&gt;)</li> <li>• #TYPE# - Link to Image (&lt;img src="#path to image#"&gt;).</li> </ul>
<b>Page - Basic template</b>	<ul style="list-style-type: none"> <li>• #CONTENT# - Contains <b>Body - Diagram</b> through to <b>Body - Object</b></li> <li>• #TITLE# - Current package name.</li> </ul>
<b>Page - Index</b>	<ul style="list-style-type: none"> <li>• #CSS# - Style Sheet to use</li> <li>• #HOME# - A link to the Start page</li> <li>• #JS# - Javascript to use</li> <li>• #TITLE# - Current package name</li> <li>• #TOC# - <b>To be established</b>.</li> </ul>
<b>Page - ToC</b>	<ul style="list-style-type: none"> <li>• None.</li> </ul>
<b>Scenario</b>	<ul style="list-style-type: none"> <li>• #CONTENT# - List of <b>Scenario Item</b></li> <li>• #EXCEPTIONS# - List of Structured Scenario exceptions</li> <li>• #STRUCTURED# - List of Structured Scenarios.</li> </ul>

Section	Fields
<b>Scenario Item</b>	<ul style="list-style-type: none"> <li>• #IMAGE# - The file path of the images</li> <li>• #NOTES# - Scenario notes</li> <li>• #NUMBER# - A unique number used to identify div elements</li> <li>• #SCENARIO# - Scenario name</li> <li>• #TYPE# - Scenario type.</li> </ul>
<b>Scenario Exception</b>	<ul style="list-style-type: none"> <li>• #CONTENT# - Loops <b>Scenario Exception Item</b> for each exception.</li> </ul>
<b>Scenario Exception Item</b>	<ul style="list-style-type: none"> <li>• #NAME# - Exception name</li> <li>• #STEPNO# - Exception step number</li> <li>• #TYPE# - Exception Type.</li> </ul>
<b>Scenario Structured</b>	<ul style="list-style-type: none"> <li>• #CONTENT# - Loops <b>Scenario Structured Items</b> for each Structured Scenario item.</li> </ul>
<b>Scenario Structured Items</b>	<ul style="list-style-type: none"> <li>• #ACTION# - Name of the scenario</li> <li>• #STEPNO# - Scenario step number</li> <li>• #RESULT# - Step result value</li> <li>• #USES# - Step uses value</li> <li>• #STATE# - Step state value.</li> </ul>
<b>Tagged Value</b>	<ul style="list-style-type: none"> <li>• #CONTENT# - List of <b>Tagged Value Line Item</b>.</li> </ul>
<b>Tagged Value Line Item</b>	<ul style="list-style-type: none"> <li>• #IMAGE# - The file path of the images</li> <li>• #NOTES# - Tagged Value notes</li> <li>• #NUMBER# - A unique number used to identify div elements</li> <li>• #PROPERTY# - Tagged Value name</li> <li>• #VALUE# - Tagged Value if type is boolean (value is <b>true</b> or <b>false</b>).</li> </ul>
<b>Test Cases</b>	<ul style="list-style-type: none"> <li>• #CONTENT# - List of <b>Test Cases Line Item</b>.</li> </ul>
<b>Test Cases Line Item</b>	<ul style="list-style-type: none"> <li>• #ACCEPTANCE# - Test case acceptance notes</li> <li>• #CHECKEDBY# - Test case checked by</li> <li>• #CLASS# - Test case class (<b>Unit, Integration, System, Acceptance, Scenario</b>)</li> <li>• #IMAGE# - The file path of the images</li> <li>• #INPUT# - Test case input notes</li> <li>• #NOTES# - Test case notes</li> <li>• #NUMBER# - A unique number used to identify div elements</li> <li>• #RESULTS# - Test case result notes</li> <li>• #RUNBY# - Test case run by</li> <li>• #RUNDATE# - Test case last run</li> <li>• #STATUS# - Test case status</li> <li>• #TEST# - Test case name</li> <li>• #TYPE# - Test case type.</li> </ul>

**Part**

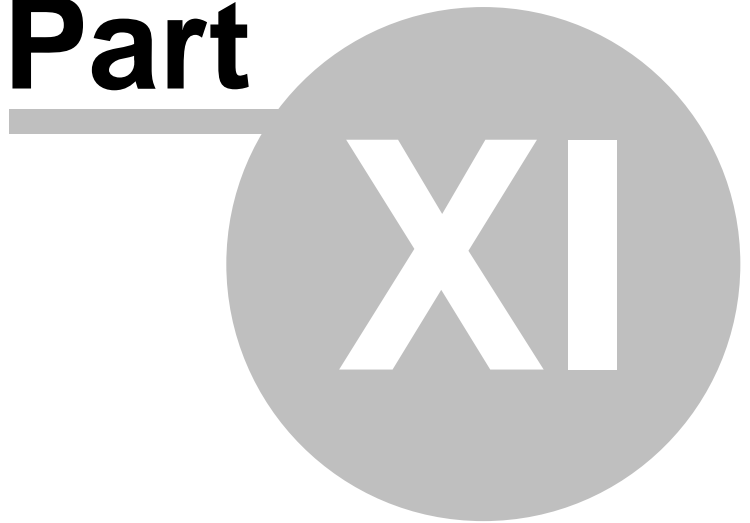

## 11 Automation and Scripts



This section describes how you can automate and extend the facilities of Enterprise Architect through:

- [Scripts](#)<sup>[1660]</sup>
- [The Enterprise Architect Object Model](#)<sup>[1666]</sup>
- [The Enterprise Architect Add-In Model.](#)<sup>[1776]</sup>

## 11.1 Scripting



### Notes:

- This facility is available in the Corporate, Business and Software Engineering, Systems Engineering and Ultimate editions.
- If you intend to use the Scripting facility under Crossover/WINE, you must also install Internet Explorer version 6.0 or above.

Scripts executed in Enterprise Architect have access to the currently open model and are a powerful tool for querying and updating the model in situations that would otherwise require you to perform time consuming and repetitive GUI tasks. Enterprise Architect supports management of scripts using the following script engines:

- JavaScript
- Microsoft JScript
- Microsoft VBScript

The management interface for Scripting is the **Scripter** window, which contains the:

- [Script Tree View](#)<sup>[16631]</sup> (**Scripts** tab), which you use to review, create and edit scripts
- [Script Console](#)<sup>[16631]</sup> (**Console** tab), which you use to operate on an executing script.

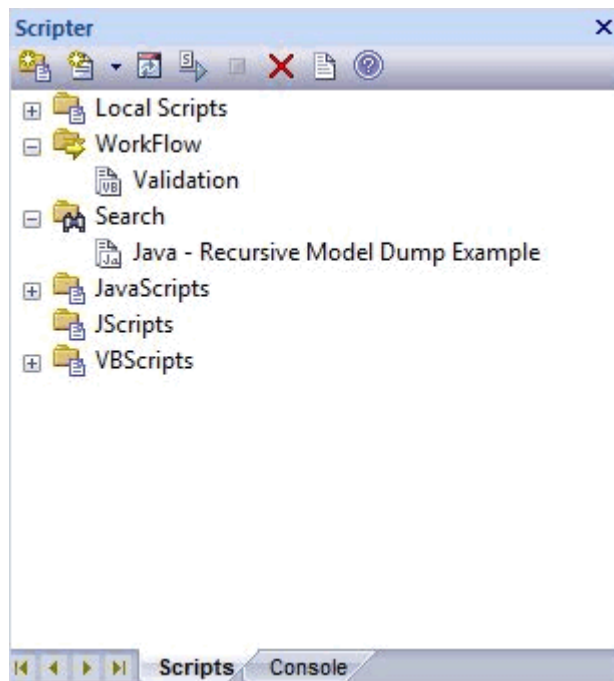

Scripts are managed in groups. The first group in the list is always *Local Scripts*, which are available to any model. You cannot create, edit, drag-and-drop or delete these scripts. Local Scripts are files in the Scripts subdirectory of the Enterprise Architect installation - any instance of Enterprise Architect that has a currently open model can see these scripts.

All other groups are *User Scripts*, which you create yourself. A user group can be [one of four types](#)<sup>[16631]</sup>, each of which applies a template and certain conditions to the scripts you create within that group. User scripts are only visible inside the model in which they were created; the contents of the scripts are stored with the model,



although they can be saved to the file system easily using the [Script Editor](#) <sup>[1435]</sup>.

### 11.1.1 Scripts Tab

**Note:**

This facility is available in the Corporate, Business and Software Engineering, Systems Engineering and Ultimate editions.

The **Scripts** tab is composed of a toolbar and a view of all scripts according to group.

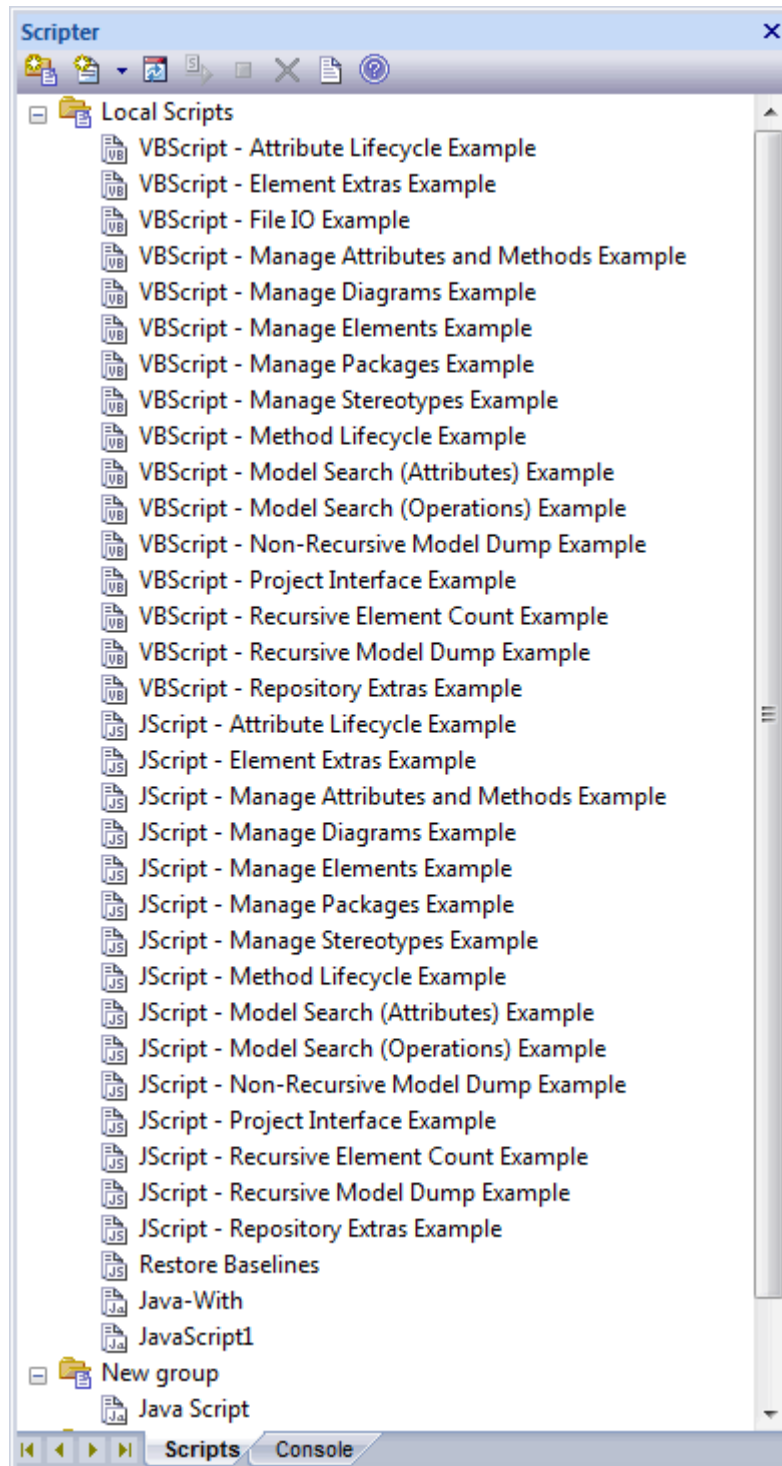











To execute a script, press **[Ctrl]** while you double-click on the script name.

To write or edit a user script, double-click on the script name to display the [Script Editor](#)<sup>[1439]</sup>. This usually displays a script template, determined by the user group type as assigned on the [Script Group Properties dialog](#)<sup>[1663]</sup>.

You can move or copy a script from one *user* scripts folder to another. To:

- *Move* a script, highlight it in the **Scripts** tab and drag it into the user scripts folder it now belongs to
- *Copy* a script, highlight it in the **Scripts** tab and press **[Ctrl]** while you drag it into the user scripts folder in which to duplicate it.

The **Scripts** tab toolbar provides the following options:

Icon	Use to
	Create a new script group. The new group is added to the end of the list in the <b>Scripter</b> window, with the 'New group' text highlighted so that you can type in the group name.
	Create a new script file in the selected script group; displays a short menu of the types of script you can create, namely: <ul style="list-style-type: none"> <li>• VBScript ()</li> <li>• JScript ()</li> <li>• JavaScript ()</li> </ul> The new script is added to the end of the list in the selected group, with the 'New script' text highlighted so that you can type in the script name.
	Refresh the script tree in the <b>Scripter</b> window. This icon also reloads any changes made to a workflow script.
	Compile and execute the selected script. The output from the script is written to the <b>Script</b> tab of the <b>Output</b> window, which you display using the <b>View Script Output</b> button (below).
	Stop an executing script. The icon is disabled if no script is executing.
	Delete a <i>script</i> from the model. You cannot use this icon to delete a script <i>group</i> (see the <a href="#">Context Menu</a> <sup>[1662]</sup> section, below), scripts in the Local Scripts group, or a script that is executing. <p><b>Important:</b></p> The system prompts you to confirm the deletion <i>only</i> if the <b>Confirm Deletes</b> checkbox is selected in the <b>Project Browser</b> panel of the <a href="#">General page</a> <sup>[351]</sup> of the <b>Options</b> dialog. If this option is not selected, no prompt is displayed. Script deletion is permanent - scripts cannot be recovered.
	Display the <b>Output</b> window with the results of the most recently executed script displayed in the <b>Script</b> tab.

### Context Menus

The script groups and their scripts also have context menus that provide some or all of the following options:

- **Group Properties** - to display or edit script group properties in the [Script Group Properties](#)<sup>[1663]</sup> dialog
- **Run Script** - to execute the selected script
- **Rename Script** - to change the name of the selected group or script
- **New VBScript/JScript/JavaScript** - add a new script to the selected user group
- **Import Workflow Script** - to display the **Browser** dialog through which you locate and select a workflow script source (.vbs) file to import into the *Workflow* script folder
- **Delete Group/Script** - to delete the selected user group or script.

**Note:**

If you select to delete a script group that contains scripts, the system always prompts you to confirm the action regardless of any system settings for delete operations. Be certain that you intend to delete the group and its scripts before confirming the deletion - deletion of script groups and scripts is permanent.

**11.1.1.1 Script Group Properties**

The screenshot shows a dialog box titled 'Script Group Properties'. It has several input fields: 'Name' with the text 'Java Scripts', 'Group UID' with the value '{84B17EC0-B433-439d-9A7C-B99F0ACBF178}', 'Source' with the value 'Repository', and 'Group Type' with a dropdown menu set to 'Workflow'. Below these fields is a 'Notes' section with a rich text editor containing the text 'This is a group of scripts created for Java operations.' At the bottom of the dialog are three buttons: 'OK', 'Cancel', and 'Help'.

The **Script Group Properties** dialog enables you to set the following properties of the script group:

- **Name** - The name of the script group; the dialog also displays the automatically-assigned GUID of the group
- **Group Type** - The type of scripts contained in the group. This can be one of:
  - **Normal** - (📁) Ordinary scripts
  - **Project Browser** - (📁) Scripts that are listed in and can be executed from the **Project Browser Scripts** <sup>[1214]</sup> [context menu option](#) <sup>[1214]</sup>
  - **Workflow** - (📁) [Scripts executed by Enterprise Architect's workflow engine](#) <sup>[220]</sup>; you can create only VB scripts of this type)
  - **Search** - (📁) Scripts that can be executed as [model searches](#) <sup>[1231]</sup>; these scripts are listed in the **Search** field of the **Model Search** window.
- **Notes** - Your own notes on the script group.

**11.1.2 Console Tab****Note:**

This facility is available in the Corporate, Business and Software Engineering, Systems Engineering and Ultimate editions.

The script console is a tab of the **Scripter** window. It is a command line interpreter with which you can quickly enable a script engine and enter commands to act on the script.

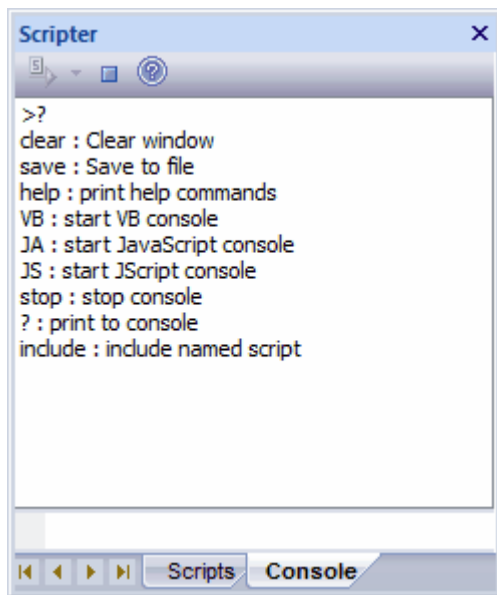

You type the commands in the field at the bottom of the tab; when you press the **[Enter]** key, the script console executes the commands and displays any output immediately.

You can input two types of command:

- Console commands
- Script commands.

### Console Commands

Console commands are preceded by the ! character and instruct the console to perform an action. The available console commands are listed below; to list these commands on the **Console** tab itself (as shown above) type? in the console field (without the preceding ! character) .

- **c(lear)** - clears the console display
- **sa(ve)** - saves the console display to a file
- **h(elp)** - prints a list of commands, as for ?
- **VB** - opens a VBScript console
- **JA** - opens a JavaScript console
- **JS** - opens a JScript console
- **st(op)** - closes any script running console
- **i(nclude) name** - executes the named script item; *name* is of the format *GroupName.ScriptName* (spaces are allowed in names)
- **?** - (without the !) lists commands
- **?name** - Outputs the value of a variable *name* (only if a script console is opened).

### Script Commands

A script command is script code that depends on the script engine. Script commands can be executed only once a script console has been created.

*Examples:*

The following lines, entered into the console, create a *VBScript* console and then execute the script *MyScript* in the user group *MyGroup*.

```
>!VB
>!i MyGroup.MyScript
```

The following lines, entered into the console, create a *JScript* console and then create a variable called **x** with the value **1**.

```
>!JS
>var x = 1
```

The following diagram shows the result of entering the above JScript example. Remember that you can use

?<variable name> to get the current value of any item you have created during the console session.

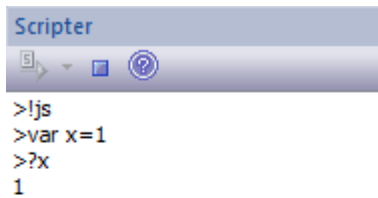

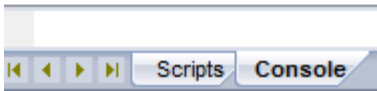

```
Scripter
>!js
>var x=1
>?x
1
```



### Console Tab Toolbar

The **Console** tab has two operations available through the toolbar:

- Open Console (  ) - click on the down-arrow and select to open a VBScript console, JScript console or JavaScript console
- Stop Script (  ) - click to stop an executing script and close the current console.

## 11.2 Enterprise Architect Object Model



### Introduction

Automation provides a way for other applications to access the information in an Enterprise Architect model using Windows OLE Automation (ActiveX). Typically this involves scripting clients such as MS Word or Visual Basic, or using scripts created within Enterprise Architect using the [Scripter window](#)<sup>[1660]</sup>.

The *Automation Interface* provides a way of accessing the internals of Enterprise Architect models. Examples of things you can do using the Automation Interface include:

- Perform repetitive tasks, such as update the version number for all elements in a model
- Generate code from a State Machine diagram
- Produce custom reports
- Perform ad hoc queries.

### Connecting to the Automation Interface

All development environments capable of generating *ActiveX Com* clients should be able to connect to the Enterprise Architect Automation Interface. This guide provides detailed instructions on [connecting to the interface](#)<sup>[1665]</sup> using Microsoft Visual Basic 6.0, Borland Delphi 7.0, Microsoft C# and Java. There are also more detailed steps on how to [set-up Visual Basic](#)<sup>[1668]</sup>; the principles are applicable to other languages.

### Examples and Tips

Instruction on how to use the Automation Interface is provided by means of sample code. See [pointers to the samples](#)<sup>[1669]</sup> and other [available resources](#)<sup>[1671]</sup>. Also, consult the extensive [Reference Section](#)<sup>[1671]</sup>.

### Calling Executables from Enterprise Architect

Enterprise Architect can be set up to call an external application. You can pass parameters on the current position selected in the **Project Browser** to the application being called. For instructions, go to the [Call from Enterprise Architect](#)<sup>[1670]</sup> topic. A more sophisticated method is to create [Add-Ins](#)<sup>[1776]</sup>, which are discussed in a separate topic.

#### 11.2.1 Using the Automation Interface

This section provides instructions on how to connect to and use the Automation Interface, including:

- [Connecting to the Interface](#)<sup>[1665]</sup>
- [Setting References In Visual Basic](#)<sup>[1668]</sup>
- [Examples and Tips](#)<sup>[1669]</sup>

##### 11.2.1.1 Connect to the Interface

All development environments capable of generating ActiveX Com clients should be able to connect to the Enterprise Architect Automation Interface.

By way of example, the following sections describe how to connect using several such tools. The procedure might vary slightly with different versions of these products.

#### Microsoft Visual Basic 6.0

1. Create a new project.
2. Select the **Project | References** menu option.
3. Select *Enterprise Architect Object Model 2.0* from the list. (If this does not appear, go to the command line and re-register Enterprise Architect using

```
EA.exe /unregister
```

then

```
EA.exe /register).
```

4. See the general library documentation on the use of Classes. The following example creates and opens a repository object:

```
Public Sub ShowRepository()
    Dim MyRep As New EA.Repository
    MyRep.OpenFile "c:\eatest.eap"
End Sub
```

## Borland Delphi 7.0

1. Create a new project.
2. Select the **Project | Import Type Library** menu option.
3. Select **Enterprise Architect Object Model 2.0** from the list. (If this does not appear, go to the command line and re-register Enterprise Architect using

```
EA.exe /unregister
```

then

```
EA.exe /register).
```

4. Click on the **Create Unit** button.
5. Include *EA\_TLB* in Project1's *Uses* clause.
6. See the general library documentation on the use of Classes. The following example creates and opens a repository object:

```
procedure TForm1.Button1Click(Sender: TObject);
var
    r: TRepository;
    b: boolean;
begin
    r:= TRepository.Create(nil);
    b:= r.OpenFile('c:\eatest.eap');
end;
```

## Microsoft C#

1. Select the Visual Studio **Project | Add Reference** menu option.
2. Click on the **Browse** tab.
3. Navigate to the folder in which you installed Enterprise Architect (usually Program Files/Sparx Systems/EA) and select Interop.EA.dll.
4. See the general library documentation on the use of Classes. The following example creates and opens a repository object:

```
private void button1_Click(object sender, System.EventArgs e)
{
    EA.Repository r = new EA.RepositoryClass();
    r.OpenFile("c:\eatest.eap");
}
```

## Java

1. Copy the file SSJavaCOM.dll from the Java API subdirectory of your installed directory (usually Program Files/Sparx Systems/EA) into any location within the Windows PATH. For example, the windows\system32 directory.
2. Copy the eaapi.jar file from the *Java API* subdirectory of your installed directory (usually Program Files/Sparx Systems/EA) to a location in the Java CLASSPATH or where the Java class loader can find it at run time.
3. All of the Classes described in the documentation are in the package org.sparx. See the [general library documentation](#)<sup>[1677]</sup> for their use. The following example creates and opens a repository object.

```
public void OpenRepository()
```

```

{
    org.sparx.Repository r = new org.sparx.Repository();
    r.OpenFile("c:\\eatest.eap");
}

```

### 11.2.1.1.1 Set References In Visual Basic

This topic describes how to use the Enterprise Architect ActiveX interface with Visual Basic (VB). Use is ensured for Visual Basic version 6. This might vary slightly with versions other than version 6.

It is assumed that you have accessed VB through a Microsoft Application such as VB 6.0, MS Word or MS Access. If the code is not called from within Word, the *Word VB* reference must also be set.

On creating a new VB project, set a reference to an Enterprise Architect Type Library and a Word Type Library. Follow the steps below:

1. Select the **Tools | References** menu option. The following dialog displays:

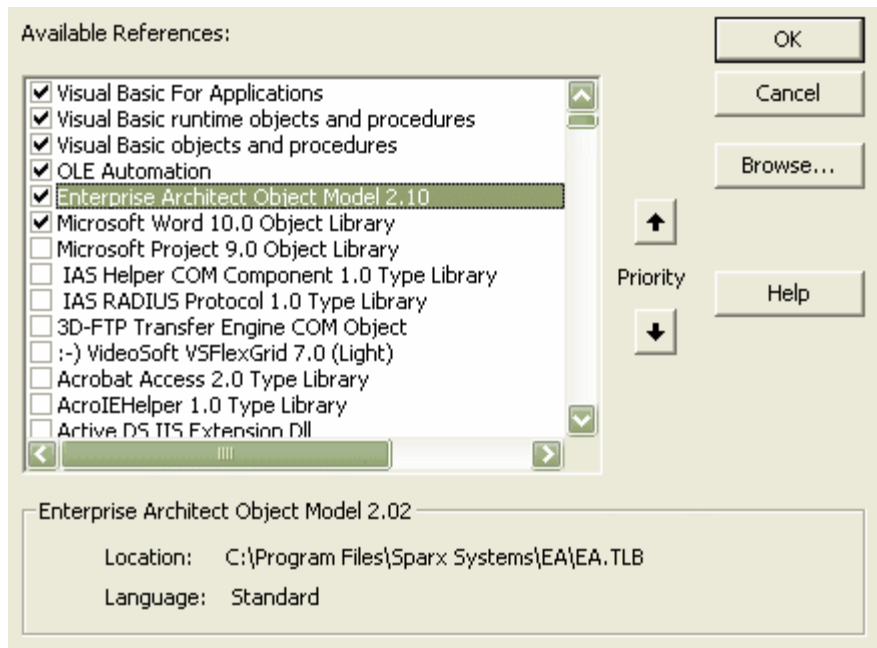

2. Select the **Enterprise Architect Object Model 2.10** checkbox from the list.
3. Do the same for VB or VB Word: select the checkbox for the **Microsoft Word 10.0 Object Library**.
4. Click on the **OK** button.

#### Note:

If Enterprise Architect Object Model 2.10 does not appear in the list, go to the command line and manually re-enter Enterprise Architect using the following:

- To unregister Enterprise Architect: ea.exe /unregister
- To register Enterprise Architect: ea.exe /register.

**Visual Basic 5/6 users** should also note that the version number of the Enterprise Architect interface is stored in the VBP project file in a form similar to the following:

```
Reference=*G{64FB2BF4-9EFA-11D2-8307-C45586000000}#2.2#0#..\..\..\Program Files\Sparx Systems\EA\EA.TLB#Enterprise Architect Object Model 2.02
```

If you experience problems moving from one version of Enterprise Architect to another, open the VBP file in a text editor and remove this line. Then open the project in Visual Basic and use **Project-References** to create a new reference to the Enterprise Architect Object model.



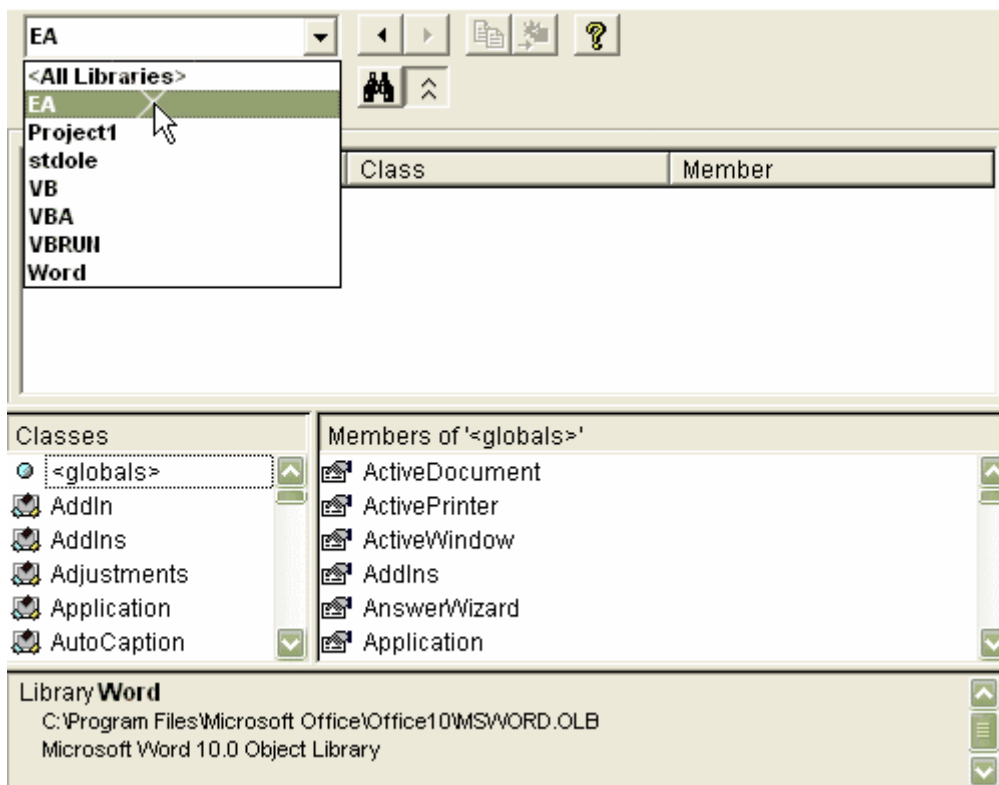

Reference to objects in Enterprise Architect and Word should now be available in the **Object Browser**. This can be accessed from the main menu by selecting **View | Object Browser**, or by pressing **[F2]**.

The drop-down list on the top-left of the window should now include Enterprise Architect and Word. If MS-Project is installed this must also be set up.

### 11.2.1.2 Examples and Tips

Instructions for using the interface are provided through sample code. There are several sets of examples:

- VB 6 and C# examples are available in the *Code Samples* folder under your Enterprise Architect installation (default: C:\Program Files\Sparx Systems\EA\Code Samples)
- Enterprise Architect can be set up to [call an external application](#)<sup>[1670]</sup>
- Several VB.NET code snippets are provided in the [reference section](#)<sup>[1765]</sup>
- A comprehensive example of using Visual Basic to create MS Word documentation is available from the internet at [www.sparxsystems.com/resources/developers/autint\\_vb.html](http://www.sparxsystems.com/resources/developers/autint_vb.html)
- Additional samples are available from the Sparx Systems website; see the [Available Resources](#)<sup>[1671]</sup> topic.

Additionally, you should note the following tips and tricks:

- An instance of the Enterprise Architect (EA.exe) process is executed when you initialize a new repository object. This process must remain running in order to perform automation tasks. If the main window is visible, you can safely minimize it, but it must remain running.
- The Enterprise Architect ActiveX Interface is a functional interface rather than a data interface. When you load data through the interface there is a noticeable delay as Enterprise Architect user interface elements (such as Windows, menus) are loaded and the specified database connection is established.
- Collections use a zero-based index; for example, Repository.Models(0) represents the first model in the repository.
- During the development of your client software your program might terminate unexpectedly and leave EA.exe running in such a state that it is unable to support further interface calls. If your program terminates abnormally, ensure that Enterprise Architect is not left running in the background (see the Windows **Task Manager / Process** tab).
- A handle to a currently running instance of Enterprise Architect can be obtained through the use of a GetObject() call. For more information, refer to the reference page for the [App](#)<sup>[1674]</sup> object. Accessing your

Enterprise Architect model via the *App* object enables querying the current User Interface status, such as using `GetCurrentItem()` on the [Repository](#) <sup>[1680]</sup> object to detect the current selection by the user, allowing for rapid prototyping and testing.

## Enterprise Architect Not Closing

If your automation controller was written using the .NET framework, Enterprise Architect does not close even after you release all your references to it. To force the release of the COM pointers, call the memory management functions as shown below:

```
GC.Collect();
GC.WaitForPendingFinalizers();
```

There are additional concerns when controlling a running instance of Enterprise Architect that loads Add-Ins - see the [Tricks and Traps](#) <sup>[1779]</sup> topic for details.

### 11.2.1.2.1 Call from Enterprise Architect

Enterprise Architect can be set up to call an external application. You can pass parameters on the current position selected in the **Project Browser** to the application being called.

To define an application that you can run from Enterprise Architect, select the **Tools | Customize** menu option. The **Customize** dialog displays. Select the **Tools** tab.

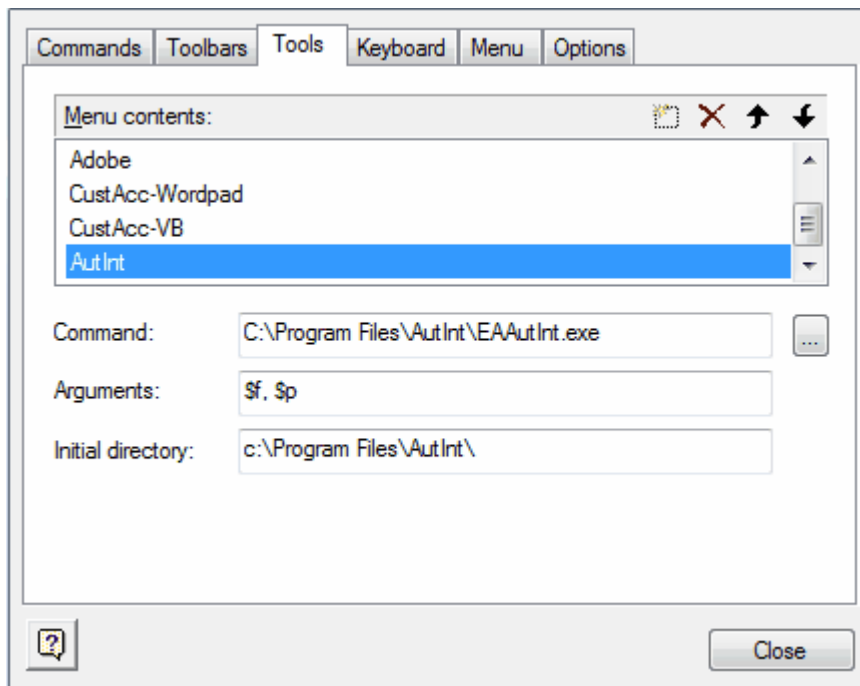

With this you can:

- Add a command line for an application
- Define parameters to pass to this application

The parameters required for running the `AutInt` executable are:

- The Enterprise Architect file parameter `$f` and
- The current PackageID `$p`

Hence the arguments should simply contain: `$f, $p`

The available parameters for passing information to external applications are:

Parameter	Description	Notes
\$d	Diagram ID	ID for accessing associated diagram.
\$D	Diagram GUID	GUID for accessing the associated diagram.

Parameter	Description	Notes
\$e	Comma separated list of element IDs	All elements selected in the current diagram.
\$E	Comma separated list of element GUIDs	All elements selected in the current diagram.
\$f	Project Name	For example: C:\projects\EAexample.eap.
\$F	Calling Application (Enterprise Architect)	'Enterprise Architect'.
\$p	Current Package ID	For example: 144.
\$P	Package GUID	GUID for accessing this package.

Once this has been set up, the application can be called from the main menu in Enterprise Architect using the **Tools | YourApplication** menu option.

### 11.2.1.2.2 Available Resources

Other available resources include:

Resource	Download Link
VB 6 Add-In for generating MS Word documentation.	<a href="http://www.sparxsystems.com/resources/developers/autint_vb.html">www.sparxsystems.com/resources/developers/autint_vb.html</a>
VB 6 Add-In to display a custom ActiveX graph control within the Enterprise Architect window as a new view.	<a href="http://www.sparxsystems.com/resources/developers/autint_vb_custom_view.html">www.sparxsystems.com/resources/developers/autint_vb_custom_view.html</a>
A basic Add-In framework written in C#. Useful as a starting point for authoring your own custom Enterprise Architect Add-In.	<a href="http://www.sparxsystems.com/bin/CS_AddinFramework.zip">www.sparxsystems.com/bin/CS_AddinFramework.zip</a>
An extension on the <i>CS_AddinFramework</i> example showing how to export Tagged Values to a .csv file.	<a href="http://www.sparxsystems.com/bin/CS_AddinTaggedCSV.zip">www.sparxsystems.com/bin/CS_AddinTaggedCSV.zip</a>
A basic Add-In skeleton written in Delphi.	<a href="http://www.sparxsystems.com/bin/DelphiDemo.zip">www.sparxsystems.com/bin/DelphiDemo.zip</a>
A simple example Add-In written in C#.	<a href="http://www.sparxsystems.com/bin/CS_Sample.zip">www.sparxsystems.com/bin/CS_Sample.zip</a>

For further information, see [www.sparxsystems.com/resources/developers/autint.html](http://www.sparxsystems.com/resources/developers/autint.html).

## 11.2.2 Reference

This section provides detailed information on all the objects available in the object model provided by the Automation Interface, covering:

- [Interface Overview](#) <sup>[1672]</sup>
- [App](#) <sup>[1674]</sup>
- [Enumerations](#) <sup>[1675]</sup>
- [Repository](#) <sup>[1679]</sup>
- [Element](#) <sup>[1708]</sup>
- [Element Features](#) <sup>[1726]</sup>
- [Connector](#) <sup>[1738]</sup>
- [Diagram Package](#) <sup>[1745]</sup>
- [Project Interface](#) <sup>[1753]</sup>
- [Code Samples](#) <sup>[1765]</sup>

### 11.2.2.1 Interface Overview

#### public Package

This package provides an overview of the main elements within the Automation Interface. These are:

- The [Repository](#)<sup>[1679]</sup>, which represents the model as a whole and provides entry to model packages and collections
- [Elements](#)<sup>[1708]</sup>, which are the basic structural unit (such as Class, Use Case and Object)
- [Element Features](#)<sup>[1726]</sup>, which are attributes and operations defined on an element
- [Diagram Package](#)<sup>[1745]</sup>, the visible drawings contained in the model
- [Connectors](#)<sup>[1738]</sup>, relationships between elements.

The following diagram illustrates the main interface elements and their associated contents. Each element in this document is creatable by Automation and can be accessed through the various collections that exist or, in some cases, directly.

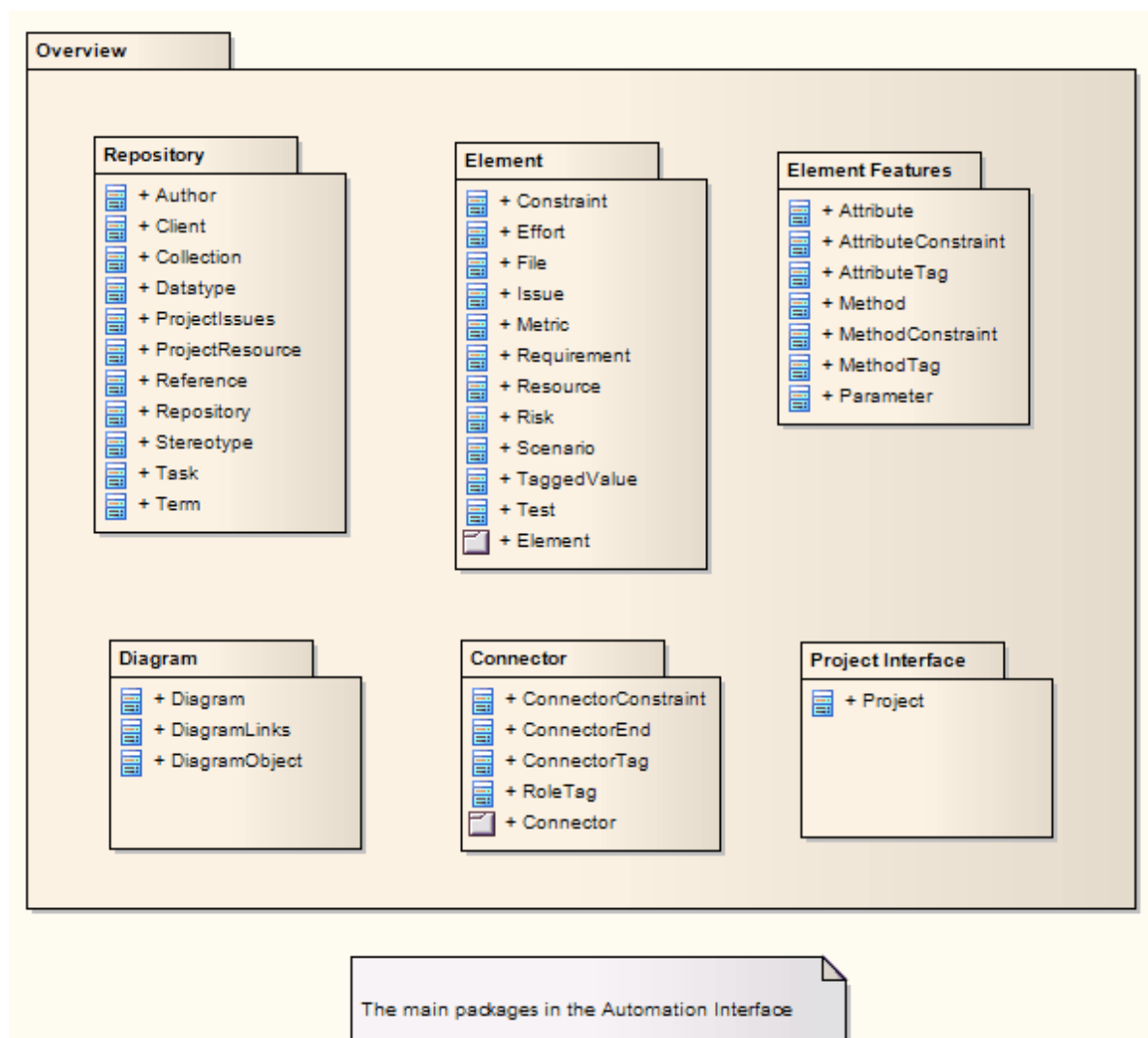

The following diagram provides a high level overview of the Automation Interface for accessing, manipulating, modifying and creating elements. The top level object is the Repository, which contains collections for a variety of system level objects, as well as the main Models collection that provides access to the UML elements, diagrams and packages within the project. In general, the Role names applied at the Target end of associations indicate the name of the Collection that is used to access instances of that object.

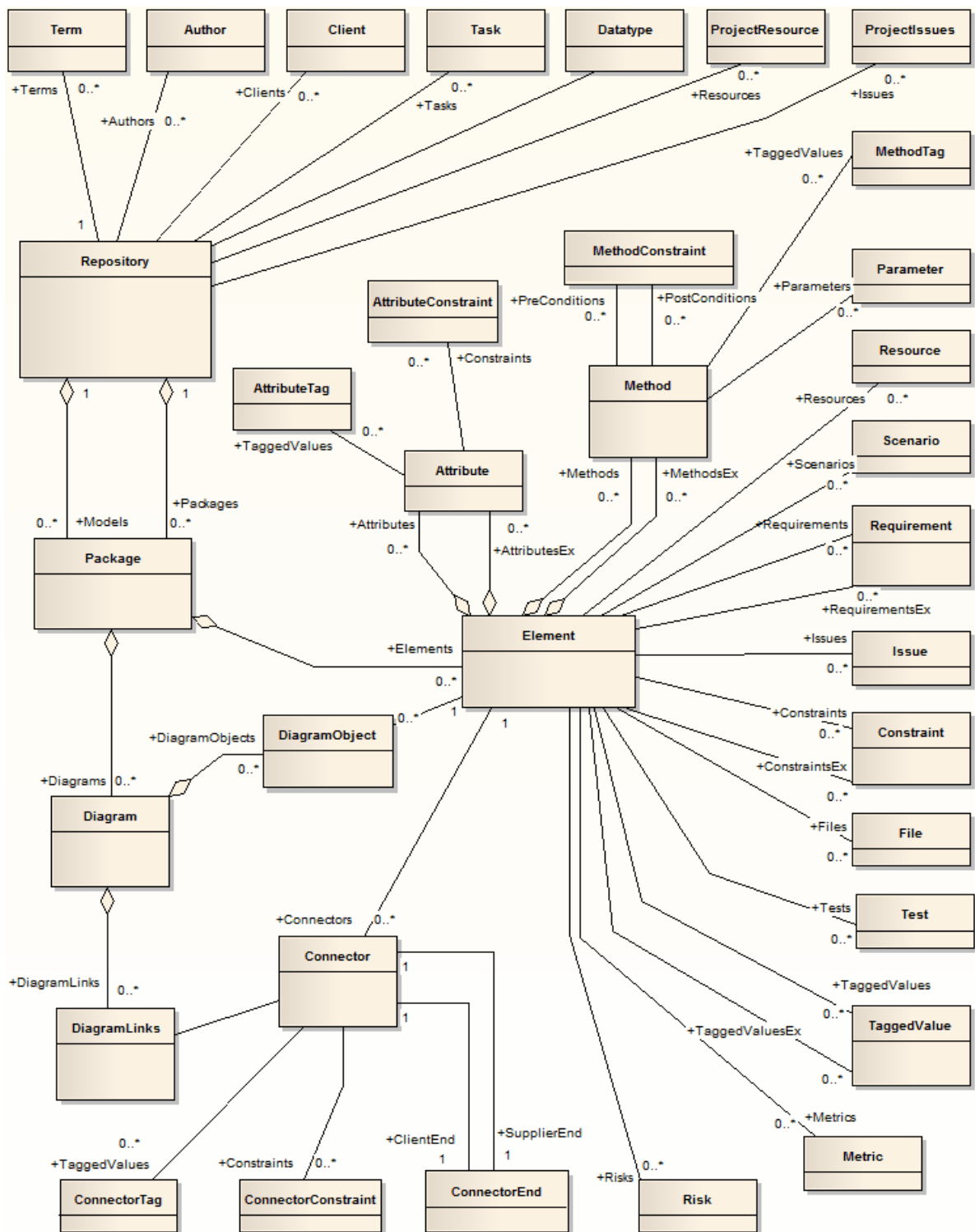

## Internal Links

- Logical diagram:: Automation Interface  
Package:: Automation Interface
- Logical diagram:: Automation Interface  
Package:: Automation Interface
- Logical diagram:: Automation Interface  
Package:: Automation Interface
- Logical diagram:: Automation Interface

- Package:: Automation Interface
- Logical diagram:: Automation Interface  
Package:: Automation Interface
- Logical diagram:: Automation Interface  
Package:: Automation Interface
- Logical diagram:: Automation Interface  
Package:: Automation Interface

## Connectors

Connector	Source	Target
<i>Nesting</i> source > target	<i>Connector</i> Contained Element	<i>Overview</i> Containing Element
<i>Nesting</i> source > target	<i>Repository</i> Contained Element	<i>Overview</i> Containing Element
<i>Nesting</i> source > target	<i>Diagram</i> Contained Element	<i>Overview</i> Containing Element
<i>Nesting</i> source > target	<i>Element</i> Contained Element	<i>Overview</i> Containing Element
<i>Nesting</i> source > target	<i>Project Interface</i> Contained Element	<i>Overview</i> Containing Element
<i>Nesting</i> source > target	<i>ElementFeatures</i> Contained Element	<i>Overview</i> Containing Element

### 11.2.2.2 App

The *App* object represents a running instance of Enterprise Architect. Its object provides access to the Automation Interface.

Attribute	Type	Notes
Project	Project	Read only. Provides a handle to the Project Interface.
Repository	Repository	Read only. Provides a handle to the Repository object.
Visible	Boolean	Read/Write. Whether or not the application is visible.

## GetObject() Support

The *App* object is creatable and a handle can be obtained by creating one. In addition, clients can use the equivalent of Visual Basic's *GetObject()* to obtain a reference to a currently running instance of Enterprise Architect.

Use this method to more quickly test changes to Add-Ins and external clients, as the Enterprise Architect application and data files do not have to be constantly re-loaded.

For example:

```
Dim App as EA.App
Set App = GetObject("EA.App")
MsgBox App.Repository.Models.Count
```

Another example, which uses the *App* object without saving it to a variable:

```
Dim Rep as EA.Repository
Set Rep = GetObject("EA.App").Repository
MsgBox Rep.ConnectionString
```

### 11.2.2.3 Enumerations

These enumerations are defined by the Automation Interface:

- [ConstLayoutStyles](#)<sup>[1675]</sup>
- [CreateBaselineFlag](#)<sup>[1676]</sup>
- [CreateModelType](#)<sup>[1676]</sup>
- [EAEditionTypes](#)<sup>[1676]</sup>
- [EnumRelationSetType](#)<sup>[1676]</sup>
- [ExportPackageXMIFlag](#)<sup>[1677]</sup>
- [MDGMenus](#)<sup>[1677]</sup>
- [ObjectType](#)<sup>[1677]</sup>
- [PropType](#)<sup>[1678]</sup>
- [ReloadType](#)<sup>[1678]</sup>
- [ScenarioDiagramType](#)<sup>[1678]</sup>
- [ScenarioStepType](#)<sup>[1679]</sup>
- [ScenarioTestType](#)<sup>[1679]</sup>
- [XMIType](#)<sup>[1679]</sup>

#### 11.2.2.3.1 ConstLayoutStyles Enum

The *enum* values defined here are used exclusively for the *Lay Out a Diagram* method. They enable you to define the layout options as depicted in the **Layout Diagram** menu option. For further information, see the [Lay Out a Diagram](#)<sup>[471]</sup> topic.

Method	Use to
<i>IsCrossReduceAggressive</i>	Perform aggressive Cross-reduction in the layout process (time consuming).
<i>IsCycleRemoveDFS</i>	Use the <i>Depth First Cycle Removal</i> algorithm.
<i>IsCycleRemoveGreedy</i>	Use the <i>Greedy Cycle Removal</i> algorithm.
<i>IsDiagramDefault</i>	Use existing layout options specified for this diagram.
<i>IsInitializeDFSIn</i>	Initialize the layout using the <i>Depth First Search Inward</i> algorithm.
<i>IsInitializeNaive</i>	Initialize the layout using the <i>Naïve Initialize Indices</i> algorithm.
<i>IsInitializeDFSOut</i>	Initialize the layout using the <i>Depth First Search Outward</i> algorithm.
<i>IsLayeringLongestPathSink</i>	Layer the diagram using the <i>Longest Path Sink</i> algorithm.
<i>IsLayeringLongestPathSource</i>	Layer the diagram using the <i>Longest Path Source</i> algorithm.
<i>IsLayeringOptimalLinkLength</i>	Layer the diagram using the <i>Optimal Link Length</i> algorithm.
<i>IsLayoutDirectionDown</i>	Direct connectors to point downwards.
<i>IsLayoutDirectionLeft</i>	Direct connectors to point leftwards.
<i>IsLayoutDirectionRight</i>	Direct connectors to point rightwards.
<i>IsLayoutDirectionUp</i>	Direct connectors to point upwards.
<i>IsProgramDefault</i>	Use factory default layout options as specified by Enterprise Architect.

### 11.2.2.3.2 CreateBaselineFlag Enum

The *CreateBaselineFlag* enumeration is used in Baseline Management, when creating a Baseline.

Method	Use to
<i>cbSaveToStub</i>	Baseline this package with only immediate children. (Child packages are included as stubs only.)

### 11.2.2.3.3 CreateModelType Enum

The *CreateModelType* enumeration is used in the [CreateModel](#)<sup>[1682]</sup> method on the Repository class.

Method	Use to
<i>cmEAPFromBase</i>	Create a copy of the EABase model file to the specified file path.
<i>cmEAPFromSQLRepository</i>	Create a .eap file shortcut to an SQL-based repository. Requires user interaction to provide sql connection details.

### 11.2.2.3.4 EAEditionTypes Enum

The *EAEditionTypes* enumeration identifies the level of licensed functionality available to the current repository. For example:

```
EAEditionTypes theEdition = theRepository.GetEAEdition();
if ( theEdition == EAEditionTypes.piDesktop )
    ...
else if ( theEdition == EAEditionTypes.piProfessional )
    ...
```

The enumeration defines the following formal values:

- *piLite*
- *piDesktop*
- *piProfessional*
- *piCorporate*
- *piBusiness*
- *piSystemEng*
- *piUltimate*.

There is no separate value for the trial edition; the *Repository.EAEdition* attribute contains the appropriate **EAEditionTypes** value for whichever edition the user has selected to trial.

### 11.2.2.3.5 EnumRelationSetType Enum

This enumeration represents values returned from the *GetRelationSet* method of the [Element](#)<sup>[1711]</sup> object.

Method	Notes
<i>rsDependEnd</i>	List of elements that depend on the current element.
<i>rsDependStart</i>	List of elements that the current element depends on.
<i>rsGeneralizeEnd</i>	List of elements that are generalized by the current element.
<i>rsGeneralizeStart</i>	List of elements that the current element generalizes.
<i>rsParents</i>	List of all parent elements of the current element.
<i>rsRealizeEnd</i>	List of elements that are realized by the current element.
<i>rsRealizeStart</i>	List of elements that the current element realizes.



### 11.2.2.3.6 ExportPackageXMIFlag Enum

The *ExportPackageXMIFlag* enumeration is used in package control, when exporting to XMI.

Method	Use to
<i>epSaveToStub</i>	Export this package with only immediate children. (Child packages are included as stubs only.)

### 11.2.2.3.7 MDGMenus Enum

Use this enumeration when providing the *HiddenMenus* property to *MDG\_GetProperty*.

These options are exclusive of one another and can be read or added to hide more than one menu.

See the [MDG\\_GetProperty](#)<sup>[1824]</sup> topic for an example of use.

Method	Use to
<i>mgBuildProject</i>	Hide <b>Build Project</b> menu option.
<i>mgMerge</i>	Hide <b>Merge</b> menu option.
<i>mgRun</i>	Hide <b>Run</b> menu option.

### 11.2.2.3.8 ObjectType Enum

The *ObjectType* enumeration identifies Enterprise Architect object types even when referenced through a Dispatch interface.

For example:

```
Object ob = Repository.GetElementByID(13);
if ( ob.ObjectType == otElement )
;
else if( ob.ObjectType == otAuthor )
...

```

All of the following are valid enumeration values:

<i>otAttribute</i>	<i>otPackage</i>
<i>otAttributeConstraint</i>	<i>otParameter</i>
<i>otAttributeTag</i>	<i>otPartition</i>
<i>otAuthor</i>	<i>otProject</i>
<i>otClient</i>	<i>otProjectIssues</i>
<i>otCollection</i>	<i>otProjectResource</i>
<i>otConnector</i>	<i>otProperties</i>
<i>otConnectorConstraint</i>	<i>otProperty</i>
<i>otConnectorEnd</i>	<i>otPropertyType</i>
<i>otConnectorTag</i>	<i>otReference</i>
<i>otConstraint</i>	<i>otRepository</i>
<i>otCustomProperty</i>	<i>otRequirement</i>
<i>otDatatype</i>	<i>otResource</i>
<i>otDiagram</i>	<i>otRisk</i>
<i>otDiagramLink</i>	<i>otRoleTag</i>
<i>otDiagramObject</i>	<i>otScenario</i>
<i>otEffort</i>	<i>otScenarioExtension</i>
<i>otElement</i>	<i>otScenarioStep</i>
<i>otEventProperties</i>	<i>otStereotype</i>
<i>otEventProperty</i>	<i>otSwimlane</i>
<i>otFile</i>	<i>otSwimlaneDef</i>
<i>otIssue</i>	<i>otSwimlanes</i>
<i>otMethod</i>	<i>otTaggedValue</i>
<i>otMethodConstraint</i>	<i>otTask</i>
<i>otMethodTag</i>	<i>otTerm</i>
<i>otMetric</i>	<i>otTest</i>
<i>otModel</i>	<i>otTransition</i>

*otNone*

### 11.2.2.3.9 PropType Enum

The *PropType* enumeration gives the automation programmer an indication of what sort of data is going to be stored by this property.

Method	Notes
<i>ptArray</i>	An array containing values of any type.
<i>ptBoolean</i>	True or False.
<i>ptEnum</i>	A string being an entry in the semi-colon separated list specified in the validation field of the Property.
<i>ptFloatingPoint</i>	4 or 8 byte floating point value.
<i>ptInteger</i>	16-bit or 32-bit signed integer.
<i>ptString</i>	Unicode string.

### 11.2.2.3.10 ReloadType Enum

This enumeration represents values returned from the *GetReloadItem* and *PeekReloadItem* methods of the *ModelWatcher* Class. It has four possible values, which define the type of change that was made to a model.

Method	Notes
<i>rtElement</i>	The <i>Item</i> parameter represents a particular element that must be reloaded.
<i>rtEntireModel</i>	Entire model must be reloaded to ensure that all changes are reloaded.
<i>rtNone</i>	No change in the model.
<i>rtPackage</i>	The <i>Item</i> parameter represents a particular package that must be reloaded.

### 11.2.2.3.11 ScenarioDiagramType Enum

The *ScenarioDiagramType* enumeration provides the following enumeration values to the [Project.GenerateDiagramFromScenario\(\)](#) <sup>[175]</sup> method. They specify the type of diagram to generate.

Method	Use to
<i>sdActivity</i>	<a href="#">Generate an Activity diagram</a> <sup>[500]</sup>
<i>sdActivityWithAction</i>	<a href="#">Generate an Activity diagram with an Action</a> <sup>[500]</sup> .
<i>sdActivityWithActionPin</i>	<a href="#">Generate an Activity diagram with an ActionPin</a> <sup>[500]</sup> .
<i>sdActivityWithActivityParameter</i>	<a href="#">Generate an Activity diagram with an ActivityParameter.</a> <sup>[500]</sup>
<i>sdRobustness</i>	<a href="#">Generate a Robustness diagram.</a> <sup>[504]</sup>
<i>sdRuleFlow</i>	<a href="#">Generate a RuleFlow diagram.</a> <sup>[504]</sup>
<i>sdSequence</i>	<a href="#">Generate a Sequence diagram.</a> <sup>[503]</sup>
<i>sdState</i>	<a href="#">Generate a State Machine diagram.</a> <sup>[504]</sup>

### 11.2.2.3.12 ScenarioStepType Enum

The *ScenarioStepType* enumeration is used to identify the [steps](#)<sup>[1723]</sup> of a scenario, and the entity performing the step.

Method	Use to
<i>stActor</i>	Identify that the step is an action performed by an actor.
<i>stSystem</i>	Identify that the step is an action performed by the system.

### 11.2.2.3.13 ScenarioTestType Enum

The *ScenarioTestType* enumeration provides the following enumeration values to the [Project.GenerateTestFromScenario\(\)](#)<sup>[1758]</sup> method. They specify the type of [test to generate](#)<sup>[505]</sup>.

Method	Use to
<i>stExternal</i>	Generate an external Test Case element.
<i>stInternal</i>	Generate an internal test.

### 11.2.2.3.14 XMISType Enum

The following enumeration values are used in the *Project.ExportPackageXMI()* method. They enable specification of the XML export type.

*xmiEADefault*  
*xmiRoseDefault*  
*xmiEA10*  
*xmiEA11*  
*xmiEA12*  
*xmiEA20*  
*xmiEA21*  
*xmiMOF13*  
*xmiMOF14*  
*xmiRose10*  
*xmiRose11*  
*xmiRose12*

## 11.2.2.4 Repository

### public Package

The *Repository* package contains the high level system objects and entry point into the model itself using the *Models* collection and the other system level collections.

This diagram illustrates the [Repository](#)<sup>[1680]</sup> and its first level functions and collections.

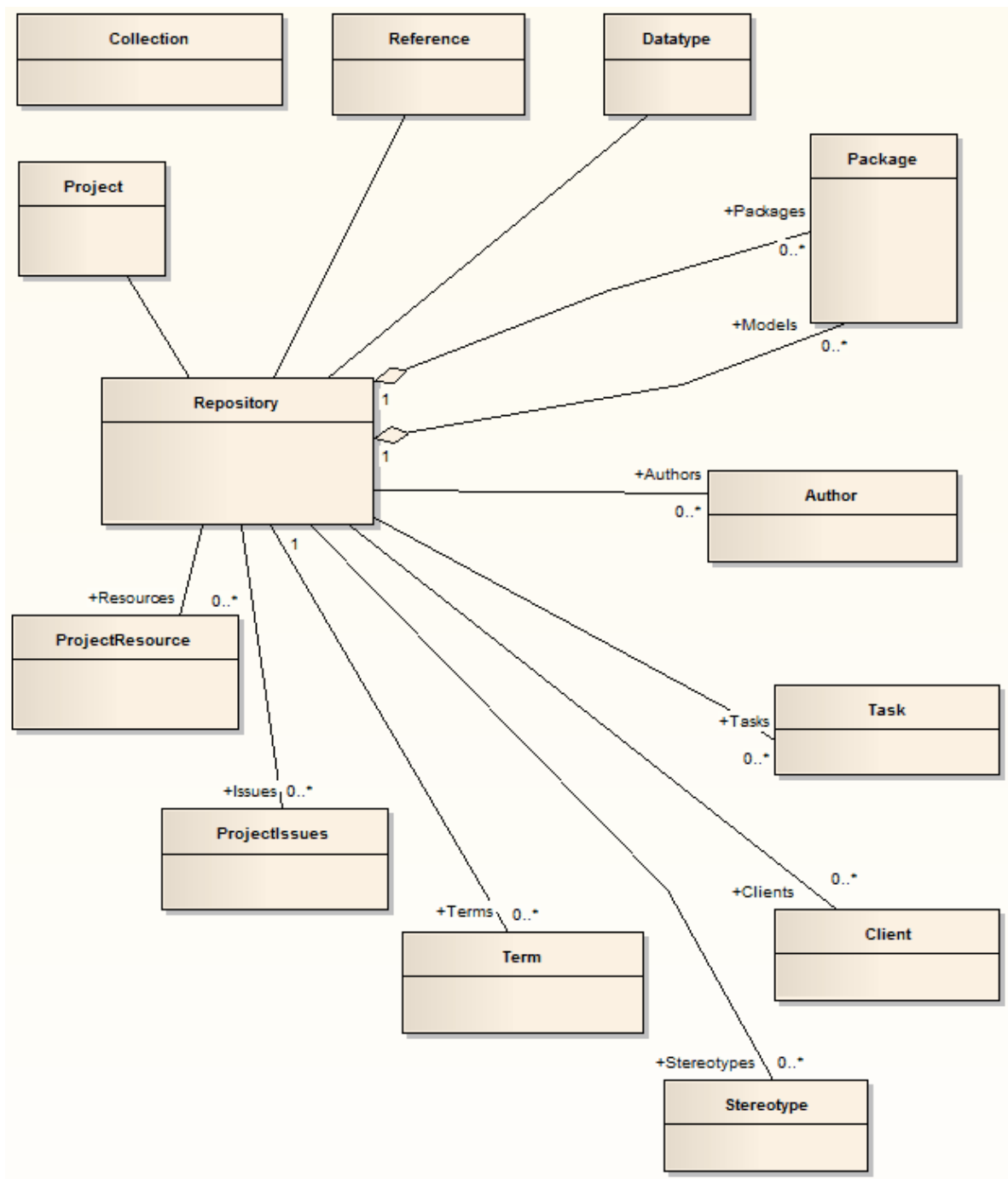

#### 11.2.2.4.1 Repository

##### public Class

The *Repository* is the main container of all structures such as models, packages and elements. You can iteratively begin accessing the model using the *Models* collection. It also has some convenient methods to directly access the structures without having to locate them in the hierarchy first.

Associated table in .EAP file: *<none>*

## Repository Attributes

Attribute	Type	Notes
<b>Authors</b>	<a href="#">Collection</a> <sup>1695</sup>	Read only. The system <i>Authors</i> collection. Contains 0 or more <i>Author objects</i> , each of which can be associated with, for example, elements or diagrams as the item author or owner. Use <i>AddNew</i> , <i>Delete</i> and <i>GetAt</i> to manage Authors.
<b>BatchAppend</b>	<i>Boolean</i>	Read/Write. Set this property to <b>true</b> when your automation client has to rapidly insert many elements, operations, attributes and/or operation parameters. Set to <b>false</b> when work is complete.  This can result in 10- to 20-fold improvement in adding new elements in bulk.
<b>Clients</b>	<a href="#">Collection</a> <sup>1695</sup>	Read only. A list of <i>Clients</i> associated with the project. You can modify, delete and add new <i>Client objects</i> using this collection.
<b>ConnectionString</b>	<i>String</i>	Read only. The filename/connection string of the current Repository.
<b>Datatypes</b>	<a href="#">Collection</a> <sup>1695</sup>	Read only. The <i>Datatypes</i> collection. Contains a list of <i>Datatype objects</i> , each representing a data type definition for either data modeling or code generation purposes.
<b>EAEdition</b>	<a href="#">EAEditionType</a> <a href="#">es</a> <sup>1676</sup>	Read only. Returns the level of core licensed functionality available to the current repository.  <b>Note:</b>  This property returns <b>Corporate</b> when the edition is <i>Business and Software Engineering</i> , <i>Systems Engineering</i> or <i>Ultimate</i> . Use <b>EAEditionEx</b> to identify which of these extended editions is available.
<b>EAEditionEx</b>	<a href="#">EAEditionType</a> <a href="#">es</a> <sup>1676</sup>	Read only. Returns the level of extended licensed functionality available to the current repository.
<b>EnableCache</b>	<i>Boolean</i>	Read/Write. An optimization for pre-loading package objects when dealing with large sets of automation objects.
<b>EnableUIUpdates</b>	<i>Boolean</i>	Read/Write. Set this property to <b>false</b> to improve the performance of changes to the model; for example, bulk addition of elements to a package. To reveal the changes to the user, call <i>Repository.RefreshModelView()</i> .
<b>FlagUpdate</b>	<i>Boolean</i>	Read/Write. Instructs Enterprise Architect to update the Repository with the <i>LastUpdate</i> value.
<b>InstanceGUID</b>	<i>String</i>	Read only. The identifier string identifying the Enterprise Architect runtime session.
<b>IsSecurityEnabled</b>	<i>Boolean</i>	Read only. Checks whether User Security is enabled for the current repository.
<b>Issues</b>	<a href="#">Collection</a> <sup>1695</sup>	Read only. The <i>System Issues</i> list. Contains <i>ProjectIssues objects</i> , each detailing a particular issue as it relates to the project as a whole.
<b>LastUpdate</b>	<i>String</i>	Read only. The identifier string identifying the Enterprise Architect runtime session and the timestamp for when it was set.

Attribute	Type	Notes
LibraryVersion	Long	Read only. The build number of the Enterprise Architect runtime.
Models	<a href="#">Collection</a> <sup>[1695]</sup> of type <a href="#">Package</a> <sup>[1695]</sup>	<p>Read only. <i>Models</i> are of type <i>package</i> and belong to a collection of packages. This is the top level entry point to an Enterprise Architect project file. Each model is a <i>root node</i> in the <b>Project Browser</b> and can contain items such as Views and packages.</p> <p>A model is a special form of a package; it has a <i>ParentID</i> of <b>0</b>. By iterating through all models, you can access all the elements within the project hierarchy.</p> <p>You can also use the <i>AddNew</i> function to create a new model. A model can be deleted, but remember that everything contained in the model is deleted as well.</p>
ObjectType	<a href="#">ObjectType</a> <sup>[1677]</sup>	Read only. Distinguishes objects referenced through the Dispatch interface.
ProjectGUID	String	Read only. Returns a unique ID for the project.
PropertyTypes	<a href="#">Collection</a> <sup>[1695]</sup>	Read only. Collection of <a href="#">Property Types</a> <sup>[1704]</sup> available to the Repository.
Resources	<a href="#">Collection</a> <sup>[1695]</sup>	Read only. Contains available <i>ProjectResource</i> objects to assign to work items within the project. Use the <b>add new</b> , <b>modify</b> and <b>delete</b> functions to manage resources.
Stereotypes	<a href="#">Collection</a> <sup>[1695]</sup>	Read only. The <a href="#">Stereotype</a> <sup>[1705]</sup> collection. A list of <i>Stereotype objects</i> that contain information on a stereotype and which elements it can be applied to.
SuppressEADialogs	Boolean	Read/Write. Set this property in the <a href="#">EA_OnPostNewElement</a> <sup>[1795]</sup> or <a href="#">EA_OnPostNewConnector</a> <sup>[1795]</sup> broadcast events to control whether Enterprise Architect should suppress showing the default <b>Properties</b> dialogs to the user when an element or connector is created.
Tasks	<a href="#">Collection</a> <sup>[1695]</sup>	Read only. A list of system tasks (to do list). Each entry is a <a href="#">Task</a> <sup>[1707]</sup> <i>Item</i> ; you can modify, delete and add new tasks.
Terms	<a href="#">Collection</a> <sup>[1695]</sup>	Read only. The project <i>Glossary</i> . Each <a href="#">Term</a> <sup>[1708]</sup> object is an entry in the Glossary. Add, modify and delete Terms to maintain the Glossary.

## Repository Methods

Method	Type	Notes
ActivateDiagram (long DiagramID)		<p>Activates an already open diagram (that is, makes it the active tab) in the main Enterprise Architect user interface.</p> <p>Parameters:</p> <ul style="list-style-type: none"> <li>DiagramID: Long - the ID of the diagram to make active.</li> </ul>
ActivatePerspective (string, long)	Boolean	<b>Deprecated</b> - no longer in use.
ActivateTab (string Name)		<p>Activates an open Enterprise Architect tabbed view.</p> <p>Parameters:</p>







Method	Type	Notes
		<ul style="list-style-type: none"> <li>Name: String - the name of the view to activate.</li> </ul>
<b>ActivateTechnology (string Name)</b>		<p>Activates an enabled MDG Technology.</p> <p>Parameters:</p> <ul style="list-style-type: none"> <li>Name: String - the name of the Technology to activate.</li> </ul>
<b>ActivateToolbox (string Toolbox, long Options)</b>	<i>Boolean</i>	<p>Activates a <b>Toolbox</b> page in the GUI.</p> <p>Returns <b>true</b> if the specified <b>Toolbox</b> page is successfully activated, otherwise returns <b>false</b>.</p> <p>Parameters:</p> <ul style="list-style-type: none"> <li>Toolbox: String - the name of the <b>Toolbox</b> page to activate.</li> <li>Options: Long - reserved for future use.</li> </ul>
<b>AddDefinedSearches (string sXML)</b>		<p>Enables you to enter a set of defined searches that last in Enterprise Architect for the life of the application. When Enterprise Architect loads again they must be inserted again by your Add-In.</p> <p>Parameters:</p> <ul style="list-style-type: none"> <li>sXML: String - the XML of the defined searches; you can get this XML by performing an <i>export</i> of the searches from the <a href="#">Manage Searches</a> <sup>[1235]</sup> dialog in Enterprise Architect.</li> </ul>
<b>AddPerspective (string Perspective, long Options)</b>	<i>Boolean</i>	<b>Deprecated</b> - no longer in use.
<b>AddTab (string TabName, string ControlID)</b>	<i>activeX custom control</i>	<p>Adds an ActiveX custom control as a tabbed window. Enterprise Architect creates a control and, if successful, returns its Unknown pointer, which can be used by the caller to manipulate the control.</p> <p>Parameters:</p> <ul style="list-style-type: none"> <li>TabName: String - used as the tab caption.</li> <li>ControlID: String - the ProgID of the control; for example, Project1, UserControl1.</li> </ul>
<b>AddWindow (string WindowName, string ControlID)</b>	<i>activeX custom control</i>	<p>Adds an ActiveX custom control as a window to the <b>Add-Ins</b> docked window. Enterprise Architect creates a control and, if successful, returns its Unknown pointer, which can be used by the caller to manipulate the control.</p> <p>The window can be shown by selecting it from the list in the <a href="#">Workspace Layouts</a> <sup>[86]</sup> toolbar - click on the third icon from the <i>right</i> and look at the end of the list.</p> <p>Parameters:</p> <ul style="list-style-type: none"> <li>WindowName: String - used as the window title.</li> <li>ControlID: String - the ProgID of the control; for example, Project1, UserControl1.</li> </ul>
<b>AdviseConnectorChange (long ConnectorID)</b>		<p>Provides an Add-In or automation client with the ability to advise the Enterprise Architect user interface that a particular connector has changed and, if it is visible in any open diagram, to reload and refresh that connector for the user.</p> <p>Parameters:</p> <ul style="list-style-type: none"> <li>ConnectorID: Long - the ID of the connector.</li> </ul>
<b>AdviseElementChange (long</b>		<p>Provides an Add-In or automation client with the ability to advise the Enterprise Architect user interface that a</p>

Method	Type	Notes
<b>ObjectID)</b>		particular element has changed and, if it is visible in any open diagram, to reload and refresh that element for the user.  Parameters: <ul style="list-style-type: none"> <li>ObjectID: Long - the ID of the element.</li> </ul>
<b>ChangeLoginUser (string Name, string Password)</b>	<i>Boolean</i>	Sets the currently logged on user to be that specified by a name and password. This logs the user into the repository when security is enabled. If security is not enabled an exception ( <i>Security not enabled</i> ) is thrown.  Parameters: <ul style="list-style-type: none"> <li>Name: String - the name of the user.</li> <li>Password: String - the password of the user.</li> </ul>
<b>ClearAuditLogs (Object StartDateTime, Object EndDateTime)</b>	<i>Boolean</i>	Clears all Audit Logs from the model.  If <i>StartDateTime</i> and <i>EndDateTime</i> are not null then only log items that fall into this period are cleared.  Returns <b>true</b> for success, <b>false</b> for failure.  <b>Notes:</b> <ul style="list-style-type: none"> <li>This method cannot be undone. It is strongly advised that you call <i>SaveAuditLogs</i> first to backup the logs.</li> <li>This method might fail if the user logged into the model does not have the correct access permission.</li> </ul> Parameters: <ul style="list-style-type: none"> <li>StartDateTime: Variant [DateTime] - the earliest date and time of log entries to clear.</li> <li>EndDateTime; Variant [DateTime] - the latest date and time of log entries to clear.</li> </ul>
<b>ClearOutput (string Name)</b>		Removes all the text from a tab in the <b>Output</b> window. See also <a href="#">CreateOutputTab</a> <sup>[1685]</sup> , <a href="#">EnsureOutput Visible</a> <sup>[1685]</sup> , <a href="#">WriteOutput</a> <sup>[1693]</sup> .  Parameters: <ul style="list-style-type: none"> <li>Name: String - the name of the tab to remove text from.</li> </ul>
<b>CloseAddins ()</b>		Called by automation controllers to ensure that Add-Ins created in .NET do not linger after all controller references to Enterprise Architect have been cleared.
<b>CloseDiagram (long DiagramID)</b>		Closes a diagram in the current list of diagrams that Enterprise Architect has open.  Parameters: <ul style="list-style-type: none"> <li>DiagramID: Long - the ID of the diagram to close.</li> </ul>
<b>CloseFile ()</b>		Closes any open file.
<b>CreateModel (CreateModelType CreateType, string FilePath, long ParentWnd)</b>	<i>Boolean</i>	Creates a new .eap model file based on the standard Enterprise Architect Base model, or a shortcut .eap based on a provided SQL connection.  Returns <b>true</b> when the new file is created, otherwise returns <b>false</b> .  Parameters: <ul style="list-style-type: none"> <li>CreateType: <a href="#">CreateModelType</a><sup>[1676]</sup> - Specify whether to</li> </ul>



Method	Type	Notes
		<p>make a new copy of the EABase.eap model, or create a .eap file shortcut to a DBMS repository. The latter option requires a dialog to be opened for the user to provide SQL connection details.</p> <ul style="list-style-type: none"> <li>• FilePath: String - Destination for new .eap file.</li> <li>• ParentWnd: Long - Window handle to act as the parent for the SQL connection dialog. Only required when using <i>cmEAPFromSQLRepository</i>.</li> </ul>
CreateOutputTab (string Name)		<p>Creates a tab in the <b>Output</b> window. See also <a href="#">ClearOutput</a><sup>[1684]</sup>, <a href="#">EnsureOutput Visible</a><sup>[1685]</sup>, <a href="#">WriteOutput</a><sup>[1693]</sup>.</p> <p>Parameters:</p> <ul style="list-style-type: none"> <li>• Name: String - the name of the tab to create.</li> </ul>
DeletePerspective (string Perspective, long Options)	Boolean	<b>Deprecated</b> - no longer in use.
DeleteTechnology (string ID)	Boolean	<p>Removes a specified MDG Technology resource from the repository.</p> <p>Returns <b>true</b>, if the technology is successfully removed from the model. Returns <b>false</b> otherwise.</p> <p><b>Note:</b></p> <p>This applies to technologies imported into pre-7.0 versions of Enterprise Architect (imported technologies), not to technologies referenced in version 7.0 and later (referenced technologies). See <a href="#">Deploy an MDG Technology</a><sup>[1147]</sup> (from Add-Ins).</p> <p>Parameters:</p> <ul style="list-style-type: none"> <li>• ID: String - the ID of the technology.</li> </ul>
EnsureOutputVisible (string Name)		<p>Ensures that a specified tab in the <b>Output</b> window is visible to the user. The <b>Output</b> window is made visible if it is hidden. See also <a href="#">ClearOutput</a><sup>[1684]</sup>, <a href="#">CreateOutputTab</a><sup>[1685]</sup>, <a href="#">WriteOutput</a><sup>[1693]</sup>.</p> <p>Parameters:</p> <ul style="list-style-type: none"> <li>• Name: String - the name of the tab to make visible.</li> </ul>
ExecutePackageBuildScript (long ScriptOptions, string PackageGuid)		<p>Enables you to run the active package build script based on your current selection in the <b>Project Browser</b>. You can also run a script by passing in the package GUID.</p> <p>Parameters:</p> <ul style="list-style-type: none"> <li>• ScriptOptions: Long - the script type; can be any one of these numerical values: <ul style="list-style-type: none"> <li>1 = Build</li> <li>2 = Test</li> <li>3 = Run</li> <li>4 = Create Workbench Instance</li> <li>5 = Debug.</li> </ul> </li> <li>• PackageGuid: String - the ID of the package for which to run the script.</li> </ul>
Exit		Shuts down Enterprise Architect immediately. Used by .NET programmers where the garbage collector does not immediately release all referenced COM objects.
GetActivePerspective ()	String	<b>Deprecated</b> - no longer in use.

Method	Type	Notes
<b>GetAttributeByGuid (string Guid)</b>	<a href="#">Attribute</a>  1727	Returns a pointer to an attribute in the repository, located by its GUID. This is usually found using the <i>AttributeGUID</i> property of an attribute.  Parameters: <ul style="list-style-type: none"> <li>Guid: String - the GUID of the attribute to locate.</li> </ul>
<b>GetAttributeByID (string Id)</b>	<a href="#">Attribute</a>  1727	Returns a pointer to an attribute in the repository, located by its ID. This is usually found using the <i>AttributeID</i> property of an attribute.  Parameters: <ul style="list-style-type: none"> <li>Id: String - the ID of the attribute to locate.</li> </ul>
<b>GetConnectorByGuid (string Guid)</b>	<a href="#">Connector</a>  1739	Returns a pointer to a connector in the repository, located by its GUID. This is usually found using the <i>ConnectorGUID</i> property of a connector.  Parameters: <ul style="list-style-type: none"> <li>Guid: String - the GUID of the connector to locate.</li> </ul>
<b>GetConnectorByID (long ConnectorID)</b>	<a href="#">Connector</a>  1739	Searches the repository for a connector with a specific ID.  Parameters: <ul style="list-style-type: none"> <li>ConnectorID: Long - the ID of the connector to locate.</li> </ul>
<b>GetContextItem (object Item)</b>	<a href="#">ObjectType</a> e 1677	Sets a pointer to an item in context within Enterprise Architect.  Also returns the corresponding <i>ObjectType</i> .  For additional information about <i>ContextItems</i> and the supported <i>ObjectTypes</i> see the <b>GetContextItemType</b> method (below).  Parameters: <ul style="list-style-type: none"> <li>Item: Object - the item to point to.</li> </ul>
<b>GetContextItemType ()</b>	<a href="#">ObjectType</a> e 1677	Returns the <i>ObjectType</i> of an item in context within Enterprise Architect. A <i>ContextItem</i> is defined as an item selected anywhere within the Enterprise Architect GUI including: <ul style="list-style-type: none"> <li>An item selected in the <b>Project Browser</b></li> <li>An item selected in an open diagram</li> <li>An item selected in certain dialogs, such as the attribute <b>Properties</b> dialog.</li> </ul> The supported <i>ObjectTypes</i> can be any one of the following values: <ul style="list-style-type: none"> <li><i>otElement</i></li> <li><i>otPackage</i></li> <li><i>otDiagram</i></li> <li><i>otAttribute</i></li> <li><i>otMethod</i></li> <li><i>otConnector</i></li> </ul>
<b>GetCurrentContextObject ()</b>	<i>Object</i>	Returns the current context Object.
<b>GetCurrentCounts ()</b>	<i>String</i>	Returns a set of counts from a number of tables within the base Enterprise Architect repository. These can be used to determine whether records have been added or deleted from the tables for which information is retrieved.
<b>GetCurrentDiagram ()</b>	<a href="#">Diagram</a>	Returns a selected diagram.

Method	Type	Notes
	 1746	
<b>GetCurrentLoginUser (boolean GetGuid = false)</b>	<i>String</i>	<p>If security is not enabled in the repository, an error is generated.</p> <p>If <i>GetGuid</i> is <b>True</b>, a GUID generated by Enterprise Architect representing the user is returned; otherwise the text as entered in <i>System Users/User Details/Login</i> is returned.</p>
<b>GetDiagramByGuid (string Guid)</b>	<a href="#">Diagram</a>  1746	<p>Returns a pointer to a diagram using the global reference ID (global ID). This is usually found using the diagram <i>GUID</i> property of an element, and stored for later use to open a diagram without using the collection <i>GetAt()</i> function.</p> <p>Parameters:</p> <ul style="list-style-type: none"> <li>Guid: String - the GUID of the diagram to locate.</li> </ul>
<b>GetDiagramByID (long DiagramID)</b>	<a href="#">Diagram</a>  1746	<p>Gets a pointer to a diagram using an absolute reference number (local ID). This is usually found using the <i>DiagramID</i> property of an element, and stored for later use to open a diagram without using the collection <i>GetAt()</i> function.</p> <p>Parameters:</p> <ul style="list-style-type: none"> <li>DiagramID: Long - the ID of the diagram to locate.</li> </ul>
<b>GetElementByGuid (string Guid)</b>	<a href="#">Element</a>  1711	<p>Returns a pointer to an element in the repository, using the element's GUID reference number (global ID). This is usually found using the <i>ElementGUID</i> property of an element, and stored for later use to open an element without using the collection <i>GetAt()</i> function.</p> <p>Parameters:</p> <ul style="list-style-type: none"> <li>Guid: String - the GUID of the element to locate.</li> </ul>
<b>GetElementByID (long ElementID)</b>	<a href="#">Element</a>  1711	<p>Gets a pointer to an element using an absolute reference number (local ID). This is usually found using the <i>ElementID</i> property of an element, and stored for later use to open an element without using the collection <i>GetAt()</i> function.</p> <p>Parameters:</p> <ul style="list-style-type: none"> <li>ElementID: Long - the ID of the element to locate.</li> </ul>
<b>GetElementsByQuery (string QueryName, string SearchTerm)</b>		<p>Enables the user to run a search in Enterprise Architect, returning the result as a collection.</p> <p>For example <i>GetElementsByQuery('Simple','Class1')</i>, where results contain elements with <i>Class1</i> in the <b>Name</b> and <b>Notes</b> fields.</p> <p>Parameters:</p> <ul style="list-style-type: none"> <li>QueryName: String - the name of the search to run, for example 'Simple'.</li> <li>SearchTerm: String - the term to search for.</li> </ul>
<b>GetElementSet (string IDList, long Options)</b>	<a href="#">Collection</a>  1695	<p>Returns a set of elements as a collection based on a comma-separated list of <i>ElementID</i> values. By default, if no values are provided in the IDList parameter, all objects for the entire project are returned.</p> <p>Parameters</p> <ul style="list-style-type: none"> <li>IDList: String - a comma-separated list of <i>ElementID</i> values</li> <li>Options: Long - modifies default behaviour of this method</li> </ul>

Method	Type	Notes
		<ul style="list-style-type: none"> <li>1 - Returns empty collection when empty IDList parameter is given.</li> <li>2 - Use IDList string as an SQL query to populate this collection.</li> </ul>
<b>GetFieldFromFormat (string Format, string Text)</b>	<i>String</i>	<p>Converts a field from your preferred format to Enterprise Architect's internal format. Returns the field in Enterprise Architect's internal format.</p> <p>Parameters:</p> <ul style="list-style-type: none"> <li>Format: String - The format to convert the field from. Valid formats are: <ul style="list-style-type: none"> <li>HTML - Full HTML</li> <li>RTF - Rich Text Format</li> <li>TXT - Plain text</li> </ul> </li> <li>Text: String - The field to be converted.</li> </ul>
<b>GetFormatFromField (string Format, string Text)</b>	<i>String</i>	<p>After accessing a field that contains formatting, use this method to convert it to your preferred format. Returns the field in the format specified.</p> <p>Parameters:</p> <ul style="list-style-type: none"> <li>Format: String - The format to convert the field to. Valid formats are: <ul style="list-style-type: none"> <li>HTML - Full HTML</li> <li>RTF - Rich Text Format</li> <li>TXT - Plain text</li> </ul> </li> <li>Text: String - The field to be converted.</li> </ul>
<b>GetLastError ()</b>	<i>String</i>	<p>Returns a string value describing the most recent error that occurred in relation to this object.</p> <p>This function is rarely used as an exception is thrown when an error occurs.</p>
<b>GetMethodByGuid (string Guid)</b>	<a href="#">Method</a> <sup>[1732]</sup>	<p>Returns a pointer to a method in the repository. This is usually found using the <i>MethodGUID</i> property of a method.</p> <p>Parameters:</p> <ul style="list-style-type: none"> <li>Guid: String - the GUID of the method to look for.</li> </ul>
<b>GetMethodById (string Id)</b>	<a href="#">Method</a> <sup>[1732]</sup>	<p>Returns a pointer to a method in the repository. This is usually found using the <i>MethodID</i> property of a method.</p> <p>Parameters:</p> <ul style="list-style-type: none"> <li>Id: String - the ID of the method to look for.</li> </ul>
<b>GetPackageByGuid (string Guid)</b>	<a href="#">Package</a> <sup>[1698]</sup>	<p>Returns a pointer to a package in the repository using the package's GUID reference number (global ID). This is usually found using the <i>PackageGUID</i> property of the package.</p> <p>Each package in the model also has an associated element with the same GUID, so if you have an element with <i>Type="Package"</i> then you can load the package by calling: <i>GetPackageByGuid(Element.ElementGUID)</i>.</p> <p>Parameters:</p> <ul style="list-style-type: none"> <li>Guid: String - the GUID of the package to look for.</li> </ul>
<b>GetPackageById (long PackageID)</b>	<a href="#">Package</a> <sup>[1698]</sup>	<p>Get a pointer to a package using an absolute reference number (local ID). This is usually found using the <i>PackageID</i> property of a package, and stored for later use</p>

Method	Type	Notes
		to open a package without using the collection <i>GetAt()</i> function. Parameters: <ul style="list-style-type: none"> <li>PackageID: Long - the ID of the package to locate.</li> </ul>
<b>GetProjectInterface ()</b>	<a href="#">Project</a> <sup>[1753]</sup>	Return a pointer to the <a href="#">EA.Project interface</a> <sup>[1753]</sup> (the XML-based automation server for Enterprise Architect). Use this interface to work with Enterprise Architect using XML, and also to access utility functions for loading diagrams, running reports and so on.
<b>GetReferenceList (string Type)</b>	<a href="#">Reference</a> <sup>[1705]</sup>	Uses the list type to get a pointer to a <i>Reference List</i> object. Parameters: <ul style="list-style-type: none"> <li>Type: String - specifies the list type to get; valid list types are: <i>Diagram</i> <i>Element</i> <i>Constraint</i> <i>Requirement</i> <i>Connector</i> <i>Status</i> <i>Cardinality</i> <i>Effort</i> <i>Metric</i> <i>Scenario</i> <i>Status and</i> <i>Test.</i></li> </ul>
<b>GetTechnologyVersion (string ID)</b>	<i>String</i>	Returns the version of a specified MDG Technology resource. Parameters: <ul style="list-style-type: none"> <li>ID: String - the specified technology ID.</li> </ul>
<b>GetTreeSelectedElements()</b>	<a href="#">Collection</a> <sup>[1695]</sup>	Returns the set of elements currently selected in the <b>Project Browser</b> as a collection.
<b>GetTreeSelectedItem (object SelectedItem)</b>	<a href="#">ObjectType</a> <sup>[1677]</sup>	Gets an object variable and type corresponding to the currently selected item in the tree view.  To use this function, create a generic object variable and pass this as the parameter. Depending on the return type, cast it to a more specific type.  The object passed back through the parameter can be a package, element, diagram, attribute or operation object. Parameters: <ul style="list-style-type: none"> <li>SelectedItem: Object - the object to get the variable and type for.</li> </ul>
<b>GetTreeSelectedItemType ()</b>	<a href="#">ObjectType</a> <sup>[1677]</sup>	Returns the type of the object currently selected in the tree. One of: <ul style="list-style-type: none"> <li><i>otDiagram</i></li> <li><i>otElement</i></li> <li><i>otPackage</i></li> <li><i>otAttribute</i></li> <li><i>otMethod.</i></li> </ul>
<b>GetTreeSelectedObject ()</b>	<i>Object</i>	The related method <a href="#">GetTreeSelectedItem</a> <sup>[1689]</sup> () has an output parameter that is inaccessible by some scripting

Method	Type	Notes
		languages. As an alternative, this method provides the selected item through the return value.
GetTreeSelectedPackage ()	<a href="#">Package</a> <small>[1698]</small>	Returns the package in which the currently selected tree view object is contained.
HasPerspective (string Perspective)	String	<b>Deprecated</b> - no longer in use.
ImportPackageBuildScripts (string PackageGuid, string BuildScriptXML)		Imports build scripts into a package in Enterprise Architect. Parameters: <ul style="list-style-type: none"> <li>PackageGuid: String - the GUID of the package into which to import the build scripts.</li> <li>BuildScriptXML: String - the build script XML data, which you can export from within Enterprise Architect.</li> </ul>
ImportTechnology (string Technology)	Boolean	Installs a given MDG Technology resource into the repository. Returns <b>True</b> , if the technology is successfully loaded into the model. Otherwise returns <b>False</b> . <b>Note:</b> This applies to technologies imported into pre-7.0 versions of Enterprise Architect (imported technologies), not to technologies referenced in version 7.0 and later (referenced technologies). See <a href="#">Deploy an MDG Technology</a> <small>[1147]</small> (from Add-Ins). Parameters: <ul style="list-style-type: none"> <li>Technology: String - the contents of the technology resource file.</li> </ul>
IsTabOpen (string TabName)	String	Checks whether a named Enterprise Architect tabbed view is open and active. This includes open diagram windows or custom controls added using <a href="#">Repository.AddTab()</a> <small>[1683]</small> . Returns: <ul style="list-style-type: none"> <li><b>2</b> to indicate that a tab is open and active (top-most)</li> <li><b>1</b> to indicate that it is open but not top-most, or</li> <li><b>0</b> to indicate that it is not visible at all.</li> </ul> <b>Note:</b> TabName is case-sensitive. Parameters: <ul style="list-style-type: none"> <li>TabName: String - the name of the tab to check for.</li> </ul>
IsTechnologyEnabled (string ID)	Boolean	Checks whether a specified technology is enabled in Enterprise Architect. Returns <b>True</b> if the MDG Technology resource is enabled. Otherwise returns <b>False</b> . Parameters: <ul style="list-style-type: none"> <li>ID: String - the technology ID to check for.</li> </ul>
IsTechnologyLoaded (string ID)	Boolean	Checks whether a specified technology is loaded into the repository. Returns <b>True</b> if the MDG Technology resource is loaded into the repository. Otherwise returns <b>False</b> .

Method	Type	Notes
		Parameters: <ul style="list-style-type: none"> <li>ID: String - the technology ID to check for.</li> </ul>
<b>OpenDiagram (long DiagramID)</b>		Provides a method for an automation client or Add-In to open a diagram. The diagram is added to the tabbed list of open diagrams in the main Enterprise Architect view. Parameters: <ul style="list-style-type: none"> <li>DiagramID: Long - the ID of the diagram to open.</li> </ul>
<b>OpenFile (string Filename)</b>	<i>Boolean</i>	This is the main point for opening an Enterprise Architect project file from an automation client, and working with the contained objects.  If the required project is a DBMS repository, and you have created a shortcut .EAP file containing the database connection string, you can call this shortcut file to access the DBMS repository.  You can also connect to a SQL database by passing in the connection string itself instead of a filename. A valid connection string can be obtained from the <a href="#">Open Project</a> <sup>[114]</sup> dialog by selecting a recently opened SQL repository. Parameters: <ul style="list-style-type: none"> <li>Filename: String - the filename of the Enterprise Architect project to open.</li> </ul>
<b>OpenFile2 (string FilePath, string Username, string Password)</b>	<i>Boolean</i>	As for <i>OpenFile()</i> except this enables the specification of a password. Parameters: <ul style="list-style-type: none"> <li>Filepath: String - the file path of the Enterprise Architect project to open.</li> <li>Username: String - the user login ID</li> <li>Password: String - the user password.</li> </ul>
<b>RefreshModelView (long PackageID)</b>		Reloads a package or the entire model, updating the user interface. Parameters: <ul style="list-style-type: none"> <li>PackageID: Long - the ID of the package to reload: if <b>0</b>, the entire model is reloaded; if a valid package ID, only that package is reloaded.</li> </ul>
<b>RefreshOpenDiagrams (boolean FullReload)</b>		Refreshes the diagram contents for all diagrams open in Enterprise Architect. Parameters: <ul style="list-style-type: none"> <li>FullReload: Boolean - if <b>false</b> the displayed contents of elements and connectors are refreshed in each diagram; if <b>true</b> each of the diagrams is completely reloaded from the repository.</li> </ul>
<b>ReloadDiagram (long DiagramID)</b>		Reloads a specified diagram. This would commonly be used to refresh a visible diagram after code import/export or other batch process where the diagram requires complete refreshing. Parameters: <ul style="list-style-type: none"> <li>DiagramID: Long - the ID of the diagram to be reloaded.</li> </ul>
<b>RemoveOutputTab (string Name)</b>		Removes a specified tab from the <b>Output</b> window. Parameters:

Method	Type	Notes
		<ul style="list-style-type: none"> <li>Name: String - the name of the tab to be removed.</li> </ul>
<b>RunModelSearch</b> (string sQueryName, string sSearchTerm, string sSearchOptions, string sSearchData)		<p>Runs a search, displaying the results in Enterprise Architect's <b>Model Search</b> window.</p> <p>Parameters:</p> <ul style="list-style-type: none"> <li>sQueryName: String - the name of the search to run, for example <i>Simple</i>.</li> <li>sSearchTerm: String - the term to search for.</li> <li>sSearchOptions: String - currently not being used.</li> <li>sSearchData: String - enables you to supply a list of results in the form of XML, which is appended onto the result list in Enterprise Architect. See <a href="#">XML Format</a>; this parameter is not mandatory so pass in an empty string to run the search as per normal.</li> </ul>
<b>SaveAllDiagrams</b> ()		Saves all open diagrams.
<b>SaveAuditLogs</b> (string FilePath, object StartDateTime, object EndDateTime)	<i>Boolean</i>	<p>Saves the Audit Logs contained within a model to a specified file.</p> <p>If <i>StartDateTime</i> and <i>EndDateTime</i> are not null then only log items that fall into this period are saved.</p> <p>Returns <b>true</b> for success, <b>false</b> for failure.</p> <p><b>Note:</b></p> <p>This might fail if the user logged into the model does not have the correct access permission.</p> <p>Parameters:</p> <ul style="list-style-type: none"> <li>FilePath: String - the file to save the Audit Logs to.</li> <li>StartDateTime: Variant [DateTime] - the earliest date and time of log entries to save.</li> <li>EndDateTime; Variant [DateTime] - the latest date and time of log entries to save.</li> </ul>
<b>SaveDiagram</b> (long DiagramID)		<p>Saves an open diagram. Assumes the diagram is open in the main user interface Tab list.</p> <p>Parameters:</p> <ul style="list-style-type: none"> <li>DiagramID: Long - the ID of the diagram to save.</li> </ul>
<b>ShowDynamicHelp</b> (string Topic)		<p>Shows a help topic as a view.</p> <p>Parameters:</p> <ul style="list-style-type: none"> <li>Topic: String - specifies the help topic.</li> </ul>
<b>ShowInProjectView</b> (object Item)		<p>Selects a specified object in the <b>Project Browser</b>.</p> <p>Accepted object types are <i>Package</i>, <i>Element</i>, <i>Diagram</i>, <i>Attribute</i>, and <i>Method</i>. An exception is thrown if the object is of an invalid type.</p> <p>Parameters:</p> <ul style="list-style-type: none"> <li>Item: Object - the object to highlight.</li> </ul>
<b>ShowProfileToolbox</b> (string Technology, string Profile, boolean Show)		<p>Shows/hides the contents of a specified technology or profile in the <b>Toolbox</b>.</p> <p>To show/hide a profile in the <b>Toolbox</b>, specify the profile's ID value in the <i>Profile</i> parameter and set the <i>Technology</i> parameter to a null string.</p> <p>To show/hide a technology in the <b>Toolbox</b>, specify the</p>



Method	Type	Notes
		<p>technology's ID in the <i>Technology</i> parameter and set the <i>Profile</i> parameter to a null string.</p> <p>Parameters:</p> <ul style="list-style-type: none"> <li>Technology: String - the ID of the technology.</li> <li>Profile: String - the ID of the profile.</li> <li>Show: Boolean - if <b>true</b>, show the technology or profile; if <b>false</b>, hide the technology or profile.</li> </ul>
ShowWindow (long Show)		<p>Shows or hides Enterprise Architect.</p> <p>Parameters:</p> <ul style="list-style-type: none"> <li>Show: Long.</li> </ul>
SQLQuery (string SQL)	String	<p>Enables execution of a SQL <i>select</i> statement against the current repository. Returns an XML formatted string value of the resulting recordset.</p> <p>Parameters:</p> <ul style="list-style-type: none"> <li>SQL: String - contains the SQL Select statement.</li> </ul>
VersionControlResynchPkgStatuses (boolean ClearSettings)		<p><a href="#">Synchronizes the version control status</a><sup>[267]</sup> of each version controlled package within the current model with the status reported by your version control provider.</p> <p>Parameters:</p> <ul style="list-style-type: none"> <li>ClearSettings: Boolean - if <b>true</b>, clear the version control settings from packages that are reported by the version control provider as <i>uncontrolled</i>; if <b>false</b>, leave the version control settings unchanged for packages reported as <i>uncontrolled</i>.</li> </ul>
WriteOutput (string Name, string String, long ID)		<p>Writes text to a specified tab in the <b>Output</b> window, and associates the text with an ID. See also <a href="#">ClearOutput</a><sup>[1684]</sup>, <a href="#">CreateOutputTab</a><sup>[1685]</sup>, <a href="#">EnsureOutput Visible</a><sup>[1685]</sup>.</p> <p>Parameters:</p> <ul style="list-style-type: none"> <li>Name: String - specifies the tab on which to display the text.</li> <li>String: String - specifies the text to display.</li> <li>ID: Long - specifies the ID the text is associated with.</li> </ul>

#### 11.2.2.4.2 Author

##### public Class

An *Author* object represents a named model author. Accessed using the Repository *Authors* collection.

Associated table in .EAP file: *t\_authors*

##### Author Attributes

Attribute	Type	Notes
Name	String	Read/Write. Author name.
Notes	String	Read/Write. Notes about the author.
ObjectType	<a href="#">ObjectType</a> <sup>[1677]</sup>	Read only. Distinguishes objects referenced through a Dispatch interface.
Roles	String	Read/Write. Roles the author might play in this project.

### Author Methods

Method	Type	Notes
<b>GetLastError ()</b>	<i>String</i>	Returns a string value describing the most recent error that occurred in relation to this object.  This function is rarely used as an exception is thrown when an error occurs.
<b>Update ()</b>	<i>Boolean</i>	Updates the current Author object after modification or appending a new item. If <b>false</b> is returned, check the <i>GetLastError</i> function for more information.

#### 11.2.2.4.3 Client

### public Class

A Client represents one or more people or organizations related to the project. Accessed using the Repository *Clients* collection.

Associated table in .EAP file: *t\_clients*

### Client Attributes

Attribute	Type	Notes
<b>E-Mail</b>	<i>String</i>	Read/Write. E-Mail address.
<b>Fax</b>	<i>String</i>	Read/Write. Fax number.
<b>Mobile</b>	<i>String</i>	Read/Write. Mobile phone if available.
<b>Name</b>	<i>String</i>	Read/Write. Client name.
<b>Notes</b>	<i>String</i>	Read/Write. Notes about client.
<b>ObjectType</b>	<a href="#">ObjectType</a> <small>[1677]</small>	Read only. Distinguishes objects referenced through the <i>Dispatch</i> interface.
<b>Organization</b>	<i>String</i>	Read/Write. Associated organization.
<b>Phone1</b>	<i>String</i>	Read/Write. Main phone number.
<b>Phone2</b>	<i>String</i>	Read/Write. Second phone number.
<b>Roles</b>	<i>String</i>	Read/Write. Roles this client might play in the project.

### Client Methods

Method	Type	Notes
<b>GetLastError ()</b>	<i>String</i>	Returns a string value describing the most recent error that occurred in relation to this object.  This function is rarely used as an exception is thrown when an error occurs.
<b>Update ()</b>	<i>Boolean</i>	Updates the current Client object after modification or appending a new item. If <b>false</b> is returned, check the <i>GetLastError</i> function for more information.

#### 11.2.2.4.4 Collection

##### public Class

This is the main collection Class used by all elements within the Automation Interface. It contains methods to iterate through the collection, refresh the collection and delete an item from the collection. It is important to realize that when *AddNew* is called, the item is not automatically added to the current collection. The typical steps are:

1. Call *AddNew* to add a new item.
2. Modify the item as required.
3. Call *Update* on the item to save it to the database.
4. Call *Refresh* on the collection to include it in the current set.

*Delete* is much the same; until *Refresh* is called, the collection still contains a reference to the deleted item, which should not be called.

Each can be used to iterate through the collection for languages that support this type of construct.

##### Collection Attributes

Attribute	Type	Notes
Count	Short	Read only. The number of objects referenced by this list.
ObjectType	<a href="#">ObjectType</a> <small> 1677 </small>	Read only. Distinguishes objects referenced through a Dispatch interface.

##### Collection Methods

Method	Type	Notes
<b>AddNew (string Name, string Type)</b>	Object	Adds a new item to the current collection.  Note that the interface is the same for all collections; you must provide a <i>Name</i> and <i>Type</i> argument. What these are used for depends on the actual collection member. Also note that you must call <i>Update()</i> on the returned object to complete the <i>AddNew</i> . If <i>Update()</i> is not called the object is left in an indeterminate state.  Parameters: <ul style="list-style-type: none"> <li>• Name: String</li> <li>• Type: String (up to 30 characters long)</li> </ul>
<b>Delete (short index)</b>	Void	Deletes the item at the selected reference.  Parameters: <ul style="list-style-type: none"> <li>• index: Short</li> </ul>
<b>DeleteAt (short index, boolean Refresh)</b>	Void	Deletes the item at the selected index. The second parameter is currently unused.  Parameters: <ul style="list-style-type: none"> <li>• index: Short</li> <li>• Refresh: Boolean</li> </ul>
<b>GetAt (short index)</b>	Object	Retrieves the array object using a numerical index. If the index is out of bounds, an error occurs.  Parameters: <ul style="list-style-type: none"> <li>• index: Short</li> </ul>
<b>GetByName (string Name)</b>	Object	Gets an item in the current collection by Name.  If the collection does not contain any items, the method returns a null value. If the collection contains items, but it was unable to find

Method	Type	Notes
		<p>an object with the specified name, the method raises an exception.</p> <p>Only supported for the following collections: <a href="#">Model</a> <sup>[1698]</sup>, <a href="#">Package</a> <sup>[1698]</sup>, <a href="#">Element</a> <sup>[1711]</sup>, <a href="#">Diagram</a> <sup>[1746]</sup>, and element <a href="#">TaggedValue</a> <sup>[1724]</sup>.</p> <p>Parameters:</p> <ul style="list-style-type: none"> <li>Name: String</li> </ul>
<b>GetLastError ()</b>	<i>String</i>	<p>Returns a string value describing the most recent error that occurred in relation to this object.</p> <p>This function is rarely used as an exception is thrown when an error occurs.</p>
<b>Refresh ()</b>	<i>Void</i>	<p>Refreshes the collection by re-querying the model and reloading the collection. Should be called after adding a new item or after deleting an item.</p>

#### 11.2.2.4.5 Datatype

##### public Class

A *Datatype* is a named type that can be associated with attribute or method types. It typically is related to either code engineering or database modeling. Datatypes also indicate which language or database system they relate to. Accessed using the Repository *Datatypes* collection.

Associated table in .EAP file: *t\_datatypes*

##### Datatype Attributes

Attribute	Type	Notes
<b>DatatypeID</b>	<i>Long</i>	Read/Write. Instance ID for this datatype within the current model. System maintained.
<b>DefaultLen</b>	<i>Long</i>	Read/Write. Default length (DDL only).
<b>DefaultPrec</b>	<i>Long</i>	Read/Write. Default precision (DDL only).
<b>DefaultScale</b>	<i>Long</i>	Read/Write. Default scale (DDL only).
<b>GenericType</b>	<i>String</i>	Read/Write. The associated generic type for this data type.
<b>HasLength</b>	<i>String</i>	Read/Write. Indicates datatype has a length component.
<b>MaxLen</b>	<i>Long</i>	Read/Write. Maximum length (DDL only).
<b>MaxPrec</b>	<i>Long</i>	Read/Write. Maximum precision (DDL only).
<b>MaxScale</b>	<i>Long</i>	Read/Write. Maximum scale (DDL only).
<b>Name</b>	<i>String</i>	Read/Write. The datatype name (such as <i>integer</i> ). This appears in the related drop-down datatype lists where appropriate.
<b>ObjectType</b>	<a href="#">ObjectType</a> <sup>[1677]</sup>	Read only. Distinguishes objects referenced through a Dispatch interface.
<b>Product</b>	<i>String</i>	Read/Write. The datatype product, such as Java, C++, Oracle.
<b>Size</b>	<i>Long</i>	Read/Write. The datatype size.
<b>Type</b>	<i>String</i>	Read/Write. The type can be <i>DDL</i> for database datatype or <i>Code</i> for language datatypes.

Attribute	Type	Notes
UserDefined	Long	Read/Write. Indicates if datatype is a user defined type or system generated.  Datatypes distributed with Enterprise Architect are all system generated. Datatypes created in the <b>Datatype</b> dialog are marked <b>1 (true)</b> .

### Datatype Methods

Method	Type	Notes
GetLastError ()	String	Returns a string value describing the most recent error that occurred in relation to this object.  This function is rarely used as an exception is thrown when an error occurs.
Update ()	Boolean	Updates the current Datatype object after modification or appending a new item.  If <b>false</b> is returned, check the <i>GetLastError</i> function for more information.

#### 11.2.2.4.6 EventProperties

An *EventProperties* object is passed to *BroadcastFunctions* to facilitate parameter passing.

### EventProperties Attributes

Attribute	Type	Notes
Count	Long	Read only. Number of parameters being passed to this broadcast event.
ObjectType	<a href="#">ObjectType</a> <sup>1697</sup>	Read only. Distinguishes objects referenced through a Dispatch interface.

### EventProperties Methods

Method	Type	Notes
Get (object Index)	<a href="#">EventProperty</a> <sup>1697</sup>	Read only. Returns an <i>EventProperty</i> in the list, raising an error if <i>Index</i> is out of range.  Parameters: <ul style="list-style-type: none"> <li>Index: Variant - can either be a number representing a zero-based index into the array, or a string representing the name of the <i>EventProperty</i>. For example, <i>Props.Get(3)</i> or <i>Props.Get("ObjectID")</i>.</li> </ul>

#### 11.2.2.4.7 EventProperty

*EventProperty* objects are always part of an [EventProperties](#)<sup>1697</sup> collection, and are passed to Add-In methods responding to [broadcast events](#)<sup>1787</sup>.

### EventProperty Attributes

Attribute	Type	Notes
Description	String	Explanation of what this property represents.
Name	String	A string distinguishing this property from others in the list.
ObjectType	<a href="#">ObjectType</a>	Distinguishes objects referenced through a Dispatch interface.

Attribute	Type	Notes
	  1677	
<b>Value</b>	<i>Variant</i>	A string, number or object reference representing the property value.

#### 11.2.2.4.8 ModelWatcher

##### public Class

The *ModelWatcher* object enables an automation client to track changes in a particular model.



##### Note:

After your model has been loaded, you only create the ModelWatcher once. If you [reload](#)  the model, or load another model, the created ModelWatcher is still valid.

##### ModelWatcher Attributes



Attribute	Type	Notes
<b>ObjectType</b>	<a href="#">ObjectType</a>   1677	Read only. Distinguishes objects referenced through a Dispatch interface.

##### ModelWatcher Methods

Methods	Type	Notes
<b>GetReloadItem (object Item)</b>	<a href="#">ReloadType</a>   1678	<p>The object that must be reloaded in order to see all changes is returned through the <i>Item</i> parameter. If there are no changes or the entire model must be reloaded, this value is returned as <b>null</b> (C#) or <b>Nothing</b> (VB).</p> <p>Calling this method clears the records so that the next time it is called the return values refer only to new changes. Returns a value from the <i>ReloadType</i> enumeration that specifies which type of change, if any, has occurred.</p> <p>Parameters:</p> <ul style="list-style-type: none"> <li>Item: Object</li> </ul>
<b>PeekReloadItem</b>	<a href="#">ReloadType</a>   1678	This method behaves identically to <i>GetReloadItem()</i> but does not clear the change record.

#### 11.2.2.4.9 Package

##### public Class

A *Package* object corresponds to a Package element in the Enterprise Architect **Project Browser**. It is accessed either through the [Repository Models](#)  |1682| collection (a Model is a special form of Package) or through the [Package Packages](#)  |1700| collection. Note that a Package has an Element object as an attribute; this corresponds to an Enterprise Architect Package element in the *t\_object* table and is used to associate additional information (such as scenarios and constraints) with the logical package. To set additional information for a package, reference the Element object directly. Also note that if you add a Package to a diagram, you should add an instance of the element (not the Package itself) to the *DiagramObjects* collection for a diagram.

Associated table in .EAP file: *t\_package*

## Package Attributes

Attribute	Type	Notes
Alias	String	Read only. Alias.
BatchLoad	Long	Read/Write. Flag to indicate that the package is batch loaded during batch import from controlled packages. Not currently used.
BatchSave	Long	Read/Write. Boolean value to indicate whether the package is included in the batch XML export list or not.
CodePath	String	Read/Write. The path to where associated source code is found. Not currently used.
Connectors	<a href="#">Collection</a> <small>[1695]</small>	Read only. Collection of connectors.
Created	Date	Read/Write. Date the package was created.
Diagrams	<a href="#">Collection</a> <small>[1695]</small>	Read only. A collection of diagrams contained in this package.
Element	<a href="#">Element</a> <small>[1711]</small>	Read only. The associated element object. Use to get/set common information such as Stereotype, Complexity, Alias, Author, Constraints, Tagged Values and Scenarios.
Elements	<a href="#">Collection</a> <small>[1695]</small>	Read only. A collection of elements that belong to this package.
Flags	String	Read/Write. Extended information about the package.
IsControlled	Boolean	Read/Write. Indicates if the package has been marked as <i>Controlled</i> .
IsModel	Boolean	Read only. Indicates if the package is a model or a package.
IsNamespace	Boolean	Read/Write. <b>True</b> is 'package is a Namespace root'. Use <b>0</b> and <b>1</b> to set <b>False</b> and <b>True</b> .
IsProtected	Boolean	Read/Write. Indicates if the package has been marked as <i>Protected</i> .
IsVersionControlled	Boolean	Read. Indicates whether or not this package is under version control.
LastLoadDate	Date	Read/Write. The date XML was last loaded for the package.
LastSaveDate	Date	Read/Write. The date XML was last saved from the package.
LogXML	Boolean	Read/Write. Indicates if XML export information is to be logged.
Modified	Date	Read/Write. Date the package was last modified.
Name	String	Read/Write. The name of the package.
Notes	String	Read/Write. Notes about this package.
ObjectType	<a href="#">ObjectType</a> <small>[1677]</small>	Read only. Distinguishes objects referenced through a Dispatch interface.
Owner	String	Read/Write. The package owner when using controlled packages.
PackageGUID	Variant	Read only. The global Package ID. Valid across models.

Attribute	Type	Notes
PackageID	Long	Read only. The local Package ID number. Valid only in this model file.
Packages	<a href="#">Collection</a> <small>[1695]</small>	Read only. A collection of contained packages that can be walked through.
ParentID	Long	Read/Write. The ID of the package that is the parent of this one. 0 indicates this package is a <i>model</i> (that is, it has no parent).
TreePos	Long	Read/Write. The relative position in the tree compared to other packages (use to sort packages).
UMLVersion	String	Read/Write. The UML version for XML export purposes.
UseDTD	Boolean	Read/Write. Indicates if a DTD is to be used when exporting XML.
Version	String	Read/Write. The version of the package.
XMLPath	String	Read/Write. The path to where the XML is saved when using controlled packages.

### Package Methods

Method	Type	Notes
ApplyGroupLock (string aGroupName)	Boolean	Applies a group lock to the package object, for the specified group, on behalf of the current user.  Throws an exception if the operation fails. Use <i>GetLastError()</i> to retrieve error information.  Parameter: <ul style="list-style-type: none"> <li>aGroupName: String - The name of the security group for which to apply the lock.</li> </ul>
ApplyUserLock ()	Boolean	Applies a user lock to the package object for the current user.  Throws an exception if the operation fails. Use <i>GetLastError()</i> to retrieve error information.
Clone	LDISPATCH	Inserts a copy of the package into the same parent as the original package.  Returns the newly-created package.
FindObject (string DottedID)	LPDISPATCH	Returns a package, element, attribute or operation matching the parameter <i>DottedID</i> . If the DottedID is not found, an error is returned: <i>Can't find matching object</i> .  Parameter: <ul style="list-style-type: none"> <li>DottedID: String - Is in the form <i>object.object.object</i> where <i>object</i> is replaced by the name of a package, element attribute or operation. Examples include <i>MyNamespace.Class1, CStudent.m_Name, MathClass.DoubleIt(int)</i>.</li> </ul>
GetLastError ()	String	Returns a string value describing the most recent error that occurred in relation to this object.  This function is rarely used as an exception is thrown when an error occurs.
ReleaseUserLock ()	Boolean	Removes an existing User or Group lock from the package object.



Method	Type	Notes
		Throws an exception if the operation fails. Use <i>GetLastError()</i> to retrieve error information.
<b>Update ()</b>	<i>Boolean</i>	Update the current package object after modification or appending a new item.  If <b>false</b> is returned, check the <i>GetLastError</i> function for more information.  Note that a package object also has an <i>element</i> component that must be taken into account. The package object contains information about the package attributes such as hierarchy or contents. The element attribute contains information about, for example, Stereotype, Constraints or Files - all the attributes of a typical element.
<b>VersionControlAdd (string ConfigGuid, string XMLFile, string Comment, boolean KeepCheckedOut)</b>	<i>Void</i>	Places the package under version control, using the specified Version Control Configuration and the specified XML filename.  Throws an exception if the operation fails. Use <i>GetLastError()</i> to retrieve error information.  It is recommended that the package be saved using <i>Update()</i> before calling <i>VersionControlAdd()</i> , so that any outstanding changes are not lost.  Parameters: <ul style="list-style-type: none"> <li>• ConfigGuid: String - Name corresponding to the Unique ID of the version control configuration to use.</li> <li>• XMLFile: String - Name of the XML file to use for this package. This filename is relative to the Working Copy folder specified for the Config.</li> <li>• Comment: String - Log message that is added to the version controlled file's history (where applicable).</li> <li>• KeepCheckedOut: Boolean - Specify <b>True</b> to add to version control and keep package checked-out.</li> </ul>
<b>VersionControlCheckin (string Comment)</b>	<i>Void</i>	Perform checkin of the version controlled package.  Throws an exception if the operation fails. Use <i>GetLastError()</i> to retrieve error information.  Parameters: <ul style="list-style-type: none"> <li>• Comment: String - Log message that is added to the version controlled file's history (where applicable).</li> </ul>
<b>VersionControlCheckout (string Comment)</b>	<i>Void</i>	Perform checkout of the version controlled package.  Throws an exception if the operation fails. Use <i>GetLastError()</i> to retrieve error information.  Parameters: <ul style="list-style-type: none"> <li>• Comment: String - Log message that is added to the version controlled file's history (where applicable).</li> </ul>
<b>VersionControlGetLatest (boolean ForceImport)</b>		Updates the local working copy of the package file associated with the object package, before re-importing the package data from the package file.  Parameters: <ul style="list-style-type: none"> <li>• ForceImport: Boolean - Used if the package data in the model is found to be up-to-date with respect to the version controlled package file. If: <ul style="list-style-type: none"> <li>• <b>False</b>, the package data that exists in the model is accepted as being up-to-date and no attempt is made to re-import data from the package file</li> </ul> </li> </ul>

Method	Type	Notes
		<ul style="list-style-type: none"> <li><b>True</b>, Enterprise Architect re-imports the package from the package file regardless.</li> </ul> See also the version control menu option <a href="#">Get Latest</a> <sup>[258]</sup> .
<b>VersionControlGetStatus ()</b>	<i>Long</i>	Returns the version control status of the package. Throws an exception if the operation fails. Use <i>GetLastError()</i> to retrieve error information. Return value maps to the following enumerated type: <pre>enum EnumCheckOutStatus {     csUncontrolled = 0,     csCheckedIn,     csCheckedOutToThisUser,     csReadOnlyVersion,     csCheckedOutToAnotherUser,     csOfflineCheckedIn,     csCheckedOutOfflineByUser,     csCheckedOutOfflineByOther,     csDeleted, };</pre> <p><i>csUncontrolled</i> - Either unable to communicate with the version control provider associated with the package or the package file is unknown to the provider.</p> <p><i>csReadOnlyVersion</i> - Package is marked as read-only. An earlier revision of the package has been retrieved from version control.</p> <p><i>csOfflineCheckedOutToThisUser</i> - Indicates that the package was 'checked out' by this user whilst disconnected from version control.</p> <p><i>csOfflineNotCheckedOutToThisUser</i> - Indicates that Enterprise Architect can not currently connect to the version control config and the package was not previously checked out to this user.</p> <p><i>csDeleted</i> - The package file has been deleted from version control.</p>
<b>VersionControlPutLatest (string CheckInComment)</b>	<i>Void</i>	Perform a checkin of the version controlled package, whilst keeping the package checked-out. Throws an exception if the operation fails. Use <i>GetLastError()</i> to retrieve error information. When a package that was previously marked as <i>Checked Out Offline</i> , is successfully 'Put' (checkedin) to version control, that package's flags are updated to clear the <i>Checked Out Offline</i> indicator. Parameters: <ul style="list-style-type: none"> <li>Comment: String - Log message added to the version controlled file's history (where applicable).</li> </ul>
<b>VersionControlRemove ()</b>	<i>Void</i>	Removes version control from the package. Throws an exception if the operation fails. Use <i>GetLastError()</i> to retrieve error information.
<b>VersionControlResynchPackageStatus (boolean ClearSettings)</b>		<a href="#">Synchronizes</a> <sup>[267]</sup> the version control status of the single object package recorded in your current model with the package status reported by your version control provider. Parameters: <ul style="list-style-type: none"> <li>ClearSettings: Boolean - used if the package file associated</li> </ul>

Method	Type	Notes
		<p>with the specified package is reported by the version control provider as uncontrolled. If ClearSettings is:</p> <ul style="list-style-type: none"> <li>• <b>True</b>, the version control settings are cleared from the package</li> <li>• <b>False</b>, the version control settings remain unchanged.</li> </ul>

#### 11.2.2.4.10 ProjectIssues

##### public Class

A system-level Issue. Indicates a problem or risk associated with the system as a whole. Accessed using the Repository *Issues* collection.

Associated table in .EAP file: *t\_issues*

##### ProjectIssues Attributes

Attribute	Type	Notes
Category	String	Read/Write. The category this issue belongs to.
Date	Date	Read/Write. Date created.
DateResolved	Date	Read/Write. Date issue resolved.
Name	String	Read/Write. Issue name (that is, the issue itself).
IssueID	Long	Read only. The ID of this issue.
Notes	String	Read/Write. Associated description of issue.
ObjectType	<a href="#">ObjectType</a> <small>(167)</small>	Read only. Distinguishes objects referenced through a Dispatch interface.
Owner	String	Read/Write. Owner of issue.
Priority	String	Read/Write. Issue priority. Generally should use Low, Medium or High.
Resolution	String	Read/Write. Description of resolution.
Resolver	String	Read/Write. Person resolving issue.
Severity	String	Read/Write. Issue severity. Should be marked as Low, Medium or High.
Status	String	Read/Write. Current issue status.

##### ProjectIssues Methods

Method	Type	Notes
GetLastError ()	String	<p>Returns a string value describing the most recent error that occurred in relation to this object.</p> <p>This function is rarely used as an exception is thrown when an error occurs.</p>
Update ()	Boolean	Update the current Issue object after modification or appending a new item. If <b>false</b> is returned, check the <i>GetLastError</i> function for more information.

### 11.2.2.4.11 ProjectResource

#### public Class

A *Project Resource* is a named person who is available to work on the current project in any capacity. Accessed using the Repository *Resources* collection.

Associated table in .EAP file: *t\_resources*

#### ProjectResource Attributes

Attribute	Type	Notes
Email	String	Email address.
Fax	String	Fax number.
Mobile	Variant	Mobile number if available.
Name	String	Name of resource.
Notes	String	A description if appropriate.
ObjectType	<a href="#">ObjectType</a> <sup>[1677]</sup>	Read only. Distinguishes objects referenced through a Dispatch interface.
Organization	<a href="#">Package</a> <sup>[1698]</sup> : String	Organization resource associated with.
Phone1	Variant	Main phone.
Phone2	Variant	Alternative phone.
Roles	String	The roles this resource can play in the current project.

#### ProjectResource Methods

Method	Type	Notes
GetLastError ()	String	Returns a string value describing the most recent error that occurred in relation to this object.  This function is rarely used as an exception is thrown when an error occurs.
Update ()	Boolean	Update the current Resource object after modification or appending a new item. If <b>false</b> is returned, check the <i>GetLastError</i> function for more information.

### 11.2.2.4.12 PropertyType

#### public Class

A *PropertyType* object represents a defined property that can be applied to UML elements as a Tagged Value. Accessed using the Repository *PropertyTypes* collection. Each *PropertyType* corresponds to one of the predefined Tagged Values for the model.

Associated table in .EAP file: *t\_propertytypes*

#### Author Attributes

Attribute	Type	Notes
Description	String	Read/Write. Short description for the property.

Attribute	Type	Notes
Detail	String	Read/Write. Configuration information for the property.
ObjectType	<a href="#">ObjectType</a> <sup>[1677]</sup>	Read only. Distinguishes objects referenced through a Dispatch interface.
Tag	String	Read/Write. Name of the property (Tag Name).

### Author Methods

Method	Type	Notes
GetLastError ()	String	Returns a string value describing the most recent error that occurred in relation to this object.  This function is rarely used as an exception is thrown when an error occurs.
Update ()	Boolean	Update the current <i>PropertyType</i> object after modification or appending a new item. If <b>false</b> is returned, check the <i>GetLastError</i> function for more information.

#### 11.2.2.4.13 Reference

### public Class

This Interface provides access to the various lookup tables within Enterprise Architect. Use the Repository *GetReferenceList()* method to get a handle to a list. Valid lists are:

- Diagram
- Element
- Constraint
- Requirement
- Connector
- Status
- Cardinality
- Effort
- Metric
- Scenario
- Status
- Test

### Reference Attributes

Attribute	Type	Notes
Count	Short	Count of items in the list.
ObjectType	<a href="#">ObjectType</a> <sup>[1677]</sup>	Read only. Distinguishes objects referenced through a Dispatch interface.
Type	String	The list type (for example, Diagram Types).

### Reference Methods

Method	Type	Notes
GetAt (short Index)	String	Get the item at the specified index.

Method	Type	Notes
		Parameters: <ul style="list-style-type: none"> <li>Index: Short - The index of the item to retrieve from the list.</li> </ul>
<b>GetLastError ()</b>	<i>String</i>	Returns a string value describing the most recent error that occurred in relation to this object.  This function is rarely used as an exception is thrown when an error occurs.
<b>Refresh ()</b>	<i>Short</i>	Refresh the current list and return the count of items.

#### 11.2.2.4.14 Stereotype

##### public Class

The *Stereotype* element corresponds to a UML stereotype, which is an extension mechanism for varying the behavior and type of a model element. Use the Repository *Stereotypes* collection to add new elements and delete existing ones.

Associated table in .EAP file: *t\_stereotypes*

##### Stereotype Attributes

Attribute	Type	Notes
<b>AppliesTo</b>	<i>String</i>	Read/Write. A reference to the stereotype <i>Base Class</i> , that is, which element it applies to.
<b>MetafileLoadPath</b>	<i>String</i>	Read/Write. Path to an associated metafile. The automation interface does not yet support loading metafiles. To do this you must use the <b>Stereotype</b> tab of the <b>UML Types</b> dialog in Enterprise Architect.
<b>Notes</b>	<i>String</i>	Read/Write. Notes about the stereotype.
<b>Name</b>	<i>String</i>	Read/Write. The stereotype name. Appears in the <b>Stereotype</b> drop list for elements that match the <i>AppliesTo</i> attribute.
<b>ObjectType</b>	<a href="#">ObjectType</a> <small> 1677 </small>	Read only. Distinguishes objects referenced through a Dispatch interface.
<b>StereotypeGUID</b>	<i>String</i>	Read/Write. Unique identifier for stereotype, generally set and maintained by Enterprise Architect.
<b>Style</b>	<i>String</i>	Read/Write. Additional style specifier for stereotype.
<b>VisualType</b>	<i>String</i>	Read/Write. Indicates an inbuilt visual style associated with a stereotype. Not currently implemented.

##### Stereotype Methods

Method	Type	Notes
<b>GetLastError ()</b>	<i>String</i>	Returns a string value describing the most recent error that occurred in relation to this object.  This function is rarely used as an exception is thrown when an error occurs.
<b>Update ()</b>	<i>Boolean</i>	Update the current stereotype object after modification or appending a new item. If <b>false</b> is returned, check the <i>GetLastError</i> function for more information.

### 11.2.2.4.15 Task

#### public Class

A Task is an entry in the System ToDo list. Accessed using the Repository *Tasks* collection.

Associated table in .EAP file: *t\_tasks*

#### Task Attributes

Attribute	Type	Notes
<b>ActualTime</b>	<i>Long</i>	Read/Write. Time already expended on task, in hours, days or other units.
<b>AssignedTo</b>	<i>String</i>	Read/Write. Person this task is assigned to; that is, the responsible resource.
<b>EndDate</b>	<i>Date</i>	Read/Write. Date task scheduled to finish.
<b>History</b>	<i>String</i>	Read/Write. Memo field to hold, for example, task history or notes.
<b>Name</b>	<i>Variant</i>	Read/Write. Task name.
<b>Notes</b>	<i>Variant</i>	Read/Write. Description of the task.
<b>ObjectType</b>	<a href="#">ObjectType</a> <small> 1677 </small>	Read only. Distinguishes objects referenced through a Dispatch interface.
<b>Owner</b>	<i>String</i>	Read/Write. The task owner.
<b>Percent</b>	<i>Long</i>	Read/Write. Percent the task is complete.
<b>Phase</b>	<i>String</i>	Read/Write. The phase of the project the task relates to.
<b>Priority</b>	<i>String</i>	Read/Write. Priority associated with this task.
<b>StartDate</b>	<i>Date</i>	Read/Write. Date task is to start.
<b>Status</b>	<i>Variant</i>	Read/Write. Current task status.
<b>TaskID</b>	<i>Long</i>	Read only. Local ID of task.
<b>TotalTime</b>	<i>Long</i>	Read/Write. The total expected time the task might run - in hours, days or some other unit.
<b>Type</b>	<i>String</i>	Read/Write. Sets or returns string representing the type.

#### Task Methods

Method	Type	Notes
<b>GetLastError ()</b>	<i>String</i>	Returns a string value describing the most recent error that occurred in relation to this object.  This function is rarely used as an exception is thrown when an error occurs.
<b>Update ()</b>	<i>Boolean</i>	Update the current Task object after modification or appending a new item. If <b>false</b> is returned, check the <i>GetLastError</i> function for more information.

### 11.2.2.4.16 Term

#### public Class

A *Term* object represents one entry in the system glossary. Accessed using the Repository *Terms* collection.

Associated table in .EAP file: *t\_glossary*

#### Term Attributes

Attribute	Type	Notes
Meaning	String	Read/Write. The description of the term; its meaning.
ObjectType	<a href="#">ObjectType</a> [167]	Read only. Distinguishes objects referenced through a Dispatch interface.
Term	String	Read/Write. The glossary item name.
TermID	Long	Read only. A local ID number to identify the term in the model.
Type	String	Read/Write. The type this term applies to (for example, business or technical).

#### Term Methods

Method	Type	Notes
GetLastError ()	String	Returns a string value describing the most recent error that occurred in relation to this object.  This function is rarely used as an exception is thrown when an error occurs.
Update ()	Boolean	Update the current Term object after modification or appending a new item. If <b>false</b> is returned, check the <i>GetLastError</i> function for more information.

### 11.2.2.5 Element

#### public Package

The *Element* package contains information about an element and its associated extended properties such as testing and project management information. An element is the basic item in an Enterprise Architect model. Classes, Use Cases and Components are all different types of UML element.

The diagram below illustrates the relationships between an *element* and its associated extended information. The related information is accessed through the collections owned by the element (for example, Scenarios and Tests). It also includes a full description of the element object (the basic model structural unit).



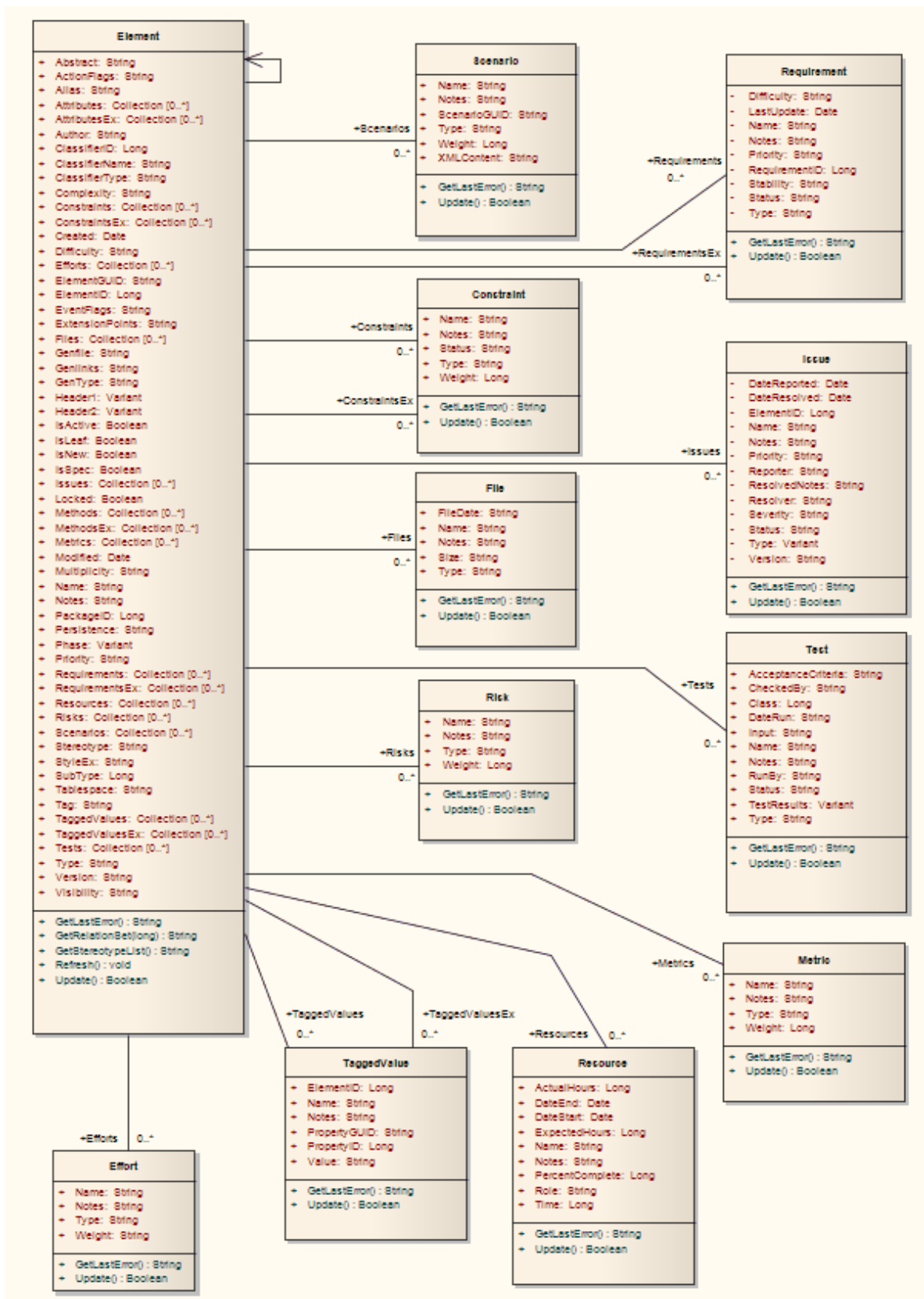

### 11.2.2.5.1 Constraint

#### public Class

A *Constraint* is a condition imposed on an element. Constraints are accessed through the Element *Constraints* collection.

Associated table in .EAP file: *t\_objectconstraints*

#### Constraint Attributes

Attribute	Type	Notes
Name	String	Read/Write. The name of the constraint (that is, the constraint).
Notes	String	Read/Write. Notes about the constraint.
ObjectType	<a href="#">ObjectType</a> <small> 1677 </small>	Read only. Distinguishes objects referenced through a Dispatch interface.
ParentID	Long	Read only. The <i>ElementID</i> of the element to which this constraint applies.
Status	String	Read/Write. Current status.
Type	String	Read/Write. Constraint type.
Weight	Long	Read/Write. A weighting factor.

#### Constraint Methods

Method	Type	Notes
GetLastError ()	String	Returns a string value describing the most recent error that occurred in relation to this object.  This function is rarely used as an exception is thrown when an error occurs.
Update ()	Boolean	Update the current <i>Constraint</i> object after modification or appending a new item. If <b>false</b> is returned, check the <i>GetLastError</i> function for more information.

### 11.2.2.5.2 Effort

#### public Class

An *Effort* is a named item with a weighting that can be associated with an element for purposes of building metrics about the model. Accessed through the Element *Efforts* collection.

Associated table in .EAP file: *t\_objecteffort*

#### Effort Attributes

Attribute	Type	Notes
Name	String	Read/Write. The name of the effort.
Notes	String	Read/Write. Notes about the effort.
ObjectType	<a href="#">ObjectType</a> <small> 1677 </small>	Read only. Distinguishes objects referenced through a Dispatch interface.
Type	String	Read/Write. The effort type.

Attribute	Type	Notes
Weight	Long	Read/Write. A weighting factor.
Weight2	Float	Read/Write. A weighting factor.

### Effort Methods

Method	Type	Notes
GetLastError ()	String	Returns a string value describing the most recent error that occurred in relation to this object.  This function is rarely used as an exception is thrown when an error occurs.
Update ()	Boolean	Saves the effort to the model.

#### 11.2.2.5.3 Element

### public Class

An *Element* is the main modeling unit. It corresponds to (for example) Class, Use Case, Node or Component. You create new elements by adding to the Package *Elements* collection. Once you have created an element, you can add it to the *DiagramObjects* collection of a diagram to include it in the diagram.

Elements also have a collection of connectors. Each entry in this collection indicates a relationship to another element.

There are also some extended collections for managing additional information about the element, including things such as Tagged Values, Issues, Constraints and Requirements.

Associated table in .EAP file: *t\_object*

### Element Attributes

Attribute	Type	Notes
Abstract	String	Read/Write. Indicates if the element is Abstract (1) or Concrete (0).
ActionFlags	String	Read/Write. A structure to hold flags concerned with Action semantics.
Alias	String	Read/Write. An optional alias for this element.
Attributes	<a href="#">Collection</a> <small>[1695]</small>	Read only. Collection of Attribute objects for current element. Use the <b>AddNew</b> and <b>Delete</b> functions to manage attributes.
AttributesEx	<a href="#">Collection</a> <small>[1695]</small>	Read only. Collection of Attribute objects belonging to the current element and its parent elements.
Author	String	Read/Write. The element author (see the <a href="#">Repository: Authors</a> <small>[1680]</small> list for more details).
BaseClasses	<a href="#">Collection</a> <small>[1695]</small>	Read only. List of Base Classes for this element presented as a collection for convenience.
ClassifierID	Long	<b>Deprecated.</b> See <i>ClassifierID</i> .
ClassifierID	Long	Read/Write. ElementID of a Classifier associated with this element; that is, the base type. Only valid for instance type elements (such as Object, Sequence).
ClassifierName	String	Read/Write. Name of associated Classifier (if any).

Attribute	Type	Notes
<b>ClassifierType</b>	<i>String</i>	Read only. Type of associated classifier.
<b>Complexity</b>	<i>String</i>	Read/Write. A complexity value indicating how difficult the element is. Can be used for metric reporting and estimation. Valid values are: <b>1</b> for Easy, <b>2</b> for Medium, <b>3</b> for Difficult.
<b>CompositeDiagram</b>	<a href="#">Diagram</a> <sup>[1746]</sup>	Read only. If the element is Composite, returns its associated diagram; otherwise returns null.
<b>Connectors</b>	<a href="#">Collection</a> <sup>[1695]</sup>	Read only. Returns a collection containing the connectors to other elements.
<b>Constraints</b>	<a href="#">Collection</a> <sup>[1695]</sup>	Read only. Collection of <a href="#">Constraint</a> <sup>[1710]</sup> objects.
<b>ConstraintsEx</b>	<a href="#">Collection</a> <sup>[1695]</sup>	Read only. Collection of Constraint objects belonging to the current element and its parent elements.
<b>Created</b>	<i>Date</i>	Read/Write. The date the element was created.
<b>CustomProperties</b>	<a href="#">Collection</a> <sup>[1695]</sup>	Read only. List of advanced properties for an element. The collection of advanced properties differs depending on element type; for example, an Action and an Activity have different advanced properties. Currently only editable from the user interface.
<b>Diagrams</b>	<a href="#">Collection</a> <sup>[1695]</sup>	Read only. Returns a collection of sub-diagrams (child diagrams) attached to this element as seen in the tree view.
<b>Difficulty</b>	<i>String</i>	Read/Write. A difficulty level associated with this element for estimation/metrics; only useable for Requirement, Change and Issue element types, otherwise ignored. Valid values are: <b>Low</b> , <b>Medium</b> , <b>High</b> .
<b>Efforts</b>	<a href="#">Collection</a> <sup>[1695]</sup>	Read only. Collection of <a href="#">Effort</a> <sup>[1710]</sup> objects.
<b>ElementGUID</b>	<i>String</i>	Read only. A globally unique ID for this element; that is, unique across all model files. If you have to set this value manually, you should only do so when the element is first created, and make sure you format the GUID exactly as Enterprise Architect expects.
<b>ElementID</b>	<i>Long</i>	Read only. The local ID of the Element. Valid for this file only.
<b>Elements</b>	<a href="#">Collection</a> <sup>[1695]</sup>	Read only. Returns a collection of child elements (sub-elements) attached to this element as seen in the tree view.
<b>EmbeddedElements</b>	<a href="#">Collection</a> <sup>[1695]</sup>	Read only. List of elements that are embedded into this element, such as Ports, Parts, Pins and Parameter Sets.
<b>EventFlags</b>	<i>String</i>	Read/Write. A structure to hold a variety of flags to do with signals or events.
<b>ExtensionPoints</b>	<i>String</i>	Read/Write. Optional extension points for a Use Case as a comma-separated list.
<b>Files</b>	<a href="#">Collection</a> <sup>[1695]</sup>	Read only. Collection of <a href="#">File</a> <sup>[1717]</sup> objects.
<b>GenFile</b>	<i>String</i>	Read/Write. The file associated with this element for code generation and synchronization purposes. Can include macro expansion tags for local conversion to full path.
<b>Genlinks</b>	<i>String</i>	Read/Write. Links to other Classes discovered at code reversing time; Parents and Implements connectors only.

Attribute	Type	Notes
<b>GenType</b>	<i>String</i>	Read/Write. The code generation type; for example, Java, C++, C#, VBNet, Visual Basic, Delphi.
<b>Header1</b>	<i>Variant</i>	Read/Write. A user defined string for inclusion as header in the source files generated.
<b>Header2</b>	<i>Variant</i>	Read/Write. Same as for <b>Header1</b> , but used in the CPP source file.
<b>IsActive</b>	<i>Boolean</i>	Read/Write. Boolean value indicating whether the element is active or not. <b>1</b> = True, <b>0</b> = False.
<b>IsLeaf</b>	<i>Boolean</i>	Read/Write. Boolean value indicating whether the element is in leaf node or not. <b>1</b> = True, <b>0</b> = False.
<b>IsNew</b>	<i>Boolean</i>	Read/Write. Boolean value indicating whether the element is new or not. <b>1</b> = True, <b>0</b> = False.
<b>IsSpec</b>	<i>Boolean</i>	Read/Write. Boolean value indicating whether the element is a specification or not. <b>1</b> = True, <b>0</b> = False.
<b>Issues</b>	<a href="#">Collection</a> <small>1695</small>	Read only. Collection of Issue objects.
<b>Locked</b>	<i>Boolean</i>	Read/Write. Indicates if the element has been locked against further change.
<b>MetaType</b>	<i>String</i>	Read only. The element's domain-specific meta type, as defined by an applied stereotype from an MDG Technology.
<b>Methods</b>	<a href="#">Collection</a> <small>1695</small>	Read only. Collection of Method objects for current element.
<b>MethodsEx</b>	<a href="#">Collection</a> <small>1695</small>	Read only. Collection of Method objects belonging to the current element and its parent elements.
<b>Metrics</b>	<a href="#">Collection</a> <small>1695</small>	Read only. Collection of Metric elements for current element.
<b>MiscData</b>	<i>String</i>	Read only. This low-level property provides information about the contents of the <b>PData</b> fields. These database fields are not documented and developers must gain understanding of these fields through their own endeavors to use this property. <b>MiscData</b> is zero based, therefore: <ul style="list-style-type: none"> <li>• <b>MiscData(0)</b> corresponds to <b>PData1</b></li> <li>• <b>MiscData(1)</b> to <b>PData2</b></li> </ul> and so on.
<b>Modified</b>	<i>Date</i>	Read/Write. The date the element was last modified.
<b>Multiplicity</b>	<i>String</i>	Read/Write. Multiplicity value for this element.
<b>Name</b>	<i>String</i>	Read/Write. The element name; should be unique within the current package.
<b>Notes</b>	<i>String</i>	Read/Write. Further descriptive text about the element.
<b>ObjectType</b>	<a href="#">ObjectType</a> <small>1677</small>	Read only. Distinguishes objects referenced through a Dispatch interface.

Attribute	Type	Notes
PackageID	Long	Read/Write. A local ID for the package containing this element.
ParentID	Long	Read/Write. If this element is a child of another, used to set or retrieve the <i>ElementID</i> of the other element. If not, returns 0.
Partitions	<a href="#">Collection</a> <sup>[1695]</sup>	Read only. List of logical partitions into which an element can be divided. Only valid for elements that support partitions, such as Activities and States.
Persistence	String	Read/Write. The persistence associated with this element. Can be <b>Persistent</b> or <b>Transient</b> .
Phase	String	Read/Write. Phase this element scheduled to be constructed in. Any string value.
Priority	String	Read/Write. The priority of this element as compared to other project elements. Only applies to Requirement, Change and Issue types, otherwise ignored.  Valid values are: <b>Low</b> , <b>Medium</b> and <b>High</b> .
Properties	<a href="#">Properties</a> <sup>[1736]</sup>	Returns a list of specialized properties that apply to the element that might not be available using the automation model. The properties are purposely undocumented because of their obscure nature and because they are subject to change as progressive enhancements are made to them.
PropertyType	Long	Read/Write. The ElementID of a Type associated with this element. Only valid for Port and Part elements.
Realizes	<a href="#">Collection</a> <sup>[1695]</sup>	Read only. List of Interfaces realized by this element for convenience.
Requirements	<a href="#">Collection</a> <sup>[1695]</sup>	Read only. Collection of <a href="#">Requirement</a> <sup>[1719]</sup> objects.
RequirementsEx	<a href="#">Collection</a> <sup>[1695]</sup>	Read only. Collection of <a href="#">Requirement</a> <sup>[1719]</sup> objects belonging to the current element and its parent elements.
Resources	<a href="#">Collection</a> <sup>[1695]</sup>	Read only. Collection of <a href="#">Resource</a> <sup>[1720]</sup> objects for current element.
Risks	<a href="#">Collection</a> <sup>[1695]</sup>	Read only. Collection of <a href="#">Risk</a> <sup>[1721]</sup> objects.
RunState	String	Read/Write. The object's runstate list as a string.
Scenarios	<a href="#">Collection</a> <sup>[1695]</sup>	Read only. Collection of <a href="#">Scenario</a> <sup>[1722]</sup> objects for current element.
StateTransitions	<a href="#">Collection</a> <sup>[1695]</sup>	Read only. List of State Transitions that an element can support. Applies in particular to Timing elements.
Status	String	Read/Write. Sets or gets the status, such as <b>Proposed</b> or <b>Approved</b> .
Stereotype	String	Read/Write. The primary element stereotype. This is the first of the list of stereotypes you can access using the <i>StereotypeEx</i> attribute.
StereotypeEx	String	Read/Write. All the applied stereotypes of the element in a comma-separated list.
StyleEx	String	Read/Write. Advanced style settings. Reserved for the use of Sparx Systems.
Subtype	Long	Read/Write. A numeric subtype that qualifies the <a href="#">Type</a> <sup>[1715]</sup> of

Attribute	Type	Notes																														
		<p>the main element. For example:</p> <ul style="list-style-type: none"> <li>For Event: <b>0</b> = Receiver, <b>1</b> = Sender</li> <li>For Class: <b>1</b> = Parameterised, <b>2</b> = Instantiated, <b>3</b> = Both, <b>0</b> = Neither, <b>17</b> = Association Class</li> </ul> <p><b>Note:</b></p> <p>If <b>17</b>, because an Association Class has been created through the user interface, <b>MiscData(3)</b> will contain the ID of the related Association. As MiscData is read-only, you cannot create an Association Class through the Automation Interface.</p> <ul style="list-style-type: none"> <li>For Note: <b>1</b> = Note linked to connector, <b>2</b> = Constraint linked to connector</li> <li>For StateNode: <b>100</b> = ActivityInitial, <b>101</b> = ActivityFinal</li> <li>For Activity: <b>0</b> = Activity, <b>8</b> = composite Activity (also set to <b>8</b> for other composite elements such as Use Cases)</li> <li>For Synchronization: <b>0</b> = Horizontal, <b>1</b> = Vertical.</li> </ul> <p>Note that there are many more Types than indicated in the above examples.</p>																														
Tablespace	String	Read/Write. Associated tablespace for a Table element.																														
Tag	String	Read/Write. Corresponds to the <b>Keywords</b> field in the Enterprise Architect user interface. See the <a href="#">General Settings</a> [482] topic.																														
TaggedValues	<a href="#">Collection</a> [1695] of type <a href="#">TaggedValue</a> [1724]	Read only. Returns a collection of <a href="#">TaggedValue</a> [1724] objects.																														
TaggedValuesEx	<a href="#">Collection</a> [1695] of type <a href="#">TaggedValue</a> [1724]	Read only. Returns a collection of <a href="#">TaggedValue</a> [1724] objects belonging to the current element and the elements specialized or realized by the current element.																														
Tests	<a href="#">Collection</a> [1695]	Read only. Collection of <a href="#">Test</a> [1725] objects for current element.																														
TreePos	Long	Read/Write. Sets or gets the tree position.																														
Type	String	<p>Read/Write. The element type (such as Class, Component).</p> <p>Note that Type is case sensitive inside Enterprise Architect and should be provided with an initial capital (proper case). Valid types are:</p> <table border="0"> <tr> <td><b>Action</b></td> <td><b>InteractionOccurrence</b></td> </tr> <tr> <td><b>Activity</b></td> <td><b>InteractionState</b></td> </tr> <tr> <td><b>ActivityPartition</b></td> <td><b>Interface</b></td> </tr> <tr> <td><b>ActivityRegion</b></td> <td><b>InterruptibleActivityRegion</b></td> </tr> <tr> <td><b>Actor</b></td> <td><b>Issue</b></td> </tr> <tr> <td><b>Artifact</b></td> <td><b>Node</b></td> </tr> <tr> <td><b>Association</b></td> <td><b>Note</b></td> </tr> <tr> <td><b>Boundary</b></td> <td><b>Object</b></td> </tr> <tr> <td><b>Change</b></td> <td><b>Package</b></td> </tr> <tr> <td><b>Class</b></td> <td><b>Parameter</b></td> </tr> <tr> <td><b>Collaboration</b></td> <td><b>Part</b></td> </tr> <tr> <td><b>Component</b></td> <td><b>Port</b></td> </tr> <tr> <td><b>Constraint</b></td> <td><b>ProvidedInterface</b></td> </tr> <tr> <td><b>Decision</b></td> <td><b>Report</b></td> </tr> <tr> <td><b>DeploymentSpecification</b></td> <td><b>RequiredInterface</b></td> </tr> </table>	<b>Action</b>	<b>InteractionOccurrence</b>	<b>Activity</b>	<b>InteractionState</b>	<b>ActivityPartition</b>	<b>Interface</b>	<b>ActivityRegion</b>	<b>InterruptibleActivityRegion</b>	<b>Actor</b>	<b>Issue</b>	<b>Artifact</b>	<b>Node</b>	<b>Association</b>	<b>Note</b>	<b>Boundary</b>	<b>Object</b>	<b>Change</b>	<b>Package</b>	<b>Class</b>	<b>Parameter</b>	<b>Collaboration</b>	<b>Part</b>	<b>Component</b>	<b>Port</b>	<b>Constraint</b>	<b>ProvidedInterface</b>	<b>Decision</b>	<b>Report</b>	<b>DeploymentSpecification</b>	<b>RequiredInterface</b>
<b>Action</b>	<b>InteractionOccurrence</b>																															
<b>Activity</b>	<b>InteractionState</b>																															
<b>ActivityPartition</b>	<b>Interface</b>																															
<b>ActivityRegion</b>	<b>InterruptibleActivityRegion</b>																															
<b>Actor</b>	<b>Issue</b>																															
<b>Artifact</b>	<b>Node</b>																															
<b>Association</b>	<b>Note</b>																															
<b>Boundary</b>	<b>Object</b>																															
<b>Change</b>	<b>Package</b>																															
<b>Class</b>	<b>Parameter</b>																															
<b>Collaboration</b>	<b>Part</b>																															
<b>Component</b>	<b>Port</b>																															
<b>Constraint</b>	<b>ProvidedInterface</b>																															
<b>Decision</b>	<b>Report</b>																															
<b>DeploymentSpecification</b>	<b>RequiredInterface</b>																															

Attribute	Type	Notes
		DiagramFrame EmbeddedElement Entity EntryPoint Event ExceptionHandler ExitPoint ExpansionNode ExpansionRegion GUIElement InteractionFragment Requirement Screen Sequence State StateNode Synchronization Text TimeLine UMLDiagram UseCase
Version	String	Read/Write. The version of the element.
Visibility	String	Read/Write. The Scope of this element within the current package.  Valid values are: <b>Public</b> , <b>Private</b> , <b>Protected</b> or <b>Package</b> .

### Element Methods

Method	Type	Notes
ApplyGroupLock (string aGroupName)	Boolean	Applies a group lock to the element object, for the specified group, on behalf of the current user.  Throws an exception if the operation fails. Use <i>GetLastError()</i> to retrieve error information.  Parameter: <ul style="list-style-type: none"> <li>aGroupName: String - the name of the user group for which to set the group lock.</li> </ul>
ApplyUserLock ()	Boolean	Applies a user lock to the element object for the current user.  Throws an exception if the operation fails. Use <i>GetLastError()</i> to retrieve error information.
GetLastError ()	String	Returns a string value describing the most recent error that occurred in relation to this object.  This function is rarely used as an exception is thrown when an error occurs.
GetLinkedDocument ()	String	Returns a string value containing the element's linked document contents, in RTF format.  If the element contains no linked document, an empty string is returned.
GetRelationSet (EnumRelationSetType Type)	String	Returns a string containing a comma-separated list of ElementIDs of directly- and indirectly-related elements based on the given type. See <a href="#">EnumRelationSetType</a> <sup>[1676]</sup> .  Recurses using the same relation type on all elements it finds, retrieving all dependencies and sub-dependencies of the current element; for example, <i>Object1</i> depends on <i>Object2</i> , which depends on <i>Object3</i> . Therefore this method returns <i>Object2</i> and <i>Object3</i> .  To obtain only the direct relationships of the element, use the <a href="#">Connector</a> <sup>[1738]</sup> collection instead.
GetStereotypeList ()	String	Returns a comma-separated list of stereotypes allied to this element.



Method	Type	Notes
<b>LoadLinkedDocument (string Filename)</b>	<i>Boolean</i>	Loads the RTF document from the specified file into the element's linked document. Parameter: <ul style="list-style-type: none"> <li>• FileName: String - the name of the file from which to load the RTF document.</li> </ul>
<b>Refresh ()</b>	<i>Void</i>	Refreshes the element features in the <b>Project Browser</b> . Usually called after adding or deleting attributes or methods, when the user interface is required to be updated as well.
<b>ReleaseUserLock ()</b>	<i>Boolean</i>	Releases a user lock or group lock on the element object. Throws an exception if the operation fails. Use <i>GetLastError()</i> to retrieve error information.
<b>SaveLinkedDocument (string Filename)</b>	<i>Boolean</i>	Saves the linked document for this element to the specified RTF file. Parameter: <ul style="list-style-type: none"> <li>• FileName: String - the name of the RTF file to which to save the linked document.</li> </ul>
<b>SetAppearance (long Scope, long Item, long Value)</b>	<i>Void</i>	Sets the visual appearance of the element. Parameter: <ul style="list-style-type: none"> <li>• Scope: Long - Scope of appearance set to modify <ul style="list-style-type: none"> <li><b>0</b> – Local (Diagram-local appearance)</li> <li><b>1</b> – Base (Default appearance across entire model)</li> </ul> </li> <li>• Item: Long - Appearance item to modify <ul style="list-style-type: none"> <li><b>0</b> – Background color</li> <li><b>1</b> – Font Color</li> <li><b>2</b> – Border Color</li> <li><b>3</b> – Border Width</li> </ul> </li> <li>• Value: Long - Value to set appearance to.</li> </ul>
<b>Update ()</b>	<i>Boolean</i>	Update the current element object after modification or appending a new item. If <b>false</b> is returned, check the <i>GetLastError</i> function for more information.

#### 11.2.2.5.4 File

##### public Class

A *File* represents an associated file for an element. It is accessed through the Element *Files* collection.

Associated table in .EAP file: *t\_objectfiles*

##### File Attributes

Attribute	Type	Notes
<b>FileDate</b>	<i>String</i>	Read/Write. The file date when entry is created.
<b>Name</b>	<i>String</i>	Read/Write. The file name can be a logical file or a reference to a web address (using <i>http://</i> ).
<b>Notes</b>	<i>String</i>	Read/Write. Notes about the file.

Attribute	Type	Notes
<b>ObjectType</b>	<a href="#">ObjectTyp</a> <small>e<sub>1677</sub></small>	Read only. Distinguishes objects referenced through a Dispatch interface.
<b>Size</b>	<i>String</i>	Read/Write. The file size.
<b>Type</b>	<i>String</i>	Read/Write. File type.

### File Methods

Method	Type	Notes
<b>GetLastError ()</b>	<i>String</i>	Returns a string value describing the most recent error that occurred in relation to this object.  This function is rarely used as an exception is thrown when an error occurs.
<b>Update ()</b>	<i>Boolean</i>	Update the current File object after modification or appending a new item. If <b>false</b> is returned, check the <i>GetLastError</i> function for more information.

#### 11.2.2.5.5 Issue (Maintenance)

### public Class

An *Issue* is either a *Change* or a *Defect*, is associated with the containing element, and is accessed through the *Issues* collection of an element.

Associated table in .EAP file: *t\_objectproblems*

### Issue Attributes

Attribute	Type	Notes
<b>DateReported</b>	<i>Date</i>	Read/Write. Date issue reported.
<b>DateResolved</b>	<i>Date</i>	Read/Write. Date issue resolved.
<b>ElementID</b>	<i>Long</i>	Read/Write. ID of element associated with this issue.
<b>Name</b>	<i>String</i>	Read/Write. The Issue name; that is, the Issue itself.
<b>Notes</b>	<i>String</i>	Read/Write. Issue description.
<b>ObjectType</b>	<a href="#">ObjectType</a> <small><sub>1677</sub></small>	Read only. Distinguishes objects referenced through a Dispatch interface.
<b>Priority</b>	<i>String</i>	Read/Write. Issue priority. Generally should use <b>Low</b> , <b>Medium</b> and <b>High</b> .
<b>Reporter</b>	<i>String</i>	Read/Write. Person reporting issue.
<b>Resolver</b>	<i>String</i>	Read/Write. Person resolving issue.
<b>ResolverNotes</b>	<i>String</i>	Read/Write. Notes entered by resolver about resolution.
<b>Severity</b>	<i>String</i>	Read/Write. Issue severity. Should be marked as <b>Low</b> , <b>Medium</b> or <b>High</b> .
<b>Status</b>	<i>String</i>	Read/Write. The current status of the issue.
<b>Type</b>	<i>Variant</i>	Read/Write. Issue type - can be <b>Defect</b> or <b>Change</b> , <b>Issue</b> and <b>ToDo</b> .
<b>Version</b>	<i>String</i>	Read/Write. Version associated with issue. Note that this method is only available through a Dispatch interface. For example: Object ob = Issue;

Attribute	Type	Notes
		Print ob.Version;

### Issue Methods

Method	Type	Notes
<b>GetLastError ()</b>	<i>String</i>	Returns a string value describing the most recent error that occurred in relation to this object.  This function is rarely used as an exception is thrown when an error occurs.
<b>Update ()</b>	<i>Boolean</i>	Update the current Issue object after modification or appending a new item. If <b>false</b> is returned, check the <i>GetLastError</i> function for more information.

#### 11.2.2.5.6 Metric

### public Class

A *Metric* is a named item with a weighting that can be associated with an element for purposes of building metrics about the model. Accessed through the Element *Metrics* collection.

Associated table in .EAP file: *t\_objectmetrics*

### Metric Attributes

Attribute	Type	Notes
<b>Name</b>	<i>String</i>	Read/Write. The name of the metric.
<b>Notes</b>	<i>String</i>	Read/Write. Notes about this metric.
<b>ObjectType</b>	<a href="#">ObjectType</a> <small> 167 </small>	Read only. Distinguishes objects referenced through a Dispatch interface.
<b>Type</b>	<i>String</i>	Read/Write. The metric type.
<b>Weight</b>	<i>Long</i>	Read/Write. A user defined weighting for estimation or metric purposes.

### Metric Methods

Method	Type	Notes
<b>GetLastError ()</b>	<i>String</i>	Returns a string value describing the most recent error that occurred in relation to this object.  This function is rarely used as an exception is thrown when an error occurs.
<b>Update ()</b>	<i>Boolean</i>	Update the current Metric object after modification or appending a new item. If <b>false</b> is returned, check the <i>GetLastError</i> function for more information.

#### 11.2.2.5.7 Requirement

### public Class

An *Element Requirement* object holds information about the responsibilities of an element in the context of the model. Accessed using the Element *Requirements* collection.

Associated table in .EAP file: *t\_objectrequires*

## Requirement Attributes

Attribute	Type	Notes
Difficulty	String	Read/Write. Estimated difficulty to implement.
LastUpdate	Date	Read/Write. Date requirement last updated.
Name	String	Read/Write. The requirement itself.
Notes	String	Read/Write. Further notes about requirement.
ObjectType	<a href="#">ObjectType</a> [1677]	Read only. Distinguishes objects referenced through a Dispatch interface.
ParentID	Long	Read only. The <i>ElementID</i> of the element to which this requirement applies.
Priority	String	Read/Write. Assigned priority of the requirement.
RequirementID	Long	Read only. A local ID for this requirement.
Stability	String	Read/Write. Estimated stability of the requirement.  This is an indication of the probability of the requirement - or understanding of the requirement - changing. High stability indicates a low probability of the requirement changing.
Status	String	Read/Write. Current status of the requirement.
Type	String	Read/Write. Requirement type.

## Requirement Methods

Method	Type	Notes
GetLastError ()	String	Returns a string value describing the most recent error that occurred in relation to this object.  This function is rarely used as an exception is thrown when an error occurs.
Update ()	Boolean	Update the current Requirement object after modification or appending a new item. If <b>false</b> is returned, check the <i>GetLastError</i> function for more information.

### 11.2.2.5.8 Resource

#### public Class

An Element *Resource* is a named person/task pair with timing constraints and percent complete indicators. Use this to manage the work associated with delivering an Element.

Associated table in .EAP file: *t\_objectresources*

#### Resource Attributes

Attribute	Type	Notes
ActualHours	Long	Read/Write. Time already expended on the task, in hours, days or other units.
DateEnd	Date	Read/Write. Expected end date.

Attribute	Type	Notes
DateStart	Date	Read/Write. Date to start work.
ExpectedHours	Long	Read/Write. The total expected time the task might run, in hours, days or other units.
History	String	Read/Write. Gets or sets history text.
Name	String	Read/Write. Name of resource (for example, person's name).
Notes	String	Read/Write. Descriptive notes.
ObjectType	<a href="#">ObjectType</a> <small> 1677 </small>	Read only. Distinguishes objects referenced through a Dispatch interface.
PercentComplete	Long	Read/Write. Current percent complete figure.
Role	String	Read/Write. Role they play in implementing the element.
Time	Long	Read/Write. Time expected; numeric indicating number of days.

### Resource Methods

Method	Type	Notes
GetLastError ()	String	Returns a string value describing the most recent error that occurred in relation to this object.  This function is rarely used as an exception is thrown when an error occurs.
Update ()	Boolean	Update the current Resource object after modification or appending a new item. If <b>false</b> is returned, check the <i>GetLastError</i> function for more information.

#### 11.2.2.5.9 Risk

### public Class

A *Risk* object represents a named risk associated with an element and is used for project management purposes. Accessed through the Element *Risks* collection.

Associated table in .EAP file: *t\_objectrisks*

### Risk Attributes

Attribute	Type	Notes
Name	String	Read/Write. The risk.
Notes	String	Read/Write. Further notes describing the risk.
ObjectType	<a href="#">ObjectType</a> <small> 1677 </small>	Read only. Distinguishes objects referenced through a Dispatch interface.
Type	String	Read/Write. The risk type associated with this element.
Weight	Long	Read/Write. A weighting for estimation or metric purposes.

## Risk Methods

Method	Type	Notes
<b>GetLastError ()</b>	<i>String</i>	Returns a string value describing the most recent error that occurred in relation to this object.  This function is rarely used as an exception is thrown when an error occurs.
<b>Update ()</b>	<i>Boolean</i>	Update the current Risk object after modification or appending a new item. If <b>false</b> is returned, check the <i>GetLastError</i> function for more information.

### 11.2.2.5.10 Scenario

#### public Class

A *Scenario* corresponds to a Collaboration or Use Case instance. Each Scenario is a path of execution through the logic of a Use Case. Scenarios can be added to using the Element *Scenarios* collection.

Associated table in .EAP file: *t\_objectscenarios*

#### Scenario Attributes

Attribute	Type	Notes
<b>Name</b>	<i>String</i>	Read/Write. The Scenario name.
<b>Notes</b>	<i>String</i>	Read/Write. Description of the Scenario. Usually contains the steps to execute the scenario.
<b>ObjectType</b>	<a href="#">ObjectType</a> <small>[1677]</small>	Read only. Distinguishes objects referenced through a Dispatch interface.
<b>ScenarioGUID</b>	<i>String</i>	Read/Write. A unique ID for the Scenario. Used to identify the Scenario unambiguously within a model.
<b>Steps</b>	<a href="#">Collection of ScenarioStep</a> <small>[1723]</small>	Read only. A collection of step objects for this Scenario. Use the <a href="#">AddNew</a> <small>[1695]</small> and <i>Delete</i> functions to manage steps. <i>AddNew</i> passes the step name and "1" as the type for an actor step.
<b>Type</b>	<i>String</i>	Read/Write. The scenario type (for example, <i>Basic Path</i> ).
<b>Weight</b>	<i>Long</i>	Read/Write. Currently used to position scenarios in the scenario list (that is, <i>List Position</i> ).
<b>XMLContent</b>	<i>String</i>	Read/Write. A structured field that can contain scenario details in XML format. It is recommended that you use the <a href="#">Steps</a> <small>[1722]</small> collection to read or modify this field.

#### Scenario Methods

Method	Type	Notes
<b>GetLastError ()</b>	<i>String</i>	Returns a string value describing the most recent error that occurred in relation to this object.  This function is rarely used as an exception is thrown when an error occurs.
<b>Update ()</b>	<i>Boolean</i>	Update the current Scenario object after modification or appending a new item. If <b>false</b> is returned, check the <i>GetLastError</i> function for more information.

### 11.2.2.5.11 ScenarioExtension

#### ScenarioExtension Attributes

Attribute	Type	Notes
ExtensionGUID	String	Read/Write. A unique GUID for this Extension.
Join	String	Read/Write. The GUID of the step where this Extension rejoins the Scenario.
JoiningStep	<a href="#">ScenarioStep</a> <small>[1723]</small>	Read only. The actual step where this Extension rejoins the Scenario, if any.
Level	String	Read only. The number of this Extension as shown in the scenario editor. This is derived from the value of <i>Pos</i> for this object and the owning step.
Name	String	Read/Write. The Extension name.  <b>Note:</b> This should match the name of the linked scenario.
ObjectType	<a href="#">ObjectType</a> <small>[1677]</small>	Read only. Distinguishes objects referenced through a Dispatch interface.
Pos	Long	Read/Write. The position of the Extension in the Extensions list
Scenario	<a href="#">Scenario</a> <small>[1722]</small>	Read only. The scenario that is executed as an alternative path for this Extension.

#### ScenarioExtension Methods

Method	Type	Notes
GetLastError ()	String	Returns a string value describing the most recent error that occurred in relation to this object.  This function is rarely used as an exception is thrown when an error occurs.
Update ()	Boolean	Update the current <i>ScenarioExtension</i> object after modification or appending a new item. If <b>false</b> is returned, check the <i>GetLastError</i> function for more information.

### 11.2.2.5.12 ScenarioStep

#### ScenarioStep Attributes

Attribute	Type	Notes
Extensions	Collection of <a href="#">ScenarioExtension</a> <small>[1723]</small>	Read only. A collection of <i>ScenarioExtension</i> objects that specify how the scenario is extended from this step. The arguments to <a href="#">AddNew</a> <small>[1695]</small> should match the name and GUID of the alternative scenario being linked to.
Level	String	Read only. The number of this Step as shown in the scenario editor. This is derived from the value of <i>Pos</i> .
Link	String	Read/Write. The GUID of a Use Case that is relevant to this step.
LinkedElement	<a href="#">Element</a> <small>[1711]</small>	Read only. The actual element specified by Link, if any.

Attribute	Type	Notes
<b>t</b>		
<b>Name</b>	<i>String</i>	Read/Write. The Step name.
<b>ObjectType</b>	<a href="#">ObjectType</a> <sup>[1677]</sup>	Read only. Distinguishes objects referenced through a Dispatch interface.
<b>Pos</b>	<i>Long</i>	Read/Write. The position of the Step in the Scenario Step list.
<b>Results</b>	<i>String</i>	Read/Write. Any results that are given from this step.
<b>State</b>	<i>String</i>	Read/Write. A description of the state the system enters when this Step is executed.
<b>StepGUID</b>	<i>String</i>	Read/Write. A unique GUID for this Step.
<b>StepType</b>	<a href="#">ScenarioStepType</a> <sup>[1678]</sup>	Read/Write. Identifies whether this step is being performed by a user or the system.
<b>Uses</b>	<i>String</i>	Read/Write. Input and requirements that are relevant to this step.

### ScenarioStep Methods

Method	Type	Notes
<b>GetLastError ()</b>	<i>String</i>	Returns a string value describing the most recent error that occurred in relation to this object.  This function is rarely used as an exception is thrown when an error occurs.
<b>Update ()</b>	<i>Boolean</i>	Update the current <i>ScenarioStep</i> object after modification or appending a new item. If <b>false</b> is returned, check the <i>GetLastError</i> function for more information.

#### 11.2.2.5.13 TaggedValue

### public Class

A *TaggedValue* is a named property and value associated with an element. It is accessed through the *TaggedValues* collection.

Associated table in .EAP file: *t\_objectproperties*

### TaggedValue Attributes

Attribute	Type	Notes
<b>ElementID</b>	<i>Long</i>	Read/Write. The local ID of the associated element.
<b>Name</b>	<i>String</i>	Read/Write. Name of the tag.
<b>Notes</b>	<i>String</i>	Read/Write. Further descriptive notes about this tag.  If <b>Value</b> (below) is set to " <b>&lt;memo&gt;</b> ", then <b>Notes</b> should contain the actual Tagged Value content.
<b>ObjectType</b>	<a href="#">ObjectType</a> <sup>[1677]</sup>	Read only. Distinguishes objects referenced through a Dispatch interface.
<b>PropertyGUID</b>	<i>String</i>	Read/Write. The tag global ID.
<b>PropertyID</b>	<i>Long</i>	Read only. The tag local ID.



Attribute	Type	Notes
Value	String	Read/Write. The value assigned to this tag.  This field has a 255 character limit. If the value is greater than 255 characters long, set the value to "<memo>" and insert the body of text in the <b>Notes</b> attribute (above).  When reading existing Tagged Values, if <b>Value</b> = "<memo>" then the developer should read the actual body of text from the <b>Notes</b> attribute.

### TaggedValue Methods

Method	Type	Notes
GetLastError()	String	Returns a string value describing the most recent error that occurred in relation to this object.  This function is rarely used as an exception is thrown when an error occurs.
Update()	Boolean	Update the current TaggedValue object after modification or appending a new item. If <b>false</b> is returned, check the <i>GetLastError</i> function for more information.

#### 11.2.2.5.14 Test

### public Class

A *Test* is a single Test Case applied to an element. Tests are added and accessed through the Element *Tests* collection.

Associated table in .EAP file: *t\_objecttests*

### Test Attributes

Attribute	Type	Notes
AcceptanceCriteria	String	Read/Write. The acceptance criteria for successful execution.
CheckedBy	String	Read/Write. Results confirmed by.
Class	Long	Read/Write. The test Class:  1 = Unit Test 2 = Integration Test 3 = System Test 4 = Acceptance Test 5 = Scenario Test.
DateRun	Date	Read/Write. Date last run.
Input	String	Read/Write. Input data.
Name	String	Read/Write. The test name.
Notes	String	Read/Write. Detailed notes about test to be carried out.
ObjectType	<a href="#">ObjectType</a> <small> 1677 </small>	Read only. Distinguishes objects referenced through a Dispatch interface.
RunBy	String	Read/Write. Person conducting test.
Status	String	Read/Write. Current status of test.
TestResults	Variant	Read/Write. Results of test.

Attribute	Type	Notes
Type	<i>String</i>	Read/Write. The test type, such as Load or Regression.

### Test Methods

Method	Type	Notes
<b>GetLastError ()</b>	<i>String</i>	Returns a string value describing the most recent error that occurred in relation to this object.  This function is rarely used as an exception is thrown when an error occurs.
<b>Update ()</b>	<i>Boolean</i>	Update the current Test object after modification or appending a new item. If <b>false</b> is returned, check the <i>GetLastError</i> function for more information.

### 11.2.2.6 Element Features

#### public Package

The *ElementFeatures* package contains descriptions of the model interfaces that enable access to operations and attributes, and their associated Tagged Values and constraints.

This diagram illustrates the components associated with element features. These include *Attributes* and *Methods*, and the associated constraints and Tagged Values related to them. It also includes the *Parameter* object that defines the arguments associated with an operation (method).

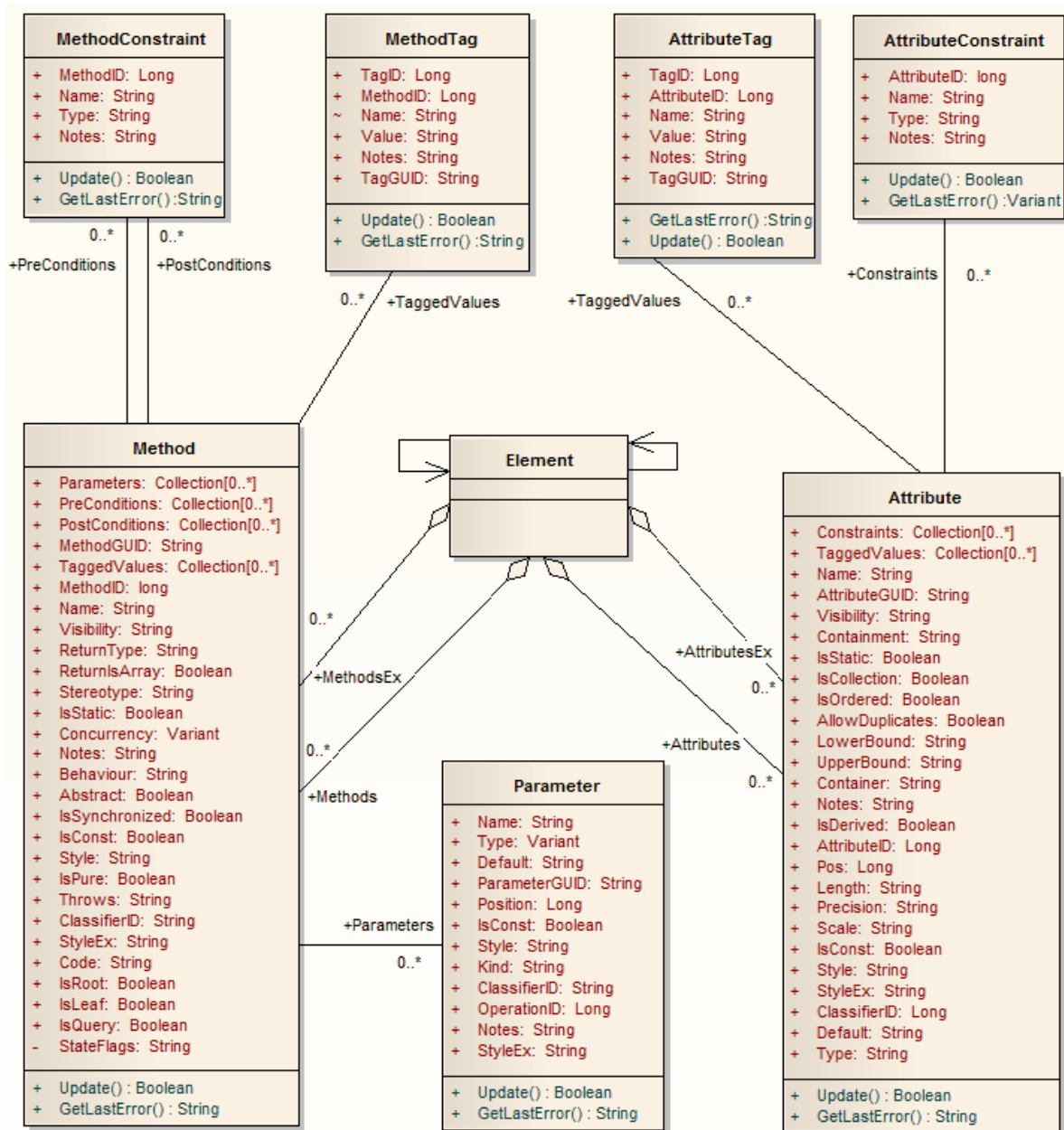

### 11.2.2.6.1 Attribute

#### public Class

An *attribute* corresponds to a UML Attribute. It contains further collections for constraints and Tagged Values. Attributes are accessed from the Element *Attributes* collection.

Associated table in .EAP file: *t\_attribute*

#### Attribute Attributes

Attribute	Type	Notes
<b>AllowDuplicate</b> s	<i>Boolean</i>	Read/Write. Indicates if duplicates are allowed in the collection. If the attribute represents a database column, this when set represents the <b>Not Null</b> option.

Attribute	Type	Notes
AttributeGUID	String	Read/Write. A globally unique ID for the current attribute. System generated.
AttributeID	Long	Read only. Local ID number of the attribute.
ClassifierID	Long	Read/Write. Classifier ID, if appropriate; indicates the base type associated with attribute, if not a primitive type.
Container	String	Read/Write. The container type.
Containment	String	Read/Write. Type of containment. Can be <b>Not Specified, By Reference</b> or <b>By Value</b> .
Constraints	<a href="#">Collection</a> <small>[1695]</small>	Read only. A collection of <i>AttributeConstraint</i> objects. Used to access and manage constraints associated with this attribute.
Default	String	Read/Write. Initial value assigned to this attribute.
IsCollection	Boolean	Read/Write. Indicates if the current feature is a collection or not. If the attribute represents a database column, this when set represents a Foreign Key.
IsConst	Boolean	Read/Write. Flag indicating if the attribute is <b>Const</b> or not.
IsDerived	Boolean	Read/Write. Indicates if the attribute is derived (that is, a calculated value).
IsOrdered	Boolean	Read/Write. Indicates if a collection is ordered or not. If the attribute represents a database column, this when set represents a Primary Key.
IsStatic	Boolean	Read/Write. Indicates if the current attribute is a static feature or not. If the attribute represents a database column, this when set represents the <b>Unique</b> option.
Length	String	Read/Write. The attribute length, where applicable.
LowerBound	String	Read/Write. A value for the collection lower bound.
Name	String	Read/Write. The attribute name.
Notes	String	Read/Write. Further notes about this attribute.
ObjectType	<a href="#">ObjectType</a> <small>[1677]</small>	Read only. Distinguishes objects referenced through a Dispatch interface.
ParentID	Long	Read only. Returns the <i>ElementID</i> of the element that this attribute is a part of.
Pos	Long	Read/Write. Position of the attribute in the Class attribute list.
Precision	String	Read/Write. Precision value.
Scale	String	Read/Write. Scale value.
Stereotype	String	Read/Write. Sets or gets the stereotype for this attribute.
StereotypeEx	String	Read/Write. All the applied stereotypes of the attribute in a comma-separated list.
Style	String	Read/Write. Contains the <b>Alias</b> property for this attribute.
StyleEx	String	Read/Write. Advanced style settings. Reserved for the use of Sparx Systems.
TaggedValues	<a href="#">Collection</a> <small>[1695]</small> of type	Read only. A collection of <i>AttributeTag</i> objects. Use to access and manage Tagged Values associated with this attribute.

Attribute	Type	Notes
	<a href="#">AttributeTag</a> [1730]	
<b>TaggedValuesEx</b>	<a href="#">Collection</a> [1695] of type <a href="#">TaggedValue</a> e [1724]	Read only. Collection of <i>TaggedValue</i> objects belonging to the current attribute and the <i>TaggedValuesEx</i> property of its classifier.
<b>Type</b>	<i>String</i>	Read/Write. The attribute type (by name; also see <i>ClassifierID</i> ).
<b>UpperBound</b>	<i>String</i>	Read/Write. A value for the collection upper bound.
<b>Visibility</b>	<i>String</i>	Read/Write. The scope of the attribute. Can be <b>Private</b> , <b>Protected</b> , <b>Public</b> or <b>Package</b> .

### Attribute Methods

Method	Type	Notes
<b>GetLastError ()</b>	<i>String</i>	Returns a string value describing the most recent error that occurred in relation to this object.  This function is rarely used as an exception is thrown when an error occurs.
<b>Update ()</b>	<i>Boolean</i>	Updates the current attribute object after modifying or appending a new item. If <b>false</b> is returned, check the <i>GetLastError</i> function for more information.

#### 11.2.2.6.2 AttributeConstraint

### public Class

An *AttributeConstraint* is a constraint associated with the current Attribute.

Associated table in .EAP file: *t\_attributeconstraints*

### AttributeConstraint Attributes

Attribute	Type	Notes
<b>AttributeID</b>	<i>Long</i>	Read/Write. ID of the attribute this constraint applies to.
<b>Name</b>	<i>String</i>	Read/Write. The constraint.
<b>Notes</b>	<i>String</i>	Read/Write. Descriptive notes about constraint.
<b>ObjectType</b>	<a href="#">ObjectType</a> [1677]	Read only. Distinguishes objects referenced through a Dispatch interface.
<b>Type</b>	<i>String</i>	Read/Write. Type of constraint.

### AttributeConstraint Methods

Method	Type	Notes
<b>GetLastError ()</b>	<i>String</i>	Returns a string value describing the most recent error that occurred in relation to this object.  This function is rarely used as an exception is thrown when an error occurs.

Method	Type	Notes
<b>Update ()</b>	<i>Boolean</i>	Update the current <i>AttributeConstraint</i> object after modification or appending a new item. If <b>false</b> is returned, check the <i>GetLastError</i> function for more information.

### 11.2.2.6.3 AttributeTag

#### public Class

An *AttributeTag* represents a Tagged Value associated with an attribute.

Associated table in .EAP file: *t\_attributetag*

#### AttributeTag Attributes

Attribute	Type	Notes
<b>AttributeID</b>	<i>Long</i>	Read/Write. Local ID of attribute associated with this Tagged Value.
<b>Name</b>	<i>String</i>	Read/Write. Name of tag.
<b>Notes</b>	<i>String</i>	Read/Write. Further descriptive notes about this tag. If <b>Value</b> (below) is set to " <b>&lt;memo&gt;</b> ", then <b>Notes</b> should contain the actual Tagged Value content.
<b>ObjectType</b>	<a href="#">ObjectType</a> <small>[167]</small>	Read only. Distinguishes objects referenced through a Dispatch interface.
<b>TagGUID</b>	<i>String</i>	Read/Write. A globally unique ID for this Tagged Value.
<b>TagID</b>	<i>Long</i>	Read only. Local ID to identify Tagged Value.
<b>Value</b>	<i>String</i>	Read/Write. The value assigned to this tag. This field has a 255 character limit. If the value is greater than 255 characters long, set the value to " <b>&lt;memo&gt;</b> " and insert the body of text in the <b>Notes</b> attribute (above). When reading existing Tagged Values, if <b>Value</b> = " <b>&lt;memo&gt;</b> " then the developer should read the actual body of text from the <b>Notes</b> attribute.

#### AttributeTag Methods

Method	Type	Notes
<b>GetLastError ()</b>	<i>String</i>	Returns a string value describing the most recent error that occurred in relation to this object. This function is rarely used as an exception is thrown when an error occurs.
<b>Update ()</b>	<i>Boolean</i>	Update the current <i>AttributeTag</i> object after modification or appending a new item. If <b>false</b> is returned, check the <i>GetLastError</i> function for more information.

### 11.2.2.6.4 CustomProperties

#### public Collection

The *CustomProperties* collection contains 0 or more *Cust Properties* associated with the current element. These properties provide advanced UML configuration options, and must not be added to or deleted. The value of each property can be set.

**Note:**

The number and type of properties vary depending on the actual element.

**CustomProperty**

Attribute	Type	Notes
Name	String	Read only. The CustomProperty name.
ObjectType	<a href="#">ObjectType</a> <small>[167]</small>	Read only. Distinguishes objects referenced through a Dispatch interface.
Value	String	Read/Write. The value associated with this custom property. Can be a string, the boolean values <b>true</b> or <b>false</b> , or an enumeration value from a defined list. The UML 2.3 specification in general provides information on enumeration kinds relevant here.

**11.2.2.6.5 EmbeddedElements****public Collection**

In UML 2.3 an element can have one or more embedded elements such as Ports, Pins, Parameters or ObjectNodes. These are attached to the boundary of the host element and cannot be moved off the element. They are owned by their host element. This collection gives easy access to the set of elements embedded on the surface of an element. Note that some embedded elements can have their own embedded element collection (for example, Ports can have Interfaces embedded on them).

The *EmbeddedElements* collection contains Element objects.

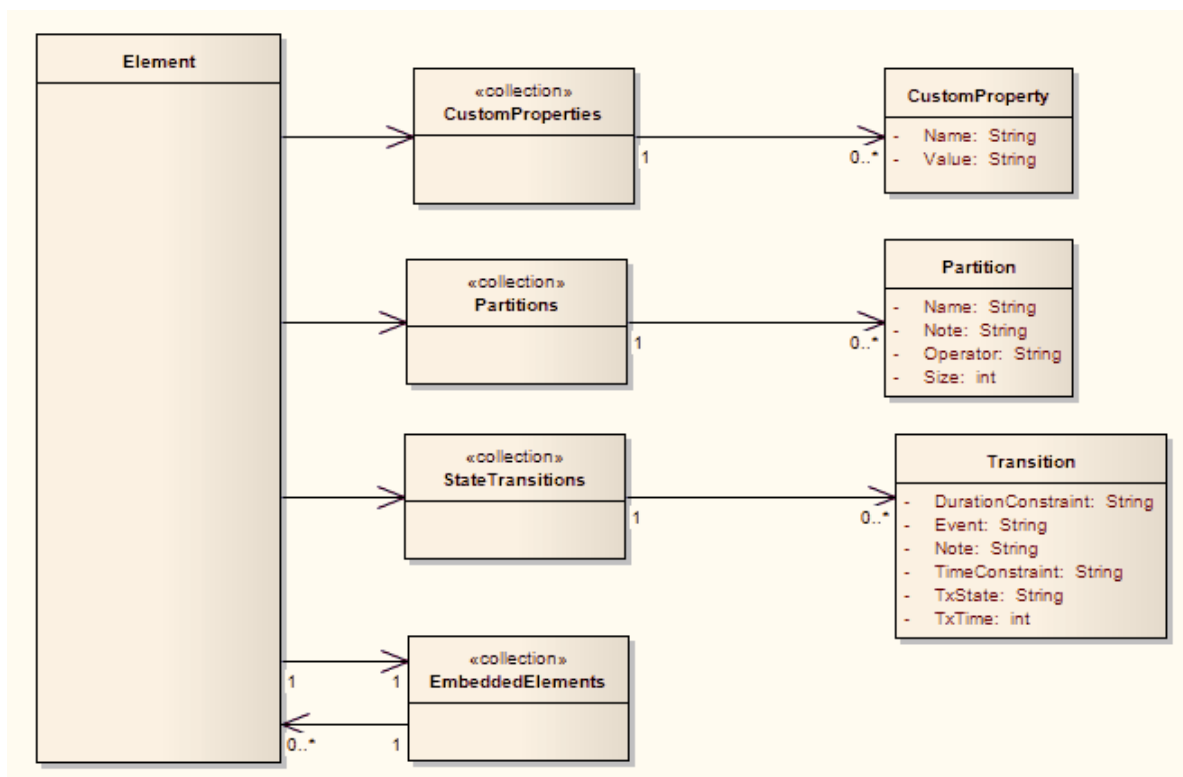

### 11.2.2.6.6 Method

#### public Class

A *method* represents a UML *operation*. It is accessed from the Element *Methods* collection and includes collections for parameters, constraints and Tagged Values.

Associated table in .EAP file: *t\_operation*

#### Method Attributes

Attribute	Type	Notes
<b>Abstract</b>	<i>Boolean</i>	Read/Write. Flag indicating if the method is abstract ( <b>1</b> ) or not ( <b>0</b> ).
<b>Behavior</b>	<i>String</i>	Read/Write. Some further explanatory behavior notes (for example, pseudocode).  <b>Note:</b> In earlier releases of Enterprise Architect this attribute had the UK/Australian spelling 'Behaviour'; this is still present for backwards compatibility, but please now use the 'Behavior' attribute for consistency.
<b>ClassifierID</b>	<i>String</i>	Read/Write. Classifier ID that applies to the <i>ReturnType</i> .
<b>Code</b>	<i>String</i>	Read/Write. Optional field to hold the method Code (used for the <b>Initial Code</b> field).
<b>Concurrency</b>	<i>Variant</i>	Read/Write. Concurrency type of method.
<b>IsConst</b>	<i>Boolean</i>	Read/Write. Flag indicating the method is <b>Const</b> .
<b>IsLeaf</b>	<i>Boolean</i>	Read/Write. Flag to indicate if the method is <i>Leaf</i> (cannot be overridden).
<b>IsPure</b>	<i>Boolean</i>	Read/Write. Flag indicating the method is defined as Pure in C++.
<b>IsQuery</b>	<i>Boolean</i>	Read/Write. Flag to indicate if the method is a query (that is, does not alter Class variables).
<b>IsRoot</b>	<i>Boolean</i>	Read/Write. Flag to indicate if the method is <i>Root</i> .
<b>IsStatic</b>	<i>Boolean</i>	Read/Write. Flag to indicate a static method.
<b>IsSynchronized</b>	<i>Boolean</i>	Read/Write. Flag indicating a Synchronized method call.
<b>MethodGUID</b>	<i>String</i>	Read/Write. A globally unique ID for the current method. System generated.
<b>MethodID</b>	<i>Long</i>	Read only. A local ID for the current method, only valid within this .EAP file.
<b>Name</b>	<i>String</i>	Read/Write. The method name.
<b>Notes</b>	<i>String</i>	Read/Write. Descriptive notes about the method.
<b>ObjectType</b>	<a href="#">ObjectType</a> <small>1677</small>	Read only. Distinguishes objects referenced through a Dispatch interface.
<b>Parameters</b>	<a href="#">Collection</a> <small>1695</small>	Read only. The <i>Parameters</i> collection for the current method. Use to add and access parameter objects for the current method.
<b>ParentID</b>	<i>Long</i>	Read only. Returns the <i>ElementID</i> of the element that this method belongs to.
<b>Pos</b>	<i>Long</i>	Read/Write. Specifies the position of the method within the set of



Attribute	Type	Notes
		operations defined for a Class.
PostConditions	<a href="#">Collection</a> <small>[1695]</small>	Read only. PostConditions (constraints) as they apply to this method. Returns a <i>MethodConstraint</i> object of type <b>post</b> .
PreConditions	<a href="#">Collection</a> <small>[1695]</small>	Read only. PreConditions (constraints) as they apply to this method. Returns a <i>MethodConstraint</i> object of type <b>pre</b> .
ReturnsArray	Boolean	Read/Write. Flag to indicate the return value is an array.
ReturnType	String	Read/Write. Return type for the method; can be a primitive data type or a Class or Interface type.
StateFlags	String	Read/Write. Some flags as applied to methods in State elements.
Stereotype	String	Read/Write. The method stereotype (optional).
StereotypeEx	String	Read/Write. All the applied stereotypes of the method in a comma-separated list.
Style	String	Read/Write. Contains the <b>Alias</b> property for this method.
StyleEx	String	Read/Write. Advanced style settings. Reserved for the use of Sparx Systems.
TaggedValues	<a href="#">Collection</a> <small>[1695]</small> of type <a href="#">MethodTag</a> <small>[1734]</small>	Read only. <i>TaggedValues</i> collection for the current method. Accesses a list of <i>MethodTag</i> objects.
Throws	String	Read/Write. Exception information.
Visibility	String	Read/Write. The method scope: <b>Public</b> , <b>Protected</b> , <b>Private</b> or <b>Package</b> .

## Method Methods

Method	Type	Notes
GetLastError ()	String	Returns a string value describing the most recent error that occurred in relation to this object.  This function is rarely used as an exception is thrown when an error occurs.
Update ()	Boolean	Update the current method object after modification or appending a new item. If <b>false</b> is returned, check the <i>GetLastError</i> function for more information.

### 11.2.2.6.7 MethodConstraint

#### public Class

A *MethodConstraint* is a condition imposed on a method. It is accessed through either the Method *PreConditions* or Method *PostConditions* collection.

Associated table in .EAP file: *t\_operationpres* and *t\_operationposts*

#### MethodConstraint Attributes

Attribute	Type	Notes
MethodID	Long	Read/Write. The local ID of the associated method.

Attribute	Type	Notes
Name	String	Read/Write. The name of the constraint.
Notes	String	Read/Write. Descriptive notes about this constraint.
ObjectType	<a href="#">ObjectType</a> [1677]	Read only. Distinguishes objects referenced through a Dispatch interface.
Type	String	Read/Write. The constraint type.

### MethodConstraint Methods

Method	Type	Notes
GetLastError ()	String	Returns a string value describing the most recent error that occurred in relation to this object.  This function is rarely used as an exception is thrown when an error occurs.
Update ()	Boolean	Update the current <i>MethodConstraint</i> object after modification or appending a new item. If <b>false</b> is returned, check the <i>GetLastError</i> function for more information.

#### 11.2.2.6.8 MethodTag

### public Class

A *MethodTag* is a Tagged Value associated with a method.

Associated table in .EAP file: *t\_operationtag*

### MethodTag Attributes

Attribute	Type	Notes
MethodID	Long	Read/Write. The ID of the associated method.
Name	String	Read/Write. The tag or name of the property.
Notes	String	Read/Write. Further descriptive notes about this tag.  If <b>Value</b> (below) is set to " <b>&lt;memo&gt;</b> ", then <b>Notes</b> should contain the actual Tagged Value content.
ObjectType	<a href="#">ObjectType</a> [1677]	Read only. Distinguishes objects referenced through a Dispatch interface.
TagGUID	String	Read/Write. A unique GUID for this Tagged Value.
TagID	Long	Read only. A unique ID for this Tagged Value.
Value	String	Read/Write. The value assigned to this tag.  This field has a 255 character limit. If the value is greater than 255 characters long, set the value to " <b>&lt;memo&gt;</b> " and insert the body of text in the <b>Notes</b> attribute (above).  When reading existing Tagged Values, if <b>Value</b> = " <b>&lt;memo&gt;</b> " then the developer should read the actual body of text from the <b>Notes</b> attribute.

## MethodTag Methods

Method	Type	Notes
<b>GetLastError ()</b>	<i>String</i>	Returns a string value describing the most recent error that occurred in relation to this object.  This function is rarely used as an exception is thrown when an error occurs.
<b>Update ()</b>	<i>Boolean</i>	Update the current <i>MethodTag</i> object after modification or appending a new item. If <b>false</b> is returned, check the <i>GetLastError</i> function for more information.

### 11.2.2.6.9 Parameter

#### public Class

A Parameter object represents a method argument and is accessed through the *Method Parameters* collection.

Associated table in .EAP file: *t\_operationparams*

#### Parameter Attributes

Attribute	Type	Notes
<b>Alias</b>	<i>String</i>	Read/Write. An optional alias for this parameter.
<b>ClassifierID</b>	<i>String</i>	Read/Write. A ClassifierID for the parameter, if known.
<b>Default</b>	<i>String</i>	Read/Write. A default value for this parameter.
<b>IsConst</b>	<i>Boolean</i>	Read/Write. Flag indicating the parameter is <i>Const</i> (cannot be altered).
<b>Kind</b>	<i>String</i>	Read/Write. The parameter kind - <b>in</b> , <b>inout</b> , <b>out</b> , <b>return</b> .
<b>Name</b>	<i>String</i>	Read/Write. The parameter name; must be unique for a single method.
<b>Notes</b>	<i>String</i>	Read/Write. Descriptive notes.
<b>ObjectType</b>	<a href="#">ObjectType</a> <small>[1677]</small>	Read only. Distinguishes objects referenced through a Dispatch interface.
<b>OperationID</b>	<i>Long</i>	Read only. ID of the method associated with this parameter.
<b>ParameterGUID</b>	<i>String</i>	Read/Write. A globally unique ID for the current Parameter. System generated.
<b>Position</b>	<i>Long</i>	Read/Write. The position in the argument list.
<b>Stereotype</b>	<i>String</i>	Read/Write. The first stereotype of the parameter.
<b>StereotypeEx</b>	<i>String</i>	Read/Write. All the applied stereotypes of the parameter in a comma-separated list.
<b>Style</b>	<i>String</i>	Read/Write. Some style information.
<b>StyleEx</b>	<i>String</i>	Read/Write. Advanced style settings. Reserved for the use of Sparx Systems.
<b>Type</b>	<i>Variant</i>	Read/Write. The parameter type; can be a primitive type or defined classifier.

## Parameter Methods

Method	Type	Notes
<b>GetLastError ()</b>	<i>String</i>	Returns a string value describing the most recent error that occurred in relation to this object.  This function is rarely used as an exception is thrown when an error occurs.
<b>Update ()</b>	<i>Boolean</i>	Update the current Parameter object after modifying or appending a new item. If <b>false</b> is returned, check the <i>GetLastError</i> function for more information.

### 11.2.2.6.10 Partitions

#### public Collection

A collection of internal element partitions (regions). This is commonly seen in [Activity](#) <sup>[753]</sup>, [State](#) <sup>[789]</sup>, [Boundary](#) <sup>[836]</sup>, [Diagram Frame](#) <sup>[766]</sup> and similar elements. Not all elements support partitions.

This collection contains a set of *Partition* elements. The set is read/write: information is not saved until the host element is saved, so ensure that you call the *Element.Save* method after making changes to a *Partition*.

#### Partition Attributes

Attribute	Type	Notes
<b>Name</b>	<i>String</i>	Read/Write. The partition name; can represent a condition or constraint in some cases.
<b>Note</b>	<i>String</i>	Read/Write. A free text note associated with this partition.
<b>ObjectType</b>	<a href="#">ObjectType</a> <sup>[167]</sup>	Read only. Distinguishes objects referenced through a Dispatch interface.
<b>Operator</b>	<i>String</i>	Read/Write. An optional operator value that specifies the partition type.
<b>Size</b>	<i>String</i>	Read/Write. Vertical or horizontal width of partition in pixels.

### 11.2.2.6.11 Properties

#### Properties

##### Properties Attributes

Attribute	Type	Notes
<b>Count</b>	<i>Long</i>	The number of properties that are available for this object.
<b>ObjectType</b>	<a href="#">ObjectType</a> <sup>[167]</sup>	Read only. Distinguishes objects referenced through a Dispatch interface.

##### Properties Methods

Method	Type	Notes
<b>Item (object Index)</b>	<i>Property</i>	Returns a property either by name or by zero-based integer offset into the list of properties.  Parameter: <ul style="list-style-type: none"> <li>Index: Variant - either a string representing the property name or an integer representing the zero-based offset into the property list.</li> </ul>

## Property

### Property Attributes

Attribute	Type	Notes
Name	String	Read only. Identifies the property. The object to which the properties list applies can have an automation property with the same name, in which case the data accessed through <b>Value</b> is identical to that obtained through the automation property.
ObjectType	<a href="#">ObjectType</a> <small>1677</small>	Read only. Distinguishes objects referenced through a Dispatch interface.
Type	<a href="#">PropType</a> <small>1678</small>	Read only. Provides an indication of what sort of data is going to be stored by this property. This restriction can be further defined by the Validation attribute.
Validation	String	Read only. Optional string that is used to validate any data that is passed to the Value attribute. This string is used by the programmer at run time to provide an indication of what's expected, and by Enterprise Architect to ensure that the submitted data is appropriate.
Value	Variant	Read/write. The value of the property as defined in the other fields.

### 11.2.2.6.12 Transitions

#### public Collection

Applies only to *Timeline elements*. A Timeline element displays 0 or more state transitions at set times on its extent. This collection enables you to access the transition set. You can also access additional information by referring to the connectors associated with the Timeline, and by referencing messages passed between timelines. Note that any changes made to elements in this collection are only saved when the main element is saved.

#### Transition Attributes

Attribute	Type	Notes
DurationConstraint	String	Read/Write. A constraint on the time duration that the transition takes.
Event	String	Read/Write. Event (optional) that initiated transition.
Note	String	Read/Write. A free text note.
ObjectType	<a href="#">ObjectType</a> <small>1677</small>	Read only. Distinguishes objects referenced through a Dispatch interface.
TimeConstraint	String	Read/Write. A constraint on when the transition has to be complete by.
TxState	String	Read/Write. The state to transition to. Defined in the <b>Timeline Properties</b> dialog.
TxTime	String	Read/Write. The time that the transition occurs. Value depends on range set in diagram.

### 11.2.2.7 Connector

#### public Package

The *Connector* package details how connectors between elements are accessed and managed.

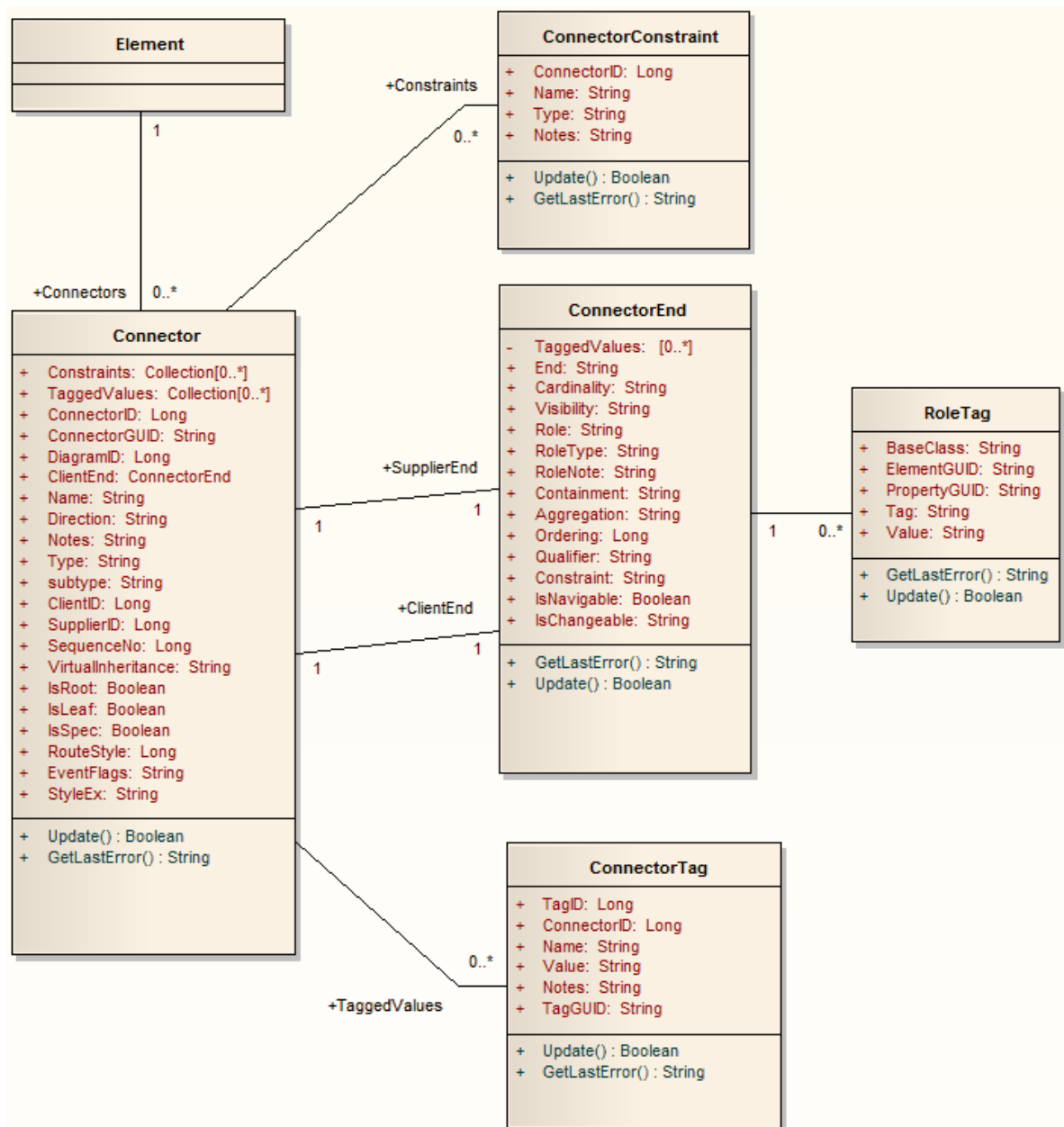

#### 11.2.2.7.1 ConnectorConstraint

##### public Class

A *ConnectorConstraint* holds information about special conditions that apply to a connector. It is accessed through the *Connector Constraints* collection.

Associated table in .EAP file: `t_connectorconstraints`

### ConnectorConstraint Attributes

Attribute	Type	Notes
ConnectorID	Long	Read/Write. A local ID value (long) - system generated.
Name	String	Read/Write. The constraint name.
Notes	String	Read/Write. Notes about this constraint.
ObjectType	<a href="#">ObjectType</a> <small>(1677)</small>	Read only. Distinguishes objects referenced through a Dispatch interface.
Type	String	Read/Write. The constraint type.

### ConnectorConstraint Methods

Method	Type	Notes
GetLastError() ( )	String	Returns a string value describing the most recent error that occurred in relation to this object.  This function is rarely used as an exception is thrown when an error occurs.
Update() ( )	Boolean	Update the current <i>ConnectorConstraint</i> object after modification or appending a new item. If <b>false</b> is returned, check the <i>GetLastError</i> function for more information.

#### 11.2.2.7.2 Connector

##### public Class

A *Connector* object represents the various kinds of connectors between UML elements. It is accessed from either the *Client* or *Supplier* element, using the *Connectors* collection of that element. When creating a new connector you must assign it a valid type from the following list:

- Aggregation
- Assembly
- Association
- Collaboration
- CommunicationPath
- Connector
- ControlFlow
- Delegate
- Dependency
- Deployment
- ERLink
- Generalization
- InformationFlow
- Instantiation
- InterruptFlow
- Manifest
- Nesting
- NoteLink
- ObjectFlow
- Package
- Realization
- Sequence
- StateFlow

- UseCase

Associated table in .EAP file: *t\_connector*

### Connector Attributes

Attribute	Type	Notes
Alias	String	Read/Write. An optional alias for this connector.
ClientEnd	<a href="#">ConnectorEnd</a> <sup>[1742]</sup>	Read only. A pointer to the <i>ConnectorEnd</i> object representing the source end of the relationship.
ClientID	Long	Read/Write. <i>ElementID</i> of the element at the source end of this connector.
Color	Long	Read/Write. Sets the color of the connector.
ConnectorGUID	VARIANT	Read only. A globally unique ID for the current connector. System generated.
ConnectorID	Long	Read only. Local identifier for the current connector. System generated.
Constraints	<a href="#">Collection</a> <sup>[1695]</sup>	Read only. Collection of <a href="#">constraint</a> <sup>[1710]</sup> objects.
CustomProperties	<a href="#">Collection</a> <sup>[1695]</sup>	Read only. Returns a collection of advanced properties associated with an element in the form of <a href="#">CustomProperty</a> <sup>[1730]</sup> objects.
DiagramID	Long	Read/Write. The <i>DiagramID</i> of the connector.
Direction	String	Read/Write. Connector direction. Can be set to one of the following: <ul style="list-style-type: none"> <li>• Unspecified</li> <li>• Bi-Directional</li> <li>• Source -&gt; Destination</li> <li>• Destination -&gt; Source</li> </ul>
EndPointX	Long	Read/Write. The x-coordinate of the connector's end point.  <b>Note:</b> Connector end points are specified in Cartesian coordinates with the origin to the top left of the screen.
EndPointY	Long	Read/Write. The y-coordinate of the connector's end point.  <b>Note:</b> Connector end points are specified in Cartesian coordinates with the origin to the top left of the screen.
EventFlags	String	Read/Write. Structure to hold a variety of flags concerned with event signaling on messages.
IsLeaf	Boolean	Read/Write. Flag indicating connector is a <i>leaf</i> .
IsRoot	Boolean	Read/Write. Flag indicating connector is a <i>root</i> .
IsSpec	Boolean	Read/Write. Flag indicating connector is a specification.
MetaType	String	Read only. The connector's domain-specific meta type, as defined by an applied stereotype from an MDG Technology.
MiscData	String	Read only. This low-level property provides information about the contents of the <b>PData</b> fields. These database fields are not documented and developers must gain understanding of these fields



Attribute	Type	Notes
		through their own endeavors to use this property. <b>MiscData</b> is zero based, therefore: <ul style="list-style-type: none"> <li>• <b>MiscData(0)</b> corresponds to <b>PData1</b></li> <li>• <b>MiscData(1)</b> to <b>PData2</b></li> </ul> and so on.
<b>Name</b>	<i>String</i>	Read/Write. The connector name.
<b>Notes</b>	<i>String</i>	Read/Write. Descriptive notes about the connector.
<b>ObjectType</b>	<a href="#">ObjectType</a> <small>[1677]</small>	Read only. Distinguishes objects referenced through a Dispatch interface.
<b>Properties</b>	<a href="#">Properties</a> <small>[1736]</small>	Returns a list of specialized properties that apply to the connector that might not be available using the automation model. The properties are purposely undocumented because of their obscure nature and because they are subject to change as progressive enhancements are made to them.
<b>RouteStyle</b>	<i>Long</i>	Read/Write. The route style.
<b>SequenceNo</b>	<i>Long</i>	Read/Write. The <i>SequenceNo</i> of the connector.
<b>StartPointX</b>	<i>Long</i>	Read/Write. The x-coordinate of the connector's start point.  <b>Note:</b> Connector end points are specified in Cartesian coordinates with the origin to the top left of the screen.
<b>StartPointY</b>	<i>Long</i>	Read/Write. The y-coordinate of the connector's start point.  <b>Note:</b> Connector end points are specified in Cartesian coordinates with the origin to the top left of the screen.
<b>StateFlags</b>	<i>String</i>	Read/Write. Structure to hold a variety of flags concerned with State signaling on messages, the list delimited by semi-colons.
<b>Stereotype</b>	<i>String</i>	Read/Write. Sets or gets the stereotype for this connector end.
<b>StereotypeEx</b>	<i>String</i>	Read/Write. All the applied stereotypes of the connector in a comma-separated list.
<b>StyleEx</b>	<i>String</i>	Read/Write. Advanced style settings. Reserved for the use of Sparx Systems.
<b>Subtype</b>	<i>String</i>	Read/Write. A possible subtype to refine the meaning of the connector.
<b>SupplierEnd</b>	<a href="#">ConnectorEnd</a> <small>[1742]</small>	Read only. A pointer to the <i>ConnectorEnd</i> object representing the target end of the relationship.
<b>SupplierID</b>	<i>Long</i>	Read/Write. <i>ElementID</i> of the element at the target end of this connector.
<b>TaggedValues</b>	<i>Collection</i>	Read only. Collection of <i>ConnectorTag</i> objects.
<b>TransitionAction</b>	<i>String</i>	Read/Write. See the <a href="#">Transition</a> <small>[892]</small> topic for appropriate values.
<b>TransitionEvent</b>	<i>String</i>	Read/Write. See the <a href="#">Transition</a> <small>[892]</small> topic for appropriate values.

Attribute	Type	Notes
TransitionGuard	String	Read/Write. See the <a href="#">Transition</a> topic for appropriate values.
Type	String	Read/Write. Connector type. Valid types are held in the <i>t_connectortypes</i> table in the .EAP file.
VirtualInheritance	String	Read/Write. For <i>Generalization</i> , indicates if inheritance is virtual.
Width	Long	Read/Write. Specifies the width of the connector.

### Connector Methods

Method	Type	Notes
GetLastError ()	String	Returns a string value describing the most recent error that occurred in relation to this object.  This function is rarely used as an exception is thrown when an error occurs.
MiscData (long Index)	String	Read only. This low-level property provides information about the contents of the <b>PData</b> fields. These database fields are not documented and developers must gain understanding of these fields through their own endeavors to use this property.  <b>MiscData</b> is zero based, therefore: <ul style="list-style-type: none"> <li>• <b>MiscData(0)</b> corresponds to <b>PData1</b></li> <li>• <b>MiscData(1)</b> to <b>PData2</b></li> </ul> Parameters: <ul style="list-style-type: none"> <li>• Index: long - the zero based index of the <b>PData</b> field to access.</li> </ul>
Update ()	Boolean	Update the current <i>ConnectorObject</i> after modification or appending a new item. If <b>false</b> is returned, check the <i>GetLastError</i> function for more information.

#### 11.2.2.7.3 ConnectorEnd

##### public Class

A *ConnectorEnd* contains information about a single end of a connector. A *ConnectorEnd* is accessed from the connector as either the *ClientEnd* or *SupplierEnd*.

Associated table in .EAP file: derived from *t\_connector*

##### ConnectorEnd Attributes

Attribute	Type	Notes
Aggregation	Long	Read/Write. Aggregation as it applies to this end. Valid values are:  0 = None 1 = Shared 2 = Composite.
Alias	String	Read/Write. An optional alias for this connector end.
AllowDuplicates	Boolean	Read/Write. For multiplicities greater than 1, indicates that duplicate entries are possible.
Cardinality	String	Read/Write. Cardinality associated with this end.
Constraint	String	Read/Write. A constraint that can be applied to this connector end.

Attribute	Type	Notes
Containment	String	Read/Write. Containment type applied to this connector end.
Derived	Boolean	Read/Write. Indicates that the value of this end is derived.
DerivedUnion	Boolean	Read/Write. Indicates the value of this role derived from the union of all roles that subset this.
End	String	Read only. The end this <i>ConnectorEnd</i> object applies to: <i>Client</i> or <i>Supplier</i> .
IsChangeable	String	Read/Write. Flag indicating whether this end is changeable or not. Values: <b>frozen</b> , <b>addOnly</b> or <b>none</b> .
IsNavigable	Boolean	Read/Write. Flag indicating this end is navigable from the other end.
Navigable	String	Read/Write. Indicates whether this role of an association is navigable from the opposite classifier. Three values are valid: <i>Navigable</i> , <i>Non-Navigable</i> and <i>Unspecified</i> .
ObjectType	<a href="#">ObjectType</a> <small>[1677]</small>	Read only. Distinguishes objects referenced through a Dispatch interface.
Ordering	Long	Read/Write. Ordering for this connector end.
OwnedByClassifier	Boolean	Read/Write. Indicates this Association end corresponds to an attribute on the opposite end of the Association.
Qualifier	String	Read/Write. A qualifier that can apply to connector end.
Role	String	Read/Write. The connector end role.
RoleNote	String	Read/Write. Notes associated with the role of this connector end.
RoleType	String	Read/Write. The role type applied to this end of the connector.
Stereotype	String	Read/Write. Sets or gets the stereotype for this connector end.
StereotypeEx	String	Read/Write. All the applied stereotypes of the connector end in a comma-separated list.
TaggedValues	Private	Read only. Collection of <a href="#">RoleTag</a> <small>[1744]</small> objects.
Visibility	String	Read/Write. Scope associated with this connector end. Valid types are: <i>Public</i> , <i>Private</i> , <i>Protected</i> and <i>Package</i> .

### ConnectorEnd Methods

Method	Type	Notes
GetLastError ()	String	Returns a string value describing the most recent error that occurred in relation to this object.  This function is rarely used as an exception is thrown when an error occurs.
Update ()	Boolean	Update the current <i>ConnectorEnd</i> object after modification or appending a new item. If <b>false</b> is returned, check the <i>GetLastError</i> function for more information.

#### 11.2.2.7.4 ConnectorTag

##### public Class

A *ConnectorTag* is a Tagged Value for a connector and is accessed through the Connector *TaggedValues* collection.

Associated table in .EAP file: *t\_connectortag*

##### ConnectorTag Attributes

Attribute	Type	Notes
ConnectorID	Long	Read/Write. The local ID of the associated connector.
Name	String	Read/Write. The tag or name.
Notes	String	Read/Write. Further descriptive notes about this tag. If <b>Value</b> (below) is set to "<memo>", then <b>Notes</b> should contain the actual Tagged Value content.
ObjectType	<a href="#">ObjectType</a> [1677]	Read only. Distinguishes objects referenced through a Dispatch interface.
TagGUID	String	Read/Write. A globally unique ID for this Tagged Value.
TagID	Long	Read only. A local ID to identify the Tagged Value.
Value	String	Read/Write. The value assigned to this tag. This field has a 255 character limit. If the value is greater than 255 characters long, set the value to "<memo>" and insert the body of text in the <b>Notes</b> attribute (above). When reading existing Tagged Values, if <b>Value</b> = "<memo>" then the developer should read the actual body of text from the <b>Notes</b> attribute.

##### ConnectorTag Methods

Method	Type	Notes
GetLastError ()	String	Returns a string value describing the most recent error that occurred in relation to this object. This function is rarely used as an exception is thrown when an error occurs.
Update ()	Boolean	Update the current <i>ConnectorTag</i> object after modification or appending a new item. If <b>false</b> is returned, check the <i>GetLastError</i> function for more information.

#### 11.2.2.7.5 RoleTag

##### public Class

This interface provides access to the association Role Tagged Values. Each connector end has a *RoleTag* collection that can be accessed to add, delete and access the RoleTags.

In code you create something that resembles the following (where *con* is a Connector Object):

Code fragment for accessing a RoleTag in VB.NET:

```
client = con.ClientEnd
client.Role = "m_client"
client.Update()
tag = client.TaggedValues.AddNew("tag", "value")
tag.Update()
```

```

tag = client.TaggedValues.AddNew("tag2", "value2")
tag.Update()
client.TaggedValues.Refresh()
For idx = 0 To client.TaggedValues.Count - 1
    tag = client.TaggedValues.GetAt(idx)
    Console.WriteLine(tag.Tag)
    client.TaggedValues.DeleteAt(idx, False)
Next
tag = Nothing

```

### RoleTag Attributes

Attribute	Type	Notes
BaseClass	String	Read/Write. Indicates the role end; set to <b>ASSOCIATION_SOURCE</b> or <b>ASSOCIATION_TARGET</b> .
ElementGUID	String	Read/Write. GUID of the connector with which this role tag is associated.
ObjectType	<a href="#">ObjectType</a> <small>(1677)</small>	Read only. Distinguishes objects referenced through a Dispatch interface.
PropertyGUID	String	Read/Write. A system generated GUID to identify the Tagged Value.
Tag	String	Read/Write. The actual tag name.
Value	String	Read/Write. The value associated with this tag.

### RoleTag Methods

Method	Type	Notes
GetLastError ( )	String	Returns a string value describing the most recent error that occurred in relation to this object.  This function is rarely used as an exception is thrown when an error occurs.
Update ( )	Boolean	Update the RoleTag after changes or on initial creation. If <b>false</b> is returned, check the <i>GetLastError</i> function for more information.

#### 11.2.2.8 Diagram

##### public Package

The *Diagram* package has information on a diagram and on *DiagramObjects* and *DiagramLinks*, which are the instances of elements within a diagram.

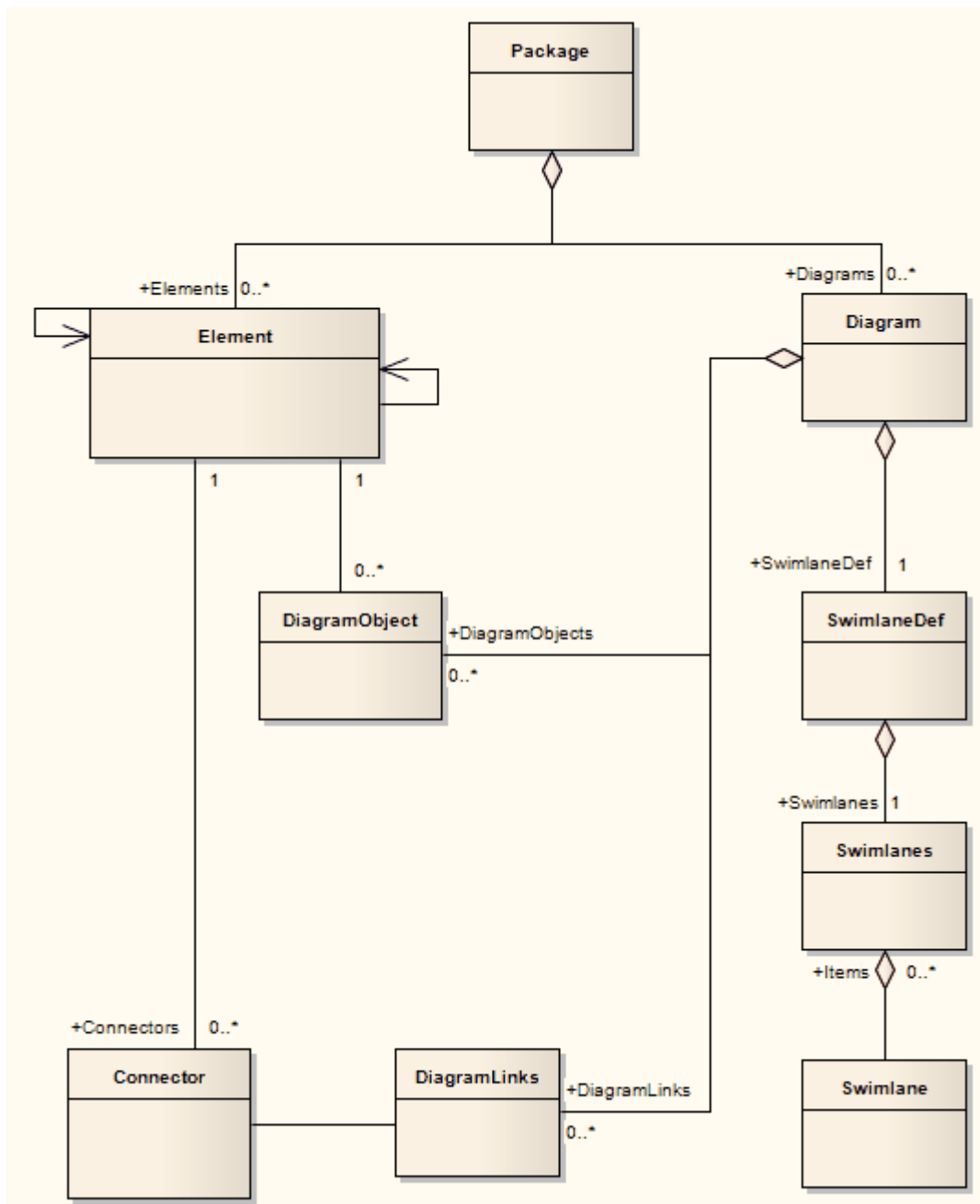

### 11.2.2.8.1 Diagram

#### public Class

A *Diagram* corresponds to a single Enterprise Architect diagram. It is accessed through the *Package Diagrams* collection and in turn contains a collection of diagram objects and diagram connectors. Adding to the *DiagramObjects* collection adds an element to the diagram (the element must already exist). When adding a new diagram, you must set the diagram type to a valid type; these are:

- Activity
- Analysis
- Component
- Custom
- Deployment
- Logical

- Sequence
- Statechart
- Use Case

**Note:**

Use the Analysis type for a Collaboration Diagram.

Associated table in .EAP file: *t\_diagram*

**Diagram Attributes**

Attribute	Type	Notes
Author	String	Read/Write. The author.
CreatedDate	Date	Read/Write. The date the diagram was created.
cx	Long	Read/Write. The X dimension of the diagram (default is 800).
cy	Long	Read/Write. The Y dimension of the diagram (default is 1100).
DiagramGUID	Variant	Read/Write. A globally unique ID for this diagram.
DiagramID	Long	Read only. A local ID for the diagram.
DiagramLinks	<a href="#">Collection</a> <small>[1695]</small>	Read only. A list of <i>DiagramLink</i> objects, each containing information about the display characteristics of a connector in a diagram.  <b>Note:</b> A <i>DiagramLink</i> is only created once a user modifies a connector in a diagram in some way. Until this condition has been met default values are used and the <i>DiagramLink</i> is not in use.
DiagramObjects	<a href="#">Collection</a> <small>[1695]</small>	Read only. A collection of references to <a href="#">DiagramObjects</a> <small>[1750]</small> . A <i>DiagramObject</i> is an instance of an element in a diagram, and includes size and display characteristics.
ExtendedStyle	String	Read/Write. An extended style attribute.
HighlightImports	Boolean	Read/Write. Flag to indicate elements from other packages should be highlighted.
IsLocked	Boolean	Read/Write. Flag indicating whether this diagram is locked or not.
MetaType	String	Read only. The diagram's domain-specific meta type, as defined by an MDG Technology.
ModifiedDate	Variant	Read/Write. The date the diagram was last modified.
Name	String	Read/Write. The diagram name.
Notes	String	Read/Write. Set/retrieve notes for this diagram.
ObjectType	<a href="#">ObjectType</a> <small>[1677]</small>	Read only. Distinguishes objects referenced through a Dispatch interface.
Orientation	String	Read/Write. Page orientation: <b>P</b> for Portrait or <b>L</b> for Landscape.
PackageID	Long	Read/Write. An ID of the package that this diagram belongs to.
ParentID	Long	Read/Write. An optional ID of an element that 'owns' this diagram; for example, a Sequence diagram owned by a Use Case.
Scale	Long	Read/Write. The zoom scale (default is 100).

Attribute	Type	Notes
<b>SelectedConnector</b>	<a href="#">Connector</a> <small>[1739]</small>	Read/Write. The currently selected connector on this diagram. Null if there is no currently selected diagram.
<b>SelectedObjects</b>	<a href="#">Collection</a> <small>[1695]</small>	Read only. Gets a collection representing the currently selected elements on the diagram. Can remove objects from this collection to deselect them, and add elements to the collection by passing the Object ID as a name to select them.
<b>ShowDetails</b>	<i>Long</i>	Read/Write. Flag to indicate Diagram Details text should be shown. <b>1</b> = Show, <b>0</b> = Hide.
<b>ShowPackageContents</b>	<i>Boolean</i>	Read/Write. Flag to indicate package contents should be shown in the current diagram.
<b>ShowPrivate</b>	<i>Boolean</i>	Read/Write. Flag to show or hide Private features.
<b>ShowProtected</b>	<i>Boolean</i>	Read/Write. Flag to show or hide Protected features.
<b>ShowPublic</b>	<i>Boolean</i>	Read/Write. Flag to show or hide Public features.
<b>Stereotype</b>	<i>String</i>	Read/Write. Sets or gets the stereotype for this diagram.
<b>StyleEx</b>	<i>String</i>	Read/Write. Advanced style settings. Reserved for the use of Sparx Systems.
<b>Swimlanes</b>	<i>String</i>	Read/Write. Information on swimlanes contained in the diagram. Please note that this property is superseded by <a href="#">SwimlaneDef</a> <small>[1751]</small> .
<b>SwimlaneDef</b>	<a href="#">SwimlaneDef</a> <small>[1751]</small>	Read/Write. Information on swimlanes contained in the diagram.
<b>Type</b>	<i>String</i>	Read only. The diagram type. See the <i>t_diagramtypes</i> table in the .EAP file for more information.
<b>Version</b>	<i>String</i>	Read/Write. The version of the diagram.

### Diagram Methods

Method	Type	Notes
<b>ApplyGroupLock (string aGroupName)</b>	<i>Boolean</i>	Applies a group lock to this diagram object, for the specified group, on behalf of the current user.  Throws an exception if the operation fails. Use <i>GetLastError()</i> to retrieve error information.  Parameter: <ul style="list-style-type: none"> <li>aGroupName: String - the name of the user group for which to set the group lock.</li> </ul>
<b>ApplyUserLock ()</b>	<i>Boolean</i>	Applies a user lock to this diagram object, for the current user.  Throws an exception if the operation fails. Use <i>GetLastError()</i> to retrieve error information.
<b>GetLastError ()</b>	<i>String</i>	Returns a string value describing the most recent error that occurred in relation to this object.  This function is rarely used as an exception is thrown when an error occurs.
<b>ReleaseUserLock ()</b>	<i>Boolean</i>	Releases a group lock or user lock on this diagram object.  Throws an exception if the operation fails. Use <i>GetLastError()</i> to retrieve error information.



Method	Type	Notes
<b>ReorderMessages ()</b>	<i>Void</i>	Resets the display order of Sequence and Collaboration messages. Typically used after inserting or deleting messages in the diagram.
<b>ShowAsElementList (bool ShowAsList, bool Persist)</b>	<i>Boolean</i>	Toggles the diagram display between diagram format and <b>Element List</b> depending on the value of <i>ShowAsList</i> .  If <i>Persist</i> is set, the display format is written to the database so the diagram always opens in that format (diagram or list). Otherwise, the display format falls back to the default (diagram) once the display is closed.  Parameters: <ul style="list-style-type: none"> <li>ShowAsList: Boolean - indicates diagram or <b>Element List</b></li> <li>Persist: Boolean - indicates set (maintain <i>ShowAsList</i> value) or not (revert to default).</li> </ul>
<b>Update ()</b>	<i>Boolean</i>	Updates this diagram object after modification or appending a new item.  If <b>false</b> is returned, use <i>GetLastError()</i> to retrieve error information.

### 11.2.2.8.2 DiagramLinks

#### public Class

A *DiagramLink* is an object that holds display information about a connector between two elements in a specific diagram. It includes, for example, the custom points and display appearance. Accessed from the Diagram [DiagramLinks](#)<sup>[1747]</sup> collection.

Associated table in .EAP file: *t\_diagramlinks*

#### DiagramLinks Attributes

Attribute	Type	Notes
<b>ConnectorID</b>	<i>Long</i>	Read/Write. The ID of the associated connector.
<b>DiagramID</b>	<i>Long</i>	Read/Write. The local ID for the associated diagram.
<b>Geometry</b>	<i>String</i>	Read/Write. The geometry associated with the current connector in this diagram.
<b>InstanceID</b>	<i>Long</i>	Read only. Holds the connector identifier for the current model.
<b>IsHidden</b>	<i>Boolean</i>	Read/Write. Flag to indicate if this item is hidden or not.
<b>ObjectType</b>	<a href="#">ObjectType</a> <sup>[1677]</sup>	Read only. Distinguishes objects referenced through a Dispatch interface.
<b>Path</b>	<i>String</i>	Read/Write. The path of the connector in this diagram.
<b>Style</b>	<i>String</i>	Read/Write. Additional style information; for example, color, thickness.

#### DiagramLinks Methods

Method	Type	Notes
<b>GetLastError ()</b>	<i>String</i>	Returns a string value describing the most recent error that occurred in relation to this object.  This function is rarely used as an exception is thrown when an error occurs.
<b>Update ()</b>	<i>Boolean</i>	Update the current <i>DiagramLink</i> object after modification or appending a new item.

Method	Type	Notes
		If <b>false</b> is returned, check the <i>GetLastError</i> function for more information.

### 11.2.2.8.3 DiagramObjects

#### public Class

The *DiagramObjects* collection holds a list of element IDs and presentation information that indicates what is displayed in a diagram and how it is shown.

Associated table in .EAP file: *t\_diagramobjects*

#### DiagramObjects Attributes

Attribute	Type	Notes
<b>Bottom</b>	<i>Long</i>	Read/Write. The bottom position of the element.
<b>DiagramID</b>	<i>Long</i>	Read/Write. The ID of the associated diagram (long).
<b>ElementID</b>	<i>Long</i>	Read/Write. The <i>ElementID</i> of the object instance in this diagram.
<b>InstanceID</b>	<i>Long</i>	Read/Write. Read only attribute. Holds the connector identifier for the current model.
<b>Left</b>	<i>Long</i>	Read/Write. The left position of the element.
<b>ObjectType</b>	<a href="#">ObjectType</a> <small>[1677]</small>	Read only. Distinguishes objects referenced through a Dispatch interface.
<b>Right</b>	<i>Long</i>	Read/Write. The right position of the element.
<b>Sequence</b>	<i>Long</i>	Read/Write. The sequence position when loading into diagram (affects Z order). The Z-order is one-based and the lowest value is in the foreground.
<b>Style</b>	<i>Variant</i>	Write only (reading this value gives undefined results). Style information for this object. See <a href="#">Setting the Style</a> <small>[1750]</small> below for more information.
<b>Top</b>	<i>Long</i>	Read/Write. The top position of the element.

#### DiagramObjects Methods

Method	Type	Notes
<b>GetLastError ()</b>	<i>String</i>	Returns a string value describing the most recent error that occurred in relation to this object. This function is rarely used as an exception is thrown when an error occurs.
<b>Update ()</b>	<i>Boolean</i>	Update the current <i>DiagramObject</i> object after modification or appending a new item. If <b>false</b> is returned, check the <i>GetLastError</i> function for more information.

#### Setting The Style

The *Style* attribute is used for setting the appearance of a *DiagramObject*. It is set with a string value in the format:

```
BCol=n;BFol=n;LCol=n;LWth=n;
```

where:

- *BCol* = Background Color
- *BFol* = Font Color
- *LCol* = Line Color
- *LWth* = Line Width

The color value is a decimal representation of the hex RGB value, where Red=FF, Green=FF00 and Blue=FF0000. For example:

```
DiagObj.Style = "BCol=35723;BFol=9342520;LCol=9342520;LWth=1;"
```

The following code snippet shows how you might change the style settings for all of the objects in the current diagram, in this case changing everything to red.

```
For Each aDiagObj In aDiag.DiagramObjects
    aDiagObj.Style = "BCol=255;BFol=9342520;LCol=9342520;LWth=1;"
    aDiagObj.Update
aRepos.ReloadDiagram aDiagObj.DiagramID
Next
```

#### 11.2.2.8.4 SwimlaneDef

A *SwimlaneDef* object makes available attributes relating to a single row or column in a list of swimlanes.

Attribute	Type	Notes
<b>Bold</b>	<i>Boolean</i>	Read/Write. Show the title text in bold.
<b>FontColor</b>	<i>Long</i>	Read/Write. RGB color used to draw the titles.
<b>HideClassifier</b>	<i>Boolean</i>	Read/Write. Removes any classifier from title display.
<b>HideNames</b>	<i>Boolean</i>	Read/Write. Set to true to hide the swimlane titles.
<b>LineColor</b>	<i>Long</i>	Read/Write. RGB color used to draw swimlane borders.
<b>LineWidth</b>	<i>Long</i>	Read/Write. Width of line, in pixels, used to draw swimlanes. Valid values: <b>1</b> , <b>2</b> or <b>3</b> .
<b>Locked</b>	<i>Boolean</i>	Read/Write. If set to true, disables user modification of the swimlanes via the diagram.
<b>ObjectType</b>	<a href="#">ObjectType</a> <small>[1677]</small>	Read only. Distinguishes objects referenced through a Dispatch interface.
<b>Orientation</b>	<i>String</i>	Read/Write. Indication of whether the swimlanes are vertical or horizontal.
<b>ShowInTitleBar</b>	<i>Boolean</i>	Read/Write. Enables vertical swimlane titles to be shown in title bar.
<b>Swimlanes</b>	<a href="#">Swimlanes</a> <small>[1751]</small>	Read/Write. A list of individual swimlanes.

#### 11.2.2.8.5 Swimlanes

A *Swimlanes* object is attached to a diagram's [SwimlaneDef](#)[1751] object and provides a mechanism to access individual swimlanes.

##### Swimlanes Attributes

Attribute	Type	Notes
<b>Count</b>	<i>Long</i>	Read/Write. Gives the number of swimlanes.
<b>ObjectType</b>	<a href="#">ObjectType</a>	Read only. Distinguishes objects referenced through a Dispatch

Attribute	Type	Notes
	<a href="#">Swimlane</a> <sup>[1677]</sup>	interface.

### Swimlanes Methods

Method	Type	Notes
<b>Add (string Title, long Width)</b>	<a href="#">Swimlane</a> <sup>[1752]</sup>	Adds a new swimlane to the end of the list. Returns a swimlane object representing the newly added entry.  Parameters: <ul style="list-style-type: none"> <li>Title: String - The title text that appears at the top of the swimlane. Can be the same as an existing swimlane title.</li> <li>Width: Long - The width of the swimlane in pixels.</li> </ul>
<b>Delete (object Index)</b>	Void	Deletes a selected swimlane.  If the string matches more than one entry, only the first entry is deleted.  Parameter: <ul style="list-style-type: none"> <li>Index: Object - Either a string representing the title text or an integer representing the zero-based index of the swimlane to delete.</li> </ul>
<b>DeleteAll ()</b>	Void	Removes all swimlanes.
<b>Insert (long Index, string Title, long Width)</b>	<a href="#">Swimlane</a> <sup>[1752]</sup>	Inserts a swimlane at a specific position. Returns a swimlane object representing the newly added entry.  Parameters: <ul style="list-style-type: none"> <li>Index: Long - The zero-based index of the existing Swimlane before which this new entry is inserted.</li> <li>Title: String - The title text which appears at the top of the swimlane. Can be the same as an existing swimlane title.</li> <li>Width: Long - The width of the swimlane in pixels.</li> </ul>
<b>Items (object Index)</b>	<a href="#">Swimlane</a> <sup>[1752]</sup> <i>collection</i>	Accesses an individual swimlane.  If the string matches more than one swimlane title, the first matching swimlane is returned.  Parameter: <ul style="list-style-type: none"> <li>Index: Object - Either a string representing the title text or an integer representing the zero-based index of the swimlane to get.</li> </ul>

#### 11.2.2.8.6 Swimlane

A *Swimlane* object makes available attributes relating to a single row or column in a list of [swimlanes](#)<sup>[1751]</sup>.

Attribute	Type	Notes
<b>BackColor</b>	Long	Read/Write. The swimlane is filled with this RGB color.
<b>ClassifiedGuid</b>	String	Read/Write. The GUID of the classifier Class. This can be obtained from the corresponding Element object via the <i>ElementGUID</i> property.
<b>ObjectType</b>	<a href="#">ObjectType</a> <sup>[1677]</sup>	Read only. Distinguishes objects referenced through a Dispatch interface.
<b>Title</b>	String	Read/Write. Text at the head of the swimlane.
<b>Width</b>	Long	Read/Write. The width of the swimlane in pixels.

### 11.2.2.9 Project Interface

#### public Package

The *Enterprise Architect.Project* interface. This is the XML-based interface to Enterprise Architect elements; it also includes some utility functions. You can get a pointer to this interface using the *Repository*. *GetProjectInterface* method.

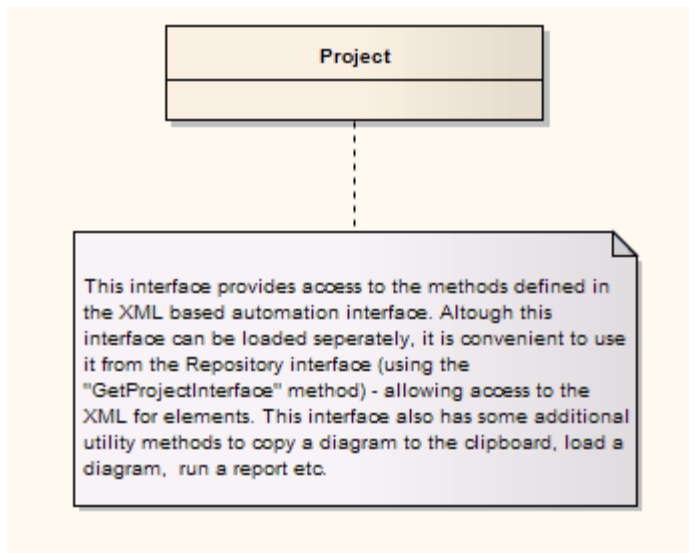

#### 11.2.2.9.1 Project

#### public Class

The Project interface can be accessed from the Repository using *GetProjectInterface()*. The returned interface provides access to the XML-based Enterprise Architect Automation Interface. Use this interface to get XML for the various internal elements and to run some utility functions to perform tasks such as load diagrams or run reports.

#### Note:

These methods all require input GUIDs in XML format; use [GUIDtoXML](#) <sup>[1760]</sup> to change the Enterprise Architect GUID to an XML GUID.

#### Project Attributes

Attribute	Type	Notes
ObjectType	<a href="#">ObjectType</a> <sup>[1677]</sup>	Read only. Distinguishes objects referenced through a Dispatch interface.

#### Project Methods

Method	Type	Notes
<b>CreateBaseline</b> (string PackageGUID, string Version, string Notes)	<i>Boolean</i>	Creates a Baseline of a specified package. Parameters: <ul style="list-style-type: none"> <li>PackageGUID: String - the GUID (in XML format) of the package to Baseline.</li> <li>Version: String - the version of the Baseline.</li> <li>Notes: String - any notes concerning the Baseline.</li> </ul>

Method	Type	Notes
<b>CreateBaselineEx</b> (string PackageGUID, string Version, string Notes, EA.CreateBaselineFlag Flags)	<i>Boolean</i>	Creates a Baseline of a specified package, with a flag to <a href="#">exclude package contents</a> <sup>[282]</sup> below the first level.  Parameters: <ul style="list-style-type: none"> <li>PackageGUID: String - the GUID (in XML format) of the package to Baseline.</li> <li>Version: String - the version of the Baseline.</li> <li>Notes: String - any notes concerning the Baseline.</li> <li>Flags: EA.<a href="#">CreateBaselineFlag</a> <sup>[1676]</sup> - whether or not to exclude package contents below the first level</li> </ul>
<b>DefineRule</b> (string CategoryID, EA.EnumMVErrorType ErrorType, string ErrorMessage)	<i>String</i>	Defines the individual rules that can be performed during model validation. It must be called once for each rule from the <a href="#">EA_OnInitializeUserRules</a> <sup>[1812]</sup> broadcast handler.  The return value is a <i>RuleId</i> , which can be used for reference purposes when an individual rule is executed by Enterprise Architect during model validation.  See <a href="#">Model Validation Example</a> <sup>[1816]</sup> for a detailed example of use of this method.  Parameters: <ul style="list-style-type: none"> <li>CategoryId: String - should be passed the return value from the <a href="#">DefineRuleCategory</a> <sup>[1754]</sup> method.</li> <li>ErrorType: EA.EnumMVErrorType - depending on the severity of the error being validated, can be: <ul style="list-style-type: none"> <li><b>mvErrorCritical</b></li> <li><b>mvError</b></li> <li><b>mvWarning</b>, or</li> <li><b>mvInformation</b>.</li> </ul> </li> <li>ErrorMessage: String - can contain a default error string, although this is probably overridden by the <a href="#">PublishResult</a> <sup>[1763]</sup> call.</li> </ul>
<b>DefineRuleCategory</b> (string CategoryName)	<i>String</i>	Defines a category of rules that can be performed during model validation (there is typically one category per Add-In). It must be called once from the <a href="#">EA_OnInitializeUserRules</a> <sup>[1812]</sup> broadcast handler.  The return value is a <i>CategoryId</i> that must to be passed to the <a href="#">DefineRule</a> <sup>[1754]</sup> method.  See <a href="#">Model Validation Example</a> <sup>[1816]</sup> for a detailed example of use of this method.  Parameters: <ul style="list-style-type: none"> <li>CategoryName: String - a text string that is visible in the <b>Model Validation Configuration</b> dialog.</li> </ul>
<b>DeleteBaseline</b> (string BaselineGUID)	<i>Boolean</i>	Deletes a Baseline, identified by the BaselineGUID, from the repository.  Parameters: <ul style="list-style-type: none"> <li>BaselineGUID: String - the GUID (in XML format) of the Baseline to delete.</li> </ul>
<b>DoBaselineCompare</b> (string PackageGUID, string	<i>String</i>	Performs a Baseline comparison using the supplied package GUID and Baseline GUID (obtained in the

Method	Type	Notes
<b>Baseline, string ConnectString )</b>		<p>result list from <a href="#">GetBaselines</a><sup>[1758]</sup>).</p> <p>Optionally you can include the connection string required to find the Baseline if it exists in a different model file.</p> <p>This method returns a log file of the status of all elements found and compared in the difference procedure. You can use this log information as input to <a href="#">DoBaselineMerge</a><sup>[1755]</sup> - automatically merging information from the Baseline.</p> <p>Parameters:</p> <ul style="list-style-type: none"> <li>PackageGUID: String - the GUID (in XML format) of the package to run the comparison on.</li> <li>Baseline: String - the GUID (in XML format) of the Baseline to run the comparison on.</li> <li>ConnectionString: String - the location of the external .EAP file or DBMS to extract the Baseline from.</li> </ul>
<b>DoBaselineMerge (string PackageGUID, string Baseline, string MergeInstructions, string ConnectString)</b>	<i>String</i>	<p>Performs a batch merge based on instructions contained in an XML file (<i>MergeInstructions</i>). You can supply an optional connection string if the Baseline is located in another model.</p> <p>In the <i>MergeInstructions</i> file, each <i>MergeItem</i> node supplies the GUID of a differenced item from the XML difference log. As the merge is uni-directional and actioned in only one possible way, no additional arguments are required. Enterprise Architect chooses the correct procedure based on the Difference results.</p> <pre>&lt;Merge&gt;   &lt;MergeItem guid="{XXXXXX}" /&gt;   &lt;MergeItem guid="{XXXXXX}" /&gt; &lt;/Merge&gt;</pre> <p>Alternatively, you can supply a single <i>MergeItem</i> with a GUID of <i>RestoreAll</i>. In this case, Enterprise Architect batch-processes ALL differences.</p> <pre>&lt;Merge&gt;   &lt;MergeItem guid="RestoreAll" /&gt; &lt;/Merge&gt;</pre> <p>Parameters:</p> <ul style="list-style-type: none"> <li>PackageGUID: String - the GUID (in XML format) of the package to merge the Baseline into.</li> <li>Baseline: String - the GUID of the Baseline (in XML format) to merge into the package.</li> <li>MergeInstructions: String - the file containing the GUID of each differenced item from the XML difference log returned by <a href="#">DoBaselineCompare</a><sup>[1754]</sup>.</li> <li>ConnectionString: String - the location of the EAP file or DBMS to get the Baseline from, if not in the same model as the package.</li> </ul>
<b>EnumDiagramElements (string DiagramGUID)</b>	protected abstract: <i>String</i>	<p>Gets an XML list of all elements in a diagram.</p> <p>Parameters:</p> <ul style="list-style-type: none"> <li>DiagramGUID: String - the GUID (in XML format) of the diagram to get elements for.</li> </ul>

Method	Type	Notes
<b>EnumDiagrams (string PackageGUID)</b>	protected abstract: <i>String</i>	Gets an XML list of all diagrams in a specified package.  Parameters: <ul style="list-style-type: none"> <li>PackageGUID: String - the GUID (in XML format) of the package to list diagrams for.</li> </ul>
<b>EnumElements (string PackageGUID)</b>	protected abstract: <i>String</i>	Gets an XML list of elements in a specified package.  Parameters: <ul style="list-style-type: none"> <li>PackageGUID: String - the GUID (in XML format) of the package to get a list of elements for.</li> </ul>
<b>EnumLinks (string ElementGUID)</b>	protected abstract: <i>String</i>	Gets an XML list of connectors for a specified element.  Parameters: <ul style="list-style-type: none"> <li>ElementGUID: String - the GUID (in XML format) of the element to get all associated connectors for.</li> </ul>
<b>EnumPackages (string PackageGUID)</b>	protected abstract: <i>String</i>	Gets an XML list of child packages inside a parent package.  Parameters: <ul style="list-style-type: none"> <li>PackageGUID: String - the GUID (in XML format) of the parent package.</li> </ul>
<b>EnumProjects ()</b>	protected abstract: <i>String</i>	Gets a list of projects in the current file; corresponds to <a href="#">Models</a> <sup>[1682]</sup> in <i>Repository</i> .
<b>EnumViews ()</b>	protected abstract: <i>String</i>	Enumerates the Views for a project. Returned as an XML document.
<b>EnumViewEx (string ProjectGUID)</b>	protected abstract: <i>String</i>	Gets a list of Views in the current project.  Parameters: <ul style="list-style-type: none"> <li>ProjectGUID: String - the GUID (in XML format) of the project to get views for.</li> </ul>
<b>Exit ()</b>	protected abstract: <i>String</i>	Exits the current instance of Enterprise Architect; this function is maintained for backward compatibility and should never be called.  Enterprise Architect automatically exits when you are no longer using any of the provided objects.
<b>ExportPackageXML (string PackageGUID, enumXMIMType XMIMType, long DiagramXML, long DiagramImage, long FormatXML, long UseDTD, string FileName)</b>	protected abstract: <i>String</i>	Exports XML for a specified package.  Parameters: <ul style="list-style-type: none"> <li>PackageGUID: String - the GUID (in XML format) of the package to be exported.</li> <li>XMIMType: EnumXMIMType - specifies the XMI type and version information; see <a href="#">XMIMType Enum</a><sup>[1679]</sup> for accepted values.</li> <li>DiagramXML: Long - <b>true</b> if XML for diagrams is required; accepted values:  <b>0</b> = Do not export diagrams  <b>1</b> = Export diagrams  <b>2</b> = Export diagrams along with alternate images.</li> <li>DiagramImage: Long - the format for diagram images to be created at the same time; accepted values:  <b>-1</b>=NONE  <b>0</b>=EMF  <b>1</b>=BMP</li> </ul>



Method	Type	Notes
		<p>2=GIF 3=PNG 4=JPG.</p> <ul style="list-style-type: none"> <li>FormatXML: Long - <b>true</b> if XML output should be formatted prior to saving.</li> <li>UseDTD: Long - <b>true</b> if a DTD should be used.</li> <li>FileName: String - the filename to output to.</li> </ul>
<b>ExportPackageXMEx (string PackageGUID, enumXMType XMType, long DiagramXML, long DiagramImage, long FormatXML, long UseDTD, string FileName, ea. ExportPackageXMIFlag Flags)</b>	protected abstract: <i>String</i>	<p>Exports XML for a specified package, with a flag to determine whether the export <a href="#">includes package content</a> <sup>[295]</sup> below the first level.</p> <p>Parameters:</p> <ul style="list-style-type: none"> <li>PackageGUID: String - the GUID (in XML format) of the package to be exported.</li> <li>XMType: EnumXMType - specifies the XMI type and version information; see <a href="#">XMType Enum</a> <sup>[1679]</sup> for accepted values.</li> <li>DiagramXML: Long - <b>true</b> if XML for diagrams is required; accepted values: 0 = Do not export diagrams 1 = Export diagrams 2 = Export diagrams along with alternate images.</li> <li>DiagramImage: Long - the format for diagram images to be created at the same time; accepted values: -1=NONE 0=EMF 1=BMP 2=GIF 3=PNG 4=JPG.</li> <li>FormatXML: Long - <b>true</b> if XML output should be formatted prior to saving.</li> <li>UseDTD: Long - <b>true</b> if a DTD should be used.</li> <li>FileName: String - the filename to output to.</li> <li>Flags: ea.<a href="#">ExportPackageXMIFlag</a> <sup>[1677]</sup> - whether or not to include package content below the first level (currently only supported for <i>xmiEADefault</i>).</li> </ul>
<b>GenerateClass (string ElementGUID, string ExtraOptions)</b>	<i>Boolean</i>	<p>Generates the code for a single Class.</p> <p>Parameters:</p> <ul style="list-style-type: none"> <li>ElementGUID: String - the GUID (in XML format) of the element to generate.</li> <li>ExtraOptions: String - enables extra options to be given to the command; currently unused.</li> </ul>
<b>GenerateDiagramFromScenario (string ElementGUID, EnumScenarioDiagramType DiagramType, long OverwriteExistingDiagram)</b>	<i>Boolean</i>	<p>Generates various diagrams from the Structured Specification of an element.</p> <p>Parameters:</p> <ul style="list-style-type: none"> <li>ElementGUID: String - the GUID (in XML format) of the element containing the Structured Specification.</li> <li>DiagramType: EnumScenarioDiagramType - the type of diagram to generate; see <a href="#">ScenarioDiagramType Enum</a> <sup>[1678]</sup> for accepted values</li> <li>OverwriteExistingDiagram: Long - determines</li> </ul>

Method	Type	Notes
		<p>whether to overwrite the existing diagram or synchronize the existing elements with the scenario steps</p> <p><b>0</b> = Delete existing diagram and elements, and create new diagram and elements</p> <p><b>1</b> = Synchronize existing elements with scenario steps and preserve diagram layout</p> <p><b>2</b> = Synchronize existing elements with scenario steps and re-cast diagram layout</p> <p><b>3</b> = Do not generate diagram if one already exists.</p>
<b>GeneratePackage</b> (string Package GUID, string ExtraOptions)	<i>Boolean</i>	<p>Generates the code for all Classes within a package.</p> <p>For example: recurse=1;overwrite=1;dir=C:\</p> <p>Parameters:</p> <ul style="list-style-type: none"> <li>PackageGUID: String - the GUID (in XML format) of the package to generate.</li> <li>ExtraOptions: String - enables extra options to be given to the command; currently enables: <ul style="list-style-type: none"> <li>Generation of all subpackages (<i>recurse</i>)</li> <li>Force overwrite of all files (<i>overwrite</i>) and</li> <li>Specification to auto generate all paths (<i>dir</i>).</li> </ul> </li> </ul>
<b>GenerateTestFromScenario</b> (string ElementGUID, EnumScenarioTestType TestType)	<i>Boolean</i>	<p>Generates either an <a href="#">Internal test</a> or an <a href="#">External test</a> <sup>[505]</sup> from the Structured Specification of an element.</p> <p>Parameters:</p> <ul style="list-style-type: none"> <li>ElementGUID: String - the GUID (in XML format) of the element containing the Structured Specification.</li> <li>TestType: EnumScenarioTestType - the type of test to generate; see <a href="#">ScenarioTestType Enum</a> <sup>[1679]</sup> for accepted values.</li> </ul>
<b>GenerateXSD</b> (string PackageGUID, string FileName, string Encoding, string Options)	<i>Boolean</i>	<p>Creates an XML schema for this GenerateXSD. Returns <b>true</b> on success.</p> <p>Parameters:</p> <ul style="list-style-type: none"> <li>PackageGUID: String - the GUID (in XML format) of the package.</li> <li>FileName: String - target filepath.</li> <li>Encoding: String - the XML encoding for the code page instruction.</li> <li>Options: String - enables extra options to be given to the command; currently enables: <ul style="list-style-type: none"> <li><i>GenGlobalElement</i> - turn the generation of global elements for all global <i>ComplexTypes</i> <b>On</b> or <b>Off</b>; for example: - GenGlobalElement=1.</li> </ul> </li> </ul>
<b>GetBaselines</b> (string PackageGUID, string ConnectString)	<i>String</i>	<p>Returns a list (in XML format) of Baselines associated with the supplied package GUID. Optionally, you can provide a connection string to get Baselines from the same package, but located in a different model file (or DBMS).</p> <p>Parameters:</p> <ul style="list-style-type: none"> <li>PackageGUID: String - the GUID (in XML format) of the package to get Baselines for.</li> <li>ConnectString: String - the location of the EAP file or DBMS to get the Baselines from, if not in the same model as the package.</li> </ul>

Method	Type	Notes
<b>GetDiagram (string DiagramGUID)</b>	protected abstract: <i>String</i>	Gets diagram details, in XML format. Parameters: <ul style="list-style-type: none"> <li>DiagramGUID: String - the GUID (in XML format) of the diagram to get details for.</li> </ul>
<b>GetElement (string ElementGUID)</b>	protected abstract: <i>String</i>	Gets XML for the specified element. Parameters: <ul style="list-style-type: none"> <li>ElementGUID: String - the GUID (in XML format) of the element to retrieve XML for.</li> </ul>
<b>GetElementConstraints (string ElementGUID)</b>	protected abstract: <i>String</i>	Gets constraints for an element, in XML format. Parameters: <ul style="list-style-type: none"> <li>ElementGUID: String - the GUID (in XML format) of the element.</li> </ul>
<b>GetElementEffort (string ElementGUID)</b>	protected abstract: <i>String</i>	Gets efforts for an element, in XML format. Parameters: <ul style="list-style-type: none"> <li>ElementGUID: String - the GUID (in XML format) of the element.</li> </ul>
<b>GetElementFiles (string ElementGUID)</b>	protected abstract: <i>String</i>	Gets metrics for an element, in XML format. Parameters: <ul style="list-style-type: none"> <li>ElementGUID: String - the GUID (in XML format) of the element.</li> </ul>
<b>GetElementMetrics (string ElementGUID)</b>	protected abstract: <i>String</i>	Gets files for an element, in XML format. Parameters: <ul style="list-style-type: none"> <li>ElementGUID: String - the GUID (in XML format) of the element.</li> </ul>
<b>GetElementProblems (string ElementGUID)</b>	protected abstract: <i>String</i>	Gets a list of issues (problems) associated with an element, in XML format. Parameters: <ul style="list-style-type: none"> <li>ElementGUID: String - the GUID (in XML format) of the element.</li> </ul>
<b>GetElementProperties (string ElementGUID)</b>	protected abstract: <i>String</i>	Gets Tagged values for an element, in XML format. Parameters: <ul style="list-style-type: none"> <li>ElementGUID: String - the GUID (in XML format) of the element.</li> </ul>
<b>GetElementRequirements (string ElementGUID)</b>	protected abstract: <i>String</i>	Gets a list of requirements for an element, in XML format. Parameters: <ul style="list-style-type: none"> <li>ElementGUID: String - the GUID (in XML format) of the element.</li> </ul>
<b>GetElementResources (string ElementGUID)</b>	protected abstract: <i>String</i>	Gets a list of resources for an element, in XML format. Parameters: <ul style="list-style-type: none"> <li>ElementGUID: String - the GUID (in XML format) of the element.</li> </ul>
<b>GetElementRisks (string ElementGUID)</b>	protected abstract: <i>String</i>	Gets a list of risks associated with an element, in XML format. Parameters:

Method	Type	Notes
		<ul style="list-style-type: none"> <li>ElementGUID: String - the GUID (in XML format) of the element.</li> </ul>
<b>GetElementScenarios (string ElementGUID)</b>	protected abstract: <i>String</i>	<p>Gets a list of scenarios for an element, in XML format.</p> <p>Parameters:</p> <ul style="list-style-type: none"> <li>ElementGUID: String - the GUID (in XML format) of the element.</li> </ul>
<b>GetElementTests (string ElementGUID)</b>	protected abstract: <i>String</i>	<p>Gets a list of tests for an element, in XML format.</p> <p>Parameters:</p> <ul style="list-style-type: none"> <li>ElementGUID: String - the GUID (in XML format) of the element.</li> </ul>
<b>GetLastError ()</b>	protected abstract: <i>String</i>	<p>Returns a string value describing the most recent error that occurred in relation to this object.</p> <p>This function is rarely used as an exception is thrown when an error occurs.</p>
<b>GetLink (string LinkGUID)</b>	protected abstract: <i>String</i>	<p>Gets connector details, in XML format.</p> <p>Parameters:</p> <ul style="list-style-type: none"> <li>LinkGUID: String - the GUID (in XML format) of the connector to get details of.</li> </ul>
<b>GUIDtoXML (string GUID)</b>	<i>String</i>	<p>Changes an internal GUID to the form used in XML.</p> <p>Parameters:</p> <ul style="list-style-type: none"> <li>GUID: String - the Enterprise Architect style GUID to convert to XML format.</li> </ul>
<b>ImportDirectory (string PackageGUID, string Language, string DirectoryPath, string ExtraOptions)</b>	<i>Boolean</i>	<p>Imports a source code directory into the model.</p> <p>Parameters:</p> <ul style="list-style-type: none"> <li>PackageGUID: String - the GUID (in XML format) of the package to reverse engineer code into.</li> <li>Language: String - specifies the language of the code to be imported.</li> <li>DirectoryPath: String - specifies the path where the code is found on the computer.</li> <li>ExtraOptions: String - enables extra options to be given to the command; currently enables import of source from all child directories (<i>recurse</i>) - for example: <i>recurse=1</i>.</li> </ul>
<b>ImportFile (string PackageGUID, string Language, string FileName, string ExtraOptions)</b>	<i>Boolean</i>	<p>Imports an individual file or binary module into the model, in a package per namespace style import.</p> <p>Parameters:</p> <ul style="list-style-type: none"> <li>PackageGUID: String - the GUID (in XML format) of the package to reverse engineer code into; this is expected to be a namespace root package.</li> <li>Language: String - specifies the language of the code to be imported.</li> </ul> <p><b>Note:</b></p> <p>Use the value "DNPE" to import a binary module. This imports a .Net assembly or Java .class file, but <b>not</b> a .jar file.</p> <ul style="list-style-type: none"> <li>Filename: String - specifies the path where the code or module is found on the computer.</li> </ul>

Method	Type	Notes
		<ul style="list-style-type: none"> <li>ExtraOptions: String - enables extra options to be given to the command; <b>currently unused</b>.</li> </ul>
<b>ImportPackageXML</b> (string PackageGUID, string Filename, long ImportDiagrams, long StripGUID)	String	<p>Imports an XML file at a point in the tree.</p> <p>Parameters:</p> <ul style="list-style-type: none"> <li>PackageGUID: String - the GUID (in XML format) of the target package to import the XML file into (or overwrite with the XML file).</li> <li>Filename or XMLText: String - the name of the XML file.</li> </ul> <p><b>Note:</b></p> <p>If the String is of type <i>filename</i> it is interpreted as a source file, otherwise the String is imported as XML text.</p> <ul style="list-style-type: none"> <li>ImportDiagrams: Long.</li> <li>StripGUID: Long - boolean value to indicate whether to replace the element UniqueIDs on import; if stripped, then a package could be imported twice into Enterprise Architect, as two different versions.</li> </ul>
<b>LayoutDiagram</b> (string DiagramGUID, long LayoutStyle)	Boolean	<p><b>Deprecated.</b> it is recommended that <i>LayoutDiagramEx</i> is used instead.</p> <p>Calls the function to automatically layout a diagram in hierarchical fashion. It is only recommended for Class and Object diagrams.</p> <p>Parameters:</p> <ul style="list-style-type: none"> <li>DiagramGUID: String - the GUID (in XML format) of the diagram to lay out.</li> <li>LayoutStyle: Long - always ignored.</li> </ul>
<b>LayoutDiagramEx</b> (string DiagramGUID, long LayoutStyle, long Iterations, long LayerSpacing, long ColumnSpacing, boolean SaveToDiagram)	Boolean	<p>Calls the function to automatically layout a diagram in hierarchical fashion. It is only recommended for Class and Object diagrams.</p> <p><i>LayoutStyle</i> accepts the following options (also see <a href="#">ConstLayoutStyles Enum</a><sup>[1675]</sup>):</p> <ul style="list-style-type: none"> <li>Default Options: <ul style="list-style-type: none"> <li>IsDiagramDefault</li> <li>IsProgramDefault.</li> </ul> </li> <li>Cycle Removal Options: <ul style="list-style-type: none"> <li>IsCycleRemoveGreedy</li> <li>IsCycleRemoveDFS.</li> </ul> </li> <li>Layering Options: <ul style="list-style-type: none"> <li>IsLayeringLongestPathSink</li> <li>IsLayeringLongestPathSource</li> <li>IsLayeringOptimalLinkLength.</li> </ul> </li> <li>Initialize Options: <ul style="list-style-type: none"> <li>IsInitializeNaive</li> <li>IsInitializeDFSOut</li> <li>IsInitializeDFSIn.</li> </ul> </li> <li>Crossing Reduction Option: <ul style="list-style-type: none"> <li>IsCrossReduceAggressive.</li> </ul> </li> <li>Layout Options - Direction <ul style="list-style-type: none"> <li>IsLayoutDirectionUp</li> </ul> </li> </ul>

Method	Type	Notes
		<p>IsLayoutDirectionDown IsLayoutDirectionLeft IsLayoutDirectionRight.</p> <p>Parameters:</p> <ul style="list-style-type: none"> <li>• DiagramGUID: String - the GUID (in XML format) of the diagram to lay out.</li> <li>• LayoutStyle: Long - the layout style.</li> <li>• Iterations: Long - the number of layout iterations the Layout process should take to perform cross reduction (Default value = 4).</li> <li>• LayerSpacing: Long - the per-element layer spacing the Layout process shall use (Default value = 20).</li> <li>• ColumnSpacing: Long - the per-element column spacing the Layout process shall use (Default value = 20).</li> <li>• SaveToDiagram: Boolean - specifies whether or not Enterprise Architect should save the supplied layout options as default to the diagram in question.</li> </ul>
<b>LoadControlledPackage (string PackageGUID)</b>	<i>String</i>	<p>Loads a package that has been marked and configured as controlled. The filename details are stored in the package control data.</p> <p>Parameters:</p> <ul style="list-style-type: none"> <li>• PackageGUID: String - the GUID (in XML format) of the package to load.</li> </ul>
<b>LoadDiagram (string DiagramGUID)</b>	protected abstract: <i>Boolean</i>	<p>Loads a diagram by its GUID.</p> <p>Parameter:</p> <ul style="list-style-type: none"> <li>• DiagramGUID: String - the GUID (in XML format) of the diagram to load; if you retrieve the GUID using the Diagram interface, use the <a href="#">GUIDtoXML</a> <small>[1760]</small> function to convert it to XML format.</li> </ul>
<b>LoadProject (string FileName)</b>	protected abstract: <i>Boolean</i>	<p>Loads an Enterprise Architect project file. Do not use this method if you have accessed the Project interface from the Repository, which has already loaded a file.</p> <p>Parameters:</p> <ul style="list-style-type: none"> <li>• FileName: String - the name of the project file to load.</li> </ul>
<b>MigrateToBPMN11 (string GUID, string Type)</b>	<i>Void</i>	<p>Migrates every BPMN 1.0 construct in a package or an element (including elements, attributes, diagrams and connectors) to BPMN 1.1.</p> <p>Parameters</p> <ul style="list-style-type: none"> <li>• GUID: String - the GUID of the package or element for which the contents are to be migrated to BPMN 1.1</li> <li>• Type: String - the type of upgrade, either just to BPMN 1.1 or to BPMN 1.1 and BPEL. Accepted values: <ul style="list-style-type: none"> <li><b>BPMN</b> = migrate to BPMN 1.1</li> <li><b>BPEL</b> = migrate to BPMN 1.1 and update: <ul style="list-style-type: none"> <li>• any diagram with stereotype <i>BPMN</i> to <i>BPEL</i></li> <li>• any element with stereotype</li> </ul> </li> </ul> </li> </ul>

Method	Type	Notes
		<p><i>BusinessProcess</i> to <i>BPELProcess</i>.</p> <p><b>Note:</b></p> <p>Migrating to BPEL is possible only in the Ultimate or Business and Software Engineering editions of Enterprise Architect.</p>
<b>PublishResult</b> (string CategoryID, EA.EnumMVErrorType ErrorType, string ErrorMessage)	String	<p>Returns the results of each rule that can be performed during model validation. It must be called once for each rule from the <a href="#">EA_OnInitializeUserRules</a><sup>[1812]</sup> broadcast handler.</p> <p>The return value is a <i>RuleId</i>, which can be used for reference purposes when an individual rule is executed by Enterprise Architect during model validation.</p> <p>See <a href="#">Model Validation Example</a><sup>[1816]</sup> for a detailed example of use of this method.</p> <p>Parameters:</p> <ul style="list-style-type: none"> <li>CategoryId: String - should be passed the return value from the <a href="#">DefineRuleCategory</a><sup>[1754]</sup> method.</li> <li>ErrorType: EA.EnumMVErrorType - depending on the severity of the error being validated, can be: <ul style="list-style-type: none"> <li><b>mvErrorCritical</b></li> <li><b>mvError</b></li> <li><b>mvWarning</b>, or</li> <li><b>mvInformation</b>.</li> </ul> </li> <li>ErrorMessage: String - contains an error string.</li> </ul>
<b>PutDiagramImageOnClipboard</b> (string DiagramGUID, long Type)	protected abstract: Boolean	<p>Copies an image of the specified diagram to the clipboard.</p> <p>Parameters:</p> <ul style="list-style-type: none"> <li>DiagramGUID: String - the GUID (in XML format) of the diagram to copy.</li> <li>Type: Long - the file type. <ul style="list-style-type: none"> <li>If Type = 0 then it is a metafile</li> <li>If Type = 1 then it is a Device Independent Bitmap.</li> </ul> </li> </ul>
<b>PutDiagramImageToFile</b> (string Diagram GUID, string FileName, long Type)	protected abstract: Boolean	<p>Saves an image of the specified diagram to file.</p> <p>Parameters:</p> <ul style="list-style-type: none"> <li>DiagramGUID: String - the GUID (in XML format) of the diagram to save.</li> <li>FileName: String - the name of the file to save the diagram into.</li> <li>Type: Long - the file type. <ul style="list-style-type: none"> <li>If type = 0 then it is a metafile</li> <li>If type = 1 then it uses the file type from the name extension (that is, .bmp, .jpg, .gif, .png, .tga)</li> </ul> </li> </ul>
<b>ReloadProject</b> ()	protected abstract: Boolean	<p>Reloads the current project. This is a convenient method to refresh the current loaded project (in case of outside changes to the .EAP file).</p>
<b>RunReport</b> (string PackageGUID, string	protected abstract: Void	<p>Runs a named RTF report.</p>

Method	Type	Notes
TemplateName, string Filename)		Parameters: <ul style="list-style-type: none"> <li>PackageGUID: String - the GUID (in XML format) of the package to run the report on.</li> <li>TemplateName: String - the RTF report template to use. If the PackageGUID has a stereotype of <i>MasterDocument</i>, the template is not required.</li> <li>FileName: String - the file name to store the generated report in.</li> </ul>
RunHTMLReport (string PackageGUID, string ExportPath, string ImageFormat, string Style, string Extension)	String	Runs an HTML report (same as <b>Documentation   HTML Documentation</b> when you right-click on a package in the <b>Project Browser</b> ).  Parameters: <ul style="list-style-type: none"> <li>PackageGUID: String - the GUID (in XML format) of the package to run the report on.</li> <li>ExportPath: String - the file name to store the generated report in.</li> <li>ImageFormat: String.</li> <li>Style: String.</li> <li>Extension: String.</li> </ul>
SaveControlledPackage (s tring PackageGUID)	String	Saves a package that has been configured as a controlled package, to XML. Only the package GUID is required, Enterprise Architect picks the rest up from the package control information.  Parameter: <ul style="list-style-type: none"> <li>PackageGUID: String - the GUID (in XML format) of the package to save.</li> </ul>
SaveDiagramImageToFile (s tring Filename)	protected abstract: String	Saves a diagram image of the current diagram to file.  Parameters: <ul style="list-style-type: none"> <li>FileName: String - the filename of the image to save.</li> </ul>
ShowWindow (long Show)	protected abstract: Void	Shows or hides the Enterprise Architect User Interface.  Parameters: <ul style="list-style-type: none"> <li>Show: Long.</li> </ul>
SynchronizeClass (string ElementGUID, string ExtraOptions)	Boolean	Synchronizes a Class with the latest source code.  Parameters: <ul style="list-style-type: none"> <li>ElementGUID: String - the GUID (in XML format) of the element to update from code.</li> <li>ExtraOptions: String - enables extra options to be given to the command; currently unused.</li> </ul>
SynchronizePackage (string PackageGUID, string ExtraOptions)	Boolean	Synchronizes each Class in a package with the latest source code.  Parameters: <ul style="list-style-type: none"> <li>PackageGUID: String - the GUID (in XML format) of the package containing the elements to update from code.</li> <li>ExtraOptions: String - enables extra options to be given to the command; currently enables synchronization of all child packages (children) - for example: <i>children=1</i>.</li> </ul>



Method	Type	Notes
<b>TransformElement (string TransformName, string ElementGUID, string TargetPackage, string ExtraOptions)</b>	<i>Boolean</i>	Transforms an element into a package. Parameters: <ul style="list-style-type: none"> <li>TransformName: String - specifies the transformation that should be executed.</li> <li>ElementGUID: String - the GUID (in XML format) of the element to transform.</li> <li>TargetPackageGUID: String - the GUID (in XML format) of the package to transform into.</li> <li>ExtraOptions: String - enables extra options to be given to the command; currently unused.</li> </ul>
<b>TransformPackage (string TransformName, string SourcePackage, string TargetPackage, string ExtraOptions)</b>	<i>Boolean</i>	Runs a transformation on the contents of a package. Parameters: <ul style="list-style-type: none"> <li>TransformName: String - specifies the transformation that should be executed.</li> <li>SourcePackageGUID: String - the GUID (in XML format) of the package to transform.</li> <li>TargetPackageGUID: String - the GUID (in XML format) of the package to transform into.</li> <li>ExtraOptions: String - enables extra options to be given to the command; currently unused.</li> </ul>
<b>XMLtoGUID (string GUID)</b>	<i>String</i>	Changes a GUID in XML format to the form used inside Enterprise Architect. Parameters: <ul style="list-style-type: none"> <li>GUID: String - the XML style GUID to convert to Enterprise Architect internal format.</li> </ul>

### 11.2.2.10 Code Samples

This topic contains various code examples indicating how to use the Automation Interface, written in VB.Net:

- [Open the Repository](#) <sup>[1765]</sup>
- [Iterate Through a .EAP File](#) <sup>[1766]</sup>
- [Add and Manage Packages](#) <sup>[1766]</sup>
- [Add and Manage Elements](#) <sup>[1767]</sup>
- [Add a Connector](#) <sup>[1767]</sup>
- [Add and Manage Diagrams](#) <sup>[1768]</sup>
- [Add and Delete Features](#) <sup>[1769]</sup>
- [Element Extras](#) <sup>[1769]</sup>
- [Repository Extras](#) <sup>[1772]</sup>
- [Stereotypes](#) <sup>[1773]</sup>
- [Work with Attributes](#) <sup>[1773]</sup>
- [Work with Methods](#) <sup>[1774]</sup>

#### 11.2.2.10.1 Open the Repository

##### public Object

"An example of how to open an Enterprise Architect repository  
"in VB.Net.

```
Public Class AutomationExample
```

```
    "class level variable for Repository
    Public m_Repository As Object
```

```

Public Sub Run()
  try
    "create the repository object
    m_Repository = CreateObject("EA.Repository")

    "open an EAP file
    m_Repository.OpenFile("F:\Test\EAAuto.EAP")
    "use the Repository in any way required
    'DumpModel

    "close the repository and tidy up
    m_Repository.Exit()
    m_Repository = Nothing

...catch e as exception
  Console.WriteLine(e)
End try
End Sub
end Class

```

### 11.2.2.10.2 Iterate Through a .EAP File

#### public Object

```

"Assume repository has already been opened.

"Start at the model level
Sub DumpModel()
  Dim idx as Integer
  For idx=0 to m_Repository.Models.Count-1
    DumpPackage("",m_Repository.Models.GetAt(idx))
  Next
End Sub

'output package name, then element contents, then process child packages
Sub DumpPackage(Indent as String, Package as Object)
  Dim idx as Integer
  Console.WriteLine(Indent + Package.Name)
  DumpElements(Indent + " ", Package)

  For idx = 0 to Package.Packages.Count-1
    DumpPackage(Indent + " ", Package.Packages.GetAt(idx))
  Next
End Sub

"dump element name
Sub DumpElements(Indent as String, Package as Object)
  Dim idx as Integer
  For idx = 0 to Package.Elements.Count-1
    Console.WriteLine(Indent + "::" + Package.Elements.GetAt(idx).Name)
  Next
End Sub

```

### 11.2.2.10.3 Add and Manage Packages

#### public Object

```

Example illustrating how to add a Model or a Package.

Sub TestPackageLifecycle

  Dim idx as integer
  Dim idx2 as integer
  Dim package as object
  Dim model as object
  Dim o as object

  "first add a new Model

  model = m_Repository.Models.AddNew("AdvancedModel","")
  If not model.Update() Then
    Console.WriteLine(model.GetLastError())
  End If

```

```

"refresh the models collection
m_Repository.Models.Refresh

"now work through models collection and add a package

For idx = 0 to m_Repository.Models.Count -1
  o = m_Repository.Models.GetAt(idx)
  Console.WriteLine(o.Name)
  If o.Name = "AdvancedModel" Then
    package = o.Packages.Addnew("Subpackage","Nothing")
    If not package.Update() Then
      Console.WriteLine(package.GetLastError())
    End If

    package.Element.Stereotype = "system"
    package.Update

    "for testing purposes just delete the
    "newly created Model and its contents
    m_Repository.Models.Delete(idx)

  End If
Next

End Sub

```

#### 11.2.2.10.4 Add and Manage Elements

##### public Object

```

"Add and delete elements in a package.

Sub ElementLifecycle

  Dim package as Object
  Dim element as Object

  package = m_Repository.GetPackageByID(2)
  element = package.elements.AddNew("Login to Website","UseCase")
  element.Stereotype = "testcase"
  element.Update
  package.elements.Refresh()

  Dim idx as integer

  "note the repeated calls to "package.elements.GetAt"
  "in general you should make this call once and assign to a local
  "variable - in the example below, Enterprise Architect loads the element required
  "everytime a call is made - rather than loading once and keeping
  "a local reference

  For idx = 0 to package.elements.count-1
    Console.WriteLine(package.elements.GetAt(idx).Name)
    If (package.elements.GetAt(idx).Name = "Login to Website" and _
      package.elements.GetAt(idx).Type = "UseCase") Then
      package.elements.deleteat(idx, false)
    End If
  Next
End Sub

```

#### 11.2.2.10.5 Add a Connector

##### public Object

```

"Add a connector and set values.

Sub ConnectorTest

  Dim source as object
  Dim target as object
  Dim con as object
  Dim o as object

```

```

Dim client as object
Dim supplier as object

"use ElementID's to quickly load an element in this example
"... you must find suitable ID's in your model

source = m_Repository.GetElementByID(129)
target = m_Repository.GetElementByID(169)

con = source.Connectors.AddNew ("test link 2", "Association")

"again- replace ID with a suitable one from your model
con.SupplierID = 169

If not con.Update Then
    Console.WriteLine(con.GetLastError)
End If
source.Connectors.Refresh

Console.WriteLine("Connector Created")

o = con.Constraints.AddNew ("constraint2","type")
If not o.Update Then
    Console.WriteLine(o.GetLastError)
End If

o = con.TaggedValues.AddNew ("Tag","Value")
If not o.Update Then
    Console.WriteLine(o.GetLastError)
End If

"use the client and supplier ends to set
"additional information

client = con.ClientEnd
client.Visibility = "Private"
client.Role = "m_client"
client.Update
supplier = con.SupplierEnd
supplier.Visibility = "Protected"
supplier.Role = "m_supplier"
supplier.Update

Console.WriteLine("Client and Supplier set")

Console.WriteLine(client.Role)
Console.WriteLine(supplier.Role)

End Sub

```

### 11.2.2.10.6 Add and Manage Diagrams

#### public Object

```

"An example of how to create a diagram and add an element to it.
"Note the optional use of element rectangle setting using
"left,right,top and bottom dimensions in AddNew call.

Sub DiagramLifeCycle

    Dim diagram as object
    Dim v as object
    Dim o as object
    Dim package as object

    Dim idx as Integer
    Dim idx2 as integer

    package = m_Repository.GetPackageByID(5)

    diagram = package.Diagrams.AddNew("Logical Diagram","Logical")
    If not diagram.Update Then
        Console.WriteLine(diagram.GetLastError)
    End If

```

```

diagram.Notes = "Hello there this is a test"
diagram.update()

o = package.Elements.AddNew("ReferenceType","Class")
o.Update

" add element to diagram - supply optional rectangle co-ordinates

v = diagram.DiagramObjects.AddNew("l=200;r=400;t=200;b=600;", "")
v.ElementID = o.ElementID
v.Update

Console.WriteLine(diagram.DiagramID)

End Sub

```

### 11.2.2.10.7 Add and Delete Features

#### public Object

```

Dim element as object
Dim idx as integer
Dim attribute as object
Dim method as object

'just load an element by ID - you must
'substitute a valid ID from your model
element = m_Repository.GetElementByID(246)

"create a new method
method = element.Methods.AddNew("newMethod", "int")
method.Update
element.Methods.Refresh

'now loop through methods for Element - and delete our addition
For idx = 0 to element.Methods.Count-1
    method =element.Methods.GetAt(idx)
    Console.WriteLine(method.Name)
    If(method.Name = "newMethod") Then
        element.Methods.Delete(idx)
    End if
Next

'create an attribute
attribute = element.attributes.AddNew("NewAttribute", "int")
attribute.Update
element.attributes.Refresh

'loop through and delete our new attribute
For idx = 0 to element.attributes.Count-1
    attribute =element.attributes.GetAt(idx)
    Console.WriteLine(attribute.Name)
    If(attribute.Name = "NewAttribute") Then
        element.attributes.Delete(idx)
    End If
Next

```

### 11.2.2.10.8 Element Extras

#### public Object

```

"Examples of how to access and use element extras, such as
"scenarios, constraints and requirements.

Sub ElementExtras

    Dim element as object
    Dim o as object
    Dim idx as Integer
    Dim bDel as boolean
    bDel = true

    try

```

```
element = m_Repository.GetElementByID(129)

'manage constraints for an element
'demonstrate addnew and delete
o = element.Constraints.AddNew("Appended","Type")
If not o.Update Then
    Console.WriteLine("Constraint error:" + o.GetLastError())
End if
element.Constraints.Refresh
For idx = 0 to element.Constraints.Count -1
    o = element.Constraints.GetAt(idx)
    Console.WriteLine(o.Name)
    If(o.Name="Appended") Then
        If bDel Then element.Constraints.Delete (idx)
    End if
Next

'efforts
o = element.Efforts.AddNew("Appended","Type")
If not o.Update Then
    Console.WriteLine("Efforts error:" + o.GetLastError())
End if
element.Efforts.Refresh
For idx = 0 to element.Efforts.Count -1
    o = element.Efforts.GetAt(idx)
    Console.WriteLine(o.Name)
    If(o.Name="Appended") Then
        If bDel Then element.Efforts.Delete (idx)
    End if
Next

'Risks
o = element.Risks.AddNew("Appended","Type")
If not o.Update Then
    Console.WriteLine("Risks error:" + o.GetLastError())
End if
element.Risks.Refresh
For idx = 0 to element.Risks.Count -1
    o = element.Risks.GetAt(idx)
    Console.WriteLine(o.Name)
    If(o.Name="Appended") Then
        If bDel Then element.Risks.Delete (idx)
    End if
Next

'Metrics
o = element.Metrics.AddNew("Appended","Change")
If not o.Update Then
    Console.WriteLine("Metrics error:" + o.GetLastError())
End if
element.Metrics.Refresh
For idx = 0 to element.Metrics.Count -1
    o = element.Metrics.GetAt(idx)
    Console.WriteLine(o.Name)
    If(o.Name="Appended") Then
        If bDel Then element.Metrics.Delete (idx)
    End if
Next

'TaggedValues
o = element.TaggedValues.AddNew("Appended","Change")
If not o.Update Then
    Console.WriteLine("TaggedValues error:" + o.GetLastError())
End if
element.TaggedValues.Refresh
For idx = 0 to element.TaggedValues.Count -1
    o = element.TaggedValues.GetAt(idx)
    Console.WriteLine(o.Name)
    If(o.Name="Appended") Then
        If bDel Then element.TaggedValues.Delete (idx)
    End if
Next
```

```
'Scenarios
o = element.Scenarios.AddNew("Appended", "Change")
If not o.Update Then
    Console.WriteLine("Scenarios error:" + o.GetLastError())
End if
element.Scenarios.Refresh
For idx = 0 to element.Scenarios.Count -1
    o = element.Scenarios.GetAt(idx)
    Console.WriteLine(o.Name)
    If(o.Name="Appended") Then
        If bDel Then element.Scenarios.Delete (idx)
    End if
Next

'Files
o = element.Files.AddNew("MyFile", "doc")
If not o.Update Then
    Console.WriteLine("Files error:" + o.GetLastError())
End if
element.Files.Refresh
For idx = 0 to element.Files.Count -1
    o = element.Files.GetAt(idx)
    Console.WriteLine(o.Name)
    If(o.Name="MyFile") Then
        If bDel Then element.Files.Delete (idx)
    End if
Next

'Tests
o = element.Tests.AddNew("TestPlan", "Load")
If not o.Update Then
    Console.WriteLine("Tests error:" + o.GetLastError())
End if
element.Tests.Refresh
For idx = 0 to element.Tests.Count -1
    o = element.Tests.GetAt(idx)
    Console.WriteLine(o.Name)
    If(o.Name="TestPlan") Then
        If bDel Then element.Tests.Delete (idx)
    End if
Next

'Defect
o = element.Issues.AddNew("Broken", "Defect")
If not o.Update Then
    Console.WriteLine("Issues error:" + o.GetLastError())
End if
element.Issues.Refresh
For idx = 0 to element.Issues.Count -1
    o = element.Issues.GetAt(idx)
    Console.WriteLine(o.Name)
    If(o.Name="Broken") Then
        If bDel Then element.Issues.Delete (idx)
    End if
Next

'Change
o = element.Issues.AddNew("Change", "Change")
If not o.Update Then
    Console.WriteLine("Issues error:" + o.GetLastError())
End if
element.Issues.Refresh
For idx = 0 to element.Issues.Count -1
    o = element.Issues.GetAt(idx)
    Console.WriteLine(o.Name)
    If(o.Name="Change") Then
        If bDel Then element.Issues.Delete (idx)
    End if
Next

catch e as exception
    Console.WriteLine(element.Methods.GetLastError())
    Console.WriteLine(e)
End try

End Sub
```

### 11.2.2.10.9 Repository Extras

#### public Object

```
" Examples of how to access repository
" collections for system level information.

Sub RepositoryExtras

    Dim o as object
    Dim idx as integer

    'issues
    o = m_Repository.Issues.AddNew("Problem","Type")
    If(o.Update=false) Then
        Console.WriteLine (o.GetLastError())
    End if
    o = nothing
    m_Repository.Issues.Refresh
    For idx = 0 to m_Repository.Issues.Count-1
        Console.Writeline(m_Repository.Issues.GetAt(idx).Name)
        If(m_Repository.Issues.GetAt(idx).Name = "Problem") then
            m_Repository.Issues.DeleteAt(idx,false)
            Console.WriteLine("Delete Issues")
        End if
    Next

    'tasks
    o = m_Repository.Tasks.AddNew("Task 1","Task type")
    If(o.Update=false) Then
        Console.WriteLine ("error - " + o.GetLastError())
    End if
    o = nothing
    m_Repository.Tasks.Refresh
    For idx = 0 to m_Repository.Tasks.Count-1
        COnsole.Writeline(m_Repository.Tasks.GetAt(idx).Name)
        If(m_Repository.Tasks.GetAt(idx).Name = "Task 1") then
            m_Repository.Tasks.DeleteAt(idx,false)
            Console.WriteLine("Delete Tasks")
        End if
    Next

    'glossary
    o = m_Repository.Terms.AddNew("Term 1","business")
    If(o.Update=false) Then
        Console.WriteLine ("error - " + o.GetLastError())
    End if
    o = nothing
    m_Repository.Terms.Refresh
    For idx = 0 to m_Repository.Terms.Count-1
        COnsole.Writeline(m_Repository.Terms.GetAt(idx).Term)
        If(m_Repository.Terms.GetAt(idx).Term = "Term 1") then
            m_Repository.Terms.DeleteAt(idx,false)
            Console.WriteLine("Delete Terms")
        End if
    Next

    'authors
    o = m_Repository.Authors.AddNew("Joe B","Writer")
    If(o.Update=false) Then
        Console.WriteLine (o.GetLastError())
    End if
    o = nothing
    m_Repository.Authors.Refresh
    For idx = 0 to m_Repository.authors.Count-1
        COnsole.Writeline(m_Repository.Authors.GetAt(idx).Name)
        If(m_Repository.authors.GetAt(idx).Name = "Joe B") then
            m_Repository.authors.DeleteAt(idx,false)
            Console.WriteLine("Delete Authors")
        End if
    Next

    o = m_Repository.Clients.AddNew("Joe Sphere","Client")
    If(o.Update=false) Then
```



```

    Console.WriteLine (o.GetLastError())
End if
o = nothing
m_Repository.Clients.Refresh
For idx = 0 to m_Repository.Clients.Count-1
    Console.WriteLine(m_Repository.Clients.GetAt(idx).Name)
    If(m_Repository.Clients.GetAt(idx).Name = "Joe Sphere") then
        m_Repository.Clients.DeleteAt(idx,false)
        Console.WriteLine("Delete Clients")
    End if
Next

o = m_Repository.Resources.AddNew("Joe Worker","Resource")
If(o.Update=false) Then
    Console.WriteLine (o.GetLastError())
End if
o = nothing
m_Repository.Resources.Refresh
For idx = 0 to m_Repository.Resources.Count-1
    Console.WriteLine(m_Repository.Resources.GetAt(idx).Name)
    If(m_Repository.Resources.GetAt(idx).Name = "Joe Worker") then
        m_Repository.Resources.DeleteAt(idx,false)
        Console.WriteLine("Delete Resources")
    End if
Next

End Sub

```

### 11.2.2.10.10 Stereotypes

#### public Object

```

Sub TestStereotypes

    Dim o as object
    Dim idx as integer

    "add a new stereotype to the Stereotypes collection
    o = m_Repository.Stereotypes.AddNew("funky","class")
    If(o.Update=false) Then
        Console.WriteLine (o.GetLastError())
    End if
    o = nothing

    "make sure you refresh
    m_Repository.Stereotypes.Refresh

    "then iterate through - deleting our new entry in the process
    For idx = 0 to m_Repository.Stereotypes.Count-1
        Console.WriteLine(m_Repository.Stereotypes.GetAt(idx).Name)
        If(m_Repository.Stereotypes.GetAt(idx).Name = "funky") then
            m_Repository.Stereotypes.DeleteAt(idx,false)
            Console.WriteLine("Delete element")
        End if
    Next

End Sub

```

### 11.2.2.10.11 Work With Attributes

#### public Object

"An example of working with attributes.

```

Sub AttributeLifecycle

    Dim element as object
    Dim o as object
    Dim t as object
    Dim idx as Integer
    Dim idx2 as integer
    try
        element = m_Repository.GetElementByID(129)
    
```

```

For idx = 0 to element.Attributes.Count -1

    Console.WriteLine("attribute=" + element.Attributes.GetAt(idx).Name)

    o = element.Attributes.GetAt(idx)
    t = o.Constraints.AddNew("> 123","Precision")
    t.Update()
    o.Constraints.Refresh
    For idx2 = 0 to o.Constraints.Count-1
        t = o.Constraints.GetAt(idx2)
        Console.WriteLine("Constraint: " + t.Name)
        If(t.Name="> 123") Then
            o.Constraints.DeleteAt(idx2, false)
        End if
    Next

    For idx2 = 0 to o.TaggedValues.Count-1
        t = o.TaggedValues.GetAt(idx2)
        If(t.Name = "Type2") Then
            'Console.WriteLine("deleteing")
            o.TaggedValues.DeleteAt(idx2, true)
        End if
    Next

    t = o.TaggedValues.AddNew("Type2","Number")
    t.Update
    o.TaggedValues.Refresh
    For idx2 = 0 to o.TaggedValues.Count-1
        t = o.TaggedValues.GetAt(idx2)
        Console.WriteLine("Tagged Value: " + t.Name)
    Next

    If(element.Attributes.GetAt(idx).Name = "m_Tootle") Then
        Console.WriteLine("delete attribute")
        element.Attributes.DeleteAt(idx, false)
    End If

Next

catch e as exception
    Console.WriteLine(element.Attributes.GetLastError())
    Console.WriteLine(e)
End try
End Sub

```

### 11.2.2.10.12 Work With Methods

#### public Object

"An example of working with the Methods collection  
"of an element - and with Method collections.

```

Sub MethodLifeCycle

    Dim element as object
    Dim method as object
    Dim t as object
    Dim idx as Integer
    Dim idx2 as integer

    try
        element = m_Repository.GetElementByID(129)

        For idx = 0 to element.Methods.Count -1
            method = element.Methods.GetAt(idx)
            Console.WriteLine(method.Name)

            t = method.PreConditions.AddNew("TestConstraint","something")
            If t.Update = false Then
                Console.WriteLine("PreConditions: " + t.GetLastError)
            End if
        Next
    end try
End Sub

```

```
method.PreConditions.Refresh
For idx2 = 0 to method.PreConditions.Count-1
    t = method.PreConditions.GetAt(idx2)
    Console.WriteLine("PreConditions: " + t.Name)
    If t.Name = "TestConstraint" Then
        method.PreConditions.DeleteAt(idx2,false)
    End If
Next

t = method.PostConditions.AddNew("TestConstraint","something")
If t.Update = false Then
    Console.WriteLine("PostConditions: " + t.GetLastError)
End if

method.PostConditions.Refresh
For idx2 = 0 to method.PostConditions.Count-1
    t = method.PostConditions.GetAt(idx2)
    Console.WriteLine("PostConditions: " + t.Name)
    If t.Name = "TestConstraint" Then
        method.PostConditions.DeleteAt(idx2, false)
    End If
Next

t = method.TaggedValues.AddNew("TestTaggedValue","something")
If t.Update = false Then
    Console.WriteLine("Tagged Values: " + t.GetLastError)
End if

For idx2 = 0 to method.TaggedValues.Count-1
    t = method.TaggedValues.GetAt(idx2)
    Console.WriteLine("Tagged Value: " + t.Name)
    If(t.Name= "TestTaggedValue") Then
        method.TaggedValues.DeleteAt(idx2,false)
    End If
Next

t = method.Parameters.AddNew("TestParam","string")
If t.Update = false Then
    Console.WriteLine("Parameters: " + t.GetLastError)
End if

method.Parameters.Refresh
For idx2 = 0 to method.Parameters.Count-1
    t = method.Parameters.GetAt(idx2)
    Console.WriteLine("Parameter: " + t.Name)
    If(t.Name="TestParam") Then
        method.Parameters.DeleteAt(idx2, false)
    End If
Next

method = nothing
Next
catch e as exception
    Console.WriteLine(element.Methods.GetLastError())
    Console.WriteLine(e)
End try

End Sub
```

## 11.3 Enterprise Architect Add-In Model



### Introduction

Add-Ins enable you to add functionality to Enterprise Architect. The Enterprise Architect Add-In model builds on the features provided by the [Automation Interface](#) <sup>[1668]</sup> to enable you to extend the Enterprise Architect user interface.

Add-Ins are ActiveX COM objects that expose public Dispatch methods. They have several advantages over stand-alone automation clients:

- Add-Ins can define Enterprise Architect menus and sub-menus
- Add-Ins receive notifications about various Enterprise Architect user-interface events including menu clicks and file changes
- Add-Ins can (and should) be written as in-process (DLL) components. This provides lower call overhead and better integration into the Enterprise Architect environment
- Because a current version of Enterprise Architect is already running there is no requirement to start a second copy of Enterprise Architect via the automation interface
- Because the Add-In receives object handles associated with the currently running copy of Enterprise Architect, more information is available about the current user's activity; for example, which diagram objects are selected
- You are not required to do anything other than to install the Add-In to make it usable; that is, you do not have to configure Add-Ins to run on your systems.

Because Enterprise Architect is constantly evolving in response to customer requests, the Add-In interface is flexible:

- The Add-In interface does not have its own version, rather it is identified by the version of Enterprise Architect it first appeared in; for example, the current version of the Enterprise Architect Add-In interface is version 2.1.
- When creating your Add-In, you do not have to subscribe to a type-library.

#### Note:

From Enterprise Architect release 7.0 Add-Ins created before 2004 are no longer supported. If an Add-In subscribes to the *Addn\_Tmpl.tlb* interface (2003 style), it will fail on load. In this event, contact the vendor or author of the Add-In and request an upgrade.

- Add-Ins do not have to implement methods that they never use.
- Add-Ins prompt users via context menus in the tree view and the diagram.
- Menu check and disable states can be controlled by the Add-In.

Add-Ins enhance the existing functionality of Enterprise Architect through a variety of mechanisms such as [Scripts](#) <sup>[1660]</sup>, [UML Profiles](#) <sup>[1093]</sup> and the [Automation Interface](#) <sup>[1666]</sup>. Once an Add-In is [registered](#) <sup>[1876]</sup>, it can be managed using the [Add-In Manager](#) <sup>[1781]</sup>.

### Create and Use Add-Ins

This topic covers the following information on Add-Ins:

- [Add-In Tasks](#) <sup>[1777]</sup>
- [Add-In Events](#) <sup>[1782]</sup>
- [Broadcast Events](#) <sup>[1787]</sup>
- [Custom Views](#) <sup>[1820]</sup>
- [MDG Add-Ins](#) <sup>[1821]</sup>

## 11.3.1 Add-In Tasks

This topic provides instructions on how to create, test, deploy and manage Add-Ins.

1. [Create an Add-In](#) <sup>[1777]</sup>
  - [Define Menu Items](#) <sup>[1777]</sup>
  - [Respond to Menu Events](#) <sup>[1785]</sup>
  - [Handle Add-In Events](#) <sup>[1782]</sup>
2. [Deploy your Add-In](#) <sup>[1778]</sup>
  - [Potential Pitfalls](#) <sup>[1779]</sup>
3. Manage Add-Ins
  - [Register an Add-In](#) <sup>[1876]</sup> (developed in-house or brought-in)
  - [The Add-In Manager](#) <sup>[1781]</sup>

### 11.3.1.1 Create Add-Ins

Before you start you must have an application development tool that is capable of creating ActiveX COM objects supporting the IDispatch interface, such as:

- Borland Delphi
- Microsoft Visual Basic
- Microsoft Visual Studio .Net.

You should consider how to [define menu items](#) <sup>[1777]</sup>. To help with this, you could review some [examples of Automation Interfaces](#) (this web page provides examples of code used to create Add-Ins for Enterprise Architect).

### Create an Add-In

An Enterprise Architect Add-In can be created in four steps:

1. Use a development tool to create an ActiveX COM DLL project. Visual Basic users, for example, choose *File>Create New Project-ActiveX DLL*.
2. Connect to the interface using the syntax appropriate to the language as detailed in the [Connect to the Interface](#) <sup>[1666]</sup> topic.
3. Create a COM Class and implement each of the [general Add-In Events](#) <sup>[1782]</sup> applicable to your Add-In. You only have to define methods for events to respond to.
4. Add a registry key that identifies your Add-In to Enterprise Architect, as described in the [Deploy Add-Ins](#) <sup>[1778]</sup> topic.

#### 11.3.1.1.1 Define Menu Items

Menu items are defined by responding to the *GetMenuItems* event.

The first time this event is called, *MenuName* is an empty string, representing the top-level menu. For a simple Add-In with just a single menu option you can return a string; for example:

```
Function EA_GetMenuItems(Repository as EA.Repository, MenuLocation As String, MenuName As String) As Variant
    EA_GetMenuItems = "&Joe's Add-In"
End Function
```

To define sub-menus, prefix a parent menu with a dash. Parent and sub-items are defined as follows:

```
Function EA_GetMenuItems(Repository as EA.Repository, MenuLocation As String, MenuName As String) As Variant
    Select Case MenuName
        Case ""
            'Parent Menu Item
            EA_GetMenuItems = "-&Joe's Add-In"
        Case "-&Joe's Add-In"
            'Define Sub-Menu Items using the Array notation.
            'In this example, "Diagram" and "Treeview" compose the "Joe's Add-In" sub-menu.
            EA_GetMenuItems = Array("&Diagram", "&Treeview")
        Case Else
            MsgBox "Invalid Menu", vbCritical
    End Select
End Function
```

Similarly, you can define further sub-items:

```
Function EA_GetMenuItems(Repository as EA.Repository, MenuLocation As String, MenuName As String) As Variant
  Select Case MenuName
    Case ""
      EA_GetMenuItems = "-Joe's Add-In"
    Case "-Joe's Add-In"
      EA_GetMenuItems = Array("-&Diagram", "&TreeView")
    Case "-&Diagram"
      EA_GetMenuItems = "&Properties"
    Case Else
      MsgBox "Invalid Menu", vbCritical
  End Select
End Function
```

To enable or disable menu options by default, you can use this method to show particular items to the user:

```
Sub EA_GetMenuState(Repository As EA.Repository, Location As String, MenuName As String, ItemName As String,
  IsEnabled As Boolean, IsChecked As Boolean)
  Select Case Location
    Case "TreeView"
      'Always enable
    Case "Diagram"
      'Always enable
    Case "MainMenu"
      Select Case ItemName
        Case "&Translate", "Save &Project"
          If GetIsProjectSelected() Then
            IsEnabled = False
          End If
        End Select
      End Select
  End Select
  IsChecked = GetIsCurrentSelection()
End Sub
```

### 11.3.1.1.2 Deploy Add-Ins

To deploy Add-Ins to users' sites, follow the steps below:

1. Add the Add-In DLL file to an appropriate directory on the user's computer; that is, C:\Program Files\[new dir].
2. Register the DLL as appropriate to your platform:
  - If compiled as a native Win32 DDL, such as VB6 or C++, register the DDL using the **regsvr32** command from the command prompt; for example:

```
regsvr32 "C:\Program Files\MyCompany\EAAaddin\EAAaddin.dll"
```

- If compiled as a .NET DLL, such as C# or VB.NET, register the DLL using the **RegAsm** command from the command prompt; for example:

```
C:\WINDOWS\Microsoft.NET\Framework\v2.0.50727\RegAsm.exe "C:\Program Files\MyCompany\EAAaddin\EAAaddin.dll" /codebase
```

3. Place a new entry into the registry using the registry editor (run **regedit**) so that Enterprise Architect recognizes the presence of your Add-In.
4. Add a new key value **EAAAddins** under the location: HKEY\_CURRENT\_USER\Software\Sparx Systems

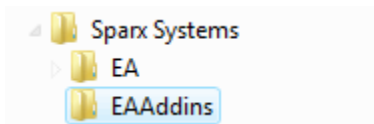

5. Add a new key under this key with the project name.

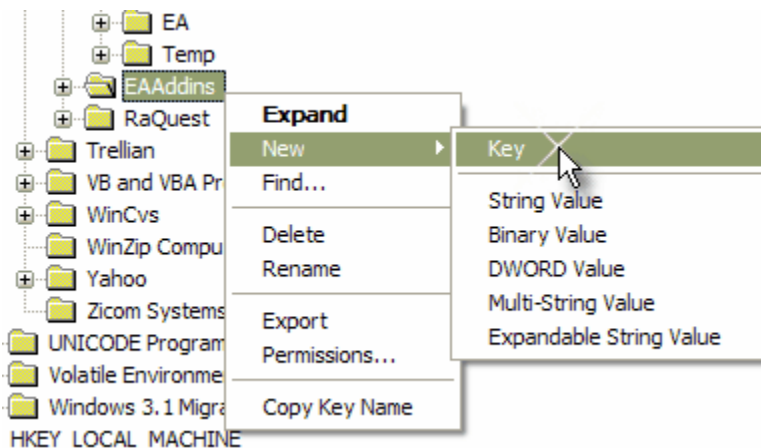
**Note:**

[ProjectName] is not necessarily the name of your DLL, but the name of the Project. In Visual Basic, this is the value for the property **Name** corresponding to the project file.

- Specify the default value by modifying the default value of the key.

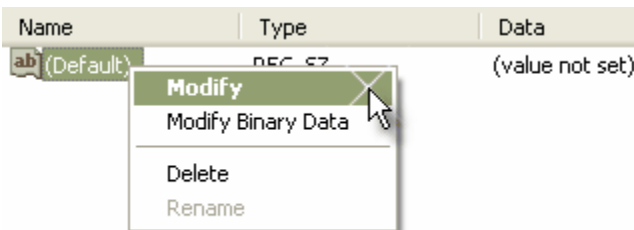

- Enter the value of the key by typing in the [project name].[class name]; for example, EaRequirements.Requirements, where *EaRequirements* is the project name, as shown in the example below.

Value name:

Value data:

OK Cancel

### 11.3.1.1.3 Tricks and Traps

#### Visual Basic 5/6 Users Note

Visual Basic 5/6 users should note that the version number of the Enterprise Architect interface is stored in the VBP project file in a form similar to the following:

```
Reference=*G{64FB2BF4-9EFA-11D2-8307-C45586000000}#2.2#0#..\..\..\Program Files\Sparx Systems\EA\EA.TLB#Enterprise Architect Object Model 2.02
```

If you experience problems moving from one version of Enterprise Architect to another, open the VBP file in a text editor and remove this line. Then open the project in Visual Basic and use *Project-References* to create a new reference to the Enterprise Architect Object model.

#### Add-In Fails to Load

From Enterprise Architect release 7.0, Add-Ins created before 2004 are no longer supported. If an Add-In subscribes to the Addn\_Tmpl.tlb interface (2003 style), it will fail on load. In this event, contact the vendor or author of the Add-In and request an upgrade.

## Holding State Information

It is possible for an Add-In to hold state information, meaning that data can be stored in member variables in response to one event and retrieved in another. There are some dangers in doing this:

- Enterprise Architect Automation Objects do not update themselves in response to user activity, to activity on other workstations, or even to the actions of other objects in the same automation client. Retaining handles to such objects between calls can result in the second event querying objects that have no relationship with the current state of Enterprise Architect.
- When you close Enterprise Architect, all Add-Ins are asked to shut down. If there are any external automation clients Enterprise Architect must stay active, in which case all the Add-Ins are reloaded, losing all the data.
- Enterprise Architect acting as an automation client does not close if an Add-In still holds a reference to it (releasing all references in the Disconnect() event avoids this problem).

It is recommended that unless there is a specific reason for doing so, the Add-In should use the repository parameter and its method and properties to provide the necessary data.

## Enterprise Architect Not Closing

### .Net Specific Issues

Automation checks the use of objects and won't enable any of them to be destroyed until they are no longer being used.

As noted in the [Automation Interface](#) <sup>[1669]</sup> topic, if your automation controller was written using the .NET framework, Enterprise Architect does not close even after you release all your references to it. To force the release of the COM pointers, call the memory management functions as shown below:

```
GC.Collect();
GC.WaitForPendingFinalizers();
```

Additionally, because automation clients hook into Enterprise Architect, which creates Add-Ins which in turn hook back into Enterprise Architect, it is possible to get into a deadlock situation where Enterprise Architect and the Add-Ins won't let go of one another and keep each other active. An Add-In might retain hooks into Enterprise Architect because:

- It keeps a private reference to an Enterprise Architect object (see [Holding State Information](#) <sup>[1780]</sup> above), or
- It has been created by .NET and the GC mechanism hasn't got around to releasing it.

There are two actions required to avoid deadlock situations:

- Automation controllers must call Repository.CloseAddins() at some point (presumably at the end of processing).
- Add-Ins must release all references to Enterprise Architect in the Disconnect() event. See the [Add-In Events](#) <sup>[1782]</sup> topic for details.

It is possible that your Automation client controls a running instance of Enterprise Architect where the Add-Ins have not complied with the rule above. In this case you could call Repository.Exit() to terminate Enterprise Architect.

### Miscellaneous

In developing Add-Ins using the .Net framework you must select COM Interoperability in the project's properties in order for it to be recognized as an Add-In.

Some development environments do not automatically register COM DLLs on creation. You might have to do that manually before Enterprise Architect recognizes the Add-In.

You can use your private Add-In key (as required for Add-In deployment) to store configuration information pertinent to your Add-In.

## Concurrent Calls

In Enterprise Architect releases up to release 7.0, there is a possibility that Enterprise Architect could call two Add-In methods concurrently if the Add-In calls:

- A message box
- A modal dialog
- VB DoEvents, .NET Application DoEvents or the equivalent in other languages.

In such cases, Enterprise Architect could initiate a second Add-In method before the first returns (re-entrancy).



In release 7.0. and subsequent releases, Enterprise Architect cannot make such concurrent calls.

If developing Add-Ins, ensure that the Add-In users are running Enterprise Architect release 7.0 or a later release to avoid any risk of concurrent method calls.

### 11.3.2 The Add-In Manager

You can use the Add-In Manager to view what Add-Ins are available and to disable those not to be used.

Access the [Manage Add-Ins](#) dialog by selecting the **Add-Ins | Manage Add-Ins** menu option.

Available Add-Ins	Status	Load on Startup
DoDAF-MODAF	Enabled	<input checked="" type="checkbox"/>
Zachman Framework	Enabled	<input checked="" type="checkbox"/>

To enable an Add-In for use, select the **Load on Startup** check box. To disable an Add-In, deselect the checkbox.

#### Note:

Enterprise Architect must be restarted for changes to take effect.

### 11.3.3 Add-In Search

Enterprise Architect enables Add-Ins to integrate with the [Model Search](#)<sup>[1231]</sup>. Searches can be defined that execute a method within your Add-In and display your results in an integrated way.

The method that runs the search must be structured in the following way:

*variant <method name> (Rep as Repository, SearchText as String, XMLResults as String)*

Parameter	Description
<b>Rep</b>	The currently open repository.
<b>SearchText</b>	An optional field that you can fill in through the <a href="#">Model Search</a> .
<b>XMLResults</b>	At completion of the method, this should contain the results for the search. The results should be an XML String that conforms to the <a href="#">Search Data Format</a> <sup>[1782]</sup> .

#### Return

The method must return a value for the results to be displayed.

#### Advanced Usage

In addition to the displayed results, two additional hidden fields can be passed into the XML that provide special functionality.

#### CLASSTYPE

Returning a field of CLASSTYPE, containing the Object\_Type value from the t\_object table, displays the appropriate icon in the column you place the field.

#### CLASSGUID

Returning a field of CLASSGUID, containing an ea\_guid value, enables the [Model Search](#) to track the object in

the **Project Browser** and open the **Properties** window for the element by double-clicking in the **Model Search**.

### 11.3.3.1 XML Format (Search Data)

The XML below provides the format for the `sSearchData` parameter of the `RunModelSearch` method. See the [Repository](#) topic for more information.

```
<ReportViewData UID="MySearchID" >
  <!--
    //The UID attribute enables XML type searches to persist column information. That is, if you run the search, group by
    column or adjust column widths, then close the window and run the search again, the format/organization changes are
    retained.To avoid persisting column arrangements, leave the attribute value blank or remove it altogether.
    // Use this section to declare all possible fields - columns that appear in Enterprise Architect's search window - that
    are used below in <Rows>.
    // The order of the columns of information to be appended here must match the order that the search run in
    Enterprise Architect would normally display.
    // Furthermore, if you append results onto a custom SQL Search, then the order used in your Custom SQL must
    match the order used below.
  -->

  <Fields>
    <Field name=""/>
    <Field name=""/>
    <Field name=""/>
    <Field name=""/>
  </Fields>

  <Rows>
    <Row>
      <Field name="" value=""/>
      <Field name="" value=""/>
      <Field name="" value=""/>
      <Field name="" value=""/>
    </Row>
    <Row>
      <Field name="" value=""/>
      <Field name="" value=""/>
      <Field name="" value=""/>
      <Field name="" value=""/>
    </Row>
    <Row>
      <Field name="" value=""/>
      <Field name="" value=""/>
      <Field name="" value=""/>
      <Field name="" value=""/>
    </Row>
  </Rows>
</ReportViewData>
```

### 11.3.4 Add-In Events

All Enterprise Architect Add-Ins can choose to respond to the following general Add-In events:

- [EA\\_Connect](#)<sup>[1782]</sup>
- [EA\\_Disconnect](#)<sup>[1783]</sup>
- [EA\\_GetMenuItems](#)<sup>[1783]</sup>
- [EA\\_MenuClick](#)<sup>[1785]</sup>
- [EA\\_GetMenuState](#)<sup>[1784]</sup>
- [EA\\_ShowHelp](#)<sup>[1787]</sup>
- [EA\\_OnOutputItemClicked](#)<sup>[1785]</sup>
- [EA\\_OnOutputItemDoubleClicked](#)<sup>[1786]</sup>

#### 11.3.4.1 EA\_Connect

##### Details

`EA_Connect` events enable Add-Ins to identify their type and to respond to Enterprise Architect start up.

This event occurs when Enterprise Architect first loads your Add-In. Enterprise Architect itself is loading at this time so that while a Repository object is supplied, there is limited information that you can extract from it.

The chief uses for *EA\_Connect* are in initializing global Add-In data and for identifying the Add-In as an [MDG Add-In](#)<sup>[1821]</sup>.

Also look at [EA\\_Disconnect](#)<sup>[1783]</sup>.

## Syntax

**Function** *EA\_Connect(Repository As EA.Repository) As String*

The *EA\_Connect* function syntax has the following elements:

Parameter	Type	Direction	Description
Repository	<a href="#">EA.Repository</a> <sup>[1680]</sup>	IN	An EA.Repository object representing the currently open Enterprise Architect model. Poll its members to retrieve model data and user interface status information.

## Return Value

String identifying a specialized type of Add-In:

Type	Details
"MDG"	MDG Add-Ins receive <a href="#">MDG Events</a> <sup>[1822]</sup> and extra menu options.
" "	None-specialized Add-In.

### 11.3.4.2 EA\_Disconnect

#### Details

The *EA\_Disconnect* event enables the Add-In to respond to user requests to disconnect the model branch from an external project.

This function is called when the Enterprise Architect closes. If you have stored references to Enterprise Architect objects (not particularly recommended anyway), you must release them here.

In addition, .NET users must call memory management functions as shown below:

```
GC.Collect();
GC.WaitForPendingFinalizers();
```

Also look at [EA\\_Connect](#)<sup>[1782]</sup>.

#### Syntax

**Sub** *EA\_Disconnect()*

#### Return Value

None.

### 11.3.4.3 EA\_GetMenuItems

#### Details

The *EA\_GetMenuItems* event enables the Add-In to provide the Enterprise Architect user interface with additional Add-In menu options in various context and main menus. When a user selects an Add-In menu option, an event is raised and passed back to the Add-In that originally defined that menu option.

This event is raised just before Enterprise Architect has to show particular menu options to the user, and its use is described in the [Define Menu Items](#)<sup>[1777]</sup> topic.

Also look at:

- [EA\\_MenuClick](#)<sup>[1785]</sup>
- [EA\\_GetMenuState](#)<sup>[1784]</sup>

## Syntax

**Function** *EA\_GetMenuItems(Repository As EA.Repository, MenuLocation As String, MenuName As String) As Variant*

The *EA\_GetMenuItems* function syntax has the following elements:

Parameter	Type	Direction	Description
<b>MenuLocation</b>	<i>String</i>		String representing the part of the user interface that brought up the menu. Can be <i>TreeView</i> , <i>MainMenu</i> or <i>Diagram</i> .
<b>MenuName</b>	<i>String</i>		The name of the parent menu for which sub-items are to be defined. In the case of the top-level menu it is an empty string.
<b>Repository</b>	<a href="#">EA.Repository</a> <small>[1680]</small>	IN	An EA.Repository object representing the currently open Enterprise Architect model. Poll its members to retrieve model data and user interface status information.

## Return Value

One of the following types:

- A string indicating the label for a single menu option.
- An array of strings indicating a multiple menu options.
- Empty (Visual Basic/VB.NET) or null (C#) to indicate that no menu should be displayed.

In the case of the top-level menu it should be a single string or an array containing only one item, or Empty/null.

### 11.3.4.4 EA\_GetMenuState

#### Details

The *EA\_GetMenuState* event enables the Add-In to set a particular menu option to either enabled or disabled. This is useful when dealing with locked packages and other situations where it is convenient to show a menu option, but not enable it for use.

This event is raised just before Enterprise Architect has to show particular menu options to the user. Its use is described in the [Define Menu Items](#)[1777] topic.

Also look at [EA\\_GetMenuItems](#)[1783].

#### Syntax

**Sub** *EA\_GetMenuState(Repository as EA.Repository, MenuLocation As String, MenuName as String, ItemName as String, IsEnabled as Boolean, IsChecked as Boolean)*

The *EA\_GetMenuState* function syntax has the following elements:

Parameter	Type	Direction	Description
<b>IsChecked</b>	<i>Boolean</i>		Boolean. Set to <b>True</b> to check this particular menu option.
<b>IsEnabled</b>	<i>Boolean</i>		Boolean. Set to <b>False</b> to disable this particular menu option.
<b>ItemName</b>	<i>String</i>		The name of the option actually clicked, for example, <i>Create a New Invoice</i> .
<b>MenuLocation</b>	<i>String</i>		String representing the part of the user interface that brought up the menu. Can be <i>TreeView</i> , <i>MainMenu</i> or <i>Diagram</i> .
<b>MenuName</b>	<i>String</i>		The name of the parent menu for which sub-items must be defined. In the case of the top-level menu it is an empty string.

Parameter	Type	Direction	Description
Repository	<a href="#">EA.Repository</a> <small>[1680]</small>	IN	An <i>EA.Repository</i> object representing the currently open Enterprise Architect model. Poll its members to retrieve model data and user interface status information.

#### Return Value

None.

### 11.3.4.5 EA\_MenuClick

#### Details

*EA\_MenuClick* events are received by an Add-In in response to user selection of a menu option.

The event is raised when the user clicks on a particular menu option. When a user clicks on one of your non-parent menu options, your Add-In receives a *MenuClick* event, defined as follows:

```
Sub EA_MenuClick(Repository As EA.Repository, ByVal MenuName As String, ByVal ItemName As String)
```

The code below illustrates an example of use:

```
If MenuName = "-&Diagram" And ItemName = "&Properties" then
    MsgBox Repository.GetCurrentDiagram.Name, vbInformation
Else
    MsgBox "Not Implemented", vbCritical
End If
```

Notice that your code can directly access Enterprise Architect data and UI elements using [Repository](#)[1680] methods.

Also look at [EA\\_GetMenuItems](#)[1783].

#### Syntax

**Sub EA\_MenuClick(Repository As EA.Repository, MenuLocation As String, MenuName As String, ItemName As String)**

The *EA\_GetMenuClick* function syntax has the following elements:

Parameter	Type	Direction	Description
ItemName	<i>String</i>		The name of the option actually clicked, for example, <i>Create a New Invoice</i> .
MenuName	<i>String</i>		The name of the parent menu for which sub-items are to be defined. In the case of the top-level menu it is an empty string.
Repository	<a href="#">EA.Repository</a> <small>[1680]</small>	IN	An <i>EA.Repository</i> object representing the currently open Enterprise Architect model. Poll its members to retrieve model data and user interface status information.

#### Return Value

None.

### 11.3.4.6 EA\_OnOutputItemClicked

#### Details

*EA\_OnOutputItemClicked* events inform Add-Ins that the user has clicked on a list entry in the system tab or one of the user defined output tabs.

Usually an Add-In responds to this event in order to capture activity on an output tab they had previously created through a call to *Repository.AddTab()*.

Note that every loaded Add-In receives this event for every click on an output tab in Enterprise Architect - irrespective of whether the Add-In created that tab. Add-Ins should therefore check the **TabName** parameter supplied by this event to ensure that they are not responding to other Add-Ins' events.

Also look at [EA\\_OnOutputItemDoubleClicked](#)<sup>[1786]</sup>.

## Syntax

**EA\_OnOutputItemClicked(Repository As EA.Repository, TabName As String, LineText As String, ID As Long)**

The *EA\_OnOutputItemClicked* function syntax has the following elements:

Parameter	Type	Direction	Description
<b>ID</b>	<i>Long</i>	IN	The ID value specified in the original call to <i>Repository.WriteOutput()</i> .
<b>LineText</b>	<i>String</i>	IN	The text that had been supplied as the String parameter in the original call to <i>Repository.WriteOutput()</i> .
<b>Repository</b>	<a href="#">EA.Repository</a> <sup>[1680]</sup>	IN	An <i>EA.Repository</i> object representing the currently open Enterprise Architect model. Poll its members to retrieve model data and user interface status information.
<b>TabName</b>	<i>String</i>	IN	The name of the tab that the click occurred in. Usually this would have been created through <i>Repository.AddTab()</i> .

## Return Value

None.

### 11.3.4.7 EA\_OnOutputItemDoubleClicked

#### Details

*EA\_OnOutputItemDoubleClicked* events informs Add-Ins that the user has used the mouse to double-click on a list entry in one of the user-defined output tabs.

Usually an Add-In responds to this event in order to capture activity on an output tab they had previously created through a call to *Repository.AddTab()*.

Note that every loaded Add-In receives this event for every double-click on an output tab in Enterprise Architect - irrespective of whether the Add-In created that tab. Add-Ins should therefore check the **TabName** parameter supplied by this event to ensure that they are not responding to other Add-Ins' events.

Also look at [EA\\_OnOutputItemClicked](#)<sup>[1785]</sup>.

## Syntax

**EA\_OnOutputItemDoubleClicked(Repository As EA.Repository, TabName As String, LineText As String, ID As Long)**

The *EA\_OnOutputItemClicked* function syntax contains the following elements:

Parameter	Type	Direction	Description
<b>ID</b>	<i>Long</i>	IN	The ID value specified in the original call to <i>Repository.WriteOutput()</i> .
<b>LineText</b>	<i>String</i>	IN	The text that had been supplied as the String parameter in the original call to <i>Repository.WriteOutput()</i> .
<b>Repository</b>	<a href="#">EA.Repository</a> <sup>[1680]</sup>	IN	An <i>EA.Repository</i> object representing the currently open Enterprise Architect model. Poll its members to retrieve model data and user interface status information.

Parameter	Type	Direction	Description
TabName	String	IN	The name of the tab that the click occurred in. Usually this would have been created through <i>Repository.AddTab()</i> .

### Return Value

None.

### 11.3.4.8 EA\_ShowHelp

#### Details

The *EA\_ShowHelp* event enables the Add-In to show a help topic for a particular menu option. When the user has an Add-In menu option selected, pressing **[F1]** can be delegated to the required Help topic by the Add-In and a suitable help message shown.

This event is raised when the user presses **[F1]** on a menu option that is not a parent menu.

Also look at [EA\\_GetMenuItems](#)<sup>[1783]</sup>.

#### Syntax

**Sub EA\_ShowHelp(Repository as EA.Repository, MenuLocation As String, MenuName as String, ItemName as String)**

The *EA\_ShowHelp* function syntax contains the following elements:

Parameter	Type	Direction	Description
ItemName	String		The name of the option actually clicked, for example, <b>Create a New Invoice</b> .
MenuLocation	String		String representing the part of the user interface that brought up the menu. Can be <b>Treeview</b> , <b>MainMenu</b> or <b>Diagram</b> .
MenuName	String		The name of the parent menu for which sub-items are to be defined. In the case of the top-level menu it is an empty string.
Repository	<a href="#">EA.Repository</a> <sup>[1680]</sup>	IN	An <i>EA.Repository</i> object representing the currently open Enterprise Architect model. Poll its members to retrieve model data and user interface status information.

### Return Value

None.

### 11.3.5 Broadcast Events

#### Overview

The following general Broadcast events are sent to all loaded Add-Ins. For an Add-In to receive the event, they must first implement the required automation event interface. If Enterprise Architect detects that the Add-In has the required interface, the event is dispatched to the Add-In.

- [File Open Event](#)<sup>[1788]</sup>
- [File Close Event](#)<sup>[1788]</sup>
- [File New Event](#)<sup>[1789]</sup>
- [Post Open Diagram Event](#)<sup>[1789]</sup>
- [Post Close Diagram Event](#)<sup>[1789]</sup>
- [Pre-Deletion Events](#)<sup>[1790]</sup>
- [Pre-New Events](#)<sup>[1793]</sup>
- [Post-New Events](#)<sup>[1798]</sup>

- [Technology Events](#) <sup>[1803]</sup>
- [Context Item Events](#) <sup>[1807]</sup>
- [Transformation Events](#) <sup>[1803]</sup>
- [Compartment Events](#) <sup>[1809]</sup>
- [Model Validation Broadcasts](#) <sup>[1811]</sup>
- [Retrieve Model Template Event](#) <sup>[1820]</sup>
- [Initialize Technology Event](#) <sup>[1803]</sup>
- [PreExit Instance](#) <sup>[1798]</sup> (not currently used).

[MDG Events](#) <sup>[1822]</sup> add quite a number of additional events, but the Add-In must first have registered as an MDG-style Add-In, rather than as a generic Add-In.

### 11.3.5.1 EA\_FileOpen

#### Details

The *EA\_FileOpen* event enables the Add-In to respond to a *File Open* event. When Enterprise Architect opens a new model file, this event is raised and passed to all Add-Ins implementing this method.

The event occurs when the model being viewed by the Enterprise Architect user changes, for whatever reason (through user interaction or Add-In activity).

Also look at [EA\\_FileClose](#) <sup>[1788]</sup> and [EA\\_FileNew](#) <sup>[1789]</sup>.

#### Syntax

**Sub EA\_FileOpen(Repository As EA.Repository)**

The *EA\_FileOpen* function syntax contains the following elements:

Parameter	Type	Direction	Description
Repository	<a href="#">EA.Repository</a> <sup>[1680]</sup>	IN	An <i>EA.Repository</i> object representing the currently open Enterprise Architect model. Poll its members to retrieve model data and user interface status information.

#### Return Value

None.

### 11.3.5.2 EA\_FileClose

#### Details

The *EA\_FileClose* event enables the Add-In to respond to a *File Close* event. When Enterprise Architect closes an opened Model file, this event is raised and passed to all Add-Ins implementing this method.

This event occurs when the model currently opened within Enterprise Architect is about to be closed (when another model is about to be opened or when Enterprise Architect is about to shutdown).

Also look at [EA\\_FileOpen](#) <sup>[1788]</sup> and [EA\\_FileNew](#) <sup>[1789]</sup>.

#### Syntax

**Sub EA\_FileClose(Repository As EA.Repository)**

The *EA\_FileClose* function syntax contains the following elements:

Parameter	Type	Direction	Description
Repository	<a href="#">EA.Repository</a> <sup>[1680]</sup>	IN	An <i>EA.Repository</i> object representing the Enterprise Architect model about to be closed. Poll its members to retrieve model data and user interface status information.



## Return Value

None.

### 11.3.5.3 EA\_FileNew

#### Details

The *EA\_FileNew* event enables the Add-In to respond to a *File New* event. When Enterprise Architect creates a new model file, this event is raised and passed to all Add-Ins implementing this method.

The event occurs when the model being viewed by the Enterprise Architect user changes, for whatever reason (through user interaction or Add-In activity).

Also look at [EA\\_FileClose](#)<sup>[1788]</sup> and [EA\\_FileOpen](#)<sup>[1788]</sup>.

#### Syntax

**Sub EA\_FileNew(Repository As EA.Repository)**

The *EA\_FileNew* function syntax contains the following elements:

Parameter	Type	Direction	Description
Repository	<a href="#">EA.Repository</a> <sup>[1680]</sup>	IN	An <i>EA.Repository</i> object representing the currently open Enterprise Architect model. Poll its members to retrieve model data and user interface status information.

## Return Value

None.

### 11.3.5.4 EA\_OnPostCloseDiagram

#### Details

*EA\_OnPostCloseDiagram* notifies Add-Ins that a diagram has been closed.

Also look at [EA\\_OnPostOpenDiagram](#)<sup>[1789]</sup>.

#### Syntax

**Function EA\_OnPostCloseDiagram(Repository As EA.Repository, DiagramID As Integer)**

The *EA\_OnPostCloseDiagram* function syntax contains the following elements:

Parameter	Type	Direction	Description
DiagramID	<i>Integer</i>	IN	Contains the Diagram ID of the diagram that was closed.
Repository	<a href="#">EA.Repository</a> <sup>[1680]</sup>	IN	An <i>EA.Repository</i> object representing the Enterprise Architect model about to be closed. Poll its members to retrieve model data and user interface status information.

## Return Value

None.

### 11.3.5.5 EA\_OnPostOpenDiagram

#### Details

*EA\_OnPostOpenDiagram* notifies Add-Ins that a diagram has been opened.

Also look at [EA\\_OnPostCloseDiagram](#)<sup>[1789]</sup>.

## Syntax

**Function** `EA_OnPostOpenDiagram(Repository As EA.Repository, DiagramID As Integer)`

The `EA_OnPostOpenDiagram` function syntax contains the following elements:

Parameter	Type	Direction	Description
DiagramID	<i>Integer</i>	IN	Contains the Diagram ID of the diagram that was opened.
Repository	<a href="#">EA.Repository</a> <small>[1680]</small>	IN	An <i>EA.Repository</i> object representing the currently open Enterprise Architect model. Poll its members to retrieve model data and user interface status information.

## Return Value

None.

### 11.3.5.6 Pre-Deletion Events

Enterprise Architect Add-Ins can respond to requests to delete elements, attributes, methods, connectors, diagrams, packages and technologies using the following broadcast events:

- [EA\\_OnPreDeleteElement](#)<sup>[1790]</sup>
- [EA\\_OnPreDeleteAttribute](#)<sup>[1791]</sup>
- [EA\\_OnPreDeleteMethod](#)<sup>[1791]</sup>
- [EA\\_OnPreDeleteConnector](#)<sup>[1792]</sup>
- [EA\\_OnPreDeleteDiagram](#)<sup>[1792]</sup>
- [EA\\_OnPreDeletePackage](#)<sup>[1793]</sup>
- [EA\\_OnPreDeleteTechnology](#)<sup>[1805]</sup> (*Deprecated*).

#### 11.3.5.6.1 EA\_OnPreDeleteElement

## Details

`EA_OnPreDeleteElement` notifies Add-Ins that an element is to be deleted from the model. It enables Add-Ins to permit or deny deletion of the element.

This event occurs when a user deletes an element from the **Project Browser** or on a diagram. The notification is provided immediately before the element is deleted, so that the Add-In can disable deletion of the element.

## Syntax

**Function** `EA_OnPreDeleteElement(Repository As EA.Repository, Info As EA.EventProperties) As Boolean`

The `EA_OnPreDeleteElement` function syntax contains the following elements:

Parameter	Type	Direction	Description
Info	<a href="#">EA.EventProperties</a> <small>[1697]</small>	IN	Contains the following <i>EventProperty Objects</i> for the element to be deleted: <ul style="list-style-type: none"> <li>• <i>ElementID</i>: A long value corresponding to <i>Element.ElementID</i>.</li> </ul>
Repository	<a href="#">EA.Repository</a> <sup>[1680]</sup>	IN	An <i>EA.Repository</i> object representing the currently open Enterprise Architect model. Poll its members to retrieve model data and user interface status information.

## Return Value

Return **True** to enable deletion of the element from the model. Return **False** to disable deletion of the element.

### 11.3.5.6.2 EA\_OnPreDeleteAttribute

#### Details

*EA\_OnPreDeleteAttribute* notifies Add-Ins that an attribute is to be deleted from the model. It enables Add-Ins to permit or deny deletion of the attribute.

This event occurs when a user attempts to permanently delete an attribute from the **Project Browser**. The notification is provided immediately before the attribute is deleted, so that the Add-In can disable deletion of the attribute.

#### Syntax

**Function** *EA\_OnPreDeleteAttribute*(*Repository* As *EA.Repository*, *Info* As *EA.EventProperties*) As *Boolean*

The *EA\_OnPreDeleteAttribute* function syntax contains the following elements:

Parameter	Type	Direction	Description
Info	<a href="#">EA.EventProperties</a> <small>[1697]</small>	IN	Contains the following <i>EventProperty Objects</i> for the attribute to be deleted: <ul style="list-style-type: none"> <li><i>AttributeID</i>: A long value corresponding to <i>Attribute.AttributeID</i>.</li> </ul>
Repository	<a href="#">EA.Repository</a> <small>[1680]</small>	IN	An <i>EA.Repository</i> object representing the currently open Enterprise Architect model. Poll its members to retrieve model data and user interface status information.

#### Return Value

Return **True** to enable deletion of the attribute from the model. Return **False** to disable deletion of the attribute.

### 11.3.5.6.3 EA\_OnPreDeleteMethod

#### Details

*EA\_OnPreDeleteMethod* notifies Add-Ins that a method (operation) is to be deleted from the model. It enables Add-Ins to permit or deny deletion of the method.

This event occurs when a user attempts to permanently delete a method from the **Project Browser**. The notification is provided immediately before the method is deleted, so that the Add-In can disable deletion of the method.

#### Syntax

**Function** *EA\_OnPreDeleteMethod*(*Repository* As *EA.Repository*, *Info* As *EA.EventProperties*) As *Boolean*

The *EA\_OnPreDeleteMethod* function syntax contains the following elements:

Parameter	Type	Direction	Description
Info	<a href="#">EA.EventProperties</a> <small>[1697]</small>	IN	Contains the following <i>EventProperty Objects</i> for the method to be deleted: <ul style="list-style-type: none"> <li><i>MethodID</i>: A long value corresponding to <i>Method.MethodID</i>.</li> </ul>
Repository	<a href="#">EA.Repository</a> <small>[1680]</small>	IN	An <i>EA.Repository</i> object representing the currently open Enterprise Architect model. Poll its members to retrieve model data and user interface status information.

## Return Value

Return **True** to enable deletion of the method from the model. Return **False** to disable deletion of the method.

### 11.3.5.6.4 EA\_OnPreDeleteConnector

#### Details

*EA\_OnPreDeleteConnector* notifies Add-Ins that a connector is to be deleted from the model. It enables Add-Ins to permit or deny deletion of the connector.

This event occurs when a user attempts to permanently delete a connector on a diagram. The notification is provided immediately before the connector is deleted, so that the Add-In can disable deletion of the connector.

#### Syntax

**Function** *EA\_OnPreDeleteConnector*(*Repository As EA.Repository, Info As EA.EventProperties*) **As Boolean**

The *EA\_OnPreDeleteConnector* function syntax contains the following elements:

Parameter	Type	Direction	Description
Info	<a href="#">EA.EventProperties</a> <small>[1697]</small>	IN	Contains the following <i>EventProperty Objects</i> for the connector to be deleted: <ul style="list-style-type: none"> <li><i>ConnectorID</i>: A long value corresponding to <i>Connector.ConnectorID</i>.</li> </ul>
Repository	<a href="#">EA.Repository</a> <small>[1680]</small>	IN	An <i>EA.Repository</i> object representing the currently open Enterprise Architect model. Poll its members to retrieve model data and user interface status information.

## Return Value

Return **True** to enable deletion of the connector from the model. Return **False** to disable deletion of the connector.

### 11.3.5.6.5 EA\_OnPreDeleteDiagram

#### Details

*EA\_OnPreDeleteDiagram* notifies Add-Ins that a diagram is to be deleted from the model. It enables Add-Ins to permit or deny deletion of the diagram.

This event occurs when a user attempts to permanently delete a diagram from the **Project Browser**. The notification is provided immediately before the diagram is deleted, so that the Add-In can disable deletion of the diagram.

#### Syntax

**Function** *EA\_OnPreDeleteDiagram*(*Repository As EA.Repository, Info As EA.EventProperties*) **As Boolean**

The *EA\_OnPreDeleteDiagram* function syntax contains the following elements:

Parameter	Type	Direction	Description
Info	<a href="#">EA.EventProperties</a> <small>[1697]</small>	IN	Contains the following <i>EventProperty Objects</i> for the connector to be deleted: <ul style="list-style-type: none"> <li><i>DiagramID</i>: A long value corresponding to <i>Diagram.DiagramID</i>.</li> </ul>
Repository	<a href="#">EA.Repository</a> <small>[1680]</small>	IN	An <i>EA.Repository</i> object representing the currently-open Enterprise Architect model. Poll its members to retrieve model

Parameter	Type	Direction	Description
y			data and user interface status information.

#### Return Value

Return **True** to enable deletion of the diagram from the model. Return **False** to disable deletion of the diagram.

### 11.3.5.6.6 EA\_OnPreDeletePackage

#### Details

*EA\_OnPreDeletePackage* notifies Add-Ins that a package is to be deleted from the model. It enables Add-Ins to permit or deny deletion of the package.

This event occurs when a user attempts to permanently delete a package from the **Project Browser**. The notification is provided immediately before the package is deleted, so that the Add-In can disable deletion of the package.

#### Syntax

**Function** *EA\_OnPreDeletePackage(Repository As EA.Repository, Info As EA.EventProperties) As Boolean*

The *EA\_OnPreDeletePackage* function syntax contains the following elements:

Parameter	Type	Direction	Description
Info	<a href="#">EA.EventProperties</a> <small>1697</small>	IN	Contains the following <i>EventProperty Objects</i> for the connector to be deleted: <ul style="list-style-type: none"> <li><i>PackageID</i>: A long value corresponding to <i>Package.PackageID</i>.</li> </ul>
Repository	<a href="#">EA.Repository</a> <small>1680</small>	IN	An <i>EA.Repository</i> object representing the currently open Enterprise Architect model. Poll its members to retrieve model data and user interface status information.

#### Return Value

Return **True** to enable deletion of the package from the model. Return **False** to disable deletion of the package.

### 11.3.5.7 Pre-New Events

Enterprise Architect Add-Ins can respond to requests to create new elements, connectors, objects, attributes, methods and packages using the following broadcast events:

- [EA\\_OnPreNewElement](#)1793
- [EA\\_OnPreNewConnector](#)1794
- [EA\\_OnPreNewDiagram](#)1795
- [EA\\_OnPreNewDiagramObject](#)1795
- [EA\\_OnPreNewAttribute](#)1796
- [EA\\_OnPreNewMethod](#)1797
- [EA\\_OnPreNewPackage](#)1797.

#### 11.3.5.7.1 EA\_OnPreNewElement

#### Details

*EA\_OnPreNewElement* notifies Add-Ins that a new element is about to be created on a diagram. It enables Add-Ins to permit or deny creation of the new element.

This event occurs when a user drags a new element from the **Toolbox** or **Resources** window onto a diagram. The notification is provided immediately before the element is created, so that the Add-In can disable addition of the element.

Also look at [EA\\_OnPostNewElement](#)<sup>[1798]</sup>.

## Syntax

**Function** EA\_OnPreNewElement(*Repository As EA.Repository, Info As EA.EventProperties*) As **Boolean**

The *EA\_OnPreNewElement* function syntax contains the following elements:

Parameter	Type	Direction	Description
Info	<a href="#">EA.EventProperties</a> <sup>[1697]</sup>	IN	Contains the following <i>EventProperty Objects</i> for the element to be created: <ul style="list-style-type: none"> <li><i>Type</i>: A string value corresponding to <i>Element.Type</i></li> <li><i>Stereotype</i>: A string value corresponding to <i>Element.Stereotype</i></li> <li><i>ParentID</i>: A long value corresponding to <i>Element.ParentID</i></li> <li><i>DiagramID</i>: A long value corresponding to the ID of the diagram to which the element is being added.</li> </ul>
Repository	<a href="#">EA.Repository</a> <sup>[1680]</sup>	IN	An <i>EA.Repository</i> object representing the currently open Enterprise Architect model. Poll its members to retrieve model data and user interface status information.

## Return Value

Return **True** to enable addition of the new element to the model. Return **False** to disable addition of the new element.

### 11.3.5.7.2 EA\_OnPreNewConnector

## Details

*EA\_OnPreNewConnector* notifies Add-Ins that a new connector is about to be created on a diagram. It enables Add-Ins to permit or deny creation of a new connector.

This event occurs when a user drags a new connector from the **Toolbox** or **Resources** window, onto a diagram. The notification is provided immediately before the connector is created, so that the Add-In can disable addition of the connector.

Also look at [EA\\_OnPostNewConnector](#)<sup>[1799]</sup>.

## Syntax

**Function** EA\_OnPreNewConnector(*Repository As EA.Repository, Info As EA.EventProperties*) As **Boolean**

The *EA\_OnPreNewConnector* function syntax contains the following elements:

Parameter	Type	Direction	Description
Info	<a href="#">EA.EventProperties</a> <sup>[1697]</sup>	IN	Contains the following <i>EventProperty Objects</i> for the connector to be created: <ul style="list-style-type: none"> <li><i>Type</i>: A string value corresponding to <i>Connector.Type</i></li> <li><i>Subtype</i>: A string value corresponding to <i>Connector.Subtype</i></li> <li><i>Stereotype</i>: A string value corresponding to <i>Connector.Stereotype</i></li> <li><i>ClientID</i>: A long value corresponding to <i>Connector.ClientID</i></li> </ul>

Parameter	Type	Direction	Description
			<ul style="list-style-type: none"> <li><i>SupplierID</i>: A long value corresponding to <i>Connector.SupplierID</i></li> <li><i>DiagramID</i>: A long value corresponding to <i>Connector.DiagramID</i>.</li> </ul>
Repository	<a href="#">EA.Repository</a> <small>[1680]</small>	IN	An <i>EA.Repository</i> object representing the currently open Enterprise Architect model. Poll its members to retrieve model data and user interface status information.

## Return Value

Return **True** to enable addition of the new connector to the model. Return **False** to disable addition of the new connector.

### 11.3.5.7.3 EA\_OnPreNewDiagram

#### Details

*EA\_OnPreNewDiagram* notifies Add-Ins that a new diagram is about to be created. It enables Add-Ins to permit or deny creation of the new diagram.

The notification is provided immediately before the diagram is created, so that the Add-In can disable addition of the diagram.

Also look at [EA\\_OnPostNewDiagram](#)[1800].

#### Syntax

**Function** *EA\_OnPreNewDiagram*(*Repository As EA.Repository, Info As EA.EventProperties*) **As Boolean**

The *EA\_OnPreNewDiagram* function syntax contains the following elements:

Parameter	Type	Direction	Description
Info	<a href="#">EA.EventProperties</a> <small>[1697]</small>	IN	Contains the following <i>EventProperty Objects</i> for the diagram to be created: <ul style="list-style-type: none"> <li><i>Type</i>: A string value corresponding to <i>Diagram.Type</i></li> <li><i>ParentID</i>: A long value corresponding to <i>Diagram.ParentID</i></li> <li><i>PackageID</i>: A long value corresponding to <i>Diagram.PackageID</i>.</li> </ul>
Repository	<a href="#">EA.Repository</a> <small>[1680]</small>	IN	An <i>EA.Repository</i> object representing the currently open Enterprise Architect model. Poll its members to retrieve model data and user interface status information.

## Return Value

Return **True** to enable addition of the new diagram to the model. Return **False** to disable addition of the new diagram.

### 11.3.5.7.4 EA\_OnPreNewDiagramObject

#### Details

*EA\_OnPreNewDiagramObject* notifies Add-Ins that a new diagram object is about to be dropped on a diagram. It enables Add-Ins to permit or deny creation of the new object.

This event occurs when a user drags an object from the Enterprise Architect **Project Browser** or **Resources** window onto a diagram. The notification is provided immediately before the object is created, so that the Add-In can disable addition of the object.

Also look at [EA\\_OnPostNewDiagramObject](#)[1800].

## Syntax

**Function** `EA_OnPreNewDiagramObject(Repository As EA.Repository, Info As EA.EventProperties) As Boolean`

The `EA_OnPreNewDiagramObject` function syntax contains the following elements:

Parameter	Type	Direction	Description
Info	<a href="#">EA.EventProperties</a> <small>[1697]</small>	IN	Contains the following <i>EventProperty Objects</i> for the object to be created: <ul style="list-style-type: none"> <li><i>Type</i>: A string value corresponding to <i>Object.Type</i></li> <li><i>Stereotype</i>: A string value corresponding to <i>Object.Stereotype</i></li> <li><i>ParentID</i>: A long value corresponding to <i>Object.ParentID</i></li> <li><i>DiagramID</i>: A long value corresponding to the ID of the diagram to which the object is being added.</li> </ul>
Repository	<a href="#">EA.Repository</a> <small>[1680]</small>	IN	An <i>EA.Repository</i> object representing the currently open Enterprise Architect model. Poll its members to retrieve model data and user interface status information.

## Return Value

Return **True** to enable addition of the object to the model. Return **False** to disable addition of the object.

### 11.3.5.7.5 EA\_OnPreNewAttribute

## Details

`EA_OnPreNewAttribute` notifies Add-Ins that a new attribute is about to be created on an element. It enables Add-Ins to permit or deny creation of the new attribute.

This event occurs when a user creates a new attribute on an element by either drag-dropping from the **Project Browser**, using the **Attributes Properties** dialog, or using the in-place editor on the diagram. The notification is provided immediately before the attribute is created, so that the Add-In can disable addition of the attribute.

Also look at [EA\\_OnPostNewAttribute](#)  
[1807].

## Syntax

**Function** `EA_OnPreNewAttribute(Repository As EA.Repository, Info As EA.EventProperties) As Boolean`

The `EA_OnPreNewAttribute` function syntax contains the following elements:

Parameter	Type	Direction	Description
Info	<a href="#">EA.EventProperties</a> <small>[1697]</small>	IN	Contains the following <i>EventProperty Objects</i> for the attribute to be created: <ul style="list-style-type: none"> <li><i>Type</i>: A string value corresponding to <i>Attribute.Type</i></li> <li><i>Stereotype</i>: A string value corresponding to <i>Attribute.Stereotype</i></li> <li><i>ParentID</i>: A long value corresponding to <i>Attribute.ParentID</i></li> <li><i>ClassifierID</i>: A long value corresponding to <i>Attribute.ClassifierID</i>.</li> </ul>
Repository	<a href="#">EA.Repository</a> <small>[1680]</small>	IN	An <i>EA.Repository</i> object representing the currently open Enterprise Architect model. Poll its members to retrieve model data and user interface status information.



## Return Value

Return **True** to enable addition of the new attribute to the model. Return **False** to disable addition of the new attribute.

### 11.3.5.7.6 EA\_OnPreNewMethod

#### Details

*EA\_OnPreNewMethod* notifies Add-Ins that a new method is about to be created on an element. It enables Add-Ins to permit or deny creation of the new method.

This event occurs when a user creates a new method on an element by either drag-dropping from the **Project Browser**, using the method **Properties** dialog, or using the in-place editor on the diagram. The notification is provided immediately before the method is created, so that the Add-In can disable addition of the method.

Also look at [EA\\_OnPostNewMethod](#)<sup>[1801]</sup>.

#### Syntax

**Function** EA\_OnPreNewMethod(*Repository* As EA.Repository, *Info* As EA.EventProperties) As Boolean

The *EA\_OnPreNewMethod* function syntax contains the following elements:

Parameter	Type	Direction	Description
<b>Info</b>	<a href="#">EA.EventProperties</a> <sup>[1697]</sup>	IN	Contains the following <i>EventProperty Objects</i> for the method to be created: <ul style="list-style-type: none"> <li><i>ReturnType</i>: A string value corresponding to <i>Method.ReturnType</i></li> <li><i>Stereotype</i>: A string value corresponding to <i>Method.Stereotype</i></li> <li><i>ParentID</i>: A long value corresponding to <i>Method.ParentID</i></li> <li><i>ClassifierID</i>: A long value corresponding to <i>Method.ClassifierID</i>.</li> </ul>
<b>Repository</b>	<a href="#">EA.Repository</a> <sup>[1680]</sup>	IN	An <i>EA.Repository</i> object representing the currently open Enterprise Architect model. Poll its members to retrieve model data and user interface status information.

## Return Value

Return **True** to enable addition of the new method to the model. Return **False** to disable addition of the new method.

### 11.3.5.7.7 EA\_OnPreNewPackage

#### Details

*EA\_OnPreNewPackage* notifies Add-Ins that a new package is about to be created in the model. It enables Add-Ins to permit or deny creation of the new package.

This event occurs when a user drags a new package from the **Toolbox** or **Resources** window onto a diagram, or by selecting the **New Package** icon from the **Project Browser**. The notification is provided immediately before the package is created, so that the Add-In can disable addition of the package.

Also look at [EA\\_OnPostNewPackage](#)<sup>[1802]</sup>.

#### Syntax

**Function** EA\_OnPreNewPackage(*Repository* As EA.Repository, *Info* As EA.EventProperties) As Boolean

The *EA\_OnPreNewPackage* function syntax contains the following elements:

Parameter	Type	Direction	Description
Info	<a href="#">EA.EventProperties</a> <small>[1697]</small>	IN	Contains the following <i>EventProperty Objects</i> for the package to be created: <ul style="list-style-type: none"> <li>• <i>Stereotype</i>: A string value corresponding to <i>Package.Stereotype</i></li> <li>• <i>ParentID</i>: A long value corresponding to <i>Package.ParentID</i></li> <li>• <i>DiagramID</i>: A long value corresponding to the ID of the diagram to which the package is being added.</li> </ul>
Repository	<a href="#">EA.Repository</a> <small>[1680]</small>	IN	An <i>EA.Repository</i> object representing the currently open Enterprise Architect model. Poll its members to retrieve model data and user interface status information.

### Return Value

Return **True** to enable addition of the new package to the model. Return **False** to disable addition of the new package.

### 11.3.5.8 EA\_OnPreExitInstance

#### Details

*EA\_OnPreExitInstance* is not currently used.

#### Syntax

**Sub EA\_OnPreExitInstance(Repository As EA.Repository)**

The *EA\_OnPreExitInstance* function syntax contains the following element:

Parameter	Type	Direction	Description
Repository	<a href="#">EA.Repository</a> <small>[1680]</small>	IN	An <i>EA.Repository</i> object representing the currently open Enterprise Architect model. Poll its members to retrieve model data and user interface status information.

### Return Value

None.

### 11.3.5.9 Post-New Events

Enterprise Architect Add-Ins can respond to the creation of new elements, connectors, objects, attributes, methods and packages using the following broadcast events:

- [EA\\_OnPostNewElement](#)[1798]
- [EA\\_OnPostNewConnector](#)[1799]
- [EA\\_OnPostNewDiagram](#)[1800]
- [EA\\_OnPostNewDiagramObject](#)[1800]
- [EA\\_OnPostNewAttribute](#)[1801]
- [EA\\_OnPostNewMethod](#)[1801]
- [EA\\_OnPostNewPackage](#)[1802]

#### 11.3.5.9.1 EA\_OnPostNewElement

#### Details

*EA\_OnPostNewElement* notifies Add-Ins that a new element has been created on a diagram. It enables Add-Ins to modify the element upon creation.

This event occurs after a user has dragged a new element from the **Toolbox** or **Resources** window onto a diagram. The notification is provided immediately after the element is added to the model. Set *Repository.SuppressEADialogs* to **true** to suppress Enterprise Architect from showing its default dialogs.

Also look at [EA\\_OnPreNewElement](#)<sup>[1793]</sup>.

## Syntax

**Function** *EA\_OnPostNewElement*(*Repository As EA.Repository, Info As EA.EventProperties*) **As Boolean**

The *EA\_OnPostNewElement* function syntax contains the following elements:

Parameter	Type	Direction	Description
<b>Info</b>	<a href="#">EA.EventProperties</a> <sup>[1697]</sup>	IN	Contains the following <i>EventProperty</i> objects for the new element: <ul style="list-style-type: none"> <li><i>ElementID</i>: A long value corresponding to <i>Element.ElementID</i>.</li> </ul>
<b>Repository</b>	<a href="#">EA.Repository</a> <sup>[1680]</sup>	IN	An <i>EA.Repository</i> object representing the currently open Enterprise Architect model. Poll its members to retrieve model data and user interface status information.

## Return Value

Return **True** if the element has been updated during this notification. Return **False** otherwise.

### 11.3.5.9.2 EA\_OnPostNewConnector

## Details

*EA\_OnPostNewConnector* notifies Add-Ins that a new connector has been created on a diagram. It enables Add-Ins to modify the connector upon creation.

This event occurs after a user has dragged a new connector from the **Toolbox** or **Resources** window onto a diagram. The notification is provided immediately after the connector is added to the model. Set *Repository.SuppressEADialogs* to **true** to suppress Enterprise Architect from showing its default dialogs.

Also look at [EA\\_OnPreNewConnector](#)<sup>[1794]</sup>.

## Syntax

**Function** *EA\_OnPostNewConnector*(*Repository As EA.Repository, Info As EA.EventProperties*) **As Boolean**

The *EA\_OnPostNewConnector* function syntax contains the following elements:

Parameter	Type	Direction	Description
<b>Info</b>	<a href="#">EA.EventProperties</a> <sup>[1697]</sup>	IN	Contains the following <i>EventProperty</i> objects for the new connector: <ul style="list-style-type: none"> <li><i>ConnectorID</i>: A long value corresponding to <i>Connector.ConnectorID</i>.</li> </ul>
<b>Repository</b>	<a href="#">EA.Repository</a> <sup>[1680]</sup>	IN	An <i>EA.Repository</i> object representing the currently open Enterprise Architect model. Poll its members to retrieve model data and user interface status information.

## Return Value

Return **True** if the connector has been updated during this notification. Return **False** otherwise.

### 11.3.5.9.3 EA\_OnPostNewDiagram

#### Details

*EA\_OnPostNewDiagram* notifies Add-Ins that a new diagram has been created. It enables Add-Ins to modify the diagram upon creation.

Set *Repository.SuppressEADialogs* to **true** to suppress Enterprise Architect from showing its default dialogs.

Also look at [EA\\_OnPreNewDiagram](#)<sup>[1795]</sup>.

#### Syntax

**Function** *EA\_OnPostNewDiagram*(*Repository As EA.Repository, Info As EA.EventProperties*) **As Boolean**

The *EA\_OnPostNewDiagram* function syntax contains the following elements:

Parameter	Type	Direction	Description
Info	<a href="#">EA.EventProperties</a> <sup>[1697]</sup>	IN	Contains the following <i>EventProperty</i> objects for the new diagram: <ul style="list-style-type: none"> <li><i>DiagramID</i>: A long value corresponding to <i>Diagram</i>. <i>PackageID</i>.</li> </ul>
Repository	<a href="#">EA.Repository</a> <sup>[1680]</sup>	IN	An <i>EA.Repository</i> object representing the currently open Enterprise Architect model. Poll its members to retrieve model data and user interface status information.

#### Return Value

Return **True** if the diagram has been updated during this notification. Return **False** otherwise.

### 11.3.5.9.4 EA\_OnPostNewDiagramObject

#### Details

*EA\_OnPostNewDiagramObject* notifies Add-Ins that a new object has been created on a diagram. It enables Add-Ins to modify the object upon creation.

This event occurs after a user has dragged a new object from the **Project Browser** or **Resources** window onto a diagram. The notification is provided immediately after the object is added to the diagram. Set *Repository.SuppressEADialogs* to **true** to suppress Enterprise Architect from showing its default dialogs.

Also look at [EA\\_OnPreNewDiagramObject](#)<sup>[1795]</sup>.

#### Syntax

**Function** *EA\_OnPostNewDiagramObject*(*Repository As EA.Repository, Info As EA.EventProperties*) **As Boolean**

The *EA\_OnPostNewDiagramObject* function syntax contains the following elements:

Parameter	Type	Direction	Description
Info	<a href="#">EA.EventProperties</a> <sup>[1697]</sup>	IN	Contains the following <i>EventProperty</i> objects for the new element: <ul style="list-style-type: none"> <li><i>ObjectID</i>: A long value corresponding to <i>Object</i>. <i>ObjectID</i>.</li> </ul>
Repository	<a href="#">EA.Repository</a> <sup>[1680]</sup>	IN	An <i>EA.Repository</i> object representing the currently open Enterprise Architect model. Poll its members to retrieve model data and user interface status information.

## Return Value

Return **True** if the element has been updated during this notification. Return **False** otherwise.

### 11.3.5.9.5 EA\_OnPostNewAttribute

#### Details

*EA\_OnPostNewAttribute* notifies Add-Ins that a new attribute has been created on a diagram. It enables Add-Ins to modify the attribute upon creation.

This event occurs when a user creates a new attribute on an element by either drag-dropping from the **Project Browser**, using the **Attributes Properties** dialog, or using the in-place editor on the diagram. The notification is provided immediately after the attribute is created. Set *Repository.SuppressEADialogs* to **true** to suppress Enterprise Architect from showing its default dialogs.

Also look at [EA\\_OnPreNewAttribute](#)<sup>[1796]</sup>.

#### Syntax

**Function** *EA\_OnPostNewAttribute*(*Repository As EA.Repository, Info As EA.EventProperties*) **As Boolean**

The *EA\_OnPostNewAttribute* function syntax contains the following elements:

Parameter	Type	Direction	Description
<b>Info</b>	<a href="#">EA.EventProperties</a> <sup>[1697]</sup>	IN	Contains the following <i>EventProperty</i> objects for the new attribute: <ul style="list-style-type: none"> <li><i>AttributeID</i>: A long value corresponding to <i>Attribute.AttributeID</i>.</li> </ul>
<b>Repository</b>	<a href="#">EA.Repository</a> <sup>[1680]</sup>	IN	An <i>EA.Repository</i> object representing the currently open Enterprise Architect model. Poll its members to retrieve model data and user interface status information.

## Return Value

Return **True** if the attribute has been updated during this notification. Return **False** otherwise.

### 11.3.5.9.6 EA\_OnPostNewMethod

#### Details

*EA\_OnPostNewMethod* notifies Add-Ins that a new method has been created on a diagram. It enables Add-Ins to modify the method upon creation.

This event occurs when a user creates a new method on an element by either drag-dropping from the **Project Browser**, using the method's **Properties** dialog, or using the in-place editor on the diagram. The notification is provided immediately after the method is created. Set *Repository.SuppressEADialogs* to **true** to suppress Enterprise Architect from showing its default dialogs.



Also look at [EA\\_OnPreNewMethod](#)<sup>[1797]</sup>.

#### Syntax

**Function** *EA\_OnPostNewMethod*(*Repository As EA.Repository, Info As EA.EventProperties*) **As Boolean**

The *EA\_OnPostNewMethod* function syntax contains the following elements:

Parameter	Type	Direction	Description
<b>Info</b>	<a href="#">EA.EventProperties</a>	IN	Contains the following <i>EventProperty</i> objects for the new method:

Parameter	Type	Direction	Description
			<ul style="list-style-type: none"> <li><i>MethodID</i>: A long value corresponding to <i>Method</i>. <i>MethodID</i>.</li> </ul>
Repository	<a href="#">EA.Repository</a> 	IN	An <i>EA.Repository</i> object representing the currently open Enterprise Architect model. Poll its members to retrieve model data and user interface status information.

### Return Value

Return **True** if the method has been updated during this notification. Return **False** otherwise.

#### 11.3.5.9.7 EA\_OnPostNewPackage

### Details

*EA\_OnPostNewPackage* notifies Add-Ins that a new package has been created on a diagram. It enables Add-Ins to modify the package upon creation.



This event occurs when a user drags a new package from the **Toolbox** or **Resources** window onto a diagram, or by selecting the **New Package** icon from the **Project Browser**. Set *Repository.SuppressEADialogs* to **true** to suppress Enterprise Architect from showing its default dialogs.

Also look at [EA\\_OnPreNewPackage](#) .

### Syntax

**Function** *EA\_OnPostNewPackage*(*Repository As EA.Repository, Info As EA.EventProperties*) **As Boolean**

The *EA\_OnPostNewPackage* function syntax contains the following elements:

Parameter	Type	Direction	Description
Info	<a href="#">EA.EventProperties</a> 	IN	Contains the following <i>EventProperty</i> objects for the new package: <ul style="list-style-type: none"> <li><i>PackageID</i>: A long value corresponding to <i>Package</i>. <i>PackageID</i>.</li> </ul>
Repository	<a href="#">EA.Repository</a> 	IN	An <i>EA.Repository</i> object representing the currently open Enterprise Architect model. Poll its members to retrieve model data and user interface status information.

### Return Value

Return **True** if the package has been updated during this notification. Return **False** otherwise.

#### 11.3.5.10 EA\_OnPostInitialized

### Details

*EA\_OnPostInitialized* notifies Add-Ins that the Repository object has finished loading and any necessary initialization steps can now be performed on the object.

For example, the Add-In can create an **Output** tab using [Repository.CreateOutputTab](#) .

### Syntax

**Sub** *EA\_OnPostInitialized*(*Repository As EA.Repository*)

The *EA\_OnPostInitialized* function syntax contains the following elements.

Parameter	Type	Direction	Description
Repository	<a href="#">EA.Repository</a> <sup>[1680]</sup>	IN	An EA.Repository object representing the currently open Enterprise Architect model. Poll its members to retrieve model data and user interface status information.

## Return Value

None.

### 11.3.5.11 EA\_OnPostTransform

#### Details

*EA\_OnPostTransform* notifies Add-Ins that an MDG transformation has taken place with the output in the specified target package.

This event occurs when a user runs an MDG transform on one or more target packages. The notification is provided for each transform/target package immediately after all transform processes have completed.

#### Syntax

**Function** *EA\_OnPostTransform(Repository As EA.Repository, Info As EA.EventProperties) As Boolean*

The *EA\_OnPostTransform* function syntax contains the following elements:

Parameter	Type	Direction	Description
Info	<a href="#">EA.EventProperties</a> <sup>[1697]</sup>	IN	Contains the following <i>EventProperty Objects</i> for the transform performed: <ul style="list-style-type: none"> <li><i>Transform</i>: A string value corresponding to the name of the transform used</li> <li><i>PackageID</i>: A long value corresponding to <i>Package.PackageID</i> of the destination package.</li> </ul>
Repository	<a href="#">EA.Repository</a> <sup>[1680]</sup>	IN	An EA.Repository object representing the currently open Enterprise Architect model. Poll its members to retrieve model data and user interface status information.

## Return Value

Reserved for future use.

### 11.3.5.12 Technology Events

Enterprise Architect Add-Ins can respond to the following events associated with the use of MDG Technologies:

- [EA\\_OnInitializeTechnologies](#)<sup>[1803]</sup>
- [EA\\_OnPreActivateTechnology](#)<sup>[1804]</sup>
- [EA\\_OnPostActivateTechnology](#)<sup>[1805]</sup>
- [EA\\_OnPreDeleteTechnology](#)<sup>[1805]</sup> (Deprecated)
- [EA\\_OnDeleteTechnology](#)<sup>[1805]</sup> (Deprecated)
- [EA\\_OnImportTechnology](#)<sup>[1806]</sup> (Deprecated)

#### 11.3.5.12.1 EA\_OnInitializeTechnologies

#### Details

*EA\_OnInitializeTechnologies* requests that an Add-In pass an MDG Technology to Enterprise Architect for loading.

This event occurs on Enterprise Architect startup. Return your technology XML to this function and Enterprise

Architect loads and enables it.

## Syntax

### **Function** *EA\_OnInitializeTechnologies(Repository As EA.Repository) As Object*

The *EA\_OnInitializeTechnologies* function syntax contains the following element:

Parameter	Type	Direction	Description
Repository	<a href="#">EA.Repository</a> <small>1680</small>	IN	An <i>EA.Repository</i> object representing the currently open Enterprise Architect model. Poll its members to retrieve model data and user interface status information.

## Return Value

Return the MDG Technology as a single XML string.

## Example

```
Public Function EA_OnInitializeTechnologies(ByVal Repository As EA.Repository) As Object
    EA_OnInitializeTechnologies = My.Resources.MyTechnology
End Function
```

### 11.3.5.12.2 *EA\_OnPreActivateTechnology*

## Details

*EA\_OnPreActivateTechnology* notifies Add-Ins that an MDG Technology resource is about to be activated in the model. This event occurs when a user selects to activate an MDG Technology resource in the model (by clicking on the **Set Active** button on the [MDG Technologies](#)<sup>1069</sup> dialog or by selecting the technology in the list box in the [Default Tools](#)<sup>80</sup> toolbar).

The notification is provided immediately after the user attempts to activate the MDG Technology, so that the Add-In can permit or disable activation of the Technology.

Also look at [EA\\_OnPostActivateTechnology](#)<sup>1805</sup>.

## Syntax

### **Function** *EA\_OnPreActivateTechnology(Repository As EA.Repository, Info As EA.EventProperties) As Boolean*

The *EA\_OnPreActivateTechnology* function syntax contains the following elements:

Parameter	Type	Direction	Description
Info	<a href="#">EA.EventProperties</a> <small>1697</small>	IN	Contains the following <i>EventProperty</i> objects for the MDG Technology to be activated: <ul style="list-style-type: none"> <li><i>TechnologyID</i>: A string value corresponding to the MDG Technology ID.</li> </ul>
Repository	<a href="#">EA.Repository</a> <sup>1680</sup>	IN	An <i>EA.Repository</i> object representing the currently open Enterprise Architect model. Poll its members to retrieve model data and user interface status information.

## Return Value

Return **True** to enable activation of the MDG Technology resource in the model. Return **False** to disable activation of the MDG Technology resource.



### 11.3.5.12.3 EA\_OnPostActivateTechnology

#### Details

*EA\_OnPostActivateTechnology* notifies Add-Ins that an MDG Technology resource has been activated in the model. This event occurs when a user activates an MDG Technology resource in the model (by clicking on the **Set Active** button on the [MDG Technologies](#) <sup>1069</sup> dialog or by selecting the technology in the list box in the [Default Tools](#) <sup>80</sup> toolbar). The notification is provided immediately after the user succeeds in activating the MDG Technology, so that the Add-In can update the Technology if necessary.

Also look at [EA\\_OnPreActivateTechnology](#) <sup>1804</sup>.

#### Syntax

**Function** *EA\_OnPostActivateTechnology(Repository As EA.Repository, Info As EA.EventProperties)*

The *EA\_OnPostActivateTechnology* function syntax contains the following elements:

Parameter	Type	Direction	Description
Info	<a href="#">EA.EventProperties</a> <sup>1697</sup>	IN	Contains the following <i>EventProperty</i> objects for the MDG Technology to be activated: <ul style="list-style-type: none"> <li><i>TechnologyID</i>: A string value corresponding to the MDG Technology ID.</li> </ul>
Repository	<a href="#">EA.Repository</a> <sup>1680</sup>	IN	An <i>EA.Repository</i> object representing the currently open Enterprise Architect model. Poll its members to retrieve model data and user interface status information.

#### Return Value

Return **True** if the MDG Technology resource is updated during this notification. Return **False** otherwise.

### 11.3.5.12.4 EA\_OnPreDeleteTechnology

**Deprecated** - refers to deleting a technology through the **Resources** window; this process is no longer recommended. See:

- [EA\\_OnPreActivateTechnology](#) <sup>1804</sup>
- [EA\\_OnPostActivateTechnology](#) <sup>1805</sup>
- [EA\\_OnInitializeTechnologies](#) <sup>1803</sup>.

#### Details

*EA\_OnPreDeleteTechnology* notifies Add-Ins that an MDG Technology resource is about to be deleted from the model. This event occurs when a user deletes an MDG Technology resource from the model. The notification is provided immediately after the user confirms their request to delete the MDG Technology, so that the Add-In can disable deletion of the MDG Technology.

Also look at [EA\\_OnDeleteTechnology](#) <sup>1806</sup>.

#### Syntax

**Function** *EA\_OnPreDeleteTechnology(Repository As EA.Repository, Info As EA.EventProperties) As Boolean*

The *EA\_OnPreDeleteTechnology* function syntax contains the following elements:

Parameter	Type	Direction	Description
Info	<a href="#">EA.EventProperties</a> <sup>1697</sup>	IN	Contains the following <i>EventProperty</i> objects for the MDG Technology to be deleted: <ul style="list-style-type: none"> <li><i>TechnologyID</i>: A string value corresponding to the MDG Technology ID.</li> </ul>

Parameter	Type	Direction	Description
Repository	<a href="#">EA.Repository</a> <sup>[1680]</sup>	IN	An <i>EA.Repository</i> object representing the currently open Enterprise Architect model. Poll its members to retrieve model data and user interface status information.

### Return Value

Return **True** to enable deletion of the MDG Technology resource from the model. Return **False** to disable deletion of the MDG Technology resource.

#### 11.3.5.12.5 EA\_OnDeleteTechnology

**Deprecated** - refers to deleting a technology through the **Resources** window; this process is no longer recommended. See:

- [EA\\_OnPreActivateTechnology](#)<sup>[1804]</sup>
- [EA\\_OnPostActivateTechnology](#)<sup>[1805]</sup>
- [EA\\_OnInitializeTechnologies](#)<sup>[1803]</sup>.

### Details

*EA\_OnDeleteTechnology* notifies Add-Ins that an MDG Technology resource has been deleted from the model.

This event occurs after a user has deleted an MDG Technology resource from the model. Add-Ins that require an MDG Technology resource to be loaded can catch this event to disable certain functionality.

Also look at [EA\\_OnPreDeleteTechnology](#)<sup>[1805]</sup>.

### Syntax

**Sub EA\_OnDeleteTechnology(Repository As EA.Repository, Info As EA.EventProperties)**

The *EA\_OnDeleteTechnology* function syntax contains the following elements:

Parameter	Type	Direction	Description
Info	<a href="#">EA.EventProperties</a> <sup>[1697]</sup>	IN	Contains the following <i>EventProperty</i> objects: <ul style="list-style-type: none"> <li>• <i>TechnologyID</i>: A string value corresponding to the MDG Technology ID.</li> </ul>
Repository	<a href="#">EA.Repository</a> <sup>[1680]</sup>	IN	An <i>EA.Repository</i> object representing the currently open Enterprise Architect model. Poll its members to retrieve model data and user interface status information.

### Return Value

None.

#### 11.3.5.12.6 EA\_OnImportTechnology

**Deprecated** - refers to deleting a technology through the **Resources** window; this process is no longer recommended. See:

- [EA\\_OnPreActivateTechnology](#)<sup>[1804]</sup>
- [EA\\_OnPostActivateTechnology](#)<sup>[1805]</sup>
- [EA\\_OnInitializeTechnologies](#)<sup>[1803]</sup>.

### Details

*EA\_OnImportTechnology* notifies Add-Ins that you have imported an MDG Technology resource into the model.

This event occurs after you have imported an MDG Technology resource into the model. Add-Ins that require an MDG Technology resource to be loaded can catch this Add-In to enable certain functionality.

## Syntax

**Sub EA\_OnImportTechnology(Repository As EA.Repository, Info As EA.EventProperties)**

The *EA\_OnImportTechnology* function syntax contains the following elements:

Parameter	Type	Direction	Description
Info	<a href="#">EA.EventProperties</a> <sup>[1697]</sup>	IN	Contains the following <i>EventProperty</i> objects: <ul style="list-style-type: none"> <li><i>TechnologyID</i>: A string value corresponding to the MDG Technology ID.</li> </ul>
Repository	<a href="#">EA.Repository</a> <sup>[1680]</sup>	IN	An <i>EA.Repository</i> object representing the currently open Enterprise Architect model. Poll its members to retrieve model data and user interface status information.

## Return Value

None.

### 11.3.5.13 Context Item Events

Enterprise Architect Add-Ins can respond to the following events associated with changing context:

- [EA\\_OnContextItemChanged](#)<sup>[1807]</sup>
- [EA\\_OnContextItemDoubleClicked](#)<sup>[1808]</sup>
- [EA\\_OnNotifyContextItemModified](#)<sup>[1809]</sup>

#### 11.3.5.13.1 EA\_OnContextItemChanged

## Details

*EA\_OnContextItemChanged* notifies Add-Ins that a different item is now in context.

This event occurs after a user has selected an item anywhere in the Enterprise Architect GUI. Add-Ins that require knowledge of the current item in context can subscribe to this broadcast function. If *ot = otRepository*, then this function behaves the same as [EA\\_FileOpen](#)<sup>[1788]</sup>.

Also look at [EA\\_OnContextItemDoubleClicked](#)<sup>[1808]</sup> and [EA\\_OnNotifyContextItemModified](#)<sup>[1809]</sup>.

## Syntax

**Sub EA\_OnContextItemChanged(Repository As EA.Repository, GUID As String, ot as EA.ObjectType)**

The *EA\_OnContextItemChanged* function syntax contains the following elements:

Parameter	Type	Direction	Description
GUID	String	IN	Contains the GUID of the new context item. This value corresponds to the following properties, depending on the value of the <i>ot</i> parameter: <ul style="list-style-type: none"> <li><i>ot (ObjectType)</i> - GUID value</li> <li><i>otElement</i> - <i>Element.ElementGUID</i></li> <li><i>otPackage</i> - <i>Package.PackageGUID</i></li> <li><i>otDiagram</i> - <i>Diagram.DiagramGUID</i></li> <li><i>otAttribute</i> - <i>Attribute.AttributeGUID</i></li> <li><i>otMethod</i> - <i>Method.MethodGUID</i></li> <li><i>otConnector</i> - <i>Connector.ConnectorGUID</i></li> <li><i>otRepository</i> - NOT APPLICABLE, GUID is an empty string</li> </ul>

Parameter	Type	Direction	Description
<b>ot</b>	<i>EA.ObjectType</i>	IN	Specifies the type of the new context item.
<b>Repository</b>	<a href="#">EA.Repository</a> <small> 1680 </small>	IN	An <i>EA.Repository</i> object representing the currently open Enterprise Architect model. Poll its members to retrieve model data and user interface status information.

## Return Value

None.

### 11.3.5.13.2 EA\_OnContextItemDoubleClicked

#### Details

*EA\_OnContextItemDoubleClicked* notifies Add-Ins that the user has double-clicked the item currently in context.

This event occurs when a user has double-clicked (or pressed **[Enter]**) on the item in context, either in a diagram or in the **Project Browser**. Add-Ins to handle events can subscribe to this broadcast function.

Also look at [EA\\_OnContextItemChanged](#)|1807| and [EA\\_OnNotifyContextItemModified](#)|1809|.

#### Syntax

**Function** *EA\_OnContextItemDoubleClicked*(*Repository* As *EA.Repository*, *GUID* As *String*, *ot* as *EA.ObjectType*)

The *EA\_OnContextItemDoubleClicked* function syntax contains the following elements:

Parameter	Type	Direction	Description
<b>GUID</b>	<i>String</i>	IN	Contains the GUID of the new context item. This value corresponds to the following properties, depending on the value of the <b>ot</b> parameter:  <i>ot (ObjectType)</i> - <i>GUID value</i> <i>otElement</i> - <i>Element.ElementGUID</i> <i>otPackage</i> - <i>Package.PackageGUID</i> <i>otDiagram</i> - <i>Diagram.DiagramGUID</i> <i>otAttribute</i> - <i>Attribute.AttributeGUID</i> <i>otMethod</i> - <i>Method.MethodGUID</i> <i>otConnector</i> - <i>Connector.ConnectorGUID</i>
<b>ot</b>	<i>EA.ObjectType</i>	IN	Specifies the type of the new context item.
<b>Repository</b>	<a href="#">EA.Repository</a> <small> 1680 </small>	IN	An <i>EA.Repository</i> object representing the currently open Enterprise Architect model. Poll its members to retrieve model data and user interface status information.

## Return Value

Return **True** to notify Enterprise Architect that the double-click event has been handled by an Add-In. Return **False** to enable Enterprise Architect to continue processing the event.

### 11.3.5.13.3 EA\_OnNotifyContextItemModified

#### Details

*EA\_OnNotifyContextItemModified* notifies Add-Ins that the current context item has been modified.

This event occurs when a user has modified the context item. Add-Ins that require knowledge of when an item has been modified can subscribe to this broadcast function.

Also look at [EA\\_OnContextItemChanged](#)<sup>[1807]</sup> and [EA\\_OnContextItemDoubleClicked](#)<sup>[1808]</sup>.

#### Syntax

**Sub** *EA\_OnNotifyContextItemModified*(*Repository As EA.Repository, GUID As String, ot as EA.ObjectType*)

The *EA\_OnNotifyContextItemModified* function syntax contains the following elements:

Parameter	Type	Direction	Description
<b>GUID</b>	<i>String</i>	IN	Contains the GUID of the new context item. This value corresponds to the following properties, depending on the value of the <i>ot</i> parameter: <ul style="list-style-type: none"> <li><i>ot (ObjectType)</i> - <i>GUID value</i></li> <li><i>otElement</i> - <i>Element.ElementGUID</i></li> <li><i>otPackage</i> - <i>Package.PackageGUID</i></li> <li><i>otDiagram</i> - <i>Diagram.DiagramGUID</i></li> <li><i>otAttribute</i> - <i>Attribute.AttributeGUID</i></li> <li><i>otMethod</i> - <i>Method.MethodGUID</i></li> <li><i>otConnector</i> - <i>Connector.ConnectorGUID</i></li> </ul>
<b>ot</b>	<i>EA.ObjectType</i>	IN	Specifies the type of the new context item.
<b>Repository</b>	<a href="#">EA.Repository</a> <sup>[1880]</sup>	IN	An <i>EA.Repository</i> object representing the currently open Enterprise Architect model. Poll its members to retrieve model data and user interface status information.

#### Return Value

None.

### 11.3.5.14 Compartment Events

Enterprise Architect Add-Ins can respond to the following events associated with user-generated element compartments:

- [EA\\_QueryAvailableCompartments](#)<sup>[1809]</sup>
- [EA\\_GetCompartmentData](#)<sup>[1810]</sup>

#### 11.3.5.14.1 EA\_QueryAvailableCompartments

#### Details

This event occurs when Enterprise Architect's diagrams are refreshed. It is a request for the Add-In to provide a list of user-defined compartments. The [EA\\_GetCompartmentData](#)<sup>[1810]</sup> event then queries each object for the data to display in each user-defined compartment.

#### Syntax

**Function** *EA\_QueryAvailableCompartments*(*Repository As EA.Repository*) *As Variant*

The *EA\_QueryAvailableCompartments* function syntax contains the following elements:

Parameter	Type	Direction	Description
Repository	<a href="#">EA.Repository</a> <small>[1680]</small>	IN	An <i>EA.Repository</i> object representing the currently open Enterprise Architect model. Poll its members to retrieve model data and user interface status information.

## Return Value

A *String* containing a comma-separated list of user-defined compartments.

## Example

```
Function EA_QueryAvailableCompartments(Repository As EA.Repository) As Variant
    Dim sReturn As String
    sReturn = ""
    If m_FirstCompartmentVisible = True Then
        sReturn = sReturn + "first,"
    End If
    If m_SecondCompartmentVisible = True Then
        sReturn = sReturn + "second,"
    End If
    If m_ThirdCompartmentVisible = True Then
        sReturn = sReturn + "third,"
    End If

    If Len(sReturn) > 0 Then
        sReturn = Left(sReturn, Len(sReturn)-1)
    End If

    EA_QueryAvailableCompartments = sReturn
End Function
```

### 11.3.5.14.2 EA\_GetCompartmentData

## Details

This event occurs when Enterprise Architect is instructed to redraw an element. It requests that the Add-In provide the data to populate the element's compartment.

## Syntax

**Function** *EA\_GetCompartmentData*(*Repository As EA.Repository, sCompartment As String, sGUID As String, oType As EA.ObjectType*) **As Variant**

The *EA\_QueryAvailableCompartments* function syntax contains the following elements:

Parameter	Type	Direction	Description
<b>oType</b>	<i>ObjectType</i>	IN	The type of the element for which data is being requested.
<b>Repository</b>	<a href="#">EA.Repository</a> <small>[1680]</small>	IN	An <i>EA.Repository</i> object representing the currently open Enterprise Architect model. Poll its members to retrieve model data and user interface status information.
<b>sCompartment</b>	<i>String</i>	IN	The name of the compartment for which data is being requested.
<b>sGUID</b>	<i>String</i>	IN	The GUID of the element for which data is being requested.

## Return Value

Variant containing a formatted string. See the example below to understand the format.

## Example

Function EA\_GetCompartmentData(Repository As EA.Repository, sCompartment As String, sGUID As String, oType As EA.ObjectType) As Variant

```
If Repository Is Nothing Then
Exit Function
End If
```

```
Dim sCompartmentData As String
Dim oXML As MSXML2.DOMDocument
Dim Nodes As MSXML2.IXMLDOMNodeList
Dim Node1 As MSXML2.IXMLDOMNode
Dim Node As MSXML2.IXMLDOMNode
Dim sData As String
```

```
sCompartmentData = ""
Set oXML = New MSXML2.DOMDocument
sData = ""
```

```
On Error GoTo ERR_GetCompartmentData
```

```
oXML.loadXML (Repository.GetTreeXMLByGUID(sGUID))
Set Node1 = oXML.selectSingleNode("//ModelItem")
```

```
If Node1 Is Nothing Then
Exit Function
End If
```

```
sCompartmentData = sCompartmentData + "Name=" + sCompartment + ";"
sCompartmentData = sCompartmentData + "OwnerGUID=" + sGUID + ";"
sCompartmentData = sCompartmentData + "Options=SkipIfOnDiagram&_eq_^1&_sc_^"
```

```
Select Case sCompartment
```

```
Case "parts"
```

```
Set Nodes = Node1.selectNodes("ModelItem[@Metatype=""Part""]")
```

```
For Each Node In Nodes
```

```
sData = sData + "Data&_eq_^" + Node.Attributes.getNamedItem("Name").nodeValue + "&_sc_^"
```

```
sData = sData + "GUID&_eq_^" + Node.Attributes.getNamedItem("GUID").nodeValue + "&_sc_^,"
```

```
Next
```

```
Case "ports"
```

```
Set Nodes = Node1.selectNodes("ModelItem[@Metatype=""Port""]")
```

```
For Each Node In Nodes
```

```
sData = sData + "Data&_eq_^" + Node.Attributes.getNamedItem("Name").nodeValue + "&_sc_^"
```

```
sData = sData + "GUID&_eq_^" + Node.Attributes.getNamedItem("GUID").nodeValue + "&_sc_^,"
```

```
Next
```

```
End Select
```

```
' If there's no data to display, then don't return any compartment data
```

```
If sData <> "" Then
```

```
sCompartmentData = sCompartmentData + "CompartmentData=" + sData + ";"
```

```
Else
```

```
sCompartmentData = ""
```

```
End If
```

```
EA_GetCompartmentData = sCompartmentData
```

```
Exit Function
```

```
ERR_GetCompartmentData:
EA_GetCompartmentData = ""
```

```
End Function
```

### 11.3.5.15 Model Validation Broadcasts

#### Perform Model Validation from an Add-In

Using Enterprise Architect broadcasts, it is possible to define a set of rules that are evaluated when the user instructs Enterprise Architect to perform model validation. An Add-In that performs model validation would involve the following broadcast events:

- [EA\\_OnInitializeUserRules](#)<sup>[1812]</sup> is intercepted in order to define rule categories and rules.
- [EA\\_OnStartValidation](#)<sup>[1812]</sup> can be intercepted to perform any required processing prior to validation.
- The following functions intercept each request to validate an individual element, package, diagram, connector, attribute and method:

- [EA\\_OnRunElementRule](#)<sup>[1813]</sup>
- [EA\\_OnRunPackageRule](#)<sup>[1813]</sup>
- [EA\\_OnRunDiagramRule](#)<sup>[1814]</sup>
- [EA\\_OnRunConnectorRule](#)<sup>[1814]</sup>
- [EA\\_OnRunAttributeRule](#)<sup>[1815]</sup>
- [EA\\_OnRunMethodRule](#)<sup>[1815]</sup>
- [EA\\_OnEndValidation](#)<sup>[1813]</sup> can be intercepted to perform any required clean-up after validation has completed.

Also consider the [Model Validation Example](#)<sup>[1816]</sup>.

### 11.3.5.15.1 EA\_OnInitializeUserRules

#### Details

*EA\_OnInitializeUserRules* is called on Enterprise Architect start-up and requests that the Add-In provide Enterprise Architect with a rule category and list of rule IDs for model validation.

This function must be implemented by any Add-In that is to perform its own model validation. It must call *Project.DefineRuleCategory* once and *Project.DefineRule* for each rule; these functions are described in the [Project Interface](#)<sup>[1753]</sup> section.

#### Syntax

**Sub EA\_OnInitializeUserRules(Repository As EA.Repository)**

The *EA\_OnInitializeUserRules* function syntax contains the following elements:

Parameter	Type	Direction	Description
Repository	<a href="#">EA.Repository</a> <sup>[1680]</sup>	IN	An <i>EA.Repository</i> object representing the currently open Enterprise Architect model. Poll its members to retrieve model data and user interface status information.

### 11.3.5.15.2 EA\_OnStartValidation

#### Details

*EA\_OnStartValidation* notifies Add-Ins that a user has invoked the model validation command from Enterprise Architect.

#### Syntax

**Sub EA\_OnStartValidation(Repository As EA.Repository, ParamArray Args() as Variant)**

The *EA\_OnStartValidation* function syntax contains the following elements:

Parameter	Type	Direction	Description
Args	<i>ParamArray of Variant</i>	IN	Contains a list of Rule Categories that are active for the current invocation of model validation.
Repository	<a href="#">EA.Repository</a> <sup>[1680]</sup>	IN	An <i>EA.Repository</i> object representing the currently open Enterprise Architect model. Poll its members to retrieve model data and user interface status information.



### 11.3.5.15.3 EA\_OnEndValidation

#### Details

*EA\_OnEndValidation* notifies Add-Ins that model validation has completed. Use this event to arrange any clean-up operations arising from the validation.

#### Syntax

**Sub EA\_OnEndValidation(Repository As EA.Repository, ParamArray Args() as Variant)**

The *EA\_OnEndValidation* function syntax contains the following elements:

Parameter	Type	Direction	Description
Args	ParamArray of Variant	IN	Contains a list of Rule Categories that were active for the invocation of model validation that has just completed.
Repository	<a href="#">EA.Repository</a> <sup>[1680]</sup>	IN	An <i>EA.Repository</i> object representing the currently open Enterprise Architect model. Poll its members to retrieve model data and user interface status information.

### 11.3.5.15.4 EA\_OnRunElementRule

#### Details

This event is triggered once for each rule defined in *EA\_OnInitializeUserRules* to be performed on each element in the selection being validated. If you don't want to perform the rule defined by **RuleID** on the given element, then simply return without performing any action. On performing any validation, if a validation error is found, use the *Repository.ProjectInterface.PublishResult* method to notify Enterprise Architect.

Also look at [EA\\_OnInitializeUserRules](#)<sup>[1812]</sup>.

#### Syntax

**Sub EA\_OnRunElementRule(Repository As EA.Repository, RuleID As String, Element As EA.Element)**

The *EA\_OnRunElementRule* function syntax contains the following elements:

Parameter	Type	Direction	Description
Element	<i>EA.Element</i>	IN	The element to potentially perform validation on.
Repository	<a href="#">EA.Repository</a> <sup>[1680]</sup>	IN	An <i>EA.Repository</i> object representing the currently open Enterprise Architect model. Poll its members to retrieve model data and user interface status information.
RuleID	String	IN	The ID that was passed into the <i>Project.DefineRule</i> command.

### 11.3.5.15.5 EA\_OnRunPackageRule

#### Details

This event is triggered once for each rule defined in [EA\\_OnInitializeUserRules](#)<sup>[1812]</sup> to be performed on each package in the selection being validated. If you don't want to perform the rule defined by **RuleID** on the given package, then simply return without performing any action. On performing any validation, if a validation error is found, use the *Repository.ProjectInterface.PublishResult* method to notify Enterprise Architect.

#### Syntax

**Sub EA\_OnRunPackageRule(Repository As EA.Repository, RuleID As String, PackageID As Long)**

The *EA\_OnRunElementRule* function syntax contains the following elements:

Parameter	Type	Direction	Description
PackageID	Long	IN	The ID of the package to potentially perform validation on. Use the <i>Repository.GetPackageByID</i> method to retrieve the package object.
Repository	<a href="#">EA.Repository</a> [1680]	IN	An <i>EA.Repository</i> object representing the currently open Enterprise Architect model. Poll its members to retrieve model data and user interface status information.
RuleID	String	IN	The ID that was passed into the <i>Project.DefineRule</i> method.

### 11.3.5.15.6 EA\_OnRunDiagramRule

#### Details

This event is triggered once for each rule defined in [EA\\_OnInitializeUserRules](#)<sup>[1812]</sup> to be performed on each diagram in the selection being validated. If you don't want to perform the rule defined by **RuleID** on the given diagram, then simply return without performing any action. On performing any validation, if a validation error is found, use the *Repository.ProjectInterface.PublishResult* method to notify Enterprise Architect.

#### Syntax

**Sub EA\_OnRunDiagramRule(Repository As EA.Repository, RuleID As String, DiagramID As Long)**

The *EA\_OnRunDiagramRule* function syntax contains the following elements:

Parameter	Type	Direction	Description
DiagramID	Long	IN	The ID of the diagram to potentially perform validation on. Use the <i>Repository.GetDiagramByID</i> method to retrieve the diagram object.
Repository	<a href="#">EA.Repository</a> [1680]	IN	An <i>EA.Repository</i> object representing the currently open Enterprise Architect model. Poll its members to retrieve model data and user interface status information.
RuleID	String	IN	The ID that was passed into the <i>Project.DefineRule</i> command.

### 11.3.5.15.7 EA\_OnRunConnectorRule

#### Details

This event is triggered once for each rule defined in [EA\\_OnInitializeUserRules](#)<sup>[1812]</sup> to be performed on each connector in the selection being validated. If you don't want to perform the rule defined by **RuleID** on the given connector, then simply return without performing any action. On performing any validation, if a validation error is found, use the *Repository.ProjectInterface.PublishResult* method to notify Enterprise Architect.

#### Syntax

**Sub EA\_OnRunConnectorRule(Repository As EA.Repository, RuleID As String, ConnectorID As Long)**

The *EA\_OnRunConnectorRule* function syntax contains the following elements:

Parameter	Type	Direction	Description
ConnectorID	Long	IN	The ID of the connector to potentially perform validation on. Use the <i>Repository.GetConnectorByID</i> method to retrieve the connector object.
Repository	<a href="#">EA.Repository</a> [1680]	IN	An <i>EA.Repository</i> object representing the currently open Enterprise Architect model. Poll its members to retrieve model data and user interface status information.

Parameter	Type	Direction	Description
RuleID	String	IN	The ID that was passed into the <i>Project.DefineRule</i> command.

### 11.3.5.15.8 EA\_OnRunAttributeRule

#### Details

This event is triggered once for each rule defined in [EA\\_OnInitializeUserRules](#)<sup>[1812]</sup> to be performed on each attribute in the selection being validated. If you don't want to perform the rule defined by **RuleID** on the given attribute, then simply return without performing any action. On performing any validation, if a validation error is found, use the *Repository.ProjectInterface.PublishResult* method to notify Enterprise Architect.

#### Syntax

**Sub EA\_OnRunAttributeRule(Repository As EA.Repository, RuleID As String, AttributeGUID As String, ObjectID As Long)**

The *EA\_OnRunAttributeRule* function syntax contains the following elements:

Parameter	Type	Direction	Description
AttributeGUID	String	IN	The GUID of the attribute to potentially perform validation on. Use the <i>Repository.GetAttributeByGuid</i> method to retrieve the attribute object.
ObjectID	Long	IN	The ID of the object that owns the given attribute. Use the <i>Repository.GetObjectByID</i> method to retrieve the object.
Repository	<a href="#">EA.Repository</a> <sup>[1680]</sup>	IN	An <i>EA.Repository</i> object representing the currently open Enterprise Architect model. Poll its members to retrieve model data and user interface status information.
RuleID	String	IN	The ID that was passed into the <i>Project.DefineRule</i> command.

### 11.3.5.15.9 EA\_OnRunMethodRule

#### Details

This event is triggered once for each rule defined in [EA\\_OnInitializeUserRules](#)<sup>[1812]</sup> to be performed on each method in the selection being validated. If you don't want to perform the rule defined by **RuleID** on the given method, then simply return without performing any action. On performing any validation, if a validation error is found, use the *Repository.ProjectInterface.PublishResult* method to notify Enterprise Architect.

#### Syntax

**Sub EA\_OnRunMethodRule(Repository As EA.Repository, RuleID As String, MethodGUID As String, ObjectID As Long)**

The *EA\_OnRunMethodRule* function syntax contains the following elements:

Parameter	Type	Direction	Description
MethodGUID	String	IN	The GUID of the method to potentially perform validation on. Use the <i>Repository.GetMethodByGuid</i> method to retrieve the method object.
ObjectID	Long	IN	The ID of the object that owns the given method. Use the <i>Repository.GetObjectByID</i> method to retrieve the object.
Repository	<a href="#">EA.Repository</a> <sup>[1680]</sup>	IN	An <i>EA.Repository</i> object representing the currently open Enterprise Architect model. Poll its members to retrieve model data and user interface status information.

Parameter	Type	Direction	Description
RuleID	String	IN	The ID that was passed into the <i>Project.DefineRule</i> command.

### 11.3.5.15.10 EA\_OnRunParameterRule

#### Details

This event is triggered once for each rule defined in [EA\\_OnInitializeUserRules](#)<sup>[1812]</sup> to be performed on each parameter in the selection being validated. If you don't want to perform the rule defined by **RuleID** on the given parameter, then simply return without performing any action. On performing any validation, if a validation error is found, use the *Repository.ProjectInterface.PublishResult* method to notify Enterprise Architect.

#### Syntax

**Sub EA\_OnRunParameterRule(Repository As EA.Repository, RuleID As String, ParameterGUID As String, MethodGUID As String, ObjectID As Long)**

The *EA\_OnRunMethodRule* function syntax contains the following elements:

Parameter	Type	Direction	Description
MethodGUID	String	IN	The GUID of the method that owns the given parameter. Use the <i>Repository.GetMethodByGuid</i> method to retrieve the method object.
ObjectID	Long	IN	The ID of the object that owns the given parameter. Use the <i>Repository.GetObjectByID</i> method to retrieve the object.
ParameterGUID	String	IN	The GUID of the parameter to potentially perform validation on. Use it to retrieve the parameter by iterating through the <i>Method.Parameters</i> collection.
Repository	<a href="#">EA.Repository</a> <sup>[1688]</sup>	IN	An <i>EA.Repository</i> object representing the currently open Enterprise Architect model. Poll its members to retrieve model data and user interface status information.
RuleID	String	IN	The ID that was passed into the <i>Project.DefineRule</i> command.

### 11.3.5.15.11 Model Validation Example

The following example code is written in C# and provides a skeleton model validation implementation that you might like to use as a starting point in writing your own model validation rules.

#### Main.cs

```
using System;

namespace myAddin
{
    public class Main
    {
        public Rules theRules;

        public Main()
        {
            theRules = new Rules();
        }

        public string EA_Connect(EA.Repository Repository)
        {
            return "";
        }

        public void EA_Disconnect()
        {
        }
    }
}
```

```
        GC.Collect();
        GC.WaitForPendingFinalizers();
    }

    private bool IsProjectOpen(EA.Repository Repository)
    {
        try
        {
            EA.Collection c = Repository.Models;
            return true;
        }
        catch
        {
            return false;
        }
    }

    public object EA_GetMenuItems(EA.Repository Repository, string MenuLocation, string MenuName)
    {
        switch (MenuName)
        {
            case "":
                return "-&myAddin";
            case "-&myAddin":
                string[] ar = { "&Test" };
                return ar;
        }
        return "";
    }

    public void EA_GetMenuState(EA.Repository Repository, string MenuLocation, string MenuName, string
    ItemName, ref bool IsEnabled, ref bool IsChecked)
    {
        // if no open project, disable all menu options
        if (IsProjectOpen(Repository))
            IsEnabled = true;
        else
            IsEnabled = false;
    }

    public void EA_MenuClick(EA.Repository Repository, string MenuLocation, string MenuName, string
    ItemName)
    {
        switch (ItemName)
        {
            case "&Test":
                DoTest(Repository);
                break;
        }
    }

    public void EA_OnInitializeUserRules(EA.Repository Repository)
    {
        if (Repository != null)
        {
            theRules.ConfigureCategories(Repository);
            theRules.ConfigureRules(Repository);
        }
    }

    public void EA_OnRunElementRule(EA.Repository Repository, string RuleID, EA.Element element)
    {
        theRules.RunElementRule(Repository, RuleID, element);
    }

    public void EA_OnRunDiagramRule(EA.Repository Repository, string RuleID, long IDiagramID)
    {
        theRules.RunDiagramRule(Repository, RuleID, IDiagramID);
    }

    public void EA_OnRunConnectorRule(EA.Repository Repository, string RuleID, long IConnectorID)
    {
        theRules.RunConnectorRule(Repository, RuleID, IConnectorID);
    }

    public void EA_OnRunAttributeRule(EA.Repository Repository, string RuleID, string AttGUID, long
```

```

IObjectID)
    {
        return;
    }

    public void EA_OnDeleteTechnology(EA.Repository Repository, EA.EventProperties Info)
    {
        return;
    }

    public void EA_OnImportTechnology(EA.Repository Repository, EA.EventProperties Info)
    {
        return;
    }

    private void DoTest(EA.Repository Rep)
    {
        // TODO: insert test code here
    }
}
}

```

## Rules.cs

```

using System;
using System.Collections;

namespace myAddin
{
    public class Rules
    {
        private string m_sCategoryID;
        private System.Collections.ArrayList m_RuleIDs;
        private System.Collections.ArrayList m_RuleIDEx;

        private const string cRule01 = "Rule01";
        private const string cRule02 = "Rule02";
        private const string cRule03 = "Rule03";
        // TODO: expand this list as much as necessary

        public Rules()
        {
            m_RuleIDs = new System.Collections.ArrayList();
            m_RuleIDEx = new System.Collections.ArrayList();
        }

        private string LookupMap(string sKey)
        {
            return DoLookupMap(sKey, m_RuleIDs, m_RuleIDEx);
        }

        private string LookupMapEx(string sRule)
        {
            return DoLookupMap(sRule, m_RuleIDEx, m_RuleIDs);
        }

        private string DoLookupMap(string sKey, ArrayList arrValues, ArrayList arrKeys)
        {
            if (arrKeys.Contains(sKey))
                return arrValues[arrKeys.IndexOf(sKey)].ToString();
            else
                return "";
        }

        private void AddToMap(string sRuleID, string sKey)
        {
            m_RuleIDs.Add(sRuleID);
            m_RuleIDEx.Add(sKey);
        }

        private string GetRuleStr(string sRuleID)
        {
            switch (sRuleID)
            {
                case cRule01:
                    return "Error Message 01";
            }
        }
    }
}

```

```

        case cRule02:
            return "Error Message 02";
        case cRule03:
            return "Error Message 03";
        // TODO: add extra cases as much as necessary
    }
    return "";
}

public void ConfigureCategories(EA.Repository Repository)
{
    EA.Project Project = Repository.GetProjectInterface();
    m_sCategoryID = Project.DefineRuleCategory("Enterprise Collaboration Architecture (ECA)
Rules");
}

public void ConfigureRules(EA.Repository Repository)
{
    EA.Project Project = Repository.GetProjectInterface();
    AddToMap(Project.DefineRule(m_sCategoryID, EA.EnumMVErrortype.mvError,
GetRuleStr(cRule01)), cRule01);
    AddToMap(Project.DefineRule(m_sCategoryID, EA.EnumMVErrortype.mvError,
GetRuleStr(cRule02)), cRule02);
    AddToMap(Project.DefineRule(m_sCategoryID, EA.EnumMVErrortype.mvError,
GetRuleStr(cRule03)), cRule03);
    // TODO: expand this list
}

public void RunConnectorRule(EA.Repository Repository, string sRuleID, long IConnectorID)
{
    EA.Connector Connector = Repository.GetConnectorByID((int)IConnectorID);
    if (Connector != null)
    {
        switch (LookupMapEx(sRuleID))
        {
            case cRule02:
                // TODO: perform rule 2 check
                break;
            // TODO: add more cases
        }
    }
}

public void RunDiagramRule(EA.Repository Repository, string sRuleID, long IDiagramID)
{
    EA.Diagram Diagram = Repository.GetDiagramByID((int)IDiagramID);
    if (Diagram != null)
    {
        switch (LookupMapEx(sRuleID))
        {
            case cRule03:
                // TODO: perform rule 3 check
                break;
            // TODO: add more cases
        }
    }
}

public void RunElementRule(EA.Repository Repository, string sRuleID, EA.Element Element)
{
    if (Element != null)
    {
        switch (LookupMapEx(sRuleID))
        {
            case cRule01:
                DoRule01(Repository, Element);
                break;
            // TODO: add more cases
        }
    }
}

private void DoRule01(EA.Repository Repository, EA.Element Element)
{
    if (Element.Stereotype != "myStereotype")
        return;
}

```

```

// TODO: validation logic here

// report validation errors
EA.Project Project = Repository.GetProjectInterface();
Project.PublishResult(LookupMap(cRule01), EA.EnumMVErrorType.mvError,
GetRuleStr(cRule01));
    }
}
}

```

### 11.3.5.16 EA\_OnRetrieveModelTemplate

#### Details

*EA\_OnRetrieveModelTemplate* requests that an Add-In pass a model template to Enterprise Architect.

This event occurs when a user executes the **Add a New Model Using Wizard** command to add a model that has been defined by an MDG Technology. See the [Incorporate Model Templates](#)<sup>[1146]</sup> topic for details of how to define such model templates.

#### Syntax

**Function EA\_OnRetrieveModelTemplate(Repository As EA.Repository,sLocation As String) As String**

The *EA\_OnRetrieveModelTemplate* function syntax contains the following elements:

Parameter	Type	Direction	Description
Repository	<a href="#">EA.Repository</a> <sup>[1680]</sup>	IN	An <i>EA.Repository</i> object representing the currently open Enterprise Architect model. Poll its members to retrieve model data and user interface status information.
sLocation	String	IN	The name of the template requested. This should match the <i>location</i> attribute in the <ModelTemplates> section of an MDG Technology File. For more information, see the <i>Incorporate Model Templates in a Technology</i> topic.

#### Return Value

Return a string containing the XML export of the model that is being used as a template.

#### Example

```

Public Function EA_OnRetrieveModelTemplate(ByRef Rep As EA.Repository, ByRef sLocation As String) As String
    Dim sTemplate As String
    Select Case sLocation
        Case "Templates\Template1.xml"
            sTemplate = My.Resources.Template1
        Case "Templates\Template2.xml"
            sTemplate = My.Resources.Template2
        Case "Templates\Template3.xml"
            sTemplate = My.Resources.Template3
        Case Else
            MsgBox("Path for " & sLocation & " not found")
            sTemplate = ""
    End Select
    EA_OnRetrieveModelTemplate = sTemplate
End Function

```

### 11.3.6 Custom Views

Enterprise Architect enables custom windows to be inserted as tabs in the **Diagram View** that appears at the center of the Enterprise Architect frame.

[Creating a custom view](#)<sup>[1621]</sup> enables you to easily and quickly tab between a custom interface and diagrams and other views normally provided by Enterprise Architect.

Uses for this facility include:

- Reports and graphs showing summary data of the model



- Alternative views of a diagram
- Alternative views of the model
- Views of external data related to model data
- Documentation tools.

### 11.3.6.1 Create a Custom View

A custom view must be designed as an ActiveX custom control and inserted through the automation interface.

ActiveX custom controls can be created using most well-known programming tools including Microsoft Visual Studio.NET. See the documentation provided by the relevant vendor on how to create a custom control to produce an OCX file.

Once the custom control has been created and registered on the target system, it can be added through the **AddTab()** method of the [Repository](#)<sup>[1688]</sup> object.

While it is possible to call **AddTab()** from any automation client, it is likely that you would call it from an Add-In, and that Add-In is defined in the same OCX that provides the custom view.

Example C# code is shown below:

```
public class Addin
{
    UserControl1 m_MyControl;

    public void EA_Connect(EA.Repository Rep)
    {
    }

    public object EA_GetMenuItems(EA.Repository Repository, string Location, string MenuName)
    {
        if( MenuName == "" )
            return "-&C# Control Demo";
        else
        {
            String[] ret = {"&Create", "&Show Button"};
            return ret;
        }
    }

    public void EA_MenuClick(EA.Repository Rep, string Location, string MenuName, string ItemName)
    {
        if( ItemName == "&Create" )
            m_MyControl = (UserControl1) Rep.AddTab("C# Demo","ContDemo.UserControl1");
        else
            m_MyControl.ShowButton();
    }
}
```

### 11.3.7 MDG Add-Ins

MDG Add-Ins are specialized types of Add-Ins that have additional features and extra requirements for Add-In authors who want to contribute to Enterprise Architect's goal of Model Driven Generation. Unlike general Add-In events, MDG Add-In events are only sent to the Add-In that has taken ownership of an Enterprise Architect model branch on a particular PC.

One of the additional responsibilities of an MDG Add-In is to take ownership of a branch of an Enterprise Architect model, which is done through the [MDG\\_Connect](#)<sup>[1822]</sup> event.

MDG Add-Ins identify themselves as such during [EA\\_Connect](#)<sup>[1782]</sup> by returning the string *MDG*.

Unlike ordinary Add-Ins, responding to MDG Add-In events is not optional, and methods must be published for each of the [MDG Events](#)<sup>[1822]</sup>.

Two examples of MDG Add-Ins are the commercially available *MDG Link for Eclipse* and *MDG Link for Visual Studio*, published by [Sparx Systems](#).

### 11.3.7.1 MDG Events

An MDG Add-In must respond to all MDG Events. These events usually identify processes such as Build, Run, Synchronize, PreMerge and PostMerge, amongst others.

An MDG Link Add-In is expected to implement some form of forward and reverse engineering capability within Enterprise Architect, and as such requires access to a specific set of events, all to do with generation, synchronization and general processes concerned with converting models to code and code to models.

- [MDG\\_BuildProject](#)<sup>[1822]</sup>
- [MDG\\_Connect](#)<sup>[1822]</sup>
- [MDG\\_Disconnect](#)<sup>[1823]</sup>
- [MDG\\_GetConnectedPackages](#)<sup>[1824]</sup>
- [MDG\\_GetProperty](#)<sup>[1824]</sup>
- [MDG\\_Merge](#)<sup>[1825]</sup>
- [MDG\\_NewClass](#)<sup>[1826]</sup>
- [MDG\\_PostGenerate](#)<sup>[1827]</sup>
- [MDG\\_PostMerge](#)<sup>[1827]</sup>
- [MDG\\_PreGenerate](#)<sup>[1828]</sup>
- [MDG\\_PreMerge](#)<sup>[1828]</sup>
- [MDG\\_PreReverse](#)<sup>[1829]</sup>
- [MDG\\_RunExe](#)<sup>[1830]</sup>
- [MDG\\_View](#)<sup>[1830]</sup>

#### 11.3.7.1.1 MDGBuild Project

##### Details

*MDG\_BuildProject* enables the Add-In to handle file changes caused by generation. This function is called in response to a user selecting the **Add-Ins | Build Project** menu option.

Respond to this event by compiling the project source files into a running application.

Also look at [MDG\\_RunExe](#)<sup>[1830]</sup>.

##### Syntax

**Sub MDG\_BuildProject(Repository As EA.Repository, PackageGuid As String)**

The *MDG\_BuildProject* function syntax contains the following elements:

Parameter	Type	Direction	Description
PackageGuid	String	IN	The GUID identifying the Enterprise Architect package subtree that is controlled by the Add-In.
Repository	<a href="#">EA.Repository</a> <sup>[1680]</sup>	IN	An <i>EA.Repository</i> object representing the currently open Enterprise Architect model. Poll its members to retrieve model data and user interface status information.

##### Return Value

None.

#### 11.3.7.1.2 MDGConnect

##### Details

*MDG\_Connect* enables the Add-In to handle user driven request to connect a model branch to an external application. This function is called when the user attempts to connect a particular Enterprise Architect package to an as yet unspecified external project. This event enables the Add-In to interact with the user to specify such a project.

The Add-In is responsible for retaining the connection details, which should be stored on a per-user or per-workstation basis. That is, users who share a common Enterprise Architect model over a network should be able to connect and disconnect to external projects independently of one another.

The Add-In should therefore not store connection details in an Enterprise Architect repository. A suitable place to store such details would be:

```
SHGetFolderPath(..CSIDL_APPDATA..)AddinName.
```

The *PackageGuid* parameter is the same identifier as required for most events relating to the MDG Add-In. Therefore it is recommended that the connection details be indexed using the *PackageGuid* value.

The *PackageID* parameter is provided to aid fast retrieval of package details from Enterprise Architect, should this be required.

Also look at [MDG\\_Disconnect](#)<sup>[1823]</sup>.

## Syntax

**Function** MDG\_Connect(*Repository As EA.Repository, PackageID as Long, PackageGuid As String*) **As Long**

The *MDG\_Connect* function syntax contains the following elements:

Parameter	Type	Direction	Description
<b>PackageGuid</b>	<i>String</i>	IN	The unique ID identifying the project provided by the Add-In when a connection to a project branch of an Enterprise Architect model was first established.
<b>PackageID</b>	<i>Long</i>	IN	The <i>PackageID</i> of the Enterprise Architect package the user has requested to have connected to an external project.
<b>Repository</b>	<a href="#">EA.Repository</a> <sup>[1680]</sup>	IN	An <i>EA.Repository</i> object representing the currently open Enterprise Architect model. Poll its members to retrieve model data and user interface status information.

## Return Value

Returns a non-zero to indicate that a connection has been made; a zero indicates that the user has not nominated a project and connection should not proceed.

### 11.3.7.1.3 MDGDisconnect

## Details

*MDG\_Disconnect* enables the Add-In to respond to user requests to disconnect the model branch from an external project. This function is called when the user attempts to disconnect an associated external project. The Add-In is required to delete the details of the connection.

Also look at [MDG\\_Connect](#)<sup>[1822]</sup>.

## Syntax

**Function** MDG\_Disconnect(*Repository As EA.Repository, PackageGuid As String*) **As Long**

The *MDG\_Disconnect* function syntax contains the following elements:

Parameter	Type	Direction	Description
<b>PackageGuid</b>	<i>String</i>	IN	The GUID identifying the Enterprise Architect package sub-tree that is controlled by the Add-In.
<b>Repository</b>	<a href="#">EA.Repository</a> <sup>[1680]</sup>	IN	An <i>EA.Repository</i> object representing the currently open Enterprise Architect model. Poll its members to retrieve model data and user interface status information.

## Return Value

Returns a non-zero to indicate that a disconnection has occurred enabling Enterprise Architect to update the user interface. A zero indicates that the user has not disconnected from an external project.

### 11.3.7.1.4 MDGGetConnectedPackages

#### Details

*MDG\_GetConnectedPackages* enables the Add-In to return a list of current connection between Enterprise Architect and an external application. This function is called when the Add-In is first loaded, and is expected to return a list of the available connections to external projects for this Add-In.

Also look at [MDG\\_Connect](#)<sup>[1822]</sup>.

#### Syntax

**Function** *MDG\_GetConnectedPackages(Repository As EA.Repository) As Variant*

The *MDG\_GetConnectedPackages* function syntax contains the following elements:

Parameter	Type	Direction	Description
Repository	<a href="#">EA.Repository</a> <sup>[1680]</sup>	IN	An <i>EA.Repository</i> object representing the currently open Enterprise Architect model. Poll its members to retrieve model data and user interface status information.

## Return Value

Returns an array of GUID strings representing individual Enterprise Architect packages.

### 11.3.7.1.5 MDGGetProperty

#### Details

*MDG\_GetProperty* provides miscellaneous Add-In details to Enterprise Architect. This function is called by Enterprise Architect to poll the Add-In for information relating to the *PropertyName*. This event should occur in as short a duration as possible as Enterprise Architect does not cache the information provided by the function.

Values corresponding to the following *PropertyNames* must be provided:

- **IconID** - Return the name of a DLL and a resource identifier in the format *#ResID*, where the resource ID indicates an Icon; for example, *c:\program files\myapp\myapp.dll#101*
- **Language** - Return the default language that Classes should be assigned when they are created in Enterprise Architect
- **HiddenMenus** - Return one or more values from the *MDGMenus* enumeration to hide menus that do not apply to your Add-In. For example:

```
if( PropertyName == "HiddenMenus" )
    return mgBuildProject + mgRun;
```

#### Syntax

**Function** *MDG\_GetProperty(Repository As EA.Repository, PackageGuid As String, PropertyName As String) As Variant*

The *MDG\_GetProperty* function syntax contains the following elements:

Parameter	Type	Direction	Description
PackageGuid	<i>String</i>	IN	The GUID identifying the Enterprise Architect package sub-tree that is controlled by the Add-In.
PropertyNam	<i>String</i>	IN	The name of the property that is used by Enterprise Architect. See <i>Details</i> for the possible values.

Parameter	Type	Direction	Description
e			
Repository	<a href="#">EA.Repository</a> <small>[1680]</small>	IN	An <i>EA.Repository</i> object representing the currently-open Enterprise Architect model. Poll its members to retrieve model data and user interface status information.

## Return Value

See *Details*, above.

### 11.3.7.1.6 MDGMerge

## Details

*MDG\_Merge* enables the Add-In to jointly handle changes to both the model branch and the code project that the model branch is connected to. This event should be called whenever the user has asked to merge their model branch with its connected code project, or whenever the user has established a new connection to a code project. The purpose of this event is to enable the Add-In to interact with the user to perform a merge between the model branch and the connected project.

Also look at [MDG\\_Connect](#)[1822], [MDG\\_PreMerge](#)[1828] and [MDG\\_PostMerge](#)[1827].

## Syntax

***Function MDG\_Merge(Repository As EA.Repository, PackageGuid As String, SynchObjects As Variant, SynchType As String, ExportObjects As Variant, ExportFiles As Variant, ImportFiles As Variant, IgnoreLocked As String, Language As String) As Long***

The *MDG\_Merge* function syntax contains the following elements:

Parameter	Type	Direction	Description
ExportFiles	<i>Variant</i>	OUT	A string array containing the list of files for each model object chosen for export by the Add-In. Each entry in this array must have a corresponding entry in the <i>ExportObjects</i> parameter at the same array index, so <i>ExportFiles(2)</i> must contain the filename of the object by <i>ExportObjects(2)</i> .
ExportObjects	<i>Variant</i>	OUT	The string array containing the list of new model objects (in <i>Object ID</i> format) to be exported by Enterprise Architect to the code project.
IgnoreLocked	<i>String</i>	OUT	A value indicating whether to ignore any files locked by the code project (that is, "TRUE" or "FALSE").
ImportFiles	<i>Variant</i>	OUT	A string array containing the list of code files made available to the code project to be newly imported to the model. Enterprise Architect imports each file listed in this array for import into the connected model branch.
Language	<i>String</i>	OUT	The string value containing the name of the code language supported by the code project connected to the model branch.
PackageGuid	<i>String</i>	IN	The GUID identifying the Enterprise Architect package sub-tree that is controlled by the Add-In.
Repository	<a href="#">EA.Repository</a> <small>[1680]</small>	IN	An <i>EA.Repository</i> object representing the currently open Enterprise Architect model. Poll its members to retrieve model data and user interface status information.
SynchObjects	<i>Variant</i>	OUT	A string array containing a list of objects ( <i>Object ID</i> format) to be jointly synchronized between the model branch and the project. See <a href="#">below</a> <small>[1825]</small> for the format of the Object IDs.

Parameter	Type	Direction	Description
<b>SynchType</b>	<i>String</i>	OUT	The value determining the user-selected type of synchronization to take place. See <a href="#">below</a> <sup>[1826]</sup> for a list of valid values.

## Return Value

Return a non-zero if the merge operation completed successfully and a zero value when the operation has been unsuccessful.

## Merge

A merge consists of three major operations:

- **Export:** Where newly created model objects are exported into code and made available to the code project.
- **Import:** Where newly created code objects, Classes and such things are imported into the model.
- **Synchronize:** Where objects available both to the model and in code are jointly updated to reflect changes made in either the model, code project or both.

## Synchronize Type

The *Synchronize* operation can take place in one of four different ways. Each of these ways corresponds to a value returned by *SynchType*:

- None: (*SynchType* = 0) No synchronization is to be performed
- Forward: (*SynchType* = 1) Forward synchronization, between the model branch and the code project is to occur
- Reverse: (*SynchType* = 2) Reverse synchronization, between the code project and the model branch is to occur
- Both: (*SynchType* = 3) Reverse, then Forward synchronization's are to occur.

## Object ID Format

Each of the Object IDs listed in the string arrays described above should be composed in the following format:

(@namespace)\*(#class)\*(\$attribute|%operation|:property)\*

### 11.3.7.1.7 MDGNewClass

## Details

*MDG\_NewClass* enables the Add-In to alter details of a Class before it is created.

This method is called when Enterprise Architect generates a new Class, and requires information relating to assigning the language and file path. The file path should be passed back as a return value and the language should be passed back via the language parameter.

Also look at [MDG\\_PreGenerate](#) <sup>[1828]</sup>.

## Syntax

**Function** *MDG\_NewClass*(*Repository As EA.Repository, PackageGuid As String, CodeID As String, Language As String*) *As String*

The *MDG\_NewClass* function syntax contains the following elements:

Parameter	Type	Direction	Description
<b>CodeID</b>	<i>String</i>	IN	A string used to identify the code element before it is created, for more information see <a href="#">MDG_View</a> <sup>[1830]</sup> .
<b>Language</b>	<i>String</i>	OUT	A string used to identify the programming language for the new Class. The language must be supported by Enterprise Architect.
<b>PackageGui</b>	<i>String</i>	IN	The GUID identifying the Enterprise Architect package sub-tree

Parameter	Type	Direction	Description
d			that is controlled by the Add-In.
Repository	<a href="#">EA.Repository</a> <small>[1680]</small>	IN	An <i>EA.Repository</i> object representing the currently open Enterprise Architect model. Poll its members to retrieve model data and user interface status information.

## Return Value

Returns a string containing the file path that should be assigned to the Class.

### 11.3.7.1.8 MDGPostGenerate

#### Details

*MDG\_PostGenerate* enables the Add-In to handle file changes caused by generation.

This event is called after Enterprise Architect has prepared text to replace the existing contents of a file. Responding to this event enables the Add-In to write to the linked application's user interface rather than modify the file directly.

When the contents of a file are changed, Enterprise Architect passes *FileContents* as a non-empty string. New files created as a result of code generation are also sent through this mechanism, enabling Add-Ins to add new files to the linked project's file list.

When new files are created Enterprise Architect passes *FileContents* as an empty string. When a non-zero is returned by this function, the Add-In has successfully written the contents of the file. A zero value for the return indicates to Enterprise Architect that the file must be saved.

Also look at [MDG\\_PreGenerate](#) [1828].

#### Syntax

**Function** *MDG\_PostGenerate*(*Repository As EA.Repository, PackageGuid As String, FilePath As String, FileContents As String*) *As Long*

The *MDG\_PostGenerate* function syntax contains the following elements:

Parameter	Type	Direction	Description
FileContents	<i>String</i>	IN	A string containing the proposed contents of the file.
FilePath	<i>String</i>	IN	The path of the file Enterprise Architect intends to overwrite.
PackageGuid	<i>String</i>	IN	The GUID identifying the Enterprise Architect package sub-tree that is controlled by the Add-In.
Repository	<a href="#">EA.Repository</a> <small>[1680]</small>	IN	An <i>EA.Repository</i> object representing the currently open Enterprise Architect model. Poll its members to retrieve model data and user interface status information.

## Return Value

Return value depends on the type of event that this function is responding to (see **Details**, above). This function is required to handle two separate and distinct cases.

### 11.3.7.1.9 MDGPostMerge

#### Details

*MDG\_PostMerge* is called after a merge process has been completed.

This function is called by Enterprise Architect after the merge process has been completed.

**Note:**

File save checking should not be performed with this function, but should be handled by [MDG\\_PreGenerate](#)<sup>[1828]</sup>, [MDG\\_PostGenerate](#)<sup>[1827]</sup> and [MDG\\_PreReverse](#)<sup>[1829]</sup>.

Also look at [MDG\\_PreMerge](#)<sup>[1828]</sup> and [MDG\\_Merge](#)<sup>[1825]</sup>.

**Syntax**

**Function MDG\_PostMerge(Repository As EA.Repository, PackageGuid As String) As Long**

The *MDG\_PostMerge* function syntax contains the following elements:

Parameter	Type	Direction	Description
Repository	<a href="#">EA.Repository</a> <sup>[1680]</sup>	IN	An <i>EA.Repository</i> object representing the currently open Enterprise Architect model. Poll its members to retrieve model data and user interface status information.
PackageGuid	String	IN	The GUID identifying the Enterprise Architect package sub-tree that is controlled by the Add-In.

**Return Value**

Return a zero value if the post-merge process has failed, a non-zero return indicates that the post-merge has been successful. Enterprise Architect assumes a non-zero return if this method is not implemented

**11.3.7.1.10 MDGPreGenerate****Details**

*MDG\_PreGenerate* enables the Add-In to deal with unsaved changes. This function is called immediately before Enterprise Architect attempts to generate files from the model. A possible use of this function would be to prompt the user to save unsaved source files.

Also look at [MDG\\_PostGenerate](#)<sup>[1827]</sup>.

**Syntax**

**Function MDG\_PreGenerate(Repository As EA.Repository, PackageGuid As String) As Long**

The *MDG\_PreGenerate* function syntax contains the following elements:

Parameter	Type	Direction	Description
Repository	<a href="#">EA.Repository</a> <sup>[1680]</sup>	IN	An <i>EA.Repository</i> object representing the currently open Enterprise Architect model. Poll its members to retrieve model data and user interface status information.
PackageGuid	String	IN	The GUID identifying the Enterprise Architect package sub-tree that is controlled by the Add-In.

**Return Value**

Return a zero value to abort generation. Any other value enables the generation to continue.

**11.3.7.1.11 MDGPreMerge****Details**

*MDG\_PreMerge* is called after a merge process has been initiated by the user and before Enterprise Architect performs the merge process.

This event is called after a user has performed their interactions with the merge screen and has confirmed the merge with the **OK** button, but before Enterprise Architect performs the merge process using the data



provided by the *MDG\_Merge* call, before any changes have been made to the model or the connected project. This event is made available to provide the Add-In with the opportunity to generally set internal Add-In flags to augment the *MDG\_PreGenerate*, *MDG\_PostGenerate* and *MDG\_PreReverse* events.

#### Note:

File save checking should not be performed with this function, but should be handled by [MDG\\_PreGenerate](#)<sup>[1828]</sup>, [MDG\\_PostGenerate](#)<sup>[1827]</sup> and [MDG\\_PreReverse](#)<sup>[1829]</sup>.

Also look at [MDG\\_Merge](#)<sup>[1825]</sup> and [MDG\\_PostMerge](#)<sup>[1827]</sup>.

## Syntax

**Function** *MDG\_PreMerge(Repository As EA.Repository, PackageGuid As String) As Long*

The *MDG\_PreMerge* function syntax contains the following elements:

Parameter	Type	Direction	Description
Repository	<a href="#">EA.Repository</a> <sup>[1680]</sup>	IN	An <i>EA.Repository</i> object representing the currently open Enterprise Architect model. Poll its members to retrieve model data and user interface status information.
PackageGuid	String	IN	The GUID identifying the Enterprise Architect package sub-tree that is controlled by the Add-In.

## Return Value

A return value of zero indicates that the merge process will not occur. If the value is not zero the merge process will proceed. If this method is not implemented then it is assumed that a merge process is used.

### 11.3.7.1.12 MDGPreReverse

#### Details

*MDG\_PreReverse* enables the Add-In to save file changes before being imported into Enterprise Architect.

This function operates on a list of files that are about to be reverse-engineered into Enterprise Architect. If the user is working on unsaved versions of these files in an editor, you could either prompt the user or save automatically.

Also look at [MDG\\_PostGenerate](#)<sup>[1827]</sup> and [MDG\\_PreGenerate](#)<sup>[1828]</sup>.

## Syntax

**Sub** *MDG\_PreReverse(Repository As EA.Repository, PackageGuid As String, FilePaths As Variant)*

The *MDG\_PreReverse* function syntax contains the following elements:

Parameter	Type	Direction	Description
Repository	<a href="#">EA.Repository</a> <sup>[1680]</sup>	IN	An <i>EA.Repository</i> object representing the currently open Enterprise Architect model. Poll its members to retrieve model data and user interface status information.
PackageGuid	String	IN	The GUID identifying the Enterprise Architect package sub-tree that is controlled by the Add-In.
FilePaths	String array	IN	An array of filepaths pointed to the files that are to be reverse engineered.

## Return Value

None.

### 11.3.7.1.13 MDGRunExe

#### Details

*MDG\_RunExe* enables the Add-In to run the target application. This function is called when the user selects the **Add-Ins | Run Exe** menu option. Respond to this event by launching the compiled application.

Also look at [MDG\\_BuildProject](#)<sup>[1822]</sup>.

#### Syntax

**Sub MDG\_RunExe(Repository As EA.Repository, PackageGuid As String)**

The *MDG\_RunExe* function syntax contains the following elements:

Parameter	Type	Direction	Description
Repository	<a href="#">EA.Repository</a> <sup>[1880]</sup>	IN	An <i>EA.Repository</i> object representing the currently open Enterprise Architect model. Poll its members to retrieve model data and user interface status information.
PackageGuid	String	IN	The GUID identifying the Enterprise Architect package sub-tree that is controlled by the Add-In.

#### Return Value

None.

### 11.3.7.1.14 MDGView

#### Details

*MDG\_View* enables the Add-In to display user specified code elements. This function is called by Enterprise Architect when the user asks to view a particular code element. This enables the Add-In to present that element in its own way, usually in a code editor.

#### Syntax

**Function MDG\_View(Repository As EA.Repository, PackageGuid As String, CodeID as String) As Long**

The *MDG\_View* function syntax contains the following elements:

Parameter	Type	Direction	Description
Repository	<i>EA.Repository</i>	IN	An <i>EA.Repository</i> object representing the currently open Enterprise Architect model. Poll its members to retrieve model data and user interface status information.
PackageGuid	String	IN	The GUID identifying the Enterprise Architect package sub-tree that is controlled by the Add-In.
CodeID	String	IN	Identifies the code element in the following format: <type>ElementPart<type>ElementPart... where each element is preceded with a token identifying its type: @ - namespace # - Class \$ - attribute % - operation  For example if a user has selected the <i>m_Name</i> attribute of <i>Class1</i> located in <i>namespace Name1</i> , the <i>class ID</i> would be passed through in the following format:

Parameter	Type	Direction	Description
			@Name1#Class1%m_Name

### Return Value

Return a non-zero value to indicate that the Add-In has processed the request. Returning a zero value results in Enterprise Architect employing the standard viewing process which is to launch the associated source file.

**Part**

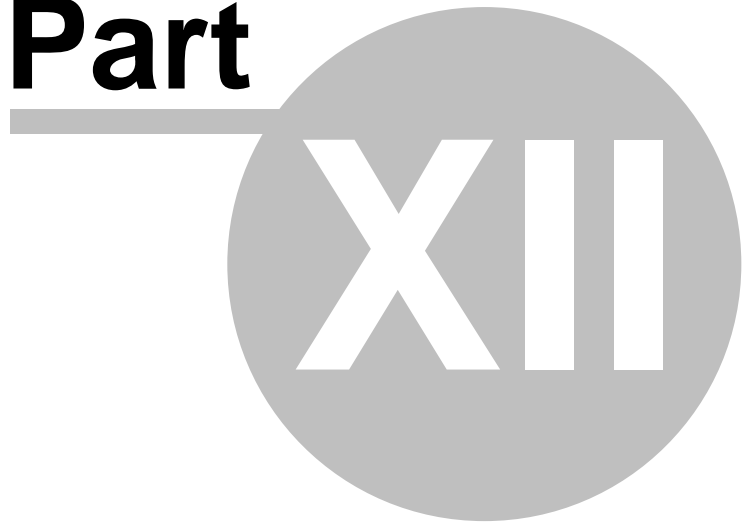

**XII**

## 12 Glossary of Terms

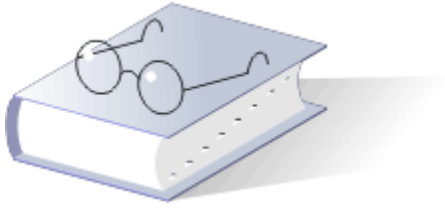

This topic provides a detailed glossary for Enterprise Architect.

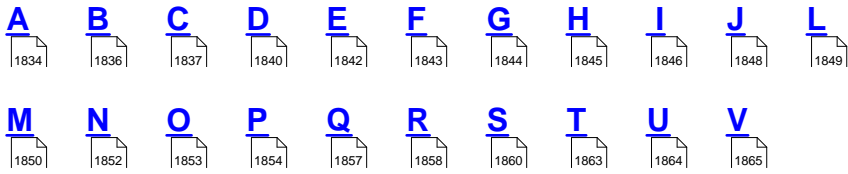

## 12.1 A

**abstract class**

A Class that cannot be directly instantiated.

*Contrast:* concrete class

**abstraction**

The essential characteristics of an entity that distinguish it from all other kinds of entities. An abstraction defines a boundary relative to the perspective of the viewer.

**action**

The specification of an executable statement that forms an abstraction of a computation procedure. An action typically results in a change in the state of the system, and can be realized by sending a message to an object or modifying a connector or a value of an attribute.

**action sequence**

An expression that resolves to a sequence of actions.

**action state**

A state that represents the execution of an atomic action, typically the invocation of an operation.

**activation**

The execution of an action.

**active class**

A Class whose instances are active objects. When instantiated, an active Class controls its execution. Rather than being invoked or activated by other objects, it can operate standalone, and define its own thread of behavior.

*See also:* active object

**active object**

An object that owns a thread and can initiate control activity. An instance of active Class.

*See also:* active class, thread

**activity**

Defines the bounds for the structural organization that contains a set of basic or fundamental behaviors. It can be used to model procedural type application development for system design through to modeling business processes in organizational structures and work flow.

**activity diagram**

A diagram used to model procedural type application development for system design through to modeling business processes in organizational structures and work flow.

**activity graph**

A special case of a State Machine that is used to model processes involving one or more classifiers.

*Contrast:* state chart diagram

**actor [class]**

A coherent set of roles that users of Use Cases play when interacting with these Use Cases. An Actor has one role for each Use Case with which it communicates.

**actual parameter**

A binding for a parameter that resolves to a run-time instance.

*Synonym:* argument

*Contrast:* (formal) parameter

**aggregate [class]**

A Class that represents the 'whole' in an Aggregation (whole-part) relationship.

*See also:* aggregation

**aggregation**

A special form of Association that specifies a whole-part relationship between the Aggregate (whole) and a component part.

*See also:* composition

**analysis**

The part of the software development process whose primary purpose is to formulate a model of the

problem domain. Analysis focuses on what to do, design focuses on how to do it.

*Contrast:* design

**analysis diagram**

A diagram used to capture high level business processes and early models of system behavior and elements. It is less formal than some other diagrams, but provides a good means of capturing the essential business characteristics and requirements.

**analysis time**

Refers to something that occurs during an analysis phase of the software development process.

*See also:* modeling time, run time, compile time

*Contrast:* design time

**architecture**

The organizational structure and associated behavior of a system. An architecture can be recursively decomposed into parts that interact through interfaces, relationships that connect parts, and constraints for assembling parts. Parts that interact through interfaces include Classes, Components and subsystems.

**argument**

A binding for a parameter that resolves to a run-time instance.

*Synonym:* actual parameter

*Contrast:* (formal) parameter

**artifact**

A physical piece of information that is used or produced by a business or development process. Examples of Artifacts include models, source files, scripts, and binary executable files. An Artifact can constitute the implementation of a deployable component.

*Synonym:* product

*Contrast:* component

**assembly**

A connector that bridges the required interface of a component with the provided interface of a second component.

**association**

The semantic relationship between two or more classifiers that specifies connections among their instances.

*See also:* link

**association class**

A model element that has both Association and Class properties. An Association Class can be seen as an Association that also has Class properties, or as a Class that also has Association properties.

*See also:* class

**association end**

The endpoint of an Association, which connects the Association to a classifier.

*See also:* classifier, link end

**attribute**

A feature within a classifier that describes a range of values that instances of the classifier can hold.

**auxiliary class**

A stereotyped Class that supports another more central or fundamental Class, typically by implementing secondary logic or control flow. Auxiliary Classes are typically used together with focus Classes, and are particularly useful for specifying the secondary business logic or control flow of components during design.

*See also:* focus class

## 12.2 B

**behavior**

The observable effects of an operation or event, including its results.

**behavioral diagram**

A diagram that depicts the behavioral features of a system or business process. Behavioral diagrams include Activity diagrams, State Machine diagrams, Communication diagrams, Interaction Overview diagrams, Sequence diagrams, Timing diagrams and Use Case diagrams.

**behavioral feature**

A dynamic feature of a model element, such as an operation or method.

**behavioral model aspect**

A model aspect that emphasizes the behavior of the instances in a system, including their methods, collaborations, and state histories.

**binary association**

An Association between two Classes. A special case of an N-ary Association.

*Contrast:* n-ary association

**binding**

The creation of a model element from a template by supplying arguments for the parameters of the template.

**bookmark**

A marker in a Rich Text Format document that enables you to link inner sections of a document into a master document (using the Word 'Insert File' function).

**boolean**

An enumeration whose values are true and false.

**boolean expression**

An expression that evaluates to a boolean value.

**boundary**

1. A stereotyped Class that models some system boundary – typically a user interface screen. It is used in the conceptual phase to capture user interaction with the system at a screen level (or some other boundary interface type). It is often used in Sequence and Robustness (Analysis) diagrams. It is the View in the Model-View-Controller pattern.
2. A System Boundary element is used to delineate a particular part of the system.



## 12.3 C

**C++**

An object-oriented programming language based on the earlier 'C' language.

**call**

An action state that invokes an operation on a classifier.

**cardinality**

The number of elements in a set.

*Contrast:* multiplicity

**CASE**

Computer Aided Software Engineering. A tool designed for the purpose of modeling and building software systems.

**child**

In a Generalization relationship, the specialization of another element, the parent.

*See also:* subclass, subtype

*Contrast:* parent

**choice**

A pseudo-state used to compose complex transitional paths, where the outgoing transition path is decided by dynamic, run-time conditions determined by the actions performed by the State Machine on the path leading to the choice.

**class**

A description of a set of objects that share the same attributes, operations, methods, relationships and semantics. A Class can use a set of interfaces to specify collections of operations it provides to its environment.

*See also:* interface, object

**class diagram**

A diagram that shows a collection of declarative (static) model elements, such as Classes, types, and their contents and relationships.

*See also:* object diagram

**classification**

The assignment of an object to a classifier.

*See also:* dynamic classification, multiple classification and static classification.

**classifier**

A mechanism that describes behavioral and structural features. Classifiers include Interfaces, Classes, datatypes, and components.

**client**

A classifier that requests a service from another classifier.

*Contrast:* supplier

**collaboration**

The specification of how an operation or classifier, such as a Use Case, is realized by a set of classifiers and Associations playing specific roles used in a specific way. The Collaboration defines an interaction.

*See also:* interaction

**collaboration diagram**

Used pre-UML 2.0. Now called a Communication diagram.

**collaboration occurrence**

Uses an Occurrence to apply a pattern defined by a Collaboration to a specific situation.

**combined fragment**

A combined fragment reflects a piece or pieces of interaction (called interaction operands) controlled by an interaction operator, whose corresponding boolean conditions are known as interaction constraints. It appears graphically as a transparent window, divided by horizontal dashed lines for each operand.

**comment**

An annotation attached to an element or a collection of elements. A comment, or note, has no semantics.

*Contrast:* constraint

**communication diagram**

A diagram that shows the interactions between elements at run-time in much the same manner as a Sequence diagram. However, Communication diagrams are used to visualize inter-object relationships, while Sequence diagrams are more effective at visualizing processing over time.

*See also:* collaboration diagram, object diagram

**compile time**

Refers to something that occurs during the compilation of a software module.

*See also:* modeling time, run time, analysis time, design time

**component**

A modular, deployable, and replaceable part of a system that encapsulates implementation and exposes a set of interfaces. A Component is typically specified by one or more classifiers (such as implementation Classes) that reside on it, and can be implemented by one or more artifacts (such as binary, executable, or script files).

*See also:* module

*Contrast:* artifact, product

**component diagram**

A diagram that shows the organizations and dependencies among Components.

**composite [class]**

A Class that is related to one or more Classes by a Composition relationship.

*See also:* composition

**composite state**

A State that consists of either concurrent (orthogonal) substates or sequential (disjoint) substates.

*See also:* substate, concurrent substate, disjoint substate

**composite structure diagram**

A diagram that reflects the internal collaboration of Classes, Interfaces, or Components to describe a functionality. Composite Structure diagrams are similar to Class diagrams, except that they model a specific usage of the structure.

**composition**

A form of Aggregation that requires that a part instance be included in at most one Composite at a time, and that the Composite object is responsible for the creation and destruction of the parts. Composition can be recursive.

*Synonym:* composite aggregation

*See also:* composite, aggregation

**concrete class**

A Class that can be directly instantiated.

*Contrast:* abstract class

**concurrency**

The occurrence of two or more activities during the same time interval. Concurrency can be achieved by interleaving or simultaneously executing two or more threads.

*See also:* thread

**concurrent substate**

A substate that can be held simultaneously with other substates contained in the same composite State.

*See also:* composite state

*Contrast:* disjoint substate

**connector**

A logical link between model elements. Can be structural, dynamic or possessive.

**constraint**

1. A semantic condition or restriction. Certain constraints are predefined in the UML, others can be user defined. Constraints are one of three extensibility mechanisms in UML.

See *also*: tagged value, stereotype

*Contrast*: comment

2. A rule or condition that applies to some element. It is often modeled as a pre- or post- condition.

***container***

1. An instance that exists to contain other instances, and that provides operations to access or iterate over its contents.(for example, arrays, lists, sets).

2. A component that exists to contain other components.

***containment hierarchy***

A namespace hierarchy consisting of model elements, and the containment relationships that exist between them. A containment hierarchy forms a graph.

***context***

A view of a set of related modeling elements for a particular purpose, such as specifying an operation.

***continuation***

A Continuation is used in *seq* and *alt* combined fragments, to indicate the branches of continuation an operand follows.

***control***

A stereotyped Class that represents a controlling entity or manager. A Control organizes and schedules other activities and elements. It is the controller of the Model-View-Controller pattern.

***control flow***

A connector linking two nodes in an activity diagram. Control Flow connectors start a node's activity when the preceding node's action is finished.

## 12.4 D

**database schema**

The description of a database structure. It defines tables and fields and the relationship between them.

**datastore**

An element used to define permanently stored data. A token of data that is stored in the Datastore is stored permanently. A token of data that comes out of the Datastore is a copy of the original data. The tokens imported are kept for the life of the Activity in which it exists.

**datatype**

A descriptor of a set of values that lack identity and whose operations do not have side effects. Datatypes include primitive pre-defined types and user-definable types. Pre-defined types include numbers, string and time. User-definable types include enumerations.

**decision**

An element of an Activity diagram that indicates a point of conditional progression: if a condition is true, then processing continues one way, if not, then another.

**defining model [MOF]**

The model on which a repository is based. Any number of repositories can have the same defining model.

**delegate**

A connector that defines the internal assembly of a component's external ports and interfaces. Using a Delegate connector wires the internal workings of the system to the outside world, by a delegation of the external interfaces' connections.

**delegation**

The ability of an object to issue a message to another object in response to a message. Delegation can be used as an alternative to inheritance.

*Contrast:* inheritance

**dependency**

A relationship between two modeling elements, in which a change to one modeling element (the independent element) affects the other modeling element (the dependent element).

**deployment**

A type of Dependency relationship that indicates the deployment of an artifact onto a node or executable target.

**deployment diagram**

A diagram that shows the configuration of run-time processing nodes and the components, processes, and objects that live on them. Components represent run-time manifestations of code units.

*See also:* component diagrams

**deployment specification**

Specifies parameters guiding deployment of an artifact, as is common with most hardware and software technologies.

**derived element**

A model element that can be computed from another element, but that is shown for clarity or that is included for design purposes even though it adds no semantic information.

**design**

The part of the software development process whose primary purpose is to decide how the system is to be implemented. During design, strategic and tactical decisions are made to meet the required functional and quality requirements of a system.

*Contrast:* analysis

**design time**

Refers to something that occurs during a design phase of the software development process.

*See also:* modeling time, run time, compile time

*Contrast:* analysis time

**development process**

A set of partially ordered steps performed for a given purpose during software development, such as constructing models or implementing models.

**diagram**

A graphical presentation of a collection of model elements, most often rendered as a connected graph of arcs (relationships) and vertices (other model elements). UML supports 14 diagram types, and Enterprise Architect extends these with seven more. Add-Ins, technologies and profiles can provide further diagram types.

**diagram gate**

A simple graphical way to indicate the point at which messages can be transmitted into and out of Interaction Fragments.

**diagram view**

The Enterprise Architect workspace area where the UML diagrams are displayed.

**disjoint substate**

A substate that cannot be held simultaneously with other substates contained in the same composite State.

*See also:* composite state, substate

*Contrast:* concurrent substate

**distribution unit**

A set of objects or components that are allocated to a process or a processor as a group. A distribution unit can be represented by a run-time composite or an Aggregate.

**domain**

An area of knowledge or activity characterized by a set of concepts and terminology understood by practitioners in that area.

**dynamic classification**

A semantic variation of Generalization in which an object can change its classifier.

*See also:* multiple classification

*Contrast:* static classification

## 12.5 E

**element**

1. An atomic constituent of a model.
2. A model object of any type, such as Class, Component, Node or Object.

**endpoint**

Used in Interaction diagrams to reflect a lost message in sequence.

**entity**

A store or persistence mechanism that captures the information or knowledge in a system. It is the Model in the Model-View-Controller pattern.

**entry action**

An action executed upon entering a state in a State Machine regardless of the transition taken to reach that state.

**entry point**

Used to define where external states can enter a Sub Machine.

**enumeration**

A list of named values used as the range of a particular attribute type. For example, RGBColor = {red, green, blue}. Boolean is a predefined enumeration with values from the set {false, true}.

**event**

The specification of a significant occurrence that has a location in time and space. In the context of State diagrams, an event is an occurrence that can trigger a transition.

**exception handler**

An element that defines the group of operations to carry out when an exception occurs.

**exit action**

An action executed upon exiting a State in a State Machine regardless of the transition taken to exit that State.

**exit point**

Used in Sub Machine states and State Machines to denote the point where the machine is exited and the transition sourcing this exit point, for Sub Machines, is triggered. Exit points are a type of pseudo-state used in the State Machine diagram.

**export**

In the context of packages, to make an element visible outside its enclosing namespace.

*See also:* visibility

*Contrast:* import

**expose interface**

A toolbox icon that is a graphical way to depict the required and supplied interfaces of a Component, Class or Part.

**expression**

A string that evaluates to a value of a particular type. For example, the expression  $(7 + 5 * 3)$  evaluates to a value of type number. A relationship from an extension Use Case to a base Use Case, specifying how the behavior defined for the extension Use Case augments (subject to conditions specified in the extension) the behavior defined for the base Use Case. The behavior is inserted at the location defined by the extension point in the base Use Case. The base Use Case does not depend on performing the behavior of the extension Use Case.

*See also:* extend, include

**extend**

A connector used to indicate that an element extends the behavior of another. Extensions are used in Use Case models to indicate one Use Case (optionally) extends the behavior of another.

*See also:* expression, include

## 12.6 F

**facade**

A stereotyped package containing only references to model elements owned by another package. It is used to provide a 'public view' of some of the contents of a package.

**feature**

A property, like operation or attribute, that is encapsulated within a classifier, such as an Interface, a Class, or a Datatype.

**final**

A pseudo-state that indicates an end.

**final state**

A special kind of State signifying that the enclosing composite State or the entire State Machine is completed.

**fire**

To execute a State transition.

See *also*: transition

**flow final**

An element that depicts an *exit* from the system, as opposed to the *Activity Final*, which represents the completion of the activity.

**focus class**

A stereotyped Class that defines the core logic or control flow for one or more auxiliary Classes that support it. Focus Classes are typically used together with one or more auxiliary Classes, and are particularly useful for specifying the core business logic or control flow of components during design.

See *also*: auxiliary class

**focus of control**

A symbol on a Sequence diagram that shows the period of time during which an object is performing an action, either directly or through a subordinate procedure.

**forward engineering**

The process of generating source code from the UML model.

**fork**

Used in State Machine diagrams as pseudo-states. With respect to State Machine diagrams, a Fork pseudo-state signifies that its incoming transition comes from a single State, and it has multiple outgoing transitions.

*Contrast*: join

**framework**

A stereotyped package containing model elements that specify a reusable architecture for all or part of a system. Frameworks typically include Classes, Patterns or templates. When frameworks are specialized for an application domain, they are sometimes referred to as Application frameworks.

See *also*: pattern

## 12.7 G

**generalizable element**

A model element that can participate in a Generalization relationship.

See *also*: generalization

**generalization**

A taxonomic relationship between a more general element and a more specific element. The more specific element is fully consistent with the more general element and contains additional information. An instance of the more specific element can be used where the more general element is allowed.

See *also*: generalizable element, inheritance

**guard condition**

A condition that must be satisfied in order to enable an associated transition to fire.



## 12.8 H

### *history state*

There are two types of History pseudo-states defined in UML: shallow History and deep History. A shallow History sub-state is used to represent the most recently active sub-state of a composite State. A deep History sub-state, in contrast, reflects the most recent active configuration of the composite State.

## 12.9 I

**implementation**

A definition of how something is constructed or computed. For example, a Class is an implementation of a type, a method is an implementation of an operation.

**implementation class**

A stereotyped Class that specifies the implementation of a Class in some programming language (for example, C++, Smalltalk, Java) in which an instance can not have more than one Class. An Implementation Class is said to realize a type if it provides all of the operations defined for the type with the same behavior as specified for the type's operations.

See also: type

**implementation inheritance**

The inheritance of the implementation of a more general element. Includes inheritance of the interface.

Contrast: interface inheritance

**import**

In the context of packages, a dependency that shows the packages whose Classes can be referenced within a given package (including packages recursively embedded within it).

See also: visibility

Contrast: export

**include**

A relationship from a base Use Case to an inclusion Use Case, specifying how the behavior for the base Use Case contains the behavior of the inclusion Use Case. The behavior is included at the location that is defined in the base Use Case. The base Use Case depends on performing the behavior of the inclusion Use Case, but not on its structure (that is, attributes or operations).

See also: extend, expression

**inheritance**

The mechanism by which more specific elements incorporate the structure and behavior of more general elements related by behavior.

See also: generalization

Contrast: delegation

**initial state**

A pseudo-state used to denote the default state of a composite State; there can be one initial vertex in each region of the composite State.

**instance**

An entity that has a unique identity, a set of operations that can be applied to it, and a state that stores the effects of the operations.

See also: object

**interaction**

A specification of how stimuli are sent between instances to perform a specific task. The interaction is defined in the context of a collaboration.

See also: collaboration

**interaction diagram**

A generic term that applies to several types of diagrams that emphasize object interactions. These include *Timing* diagrams, *Sequence* diagrams, *Interaction Overview* diagrams and *Communication* diagrams.

**interaction occurrence**

A reference to an existing interaction element. Interaction occurrences are visually represented by a frame, with **ref** in the frame's title space. The diagram name is indicated in the frame contents.

**interaction overview diagram**

A diagram that visualizes the cooperation between other Interaction diagrams to illustrate a control flow serving an encompassing purpose. As Interaction Overview diagrams are a variant of *Activity* diagrams, most of the diagram notation is similar, as is the process in constructing the diagram.

**interface**

A named set of operations that characterize the behavior of an element.

*See also:* class

*Contrast:* type

***interface inheritance***

The inheritance of the interface of a more general element. Does not include inheritance of the implementation.

*Contrast:* implementation inheritance

***internal transition***

A transition signifying a response to an event without changing the state of an object.

***interrupt flow***

An Enterprise Architect-defined toolbox icon used to define the exception handler and interruptible activity region concepts.

## 12.10 J

**Java**

A fully object-oriented, cross platform language based on elements from Smalltalk, C++ and other OO languages.

**join**

Used in State Machine diagrams and in Activity diagrams to synchronize multiple flows.

Contrast: *fork*

**junction**

Junction pseudo-states are used to design complex transitional paths. A Junction can be used to combine, or merge, multiple paths into a shared transition path or to split an incoming path into multiple paths.

## 12.11 L

**layer**

The organization of classifiers or packages at the same level of abstraction. A layer represents a horizontal slice through an architecture, whereas a partition represents a vertical slice.

*Contrast:* partition

**lifeline**

An individual participant in an interaction (that is, Lifelines cannot have multiplicity). A Lifeline represents a distinct connectable element.

**link**

A semantic connector among a tuple of objects. An instance of an Association.

*See also:* association

**link end**

An instance of an Association end.

*See also:* association end, classifier

**local path**

A relative path on a local machine, enabling developers to store shared source code in machine specific directories, but still generate and synchronize code.

## 12.12 M

***maintenance***

The support of a software system after it is deployed.

***manifest***

A relationship that indicates that the artifact source embodies the target model element. Stereotypes can be added to Enterprise Architect to classify the type of manifestation of the model element.

***message***

Messages indicate a flow of information, or transition of control, between elements. Messages are used by Communication diagrams, Sequence diagrams, Interaction Overview diagrams and Timing diagrams.

***message endpoint***

An element that defines an endpoint of a Lifeline, such as a State or Value Lifeline in a Timing diagram.

***message label***

Used for messages sent between Lifelines to make the diagram appear less cluttered. Labels with the same name indicate that a message can be interrupted.

***metaclass***

A Class whose instances are Classes. Metaclasses are typically used to construct metamodels.

***metafile***

A vector-based image format native to Windows. Supports high detail and excellent scaling. Typically used for saving diagram images for placement in documents. Comes in Placeable (an older format) and Enhanced (current standard format).

***meta-metamodel***

A model that defines the language for expressing a metamodel. The relationship between a meta-metamodel and a metamodel is analogous to the relationship between a metamodel and a model.

***metamodel***

A model that defines the language for expressing a model.

***meta-object***

A generic term for all meta-entities in a meta-modeling language. For example, meta-types, meta-classes, meta-attributes, and meta-associations.

***Meta-Object Facility (MOF)***

An Object Management Group (OMG) standard. MOF originated in the UML, when the OMG required a Meta-Modeling architecture to define the UML. MOF is designed as a four-layered architecture.

***method***

The implementation of an operation. It specifies the algorithm or procedure associated with an operation.

***model [MOF]***

An abstraction of a physical system with a certain purpose.

*See also:* physical system

*Usage note:* In the context of the MOF specification, which describes a meta-metamodel, the meta-metamodel is for brevity frequently referred to simply as the model.

***model aspect***

A dimension of modeling that emphasizes particular qualities of the metamodel. For example, the structural model aspect emphasizes the structural qualities of the metamodel.

***model elaboration***

The process of generating a repository type from a published model. Includes the generation of interfaces and implementations which enables repositories to be instantiated and populated based on, and in compliance with, the model elaborated.

***model element [MOF]***

An element that is an abstraction drawn from the system being modeled.

*Contrast:* view element; in the MOF specification model elements are considered to be meta-objects.

***model library***

A stereotyped package containing model elements that are intended to be reused by other packages. A

model library differs from a profile in that a model library does not extend the metamodel using stereotypes and tagged definitions. A model library is analogous to a Class library in some programming languages.

**modeling time**

Refers to something that occurs during the modeling phase of the software development process. It includes analysis time and design time.

*Usage note:* When discussing object systems, it is often important to distinguish between modeling-time and run-time concerns.

*See also:* analysis time, design time, compile time

*Contrast:* run time

**module**

A software unit of storage and manipulation. Modules include source code modules, binary code modules and executable code modules.

*See also:* component

**MOF**

Meta-Object Facility, an Object Management Group (OMG) standard. MOF originated in the UML, when the OMG required a Meta-Modeling architecture to define the UML. MOF is designed as a four-layered architecture.

**multiple classification**

A semantic variation of Generalization in which an object can belong directly to more than one classifier.

*See also:* static classification, dynamic classification

**multiple inheritance**

A semantic variation of Generalization in which a type can have more than one supertype.

*Contrast:* single inheritance

**multiplicity**

A specification of the range of enableable cardinalities that a set can assume. Multiplicity specifications can be given for roles within Associations, Parts within Composites, repetitions and other purposes. Essentially a multiplicity is a (possibly infinite) subset of the non-negative integers.

*Contrast:* cardinality

**multi-valued [MOF]**

A model element with multiplicity defined whose *Multiplicity Type::* upper attribute is set to a number greater than one. The term multi-valued does not pertain to the number of values held by, for example, an attribute or parameter, at any point in time.

*Contrast:* single-valued

## 12.13 N

**name**

A string used to identify a model element.

**namespace**

A part of the model in which the names can be defined and used. Within a namespace, each name has a unique meaning.

*See also:* name

**n-ary association**

An Association among three or more Classes. Each instance of the Association is an n-tuple of values from the respective Classes.

*Contrast:* binary association

**nesting**

A connector used as an alternative membership notation to indicate nested members within an element; for example, a package that has nested members. The nested members of a package could also be shown inside the package rather than linked by the Nesting connector.

**node**

A classifier that represents a run-time computation resource, which generally has at least a memory and often processing capability. Run-time objects and components can reside on nodes.



## 12.14 O

**object**

An entity with a well-defined boundary and identity that encapsulates state and behavior. State is represented by attributes and relationships, behavior is represented by operations, methods and State Machines. An Object is an instance of a Class.

See also: class, instance

**object diagram**

A diagram that encompasses objects and their relationships at a point in time. An Object diagram can be considered as a special case of a Class diagram or Communication diagram.

See also: class diagram, communication diagram

**object flow**

A sub type of the State flow or transition. It implies the passing of an object instance between elements at run-time.

**object flow state**

A state in an Activity graph that represents the passing of an object from the output of actions in one State to the input of actions in another State.

**object lifeline**

A line in a Sequence diagram that represents the existence of an object over a period of time.

See also: sequence diagram

**Object Management Group (OMG)**

The standards body responsible for the UML specification and management. Their website is [www.omg.org](http://www.omg.org) - follow the links to the UML pages.

**occurrence**

A relationship that indicates that a Collaboration represents a classifier. An Occurrence connector is drawn from the collaboration to the classifier.

**operation**

A service that can be requested from an object to effect behavior. An operation has a signature, which could restrict the actual parameters that are possible.

## 12.15 P

### **package**

1. A namespace, as well as an element that can be contained in other packages' namespaces. Packages can own or merge with other packages, and their elements can be imported into a package's namespace.
2. A logical container of model elements. It groups elements and can also contain other packages. The OMG UML specification (*UML Superstructure Specification, v2.1.1, p. 109*) states:

*A package is used to group elements, and provides a namespace for the grouped elements.*

*A package is a namespace for its members, and may contain other packages. Only packageable elements can be owned members of a package. By virtue of being a namespace, a package can import either individual members of other packages, or all the members of other packages.*

*In addition a package can be merged with other packages.*

Note that packages own model elements and are the basis for configuration control, storage and access control. Each element can be directly owned by a single package, so the package hierarchy is a strict tree. However, packages can reference other packages, modeled by using one of the stereotypes «import» and «access» of Permission dependency, so the usage network is a graph. Other kinds of dependencies between packages usually imply that one or more dependencies among the elements exist.

A package is represented by the common folder icon - a large rectangle with a small rectangle (a 'tab') attached to the left side on top.

### **package diagram**

Used to reflect the organization of packages and their elements, and provide a visualization of their corresponding namespaces.

### **package import**

A package import relationship is drawn from a source package to a package whose contents are imported. Private members of a target package cannot be imported.

### **package merge**

Indicates a relationship between two packages whereby the contents of the target package are merged with those of the source package. Private contents of a target package are not merged.

### **parameter**

The specification of a variable that can be changed, passed, or returned. A parameter can include a name, type, and direction. Parameters are used for operations, messages and events.

*Synonym:* formal parameter

*Contrast:* argument, actual parameter

### **parameterized element**

The descriptor for a Class with one or more unbound parameters.

*Synonym:* template, parameterized class

### **parent**

In a generalization relationship, the generalization of another element, the child.

*See also:* subclass, subtype

*Contrast:* child

### **part**

A run-time instance of a Class or Interface.

### **participate**

The connection of a model element to a relationship or to a reified relationship. For example, a Class participates in an Association, an Actor participates in a Use Case.

### **partition**

1. activity graphs: A portion of an activity graph that organizes the responsibilities for actions.

*See also:* swim lane

2. architecture: A set of related classifiers or packages at the same level of abstraction or across layers in a layered architecture. A partition represents a vertical slice through an architecture, whereas a layer represents a horizontal slice.

*Contrast:* layer

**pattern**

A template collaboration.

*See also:* framework

**persistent object**

An object that exists after the process or thread that created it has ceased to exist.

**physical system**

1. The subject of a model.

2. A collection of connected physical units, which can include software, hardware and people, that are organized to accomplish a specific purpose. A physical system can be described by one or more models, possibly from different viewpoints.

*See also:* model (MOF)

*Contrast:* system

**port**

Defines the interaction between a classifier and its environment. Interfaces controlling this interaction can be depicted using the 'Expose Interface' toolbox icon.

**postcondition**

A constraint that must be true at the completion of an operation.

**precondition**

A constraint that must be true when an operation is invoked.

**primitive type**

A pre-defined basic datatype without any substructure, such as an integer or a string.

**process**

1. A heavyweight unit of concurrency and execution in an operating system.

*Contrast:* thread, which includes heavyweight and lightweight processes. If necessary, an implementation distinction can be made using stereotypes.

2. A software development process - the steps and guidelines by which to develop a system.

3. To execute an algorithm or otherwise handle something dynamically.

**product**

A physical piece of information that is produced by a business or development process. Examples of products include models, source files, scripts, and binary executable files. An product can constitute the implementation of a deployable component.

*Synonym:* artifact

*Contrast:* component

**profile**

A stereotyped package that contains model elements that have been customized for a specific domain or purpose using extension mechanisms, such as stereotypes, tagged definitions and constraints. A profile can also specify model libraries on which it depends and the metamodel subset that it extends.

**Project Browser**

The workspace window where the model contents are displayed in 'tree' format. Displays structures such as packages, diagrams and model elements.

**projection**

A mapping from a set to its subset.

**property**

A named value denoting a characteristic of an element. A property has semantic impact. Certain properties are predefined in the UML; others can be user defined.

*See also:* tagged value

**pseudo-state**

A vertex in a State Machine that has the form of a State, but doesn't behave as a State. Pseudo-states include initial and history vertices.

**published model [MOF]**

A model that has been frozen, and that becomes available for instantiating repositories and for support

in defining other models. A frozen model's model elements cannot be changed.

## 12.16 Q

### *qualifier*

An Association attribute or tuple of attributes whose values partition the set of objects related to an object across an Association.

## 12.17 R

**realize**

A source object realizes the destination object. Realize is used to express traceability and completeness in the model – a business process or requirement is realized by one or more Use Cases which are in turn realized by some Classes which in turn are realized by a Component, and so on.

**receive [a message]**

The handling of a stimulus passed from a sender instance.

See *also*: sender, receiver

**receive**

An element used to define the acceptance or receipt of a request. Movement on to the next action occurs until it has received what is defined.

**receiver [object]**

The object handling a stimulus passed from a sender object.

*Contrast*: sender

**reception**

A declaration that a classifier is prepared to react to the receipt of a signal.

**recursion**

A type of message used in Sequence diagrams to indicate a recursive function.

**reference**

1. A denotation of a model element.
2. A named slot within a classifier that facilitates navigation to other classifiers.

*Synonym*: pointer

**region**

UML 2.x supports both Expansion Regions and Interruptible Activity Regions. An Expansion Region defines the bounds of a region consisting of one or more sets of input collections, where an input collection is a set of elements of the same type. An Interruptible Activity Region contains Activity nodes - when a token leaves an interruptible region, this terminates all of the region's tokens and behaviors.

**refinement**

A relationship that represents a fuller specification of something that has already been specified at a certain level of detail. For example, a design Class is a refinement of an analysis Class.

**relationship**

A semantic connection among model elements. Examples of relationships include Associations and Generalizations.

**repository**

A facility for storing object models, interfaces and implementations.

**represents**

A connector that indicates a Collaboration is used in a classifier. The connector is drawn from the Collaboration to its owning classifier.

**requirement**

A required feature, property or behavior of a system (external requirement).

**responsibility**

A contract or obligation of a classifier (internal requirement).

**reuse**

The use of a pre-existing artifact.

**reverse engineering**

The process of importing source code into the model as standard UML model objects (such as Classes, attributes and operations).

**rich text format**

A standard mark-up language for creating word processor documents, frequently associated with Microsoft Word.

**robustness diagram**

---

Enterprise Architect supports business process modeling extensions from the UML business process model profile. Robustness diagrams are used in ICONIX - you can read more about this at [www.sparxsystems.com/iconix/iconixsw.htm](http://www.sparxsystems.com/iconix/iconixsw.htm).

**role**

1. The named detail and rules associated with one end of an association. Can indicate name, constraints, multiplicity and collection details.
2. The named specific behavior of an entity participating in a particular context. A role can be static (such as an Association end) or dynamic (such as a Collaboration role).

**role binding**

The mapping between a Collaboration Occurrence's internal roles and the respective parts required to implement a specific situation. The associated parts can have properties defined to enable the binding to occur, and the collaboration to take place.

**run time**

The period of time during which a computer program executes.

See also: analysis time, compile time, design time

*Contrast:* modeling time

## 12.18 S

### **scenario**

1. A specific sequence of actions that illustrates behaviors. A scenario can be used to illustrate an interaction or the execution of a Use Case instance.

*See also:* interaction.

2. A sequence of operations carried out in some order to produce a known result. Can apply to Use Cases where it is the equivalent of a Sequence diagram, or to other objects to describe how they are used at run-time.

### **schema [MOF]**

In the context of the MOF, analogous to a package that is a container of model elements. Schema corresponds to a MOF package.

*Contrast:* metamodel, package

### **self-message**

Reflects a new process or method invoked within the calling Lifeline's operation. It is a specification of a message.

### **semantic variation point**

A point of variation in the semantics of a metamodel. It provides an intentional degree of freedom for the interpretation of the metamodel semantics.

### **send [a message]**

The passing of a stimulus from a sender instance to a receiver instance.

*See also:* sender, receiver

### **sender [object]**

The object passing a stimulus to a receiver object.

*Contrast:* receiver

### **sequence diagram**

A diagram that shows object interactions arranged in time sequence. In particular, it shows the objects participating in the interaction and the sequence of messages exchanged. Unlike a Communication (Collaboration) diagram, a Sequence diagram includes time sequences but does not include object relationships. A Sequence diagram can exist in a generic form (describes all possible scenarios) and in an instance form (describes one actual scenario). Sequence diagrams and Communication diagrams express similar information, but show it in different ways.

*See also:* communication diagram, object lifeline

### **signal**

The specification of an asynchronous stimulus communicated between instances. Signals can have parameters.

### **signature**

The name and parameters of a behavioral feature. A signature can include an optional returned parameter.

### **single inheritance**

A semantic variation of Generalization in which a type can have only one supertype.

*Contrast:* multiple inheritance

### **single valued [MOF]**

A model element with multiplicity defined is single valued when its Multiplicity Type: upper attribute is set to 1. The term single-valued does not pertain to the number of values held by, for example, an attribute or parameter at any point in time, since a single-valued attribute (for instance, with a multiplicity lower bound of zero) could have no value.

*Contrast:* multi-valued

### **specification**

A declarative description of what something is or does.

*Contrast:* implementation

### **state**

A condition or situation during the life of an object during which it satisfies some condition, performs



some activity, or waits for some event.

*Contrast:* state [OMA]

**state invariant**

A condition applied to a Lifeline that must be fulfilled for the Lifeline to exist.

**state machine**

A behavior that specifies the sequences of States that an object or an interaction goes through during its life in response to events, together with its responses and actions.

**state machine diagram**

A diagram that illustrates how an element, often a Class, can move between States classifying its behavior, according to transition triggers, constraining guards and other aspects of State Machine diagrams that depict and explain movement and behavior.

**state chart**

A diagram that shows a State Machine.

*See also:* state machine

*Contrast:* activity graph

**state continuation**

A symbol that serves two different purposes for Interaction diagrams - as State Invariants and as Continuations. A State Invariant is a condition applied to a Lifeline that must be fulfilled for the Lifeline to exist. A Continuation is used in seq and alt combined fragments to indicate the branches of continuation that an operand follows.

**state lifeline**

A State Lifeline follows discrete transitions between States, which are defined along the y-axis of the timeline. Any transition has optional attributes of timing constraints, duration constraints and observations.

**static classification**

A semantic variation of Generalization in which an object can not change classifier.

*See also:* multiple classification

*Contrast:* dynamic classification

**stereotype**

A new type of modeling element that extends the semantics of the metamodel. Stereotypes must be based on certain existing types or Classes in the metamodel. Stereotypes can extend the semantics, but not the structure of pre-existing types and Classes. Certain stereotypes are predefined in the UML, others can be user defined. Stereotypes are one of three extensibility mechanisms in UML.

*See also:* constraint, tagged value

**stimulus**

The passing of information from one instance to another, such as raising a signal or invoking an operation. The receipt of a signal is normally considered an event.

*See also:* message

**string**

A sequence of text characters. The details of string representation depend on implementation, and can include character sets that support international characters and graphics.

**structural diagram**

A diagram that depicts the structural elements composing a system or function. These diagrams can reflect the static relationships of a structure, as do Class or Package diagrams, or run-time architectures, such as Object or Composite Structure diagrams. Structural diagrams include Class diagrams, Composite Structure diagrams, Component diagrams, Deployment diagrams, Object diagrams and Package diagrams.

**structural feature**

A static feature of a model element, such as an attribute.

**structural model aspect**

A model aspect that emphasizes the structure of the objects in a system, including their types, Classes, relationships, attributes and operations.

**subactivity state**

A State in an activity graph that represents the execution of a non-atomic sequence of steps that has

some duration.

**subclass**

In a Generalization relationship, the specialization of another Class; the superclass.

*See also:* generalization, child, parent

*Contrast:* superclass

**submachine state**

A State in a State Machine that is equivalent to a composite State but its contents are described by another State Machine.

**subpackage**

A package that is contained in another package.

**substate**

A State that is part of a composite State.

*See also:* composite state, concurrent substate, disjoint substate

**subsystem**

A grouping of model elements that represents a behavioral unit in a physical system. A subsystem offers interfaces and has operations. In addition, the model elements of a subsystem can be partitioned into specification and realization elements.

*See also:* package, physical system

**subtype**

In a Generalization relationship, the specialization of another type; the supertype.

*See also:* generalization, child, parent

*Contrast:* supertype

**superclass**

In a Generalization relationship, the generalization of another Class; the subclass.

*See also:* generalization

*Contrast:* subclass

**supertype**

In a Generalization relationship, the generalization of another type; the subtype.

*See also:* generalization

*Contrast:* subtype

**supplier**

A classifier that provides services that can be invoked by others.

*Contrast:* client

**swimlane**

A partition on an Activity diagram for organizing the responsibilities for actions. Swimlanes typically correspond to organizational units in a business model.

*See also:* partition

**synch**

A State used for indicating that concurrent paths of a State Machine are synchronized. After bringing the paths to a synch state, the emerging transition indicates unison.

**synchronize code**

The process of importing and exporting code changes to ensure the model and source code match.

**system**

A top-level subsystem in a model.

*Contrast:* physical system

**system boundary**

An element used to delineate a particular part of the system.

## 12.19 T

**table**

A relational table (composed of columns).

**tagged value**

The explicit definition of a property as a name-value pair. In a Tagged Value, the name is referred to as the tag. Certain tags are predefined in the UML; others can be user defined. Tagged Values are one of three extensibility mechanisms in UML.

See *also*: constraint, property, stereotype

**template**

The descriptor for a Class with one or more unbound parameters.

*Synonym*: parameterized element, parameterized class

**terminate**

A pseudostate indicating that upon entry of its pseudostate, the State Machine's execution ends.

**thread [of control]**

A single path of execution through a program, a dynamic model, or some other representation of control flow. Also, a stereotype for the implementation of an active object as a lightweight process.

See *also*: active object, process, concurrency

**time event**

An event that denotes the time elapsed since the current state was entered.

See *also*: event

**time expression**

An expression that resolves to an absolute or relative value of time.

**timing diagram**

A diagram that defines the behavior of different objects within a time-scale, with visual depictions of those objects changing state and interacting over time.

**toolbox**

The main toolbar running down the center of Enterprise Architect, from which you can select model elements to insert into diagrams. This is also known as the **Toolbox** and the Object toolbar.

**top level**

A stereotype of package denoting the top-most package in a containment hierarchy. The *topLevel* stereotype defines the outer limit for looking up names, as namespaces 'see' outwards. For example, *opTopLevelSubsystem* represents the top of the subsystem containment hierarchy.

**trace**

A dependency that indicates a historical or process relationship between two elements that represent the same concept without specific rules for deriving one from the other.

**transient object**

An object that exists only during the execution of the process or thread that created it.

**transition**

A relationship between two States indicating that an object in the first State performs certain specified actions and enters the second State when a specified event occurs and specified conditions are satisfied. On such a change of State, the transition is said to *fire*.

See *also*: fire, object flow

**type**

A stereotyped Class that specifies a domain of objects together with the operations applicable to the objects, without defining the physical implementation of those objects. A type can not contain any methods, maintain its own thread of control, or be nested. However, it can have attributes and associations. Although an object can have at most one implementation Class, it can conform to multiple different types.

See *also*: implementation class

*Contrast*: interface

**type expression**

An expression that evaluates to a reference to one or more types.

## 12.20 U

### **UML**

The Unified Modeling Language, a notation and specification for modeling software systems in an Object-Oriented manner. You can read more about UML at the [OMG home page](#) or at our [UML Tutorial](#).

### **UML diagrams**

Diagrams used to model different aspects of the system under development. They include various elements and connectors, all of which have their own meanings and purposes. UML 2.3 includes 14 diagrams: Use Case diagram, Activity diagram, State Machine diagram, Timing diagram, Sequence diagram, Interaction Overview diagram, Communication diagram, Package diagram, Class diagram, Object diagram, Composite Structure diagram, Component diagram and Deployment diagram.

### **UML toolbox**

The main toolbar running down the center of Enterprise Architect from which you can select model elements to insert into diagrams. This is also known as the **Toolbox** and the Object toolbar.

### **uninterpreted**

A placeholder for a type or types whose implementation is not specified by the UML. Every uninterpreted value has a corresponding string representation.

See *also*: any [CORBA]

### **usage**

A dependency in which one element (the client) requires the presence of another element (the supplier) for its correct functioning or implementation.

### **use**

A connector that indicates that one element requires another to perform some interaction. The Usage relationship does not specify how the target supplier is used, other than that the source client uses it in definition or implementation.

### **use case [class]**

A UML model element that describes how a user of the proposed system interacts with the system to perform a discrete unit of work. It describes and signifies a single interaction over time that has meaning for the end user (person, machine or other system), and is required to leave the system in a complete state: either the interaction completed or was rolled back to the initial state.

See *also*: use case instance

### **use case diagram**

A diagram that captures Use Cases and Actor interactions. It describes the functional requirements of the system, the manner in which outside things (Actors) interact at the system boundary, and the response of the system.

### **use case estimation**

The technique of estimating project size and complexity based on the number of Use Cases and their difficulty.

### **use case instance**

The performance of a sequence of actions being specified in a Use Case. An instance of a Use Case.

See *also*: Use Case class

### **use case model**

A model that describes a system's functional requirements in terms of Use Cases.

### **utility**

A stereotype that groups global variables and procedures in the form of a Class declaration. The utility attributes and operations become global variables and global procedures, respectively. A utility is not a fundamental modeling construct, but a programming convenience.

## 12.21 V

**value**

An element of a type domain.

**value lifeline**

A Lifeline that shows the Lifeline's state across the diagram, within parallel lines indicating a steady state. A cross between the lines indicates a transition or change in state.

**vertex**

A source or a target for a transition in a State Machine. A vertex can be either a State or a pseudo-state.

*See also:* state, pseudo-state

**view**

A projection of a model, which is seen from a given perspective or vantage point and omits entities that are not relevant to this perspective.

**view element**

An element that is a textual and/or graphical projection of a collection of model elements.

*Contrast:* model element (MOF)

**view projection**

A projection of model elements onto view elements. A view projection provides a location and a style for each view element.

**visibility**

An enumeration whose value (public, protected, package or private) denotes how the model element to which it refers can be seen outside its enclosing namespace.

*See also:* export, import

**Visual Basic**

A rapid application development programming language. Windows' only scripting language based on COM.

**Part**

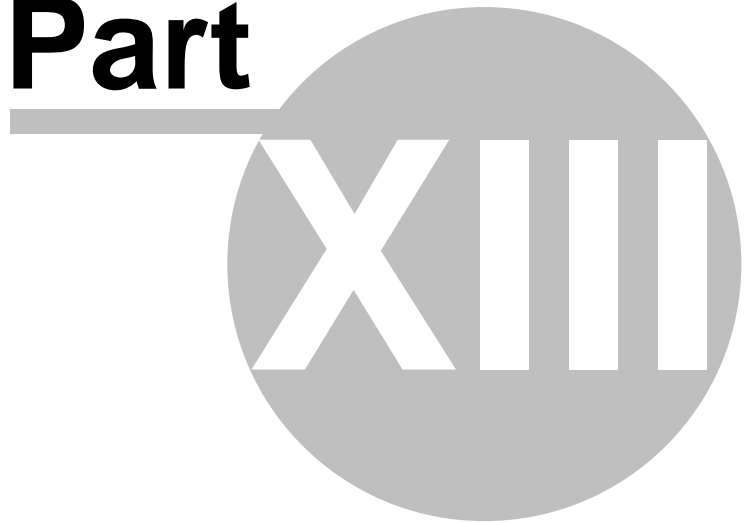

## 13 License Management



The **License Management** dialog in Enterprise Architect enables you to upgrade Enterprise Architect and to register Add-Ins.

To access License Management from within Enterprise Architect, select the **Help | Register and Manage License Key(s)** menu option. The **License Management** dialog displays, listing the currently-registered keys, when the key expires (or, for [shared keys](#)<sup>[1870]</sup>, when they are to be reactivated in the keystore for issue to another user) and the product each key applies to.

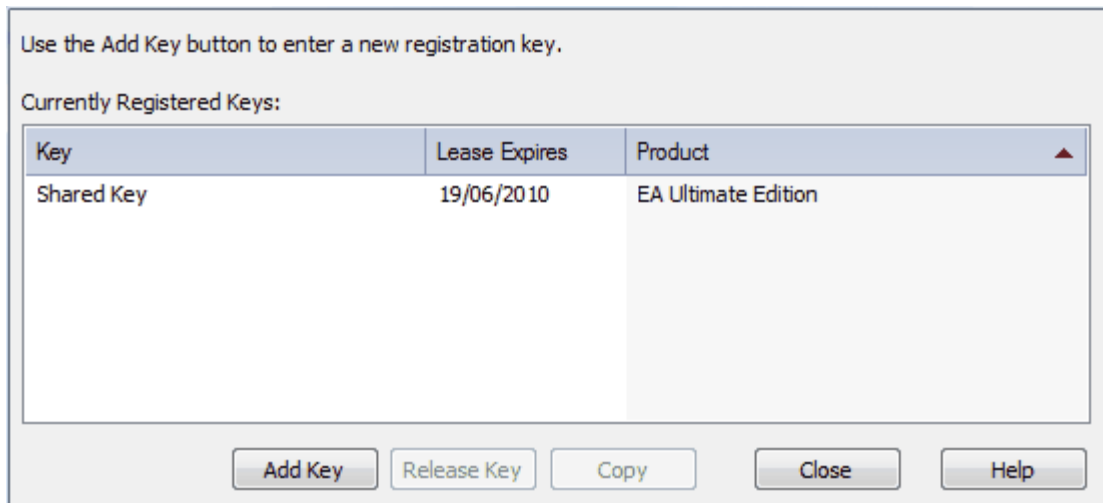

Use the buttons on the dialog as required:

Option	Use to
<b>Add Key</b>	Display the <b>Add Registration Key</b> dialog, which enables you to: <ul style="list-style-type: none"> <li>• Add a new key to update to a higher version of Enterprise Architect or to register an Add-In.</li> <li>• Obtain a key from the Sparx Systems Key Store (available for version 4.51 and above).</li> </ul> For more information on adding keys see the <a href="#">Add License Key</a> <sup>[1870]</sup> topic.
<b>Remove Key</b>	(Private Key) Make the Add-In or current version of Enterprise Architect inoperable.
<b>Release Key</b>	(Shared Key) Release the key to the keystore; however, the Keystore Manager is normally configured to release keys automatically when the user logs off.
<b>Copy</b>	Place the highlighted key into the clipboard.
<b>Close</b>	Close the dialog.
<b>Help</b>	Display the help for this topic.

You can also run the following tasks from the **License Management** dialog:

- [Register a Full License](#)<sup>[227]</sup>
- [Upgrade an Existing License](#)<sup>[1873]</sup>

- [Register an Add-In](#) 



## 13.1 Finding Your License Information

You can find information on your Enterprise Architect license in the [About Enterprise Architect](#) dialog; select the **Help | About EA** menu option.

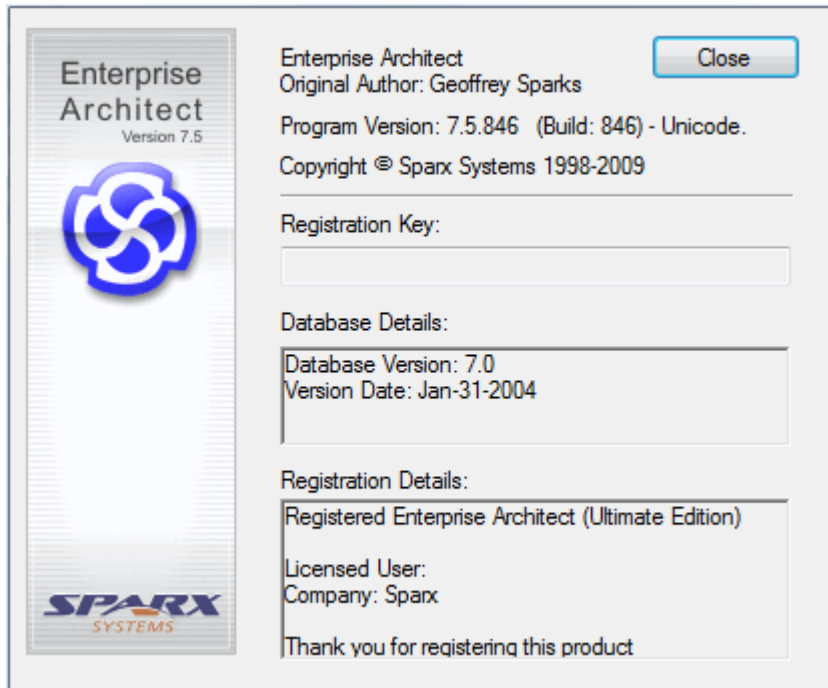

## 13.2 Add License Key

Two types of key can be used in conjunction with Enterprise Architect:

- Private keys allow you to register, indefinitely, an Enterprise Architect license (Desktop, Professional, Corporate, Business and Software Engineering, Systems Engineering or Ultimate) or an Add-In product (such as MDG Link for Eclipse or MDG Link for Visual Studio.NET) on the machine and user account that you are currently using.
- Shared keys - obtained from a central shared key store - give you temporary access to the installed 'suite' edition of Enterprise Architect. Shared Keys are available with the purchase of a floating license, and require Enterprise Architect version 4.51 or higher. For more information, see [Enterprise Architect Floating License](#).

### Notes:

- Some license keys can override and remove others. For example, the key for a more advanced edition of Enterprise Architect replaces the key for a simpler edition, and the key for MDG Integration for Visual Studio replaces the key for MDG Link for Visual Studio.
- Shared keys and Private keys have different formats and cannot be used interchangeably in the two procedures below.

### Add a Private Key

To add a private key, follow the steps below:

1. Select the **Help | Register and Manage License Key(s)** menu option. The [License Management](#) <sup>1867</sup> dialog displays.
2. Click on the **Add Key** button. The **Add Registration Key** dialog displays.

The screenshot shows a dialog box titled 'Add Registration Key'. It has two tabs: 'Enter Private Key' (which is selected) and 'Get Shared Key'. Inside the dialog, there are two input fields: 'Name:' and 'Company:'. Below these fields is a large text area with the instruction 'Copy registration key into space below, then press OK button'. At the bottom of the dialog are three buttons: 'OK', 'Cancel', and 'Help'.

3. Click on the **Enter Private Key** tab.
4. In the **Name** and **Company** fields, type your user name and company name. Into the registration key field, copy the registration key (including any parentheses around the key).
5. Click on the **OK** button to confirm the key selection.

### Add a Shared Key

Shared Keys require a shared license keystore to be configured by your license administrator. The key store can be either file-based or network based (preferred). Only the Key Administrator is required to install the Sparx Enterprise Key Store application. End users simply connect to the configured key file - advised by the administrator - using Enterprise Architect as described below. No additional software is required to be installed.

### Note:

If any error messages are displayed while attempting to obtain a shared key, see [Keystore Troubleshooting](#)

<sup>1872</sup>

To add a shared key, follow the steps below:

1. Select the **Help | Register and Manage License Key(s)** menu option. The [License Management](#) <sup>1867</sup> dialog displays.
2. Click on the **Add Key** button. The **Add Registration Key** dialog displays.
3. Click on the **Get Shared Key** tab.

4. In the **Name** and **Company** fields, type your user name and company name.
5. In the **Shared key store** field, click on the [ ... ] (Browse) button. The **Shared Keystore Selection** dialog displays.

6. If your keystore is file-based, select the **File Based Keystore** radio button, click on the **Browse** button, and locate and select the keystore file. Go to step 9.
7. If the keystore is network-based, click on the **Sparx Keystore Server** radio button and, in the **Server Address** field, type the server address of the keystore.
8. If necessary, type in the password (advised by your administrator) and/or click on the **Test** button to ensure that you have a connection to the keystore.
9. Click on the **OK** button to return to the **Get Shared Key** tab, which now shows the name of the keystore in the **Shared Keystore** field.
10. In the **Select a Product** field, click on the appropriate product name.
11. Click on the **OK** button. The **License Management** dialog redisplay, indicating that the shared key is registered for the selected product, until the key expiry date.
12. Click on the **Close** button.

### 13.3 Keystore Troubleshooting

Message Displayed:	Explanation
<p><i>Error reading Key Store file: (Access is denied)</i></p>	<p>All users who are to use the shared key facility require <b>Read, Write and Modify</b> access to the <i>sskeys.dat</i> file containing the shared keys. Please verify that all required users have sufficient permissions to the file and try again.</p> <p>If the problem continues, contact Sparx Support.</p> <p><b>Tip:</b></p> <p>Review the effective permissions calculated at the location of the key file for the user account reporting the problem. You should closely examine the permissions for <b>both</b> the Network Share and the File System. It is possible that these permissions have been overwritten at some point.</p>
<p><i>Error reading Key Store file: (Key File has been moved)</i></p>	<p>As a security measure in the key store, the hard drive serial number is recorded when the file is created. The file then cannot be moved from the original location in which it was created. If the key store has to be re-located for any reason, the administrator should re-create the key store in the new location using the original license keys.</p> <p>This issue is commonly seen after a file server has undergone a hardware upgrade in which the physical hard drives have been replaced. Problems could also occur if the drive used is part of a RAID configuration.</p> <p>This message could also appear where the key store exists on a Novell-based file system. When creating the key store, the administrator is prompted to confirm that the key store is to be located on a Novell Netware file server. If the administrator clicks on the <b>Yes</b> button, the key store instead records the logical path used to create it, and all users must connect to the key store using this same path. The recorded path is case-sensitive and must be an exact match.</p>

## 13.4 Upgrade an Existing License

Enterprise Architect comes in six editions: Desktop, Professional, Corporate, Business and Software Engineering, Systems Engineering and Ultimate. If you are using a less powerful edition, such as Professional or Desktop, you can upgrade your license at a future date. You can do this by purchasing an upgrade key from Sparx Systems (see the Sparx Systems [website](#) for purchase details).

An upgrade key is a special key that upgrades an existing license to a higher *edition*. Once you have purchased and received the appropriate key, use the following procedures to unlock additional features. The procedure for Enterprise Architect version [7.0 and later](#) releases differs from the procedure for [earlier releases](#).

### Notes:

- The [Lite](#) version and the Trial version cannot be registered or upgraded. If you have purchased Enterprise Architect, you must download the registered version from [www.sparxsystems.com/securedownloads/easetupfull.exe](http://www.sparxsystems.com/securedownloads/easetupfull.exe) before you can enter your registration key.
- This topic is mainly relevant to users with *private* keys. If you are an end-user with a *shared* key, you would simply be allocated the relevant key next time you requested one. If, however, you need to upgrade while using a shared key on a long lease, you would simply click on the [Release Key](#) button and then the [Add Key](#) button.

### Tip:

Once you have successfully completed an upgrade with a *Private* key, select the **Help | About EA** menu option. Copy the registration key shown and store it somewhere safe; this is a key to the full license of the edition you have upgraded to. If you ever have to reinstall Enterprise Architect, you can register it with this key, so you won't have to go through the upgrade process again.

## Upgrade Enterprise Architect Version 6.5 and Earlier

To upgrade from one license edition to another, follow the steps below:

1. Make sure you have a valid upgrade key purchased from Sparx Systems; you typically receive this in an email or PDF format.
2. Open Enterprise Architect.
3. Select the **Help | Register and Manage License Key(s)** menu option. The **License Management** dialog displays

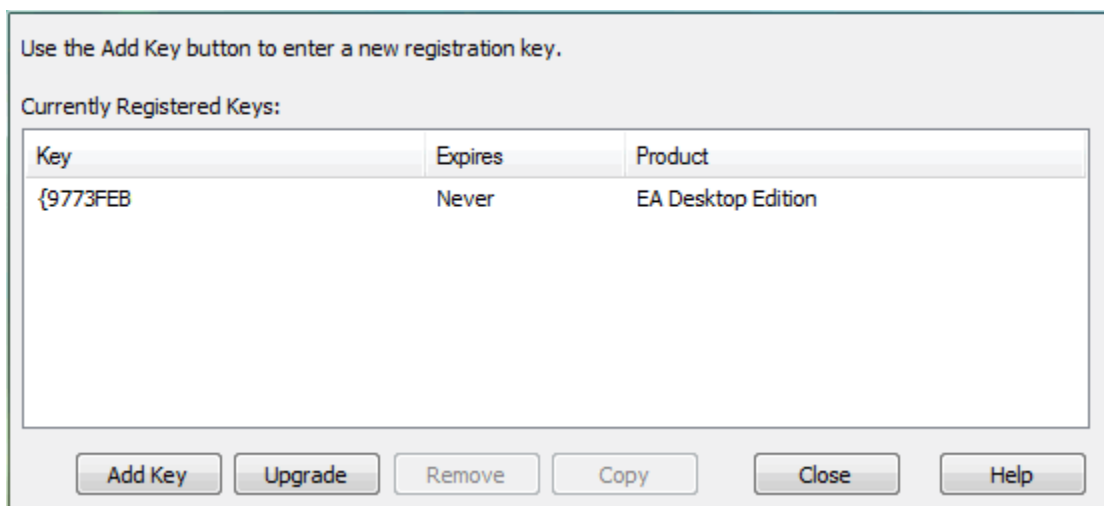

4. Click on the **Add Key** button or the **Upgrade** button to enter a new license key.
5. If you selected the **Add key** option, the **Add Registration Key** dialog displays. Enter the key you received for the upgraded edition of Enterprise Architect, including the { and } bracket characters (use copy and paste from an email to avoid typing mistakes).
6. If you selected the **Upgrade** option, the **Upgrade Key** dialog displays. Enter the key you received for the

upgraded edition of Enterprise Architect, including the { and } bracket characters (use copy and paste from an email to avoid typing mistakes).

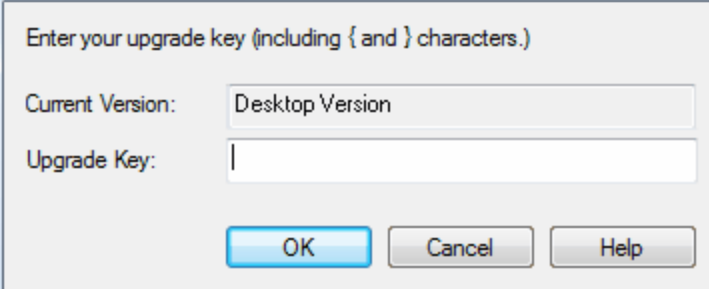

Enter your upgrade key (including { and } characters.)

Current Version: Desktop Version

Upgrade Key: |

OK Cancel Help

7. Click on the **OK** button. If the key is valid, Enterprise Architect modifies the **Current Version** field to reflect the upgrade.
8. Close Enterprise Architect and restart to enable the unlocked features.

### Upgrade Enterprise Architect Version 7.0 and Later

To upgrade from one license edition to another, follow the steps below:

1. Make sure you have a valid upgrade key purchased from Sparx Systems; you typically receive this in an email or PDF format.
2. Open Enterprise Architect.
3. Select the **Help | Register and Manage License Key(s)** menu option. The **License Management** dialog displays.

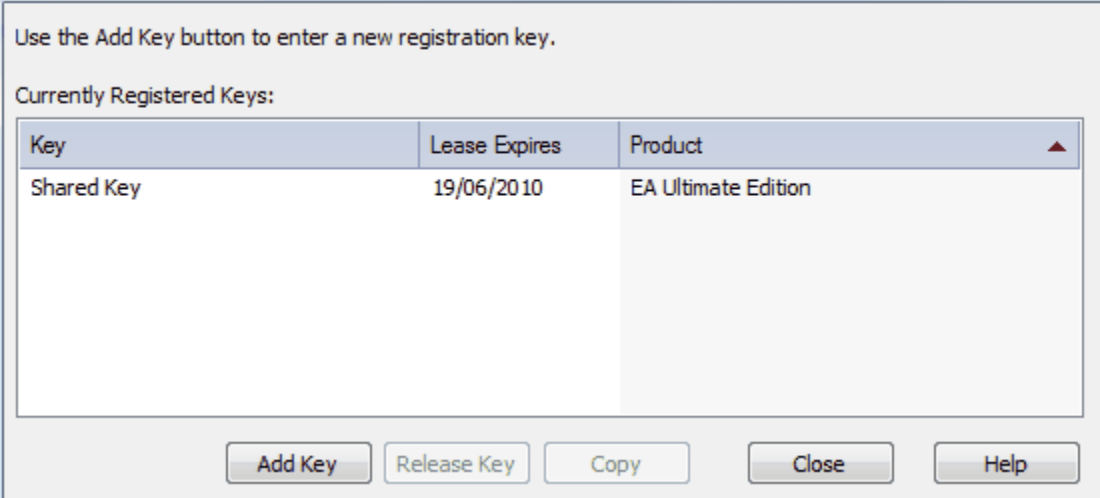

Use the Add Key button to enter a new registration key.

Currently Registered Keys:

Key	Lease Expires	Product
Shared Key	19/06/2010	EA Ultimate Edition

Add Key Release Key Copy Close Help

4. Click on the **Add Key** button; the **Add Registration Key** dialog displays

The screenshot shows a dialog box titled "Enter Private Key" with a sub-tab "Get Shared Key". The dialog contains three input fields: "Name:" (empty), "Company:" (containing "Sparx"), and a larger text area labeled "Copy registration key into space below, then press OK button" (empty). At the bottom are three buttons: "OK", "Cancel", and "Help".

5. In the **Name** and **Company** fields, type your name and company name.
6. To avoid typing mistakes, copy the key you received for the upgraded edition of Enterprise Architect - including the { and } bracket characters - from the email and paste the key into the **Copy registration key** field.
7. Click on the **OK** button. Enterprise Architect displays a *Registration succeeded – Thank you for purchasing Enterprise Architect xxxx Edition* message.
8. Click on the **OK** button, and then on the **Close** button to continue working in Enterprise Architect.

## 13.5 Register Add-In

To register Add-Ins for Enterprise Architect, follow the steps below:

### Register an Add-In for Enterprise Architect

1. Purchase one or more licenses for the Add-In from your Add-In provider. Once you have paid for a licensed version of the Add-In, you receive (via email or other suitable means) a license key for the product.
2. Save the license key and the latest full version of the Add-In.
3. Run the Add-In's setup program to install the Add-In.
4. In Enterprise Architect, select the **Help | Register and Manage License Key(s)** menu option, or the **Add-Ins | Enter License Key for <Add-In name>** menu option.

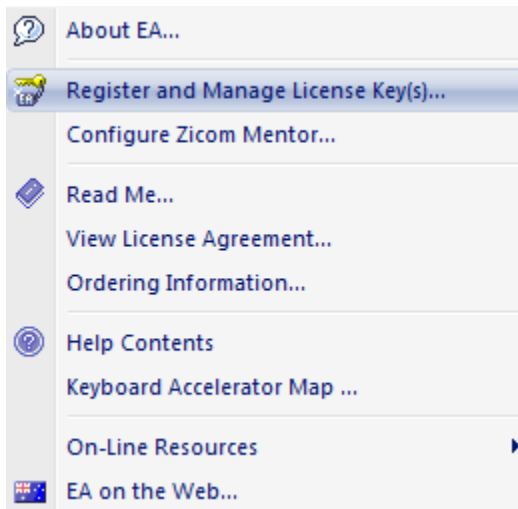

The [License Management](#) <sup>1867</sup> dialog displays.

5. Click on the **Add Key** button. The **Add Registration Key** dialog displays.

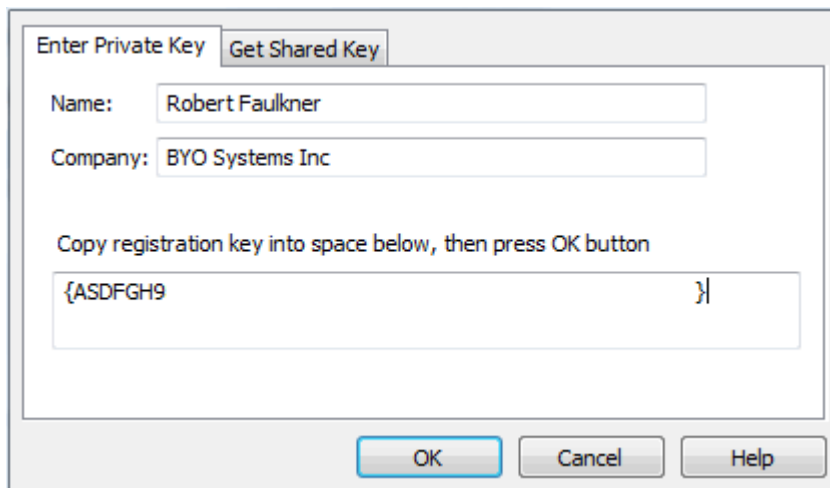

6. Type in the key you received with the Add-In, including the { and } characters.

**Note:**

If you have purchased a floating licence (shared key) follow [these steps](#) <sup>1877</sup>.

7. Click on the **OK** button.
8. When the Add-In has been added successfully, close down Enterprise Architect and restart it to apply



the changes.

# Index

## - . -

### .EMX

Import 290

### .NET

ASP, Debug 1463  
 Debug 1460  
 Debug Another Process 1472  
 Debug Assembly 1461  
 Debug CLR Versions 1462  
 Debug With COM Interop Process 1463  
 Debug, System Requirements 1447  
 Garbage Collect (Exit Method) 1680  
 Set Up Debug Session 1461

### .UML2

Import 290

## - A -

### Abstract

Complex Models 821  
 XSD Models 1047

Acceptance Testing 1542

### AcceptEvent Action

Triggers Tab 745

### Access

Email 103  
 Internet Search Engine 103  
 MDG Technologies Remote From Enterprise Architect 1070  
 Web Site 103

### Access 2007

Repository, Create 123  
 Upsize To 169

### Acknowledgement

CXImage Library 20  
 Of Contributions 20  
 Of Trademarks 19  
 Print Listview 20

### Action

AcceptEvent, Triggers Tab 745  
 As Hyperlink 842  
 BroadcastSignal, Signal Tab 745  
 Element 743  
 Expansion Node 749  
 Local Pre/Post Conditions 752  
 Notation 745

Operations 743  
 SendSignal, Signal Tab 745  
 StructuralFeature 745  
 Trigger, AcceptEvent 745  
 Type, Set 745  
 Update Operation 743

### Action Pin

Add To Action 749  
 As Action Property 751  
 As Argument For Call Action 749  
 Assign To Action 751  
 Properties 749

### ActionScript

Code Generation Language Options 1348  
 Import, Reverse Engineering 1331  
 Modeling Conventions 1283  
 Options 1348  
 Versions Supported 1348

### Activate

MDG Technologies 1069

Activate Recording Markers 1503

### Activation

End 711  
 Extend Down 711  
 Extend Up 711  
 Lower 711  
 Raise 711  
 Sequence Element 711  
 Suppress 711

### Activation Layer

Sequence Diagram Lifelines 712

### Activation Levels

Sequence Diagram Lifeline Self Messages 712

### Active

Classes 812  
 State Configuration 790

### Active Directory

Import User ID From 192

### Active State Logic

Model State Machine For HDL 1319

### Activity

Behavioral Aspects 581  
 Edit Parameters 581  
 Element 753  
 Elements And Connectors 412  
 Group, Toolbox 412  
 Instance 892  
 IsException 755  
 IsStream 755  
 Notation 754  
 Parameter Nodes 755  
 Parameters, Define 583

- Activity
  - Partition 756, 786
  - Paste As Action 432
  - Paste As Link 432
  - Paste From Project Browser 432
  - Process Element 846
  - Region Element 788
  - Structured 798
  - Structured, Conditional Node 796, 798
  - Structured, Loop Node 796, 798
  - Structured, Sequential 796
- Activity (BPEL)
  - Create 974
  - Loop 974
  - Model 974
  - Sub-Process 974
  - Task 974
  - Types 974
- Activity Diagram
  - Create Object From Attribute 568
  - Description 674
  - Elements And Connectors 674
  - Example 674
  - Generate Code From 1314, 1323
  - Generate From Scenario 499, 500
  - Generate Scenario From 513
  - Object Flows 886
  - Operations 743
- Activity Edge
  - Connector 867
  - Relationship 867
- Activity Final
  - Element 772
- Activity Partition
  - Docking 786
  - Element 786
  - Horizontal 786
  - Vertical 786
- Actor
  - Element 757
- Ada 2005
  - Code Generation Language Options 1348
  - Modeling Conventions 1284
  - Options 1348
- Adaptive Server Anywhere
  - Data Repository, Connect To 162
  - ODBC Driver, Set Up 141
  - Repository, Create 132
  - Upsize To 170
- Add
  - Category To Team Review 211
- Code Modules In MDG Technology Wizard 1128
- Connectors Between Locked Elements 204
- Connectors To UML Model, Quick Start 32
- Diagram Properties Note 440
- Diagram To Package 30
- Diagram to Project 422
- Diagram To UML Model, Quick Start 30
- Diagram Type In MDG Technology Wizard 1124
- Element Changes 1559
- Element Defects 1559
- Element Directly To Package 524
- Element Issues 1559
- Element Tasks 1559
- Element To Diagram 31
- Element To Diagram From Project Browser 430
- Element To UML Model, Quick Start 31
- Enumeration Tags To Stereotypes 1103
- Expansion Region 771
- Filters To Search 1242
- Images In MDG Technology Wizard 1130
- Instance Variable 824
- Interruptible Activity Region 782
- Key 1870
- License Key 1870
- Line Points 615
- Linked Document Template In MDG Technology Wizard 1133
- MDA Transforms In MDG Technology Wizard 1130
- Model To Project 112
- MS Word Table Of Contents 1641
- MS Word Table Of Figures 1642
- New Code Sections To Existing Features 1308
- Note To Connector 612
- Note To Link 612
- Package In Project Browser 387
- Package To UML Model, Quick Start 30
- Packages To Model Document 1620
- Pattern In MDG Technology Wizard 1123
- Pattern To Diagram 904
- Port To Element 827
- Post To Team Review 213
- Profile Attribute To Diagram 909
- Profile Connector To Diagram 909
- Profile Element To Diagram 909
- Profile In MDG Technology Wizard 1122
- Profile Operation To Diagram 909
- Project Items Via Toolbar 81
- Project Task 330
- Property Value to Part 826

- Add
  - RTF Report Template In MDG Technology Wizard 1132
  - Scripts In MDG Technology Wizard 1131
  - Shape Script To Stereotype In Profile 1104
  - Tagged Value Types In MDG Technology Wizard 1127
  - Tagged Values 634
  - Task Panel In MDG Technology Wizard 1126
  - Test Details 1538
  - Toolbox In MDG Technology Wizard 1125
  - Topic To Team Review 212
  - UML Diagram 422
  - UML Pattern To Diagram 904
  - Views 383
- Add And Delete Attributes
  - Automation Interface Code Example 1769
- Add And Delete Methods
  - Automation Interface Code Example 1769
- Add And Manage Diagrams
  - Automation Interface Code Example 1768
- Add And Manage Elements
  - Automation Interface Code Example 1767
- Add And Manage Packages
  - Automation Interface Code Example 1766
- Add Connector
  - Automation Interface Code Example 1767
- Add Stereotypes
  - Automation Interface Code Example 1773
- Add Submenu
  - Element Context Menu, Project Browser 1219
  - Package Context Menu, Project Browser 1216
- Add to Project Clipboard
  - Menu Option (Edit Menu) 57
- Add-In
  - And Enterprise ArchitectDeadlocks (.NET) 1779
  - COM Interoperability 1779
  - Concurrent Method Calls 1779
  - Connect To 72
  - Create 1777
  - Create, Define Menu Items 1777
  - Deploy 1778
  - Disable 1781
  - Display Help On 72
  - Enable 1781
  - Events 1782
  - Holding State Information 1779
  - Manage 1781
  - Manager 1781
  - MDG 1073
  - Menu 72
  - Model Driven Generation 1073
  - Pre-2004 1779
  - Re-entrancy 1779
  - Register 1876
  - Run Functions From Tasks Pane 1143
  - Search 1239, 1781
  - Search Data 1782
  - Submenu 72
  - Tasks 1777
  - Visual Basic Issues 1779
  - Window 58
- Add-In Event
  - EA\_Connect 1782
  - EA\_Disconnect 1783
  - EA\_GetMenuItems 1783
  - EA\_GetmenuState 1784
  - EA\_MenuClick 1785
  - EA\_OnOutputItemClicked 1785
  - EA\_OnOutputItemDoubleClicked 1786
  - EA\_ShowHelp 1787
- Add-In Model
  - Add-In Event, EA\_Connect 1782
  - Add-In Event, EA\_Disconnect 1783
  - Add-In Event, EA\_GetMenuItems 1783
  - Add-In Event, EA\_GetMenuState 1784
  - Add-In Event, EA\_MenuClick 1785
  - Add-In Event, EA\_OnOutputItemClicked 1785
  - Add-In Event, EA\_OnOutputItemDoubleClicked 1786
  - Add-In Event, EA\_ShowHelp 1787
  - Add-In Event, Overview 1782
  - Add-In Tasks 1777
  - Benefits 1776
  - Broadcast Event, EA\_FileClose 1788
  - Broadcast Event, EA\_FileNew 1789
  - Broadcast Event, EA\_FileOpen 1788
  - Broadcast Event, EA\_OnPostCloseDiagram 1789
  - Broadcast Event, EA\_OnPostInitialized 1802
  - Broadcast Event, EA\_OnPostOpenDiagram 1789
  - Broadcast Event, EA\_OnPostTransform 1803
  - Broadcast Event, EA\_OnPreExitInstance 1798
  - Broadcast Event, EA\_OnRetrieveModelTemplate 1820
  - Broadcast Events 1787
  - Compartment Events 1809
  - Compartment Events, EA\_GetCompartmentData 1810
  - Compartment Events, EA\_QueryAvailableCompartments 1809
  - Context Item Events 1807

## Add-In Model

- Context Item Events, EA\_OnContextItemChanged 1807, 1809
- Context Item Events, EA\_OnContextItemDoubleClicked 1808
- Create Add-In 1777
- Create Add-In, Tricks and Traps 1779
- Create Custom View 1821
- Custom View 1820
- EA\_Connect 1782
- EA\_Disconnect 1783
- EA\_FileClose 1788
- EA\_FileNew 1789
- EA\_FileOpen 1788
- EA\_GetCompartmentData 1810
- EA\_GetMenuItems 1783
- EA\_GetMenuState 1784
- EA\_MenuClick 1785
- EA\_OnContextItemChanged 1807, 1809
- EA\_OnContextItemDoubleClicked 1808
- EA\_OnDeleteTechnology 1806
- EA\_OnEndValidation 1813
- EA\_OnImportTechnology 1806
- EA\_OnInitializeTechnologies 1803
- EA\_OnInitializeUserRules 1812
- EA\_OnOutputItemClicked 1785
- EA\_OnOutputItemDoubleClicked 1786
- EA\_OnPostActivateTechnology 1805
- EA\_OnPostCloseDiagram 1789
- EA\_OnPostInitialized 1802
- EA\_OnPostNewAttribute 1801
- EA\_OnPostNewConnector 1799
- EA\_OnPostNewDiagram 1800
- EA\_OnPostNewDiagramObject 1800
- EA\_OnPostNewElement 1798
- EA\_OnPostNewMethod 1801
- EA\_OnPostNewPackage 1802
- EA\_OnPostOpenDiagram 1789
- EA\_OnPostTransform 1803
- EA\_OnPreActivateTechnology 1804
- EA\_OnPreDeleteAttribute 1791
- EA\_OnPreDeleteConnector 1792
- EA\_OnPreDeleteDiagram 1792
- EA\_OnPreDeleteElement 1790
- EA\_OnPreDeleteMethod 1791
- EA\_OnPreDeletePackage 1793
- EA\_OnPreDeleteTechnology 1805
- EA\_OnPreExitInstance 1798
- EA\_OnPreNewAttribute 1796
- EA\_OnPreNewConnector 1794
- EA\_OnPreNewDiagram 1795
- EA\_OnPreNewDiagramObject 1795
- EA\_OnPreNewElement 1793
- EA\_OnPreNewMethod 1797
- EA\_OnPreNewPackage 1797
- EA\_OnRetrieveModelTemplate 1820
- EA\_OnRunAttributeRule 1815
- EA\_OnRunConnectorRule 1814
- EA\_OnRunDiagramRule 1814
- EA\_OnRunElementRule 1813
- EA\_OnRunMethodRule 1815
- EA\_OnRunPackageRule 1813
- EA\_OnRunParameterRule 1816
- EA\_OnStartValidation 1812
- EA\_QueryAvailableCompartments 1809
- EA\_ShowHelp 1787
- Interface 1776
- Introduction 1776
- MDG Add-Ins 1821
- MDG Add-Ins, MDG Events 1822
- MDG Events, MDG\_BuildProject 1822
- MDG Events, MDG\_Connect 1822
- MDG Events, MDG\_Disconnect 1823
- MDG Events, MDG\_GetConnectedPackages 1824
- MDG Events, MDG\_GetProperty 1824
- MDG Events, MDG\_Merge 1825
- MDG Events, MDG\_NewClass 1826
- MDG Events, MDG\_PostGenerate 1827
- MDG Events, MDG\_PostMerge 1827
- MDG Events, MDG\_PreGenerate 1828
- MDG Events, MDG\_PreMerge 1828
- MDG Events, MDG\_PreReverse 1829
- MDG Events, MDG\_RunExe 1830
- MDG Events, MDG\_View 1830
- Model Validation Broadcasts 1811
- Model Validation Broadcasts, EA\_OnEndValidation 1813
- Model Validation Broadcasts, EA\_OnInitializeUserRules 1812
- Model Validation Broadcasts, EA\_OnRunAttributeRule 1815
- Model Validation Broadcasts, EA\_OnRunConnectorRule 1814
- Model Validation Broadcasts, EA\_OnRunDiagramRule 1814
- Model Validation Broadcasts, EA\_OnRunElementRule 1813
- Model Validation Broadcasts, EA\_OnRunMethodRule 1815
- Model Validation Broadcasts, EA\_OnRunPackageRule 1813
- Model Validation Broadcasts, EA\_OnRunParameterRule 1816
- Model Validation Broadcasts, EA\_OnStartValidation 1812

- Add-In Model
  - Model Validation Example 1816
  - Post-New Events 1798
  - Post-New Events, EA\_OnPostNewAttribute 1801
  - Post-New Events, EA\_OnPostNewConnector 1799
  - Post-New Events, EA\_OnPostNewDiagram 1800
  - Post-New Events, EA\_OnPostNewDiagramObject 1800
  - Post-New Events, EA\_OnPostNewElement 1798
  - Post-New Events, EA\_OnPostNewMethod 1801
  - Post-New Events, EA\_OnPostNewPackage 1802
  - Pre-Deletion Events 1790
  - Pre-Deletion Events, EA\_OnPreDeleteAttribute 1791
  - Pre-Deletion Events, EA\_OnPreDeleteConnector 1792
  - Pre-Deletion Events, EA\_OnPreDeleteDiagram 1792
  - Pre-Deletion Events, EA\_OnPreDeleteElement 1790
  - Pre-Deletion Events, EA\_OnPreDeleteMethod 1791
  - Pre-Deletion Events, EA\_OnPreDeletePackage 1793
  - Pre-New Events 1793
  - Pre-New Events, EA\_OnPreNewAttribute 1796
  - Pre-New Events, EA\_OnPreNewConnector 1794
  - Pre-New Events, EA\_OnPreNewDiagram 1795
  - Pre-New Events, EA\_OnPreNewDiagramObject 1795
  - Pre-New Events, EA\_OnPreNewElement 1793
  - Pre-New Events, EA\_OnPreNewMethod 1797
  - Pre-New Events, EA\_OnPreNewPackage 1797
  - Search Data, XML Format 1782
  - Technology Event, EA\_OnInitializeTechnologies 1803
  - Technology Events 1803
  - Technology Events, EA\_OnDeleteTechnology 1806
  - Technology Events, EA\_OnImportTechnology 1806
  - Technology Events, EA\_OnPostActivateTechnology 1805
  - Technology Events, EA\_OnPreActivateTechnology 1804
  - Technology Events, EA\_OnPreDeleteTechnology 1805
- Administrator
- Security Permissions 189
- Advanced
  - Settings, Generalizable Elements 483
  - Tag Management 638
- Advanced (Element)
  - Submenu 68
- Advanced Options
  - RTF Report 1607
- Advanced Search Options 1238
- Aggregate
  - Connector 854
  - Relationship 854
- Aggregation Connector
  - Change Form 855
- Align
  - Elements From Toolbar 83
  - Multiple Elements 532
- Alignment
  - Submenu 70
- All User Permissions
  - Dialog, User Security 196
  - View, User Security 196
- Alternate Path
  - RTF Report Template Section 1585
- Alternate Path, Scenario 490
- Alternative Image
  - For Element 447
  - In Diagram 447
  - Select 447
  - Stereotype 900
- Analysis
  - Elements and Connectors 416
  - Group, Toolbox 416
  - Models, Business Processes 931
  - Stereotypes 835
- Analysis Diagram
  - Description 733
  - Diagram 733
  - Elements And Connectors 733
  - Example 733
- Analyzer Windows
  - From the Debug Window 1467
- ANSI C 1349
  - Modeling Conventions 1285
- Anti-Aliased Rendering
  - Of Diagrams 356
- Anti-Aliased Text
  - In Diagrams 356
- Apache Tomcat
  - Server Configuration 1459
  - Server, Debugging 1456
  - Service Configuration 1460

- App Object
  - Automation Interface 1674
- Appearance
  - Apply From Clipboard 555
  - Connectors Context Menu Section 609
  - Copy For Element 555
  - Default, Of Element 538
  - Element Context Menu 555
- Appearance (Element)
  - Autosize 69
  - Submenu 69
- Applets
  - Java, In Internet Browsers, Debug 1454
- Application
  - Connector 414
- Application Look Dialog 101
- Application Workspace 48
- Apply
  - Rigorous Security Mode Lock 205
  - RTF Report Filter (Legacy) 1630
  - Stereotype To Dependency Relationship 862
  - Stereotype To Element 896
  - Stereotype To UML Construct 896
  - User Lock 205
- Archimate
  - Concept 1073
  - Diagram 1073
  - Disable 1073
  - Elements 1073
  - Enable 1073
  - MDG Technology 1073
  - Relationships 1073
  - Toolbox Pages 1073
- Argument
  - Call, Synchronize With Behavior Parameter 582
  - For Behavioral Parameter 582
  - Invocation, Synchronize With Behavior Parameter 582
- Arrange
  - Connectors 613
- Arrow
  - Quick Linker 474
- Artifact
  - Element 810
- ASA
  - Data Repository, Connect To 162
  - ODBC Driver, Set Up 141
  - Repository, Create 132
  - Upsize To 170
- ASP .NET
  - Debug 1463
- Assembly
  - Connector 855
  - Debug 1461
  - Relationship 855
- Assign
  - Information to Tagged Values 636
  - People To Changes 1566
  - People To Defects 1566
  - Tagged Values To Item 635
- Assignments
  - BPEL, Create 981
- Associate
  - Calls With Behaviors 582
  - Connector 855
  - Invocations With Behaviors 582
  - Relationship 855
- Associated Files
  - Elements 507
- Association
  - Class 844
  - Connector 855
  - Connector, Set Collection Class 1345
  - Details 626
  - Dot On Connector 629
  - N-Ary 844
  - Properties 626
  - Relationship 855
  - Set Derived Property 608
  - Specialisation, Set Up 623
- Association Class
  - Connector 856
  - Link New Class To Association 857
  - Relationship 856
- Association End
  - Qualifiers 830, 832
- Asynchronous Signal Message
  - Associate With Signal 877
  - Connector 877
  - Relationship 877
- Attach
  - Note To Link 612
- Attach To Process Dialog 1472
- Attribute
  - Add And Delete, Automation Interface Code Example 1769
  - Add To Element, In-place Editor 592
  - Automation Interface, ElementFeatures Package 1727
  - Collections 562
  - Connect To 611
  - Constraints 563
  - Context Menu, Project Browser 1221

- Attribute
  - Copy Between Elements 544
  - Create 558
  - Create Fast, Option 1341
  - Create Object From 568
  - Definition 558
  - Delete 560
  - Delete If Not In Code In Reverse Synchronization 1341
  - Derived 560
  - Dialog 558
  - Dialog, Constraints Tab 563
  - Dialog, Detail Tab 562
  - Dialog, General Tab 560
  - Disconnect From 611
  - Edit Keyword 590
  - Edit Name, In-Place Editor 588
  - Edit Scope 589
  - Edit Stereotype, In-place Editor 588
  - Fast Create 558
  - Imported, Default Name Generated From 1341
  - Inherited, Display 567
  - Inherited, Show 438
  - Introduction 558
  - Link To Element Via Object 568
  - Message Part, WSDL 1060
  - Modify 558
  - Move Between Elements 545
  - Multiplicity 562
  - Of Toolbox Page 1135
  - PData & StyleEx, Diagram Profiles 1140
  - Private, Icon 1213
  - Properties, Create 565
  - Protected, Icon 1213
  - Qualifiers 562, 832
  - Redefine Property 562
  - Show On Diagram 438
  - Stereotyped, For Columns 1019
  - Supported, By XML Element Node 914
  - Supported, Create Composite Elements 1111
  - Supported, Define Child Diagram Types 1111
  - Supported, In UML Profile 914
  - Supported, Metatype In Profiles 1108
  - Supported, Stereotype In Profiles 1108
  - Tagged Values 564
  - UML Property, isUnique 562
  - Work With, Automation Interface Code Example 1773
- Automation Interface, ElementFeatures Package 1730
- Audit
  - Requirements 928
  - Scope 272
- Audit History Tab
  - Description 278
  - How To Display 278
  - On Output Window 102, 1258
- Audit Options
  - All 273
  - Connectors Audited 273
  - Core Structural 273
  - Custom 273
  - Elements Audited 273
  - Maintenance 273
- Audit View
  - Advanced Mode 276
  - Audit Changes 276
  - Controls 276
  - Custom Time Periods 276
  - Deleted Mode 276
  - Display Database Changes 276
  - Filter By Time 276
  - Performance Problems 279
  - Raw Mode 276
  - Refresh 276
  - Search 276
  - Slow Loading 279
  - Slow Navigation 279
  - Sort 276
  - Standard Mode 276
- Auditing
  - Alternative To Differencing 279
  - And Performance Of Enterprise Architect 270
  - And RTF Reporting 270
  - Audit Tree 274
  - Display Audit Results 274
  - Enable 272
  - How To Invoke 271
  - Include Reverse Engineering 272
  - Include XMI Export 272
  - Include XMI Import 272
  - Introduction 270
  - Large Deletion Issue 279
  - Level, Core 273
  - Level, Extended 273
  - Level, Standard 273
  - Performance Issues 279
  - Quick Start 271
  - Record Display 274
  - Reverse Engineering Issue 279
- AttributeConstraint
  - Automation Interface, ElementFeatures Package 1729
- AttributeTag



- Auditing
  - Settings 271, 272
  - Use Database Timestamp 272
  - View 274
  - XMI Import Issue 279
- Auditing Settings
  - Clear Logs 272
  - Load Logs 272
  - Save Logs 272
- Authentication
  - Accept Windows Authentication 191
  - Automatic Delete On Relocation Of Project 191
- Author
  - Attributes 1693
  - Define 645
  - From Windows Active Directory 645
  - Methods 1693
- Author Collection
  - Automation Interface Repository 1693
- Auto Counter
  - Of Elements 525
- Auto Naming
  - Of Element 525
- Auto Numbering
  - Of Elements 525
- Auto Route Diagram Layout 470
- Auto Save
  - Diagram Changes 359
- Autocompletion List
  - Code Editor, Common 1432
- Autohide
  - Reveal Autohidden Window 78
  - Turn Off 78
  - Turn On 78
  - Windows 78
- Autolayout
  - Diagram 471
  - Options 471
- Automatic
  - Save Of Diagram Changes 359
- Automatic Exclusive Edit Lock 189
- Automatic Indentation
  - Code Editor, Common 1431
- Automatic Recording
  - Execution Analysis, Recording Sequence Diagrams 1504
- Automatically Hidden Windows
  - Animate 59
- Automation
  - Of Enterprise Architect 1659
- Automation Interface
  - App Object 1674
  - Attribute, ElementFeatures Package 1727
  - AttributeConstraint, ElementFeatures Package 1729
  - AttributeTag, ElementFeatures Package 1730
  - Available Resources 1671
  - Call Executables From Enterprise Architect 1666
  - Call From Enterprise Architect 1670
  - Code Example, Add And Delete Attributes 1769
  - Code Example, Add And Delete Methods 1769
  - Code Example, Add And Manage Diagrams 1768
  - Code Example, Add And Manage Elements 1767
  - Code Example, Add And Manage Packages 1766
  - Code Example, Add Connector 1767
  - Code Example, Add Stereotypes 1773
  - Code Example, Iterate Through EAP File 1766
  - Code Example, Open The Repository 1765
  - Code Example, Use Element Extras 1769
  - Code Example, Use Repository Extras 1772
  - Code Example, Work With Attributes 1773
  - Code Example, Work With Methods 1774
  - Code Examples, Introduction 1765
  - Connect From Borland Delphi 7.0 1666
  - Connect From Java 1666
  - Connect From MS C# 1666
  - Connect From MS Visual Basic 6.0 1666
  - Connect To 1666
  - Connector Package Diagram 1738
  - Connector, Connector Package 1739
  - ConnectorConstraint, Connector Package 1738
  - ConnectorEnd, Connector Package 1742
  - ConnectorTag, Connector Package 1744
  - ConstLayoutStyles Enum 1675
  - Constraint, Element Package 1710
  - CreateBaselineFlag Enum 1676
  - CreateModelType Enum 1676
  - CustomProperties Collection, ElementFeatures Package 1730
  - Diagram Package 1745
  - Diagram, Diagram Package 1746
  - DiagramLinks, Diagram Package 1749
  - DiagramObjects, Diagram Package 1750
  - Effort, Element Package 1710
  - Element Package Diagram 1708
  - Element Package, File 1717
  - Element, Element Package 1711
  - ElementFeatures Package Diagram 1726

- Automation Interface
    - EmbeddedElements Collection, ElementFeatures Package 1731
    - Enumerations 1675
    - EnumRelationSetType Enum 1676
    - Examples 1666
    - Examples and Tips 1669
    - ExportPackageXMIFlag Enum 1677
    - Introduction 1666
    - Issue, Element Package 1718
    - MDGMenus Enum 1677
    - Method, ElementFeatures Package 1732
    - MethodConstraint, ElementFeatures Package 1733
    - MethodTag, ElementFeatures Package 1734
    - Metric, Element Package 1719
    - Model 1672
    - ObjectType Enum 1677
    - Package 1672
    - Parameter, ElementFeatures Package 1735
    - Partitions Collection, ElementFeatures Package 1736
    - Project Interface 1753
    - Project, Project Interface 1753
    - Properties, ElementFeatures Package 1736
    - Property ElementFeatures Package 1736
    - PropType Enum 1678
    - Reference 1671
    - ReloadType Enum 1678
    - Repository 1680
    - Repository Package 1679, 1698
    - Repository, Author Collection 1693
    - Repository, Client Collection 1694
    - Repository, Collection Class 1695
    - Repository, Datatype 1696
    - Repository, EventProperties 1697
    - Repository, EventProperty 1697
    - Repository, ModelWatcher 1698
    - Repository, ProjectIssues 1703
    - Repository, ProjectResource 1704
    - Repository, PropertyType 1704
    - Repository, Reference 1705
    - Repository, Stereotype 1706
    - Repository, Task 1707
    - Repository, Term 1708
    - Requirement, Element Package 1719
    - Resource, Element Package 1720
    - Risk, Element Package 1721
    - RoleTag, Connector Package 1744
    - Scenario, Element Package 1722
    - ScenarioDiagramType Enum 1678
    - ScenarioExtension, Element Package 1723
    - ScenarioStep, Element Package 1723
    - ScenarioStepType Enum 1679
    - ScenarioTestType Enum 1679
    - Set Up Visual Basic 1668
    - Swimlane, Diagram Package 1752
    - SwimlaneDef, Diagram Package 1751
    - Swimlanes, Diagram Package 1751
    - TaggedValue, Element Package 1724
    - Test, Element Package 1725
    - Transitions Collection, ElementFeatures Package 1737
    - Using 1666
    - VB GetObject Support 1674
    - XMIType Enum 1679
  - Autonumbering
    - And Requirements 918
  - Autosize
    - Element, Single 444
    - Elements, As Group 444
  - Available Resources
    - Automation Interface 1671
- B -**
- Base Project
    - Copy 121
    - New 121
  - Baseline
    - And Differences, Overview 279
    - Considerations 280
    - Create 282
    - Delete 281
    - Export 281
    - Import 281
    - Include XMI Stubs 282
    - Load From Alternative Model 281
    - Manage 281
    - Merge With Current Model, Overview 279
    - Model 280
    - Overview 280
    - Requirements 928
    - Scenarios 280
    - Versions 282
  - BaseModel Script
    - InnoDB 178
    - MyISAM 178
  - Basic Path, Scenario 490
  - Batch Generate
    - Elements With Code 69
    - RTF Resource Documents, Automatically 1606
    - RTF Resource Documents, Manually 1606

- Batch XMI
  - Export 298
  - Import 298
- Behavior
  - Associate With Calls 582
  - Associate With Invocations 582
  - Instance 892
  - Of Operation, Display In Diagram 573
  - Operation, Associate With 573
  - Parameter, Tagged Values 585
  - Parameters, Define 583
  - Synchronize Call Arguments With Parameters 582
  - Synchronize Invocation Arguments With Parameters 582
- Behavior Call
  - Actions For RuleTask Operations 943
  - Interaction Occurrence 581
  - Modeling 581
  - Parameter Arguments 582
- Behavioral Diagram
  - Elements 742
  - Overview 673
- Behavioral Model Templates 1193
- Behavioral Modeling 569
- Behavioral Models
  - Generate Code From 1314
- Behavioral Parameter
  - Edit 583
  - Extend 583
  - Reassign 583
  - Set 583
- Behaviors
  - Of Activities 581
  - Of Interactions 581
- Bend
  - Connector At Cursor 615
- Bend Connector 32
- Bezier Lines 615
- Binary Module
  - Import, Reverse Engineering 1334
- Binding
  - WSDL Diagram 1057
  - WSDL Element 1057
- Bitmap Image
  - In Diagrams 447
- Blue Exclamation Mark 206
- Bookmark
  - Clear 57
  - Clear All 57
  - Code Editor, Common 1430
  - For RTF Report 1639
  - Insert In RTF Template 1597
  - Multiple Elements 341
  - Package As 1639
  - RTF, In Master Document Element 1616
  - Selected Element 57
  - Triangle 341
- Bookmark Selected
  - Menu Option (Edit Menu) 57
- Border
  - Red 206
- Boundary
  - Element 836
  - Element Settings 803
  - Element, Create 836
  - Object Settings 803
  - Properties 803
- Box Diagram Layout 463
- BPEL
  - Assignments, Create 981
  - BPMN Elements Not Mapable 961
  - Concepts 958
  - Create Assignments 981
  - Create Model 959
  - Diagram 958
  - Disable 958
  - End Event, Model 965
  - Generate 983
  - In Enterprise Architect 958
  - Intermediate Event, Model 968
  - Looping Constructs 974
  - MDG Technology 958
  - Model A Process 961
  - Model Activity 974
  - Model Gateway 972
  - Model Pool 979
  - Model Sequence Flow Connector 980
  - Model Validation 984
  - Model, Create 959
  - Modeling Restrictions 958
  - Package Structure 959
  - Process, Properties 961
  - Start Event, Model 962
  - Sub Process Types 974
  - Task Types 974
  - Validation Violations 984
  - Web Service, Create 983
- BPMN
  - 1.0 952
  - 1.1 952
  - Change Element Appearance 956
  - Concepts 952
  - Connectors 952

- BPMN
  - Core Toolbox Page 952
  - Diagram 952
  - Disable 952
  - Element Appearance, Change 956
  - Elements 952
  - MDG Technology 952
  - Migrate 1.0 Model To 1.1 957
  - Relationships 952
  - Types Toolbox Page 952
  - Update Version Via Toolbox Element 956
  - Version Differences In Appearance 956
- BPMN 1.1
  - Activity Types 974
  - BPEL Sequence Flow 980
  - Elements Not Mappable to BPEL 961
  - End Event, Types 965
  - Gateway Types 972
  - Intermediate Event, Types 968
  - Pool 979
  - Start Event, Types 962
  - Sub-Process Types 974
  - Task Types 974
- Brace Matching
  - Code Editor, Common 1430
- Branching Macros
  - Code Template Syntax 1190
- Breakpoint
  - Delete 1468
  - Difference From Recording Marker 1503
  - Disable 1468
  - Enable 1468
  - Failure Message 1468
  - Management 1468
  - Set For Modifiable Data 1470
  - Set In Code 1469
  - States 1468
  - Storage 1469
- Breakpoints And Markers Window 1503
- Broadcast Event
  - Add-In Model 1787
  - EA\_FileClose 1788
  - EA\_FileNew 1789
  - EA\_FileOpen 1788
  - EA\_OnPostCloseDiagram 1789
  - EA\_OnPostInitialized 1802
  - EA\_OnPostOpenDiagram 1789
  - EA\_OnPostTransform 1803
  - EA\_OnPreExitInstance 1798
  - EA\_OnRetrieveModelTemplate 1820
- BroadcastSignal Action
  - Signal Tab 745
- Browser
  - Element 510
- Build And Run Submenu
  - Package Context Menu, Project Browser 1217
- Build Script
  - Create 1444
  - Deploy Script, Create 1484
  - Enable Diagnostic Messages, Sequence Diagram Recording Tab 1496
  - Enable Filter, Sequence Diagram Recording Tab 1493
  - Filters 1493
  - Limit Auto Recording, Sequence Diagram Recording Tab 1496
  - Options, Sequence Diagram Recording Tab 1492
  - Record Arguments To Function Calls, Sequence Diagram Recording Tab 1494
  - Record Calls To Dynamic Modules, Sequence Diagram Recording Tab 1495
  - Record Calls To External Modules, Sequence Diagram Recording Tab 1494
  - Recursive 1446
  - Run Script, Create 1482
  - Test Script, Create 1483
  - Wildcard in Filter 1493
- Build Scripts
  - Introduction 1443
- Build Systems Using UML
  - Enterprise Architect 5
- Built-In
  - Diagram Types 1140
  - Transformations 1388
- Business
  - Scenarios & Requirements 514
- Business Analyst
  - And Enterprise Architect 38
  - Project Role 38
- Business and Software Engineering Edition
  - Of Enterprise Architect 12
- Business Domain Model
  - Create 938
- Business Interaction Diagram
  - Description 739
  - Elements And Connectors 739
  - Example 739
- Business Model
  - Analysis 931
- Business Modeling
  - Business Process Outline 933
  - Events 932
  - Example 930
  - Goals 933

- Business Modeling
  - Information 931
  - Inputs 931
  - Outputs 932
  - Process Element 931
  - Process Modeling Notation 931
  - Processes 930
  - Resources 931
  - Traceability 1245
- Business Modeling Diagram
  - Description 739
  - Elements And Connectors 739
  - Example 739
- Business Process
  - Analysis 374
  - Model, Template 374
  - Outline 933
- Business Process Execution Language (BPEL) 958
- Business Process Modeling 733
- Business Process Modeling Notation (BPMN) 952
- Business Rule
  - Add To Rule Task 945
  - Create 945
  - Element 937
  - Export To CSV File 945
  - Generate Code 951
  - Modeling 937
  - Parameters As Variables 942
  - Remove From Rule Task 945
  - Validate 950
- Business Rule Modeling
  - Business Domain Model, Create 938
  - Business Rules 937
  - Compose Rules 945
  - Computation Rule Table 945
  - Decision Table 945
  - Export Rules To CSV File 945
  - Generate Code 951
  - In Class Operations 943
  - In RuleTask Actions 937
  - Overview 934
  - Rule Composer 945
  - Rule Flow Diagram 939
  - Rule Model 937
  - Vocabulary 938
- Modeling Conventions 1285, 1286
- Object Oriented Programmiing 1286
- Options 1349
- C#
  - Code Generation Language Options 1350
  - Import, Reverse Engineering 1331
  - Modeling Conventions 1287
  - Options 1350
  - Transformation 1389
- C++
  - Code Generation 1351
  - Debug Symbols 1452
  - Implementation Files 1351
  - Import, Reverse Engineering 1331
  - Language Options 1351
  - Modeling Conventions 1289
  - Modeling Conventions, CLI Extensions 1291
  - Modeling Conventions, Managed 1290
  - Set Up Debug Session 1451
- Calibration
  - Of Project Factors 335
- Call
  - Associate With Behaviors 582
  - Automation Interface From Enterprise Architect 1670
  - Re-associate With Behavior 582
  - Self Message 872
  - Synchronize Arguments With Behavior Parameters 582
- Call Action
  - Pin As Argument 749
- Call Stack
  - Copy To Recording History 1482
  - Create Sequence Diagram 1480
  - Save 1482
  - View 1473
  - Window 1473
- Calltips
  - Code Editor, Common 1432
- Camel Case
  - Naming Format 1422
- Cancel
  - Default Diagram, Model 437
  - Validation 64
- Capture State Changes
  - Setup To, Visual Execution Analyzer 1508
- Cardinality (Multiplicity)
  - Define 665
- CASE Tool
  - Enterprise Architect 3
- Category
  - Add To Team Review 211
- C -**
- C
  - Code Generation Language Options 1349
  - Import, Reverse Engineering 1331

- Category
  - Create 211
  - Delete 209
- Central Buffer Node
  - Element 758
- Chaining Transformations 1388
- Change
  - BPMN Element Appearance 956
  - Connector Source Or Target 614
  - Connector Type 614
  - Diagram Type 434
  - Element 1563
  - Element Type 532
  - Elements And Requirements 928
  - Form Of Aggregation Connector 855
  - Tracking 269, 270
- Change Conflicts
  - Resolve 187
- Change Element
  - Hide Stereotype Letter 1564
  - Show Stereotype Letter 1564
- Change Management
  - And Requirements 928
  - Auditing 228
  - Baselines And Differences 228
  - In Enterprise Architect 228
  - Introduction 228
  - Model Transfer 287
  - Project Data Transfer 228
  - Tracking Changes 269
  - Version Control 228
- Character Set
  - Set Up For RTF Report 1615
  - Set Up For RTF Report (Legacy) 1637
- Check
  - Data Integrity 344
  - Model Integrity 344
  - Project Integrity 344
- Check Constraint
  - Create 1033
  - What Is A? 1033
- Check In
  - Branch 261
  - Explanation 257
  - Offline Packages 268
  - Packages Online 261
  - Project Browser Icon 261
- Check Out
  - Branch 261
  - Explanation 257
  - Packages Offline 261, 268
  - Project Browser Icon 261
- Checked In Package
  - Icon 1213
- Checked Out Package
  - Icon 1213
- Child
  - Confirm Element As Parent 529
- Child Element
  - Paste Object As 430
- Choice
  - Element 758
- Circle Diagram Layout 459
- Class
  - Active Classes 812
  - Collection, Set 1345
  - Created In Transformation, Connect To 1419
  - Element 811
  - Elements And Connectors 407
  - Elements, Imported 1367
  - Group, Toolbox 407
  - Make Into Association Class 857
  - Members, Show/Hide On Diagram 429
  - Model Template 376
  - Parameterized Classes (Templates) 813
  - Partial 1287
  - Partial, Generate 1311
  - Reset Options 1361
  - Show Realised Interfaces On Diagram 452
  - Source Code Generation 1308
  - View 383
- Class Diagram
  - Description 721
  - Edit Elements 68
  - Elements And Connectors 721
  - Example 721
- CLASSGUID
  - Add-In Hidden Field 1781
- Classifier
  - Behavior 779
  - Drop As Link 430
  - Drop As New Instance 430
  - Item Conveyed 865
  - Of Objects 519
  - Properties 726
  - Set 520
  - Use 520
- CLASSTYPE
  - Add-In Hidden Field 1781
- Clean
  - Project 344
- Clear All Bookmarks
  - Menu Option (Edit Menu) 57
- Clear Project Clipboard

- Clear Project Clipboard
  - Menu Option (Edit Menu) 57
- Clear Selection
  - Menu Option (Edit Menu) 57
- CLI Extensions
  - C++ Modeling Conventions 1291
- Client
  - Define 651
- Client Collection
  - Automation Interface Repository 1694
- Clipboard
  - Copy Team Review Path To 218
- Clipboard File Format
  - Define 351
- Close
  - Full Screen 74
- Close Project
  - Menu Option (File Menu) 56
- CLR Versions
  - Debug .NET 1462
- Code
  - Breakpoint, Set 1469
  - Debug, Step Into Function Calls 1473
  - Debug, Step Out Of Functions 1473
  - Debug, Step Over Lines 1472
  - Debug, Step Through Function Calls 1480
  - Delete From Features In Model In Fwd Synchronization 1341
  - Generate For Business Rule 951
  - Generated From State Machine 1317
  - Generation, Toolbar 81
  - Import, Select Language 81
  - Language, Set Default 81
  - Synchronize 1307
- Code Breakpoint
  - Set 1469
- Code Editor, Common
  - Autocompletion List 1432
  - Automatic Indentation 1431
  - Bookmarks 1430
  - Brace Matching 1430
  - Calltips 1432
  - Commenting Selections 1431
  - Configure Search Options 1437
  - Context Menu 1437
  - Cursor History 1430
  - Customize 1428
  - Debug Tooltips 1479
  - Functions 1428
  - IME 1437
  - Input Method Editor 1437
  - Intellisense 1432
- Key Bindings 1433
- Line Selection 1432
- Mouseovers 1432
- Overview 1428
- Scope Guides 1431
- Search Facility 1437
- Syntax Highlighting 1429
- Tooltips, Debug 1479
- Zooming 1432
- Code Engineering
  - And MDG Integration 1334
  - Broad View Of, In Enterprise Architect 1279
  - Code, Reverse Engineer 1328
  - Eclipse 1334
  - Element Context Menu 554
  - Generate Code For Single Class 1309
  - Generate Group of Classes 1311
  - Generate Package 1311
  - Generate Package Source Code 1311
  - Generate Source Code 1308
  - Introduction 1281
  - Namespaces 1313
  - Object Lifetimes 1340
  - Package Contents, Update 1313
  - Referenced XML Schema 1373
  - Reverse Engineer Source Code 1328
  - Settings 1335
  - Settings, Attribute/Operation Options 1341
  - Settings, Code Generation Constructor/Destructor Options 1340
  - Settings, Code Page for Source Editing 1342
  - Settings, General Code Options 1336
  - Settings, Import Component Types 1337
  - Settings, Source Code Options 1336
  - Synchronization 1328
  - Synchronize Model And Code 1327
  - Synchronize Package Tree 1313
  - UML Profile For XSD 1041
  - Unicode Character Set 1342
  - Update Package Contents 1313
  - Visual Studio 1334
  - With Enterprise Architect 1279
  - XML Schema 1039
  - XML Schema (XSD), Default UML To XSD Mappings 1049
  - XML Schema, Abstract XSD Models 1047
  - XML Schema, Generate XSD 1376
  - XML Schema, Import XSD 1373
  - XML Schema, Model XSD 1040
  - XSD 1039
  - XSD Datatype Packages 1047
- Code Engineering Submenu

- Code Engineering Submenu
  - Package Context Menu, Project Browser 1217
- Code Generation
  - ActionScript Language Options 1348
  - Ada 2005 Language Options 1348
  - C Language Options 1349
  - C# Language Options 1350
  - C++ Language Options 1351
  - Delphi Language Options 1352
  - From Activity Diagrams 1314, 1323
  - From Behavioral Models 1314
  - From Interaction Diagrams 1314, 1322
  - From Sequence Diagrams 1314, 1322
  - From State Machine Diagrams 1314, 1316
  - Java Language Options 1355
  - Language Options 1347
  - MDG Technology Language Options 1360
  - PHP Language Options 1356
  - Python Language Options 1356
  - SystemC Language Options 1357
  - VB.NET Language Options 1358
  - Verilog Language Options 1358
  - VHDL Language Options 1359
  - Visual Basic Language Options 1360
- Code Language
  - Create Properties As Attributes 565
- Code Language Options 1338
- Code Module
  - Add To MDG Technology 1128
- Code Sections
  - Synchronize 1308
- Code Template
  - Base Templates 1302
  - Custom Templates, Create 1202
  - Default Templates 1204
  - Editor 1202, 1305
  - Editor, Add New Stereotyped Templates 1205
  - Editor, Create Templates For Custom Languages 1206
  - Editor, In SDK 1202
  - Export 1202
  - Framework, In SDK 1172
  - Framework, Overview 1301
  - Import 1202
  - Overview 1302
  - Syntax, Introduction 1172
  - Syntax, Literal Text 1172
  - Syntax, Macros 1173
  - Syntax, Template Substitution Macros 1173
- Code Template Syntax
  - Variable Definitions 1200
  - Variable References 1200
- Variables 1200
- Codepage
  - Set Up For RTF Report 1615
  - Set Up For RTF Report (Legacy) 1637
- Collaboration
  - Element 814
  - Elements and Connectors, Now Communication 409
  - Message 880
- Collaboration Diagram
  - Description 715
  - Elements And Connectors 715
  - Example 715
  - Message Colors 716
- Collaboration Occurrence
  - Element 815
- Collaborative Development 1343
- Collection Class
  - Automation Interface Repository 1695
- Collection Classes
  - Set 1345
- Collections, EASL
  - Action 1194
  - Behaviors 1194
  - Classifier 1194
  - Construct 1194
  - Node 1194
  - State 1194
  - State Machine 1194
  - Transition 1194
  - Trigger 1194
  - Vertex 1194
- Color
  - Of Communication Messages 366
- Color Code External Requirements 920
- Color Query
  - Shape Scripts 1158
- Column
  - Create In Data Modeling 1019
  - Definition 1019
  - In UML Data Modeling Profile 1019
  - Order, Change 1019
  - Properties 1019
  - Sequence Entries 1019
  - Stereotyped Attribute 1019
  - Unique 1019
- COM Interop
  - Debug .NET 1463
- COM Object
  - .NET Garbage Collect (Exit Method) 1680
- Combine
  - Windows In One Frame 76



- Combined Fragment
  - Create 761
  - Element 759
  - Interaction Operator 762
- Comma Separated Value
  - Export 300, 303
  - Import 300, 305
- Command
  - Deploy, Create 1484
  - Deploy, Introduction 1484
  - Run, Create 1482
  - Run, Introduction 1482
  - Unit Test, Create 1483
  - Unit Test, Introduction 1483
- Commands
  - Add To Toolbar 91
  - Change Icon Appearance 91
  - Customize 91
  - Remove From Toolbar 91
- Commenting Selections
  - Code Editor, Common 1431
- Common
  - Connectors 405
  - Elements 405
  - Group, Toolbox 405
  - Relationships 405
- Communication
  - Connector 859
  - Elements and Connectors 409
  - Group, Toolbox 409
  - Message 879
  - Message, Create 880
  - Message, Level 880
  - Message, Properties 880
  - Message, Sequence 880
  - Relationship 859
- Communication Diagram
  - Description 715
  - Elements And Connectors 715
  - Example 715
  - Labelled Associations 715
  - Message Colors 716
  - Numbering In 715
- Communication Message
  - Colors 366
- Communication Path
  - Connector 858
  - Relationship 858
- Community Site 23, 50
- Compact
  - Project .EAP File 348
- Compare
  - Data 308
  - DDL With Database 1369
  - Models 308
  - Projects, Instructions 308
  - Projects, Why? 308
  - Utility 279, 283
- Compare Utility
  - Context Menu 285
  - Keyboard Options 285
  - Merge Options 285
  - Options 284
  - Output 284
  - Tab 284
  - Toolbar 285
- Compartment
  - Constraint 521
  - Element 521
  - Maintenance 521
  - Responsibility 521
  - Tag 521
  - Testing 521
- Compartment Events
  - Add-In Model 1809
  - EA\_GetCompartmentData 1810
  - EA\_QueryAvailableCompartments 1809
- Compiled August 10 2010 3
- Complex Modeling
  - Enterprise Architect 5
- Component
  - Description 730
  - Diagram 730
  - Element 816
  - Elements And Connectors 412, 730
  - Example 730
  - Group, Toolbox 412
  - Model Template 378
  - View 383
- Compose
  - Connector 858
  - Relationship 858
- Composite
  - Elements 837
  - Elements And Connectors 409
  - Foreign Key 1025
  - Group, Toolbox 409
  - State 789, 790
  - State Regions 681
- Composite Aggregation
  - Connector 858
  - Relationship 858
- Composite Element
  - Paste From Project Browser 431

- Composite Elements
  - Metaclass, Create With Supported Attributes 1111
- Composite Structure Diagram
  - Description 724
  - Elements And Connectors 724
  - Example 724
- Compress
  - Timeline 703
  - Transition 703
- Computation Rule Table
  - Business Rule Modeling 945
- Concept
  - Archimate 1073
  - BPEL 958
  - BPMN 952
  - Eriksson-Penker MDG Technology 1080
  - Mind Mapping 1087
  - SoaML 1089
  - SPEM 1061
  - SysML 989
- Concurrent Method Calls
  - In Add-Ins 1779
- Concurrent Substate
  - Regions 681
- Conditional Node
  - Structured Activity 796, 798
- Conditional Substitution
  - Field Substitution Macros, Code Template Syntax 1174
- Configuration
  - Apache Tomcat Server 1459
  - JBOSS Server 1458
  - Tomcat Server 1459
  - Tomcat Service 1460
- Configure
  - Controlled Packages With XMI 295
  - Export To XMI Stubs 295
  - Local Options 350
  - Model Validation 1530
  - Options 350
  - Package For Version Control 259
  - Packages 295
  - User Registry Settings 350
  - Version Control, Subversion 250
- Configure Timeline Dialog
  - States Tab 697
  - Transitions Tab 699
- Confirm
  - Parent Element 529
- Connect
  - Elements 610
- Objects 610
  - To ASA Data Repository 162
  - To Automation Interface 1666
  - To Data Repository 147
  - To Element Feature 611
  - To MSDE Server Data Repository 165
  - To MySQL Data Repository 148
  - To Oracle 10g Data Repository 153
  - To Oracle 11g Data Repository 153
  - To Oracle 9i Data Repository 153
  - To PostgreSQL Data Repository 160
  - To Progress OpenEdge Data Repository 165
  - To SQL Server Data Repository 150
- Connections
  - In Relationships Window 1269
  - In Team Review 218
  - To Other Team Reviews 218
  - Window 1269
- Connector
  - Activity Edge 867
  - Add Between Locked Elements 204
  - Add Note 612
  - Add To Diagram 32
  - Add To UML Model, Quick Start 32
  - Add, Automation Interface Code Example 1767
  - Advanced, Menu Section 608
  - Aggregate 854
  - Appearance 609
  - Application 414
  - Arrange 613
  - Assembly 855
  - Associate 855
  - Association 855
  - Association Class 856
  - Asynchronous Signal Message 877
  - At Page Boundaries 615
  - Automation Interface, Connector Package 1739
  - Bend At Cursor 615
  - Bend Connector 32
  - BPMN 952
  - Break Connection To Feature 611
  - Change Source Or Target 614
  - Change Type 614
  - Characteristics, Edit 608
  - Communication 859
  - Communication Path 858
  - Compose 858
  - Composite Aggregation 858
  - Connect To Element Feature 611
  - Connector 859

- Connector
  - Constraints 628
  - Context Menu 606
  - Control Flow 860
  - Copy Between Instances Of Elements From Project Browser 618
  - Create Between Elements 618
  - Create From Project Browser 618
  - Create From Toolbox 399
  - Create In MDA-Style Transformation 1419
  - Create With Element Using Quick Linker 475
  - Create With Quick Linker 476
  - Create, Same Type As Previous 65
  - Custom Properties 550
  - Custom Properties, Set Value 608
  - Data Flow 1076
  - Delegate 861
  - Delete 619
  - Dependency 861
  - Dependency, Apply Stereotype 862
  - Deployment 862
  - Destination Role 631
  - Details 626
  - Direction Indicator 452
  - Display Options 364
  - Duplication In Transformation 1419
  - Edge 615
  - Entity Relationship Diagram 1077
  - Extend 862
  - Extension (Profile Toolbox) 414
  - Generalization 863
  - Generalize 863
  - Generalize (Profile Toolbox) 414
  - Hide 619
  - Hide/Show 609
  - Implements 889
  - Include 864
  - Information Flow 864
  - Inheritance 863
  - In-place Editor Options 623
  - Interrupt Flow 867
  - Invoke 406
  - Labels 452
  - Labels, Edit 623
  - Line Color 353
  - List For Requirements 921
  - List, On Context References Tab 506
  - Locked 204
  - Manifest 867
  - Message 867
  - Move 34, 613
  - Multiplicity 629
  - Nesting 885
  - Notelink 886
  - Notes 641
  - Object Flow 886
  - Occurrence 888
  - Off Page 615
  - Off-Page 606
  - Overview 852
  - Package Import 888
  - Package Merge 888
  - Page Boundary 615
  - Pkg Import 888
  - Pkg Merge 888
  - Precede 406
  - Properties 626
  - Properties Menu 607
  - Realization, Common Diagram 921
  - Realization, Quick Generation Of 921
  - Realize 889
  - Recursion 890
  - Redefinition 414
  - Relationship 859
  - Representation 891
  - Represents 891
  - Reverse Direction 623
  - Role Binding 890
  - Role, Context Menu 606
  - Self-Message 871
  - Shape Script Properties 1158
  - Source Role Properties 629
  - Styles 608, 615
  - SysML Activity 996
  - SysML Block Definition 992
  - SysML Interaction 998
  - SysML Internal Block 994
  - SysML Model 991
  - SysML Parametric 995
  - SysML Requirement 1001
  - SysML State Machine 999
  - SysML Use Case 1000
  - Tagged Value (Profile Toolbox) 414
  - Tagged Value, Use 1101
  - Tagged Values 631
  - Target Role Properties 631
  - Tasks 609
  - To Class Created In Transformation 1419
  - Trace 892
  - Transform 1419
  - Transition 892
  - Type Specific Menu Section 607
  - Type, Change 614
  - Usage 894

- Connector
  - Use 894
  - Visibility 609, 619, 621
  - What Is A? 852
  - Working With 606
- Connector Package
  - Connector, Automation Interface 1739
  - ConnectorConstraint, Automation Interface 1738
  - ConnectorEnd, Automation Interface 1742
  - ConnectorTag, Automation Interface 1744
  - RoleTag, Automation Interface 1744
- Connector Package Diagram
  - Automation Interface 1738
- Connector Styles
  - Auto Routing 615
  - Bezier 615
  - Custom 615
  - Direct 615
  - Lateral 615
  - Line Style 615
  - Set 615
  - Tree Style 615
- ConnectorConstraint
  - Automation Interface, Connector Package 1738
- ConnectorEnd
  - Automation Interface, Connector Package 1742
- ConnectorTag
  - Automation Interface, Connector Package 1744
- Console
  - Commands, Scripter Window 1663
  - Tab, Scripter Window 1663
- Constant
  - Custom, For RTF Reports 1614
- ConstLayoutStyles Enum
  - Automation Interface 1675
- Constraint
  - Automation Interface, Element Package 1710
  - Compartment, Element 521
  - Delete 563
  - Element 488
  - In Connector 628
  - In Scenarios & Requirements Window 514
  - Inherited, Show 438
  - Internal, Import As Test 1547
  - Note, Element 785
  - Of Attributes, Create 563
  - Post Condition On Actions 752
  - Post-Condition, RTF Reporting 1585
  - Precondition On Actions 752
  - Pre-Condition, RTF Reporting 1585
  - Profile 1101
  - RTF Report Template Sections 1585
  - Status Type, Define 656
  - Stereotype 1101
  - Supported In UML Profiles 912
  - Synchronize, And Tagged Values 910
  - Synchronize, From MDG Toolbox Pages 910
  - Synchronize, From Resources Window 910
  - Tab, Scenario 507
  - Type, Define 655
- Contents
  - Table, MS Word, Add 1641
- Contents Submenu
  - Package Context Menu, Project Browser 1218
- Context Diagram 1076
- Context Element
  - Highlight 543
  - In Multiple Selection 543
- Context Item Events
  - Add-In Model 1807
  - EA\_OnContextItemChanged 1807, 1809
  - EA\_OnContextItemDoubleClicked 1808
- Context Menu
  - Apply «Stereotype» Option 399, 910
  - Attribute, Project Browser 1221
  - Code Editor, Common 1437
  - Configure Code Editor Search Options 1437
  - Connector 606
  - Connector Label 452
  - Connector Role 606
  - Diagram 394
  - Diagram, Project Browser 1220
  - Element 547
  - Element Label 452
  - Element, Add Supporting Diagrams and Elements 550
  - Element, Multiple Selection 557
  - Element, Project Browser 1218
  - Item, Structural Specification 496
  - Linked Document Editor 600
  - Main 54
  - Method, Project Browser 1221
  - Model Views 1224
  - Model, Project Browser 1213
  - New Element Or Connector 395
  - Operation, Project Browser 1221
  - Package, Project Browser 1214
  - Project Browser 1213
  - Scripter Window 1661
  - Selected Text, Structural Specification 497
  - Structural Specification Entry Points 498

- Context Menu
  - Team Review Options 209
- Context Reference
  - Add Comments, On Context References Tab 506
  - Add, On Context References Tab 506
  - Delete, On Context References Tab 506
  - List, On Context References Tab 506
  - Tab 506
- Continuation
  - Element 792
- Control
  - Create 838
  - Element 838
- Control Flow
  - Connector 860
  - Guard 860
  - Relationship 860
  - Weight 860
- Control Macros
  - Code Template Syntax 1190
- Control Recording
  - Execution Analysis, Recording Sequence Diagrams 1504
- Controlled Package 259
  - Batch Export To XMI 298
  - Batch Import From XMI 298
  - Disconnect 296
  - Load 297
  - Menu, XMI 294
  - Recovery 299
  - Version Control 299
  - With XMI 293
- Converge Diagram Layout 467
- Convert
  - Linked Element To Local Copy 544
  - Names In MDA Transformations 1422
- CONVERT\_DB\_TYPE 1421
- CONVERT\_NAMES 1422
- CONVERT\_TYPE 1421
- Convey
  - Information Item 865
- Copy
  - Attributes Between Elements 544
  - Base Project 121
  - Diagram Image To Clipboard 436
  - Diagram Image To Disk File 435
  - Diagram, Deep 436
  - Diagram, Shallow 436
  - Element Between Packages 531
  - Element On Diagram 433
  - Elements Between Diagrams 34
  - Maintenance Item Between Categories 1561
  - Model 115, 116, 117
  - Operations Between Elements 544
  - Package 388
  - Packages Between Projects 309
  - RTF Bookmark To Clipboard 1216, 1220
  - Test Between Categories 1544
  - UML Diagram, Deep 436
  - UML Diagram, Shallow 436
- Copyright Notice 16
- CORBA
  - MDG Technology For, Enterprise Architect 1073
- Co-Region Notation 868
- Corporate Edition
  - Of Enterprise Architect 12
- Correct Spell Checked Words 1553
- Corrupt EAP file 348
- Create
  - A Project In Enterprise Architect 28
  - Access 2007 Repository 123
  - Activity, BPEL 974
  - Adaptive Server Anywhere Repository 132
  - Add-In 1777
  - Attribute Properties 565
  - Baselines 282
  - Boundary Element 836
  - BPEL Assignments 981
  - BPEL Model 959
  - BPEL Web Service 983
  - Build Script 1444
  - Check Constraint 1033
  - Columns In Data Modeling 1019
  - Combined Fragment 761
  - Communication Messages 880
  - Connector With Quick Linker 476
  - Control Element 838
  - Custom Diagram Background, Image Manager 448
  - Custom Tagged Values 1171
  - Custom View, Add-In Model 1821
  - Data Repository 123
  - Design Master, Replication 185
  - Diagram 422
  - Diagram From Linked Document 602
  - Diagram, Automatically 387
  - Document Artifact 599
  - Documents 1568
  - Element And Connector With Quick Linker 475
  - Element From Linked Document 602
  - Element From Maintenance Item 1561
  - Element In Diagram 523

## Create

- Element On Diagram From Project Browser 430
- Element Template 542
- Elements 523
- End Event, BPEL 965
- Entity 839
- Favorites Folder, Model View 1223
- Favorites Folder, Model View (Context Menu) 1224
- Foreign Key 1025
- Gateway, BPEL 972
- Hidden Submenu In Toolbox Profile 1135
- HTML Report 1647
- Index (Data Modeling) 1033
- Intermediate Event, BPEL 968
- Link Between Elements 618
- Linked Document Template 603
- Masked Tagged Values 1171
- MDG Technologies, Overview 1118
- Model 120
- MSDE Server Repository 134
- MySQL Repository 123
- Notes 536
- Oracle 10g Server Repository 129
- Oracle 11g Server Repository 129
- Oracle 9i Server Repository 129
- Pattern 902
- Pool, BPEL 979
- Post In Team Review 213
- PostgreSQL Repository 129
- Primary Key 1022
- Primary Key Name Template 1022
- Profiles 1095
- Progress OpenEdge Repository 134
- Project 120
- Project File 112
- Reference Data Tagged Values 1170
- Relationship Using Matrix 1266
- Replicas 185
- Requirements 918
- Rich Text Format Report (Enhanced Generator) 1570
- Root Node, Model View 1223
- Root Node, Model View (Context Menu) 1224
- RTF Report (Enhanced Generator) 1570
- RTF Style Template 1576
- RTF Style Template (Legacy) 1634
- Search Definition 1239
- Sequence Flow, BPEL 980
- Slideshow, Model View 1223
- Slideshow, Model Views 1228
- Sorted Lookup Table 1033
- SQL Server Repository 126
- Start Event, BPEL 962
- Structured Tagged Values 1168
- Table in Data Modeling 1013
- Tasks Pane Profiles 1141
- Team Review Category 211
- Team Review Topic 212
- Text 536
- Timing Diagram 692
- Timing Message 883
- Toolbox Profile For MDG Technology 1134
- Trigger Operation 1033
- UML Diagram 422
- UML Pattern 902
- Unique Constraint 1033
- View, Data Modeling 1032
- Views Folder, Model View 1223
- Views Folder, Model View (Context Menu) 1224
- Views, Model View 1223
- Views, Model View (Context Menu) 1224
- Create Property Implementation Dialog 565
- CreateBaselineFlag Enum
  - Automation Interface 1676
- CreateModelType Enum
  - Automation Interface 1676
- Cross Reference
  - Between EMX Files 291
  - Delete 527
  - Set For Element 527
  - Trace With Traceability Window 1253
  - Use In Element 527
- CSV
  - Export 300, 303
  - Export From Relationship Matrix 1267
  - Export From Rule Composer 945
  - Export State Machine Table To 690
  - Import 300, 305
  - Import Requirement Hierarchies 922
  - Import Requirements 922
  - Preserve Hierarchy 300
  - Specifications 300
- CTF
  - In SDK 1172
  - Overview 1301
- Current Connector
  - Toolbar 84
- Current Element
  - Toolbar 84
- Cursor History
  - Code Editor, Common 1430

- Custom
    - Diagram 736, 737, 738
    - Diagram Types 1139
    - Elements and Connectors 417
    - Group, Toolbox 417
    - Stereotypes 1093
  - Custom Background
    - Create For Diagram, Image Manager 448
  - Custom Diagram
    - Description 734
    - Elements And Connectors 734
    - Example 734
    - Model 734
  - Custom Language
    - Create Templates For In Code Template Editor 1206
    - Settings, RTF Report Generation 1615
  - Custom Properties
    - Dialog 550
    - For Connectors 550
    - For Elements 550
  - Custom Reference
    - Delete 527
    - Set For Element 527
    - Trace With Traceability Window 1253
    - Use In Element 527
  - Custom Tagged Values
    - Create 1171
  - Custom Template
    - Create From Project 120
  - Custom Tools
    - External Applications 96
  - Custom View
    - Add-In Model 1820
  - Customize
    - Commands 90, 91
    - Diagram Appearance 423
    - Dialog 90
    - External Tools, Pass Parameters To 97
    - Keyboard 90
    - Keyboard Shortcuts 98
    - Menu Appearance 100
    - Menus 90
    - Options 90
    - RTF Language 1615
    - RTF Language (Legacy) 1637
    - Toolbar Option Appearance 101
    - Toolbars 90, 92
    - Tools 90, 94
    - Visibility Of Elements 535
    - Window 90
  - Automation Interface, ElementFeatures Package 1730
  - Cut And Paste
    - Elements Between Diagrams 34
  - CVS
    - Remote Repository 240
    - Version Control Options 240, 244
    - Version Control With Local Repositories 244
- D -**
- Dashed Border
    - On Element 529
  - Data
    - Breakpoint, Set 1470
    - Compare 308
    - Export 223
    - Import 225
    - Integrity 344
    - Integrity Check 344
    - Integrity, Run SQL Patches 346
    - Model Template 377
  - Data Breakpoint
    - Set 1470
  - Data Distribution Service
    - MDG Technology For, Enterprise Architect 1073
  - Data Flow
    - Concepts 1076
    - Connector 1076
    - Context Diagram 1076
    - Diagram 1076
    - MDG Technology 1076
    - Relationship 1076
    - Toolbox Page 1076
  - Data Management
    - Project Compare 71
    - Project Integrity 71
    - Project Transfer 71
    - Submenu (Tools Menu) 71
  - Data Model
    - To ERD Transformation, MDA-Style Transform 1390
    - Transformation From Entity Relationship Diagram 1399
    - Transformation To Entity Relationship Diagram 1390
  - Data Modeling
    - Advanced Processes 1031
    - Check Constraint 1033
    - Compare DDL With Database 1369
    - Create Columns 1019

- Data Modeling
  - Create Table 1013
  - Data Model Diagram 1013
  - Data Type Conversion Procedures 1035
  - DBMS Conversion Procedure Package 1036
  - DBMS Data Types 1037
  - DDL, Generate 1367
  - Elements And Connectors 421
  - Foreign Keys 1024
  - Generate DDL 1367
  - Generate DDL For A Package 1369
  - Group, Toolbox 421
  - Index 1033
  - Introduction 1011
  - Primary Key Extended Properties 1024
  - Primary Key, Create 1022
  - Profile (UML) 1011
  - Set MySQL Table Type 1016
  - Set Oracle Table Properties 1017
  - Set Schema Owner 1016
  - Set Table Owner 1016
  - Set Table Properties 1014
  - Sorted Lookup Table 1033
  - Stored Procedure 1030
  - Trigger Operation 1033
  - Typical Tasks 1011
  - Unique Constraint 1033
- Data Repository
  - Adaptive Server Anywhere, Connect To 162
  - Connect To 112, 147
  - Create 123
  - MSDE Server, Connect To 165
  - MySQL, Connect To 148
  - Oracle 10g, Connect To 153
  - Oracle 11g, Connect To 153
  - Oracle 9i, Connect To 153
  - Oracle, Connect Via ODBC 153
  - Oracle, Connect Via OLE DB 153
  - PostgreSQL, Connect To 160
  - Progress OpenEdge, Connect To 165
  - SQL Server, Connect To 150
- Data Source
  - Select 1365
- Data Store
  - Element (Data Flow Diagram) 1076
- Data Transfer
  - Between Repositories 306
  - Compare Projects, Instructions 308
  - Compare Projects, Why? 308
  - Copy Packages Between Projects 309
  - Transfer Project Data 307
  - Upsize to MySQL 178
- Data Type
  - Add 666
  - Code 666
  - Conversion Procedures 1035
  - DBMS 1037
  - Definition 293
  - Delete 666
  - Element 817
  - Extend 666
  - Instance 817
  - Modify 666
  - Programming Language 666
  - Referenced 817
- Database
  - Compare Package DDL With 1369
  - Default 1337
  - Design 1011
  - Keys 1011
  - Model Template 377
  - Modeling 1011
  - Schema, Import Of 1011
  - Set Default 81
  - Supported Types 1011
  - View, Report On 1032
- Database Administrator
  - And Enterprise Architect 47
  - Project Role 47
- Database Engineering
  - Introduction 1363
  - Submenu (Project Menu) 63
- Database Modeling
  - Enterprise Architect 5
- Database Operation Properties
  - Dialog 1024
- Database Repository
  - Access Permissions For 122
  - Connect To 122
  - Create 122
  - Set Up 122
- Database Schema
  - Description 739
  - Diagram 739
  - Elements And Connectors 739
  - Example 739
- Database Table
  - Select From ODBC Data Source 1366
- Datastore
  - Element, Activity Diagram 764
- Datatype
  - Automation Interface Repository 1696
- DBMS
  - Conversion Procedures 1035



- DBMS
  - Data Type Conversion Procedures 1035
- DBMS Conversion
  - Mapper 1036
  - Procedure 1036
  - Table Conversion Between DBMS Types 1036
- DDL
  - Compare With Database 1369
  - Data Modeling 1367
  - Default Script Editor 1337
  - Display In Source Code Viewer 1441
  - Generate 1367
  - Generate For Package 1369
  - Generate For Table 1367
  - Import Schema From ODBC 1363
  - Schema, Import From ODBC 1363
  - Scripts And Generated Tables 1011
  - Transformation 1393
- DDS
  - MDG Technology For, Enterprise Architect 1073
- Debug
  - .NET 1447, 1460
  - .NET Assembly 1461
  - .NET CLR Versions 1462
  - .NET With COM Interop Process 1463
  - Another .NET Process 1472
  - ASP .NET 1463
  - Break On Variable Changing Value 1477
  - Create Sequence Diagram, Call Stack 1480
  - Deploy Script, Create New 1484
  - Deploy Script, Introduction 1484
  - Enterprise Architect 5
  - File Search, Introduction 1485
  - File Search, Use 1485
  - Inspect Process Memory 1476
  - Java 1447, 1452
  - Java Applets In Internet Browsers 1454
  - Java Web Servers 1456, 1460
  - Java, Advanced Techniques 1454
  - Java, General Setup 1453
  - On Windows 7 And Windows Vista 1448
  - Platforms 1447
  - Recording Actions 1480
  - Run Script, Create New 1482
  - Run Script, Introduction 1482
  - Save Call Stack 1482
  - Script Search 1485
  - Search Window 1485
  - Show Loaded Modules 1478
  - Show Output 1478
  - Step Into Function Calls 1473
  - Step Out Of Functions 1473
  - Step Over Lines Of Code 1472
  - Step Through Function Calls 1480
  - Tooltips In Code Editor 1479
  - Under Windows Vista 1447
  - Unit Test Script, Create 1483
  - Unit Test Script, Introduction 1483
  - View Call Stack 1473
  - View Local Variables 1474
  - View Local Variables, Long Values 1474
  - View Variables In Other Scopes 1475
  - WINE Applications 1450
- Debug Session
  - Debug C++ 1451
  - Java, Attach To VM 1454
  - Microsoft Native Setup 1451
  - Set Up 1447
  - Set Up For .NET 1461
  - Set Up For Microsoft Native 1451
  - Start 1471
  - Stop 1471
- Debug Symbols
  - Debug C++ 1452
  - Microsoft Native 1452
- Debugger
  - Actions 1446
  - Debug Another Process 1472
  - Detach From Process 1472
  - Execution Analysis 1490
  - Frameworks 1446
  - How It Works 1446
  - Introduction 1446
  - On Windows 7 And Windows Vista 1448
  - Overview 1446
  - Process 1446
  - Start 1471
  - Stop 1471
  - System Requirements 1447
- Debugger Windows
  - From the Debug Window 1467
- Debugging Actions 1470
- Decision
  - Element 765
- Decision Table
  - Business Rule Modeling 945
  - Rule Action Section 945
  - Rule Binding Section 945
  - Rule Condition Section 945
- Deep Copy
  - Of Diagram 436
- Deep History 777
  - Convert From Shallow History 549

- Default
  - Code Language, Set 81
  - Database 1337
  - Database, Set 81
  - DDL Script Editor 1337
  - Hours 340
  - Model Diagram, Cancel 65
  - Model Diagram, Set 65
  - Project Browser Behavior 1210
  - Templates 1204
  - UML To XSD Mappings 1049
  - User Diagram, Cancel 65
  - User Diagram, Set 65
- Default Appearance
  - Background Color 538
  - Border Color 538
  - Border Thickness 538
  - Font Color 538
  - Of An Element 555
  - Of Element 538
  - Set For Profile Stereotype Objects 1106
- Default Diagram
  - Model, Cancel 65
  - Model, Cancel For 437
  - Model, Set 65
  - Model, Set For 437
  - User, Cancel 65
  - User, Set 65
- Default Fonts
  - Model 357
  - Set 357
  - User 357
- Default Hours
  - Estimation 340
  - Per Adjusted Use Case Point 340
  - Project Management 340
  - Rate 340
  - Settings 340
- Default Settings
  - Options Dialog 90
- Default Templates
  - Override in Code Template Editor 1204
- Default Toolbox
  - Override In Profile 1136
- Default Tools Toolbar 80
- Defect
  - Add 1563
  - Create From Test Item 1548
  - Element 1563
  - Hide Stereotype Letter 1563
  - Show Stereotype Letter 1563
- Define
  - Author 645
  - Browser Behavior 351
  - Clients 651
  - Clipboard Image File Format 351
  - Email Exchange Server 351
  - File Directory 351
  - Foreign Key Name Template 1028
  - Home Web Site 351
  - Internet Search Engine 351
  - Resources 650
  - Roles 648
  - Run-Time Variable 824
  - Stereotype As Metatype 1109
  - Stereotype Constraints 1101
  - Tasks Pane Contexts 1144
  - Tasks Pane Toolbox 1141
  - Validation Configuration For MDG Technology 1145
- Define Menu Items
  - Create Add-In 1777
- Defined Environment Types 337
- Delegate
  - Connector 861
  - Relationship 861
- Delete
  - Category In Team Review 215
  - Connectors 619
  - Connectors, Quick Start 35
  - Diagram (Single) From Project Browser 1220
  - Diagrams (Multiple) From Project Browser 1220
  - Diagrams From Project browser 434
  - Diagrams, Quick Start 35
  - Element Changes 1559
  - Element Defects 1559
  - Element From Diagram 534
  - Element from Model 534
  - Element From Project Browser 534
  - Element Issues 1559
  - Element Tasks 1559
  - Elements, Impact of Auditing 279
  - Elements, Quick Start 35
  - Instance Variable 824
  - Item In Team Review 215
  - Line Points 615
  - Linked Document 602
  - Linked Document Template 603
  - Locks 200
  - Menu Options 100
  - Package Attributes From Model Document 1621
  - Package In Project Browser 390

- Delete
  - Packages From Model Document 1621
  - Packages, Quick Start 35
  - Post In Team Review 215
  - Project Task 330
  - Relationship 489
  - Relationship Using Matrix 1266
  - Reply In Team Review 215
  - RTF Style Template 1576
  - Team Review Category 209
  - Team Review Post 209
  - Team Review Resource 209
  - Team Review Topic 209
  - Topic In Team Review 215
  - Views 385
- Delete Selected Element(s)
  - Menu Option (Edit Menu) 57
- Deletion
  - And Auditing 279
- Delphi
  - Code Generation 1352
  - Import, Reverse Engineering 1331
  - Language Options 1352
  - Limitations 1353
  - Modeling Conventions 1292
  - Properties 1353
- Demonstration
  - Of Enterprise Architect 48
- Dependency
  - Connector 861
  - Relationship 861
  - Relationship, Apply Stereotype 862
  - Report 1624
- Dependency Report
  - In Traceability 1251
- Deploy
  - Add-In 1778
  - MDG Technology From Add-In 1146
  - MDG Technology From File 1146
- Deploy Command
  - Create 1484
  - Introduction 1484
- Deploy Script
  - Create 1484
  - Introduction 1484
- Deployment
  - Connector 862
  - Diagram 727
  - Elements and Connectors 413
  - Group, Toolbox 413
  - Model Template 378
  - Relationship 862
  - View 383
- Deployment and Rollout
  - And Enterprise Architect 45
  - Project Role 45
- Deployment Diagram
  - Description 727
  - Elements And Connectors 727
  - Example 727
- Deployment Spec
  - Element 818
- Derived
  - Attribute 560
  - Symbol 560
- Design
  - Patterns 901
- Design Master 184, 347
  - Create, Replication 185
- Design Systems Using UML
  - Enterprise Architect 5
- Designate Driving Triggers
  - Model State Machine For HDL 1319
- Desktop Edition
  - Of Enterprise Architect 12
  - Upsize From 122
- Desktop Tools
  - Add 94
  - Configure 94
  - Customize 94
- Destination Role 631
- Developer
  - And Enterprise Architect 42
  - Forward Engineering 42
  - Project Role 42
  - Reverse Engineering 42
  - Round-Trip Engineering 42
  - Visualise Package Arrangement 42
- Device
  - Element 818
- Diagram
  - Activity, Description 674
  - Activity, Generate From Scenarios 500
  - Add And Manage, Automation Interface Code Example 1768
  - Add Elements Via Context Menu 395
  - Add Link To Team Review Post 216
  - Add Profile Feature 909
  - Add Profile Object 909
  - Add To Project 422
  - Add To UML Model, Quick Start 30
  - Alias 425
  - Alternative Image For Element 447
  - Analysis 733

- Diagram
- Anti-Aliased Rendering 356
  - Anti-Aliased Text 356
  - Appearance Options 356
  - Appearance Options, Connectors 428
  - Appearance Options, Diagram Tab 425
  - Appearance Options, Element 426
  - Appearance Options, Features 427
  - Appearance Options, General 424
  - Appearance Options, Set 423
  - Appearance Options, Visible Class Members 429
  - Archimate 1073
  - Attribute Details, Show 427
  - Auto Route Layout 470
  - Automatic Layout 471
  - Automatic Save 359
  - Automation Interface, Diagram Package 1746
  - Background Color 353
  - Background Color Gradient 356
  - Behavior Options 359
  - Behavioral, Overview 673
  - Box Layout 463
  - BPEL 958
  - BPMN 952
  - Build 396
  - Business Interaction 739
  - Business Modeling 739
  - Business Process 374
  - Cancel Model Default 437
  - Center-Focussed Layout 459
  - Change Type 434
  - Circular Layout 459
  - Class 376, 721
  - Class Features, Visibility 355
  - Close 396
  - Collaboration 715
  - Communication 715
  - Component 378, 730
  - Composite Structure 724
  - Connector Appearance Options 428
  - Connector Notation, Show 428
  - Context 1076
  - Context Menu 394
  - Context Menu, Project Browser 1220
  - Converge Layout 467
  - Copy Image 65
  - Copy, Deep 436
  - Copy, Shallow 436
  - Create 422
  - Create Automatically 387
  - Create Custom Background, Image Manager 448
  - Create From Linked Document 602
  - Create Using Image Library 449
  - Creator 424
  - Custom 734, 736, 737, 738
  - Customize Appearance 423
  - Data Flow 1076
  - Data Model, Example 1013
  - Database Schema 377, 739
  - Define Child Type, Supported Attributes 1111
  - Delete (Multiple) From Project Browser 434
  - Delete (Single) From Project Browser 434
  - Delete Element From 534
  - Delete From Project Browser 1220
  - Delete Multiple Elements From 534
  - Deployment 727
  - Details Note 425, 440
  - Diagram 835, 838, 839
  - Diagram To Package 30
  - Digraph Layout 465
  - Display Options 355
  - Diverge Layout 467
  - Divide Between Pages In RTF Reprt 425
  - Drag & Drop Elements From Project Browser 430
  - Drag Existing Package Onto 389
  - Duplicate 436
  - Element Appearance Options 426
  - Element Compartments, Show/Hide 426
  - Element Icons 521
  - Element Stereotypes, Show 426
  - Element, Copy 433
  - Element, Paste 433
  - Elliptical Layout 459
  - Entity Relationship 1077
  - Eriksson-Penker 1080
  - Exclusive Edit Lock 189
  - Extended 673
  - Extended UML 733
  - Fan Relations Layout 469
  - Feature Return Types, Show 427
  - Feature Stereotypes, Show 427
  - Features Appearance Options 427
  - Filter Display Of Elements 1271, 1272
  - Find In Project Browser 65, 67
  - Find Related Elements 433
  - Frame 355, 766
  - Frame (Border) 766
  - Generate From Scenarios 499
  - Hyperlink 766
  - Hyperlink To 842

- Diagram
- Increase Display Size 356, 391
  - Interaction 690, 706, 715, 717
  - Interaction Overview 717
  - Layout Options 471
  - Layout Tool 458
  - Layout, Move Sections 454
  - Legend 441
  - Lock, General 65
  - Lock, Require User Lock 205
  - Lock, Security Off 457
  - Lock, User/Group Lock 204
  - Logical 721
  - Maintenance 737
  - Make All Elements Selectable 394
  - Make Model Default 437
  - Manage Display 396
  - Managing 421
  - MDG Technology 673
  - Menu 65
  - Mind Mapping 1087
  - Modeling With 391
  - Move Elements 529
  - Move Sections 454
  - Move, Impact On Element 34, 765, 772, 778
  - Navigation And Selection Hotkeys 435
  - Neaten Layout 467
  - Note 440
  - Notes 424
  - Notes, Show/Hide 355
  - Object 723
  - Open From Shortcut 115, 117
  - Open From Shortcut (Direct Definition) 116
  - Open Package In 438
  - Overview 673
  - Package 720
  - Page Setup 355
  - Pan And Zoom 1275
  - Parametric, SysML 1002
  - Paste 436
  - Per Page Layout 464
  - Place Related Elements On Current 433
  - Print From Project Browser 1220
  - Print Page Footer 425
  - Print Page Header 425
  - Profile Attributes, PData and StyleEx 1140
  - Profiles 1139
  - Properties (Diagram Menu) 65
  - Properties Dialog - Connectors Tab 428
  - Properties Dialog - Diagram Tab 425
  - Properties Dialog - Elements Tab 426
  - Properties Dialog - Features Tab 427
  - Properties Dialog - General Tab 424
  - Properties Dialog, Visible Class Members, 429
  - Properties Note, Add 440
  - Properties, Set 423
  - Property Strings, Show 428
  - Qualifiers, Show 427
  - Redo Last Action 458
  - Reference 766
  - Relationship Traceability For 1253
  - Relationships, Show 428
  - Rename 434
  - Requirements 374, 736
  - Robustness 706, 715, 733, 835, 836, 838, 839
  - Robustness, Generate From Scenarios 504
  - Rotate Image In RTF Report 425
  - RTF Document Options 425, 1571
  - RTF Report On Elements Linked From Other Packages 1571
  - Rule Model 937
  - RuleFlow, Generate From Scenarios 501
  - Save 65, 394
  - Save As Pattern 902
  - Save Automatically 359
  - Save Image Of 65
  - Save Profile 1107
  - Scale View 356
  - Schema Diagram 739
  - Scroll Through From Diagram Toolbar 83
  - Sequence 706
  - Sequence, Generate From Scenarios 503
  - Set Page Size 455
  - Show As Element List 394
  - Show Element List As 1258
  - Show Realised Interfaces For Class 452
  - Show/Hide Package Contents 389
  - Slideshow, Model View 1222, 1228
  - SoaML 1089
  - SPEM 1062
  - Spring Layout 466
  - Stae Machine, Generate From Scenarios 501
  - State 678
  - State Machine 678
  - Stereotype 424
  - Structural, Overview 719
  - Swimlanes 450
  - Swimlanes Matrix 444
  - Switch 396
  - Synchronize With Scenario Steps 499
  - SysML 989
  - SysML, Parametric 1002
  - Tab Context Menu 397
  - Table Owner, Show 426

- Diagram
  - Tabs 397
  - Tasks, General 421
  - Timing 690
  - Toolbar 83
  - Traceability 1250
  - Types 673
  - Types, Built In 1140
  - Types, Custom 1139
  - UML 673
  - Undo Last Action 458
  - Use Case 375, 676
  - User Interface 738
  - User Interface Design 734
  - Version 424
  - View 396
  - View Next 455
  - View Previous 455
  - Visibility Indicators 427
  - Water Mark 356
  - What Is A? 673
  - Working With 391
  - WSDL Binding 1057
  - WSDL Message 1056
  - WSDL Overview 1051
  - WSDL Port Type 1056
  - WSDL Service 1054
  - WSDL Types 1051
  - Z Order Elements 437
  - Zoom From Diagram Toolbar 83
- Diagram Caption Bar
  - Hide 59
  - Show 59
- Diagram Filters
  - Access 1272
  - Application 1271
  - Clear Effect Of 1272
  - Create 1272
  - Delete 1272
  - Disable 1272
  - Enable 1272
  - Introduction 1271
  - Set Effect Of 1272
  - Suggested Use 1271
  - Window 1272
- Diagram Frame 766
- Diagram Gate
  - Element 767
- Diagram Image
  - Copy To Clipboard 436
  - Copy To Disk File 435
  - Save To Disk File 435
- Diagram Note
  - Insert New From Toolbar 83
- Diagram Only Report 1625
- Diagram Package
  - Automation Interface 1745
  - Diagram, Automation Interface 1746
  - DiagramLinks, Automation Interface 1749
  - DiagramObjects, Automation Interface 1750
  - Swimlane, Automation Interface 1752
  - SwimlaneDef, Automation Interface 1751
- Diagram Type
  - Add To MDG Technology 1124
- DiagramLinks
  - Automation Interface, Diagram Package 1749
- DiagramObjects
  - Automation Interface, Diagram Package 1750
- Dialog
  - All User Permissions 196
  - Application Look 101
  - Attach To Process 1472
  - Audit Settings 271
  - Create Property Implementation 565
  - Database Operation Properties 1024
  - Difference 274
  - General Types 653
  - Group Properties (Script) 1663
  - Maintenance 660
  - New Action 745
  - Options 350
  - Package Control Options 295
  - Paste Element 430
  - People 645
  - Project Issues 331
  - Qualifiers 832
  - Recent Post Options 1224
  - Select <Item> 515
  - Select Attribute Type 560
  - Select Property 517
  - Set Attribute 748
  - Set Feature 748
  - Set Operation 748
  - Slideshow Properties 1228
  - String Viewer 1474
  - UML Types 662
  - Version Control Settings 234
- DIB Data Access Violation 1450
- Dictionary
  - User (Spell Checker) 1553
- Diff Utility 279, 283
- Differencing
  - Facility 283
  - Output 284

- Differencing
  - With Baselines 279, 283
- Digraph Diagram Layout 465
- Direct Substitution
  - Field Substitution Macros, Code Template Syntax 1174
- Direction Indicator
  - Connector Label 452
- Directory Structure
  - Import, Reverse Engineering 1332
- Disable
  - Add-Ins 1781
  - Archimate 1073
  - BPEL 958
  - BPMN 952
  - Data Flow Diagrams 1076
  - Entity Relationship Diagram 1077
  - Eriksson-Penker MDG Technology 1080
  - Gang Of Four Pattern Technology 1083
  - GoF Pattern Technology 1083
  - ICONIX 1084
  - MDG Technologies 1069
  - Mind Mapping 1087
  - Security 189
  - SoaML 1089
  - SPEM 1061
  - SysML 989
- Disable Recording Markers 1503
- Disconnect
  - Controlled Package 296
- Discussion Forum
  - Now Team Review 208
- Display
  - Attributes, Inherited 438
  - Connector Properties, Shape Scripts 1158
  - Constraints, Inherited 438
  - Element Properties, Shape Scripts 1158
  - Full Screen 74
  - Inherited Attributes 567
  - Inherited Operation 579
  - Operations, Inherited 438
  - Requirements, Inherited 438
  - Tagged Values, Inherited 438
- Display Options
  - Connector 364
  - Diagram 355
  - Element 362
  - Link 364
  - Relationship 364
- Display Size
  - Diagram, Increase 356
- Distributed Development
  - Replication 183
  - XMI Import/Export 183
- Diverge Diagram Layout 467
- Dock
  - Two Elements 555
- Dock Windows
  - Navigation Compass 76
- Dockable
  - Element Option 555
  - Windows 75
- Docked Windows
  - For Requirements 927
- Document
  - Enterprise Architect Content 1568
  - Exclude Packages 1568
  - HTML 1568
  - Linking 597
  - Projects 1568
  - Resource, RTF Generator (Enhanced) 1606
  - Rich Text Format 1568
  - RTF 1568
  - Single Element, RTF (Legacy) 1629
  - WSDL Element 1053
- Document Artifact
  - Element 597, 819
  - Link Into RTF Report 597, 1579
- Document Generation
  - Enterprise Architect 5
- Document Options
  - RTF Generator, From Diagram (Enhanced) 1571
  - RTF Generator, From Diagram (Legacy) 1571
  - RTF Report 1607
- Documentation
  - Elements 1616
  - Generate, Project Browser Option 1212
  - Group, Toolbox 1616
  - HTML 1647
  - Rich Text Format 1569
  - RTF 1569
- Documentation (Reports)
  - Submenu (Project Menu) 61
- Documentation Submenu
  - Package Context Menu, Project Browser 1216
  - Reports 1216
- DoDAF-MODAF
  - MDG Technology For, Enterprise Architect 1073
- Domain
  - Model Template 376
  - Organizational Relationships 376
  - Physical Units 376

- Domain
    - Structure 376
  - DOORS, Telelogic
    - MDG Link For, Enterprise Architect 1073
  - Dot
    - On Association 629
  - Download
    - Gang Of Four Patterns 904
    - GoF Patterns 904
  - Drag
    - Element From Project Browser Onto Diagram 430
    - Objects From Project Browser Onto Diagram 430
  - Drawing Methods
    - Shape Scripts 1154
  - Drop
    - Classifiers As Links 430
    - Classifiers As New Instances 430
    - Elements From Project Browser Onto Diagram 430
    - Objects From Project Browser Onto Diagram 430
  - DTD
    - Validate XMI Import/Export 293
  - Duplicate
    - Diagram 436
    - Element 531
    - Package 388
    - UML Diagram 436
  - Duration
    - Constraint 874
    - Constraint Between Messages 874
    - Observation 874
  - Dynamic View 383
  - Dynamic Visual Filters 1271
- E -**
- EA
    - Execution Analyzer, Introduction 1489
  - EA\_Connect
    - Add-In Event 1782
  - EA\_Disconnect
    - Add-In Event 1783
  - EA\_FileClose
    - Broadcast Events, Add-In Model 1788
  - EA\_FileNew
    - Broadcast Events, Add-In Model 1789
  - EA\_FileOpen
    - Broadcast Events, Add-In Model 1788
  - EA\_GetCompartmentData
    - Compartment Events, Add-In Model 1810
  - EA\_GetMenuItems
    - Add-In Event 1783
  - EA\_GetMenuState
    - Add-In Event 1784
  - EA\_MenuClick
    - Add-In Event 1785
  - EA\_OnContextItemChanged
    - Context Item Events, Add-In Model 1807
  - EA\_OnContextItemDoubleClicked
    - Context Item Events, Add-In Model 1808
  - EA\_OnDeleteTechnology
    - Technology Events, Add-In Model 1806
  - EA\_OnEndValidation
    - Model Validation Broadcasts, Add-In Model 1813
  - EA\_OnImportTechnology
    - Technology Events, Add-In Model 1806
  - EA\_OnInitializeTechnologies
    - Technology Events, Add-In Model 1803
  - EA\_OnInitializeUserRules
    - Model Validation Broadcasts, Add-In Model 1812
  - EA\_OnNotifyContextItemModified
    - Context Item Events, Add-In Model 1809
  - EA\_OnOutputItemClicked
    - Add-In Event 1785
  - EA\_OnOutputItemDoubleClicked
    - Add-In Event 1786
  - EA\_OnPostActivateTechnology
    - Technology Events, Add-In Model 1805
  - EA\_OnPostCloseDiagram
    - Broadcast Events, Add-In Model 1789
  - EA\_OnPostInitialized
    - Broadcast Events, Add-In Model 1802
  - EA\_OnPostNewAttribute
    - Post-New Events, Add-In Model 1801
  - EA\_OnPostNewConnector
    - Post-New Events, Add-In Model 1799
  - EA\_OnPostNewDiagram
    - Post-New Events, Add-In Model 1800
  - EA\_OnPostNewDiagramObject
    - Post-New Events, Add-In Model 1800
  - EA\_OnPostNewElement
    - Post-New Events, Add-In Model 1798
  - EA\_OnPostNewMethod
    - Post-New Events, Add-In Model 1801
  - EA\_OnPostNewPackage
    - Post-New Events, Add-In Model 1802
  - EA\_OnPostOpenDiagram
    - Broadcast Events, Add-In Model 1789
  - EA\_OnPostTransform



- EA\_OnPostTransform  
Broadcast Events, Add-In Model 1803
- EA\_OnPreActivateTechnology  
Technology Events, Add-In Model 1804
- EA\_OnPreDeleteAttribute  
Pre-Deletion Events, Add-In Model 1791
- EA\_OnPreDeleteConnector  
Pre-Deletion Events, Add-In Model 1792
- EA\_OnPreDeleteDiagram  
Pre-Deletion Events, Add-In Model 1792
- EA\_OnPreDeleteElement  
Pre-Deletion Events, Add-In Model 1790
- EA\_OnPreDeleteMethod  
Pre-Deletion Events, Add-In Model 1791
- EA\_OnPreDeletePackage  
Pre-Deletion Events, Add-In Model 1793
- EA\_OnPreDeleteTechnology  
Technology Events, Add-In Model 1805
- EA\_OnPreExitInstance  
Broadcast Events, Add-In Model 1798
- EA\_OnPreNewAttribute  
Pre-New Events, Add-In Model 1796
- EA\_OnPreNewConnector  
Pre-New Events, Add-In Model 1794
- EA\_OnPreNewDiagram  
Pre-New Events, Add-In Model 1795
- EA\_OnPreNewDiagramObject  
Pre-New Events, Add-In Model 1795
- EA\_OnPreNewElement  
Pre-New Events, Add-In Model 1793
- EA\_OnPreNewMethod  
Pre-New Events, Add-In Model 1797
- EA\_OnPreNewPackage  
Pre-New Events, Add-In Model 1797
- EA\_OnRetrieveModelTemplate  
Broadcast Events, Add-In Model 1820
- EA\_OnRunAttributeRule  
Model Validation Broadcasts, Add-In Model 1815
- EA\_OnRunConnectorRule  
Model Validation Broadcasts, Add-In Model 1814
- EA\_OnRunDiagramRule  
Model Validation Broadcasts, Add-In Model 1814
- EA\_OnRunElementRule  
Model Validation Broadcasts, Add-In Model 1813
- EA\_OnRunMethodRule  
Model Validation Broadcasts, Add-In Model 1815
- EA\_OnRunPackageRule  
Model Validation Broadcasts, Add-In Model 1813
- EA\_OnRunParameterRule  
Model Validation Broadcasts, Add-In Model 1816
- EA\_OnStartValidation  
Model Validation Broadcasts, Add-In Model 1812
- EA\_QueryAvailableCompartments  
Compartment Events, Add-In Model 1809
- EA\_ShowHelp  
Add-In Event 1787
- EAB File  
Export 264  
Import 265  
Model Branch File 264
- EABase  
As Source 121  
Project 27  
Project File 120
- EAExample File 114
- EAP File  
As Project Database 112  
Corrupt 348  
Iterate Through, Automation Interface Code Example 1766
- EASL  
Behavioral Model Templates 1193  
Code Generation Macros, Behavioral Model 1193  
Enterprise Architect Simulation Library 1193
- EASL Collections  
Action 1194  
Behavior 1194  
Classifier 1194  
Construct 1194  
Node 1194  
State 1194  
State Machine 1194  
Transition 1194  
Trigger 1194  
Vertex 1194
- EASL Properties  
Action 1196  
Argument 1196  
Behavior 1196  
Call Event 1196  
ChangeEvent 1196  
Classifier 1196  
Condition 1196  
Construct 1196  
Edge 1196  
EventObject 1196

- EASL Properties
  - Instance 1196
  - Parameter 1196
  - Primitive 1196
  - PropertyObject 1196
  - SignalEvent 1196
  - State 1196
  - StateMachine 1196
  - TimeEvent 1196
  - Transition 1196
  - Trigger 1196
  - Vertex 1196
- EASL\_GET
  - Code Generation Macro, Behavioral Model 1193
- EASLList
  - Code Generation Macro, Behavioral Model 1193
- ECF
  - Value 337
  - Weighting 337
- Eclipse
  - MDG Integration For, Enterprise Architect 1073
  - MDG Link For, Enterprise Architect 1073
- Edit
  - Attribute Name, In-Place Editor 588
  - Element Name, In-Place Editor 588
  - Item In Team Review 215
  - Linked Document Template 604
  - Linked Documents 600
  - Menu 57
  - Operation Name, In-Place Editor 588
  - Pattern Default 904
  - RTF Style Template 1576
  - Test Details 1538
- Editions
  - Business and Software Engineering 12
  - Corporate 12
  - Desktop 12
  - Floating Licence 12
  - Lite 15
  - Of Enterprise Architect 12
  - Of Enterprise Architect, Introduction 10
  - Professional 12
  - Standalone 12
  - System Engineering 12
  - Ultimate 12
- Editor
  - Team Review 215
- Editor Language Properties
  - Code Editor Properties 1338
- Global Options 1338
- Language-Specific Options 1338
- Macro Key Assignment 1338
- Effort
  - Attributes 1710
  - Automation Interface, Element Package 1710
  - Methods 1710
- Effort Management 315
- Effort Types
  - Define 319
  - Global 319
  - Non-Global 315
- EJB
  - Entity Bean Transformations 1397
  - Session Bean Transformations 1397
- Element
  - Abort Edit Changes 68
  - Accept Edit Changes 68
  - Action 743
  - Active 483
  - Activity 753
  - Activity Final 772
  - Activity Partition 786
  - Activity Region 788
  - Actor 757
  - Add And Manage, Automation Interface Code Example 1767
  - Add Attribute, In-place Editor 592
  - Add Directly To Package 524
  - Add Link To Team Review Post 216
  - Add New Item (Inline Features Menu Option) 68
  - Add Operation, In-place Editor 592
  - Add Supporting Diagrams and Elements 550
  - Add To Diagram 31
  - Add To Diagram From Project Browser 430
  - Add To Diagram Via Context Menu 395
  - Add To Favorites 552
  - Add To Profile 1096
  - Add To UML Model, Quick Start 31
  - Align 557
  - Align From Diagram Toolbar 83
  - Align Multiple 532
  - Alternative Image 447
  - Appearance, Context Menu Option 555
  - Appearance, Format From Toolbar 85
  - Apply Image From Clipboard 69
  - Archimate 1073
  - Artifact 810
  - Associated Files 507
  - Attributes Option 554
  - Author 482

- Element
- Auto Counters 525
  - Auto Naming 525
  - Auto Numbering 525
  - Automation Interface, Element Package 1711
  - Autosize Group 444
  - Autosize Single 444
  - Background Color 353
  - Behavioral Diagram 742
  - Boundary 836
  - Boundary, Settings 803
  - BPMN 952
  - BPMN, Change Appearance 956
  - Browser Window 510
  - Bulk Update 340
  - Business Rule 937
  - Cardinality (Multiplicity), Non-Displayable 484
  - Central Buffer Node 758
  - Change 1563, 1564
  - Change Appearance, BPMN 956
  - Change Type 532
  - Changes And Issues 1558
  - Changes, Add/Modify/Delete 1559
  - Child Validation 1531
  - Choice 758
  - Class 811
  - Code Engineering Menu 554
  - Collaboration 814
  - Collaboration Occurrence 815
  - Combined Fragment 759
  - Compartments 521
  - Complexity 482
  - Component 816
  - Composite 837
  - Concurrency 484
  - Confirm As Parent 529
  - Connect 610
  - Connectors In Relationships Window 1269
  - Constraint Note 785
  - Constraint, Attach 68
  - Constraints 488
  - Context Menu 547
  - Context Menu, Add Submenu 550
  - Context Menu, Advanced 549
  - Context Menu, Features 554
  - Context Menu, Find Submenu 552
  - Context Menu, Project Browser 1218
  - Continuation 792
  - Continutaion 792
  - Control 838
  - Coordinates On Status Bar 89
  - Copy And Paste Between Diagrams 34
  - Copy Between Packages 531
  - Create Child Diagram 422
  - Create From Linked Document 602
  - Create From Maintenance Item 1561
  - Create From Toolbox 399
  - Create In Diagram 523
  - Create Link From Project Browser 618
  - Create With Quick Linker 475
  - Create, Same Type As Previous 65
  - Custom Properties 550
  - Customize Visibility 535
  - Cut And Paste Between Diagrams 34
  - Dashed Border On 529
  - Data Store, Data Flow Diagram 1076
  - Data Type 817
  - Datastore, Activity Diagram 764
  - Decision 765
  - Default Appearance 69
  - Default Element Template 542
  - Defect 1563
  - Defects 1558
  - Defects, Add/Modify/Delete 1559
  - Delete 534
  - Delete Item From 68
  - Deployment Spec 818
  - Details 484
  - Device 818
  - Diagram Frame 766
  - Diagram Gate 767
  - Display Depth 437
  - Display Options 362
  - Dockable 555
  - Document Artifact 819
  - Documentation 1616
  - Drag From Project Browser 430
  - Duplicate 531
  - Edit Attribute Keyword 590
  - Edit Attribute Scope 589
  - Edit Attribute Stereotype, In-place Editor 588
  - Edit Item, Tasks 586
  - Edit Name, In-Place Editor 588
  - Edit Operation Parameter Keyword 591
  - Edit Operation Parameter Kind 592
  - Edit Operation Scope 589
  - Edit Operation Stereotype, In-place Editor 588
  - Embedded Submenu 552
  - Embedded, Add 553
  - Endpoint 768
  - Entity 839
  - Entity, Entity Relationship Diagram 1077
  - Entry Point 769
  - Enumeration 819

- Element
- Eriksson-Penker 1080
  - Event 839
  - Exception 769
  - Execution Environment 820
  - Exit Point 771
  - Expansion Region 769
  - Export Data In CSV Format 303
  - Expose Interface 820
  - Extended By Stereotype 835
  - External Requirements 487
  - External, Data Flow Diagram 1076
  - Feature 840
  - Feature, Connect To 611
  - Feature, Disconnect From 611
  - Fill Color 353
  - Fill Color Gradient 356
  - Filter Display On Diagram 1271, 1272
  - Final (Leaf) 483
  - Find In Diagram Menu Options 1218
  - Find in Diagrams 552
  - Find In Diagrams, Element List 1258
  - Find In Project Browser 67, 552
  - Find Related 433
  - Fine Movement 454
  - Flow Final 772
  - Font, Set 69
  - Fork 773, 775
  - Fragment 759
  - Gang Of Four Pattern 1083
  - General Settings 482
  - Generalizable, Advanced Settings 483
  - Get Project Custom Colors 540
  - GoF Pattern 1083
  - Hide Type On Diagram 1271, 1272
  - Highlight Context 543
  - History 777
  - Hyperlink 840, 842
  - Icon, Project Browser, User-Defined 1108
  - Icons On Diagram 521
  - Import Data In CSV Format 305
  - Include Linked In RTF Report 1571
  - Information Item 821
  - Initial 778
  - In-place Editor Options 586
  - In-Place Formatting 521
  - Insert Maintenance Feature 594
  - Insert New Feature (Inline Features Menu Option) 68
  - Insert Operation Parameter 593
  - Insert Related Elements 551
  - Insert Testing Features 595
  - Instance 823
  - Interaction 779
  - Interaction Occurrence 780
  - InteractionUse 780
  - Interface 821
  - Internal Requirements 485
  - Interruptible Activity Region 781
  - Issue 1563
  - Issues And Changes 1558
  - Issues, Add/Modify/Delete 1559
  - Join 773, 776
  - Junction 782
  - Keywords 482
  - Labels 452
  - Layout 557
  - Legend 441
  - Lifeline 783
  - Link To Attribute Via Object 568
  - Linked, Convert To Local Copy 544
  - Lock Indicators 206
  - Lock, Require User Lock 205
  - Lock, Security Off 555
  - Lock, User/Group Lock 204
  - Locked, Add Connector To 204
  - Maintenance 1558
  - Make All Selectable/Unselectable 394
  - Make Non-Selectable, Multiple Elements 557
  - Make Non-Selectable, Single Element 555
  - Make Selectable, Multiple Elements 557
  - Make Selectable, Single Element 555
  - Managing 522
  - Master Document 1616
  - Match Size 557
  - Menu 67
  - Merge 765
  - Merge Node 784
  - Mind Mapping 1087
  - Model Document 1616
  - Modeling With 478
  - Move Between Packages 530
  - Move By Increments 454
  - Move In Diagrams 529
  - Move, Impact Of Diagram 34
  - Multiple Selection 557
  - Multiple Update 340
  - Multiplicity, Displayable 483
  - N-Ary Association 844
  - N-Ary, Entity Relationship Diagram 1077
  - New 523
  - Node 822
  - Non-Selectable, Multiple Elements 557
  - Non-Selectable, Single Element 555

- Element
- Note (Constraint, Comment) 785
  - Note, Attach 68
  - Notes 536, 641
  - Nudge 70, 454
  - Object 823
  - Occurrence 780
  - Operations Option 554
  - Package 825
  - Packaging Component 845
  - Part 825
  - Partition 786
  - Paste As Link 58
  - Paste As New 58
  - Paste Copy 531
  - Paste From Clipboard As Metafile 58
  - Paste From Project Browser 430
  - Phase 482
  - Phase, Update For Package 340
  - Place Related On Current Diagram 433
  - Port 826
  - Postconditions 488
  - Preconditions 488
  - Primitive 829
  - Process 846, 931
  - Process, Data Flow Diagram 1076
  - Properties Dialog 481
  - Properties Dialog, Changes and Defects 1565
  - Properties Dialog, General Settings 482
  - Properties Menu 548
  - Properties Window 508
  - Properties, As Attributes 565
  - Properties, Edit From Package 720
  - Properties, Links 489
  - Properties, Tagged Values Tab 508
  - Pseudo-State 682
  - Receive 787
  - Receive Event 839
  - Region 788
  - Region, Expansion 769
  - Region, Interruptible Activity 781
  - Relationship Traceability For 1253
  - Relationship, Delete 489
  - Relationship, Entity Relationship Diagram 1077
  - Relationship, Hide 489
  - Relationship, Show 489
  - Requirement 846, 922
  - Requirements 485
  - Resize 533
  - Responsibilities 485
  - Root 483
  - Rule Task 939
  - Scenario 490
  - Scenarios & Requirements 514
  - Screen 847
  - Select By Property 1271
  - Selectable, Multiple Elements 557
  - Selectable, Single Element 555
  - Send 789
  - Send Event 839
  - Sequence Diagram 710
  - Sequence, Lifecycle 708
  - Set Alternative Image 69
  - Set Cross References 527
  - Set Custom References 527
  - Set Default Appearance 538
  - Set Element Template Package 542
  - Set Feature Visibility 554
  - Set Font 556
  - Set Parent 526
  - Set Project Custom Colors 540
  - Shadow Color 353
  - Shape Script Properties 1158
  - Show Usage 526
  - Signal 834
  - Size 533
  - SoaML 1089
  - Specification 483
  - SPEM 1062
  - State 789
  - State Invariant 792, 793
  - State Lifeline 794
  - State Machine 796
  - State/Continuation 792
  - Status 482
  - Status, Update For Package 340
  - Stereotype 482
  - Stored Procedure 1030
  - Structural Diagram 809
  - Structured Activity, Conditional Node 796, 798
  - Structured Activity, Loop Node 796, 798
  - Structured Activity, Sequential Node 796, 798
  - Structured Activity, Structured Node 796, 798
  - Sub-Activity 753
  - Sub-Activity, Conditional Node 796, 798
  - Sub-Activity, Loop Node 796, 798
  - Sub-Activity, Sequential Node 796, 798
  - Sub-Activity, Structured Node 796, 798
  - Submachine State 789, 796
  - Superimposition 437
  - Synch 802
  - Synchronize Stereotyped Tagged Values From Toolbox 399
  - Synchronize Stereotypes With Profile 910

- Element
  - SysML Activity 996
  - SysML Block Definition 992
  - SysML Interaction 998
  - SysML Internal Block 994
  - SysML Model 991
  - SysML Parametric 995
  - SysML Requirement 1001
  - SysML State Machine 999
  - SysML Use Case 1000
  - System Boundary 802
  - Table 849
  - Tasks 522, 1558
  - Tasks, Add/Modify/Delete 1559
  - Template Package 542
  - Template Parameters 484
  - Template, Default Element 542
  - Templates And Profiles 542, 906
  - Terminate 804
  - Test Case 848
  - Test Scripts Compartment 1549
  - Text 536
  - Text Color 353
  - Toolbar 83
  - Transformation 1387
  - Trigger 804
  - Type 549
  - UI Control 849
  - UML 741
  - Usage 526
  - Use Case 806
  - Use Cross References 527
  - Use Custom References 527
  - Use Extras, Automation Interface Code Example 1769
  - User Interface 849
  - Value Lifeline 808
  - Version 482
  - Version, Update For Package 340
  - View Properties (Inline Features Menu Option) 68
  - View, Data Modeling 1032
  - Visibility 484
  - Visibility Options 363
  - Visual Representation, Introduction 520
  - Work On From Element List 1255
  - Work On From Toolbar 84
  - Working With 478
  - WSDL Binding 1057
  - WSDL Message 1056
  - WSDL Namespace 1051
  - WSDL Service 1054
  - WSDL, Document 1053
  - WSDL, Port Type 1056
  - Z Order 437
- Element Context Menu
  - Add Submenu, Project Browser 1219
- Element Feature
  - Attribute 558
  - Connect To 611
  - Disconnect From 611
  - Operation 569
- Element List
  - Context Menu Options 1258
  - Description 1255
  - Generate RTF Report 1570
  - Options 1258
  - Show As Diagram 1258
  - Show Diagram As 394
  - Toolbar 1258
  - Was Report View 1255
  - Work On Elements 1258
- Element Package, Automation Interface
  - Constraint 1710
  - Diagram 1708
  - Effort 1710
  - Element 1711
  - File 1717
  - Issue 1718
  - Metric 1719
  - Requirement 1719
  - Resource 1720
  - Risk 1721
  - Scenario 1722
  - ScenarioExtension 1723
  - ScenarioStep 1723
  - TaggedValue 1724
  - Test 1725
- Element Templates
  - And Profiles 1093
- ElementFeatures Package, Automation Interface
  - Attribute 1727
  - AttributeConstraint 1729
  - AttributeTag 1730
  - CustomProperties Collection 1730
  - Diagram 1726
  - EmbeddedElements Collection 1731
  - Method 1732
  - MethodConstraint 1733
  - MethodTag 1734
  - Parameter 1735
  - Partitions Collection 1736
  - Properties 1736
  - Property 1736

- ElementFeatures Package, Automation Interface
  - Transitions Collection 1737
- Ellipse Diagram Layout 459
- Email
  - Access Within Enterprise Architect 103
  - Exchange Server, Define Default 351
- Embedded Elements
  - Dialog 553
  - Element Context Submenu 552
  - Include When Pasting Composite 431
  - Incorporate Inherited Properties 553
  - Maintain Layout In Pasting Composite 431
  - Window 553
- EmbeddedElements Collection
  - Automation Interface, ElementFeatures Package 1731
- EMX
  - File Cross References 291
  - File Import 291
- Enable
  - Add-Ins 1781
  - Archimate 1073
  - Data Flow Diagrams 1076
  - Entity Relationship Diagram 1077
  - Eriksson-Penker MDG Technology 1080
  - Exclusive Diagram Edit Lock 189
  - Gang Of Four Pattern Technology 1083
  - GoF Pattern Technology 1083
  - ICONIX 1084
  - MDG Technologies 1069
  - Mind Mapping 1087
  - Security 189
  - SoaML 1089
  - SPEM 1061
- Enable Diagnostic Messages
  - Build Script, Sequence Diagram Recording Tab 1496
- Enable Filter
  - Build Script, Sequence Diagram Recording Tab 1493
- Encrypt Password
  - Prior To Release 7.1 Of Enterprise Architect 200
- Encrypt Password (Repository)
  - At Release 7.1 Of Enterprise Architect 115, 119
- End Event, BPEL
  - Create 965
  - Model 965
  - Types 965
- End User License Agreement 16
- Endpoint
  - Element 768
- Enterprise Architect
  - Add-In Model 1776
  - Alignment With UML 672
  - And Deployment 45
  - And IDEs 5
  - Autohide Windows 78
  - Automation 1659
  - Build Systems 5
  - CASE Tool 3
  - Change Control, Project 1557
  - Change Management 228
  - Code Engineering With 1279
  - Community Site 23, 50
  - Connectors 852
  - Create Project, Tutorial 28
  - Database Modeling 5
  - Debug 5
  - Demonstration 48
  - Design Systems 5
  - Dock Windows 76
  - Dockable Windows 75
  - Editions, Differences Between 12
  - Editions, Introduction 10
  - Editor 1337
  - End User License Agreement 16
  - Example Project File 114
  - Export Data In CSV Format 303
  - Extend Trial Period 10
  - Feedback Pages 3
  - For Business Analysts 38
  - For Database Administrators 47
  - For Developers 42
  - For Implementation Managers 45
  - For Project Managers 43
  - For Software Architects 40
  - For Software Engineers 41
  - For Technology Developers 46
  - For Testers 43
  - Formal Statements 16
  - Fundamental Processes 4
  - Generate Documentation 5
  - Generate Source Code 5
  - Getting Started 26
  - Glossary 1833
  - Help 23
  - How To Use 3
  - Import Data In CSV Format 305
  - In Action 48
  - Install 21
  - Interfaces For Modeling 48
  - Introduction 3
  - Key Features 8

- Enterprise Architect
  - Keyboard Shortcuts 104
  - Keyboard/Mouse Shortcuts 109
  - License Agreement 16
  - Lite Edition 15
  - Main Context Menu 54
  - Main Menu 54
  - Manage Model Structure 5
  - Manage Requirements 5
  - MDA Transformation 5
  - Model Complexity 5
  - Model Requirements 5
  - Modeling Tool 3
  - Navigation Compass 76
  - Object Model, Introduction 1666
  - Online Resources 50
  - Online User Guide 3
  - Performance, DBMS Connections 148, 150, 153, 160, 162, 165
  - Performance, In Auditing 270
  - Performance, WAN Optimizer 180
  - Predefined Search Definitions 1241
  - Professional Roles 37
  - Project Change Control 1557
  - Project Files, Open A Project 114
  - Project Maintenance 1557
  - Project Roles 37
  - Project Team Review 208
  - Project, What Is A? 113
  - Quality Control 1527
  - Read-Only Edition 15
  - Register Full License 22
  - Replication Merge Rules 184
  - Reverse Engineer 5
  - Scripting 1659
  - SDK, Introduction 1092
  - Select Edition To Trial 10
  - Share Model Development 5
  - Software Product License Agreement 16
  - Spell Checking 1552
  - Start 27
  - Start Page 50
  - Support 23, 24
  - Testing 1527
  - Tools And Features For Modeling 48
  - Trial Version 10
  - UML 2.3 Support 5
  - UML Modeling With 370
  - User Interface 48
  - Uses Of 5
  - Visualize Systems 5
  - Web Services Access 103
  - What Can I Do With It? 5
  - What is Enterprise Architect? 4
  - Working With 4
  - Workspace Status Bar 89
- Enterprise Architect Lite
  - Availability 15
  - Description 15
  - Edition 15
- Enterprise Architect Simulation Library
  - Behavioral Model Templates 1193
  - EASL Code Generation 1193
  - EASL\_GET Macro 1193
  - EASLList Macro 1193
- Enterprise Architect Toolbox 399
  - Activity Group 412
  - Analysis Group 416
  - Class Group 407
  - Common Group 405
  - Communication Group 409
  - Component Group 412
  - Composite Group 409
  - Custom Group 417
  - Data Modeling Group 421
  - Deployment Group 413
  - Documentation Group 1616
  - Interaction Group 410
  - Maintenance Group 418
  - MDG Technology Groups 1067
  - Metamodel Group 415
  - Object Group 408
  - Profile Group 414
  - Requirement Group 418
  - Shortcut Menu 403
  - State (Machine) Group 411
  - SystemC Group 1295
  - Timing Group 410
  - Use Case Group 406
  - User Interface Group 419
  - Verilog Group 1298
  - VHDL Group 1299
  - WSDL Group 420
  - XML Schema Group 420
- Enterprise Java Beans 1397
  - MDG Technology For, Enterprise Architect 1073
- Entity
  - Create 839
  - Element 839
  - Element (Entity Relationship Diagram) 1077
- Entity Relationship Diagram
  - Concepts 1077
  - Connector 1077



- Entity Relationship Diagram
  - Elements 1077
  - Example Diagram 1077
  - MDG Technology 1077
  - Relationship 1077
  - Tagged Values 1077
  - Toolbox Page 1077
  - Transformation From Data Model 1390
  - Transformation To Data Model 1399
- Entry Point
  - Element 769
- Entry Points
  - Tab Of Structural Specification 493, 498
- Enumeration
  - Automation Interface 1675
  - ConstLayoutStyles 1675
  - CreateBaselineFlag 1676
  - CreateModelType 1676
  - Element 819
  - EnumRelationSetType 1676
  - ExportPackageXMIFlag 1677
  - Literal 819
  - MDGMenus 1677
  - ObjectType 1677
  - PropType 1678
  - ReloadType 1678
  - ScenarioDiagramType 1678
  - ScenarioStepType 1679
  - ScenarioTestType 1679
  - XMIType 1679
- Enumeration Elements
  - Add To Profiles 1103
- EnumRelationSetType Enum
  - Automation Interface 1676
- Environment Complexity Factor
  - Definition 337
  - Estimate Project Size 338
  - Estimation 337
  - Value 337
  - Weighting 337
- ERD To Data Model
  - Transformation, MDA-Style Transform 1399
- ERDs 1077
- Eriksson-Penker
  - Concept 1080
  - Diagram 1080
  - Disable 1080
  - Elements 1080
  - Enable 1080
  - Extensions 1080
  - MDG Technology 1080
  - Relationships 1080
  - Toolbox Page 1080
- Eriksson-Penker Business Extensions 733
- Establish Port-Trigger Mappng
  - Model State Machine For HDL 1319
- Estimation 659
  - Default Hours 340
  - Environment Complexity Factors 337
  - Of Project Factors 335
  - Of Project Size 338
  - Of Project Timescale 335
  - Technical Complexity Factors 336
  - Use Case 335
- Event
  - Business Modeling 932
  - Element 839
  - Receive 839
  - Send 839
- EventProperties
  - Automation Interface Repository 1697
- EventProperty
  - Automation Interface Repository 1697
- Example Diagram
  - Entity Relationship Diagram 1077
- Examples And Tips
  - Automation Interface 1669
- Exception
  - Element 769
- Exception Path, Scenario 490
- Exclamation Mark
  - Blue 206
  - Red 206
- Exclude
  - Package In RTF Report 1573
- Exclusive Edit Lock
  - Automatic 189
  - Disable 189
  - Enable 189
  - Toggle 189
- Exclusive Gateway
  - Data-Based 972
  - Event-Based 972
- Execution Analysis
  - Add State Transitions 1507
  - Automatic Recording, Record Sequence Diagrams 1504
  - Breakpoints And Markers Window, Record Sequence Diagrams 1503
  - Control Recording, Record Sequence Diagrams 1504
  - Diagram Features, Generate Sequence Diagrams 1507
  - Difference Between Recording Marker And Breakpoint 1503

- Execution Analysis
  - Generate Sequence Diagram 1505, 1507
  - Introduction 1490
  - Manual Recording, Record Sequence Diagrams 1504
  - Marker Types, Record Sequence Diagrams 1499
  - Object Workbench, Create Variables 1521
  - Object Workbench, Introduction 1519
  - Object Workbench, Invoke Methods 1522
  - Object Workbench, Overview 1520
  - Object Workbench, Variables 1521
  - Pause Recording, Record Sequence Diagrams 1505
  - Place Markers, Recording Sequence Diagrams 1499
  - Platforms 1490
  - Profiler Operation 1517
  - Profiler Report, Load 1518
  - Profiler Report, Save 1518
  - Profiler Report, Save As Resource In Team Review 1519
  - Profiler Toolbar 1516
  - Profiler, Attach To Process 1517
  - Profiler, Getting Started 1516
  - Profiler, Launch 1517
  - Profiler, Overview 1514
  - Profiler, Prerequisites 1516
  - Profiler, Set Options 1518
  - Profiler, Set Sample Intervals 1518
  - Profiler, Start 1517
  - Profiler, Stop 1517
  - Profiler, Supported Platforms 1516
  - Profiler, System Requirements 1516
  - Record Activity For Class 1497
  - Record Activity For Method 1498
  - Record Sequence Diagrams, Advanced Techniques 1497
  - Record Sequence Diagrams, Enable Filter 1493
  - Record Sequence Diagrams, Introduction 1490
  - Record Sequence Diagrams, Overview 1491
  - Record Sequence Diagrams, Prerequisites 1492
  - Record Sequence Diagrams, Recording Options 1492
  - Record Sequence Diagrams, Set Up 1492
  - Record Unit Test Results 1514
  - Recording History 1506
  - Recording Markers, Activate, Record Sequence Diagrams 1503
  - Recording Markers, Disable, Record Sequence Diagrams 1503
  - Resume Recording, Record Sequence Diagrams 1505
  - Run Unit Test 1513
  - Save Recording History 1507
  - Sequence Diagrams, Enable Diagnostic Messages 1496
  - Sequence Diagrams, Limit Auto Recording 1496
  - Sequence Diagrams, Record Arguments To Function Calls 1494
  - Sequence Diagrams, Record Calls To Dynamic Modules 1495
  - Sequence Diagrams, Record Calls To External Modules 1494
  - Set Recording Markers, Record Sequence Diagrams 1502
  - Set Up To Capture State Changes 1508
  - State Machine Diagram 1509
  - State Transition Diagram 1509
  - Stop Recording, Record Sequence Diagrams 1505
  - Submenu (Project Menu) 62
  - Team Review, Save Profiler Report As Resource 1519
  - Unit Test Script, Create 1512
  - Unit Test, Record Results 1514
  - Unit Testing, Introduction 1512
  - With Enterprise Architect 1490
  - Work With Marker Sets, Record Sequence Diagrams 1503
- Execution Analyzer
  - Introduction 1489
  - Submenu (View Menu) 59
- Execution Environment
  - Element 820
- Execution Profiler
  - Attach To Process 1517
  - Getting Started 1516
  - Launch 1517
  - Operation 1517
  - Overview 1514
  - Prerequisites 1516
  - Report, Example 1514
  - Report, Load 1518
  - Report, Save 1518
  - Report, Save As Resource In Team Review 1519
  - Set Options 1518
  - Set Sample Intervals 1518
  - Start 1517
  - Stop 1517
  - Supported Platforms 1516
  - System Requirements 1516
  - Team Review, Save Report As Resource 1519

- Execution Profiler
    - Toolbar 1516
  - Exit
    - Menu Option (File Menu) 56
  - Exit Point
    - Element 771
  - Expansion Node
    - Action 749
  - Expansion Region
    - Add 771
    - Element 769
  - Explorer
    - Open 70
  - Export
    - .EAB File 264
    - Code Templates 1202
    - Data 223
    - MOF To XMI 1383
    - Profile, To Disk 1106
    - Reference Data 223
    - Reference Data, Introduction 223
    - RTF Style Template 1576
    - State Machine Table To CSV 690
    - To Rational Rose 288, 289, 293
    - To XMI 289
    - Version Controlled Model Branch 264
    - XMI, Batch 298
  - Export Diagrams
    - To RTF Document 1625
  - ExportPackageXMIFlag Enum
    - Automation Interface 1677
  - Expose Interface
    - Element 820
  - Extend
    - Connector 862
    - Relationship 862
    - Toolbox Connectors 1138
    - Toolbox Elements 1137
  - Extended Elements 835
  - Extended UML Diagrams 733
  - Extending Modeling Languages
    - And MDG Technologies 1092
    - With Enterprise Architect 1092
    - With UML Patterns In Enterprise Architect 1092
    - With UML Profiles In Enterprise Architect 1092
    - With UML Stereotypes In Enterprise Architect 1092
  - Extension
    - SysML Requirement 1001
  - Extension Points
    - Use Case 807
  - Extension Stereotypes 835
  - External
    - Element (Data Flow Diagram) 1076
    - Requirements 487, 922
  - External File
    - Add Link To Team Review Post 216
  - External Requirements
    - Color Coded 920
  - External Tools
    - Open 96
    - Pass Parameters To 97
- F -**
- Fan Relations Diagram Layout 469
  - Favorites
    - Add To Resources Window 669
    - Delete From Resources Window 669
    - Drag Objects Into 1222, 1226
    - Elements, Resources Window 669
    - Folder, Resources Window 669
    - Model Views Folder 1222
    - View Properties In Resources Window 669
  - FDD Methodology 840
  - Feature
    - As Attribute 558
    - As Operation 569
    - Element 840
  - Feature Driven Design Methodology 840
  - Feature Visibility
    - Attributes 438
    - Customize 438
    - Inherited 438
    - Operations 438
    - Set 438
    - Supress 438
  - Features
    - Connect To 611
    - Disconnect From 611
    - Of Enterprise Architect 8
  - Feedback Pages 3
  - Field Substitution Macros
    - Access Data from Attributes 1174
    - Access Data from Classes 1174
    - Access Data from Operations 1174
    - Access Data from Packages 1174
    - Access Data from Parameters 1174
    - Conditional Substitution 1174
    - Direct Substitution 1174
  - Fields and Conditions
    - In Search 1243

- File
    - .EAB 264
    - Element Package, Automation Interface 1717
    - Hyperlink To 842
    - Menu 56
  - File Search
    - Introduction 1485
    - List View 1485
    - Search Window, Debugging 1485
    - Toolbar 1485
    - Tree View 1485
    - Use 1485
  - Filter
    - Diagram, Display Of Elements 1272
  - Filters
    - Add To Search 1242
    - AND 1235
    - Diagram, Display Of Elements 1271
    - Dynamic Visual 1271
    - Element, RTF Report 1611
    - OR 1235
    - Other, RTF Report 1612
    - Search 1235
  - Find
    - Diagram In Project Browser 65, 67
    - Element In All Diagrams 552
    - Element In Diagrams, Element List 1258
    - Element In Project Browser 67, 552
    - Submenu 552
  - Find In Diagram
    - Element Context Menu, Project Browser 1218
  - Find in Project
    - Menu Option (Edit Menu) 57
  - Find In Project Browser
    - Search Option 1214
  - Floating Licence
    - Version of Corporate Edition 12
  - Floating Toolbar Buttons
    - Display 362
  - Floating Windows 76
  - Flow Final
    - Element 772
  - Font
    - Set For Element Text 556
  - Fonts
    - Set Model Default 357
    - Set User Default 357
  - Footer
    - Insert In RTF Template 1596
  - Footers
    - Add To RTF Document 1643
  - Foreign Key
    - Composite 1025
    - Constraint 1025
    - Create 1025
    - Description 1024
    - Name Template, Define 1028
    - Representation In Diagram 1025
  - Foreign Language Translation
    - RTF Report Generation 1615
  - Fork
    - Element 773, 775
    - Pseudo-State 773, 775
  - Fork/Join
    - Element 773
  - Formal Statements 16
  - Format
    - Element Appearance From Toolbar 85
    - Toolbar 85
  - Forum
    - Discussion, Now Team Review 208
  - Forward Engineering
    - Initial Code In Operations 576
    - Introduction 1281
  - Forward Slash
    - Derived Symbol 560
  - Forward Synchronization
    - Delete Code From Features In Model 1341
  - Fragment
    - Element 759
  - Frame
    - Combine Windows In 76
    - Remove Windows From 76
    - Tabbed 76
  - Free Sorting
    - On Project Browser 1210
  - Full Screen
    - Close 74
    - Display 74
  - Fully Qualified Tagged Value
    - Show In Element Compartment 438
  - Function
    - Macros, Code Template Syntax 1187
    - Step Out Of 1473
  - Function Call
    - Step Into 1473
    - Step Through 1480
- G -**
- Gang Of Four Pattern
    - Concepts 1083
    - Download 901, 904

- Gang Of Four Pattern
  - MDG Technology 1083
  - Toolbox Page 1083
- Garden Of Eden Style 1378
- Gateway
  - Create 972
  - Exclusive (XOR) 972
  - Inclusive (OR) 972
  - Model In BPEL 972
  - Parallel (AND) 972
  - Types 972
- General
  - Types, Dialog 653
- General Options
  - Set For Project 351
- General Ordering
  - Sequence Diagram Messages 876
- Generalizable Elements 483
- Generalization
  - Sets 620
- Generalization Link
  - Implement Parent Operations 578
  - Override Parent Operations 578
- Generalize
  - Connector 863
  - Relationship 863
- Generate
  - BPEL 983
  - DDL 1367
  - Global Element For Global ComplexTypes 1376
  - Global Element In XSD 1378
  - Report On Elements 1255
  - Report On Project 1255
  - Rich Text Format Report (Legacy) 1634
  - RTF Document from Resources (Enhanced) 1606
  - RTF Document From Resources (Legacy) 1636
  - RTF Report (Legacy) 1634
  - RTF Report From Element List 1255
  - RTF Report From Virtual Document 1623
  - WSDL 1379
  - XML Schema For Referenced Packages 1376
  - XML Schema, For Child Packages 1376
  - XSD 1376
- Generate Code
  - For Business Rule 951
  - From Activity Diagrams 1314, 1323
  - From Behavioral Models 1314
  - From Interaction Diagrams 1314, 1322
  - From Sequence Diagrams 1314, 1322
  - From State Machine Diagrams 1314, 1316
- Generate HTML Report Dialog 1648
- Generate RTF Document
  - Element Filters Tab 1611
  - From Model Search 1234
  - Other Filters Tab 1612
  - Project Constants, User Defined 1614
  - Update Links In Word 1646
- Generate RTF Documentation Dialog
  - General Tab 1573
  - Optimize For Sun Open Office 1573
  - Options 1573
  - Template Editor 1587
  - Templates Tab 1576
  - Word Substitution Tab 1615
- Generate Sequence Diagram
  - Diagram Features 1507
  - Execution Analysis 1505, 1507
- Generate Source Code
  - Enterprise Architect 5
  - Overview 1308
- Get Function
  - Create As Attribute Property 565
- Get Project Custom Colors
  - For Element 540
- Getting Started
  - Add License Key 1870
  - In Enterprise Architect 26
  - Installing Enterprise Architect 21
  - License Information 1869
  - License Management 1867
  - Register Enterprise Architect 22
  - Registration Key 1869
  - Start Enterprise Architect 27
  - Upgrade Existing License 1873
  - With MOF 1381
- Global Element
  - Generate For Global ComplexTypes 1376
  - Generate In XSD 1378
  - Import XSD 1375
- Global Elements
  - Import 1373
- Global Risks 322
- Glossary
  - A 1834
  - Add Item, Glossary Dialog 324
  - B 1836
  - C 1837
  - Create Item From Notes Text 641
  - D 1840
  - Delete Item, Glossary Dialog 324
  - Dialog 324

## Glossary

E 1842  
 F 1843  
 Filter List, Glossary Dialog 324  
 G 1844  
 H 1845  
 Hyperlink Term From Notes 641  
 I 1846  
 Insert Item In Text 641  
 J 1848  
 L 1849  
 M 1850  
 Model 323  
 Modify Item, Glossary Dialog 324  
 N 1852  
 O 1853  
 Of Terms 1833  
 P 1854  
 Project 323  
 Q 1857  
 R 1858  
 Report 328  
 Report Output Sample 328  
 S 1860  
 T 1863  
 U 1864  
 V 1865

## Glossary Detail Dialog

Add Item 325  
 Modify Item 325

## Goal

Business Modeling 933

## GoF Pattern

Concepts 1083  
 Download 901, 904  
 MDG Technology 1083  
 Toolbox Page 1083

## Group Lock

Identify Owner 207

## Group Login 197

## Group Properties Dialog

Script 1663

## Guillemets 899

**- H -**

## Hardware Description Languages

Model State Machine For 1319

## HDL

Model State Machine For 1319

## Header

Insert In RTF Template 1596

## Headers

Add To RTF Document 1643

## Help

Add-In 72  
 Display On Add-Ins 72  
 File Formats 24  
 For Tagged Values 636  
 Index Tab 23  
 Menu 74  
 Release Date 24  
 Search Tab 23  
 Systems 23  
 Tasks Pane Topics 51  
 Topic, Hyperlink To 840  
 Version Details 24

## Hidden Submenu

Create In Toolbox Profile 1135

## Hide

Code Execution (Project Menu) 62  
 Connectors 619  
 Connectors, All Diagrams 621  
 Connectors, Requirements Element 621  
 Connectors, Single Diagram 621  
 Diagram Caption Bar 59  
 Labels 622  
 Package Contents On Diagram 389  
 Project Browser 1209  
 Relationship 489  
 Toolbox 399

## Hide/Show

Connector Labels 609  
 Connectors 609

## Hierarchy

Of Requirements 922  
 Requirement, Import Via CSV 922

## Highlight

Context Element 543

## History

Deep 777  
 Element 777  
 Shallow 777

## Hotkeys

Diagram Navigation And Selection 435

## Hourly Rate 340

## HTML

And CSS Style Editor 1649  
 Documentation 1568, 1647  
 Generate HTML Report Dialog 1648  
 Locate Page By GUID 1647  
 Quick Start, Generate Report 1647  
 Report 1568, 1647

## HTML

- Report Templates 1649
- Report, Create 1647
- Style Template Fragments 1651
- Style Templates, Reporting 1649
- Template Fragments 1651
- View Report 1647

## Hyperlink

- Action Element 842
- As Sub Activities 842
- Diagrams 842
- Element 840
- In Linked Document 601
- Insert In RTF Template 1597
- Insert New From Toolbar 83
- To Element From Linked Document 601
- To External Files 842
- To Help Topics 840
- To Internet Facilities 840
- To Matrix Profiles 840
- To Model Search 840
- To Script 842
- To Team Review 840



## Icon

- Attribute Private 1213
- Attribute Protected 1213
- Checked In Package 1213
- Checked Out Package 1213
- Namespace Root Package 1213
- Operation Private 1213
- Operation Protected 1213
- Project Browser, User Defined 1108
- Version Controlled Package 1213

## ICONIX

- Disable 1084
- Elements 1084
- Enable 1084
- Layout 1084
- MDG Technology 1084
- Relationships 1084
- Roadmap 1084
- UML Toolbox Pages 1084

## Icons

- For Element On Diagram 521
- For Toolbox Items, Assign 1136

## IDE

- And Enterprise Architect 5

## Image

- Add To MDG Technology 1130
- Change Linked To Embedded 1638
- Handling, RTF 1638
- Print Scaled 456
- Refresh 447
- Scale To Page Size 456
- Select Alternative 447
- Store In Enterprise Architect 447
- Use From Image Library 449

## Image Library

- Import 449
- Use 449

## Image Manager

- Create Custom Diagram Background 448
- Select Alternative Image For Element 447
- Use 447

## IME

- Code Editor 1437

## Implementation Manager

- And Enterprise Architect 45
- Project Role 45

## Implementation Report 1626

- In Traceability 1251
- Target Types 1627

## Implemented Interfaces

- Generate/Disable Methods For 1341

## Implements

- Connector 889
- Relationship 889

## Import

- .EAB File 265
- ActionScript, Reverse Engineering 1331
- Binary Module, Reverse Engineering 1334
- C#, Reverse Engineering 1331
- C, Reverse Engineering 1331
- C++, Reverse Engineering 1331
- Code Templates 1202
- Code, Select Language 81
- Component Types 1337
- Data 225
- Database Schema from ODBC 1363
- DDL Schema from ODBC 1363
- Delphi, Reverse Engineering 1331
- Directory Structure, Reverse Engineering 1332
- EMX files 291
- From XMI 290
- Global Elements 1373
- Handle Classes Not Found 1335
- Image Library 449
- Java, Reverse Engineering 1331
- MDA-Style Transformations 1414
- MDG Technologies 1071

- Import
  - MOF From XMI 1383
  - Pattern 904
  - PHP, Reverse Engineering 1331
  - Python, Reverse Engineering 1331
  - Reference Data, Automatically 225
  - Reference Data, Introduction 223
  - Reference Data, Manually 225
  - Referenced XML Schema 1373
  - Requirements Via CSV 922
  - RTF Style Template 1576
  - RTF Template 1606
  - Scenario as Test 1544
  - Scenarios From Package 1544
  - Source Code, Reverse Engineering 1329, 1335
  - Split WSDL Files 1376
  - Technology Files 70
  - Test From Other Element 1546
  - UML Pattern 904
  - UML Profiles 908
  - UML2 files 291
  - User ID From Active Directory 192
  - Version Controlled Model Branch 265
  - Visual Basic, Reverse Engineering 1331
  - Visual Basic.Net, Reverse Engineering 1331
  - WSDL Files 1376
  - XMI 298
  - XSD 1373
- Import/Export
  - Submenu (Project Menu) 65
- Import/Export Submenu
  - Package Context Menu, Project Browser 1218
- Imported Class Elements 1367
- Inbuilt Stereotypes 835
- Include
  - Connector 864
  - Package In RTF Report 1573
  - Relationship 864
- Increase Text Display Size 75
- Index
  - Create in Data Modeling 1033
  - Unique 1033
  - What Is An? 1033
- Indicator
  - Locked Element 206
  - Visibility 427
- Information Flow
  - And Patterns 864
  - Connector 864
  - In Combination 864
  - Realized 866
  - Relationship 864
- Information Item
  - Conveyed 865
  - Element 821
- Inheritance
  - Connector 863
  - Relationship 863
- Inherited Attributes
  - Display 567
- Inherited Feature
  - Show 438
- Inherited Operation
  - Display 579
- Inherited Port
  - Manage 827
- Initial
  - Element 778
- Initial Code
  - Operations Properties 576
- Inline Features
  - Submenu (Element Menu) 68
- Inline IME
  - Option In RTF Editor 1600
- Inline Sequence Elements
  - Part And Port 714
- InnoDB
  - BaseModel Script 178
- In-place Editor
  - Automatic Scroll Into View 586
  - Connector Options 623
  - Edit Attribute Keyword 590
  - Edit Attribute Name 588
  - Edit Attribute Scope 589
  - Edit Attribute Stereotype 588
  - Edit Connector Labels 623
  - Edit Element Name 588
  - Edit Operation Name 588
  - Edit Operation Parameter Keyword 591
  - Edit Operation Parameter Kind 592
  - Edit Operation Scope 589
  - Edit Operation Stereotype 588
  - Element Item, Tasks 586
  - Element Options 586
  - Insert Attribute To Element 592
  - Insert Maintenance Feature 594
  - Insert Operation Parameter 593
  - Insert Operation To Element 592
  - Insert Testing Feature 595
- In-Place Formatting
  - Elements 521
- Input Method Editor
  - Code Editor 1437



- Insert
  - Attribute To Element, In-place Editor 592
  - Bookmarked RTF Into Word 1639
  - Boundary Element 803
  - Diagram Properties Note 440
  - Linked Elements 551
  - Maintenance Feature In Element 594
  - Operation To Element, In-place Editor 592
  - Related Elements 551
  - Testing Features In Element 595
- Install
  - Enterprise Architect 21
- Instance
  - Define Behavior On Creation, Supported Attributes 1110
  - Paste Object As 430
- Instantiated Template 813
- Integrated Development Environment 1424
- Integration Testing
  - Display Details 1540
- Integrity
  - Of Model Data 344
  - Of Project Data 344
- Integrity Check 344
- Intellisense
  - Code Editor, Common 1432
  - In Script Editor 1439
  - Keystrokes, Script Editor 1439
- Interaction
  - Behavioral Aspects 581
  - Diagram 690, 715, 717
  - Edit Parameters 581
  - Element 779
  - Elements and Connectors 410
  - Group, Toolbox 410
  - Parameter 581
  - Parameters, Define 583
- Interaction Diagram
  - Description 706
  - Diagram 706
  - Elements And Connectors 706
  - Example 706
  - Generate Code From 1314, 1322
- Interaction Occurrence
  - Behavior Call 581
  - Element 780
- Interaction Operator
  - Combined Fragment 762
- Interaction Overview Diagram
  - Description 717
  - Elements And Connectors 717
  - Example 717
- InteractionUse
  - Element 780
- Interface
  - Element 821
  - Expose Element 820
  - Provided 820
  - Required 820
  - Set For Element 526
  - Source Code Generation 1308
- Intermediary Language
  - MDA-Style Transforms 1415
- Intermediate Event, BPEL
  - Create 968
  - Model 968
  - Types 968
- Internal Binding
  - PIM to PSM 1385
- Internal Editor
  - Language Properties 1337
- Internal Requirement
  - Define 925
  - Properties 925
- Internet Browser Applets
  - Java, Debug 1454
- Internet Facilities
  - Hyperlink To 840
- Internet Search Engine
  - Access Within Enterprise Architect 103
  - Define Default 351
- Interrupt Flow
  - Connector 867
  - Relationship 867
- Interruptible Activity Region
  - Add 782
  - Element 781
- Interval Bar
  - Context Menu 700
  - Timing Diagram Time Interval 700
- Introduction
  - Copyright Notice 16
  - Enterprise Architect Key Features 8
  - Help File Formats 24
  - License Agreement 16
  - Support 24
  - To Code Engineering 1281
  - To Enterprise Architect 3, 4
  - To Enterprise Architect SDK 1092
  - To Forward Engineering 1281
  - To Quick Linker 474, 1113
  - To Reverse Engineering 1281
  - To Round-trip Engineering 1281
  - To Shape Scripts 1147

- Introduction
    - To Synchronization 1281
    - To Tagged Value Types 1166
    - To UML Objects 741
    - Trademarks 19
  - Invocation
    - Associate With Behaviors 582
    - Re-associate With Behaviors 582
    - Synchronize Arguments With Behavior Parameters 582
  - Invocations
    - Modeling 581
  - Invoke
    - Connector 406
    - Method, Object Workbench 1522
  - Issue
    - Create From Test Item 1548
    - Elements And Requirements 928
  - Issue (Defect)
    - Add 1563
    - Automation Interface, Element Package 1718
    - Element 1563
    - Hide Stereotype Letter 1563
    - Show Stereotype Letter 1563
  - Issue (Project)
    - Add 334
    - Delete 334
    - Model 331
    - Modify 334
    - Report, Generate 331
  - Issues Report
    - Sample Output 335
    - Via Project Issues Tab 334
  - isUnique
    - UML Property 629
  - Iterate Through EAP File
    - Automation Interface Code Example 1766
- J -**
- Java
    - Advanced Debug Techniques 1454
    - Applets In Internet Browsers, Debug 1454
    - AspectJ Extensions 1331
    - Code Generated From State Machine Diagram 1317
    - Code Generation 1355
    - Debug 1452
    - Debug Session, Attach To VM 1454
    - Debug, System Requirements 1447
    - General Debug Setup 1453
    - Import, Reverse Engineering 1331
    - Language Options 1355
    - Modeling Conventions 1293
    - Modeling Conventions, AspectJ Extensions 1294
    - Transformation, MDA-Style Transform 1403
    - Web Servers, Debugging 1456
  - JavaScript 1660, 1661
  - JBOSS
    - Server Configuration 1458
    - Server, Debugging 1456
  - Join
    - Element 773, 776
    - Pseudo-State 773, 776
  - JScript 1660, 1661
  - Junction
    - Element 782
  - JUnit Transformation
    - MDA-Style Transform 1405
- K -**
- Key
    - Combinations 104
    - Missing Combination 90
  - Key Bindings
    - Code Editor, Common 1433
  - Key Features
    - Of Enterprise Architect 8
  - Key Store
    - File Based 1870
    - Network Based 1870
  - Keyboard
    - Accelerator Map 104
    - And Mouse Shortcuts 109
    - Missing Combination 90
    - Shortcuts 104
    - Shortcuts, Customize 98
    - Shortcuts, Reset 98
  - Key-Mouse
    - Combinations 109
  - Keys
    - Foreign, Definition 1011
    - Primary, Definition 1011
  - Keystore
    - Troubleshooting 1872
  - Keywords
    - For RTF Report (Legacy) 1637
- L -**
- Label

- Label
  - Alignment 452
  - Bold 452
  - Connector 452
  - Connector, Hide/Show 609
  - Direction Indicator 452
  - Display Under Toolbar Icons 92
  - Element 452
  - Hide 452, 622
  - Menu 452
  - Set Color 452
  - Show 622
  - Show And Hide In Toolbox 401
  - Visibility 622
- Label Visibility
  - On Sequence Messages 714
- Language
  - Adjust in RTF (Legacy) 1637
  - Adjust in RTF Report 1615
  - Create Properties As Attributes 565
  - Custom, Create Templates For In Code Template Editor 1206
  - For Spell Check, Download 1554
  - Macros 1344
- Language Options
  - ActionScript 1348
  - Ada 2005 1348
  - C 1349
  - C# 1350
  - C++ 1351
  - Code Editor 1338
  - Code Generation 1347
  - Delphi 1352
  - Java 1355
  - MDG Technology 1360
  - PHP 1356
  - Python 1356
  - SystemC 1357
  - VB.NET 1358
  - Verilog 1358
  - VHDL 1359
  - Visual Basic 1360
- Languages
  - For Modeling, Introduction 671
- Layout
  - Diagram, Automatically 471
  - Diagram, Move Sections 454
  - ICONIX 1084
  - Sequence Diagram 709
- Layout Diagram
  - Auto Route Layout 470
  - Box Layout 463
  - Center Focussed Layout 459
  - Circular Layout 459
  - Converge Layout 467
  - Digraph Layout 465
  - Diverge Layout 467
  - Elliptical Layout 459
  - Fan Relations Layout 469
  - Main Procedure 458
  - Neaten Layout 467
  - Options 458
  - Per Page Layout 464
  - Spring Layout 466
  - Tool 458
  - Top-To-Bottom Circle 459
- Layout Tools Window 458
- Lazy Loading
  - Enterprise Architect Performance 148, 150, 153, 160, 162, 165
  - For ASA Data Repository 162
  - For MSDE Server Data Repository 165
  - For MySQL Data Repository 148
  - For Oracle Data Repository 153
  - For PostgreSQL Data Repository 160
  - For Progress OpenEdge Data Repository 165
  - For SQL Server Data Repository 150
- Legend
  - Add To Diagram 441
  - Add To State Machine Table 689
  - Edit 441
  - Element 441
  - Insert New From Toolbar 83
  - Remove From State Machine Table 689
  - Style 441
- Letter A
  - Red 597, 599
- Level Numbering
  - For Requirements 922
  - Show In Project Browser 1214
- License
  - Agreement 16
  - Information 1869
  - Management 1867
- Lifecycle
  - Of A Sequence Element 708
- Lifeline
  - Element 783
  - Objects In Sequence Diagrams 710
  - Sequence Element, Termination 708
- Limit Auto Recording to Stack Frame Threshold
  - Build Script, Sequence Diagram Recording Tab 1496
- Limitations

- Limitations
  - Of XMI 293
- Line
  - Angles, Tidy 615
  - Bend At Cursor 615
  - Bezier 615
  - Straighten At Cursor 615
  - Style 615
  - Supress Segments 615
- Line Points
  - Add 615
  - Delete 615
  - Toggle 615
- Line Selection
  - Code Editor, Common 1432
- Link
  - Add Note 612
  - Copy Between Instances Of Elements From Project Browser 618
  - Create Between Elements 618
  - Create From Project Browser 618
  - Display Options 364
  - Paste Object As 430
  - Window 1269
- Link Notes
  - To Element Feature 537
  - To Internal Documentation 537
- Linked Document
  - Create 597
  - Create Diagram From 602
  - Create Document Artifact 599
  - Create Element From 602
  - Create For UML Element 599
  - Create Glossary Definition In 600
  - Delete 602
  - Edit 600
  - Editor Context Menu 600
  - Hyperlink 601
  - Introduction 597
  - Link Into RTF Report 597, 1579
  - Replace 602
  - To UML Element 599
- Linked Document Template
  - Add To MDG Technology 1133
  - Assign To Group 603
  - Create 603
  - Delete 603
  - Edit 604
  - Modify 603
- Linked Element
  - Convert To Local Copy 544
- Linked Image
  - Change To Embedded 1638
- List Macro
  - Code Template Syntax 1190
- List Overrides
  - RTF Reports 1601
- Load
  - Controlled Package 297
  - Report Templates (Legacy) 1634
- Loaded Modules
  - Show In Debugger 1478
- Local
  - Directories 1343
  - Path Dialog 1343
  - Paths 1343
  - Pre/Post Conditions 752
- Local Variables
  - View 1474
  - View Long Values 1474
- Locals Window 1474
  - View Long Values 1474
- Lock
  - Apply User Lock 205
  - Connector 200
  - Delete 200
  - Delete, User level 207
  - Diagram, Rigorous Security Mode 205
  - Diagram, Security Off 457
  - Diagram, User/Group Lock 204
  - Element 200
  - Element, Security Off 555
  - Identify Owner 207
  - Manage 200
  - Manage, User-Level 207
  - Model Elements, Rigorous Security Mode 205
  - Model Elements, User/Group Lock 204
  - Package, Rigorous Security Mode 205
  - Package, User/Group Lock 204
  - Packages 205
  - Release User Lock 205
  - Standard Security Policy 204
  - View 200
  - View, User Level 207
- Locked Element
  - Add Connectors 204
  - Indicators 206
- Log
  - Audit, Clear 272
  - Audit, Load 272
  - Audit, Save 272
- Logical Diagram
  - Class Diagram 721
- Logical Model 376

- Login
  - As Different User (Security) 64
  - Group 197
  - Multiple Under One ID 197
- Loop Node
  - Structured Activity 796, 798
- M -**
- Macro
  - Behavioral Model 1193
  - Branching 1190
  - Code Template Syntax 1173, 1190
  - Control 1190
  - CONVERT\_DB\_TYPE 1421
  - CONVERT\_NAMES 1422
  - CONVERT\_TYPE 1421
  - EASL Code Generation 1193
  - EASL\_GET 1193
  - EASList 1193
  - Field Substitution, Code Template Syntax 1174
  - Function, Code Template Syntax 1187
  - Language 1344
  - List 1190
  - PI 1190
  - Preprocessor 1344
  - REMOVE\_PREFIX 1422
  - SQL Search 1239
  - Synchronization 1190
  - Tagged Value, Code Template Syntax 1186
  - Template Substitution, Code Template Syntax 1173
  - TRANSFORM\_CLASSIFIER 1423
  - TRANSFORM\_CURRENT 1421
  - TRANSFORM\_REFERENCE 1419, 1423
- Main Context Menu 54
- Main Menu 54
- Maintain
  - Groups 197
  - Security Users 191
- Maintenance
  - Asterisk On Maintenance Window Tabs 1558
  - Compartment, Element 521
  - Create Defect Item From Test 1548
  - Dialog 660
  - Elements And Connectors 418
  - Feature, Insert In Element 594
  - Group, Toolbox 418
  - Items 1558
  - Model Template 381
  - Of Element Properties 1559
  - Problem Types 660
  - Script, Show In Compartments 1561
  - Support 1559
  - Testing Types 661
  - Window 1558
  - Workspace 1558
- Maintenance Diagram
  - Description 737
  - Elements And Connectors 737
  - Example 737
- Maintenance Item
  - Copy Between Categories 1561
  - Create Element From 1561
  - Move Between Categories 1561
- Make Same
  - Submenu 70
- Manage
  - Add-Ins 1781
  - Baselines 281
  - Bookmarks 341
  - Changes 228
  - Diagrams 421
  - Elements 522
  - Inherited Ports 827
  - Locks 200
  - MDG Technologies 1069
  - Redefined Ports 827
  - Requirements 927
  - User-Level Locks 207
  - Views 383
  - Views, Add Views 383
  - Views, Delete 385
  - Views, Rename 384
- Manage .EAP File
  - Submenu (Tools Menu) 71
- Managed C++
  - Modeling Conventions 1290
- Manifest
  - Connector 867
  - Relationship 867
- Manual Recording
  - Execution Analysis, Recording Sequence Diagrams 1504
- Manual Version Control
  - With XMI 299
- Map State Changes
  - Visual Execution Analyzer 1511
- Mapper
  - Data Type Conversion Procedures 1035
- Marker
  - Storage 1469
- Marker Management

- Marker Management
  - Debugger 1468
- Marker Sets
  - Work With 1503
- Masked Tagged Values
  - Create 1171
- Master Document
  - Element 1616
  - Element, Create 1618
  - Generate Documentation 1623
  - Overview, Virtual Document 1616
  - RTF Bookmarks In 1616
  - Tagged Values 1618
- Matrix
  - Swimlanes 444
- Matrix Profile
  - Hyperlink To 840
- MDA Transform
  - Add To MDG Technology 1130
- MDA Transformation
  - Built-In 1385
  - Enterprise Architect 5
  - Overview 1385
  - Project Menu Option 63
- MDA-Style Transformation
  - Built In Transformation 1388
  - C# Transformation 1389
  - Chaining Transformations 1388
  - Convert Datatypes 1421
  - Convert Names 1422
  - Convert Types 1421
  - Copy Information 1421
  - Create Connectors 1419
  - Cross References 1423
  - Data Model To ERD Transformation 1390
  - DDL Transformation 1393
  - Duplication Of Connectors 1419
  - EJB Transformations 1397
  - ERD To Data Model Transformation 1399
  - Import Transformations 1414
  - Intermediary Language 1415
  - Java Transformation 1403
  - JUnit Transformation 1405
  - NUnit Transformation 1407
  - Specify Classifiers 1423
  - Transform Connectors 1419
  - Transform Elements 1387
  - Transformation Templates 1412
  - Write Transformations 1414
  - WSDL Transformation 1408
  - XSD Transformation 1409
- MDDE
  - Advanced Debug Techniques, Java 1454
  - Available Tools 1424
  - Basic Setup 1425
  - Breakpoint Management 1468
  - Build Script, Create 1444
  - Build Script, Introduction 1443
  - Code Editors 1425
  - Debug .NET 1460
  - Debug .NET Assembly 1461
  - Debug .NET CLR Versions 1462
  - Debug .NET With COM Interop Process 1463
  - Debug Apache Tomcat Server Configuration 1459
  - Debug Apache Tomcat Windows Service 1460
  - Debug ASP .NET 1463
  - Debug Java 1452
  - Debug Java Applets In Internet Browsers 1454
  - Debug Java Web Servers 1456
  - Debug JBOSS Server Configuration 1458
  - Debug Symbols, C++ And Native Applications 1452
  - Debugger Frameworks 1446
  - Debugger System Requirements 1447
  - Debugger, Overview 1446
  - Default Script, Set 1428
  - External Tools 1425
  - For C++ Applications 1451
  - For Microsoft Native Applications 1451
  - For WINE Applications 1450
  - General Debug Setup, Java 1453
  - General Workflow 1425
  - Generate Code 1425
  - Getting Started 1424
  - Introduction 1424
  - Java Debug Session, Attach To VM 1454
  - Limitations 1277
  - Marker Management 1468
  - Model Driven Development Environment 1489
  - Overview 1277
  - Package Build Scripts, Manage 1426
  - Pin/Unpin A Package 1428
  - Prerequisites 1424
  - Recursive Builds 1446
  - Script Actions, Define 1427
  - Set Up Debug Session 1447
  - Set Up Debug Session For .NET 1461
  - Supported Environments 1277
  - Synchronize Code 1425
  - UAC-Enabled Operating Systems 1448
  - Workspace Layout 1424
- MDG Add-In For
  - CORBA 1073

- MDG Add-In For
  - Data Distribution Service 1073
  - DDS 1073
  - Department Of Defense Architecture Framework - Ministry Of Defence Architecture Framework 1073
  - DoDAF-MODAF 1073
  - DOORS 1073
  - Eclipse 1073
  - Enterprise Java Beans 1073
  - Python 1073
  - Strategic Modeling 1073
  - SysML 1073
  - Systems Modeling Lanuages 1073
  - TcSE 1073
  - Teamcenter Systems Engineering, Siemens PLM 1073
  - Testing 1073
  - The Open Group Architecture Framework 1073
  - TOGAF 1073
  - Visio 1073
  - Visual Studio 2005/2008 1073
  - Visual Studio.NET 1073
  - Zachman Framework 1073
- MDG Add-Ins
  - Add-In Model 1821
  - MDG Events 1822
  - MDG\_BuildProject 1822
  - MDG\_Connect 1822
  - MDG\_Disconnect 1823
  - MDG\_GetConnectedPackages 1824
  - MDG\_GetProperty 1824
  - MDG\_Merge 1825
  - MDG\_NewClass 1826
  - MDG\_PostGenerate 1827
  - MDG\_PostMerge 1827
  - MDG\_PreGenerate 1828
  - MDG\_PreMerge 1828
  - MDG\_PreReverse 1829
  - MDG\_Run\_Exe 1830
  - MDG\_View 1830
- MDG Events
  - Add-In Model 1822
  - MDG\_BuildProject 1822
  - MDG\_Connect 1822
  - MDG\_Disconnect 1823
  - MDG\_GetConnectedPackages 1824
  - MDG\_GetProperty 1824
  - MDG\_Merge 1825
  - MDG\_NewClass 1826
  - MDG\_PostGenerate 1827
  - MDG\_PostMerge 1827
- MDG\_PreGenerate 1828
- MDG\_PreMerge 1828
- MDG\_PreReverse 1829
- MDG\_Run\_Exe 1830
- MDG\_View 1830
- MDG Integration For
  - Eclipse 1073
  - TcSE 1073
  - Teamcenter Systems Engineering, Siemens PLM 1073
  - Visual Studio 2005/2008 1073
- MDG Link For
  - DOORS, Telelogic 1073
  - Eclipse 1073
  - Visio 1073
  - Visual Studio.NET 1073
- MDG Technology
  - Access, Remote From Enterprise Architect 1070
  - Activate 1069
  - Active, Automatically Pinned Pages 401
  - And Resources Window 1067
  - Code Generation 1360
  - Create 1118
  - Create Toolbox Profile For 1134
  - Define Tasks Pane Profile 1141
  - Define Validation Configuration 1145
  - Deploy From Add-In 1146
  - Deploy From File 1146
  - Disable 1069
  - Enable 1069
  - Example Of Development 1118
  - Import 1071
  - Include Custom Diagram Types 1139
  - Incorporate Model Template 1146
  - Introduction 1066, 1118
  - Language Options 1360
  - Link for Downloads 1066
  - Manage 1069
  - Toolbox Groups 1067
- MDG Technology (Integrated)
  - Archimate 1073
  - BPEL 958
  - BPMN 952
  - Data Flow Diagram 1076
  - Entity Relationship Diagram 1077
  - Eriksson-Penker 1080
  - Gang Of Four Pattern 1083
  - GoF Pattern 1083
  - ICONIX 1084
  - Mind Mapping 1087
  - SoaML 1089

- MDG Technology (Integrated)
  - SPEM 1061
  - SysML 989
- MDG Technology For
  - CORBA 1073
  - Data Distribution Service 1073
  - DDS 1073
  - Department Of Defense Architecture Framework - Ministry Of Defence Architecture Framework 1073
  - DoDAF-MODAF 1073
  - Enterprise Java Beans 1073
  - Python 1073
  - Strategic Modeling 1073
  - SysML 1073
  - Systems Modeling Languages 1073
  - Testing 1073
  - The Open Group Architecture Framework 1073
  - TOGAF 1073
  - Zachman Framework 1073
- MDG Technology Selection (MTS) File 1133
- MDG Technology Wizard
  - Add Code Modules 1128
  - Add Diagram Type To Technology 1124
  - Add Images 1130
  - Add Linked Document Template To Technology 1133
  - Add MDA Transforms 1130
  - Add Pattern To Technology 1123
  - Add Profile To Technology 1122
  - Add RTF Report Template To Technology 1132
  - Add Scripts 1131
  - Add Tagged Value Types 1127
  - Add Task Panel To Technology 1126
  - Add Toolbox To Technology 1125
  - Create Technologies 1118
- MDG\_BuildProject
  - Add-In Model 1822
- MDG\_Connect
  - Add-In Model 1822
- MDG\_Disconnect
  - Add-In Model 1823
- MDG\_GetConnectedPackages
  - Add-In Model 1824
- MDG\_GetProperty
  - Add-In Model 1824
- MDG\_Merge
  - Add-In Model 1825
- MDG\_NewClass
  - Add-In Model 1826
- MDG\_PostGenerate
  - Add-In Model 1827
- MDG\_PostMerge
  - Add-In Model 1827
- MDG\_PreGenerate
  - Add-In Model 1828
- MDG\_PreMerge
  - Add-In Model 1828
- MDG\_PreReverse
  - Add-In Model 1829
- MDG\_Run\_Exe
  - Add-In Model 1830
- MDG\_View
  - Add-In Model 1830
- MDGMenus Enum
  - Automation Interface 1677
- Memory Viewer
  - Window 1476
- Menu
  - Add-Ins 72
  - Context 48
  - Context, Project Browser 1213
  - Customize Appearance 100
  - Delete Options 100
  - Diagram 65
  - Diagram Context 394
  - Edit 57
  - Element 67
  - Element Context 547
  - File 56
  - Help 74
  - Items, Define In Add-In 1777
  - Label 452
  - Main 54
  - Main Context 54
  - Missing Option 90
  - New Element Or Connector Context 395
  - Other Element Tools 58
  - Other Project Tools 58
  - Package Control 294
  - Project 60
  - Properties, Element Context 548
  - Set Animation 100
  - Set Shadowing 100
  - Settings (Project) 73
  - Toolbars (View Menu Option) 58
  - Tools 70
  - Version Control (Package) 257
  - Version Control (Project) 256
  - View 58
  - Visual Styles (View Menu Option) 58
  - Window 74
- Menu Option (File Menu)



- Menu Option (File Menu)
  - Close Project 56
  - Exit 56
  - New Project 56
  - Open Project 56
  - Open Source File 56
  - Page Setup 56
  - Print 56
  - Print Preview 56
  - Print Setup 56
  - Reload Current Project 56
  - Save Project As 56
- Merge
  - Baseline With Current Model, Overview 279
  - Element 765, 784
  - Node 784
  - Options, Compare Utility 285
- Merge Packages
  - Relationship 888
- Message
  - Asynchronous Signal 877
  - Collaboration 880
  - Colors In Communication Diagrams 716
  - Communication 879
  - Communication, Coloring 366
  - Communication, Create 880
  - Connector 867
  - Create On Timing Diagram 883
  - Endpoint 784
  - Group, Start New 880
  - Label 785
  - Level 880
  - Move 867
  - Recursion 890
  - Relationship 867
  - Scope 624
  - Self Message 871
  - Self Message Call 872
  - Sequence Communication 880
  - Sequence Diagram, Asynchronous Signal 877
  - Sequence Diagram, Examples 873
  - Sequence Diagram, General Ordering 876
  - Sequence Diagram, Self Message 871
  - Sequence, Create 868
  - Sequence, Label Visibility 714
  - Sequencing 880
  - Source and Target 624
  - Timing Diagram 882
  - WSDL Diagram 1056
  - WSDL Element 1056
- Message Angle
  - Adjust With Duration Constraint 874
- Message Part
  - WSDL Attribute 1060
- Meta Object Facility
  - Introduction 1380
- Metaclass
  - Add To Profile 1096
- Metafile
  - Supported In UML Profiles 912
- META-INF Package 1397
- Metamodel
  - Elements and Connectors 415
  - Group, Toolbox 415
- Method
  - Add And Delete, Automation Interface Code Example 1769
  - Automation Interface, ElementFeatures Package 1732
  - Context Menu, Project Browser 1221
  - Delete If Not In Code In Reverse Synchronization 1341
  - From Rule Flow Activity 942
  - Implemented Interfaces 1341
  - Include Bodies In Model When Reverse Engineering 1341
  - Invoke, Object Workbench 1522
  - Show Parameters On Diagram 429
  - Work With, Automation Interface Code Example 1774
- MethodConstraint
  - Automation Interface, ElementFeatures Package 1733
- Methodology
  - FDD 840
  - Feature-Driven Design 840
- MethodTag
  - Automation Interface, ElementFeatures Package 1734
- Metric
  - Automation Interface, Element Package 1719
- Metric Types
  - Define 320
  - Global 320
  - Non-Global 317
- Metrics 659
  - Project Management Window 312
- Metrics And Estimation
  - Default Hour Rate 340
  - ECF 337
  - Effort Types 319
  - Environment Complexity Factors 337
  - For An Element 317
  - Metric Types 320
  - Risk Types 322

- Metrics And Estimation
  - TCF 336
  - Technical Complexity Factors 336
- Microsoft Native
  - Debug Symbols 1452
  - Set Up Debug Sessions 1451
- Microsoft Word
  - Special Considerations 1641
  - Use In RTF Documentation 1638
- Migrate
  - BPMN 1.0 Model To 1.1 957
- MigrateToBPMN11()
  - Function 957, 1753
- Migration
  - From UML 1.3 344
  - To UML 2.0 344
- Mind Mapping
  - Concept 1087
  - Diagram 1087
  - Disable 1087
  - Elements 1087
  - Enable 1087
  - MDG Technology 1087
  - Relationship 1087
  - Toolbox Page 1087
- MiscData 1711
- Model
  - Activity, BPEL 974
  - Add To Project 112
  - Analysis, Business Processes 931
  - Automation Interface 1672
  - BPEL Process 961
  - BPEL, Create 959
  - Business Domain, Create 938
  - Business Processes, Analysis 931
  - Business Rules 934
  - Connect To Version Control Using TFS 253
  - Contents 372
  - Context Menu, Project Browser 1213
  - Data Integrity 344
  - Databases 1011
  - Default Diagram, Cancel 437
  - Default Diagram, Set 437
  - Default Fonts 357
  - Delete Element From 534
  - Delete Multiple Elements From 534
  - Gateway, BPEL 972
  - Glossary 323
  - Integrity Check 344
  - Integrity, Run SQL Patches 346
  - Issues 331
  - Navigation Tools 1208
  - Package, Create Using Model Wizard 372
  - Pattern 372
  - Pool, BPEL 979
  - Remove Recent 56
  - Requirements 917, 922
  - Requirements, SysML, Create 1007
  - Root Node 1213
  - Search Tools 1208
  - Sequence Flow, BPEL 980
  - Sharing, Introduction 182
  - Shortcut 115
  - Shortcut (Capture Current Environment) 117
  - Shortcut (Direct Definition) 116
  - Structure 370
  - SysML Operational Domain, Create 1007
  - SysML Parametric, Create 1002
  - SysML System Design 1009
  - SysML, Simulate 1005
  - Systems Engineering, Create 986
  - Templates, Incorporate In Technology 1146
  - Trace Tools 1208
  - Transformation 1387
  - UML, Specialized 917
  - Upgrade 346
  - What Is A? 372
  - WSDL 1050
  - WSDL, Binding 1057
  - WSDL, Document 1053
  - WSDL, Message 1056
  - WSDL, Message Part 1060
  - WSDL, Namepace 1051
  - WSDL, Port Type 1056
  - WSDL, Port Type Operation 1059
  - WSDL, Service 1054
  - XSD 1040
- Model Branch
  - .EAB File 264
  - Apply Version Control 264
  - Check In 261
  - Check Out 261
  - Export 264
  - File 264
  - Import 265
- Model Changes
  - Auditing 270
  - Record 270
- Model Document
  - Add Packages As Attributes 1620
  - Change Package Sequence 1622
  - Delete Package Attributes 1621
  - Delete Packages 1621
  - Document Order 1622

- Model Document
  - Element 1616
  - Element, Create 1619
  - Generate Documentation 1623
  - Identify Search For 1619
  - Model Search Sequence 1622
  - Move Package Attributes Between Elements 1622
  - Overview, Virtual Document 1616
  - Select Template For 1619
  - Sequence of Model Document Elements 1622
  - Sequence of Package Attributes 1622
  - Tagged Values 1619
- Model Driven Achitecture
  - Overview 1385
- Model Driven Development Environment 1424
  - Advanced Debug Techniques, Java 1454
  - Available Tools 1424
  - Basic Setup 1425
  - Breakpoint Management 1468
  - Build Script, Create 1444
  - Build Script, Introduction 1443
  - Code Editors 1425
  - Debug .NET 1460
  - Debug .NET Assembly 1461
  - Debug .NET CLR Versions 1462
  - Debug .NET With COM Interop Process 1463
  - Debug Apache Tomcat Server Configuration 1459
  - Debug Apache Tomcat Windows Service 1460
  - Debug ASP .NET 1463
  - Debug Java 1452
  - Debug Java Applets In Internet Browsers 1454
  - Debug Java Web Servers 1456
  - Debug JBOSS Server Configuration 1458
  - Debug Symbols, C++ And Native Applications 1452
  - Debugger Frameworks 1446
  - Debugger System Requirements 1447
  - Debugger, Overview 1446
  - Default Script, Set 1428
  - External Tools 1425
  - For C++ Applications 1451
  - For Microsoft Native Applications 1451
  - For WINE Applications 1450
  - General Debug Setup, Java 1453
  - General Workflow 1425
  - Generate Code 1425
  - Getting Started 1424
  - Introduction 1489
  - Java Debug Session, Attach To VM 1454
  - Limitations 1277
- Marker Management 1468
- Overview 1277
- Package Build Scripts, Manage 1426
- Pin/Unpin A Package 1428
- Prerequisites 1424
- Recursive Builds 1446
- Script Actions, Define 1427
- Set Up Debug Session 1447
- Set Up Debug Session For .NET 1461
- Supported Environments 1277
- Synchronize Code 1425
- UAC-Enabled Operating Systems 1448
- Workspace Layout 1424
- Model Driven Generation
  - Add-Ins 1073
- Model File
  - Connect To ASA Data Repository 162
  - Connect To Data Repository 147
  - Connect To MSDE Server Data Repository 165
  - Connect To MySQL Data Repository 148
  - Connect To Oracle 10g Data Repository 153
  - Connect To Oracle 11g Data Repository 153
  - Connect To Oracle 9i Data Repository 153
  - Connect To PostgreSQL Data Repository 160
  - Connect To Progress OpenEdge Data Repository 165
  - Connect To SQL Server Data Repository 150
  - Create Access 2007 Repository 123
  - Create Adaptive Server Anywhere Repository 132
  - Create Data Repository 123
  - Create Model 120
  - Create MSDE Server Repository 134
  - Create MySQL Repository 123
  - Create Oracle 10g Server Repository 129
  - Create Oracle 11g Server Repository 129
  - Create Oracle 9i Server Repository 129
  - Create PostgreSQL Repository 129
  - Create Progress OpenEdge Repository 134
  - Create SQL Server Repository 126
  - Enterprise Architect Project Files 112
  - Set Up Adaptive Server Anywhere ODBC Driver 141
  - Set Up Database Model Files 122
  - Set Up MySQL ODBC Driver 135
  - Set Up ODBC Driver 135
  - Set Up PostgreSQL ODBC Driver 138
  - Set Up Progress OpenEdge ODBC Driver 145
- Model Glossary
  - Add Item, Glossary Detail Dialog 325
  - Add Item, Glossary Dialog 324
  - Delete Item, Glossary Dialog 324

- Model Glossary
  - Delete Item, Project Glossary Tab 325
  - Filter List, Glossary Dialog 324
  - Filter List, Project Glossary Tab 325
  - Glossary Dialog 324
  - Glossary Report 328
  - Modify Item, Glossary Detail Dialog 325
  - Modify Item, Glossary Dialog 324
  - Project Glossary Tab 325
  - Redefine Entry Type, Project Glossary Tab 325
- Model Maintenance (.EAP)
  - Compact Project 348
  - Introduction 344
  - Rename Project 348
  - Repair Project 348
- Model Pattern
  - Introduction 373
  - Select In Enterprise Architect 28
- Model Profile
  - Apply 444
  - Save 444
  - Swimlanes Matrix 444
  - Zachman 444
- Model Search
  - Access From Add-In 1233, 1781
  - Access From MTS File 1233
  - Access From Shortcut 115, 117, 1233
  - Access From Shortcut (Direct Definition) 116
  - Add Data Columns 1231
  - Add Filters 1242
  - Advanced Search Options 1238
  - Conditions 1243
  - Create Search Definition 1239
  - Define In MTS File 1133
  - Export Search Definitions 1235
  - External Access 1233
  - Fields 1243
  - Find Object In Diagrams 1234
  - Find Object In Project Browser 1234
  - Generate RTF Documentation 1234
  - Generate RTF Report 1570
  - Group Results 1231
  - Hyperlink To 840, 1233
  - Import Search Definitions 1235
  - Introduction 1231
  - Manage 1235
  - Notes Options 1231
  - Operate On Objects In Results 1234
  - Options 1231
  - Process Results Of Search 1231, 1234
  - Remove Data Columns 1231
  - To Populate Model Views 1226
  - Toolbar Options 1231
  - Use 1233
  - View 1231
- Model State Machine
  - Active State Logic 1319
  - Designate Driving Triggers 1319
  - Establish Port-Trigger Mapping 1319
  - For Hardware Description Languages 1319
- Model Template
  - Business Process 374
  - Class 376
  - Component 378
  - Database 377
  - Deployment 378
  - Domain 376
  - Introduction 373
  - Logical 376
  - Maintenance 381
  - Physical 378
  - Project 381
  - Relational Database 377
  - Requirements 374
  - Testing 380
  - Use Case 375
- Model Transfer
  - Introduction 287
- Model Transformations
  - Submenu (Project Menu) 63
- Model Validation
  - BPEL Violations 984
  - Configure 1530
  - Define Configuration For MDG Technology 1145
  - Element Composition Rule 1531
  - Object Constraint Language 1528
  - OCL 1528
  - OCL Conformance Rule 1532
  - Of BPEL 984
  - Property Validity Rule 1532
  - Rule, Element Composition 1531
  - Rule, OCL Conformance 1532
  - Rule, Property Validity 1532
  - Rule, Well Formedness 1531
  - Rules 1530
  - Submenu (Project Menu) 64
  - Well Formedness Rule 1531
- Model Validation Broadcasts
  - Add-In Model 1811
  - EA\_OnEndValidation 1813
  - EA\_OnInitializeUserRules 1812
  - EA\_OnRunAttributeRule 1815

- Model Validation Broadcasts
  - EA\_OnRunConnectorRule 1814
  - EA\_OnRunDiagramRule 1814
  - EA\_OnRunElementRule 1813
  - EA\_OnRunMethodRule 1815
  - EA\_OnRunPackageRule 1813
  - EA\_OnRunParameterRule 1816
  - EA\_OnStartValidation 1812
  - Model Validation Example 1816
- Model Views
  - Automatic Notification 342
  - Context Menu Options 1224
  - Define In MTS File 1133
  - Define Search 1226
  - Delete (Context Menu) 1224
  - Delete (Toolbar) 1223
  - Display Recent Postings 1226
  - Enable Technology-Defined View 1226
  - Export As XML 1226
  - Favorites 1222
  - Favorites Folder, Create (Context Menu) 1224
  - Favorites Folder, Create (Toolbar) 1223
  - For Requirement Change Management 928
  - Import As XML 1226
  - Monitor Work Flow 342
  - Move Objects Between Views 1226
  - Move Objects Into Favorites 1226
  - My Views 1222
  - Operations 1226
  - Postings From Team Review 1222
  - Properties 1226
  - Recent Discussions 1222
  - Recent Post Options 1224
  - Refresh (Toolbar) 1223
  - Refresh Search 1226
  - Root Node, Create (Context Menu) 1224
  - Root Node, Create (Toolbar) 1223
  - Slide Show, Run (Manual) 1228
  - Slideshow 1222
  - Slideshow Folder, Create (Toolbar) 1223, 1228
  - Slideshow, Automate 1228
  - Technology-Defined 1222
  - Toolbar Options 1223
  - Use Objects In Views And Favorites 1226
  - View, Create (Context Menu) 1224
  - View, Create (Toolbar) 1223
  - Views 1222
  - Views Folder, Create (Context Menu) 1224
  - Views Folder, Create (Toolbar) 1223
  - Window 1222
- Model Violations
  - Examples 1528
- Model Wizard
  - Add Model Package 372
  - Quick Start 28
  - Use To Create Model 120
- Modeling
  - Behavior Calls 581
  - Behaviors (General) 569
  - Enterprise Architect Processes 4
  - Enterprise Architect Tools and Features 48
  - Enterprise Architect, Getting Started 26
  - Getting Started - Enterprise Architect 26
  - Invocations 581
  - Languages, Introduction 671
  - Systems Engineering 986
  - Tasks With Enterprise Architect 4
  - The Business Process 930
  - With Diagrams 391
  - With Elements 478
  - With Enterprise Architect, Overview 371
- Modeling Conventions 1282
  - ActionScript 2 and 3 1283
  - Ada 2005 1284
  - ANSI C 1285
  - C 1285
  - C# 1287
  - C, Object Oriented Programming 1286
  - C++ 1289
  - C++, Managed 1290
  - C++/CLI Extensions 1291
  - Delphi 1292
  - Java 1293
  - Java AspectJ Extensions 1294
  - Object Oriented Programming in C 1286
  - PHP 1294
  - Python 1295
  - SystemC 1295
  - VB.NET 1296
  - Verilog 1298
  - VHDL 1299
  - Visual Basic 1301
- Modeling Language
  - Extending 1092
- Modeling Tool
  - Enterprise Architect 3
- Models Collection 1680
- Model-View-Controller Pattern 838
- ModelWatcher
  - Automation Interface Repository 1698
- Modify
  - Element Changes 1559
  - Element Defects 1559
  - Element Issues 1559

- Modify
    - Element Tasks 1559
    - Linked Document Template 603
    - Project Task 330
    - Relationship Using Matrix 1266
    - RTF Style Template (Legacy) 1634
    - Tagged Values 635
  - Modules
    - Window 1478
  - MOF
    - Export To XMI 1383
    - Getting Started 1381
    - Import From XMI 1383
    - Introduction 1380
  - Monitor
    - Events 342
    - Progress 342
    - Work Flow 342
  - Mouse/Keyboard
    - Shortcuts 109
  - Mouseovers
    - Code Editor, Common 1432
  - Move
    - Attributes Between Elements 545
    - Connectors 613
    - Connectors, Quick Start 34
    - Diagram Sections 454
    - Diagrams, Quick Start 34
    - Elements Between Packages 530
    - Elements By Increments 70, 454
    - Elements In Diagrams 529
    - Elements, Quick Start 34
    - Internal Responsibility To External Requirement 926
    - Maintenance Item Between Categories 1561
    - Nudge Elements 70
    - Objects Between Packages 530
    - Operations Between Elements 545
    - Package Contents Up Or Down 1210
    - Packages, Quick Start 34
    - Submenu 70
    - Test Between Categories 1544
  - MS Jet
    - Database As Model Repository 122
  - MS Word
    - Update RTF Report Links 1646
    - Use In RTF Documentation 1638
  - MS Word Tables
    - Apply Styles 1644
    - Manipulate 1644
    - Resize 1644
  - MSDE
    - Server Data Repository, Connect To 165
    - Server Repository, Create New 134
    - Upsize To 173
  - MTS File
    - Advanced Options 1133
    - Create 1133
    - Incorporate Model Search 1133
    - Incorporate Model View 1133
    - Working With 1133
  - Multi-page Diagram
    - Print 456
  - Multiple Login
    - Under One User ID 197
  - Multiple Select
    - Items From Project Browser 431
  - Multiple Stereotype
    - Restrict Application Of 1110
  - Multiplicity 376
    - Connector, Source Role 629
    - Connector, Target Role 631
    - Of Connector 665
    - Of Element 665
    - Of Element, Displayable 483, 549
    - Of Element, Non-Displayable 484
  - MVC Pattern 838
  - MyISAM
    - BaseModel Script 178
  - MySQL
    - Create Repository 123
    - Data Repository, Connect To 148
    - ODBC Driver, Set Up 135
    - Table Type, Set 1016
    - Upsize To 178
- N -**
- Name Template
    - Foreign Key 1028
    - Primary Key 1022
  - Namespace
    - Clear 1313
    - Dialog 1313
    - Explanation 1313
    - List 1313
    - Locate In Project Browser 1313
    - Root 1313
    - Root Package Icon 1213
    - Set 1313
    - WSDL Element 1051
  - Naming Format
    - Camel Case 1422

- Naming Format
    - Pascal Case 1422
    - Spaced 1422
    - Underscored 1422
  - N-Ary
    - Association Element 844
    - Element (Entity Relationship Diagram) 1077
  - Navigate
    - Diagram 1275
  - Navigation And Selection
    - Hotkeys, For Diagram 435
  - Navigation Compass 76
  - Neaten Diagram Layout 467
  - Nested Version Control Packages 231, 236
  - Nesting
    - Connector 885
    - Relationship 885
  - New Action Dialog 745
  - New Code Sections
    - Add To Existing Features 1308
  - New Project
    - Menu Option (File Menu) 56
  - New Search Query 1239
  - New Structured Activity Dialog 796
  - Node
    - Element 822
  - Non-Selectable
    - Element 555
  - Normal.rtf Template File 1576
  - Notation
    - Co-Region 868
    - Process Modeling 931
  - Note
    - Add To Link/Connector 612
    - Create Project Glossary Item 641
    - Element 785
    - Element, Create 536
    - For Attribute 641
    - For Connector 641
    - For Diagram 641
    - For Element 641
    - For Operation 641
    - Formatting 642
    - Hyperlink Glossary Term 641
    - Insert Glossary Item 641
    - Insert New From Toolbar 83
    - Keyboard Shortcuts 642
    - Link To Element Feature 537
    - Link To Internal Documentation 537
    - Spell Check 641
    - Tab 641
    - Toolbar Options 642
  - Window 641
  - Notelink
    - Connector 886
    - Insert New From Toolbar 83
    - Relationship 886
  - Nudge
    - Elements 70, 454
  - Numbered Sections
    - In RTF Reports 1601
  - Numbering Levels
    - Apply 1601
    - In Virtual Documents 1623
    - RTF Reports 1601
    - Use 1601
  - Numbering List
    - RTF Reports 1601
  - Numeric Range Generator
    - Timeline Element States 697
  - NUnit Transformation
    - MDA-Style Transform 1407
- O -**
- Object
    - Appearance, Options 362
    - Attributes 1415
    - Classes 1415
    - Classifiers 519
    - Columns 1415
    - Connect 610
    - Connector 489
    - Create From Attribute 568
    - Definition 1415
    - Element 823
    - Elements And Connectors 408
    - Group, Toolbox 408
    - Instance 823
    - Links 489
    - Move Between Packages 530
    - Multiplicity 629
    - Operations 1415
    - Packages 1415
    - Parameters 1415
    - Properties 481, 1415
    - Relationships 489
    - Scenario 490
    - State, Set 824
    - Tables 1415
    - Transformation 1415
    - Type 1415
    - Type, Change For Element 532

- Object Constraint Language
  - Model Validation 1528
  - Model Validation Rules For Conformance 1532
- Object Diagram
  - Description 723
  - Elements And Connectors 723
  - Example 723
- Object Flow
  - Connector 886
  - In Activity Diagram 886
  - In State Machine Diagram 886
  - Multiple 886
  - Relationship 886
  - Selection Behavior 886
  - Simple 886
  - Transformation Behavior 886
  - With Action Pins 886
- Object Oriented Programming
  - C Code Generation For UML Model 1286
  - Limitations 1286
- Object Workbench
  - Constraints 1521
  - Introduction, Visual Execution Analyzer 1519
  - Invoke Method 1522
  - Modes 1520
  - Overview, Visual Execution Analyzer 1520
  - Platforms Upported 1520
  - Requirements 1521
  - Workbench Variables, Constructors 1521
  - Workbench Variables, Create 1521
  - Workbench Variables, Delete 1521
- ObjectType Enum
  - Automation Interface 1677
- Occurrence
  - Connector 888
  - Element 780
  - Relationship 888
- OCL
  - Model Validation 1528
- OCL Constraints
  - Attribute 1532
  - Element 1532
  - Feature 1532
  - Model Validation Rules for Conformance 1532
  - Relationship 1532
- ODBC
  - Data Modeling 1367
  - Driver, Set Up 135
- ODBC Data Source
  - Select 1365
- ODBC Source
  - Select Stored Procedures From 1366
- Select Tables From 1366
- Offline
  - Checkout 268
  - Version Control 268
- OLE DB Provider
  - Microsoft For Oracle 153
  - Oracle Provider 153
- Online Resources
  - Access From Tasks Pane 51
  - Submenu 74
- Open
  - External Tools 96
  - Package From Project Browser 387
  - Package Within Diagram 438
  - Report in Microsoft Word 1638
- Open Office
  - Optimize For, In RTF Report Generation 1573
- Open Project
  - Menu Option (File Menu) 56
- Open Repository
  - Automation Interface Code Example 1765
- Open Source Directory
  - Element Code 69
- Open Source File
  - Menu Option (File Menu) 56
- Operation
  - Add To Element, In-place Editor 592
  - Appearance 569
  - As Action 743
  - Associate With Behavior 573
  - Behavior Description, Show In Diagram 573
  - Behavior, Initial Code 576
  - Business Rule 943
  - Connect To 611
  - Constraints 577
  - Context Menu, Project Browser 1221
  - Copy Between Elements 544
  - Definition 569
  - Dialog, Behavior Tab 573
  - Dialog, General Tab 570
  - Dialog, Post Tab 577
  - Dialog, Pre Tab 577
  - Disconnect From 611
  - Display Inherited Operation 579
  - Edit Name, In-Place Editor 588
  - Edit Parameter Kind 592
  - Edit Scope 589
  - Edit Stereotype, In-place Editor 588
  - Element Feature 569
  - Fast Create 570
  - Implement Interface Operations 578
  - Implement Parent Operations 578



- Operation
  - In Project Browser 569
  - Inherited, Show 438
  - Introduction 569
  - Move Between Elements 545
  - Of State Element, Behavior 573
  - Override Interface Operations 578
  - Override Parent Operations 578
  - Parameter Keyword, Edit 591
  - Parameter, By Reference 586
  - Parameter, Insert In Element 593
  - Parameters, Define 583
  - Private, Icon 1213
  - Properties, Behavior 573
  - Properties, General 570
  - Properties, Initial Code 576
  - Properties, Postconditions 577
  - Properties, Preconditions 577
  - Protected, Icon 1213
  - RuleTask, Behavior Call Action 943
  - Show On Diagram 438
  - Tagged Values, Add 577
  - WSDL Port Type Operation 1059
- Operational Domain Model
  - SysML, Create 1007
- Options
  - Audit 273
  - Compare Utility 284
  - Element Visibility 363
  - Read-Only, For Enterprise Architect 15
  - Reset For A Class 1361
  - Visual Styles/Themes 101
- Options Dialog
  - ActionScript 1348
  - Ada 2005 1348
  - Appearance Options 356
  - Attribute/Operation Specifications 1341
  - C 1349
  - C# 1350
  - C++ 1351
  - Communication Message Coloring 366
  - Connector Settings 364
  - Delphi 1352
  - Diagram Behavior 359
  - Diagram Settings 355
  - General Settings 351
  - Introduction 350
  - Java 1355
  - Links Settings 364
  - MDG Technology 1360
  - Object Appearance 362
  - Object Appearance, Default Fonts 357
  - Object Appearance, Element Visibility 363
  - PHP 1356
  - Python 1356
  - Sequence Diagram Options 360
  - Standard Colors 353
  - SystemC 1357
  - VB.NET 1358
  - Verilog 1358
  - VHDL 1359
  - Visual Basic 1360
  - XML Specifications 367
- Oracle
  - Package, Create 1022
  - Sequence 1019
  - Sequence Options, DDL For Packages 1369
  - Sequence Options, DDL For Table 1367
  - Tables, Set Properties 1017
  - Tables, Tagged Values 1017
  - Temporary Table 1017
  - Upsize To 175
- Oracle 10g
  - Data Repository, Connect To 153
  - Server Repository, Create 129
- Oracle 11g
  - Data Repository, Connect To 153
  - Server Repository, Create 129
- Oracle 9i
  - Data Repository, Connect To 153
  - Server Repository, Create 129
- Order
  - Package Contents 1210
- Other Element Tools
  - Submenu 59
- Other Project Tools
  - Submenu 59
- Outline
  - Red 206
- Output
  - Business Modeling 932
  - Debugger, View 1478
  - Debugger, Window 1478
- Output Window
  - Audit History Tab 278
  - Context Menu 102
- Override
  - Attribute Initializer 567
  - Default Toolbox In Toolbox Profile 1136
  - Implement Parent Operations 578
  - Parent Operations 578
- Overview
  - Visual Execution Analyzer 1488

## - P -

### Package

Add And Manage, Automation Interface Code Example 1766

Add Element Directly 524

Add To Diagram From Toolbox 387

Add To Project Browser 387

Add To UML Model, Quick Start 30

Apply Version Control To Model Branch 264

As RTF Bookmark 1639

Automation Interface 1672

Automation Interface Repository 1698

Baselines 279

Batch Export To XMI 298

Batch Import From XMI 298

Body, For Oracle 1022

Check In 261

Check Out 261

Comparison, Example 284

Configuration 295

Configure For Version Control 259

Context Menu, Project Browser 1214

Control, Menu 294

Control, Remove 296

Controlled 259

Copy 388

Copy Between Projects 309

Create Diagram 422

Create Oracle Packages 1022

CSV Import/Export Specification 300

Delete In Project Browser 390

Duplicate 388

Element 825

Existing, Drag Onto Diagram 389

Export 293

Export To XMI Stubs 295

Export Version Controlled Model Branch 264

Hide Contents On Diagram 389

Icon Overlays 1213

Import 293

Import Version Controlled Model Branch 265

Load 297

Lock 205

Lock, Require User Lock 205

Lock, User/Group Lock 204

META-INF 1397

Modeling With 387

Move 34

Move Element Between 530

Move Objects Between 530

Nested in Version Control 236

Open From Diagram 438

Open From Project Browser 387

Paste Copy 388

Phase, Update 340

Pin/Unpin, Visual Execution Analyzer 1428

Profile 1095

Rename 388

Resynchronize Package Version Control Status 267

Review Version Control History 266

Save 297

Save Profile 1107

Show Contents On Diagram 389

Specification, For Oracle 1022

Status, Update 340

Synchronize Contents 1313

Tasks 387

Update Contents 1313

Validate Version Control Configuration 260

Version Control 228

Version, Update 340

Working With 387

XML 293

Package Build Scripts

  Manage, Visual Execution Analyzer 1426

Package Context Menu

  Add Submenu, Project Browser 1216

  Build And Run Submenu, Project Browser 1217

  Code Engineering Submenu, Project Browser 1217

  Contents Submenu, Project Browser 1218

  Documentation Submenu, Project Browser 1216

  Import/Export Submenu, Project Browser 1218

Package Control

  Options, Dialog 295

Package Diagram

  Description 720

  Elements And Connectors 720

  Example 720

Package Import

  Connector 888

  Relationship 888

Package Merge

  Connector 888

  Relationship 888

Package Scenarios

  Import As Test Scenarios 1544

Package Structure

  BPEL 959

Packaging Component

- Packaging Component
  - Element 845
- Page
  - Footer, Print On Diagram 425
  - Header, Print On Diagram 425
  - Setup, Menu Option (File Menu) 56
  - Size, Set For Diagram 455
- Pan
  - Diagram View 453
- Pan And Zoom
  - Diagram 1275
  - Window 1275
- Paragraph Numbering
  - In RTF Style Template Editor 1593
- Parameter
  - Activity 583
  - Automation Interface, ElementFeatures Package 1735
  - Behavior 583
  - Behavior Call Arguments 582
  - Behavior, Tagged Values 585
  - Behavioral, Edit 583
  - Behavioral, Extend 583
  - Behavioral, Reassign 583
  - Behavioral, Set 583
  - Behavioral, Synchronize Call Argument With 582
  - Behavioral, Synchronize Invocation Argument With 582
  - Dialog 583
  - For Rule Flow Activity 942
  - Interaction 583
  - Kind Inout, By Reference 586
  - Operation 583
  - Operation, By Reference 586
  - Reference 586
  - Show Details On Diagram 429
  - Variables In Business Rules 942
- Parameter Information
  - Display In Source Code 1442
- Parameter Kind
  - Edit for Element Operation 592
- Parameterized Classes (Templates) 813
- Parametric
  - Diagram 1002
  - Diagram, Simulate SysML Model 1005
  - Model, SysML, Create 1002
- Parent
  - Confirm Element As Parent 529
  - Set For Element 526
- Parse
  - Source Code Files In Viewer 1441
- Part
  - Add Property Value 826
  - Element 825
  - Property Tab 829
  - Qualifiers 832
  - Represent On Sequence Diagram 714
- Partial Class
  - Generate 1311
- Partition
  - Activity 786
  - Docking 786
  - Element 786
  - Horizontal 786
  - Vertical 786
- Partitions Collection
  - Automation Interface, ElementFeatures Package 1736
- Pascal Case
  - Naming Format 1422
- Password
  - Administrator Change 202
  - Administrator Set 202
  - Security, Change 191
  - User Change 202
- Password Encryption
  - Prior To Release 7.1 Of Enterprise Architect 200
- Password Encryption (Repository)
  - At Release 7.1 Of Enterprise Architect 115, 119
- Paste
  - Activity As Action 432
  - Activity As Link 432
  - Composite Element 431
  - Connectors Between Pasted Activities 432
  - Connectors Between Pasted Instances 430
  - Copy Of Element 531
  - Copy Of Package 388
  - Diagram Into Package 436
  - Element From Project Browser 430
  - Element On Diagram 433
  - Multiple Items As Children 431
  - Multiple Items As Instances 431
  - Multiple Items As Links 431
  - Multiple Items From Project Browser 431
  - Object As Child 430
  - Object As Link 430
  - Object As New Instance 430
- Paste Element Dialog 430
- Paste Elements
  - As Link 58
  - As New 58

- Paste Elements
  - From Clipboard As Metafile 58
  - Menu Option (Edit Menu) 57
  - Submenu (Edit Menu) 58
- Patches
  - SQL, Run 346
- Pattern
  - Action, Modify 904
  - Actions 902
  - Add To MDG Technology 1123
  - Create From Diagram 902
  - Default, Change 904
  - Design 901
  - Gang of Four 901
  - GoF 901
  - GoF, Download 904
  - Import Into Model 904
  - In Resources View 902
  - Model-View-Controller 838
  - MVC 838
  - Save 902
  - Save From Diagram 902
- Pause Recording
  - Execution Analysis, Recording Sequence Diagrams 1505
- PDATA
  - Diagram Profile Attribute Values 1140
  - Element Attribute In MiscData, Object Model 1711
- People
  - As Project Resources 650
  - Assign To Changes 1566
  - Assign To Defects 1566
  - Dialog 645
  - Settings 645
- Per Page Diagram Layout 464
- Performance
  - Of Enterprise Architect 148, 150, 153, 160, 162, 165, 180, 270
- Permission List
  - User Security 198
- PHP
  - Code Generation 1356
  - Import, Reverse Engineering 1331
  - Language Options 1356
  - Modeling Conventions 1294
- Physical Model 378
- PI Macro
  - Code Template Syntax 1190
- PIM
  - Internal Bindings 1385
- Pin
  - Action 749
  - Add To Action 749
  - As Action Property 751
  - As Argument For Call Action 749
  - Assign To Action 749, 751
  - Connector End Point 84
  - Connector Start Point 84
  - Properties 749
  - Toolbox Pages 401
- Pkg Import
  - Connection 888
  - Relationship 888
- Pkg Merge
  - Connector 888
  - Relationship 888
- Place Recording Markers
  - Execution Analysis, Recording Sequence Diagrams 1499
- Platform Naming Conventions 1422
- Platform Specific Model 1385
- Platform-Independent Model 1385
- Pool (BPEL)
  - Create 979
  - Model 979
- Port
  - Add To Element 827
  - Element 826
  - For Trigger Element 804
  - Inherited 827
  - Property Tab 829
  - Qualifiers 832
  - Redefined 827
  - Represent On Sequence Diagram 714
- Port Type
  - WSDL Diagram 1056
  - WSDL Element 1056
- Port Type Operation
  - WSDL 1059
- Position Elements 70
- Post
  - Add To Team Review 213
  - Create In Team Review 213
  - Create Reply 214
  - Delete 209
  - Delete In Team Review 215
  - Edit In Team Review 215
  - Reply To In Team Review 214
- Post-Constraint
  - RTF Report Template Section 1585
- PostgreSQL
  - Data Repository, Connect To 160
  - ODBC Driver, Set Up 138

- PostgreSQL
  - Repository, Create 129
  - Upsize To 173
- Post-New Events
  - Add-In Model 1798
  - EA\_OnPostNewAttribute 1801
  - EA\_OnPostNewConnector 1799
  - EA\_OnPostNewDiagram 1800
  - EA\_OnPostNewDiagramObject 1800
  - EA\_OnPostNewElement 1798
  - EA\_OnPostNewMethod 1801
  - EA\_OnPostNewPackage 1802
- Pre/Post Conditions
  - Constraints 752
  - Local 752
  - Notes 752
  - On Actions 752
- Precede
  - Connector 406
- Pre-Constraint
  - RTF Report Template Section 1585
- Predefined Tag Type
  - Assign To Stereotype 1099
  - Define 1099
- Predefined Tagged Value Type
  - Filters 1166
  - Reference Data 1169
  - Structured 1166
  - Syntax 1166, 1169
- Pre-Deletion Events
  - Add-In Model 1790
  - EA\_OnPreDeleteAttribute 1791
  - EA\_OnPreDeleteConnector 1792
  - EA\_OnPreDeleteDiagram 1792
  - EA\_OnPreDeleteElement 1790
  - EA\_OnPreDeleteMethod 1791
  - EA\_OnPreDeletePackage 1793
- Pre-New Events
  - Add-In Model 1793
  - EA\_OnPreNewAttribute 1796
  - EA\_OnPreNewConnector 1794
  - EA\_OnPreNewDiagram 1795
  - EA\_OnPreNewDiagramObject 1795
  - EA\_OnPreNewElement 1793
  - EA\_OnPreNewMethod 1797
  - EA\_OnPreNewPackage 1797
- Preprocessor Macros 1344
- Preserve Hierarchy
  - CSV Specification 300
- Primary Key
  - Complex 1022
  - Create 1022
  - Description 1022
  - Extended Properties 1024
  - Name Template, Define 1022
  - Simple 1022
  - SQL Server, Non-Clustered 1024
- Primitive
  - Element 829
- Print
  - Diagram (Single) From Project Browser 1220
  - Diagrams (Multiple) From Project Browser 1220
  - Menu Option (File Menu) 56
  - Multi-page Diagrams 456
  - Page Footer On Diagram 425
  - Page Header On Diagram 425
  - Preview, Menu Option (File Menu) 56
  - Project Issues 332
  - Scaled Image 456
  - Setup, Menu Option (File Menu) 56
  - Task List 329
- Print Preview
  - Display 395
  - Multiple Pages 395
- Private Key
  - Add 1870
- Private Model
  - And Version Control Using TFS 253
- Problem Type
  - Define 660
- Process
  - BPEL, Properties 961
  - Element 846, 931
  - Element (Data Flow Diagram) 1076
  - Model Template 374
  - Modeling 374
- Process Memory
  - Inspect 1476
- Process Modeling Notation 931
- Professional Edition
  - Of Enterprise Architect 12
  - Upsize From 122
- Profile
  - Add Attribute To Diagram 909
  - Add Connector To Diagram 909
  - Add Element To Diagram 909
  - Add Elements 1096
  - Add Enumeration Elements 1103
  - Add Metaclasses 1096
  - Add Operation To Diagram 909
  - Add Shape Script 1104
  - Add Stereotypes 1096
  - Add To MDG Technology 1122

## Profile

- And Element Templates 542, 906, 1093
- Constraints 1101
- Create 1095
- Diagram, Create 1139
- Elements And Connectors 414
- Export To Disk 1106
- Group, Toolbox 414
- Import 908
- Import From XML 906, 1093
- Package 1095
- References 912
- Save 1106
- Save From Diagram 1107
- Save From Package 1107
- Set Default Appearance Of Stereotype Objects 1106
- Stereotype 1095, 1113
- Stereotypes 906, 1093
- Swimlanes Matrix 444
- Tagged Values 910
- Tags 1098
- Tasks Pane, Create 1141
- Toolbox 1134
- UML, Constraints Supported 912
- UML, Example File 915
- UML, Metafiles Supported 912
- UML, Structure 913
- UML, Supported Attributes 914
- UML, Tags Supported 912
- Use 907
- Work With 1095
- Zachman 444

## Profile Connector

- Add To Diagram 909

## Profile Element

- Add To Diagram 909

## Profiler

- Attach To Process 1517
- Getting Started 1516
- Launch 1517
- Operation 1517
- Overview 1514
- Prerequisites 1516
- Report, Example 1514
- Report, Load 1518
- Report, Save 1518
- Report, Save As Resource In Team Review 1519
- Set Options 1518
- Set Sample Intervals 1518
- Start 1517

## Stop 1517

- Supported Platforms 1516
- System Requirements 1516
- Team Review, Save Report As Resource 1519
- Toolbar 1516

## Progress OpenEdge

- Data Repository, Connect To 165
- ODBC Driver, Set Up 145
- Server Repository, Create 134
- Upsize To 171

## Project

- Administration, Security Permissions 189
- Author 645
- Browser 1209
- Change Control 1557
- Clean 344
- Clients 651
- Compact .EAP File 348
- Compare With Other Project 308
- Comparison, Why? 308
- Configure 120
- Constants 1614
- Create In Enterprise Architect, Tutorial 28
- Data Integrity 344
- Data, Transfer 307
- Develop In Team Environment, Introduction 182
- Development, Introduction 111
- EABase 27
- Estimation 335
- Explorer 1209
- File, EABase 120
- Glossary 323
- Integrity Check 344
- Integrity, Run SQL Patches 346
- Issues 323, 331
- Items, Add Via Toolbar 81
- Maintenance 1557
- Menu 60
- Metrics 335
- Model Template 381
- Open Existing 112
- Recover 344
- Remove Recent 56
- Rename .EAP File 348
- Repair Project .EAP File 348
- Resources 650
- Roles 648
- Share, DBMS Repository 183
- Share, Network Drive 183
- Share, Replication 183
- Sharing, Introduction 182

- Project
  - Spell Checking 1552
  - Statistics, View 60
  - Structure 370
  - Tasks 37, 323
  - Timescale Estimation 335
  - Toolbar 81
  - Transfer 178
  - Upgrade 346
  - Use The Model Search 1233
  - View 1209
  - What Is A? 113
- Project Branch
  - Check In 261
  - Check Out 261
- Project Browser
  - Attribute Context Menu 1221
  - Collapse Contents 1218
  - Context Menus 1213
  - Default Behaviour 1210
  - Diagram Context Menu 1220
  - Element Context Menu 1218
  - Element Context Menu, Add Submenu 1219
  - Exclamation Marks 206
  - Expand Contents 1218
  - Free Sorting 1210
  - Hide And Show 1209
  - Icon Overlays 1213
  - Icon, User-Defined 1108
  - Introduction 1209
  - Method Context Menu 1221
  - Model Context Menu 1213
  - Move Items Within 1209
  - Open Package 387
  - Operation Context Menu 1221
  - Order Package Contents 1209
  - Package Context Menu 1214
  - Package Context Menu, Add Submenu 1216
  - Package Context, Build And Run Submenu 1217
  - Package Context, Code Engineeing Submenu 1217
  - Package Context, Contents Submenu 1218
  - Package Context, Documentation Submenu 1216
  - Package Context, Import/Export Submenu 1218
  - Reload Current Package 1218
  - Reset Sort Order 1218
  - Scripts 1663
  - Selective Collapse of Packages 1209
  - Show Level Numbering 1214
  - Show Stereotypes 1210
  - Toolbar 1212
  - Version Control Indicators 233
  - Views 1209
- Project Constant
  - RTF Reports 1614
- Project Custom Colors
  - Get For Element 540
  - Set For Element 540
- Project Discussion Forum
  - Now Team Review 208
- Project Factor Calibration 335
- Project File
  - Create 112
  - Example 114
  - Open 114
- Project Glossary
  - Add Item, Glossary Detail Dialog 325
  - Add Item, Glossary Dialog 324
  - Create Item From Notes Text 641
  - Delete Item, Glossary Dialog 324
  - Delete Item, Project Glossary Tab 325
  - Filter List, Glossary Dialog 324
  - Filter List, Project Glossary Tab 325
  - Glossary Dialog 324
  - Glossary Report 328
  - Hyperlink Term From Notes 641
  - Insert Item In Text 641
  - Modify Item, Glossary Detail Dialog 325
  - Modify Item, Glossary Dialog 324
  - Redefine Entry Type, Project Glossary Tab 325
  - Tab 325
- Project Indicators
  - Risk Types 322
- Project Interface
  - Automation Interface 1753
  - Project 1753
- Project Issue
  - Add 334
  - Delete 334
  - Dialog 331
  - Modify 334
  - Print List 332
  - Record 331
  - Report, Via Project Issues Dialog 334
  - Report, Via Project Issues Tab 334
  - Tab 332
- Project Management
  - Asterisk On Window Tabs 313
  - Default Hours 340
  - Effort Management 315
  - Effort Types 319

- Project Management
  - Environment Complexity Factors 337
  - Introduction 312
  - Maintenance 1558
  - Metric Types 320
  - Metrics 312, 317
  - Resource Allocation 314
  - Resource Report 318
  - Resources 312
  - Risk Management 316
  - Risk Types 322
  - Risks 312
  - Technical Complexity Factors 336
  - Toolbar 312
  - Window 312, 313
  - With Enterprise Architect 312
- Project Manager
  - And Enterprise Architect 43
  - Project Estimation 43
  - Project Role 43
  - Resource Management 43
  - Risk Management 43
- Project Role
  - And Enterprise Architect 37
  - Business Analyst 38
  - Database Administrator 47
  - Deployment and Rollout 45
  - Developer 42
  - Implementation Manager 45
  - Project Manager 43
  - Software Architect 40
  - Software Engineer 41
  - Technology Developer 46
  - Tester 43
- Project Settings
  - Configure (Settings Menu) 73
- Project Task
  - Add 330
  - Delete 330
  - List 329
  - Modify 330
  - Tab, Print List 329
- Project Team Review
  - Access 208
  - Add External File Link To Post 216
  - Add New Category 211
  - Add New Post 213
  - Add Object Link To Post 216
  - Add Team Review Link To Post 216
  - Connections To Other Team Reviews 218
  - Copy Path To Clipboard 218
  - Create Category 211
  - Create Post 213
  - Create Reply 214
  - Delete Item 215
  - Edit Item 215
  - Editor 215
  - Icons 208
  - Introduction 208
  - Load Data When Required 218
  - Loading Behavior 218
  - Mark All Posts Unread 218
  - Options 218
  - Preload 218
  - Reply To Post 214
  - Search 217
  - Was Discussion Forum 208
- Project Version Control Menu 256
- ProjectIssues
  - Automation Interface Repository 1703
- ProjectResource
  - Automation Interface Repository 1704
- Properties
  - Automation Interface, ElementFeatures Package 1736
  - Behavior Tab 581
  - Call Tab 581
  - Connector, Menu Section 607
  - Constraints, Scenario 507
  - Dialog, Element 481
  - Editor Language 1338
  - Effect Tab 743
  - Element 481
  - Element Context Menu 548
  - Element, Associated Files 507
  - Element, Connectors 489
  - Element, Constraints 488
  - Element, Details 484
  - Element, External Requirements 487
  - Element, General 482
  - Element, Generalizable 483
  - Element, Internal Requirements 485
  - Element, Links 489
  - Element, Relationships 489
  - Element, Requirements 485
  - Element, Tagged Values Tab 508
  - Element, Trigger Tab 804
  - Extend For Requirements 920
  - Object 481
  - Of Classifiers, Composite Structure Diagram 726
  - Of Requirements, Extended 920
  - Of Requirements, Standard 919
  - Requirement, Display On Diagram 920, 921



- Properties
    - Window (Element) 508
  - Properties Note
    - Diagram 440
  - Properties,
    - Part, Property Tab 829
    - Port, Property Tab 829
  - Properties, EASL
    - Action 1196
    - Argument 1196
    - Behavior 1196
    - Call Event 1196
    - ChangeEvent 1196
    - Classifier 1196
    - Condition 1196
    - Construct 1196
    - Edge 1196
    - EventObject 1196
    - Instance 1196
    - Parameter 1196
    - Primitive 1196
    - PropertyObject 1196
    - SignalEvent 1196
    - State 1196
    - StateMachine 1196
    - TimeEvent 1196
    - Transition 1196
    - Trigger 1196
    - Vertex 1196
  - Property
    - Automation Interface, ElementFeatures Package 1736
    - Redefined 517
    - Select, Dialog 517
    - Subsetted 517
  - Property Validation
    - Attribute 1532
    - Element 1532
    - Feature 1532
    - Relationship 1532
  - Property Value
    - Part, Add To 826
  - PropertyType
    - Automation Interface Repository 1704
  - PropType Enum
    - Automation Interface 1678
  - Proxy
    - (Shortcut) File 115
  - Pseudo-State
    - Elements 682
    - Fork 773, 775
    - In State Machine Diagram 682
  - Join 773, 776
  - PSM 1385
  - Python
    - Code Generation 1356
    - Import, Reverse Engineering 1331
    - Language Options 1356
    - MDG Technology For, Enterprise Architect 1073
    - Modeling Conventions 1295
- Q -**
- Qualified Association 830
  - Qualifier
    - Association End 832
    - Association Property 830
    - Attribute 832
    - Attribute Property 830
    - Dialog 832
    - Part 832
    - Part Property 830
    - Port 832
    - Port Property 830
    - Set Properties 832
  - Quality Control 1527
    - Model Validation 1528
    - Spell Checking 1552
    - Testing 1536
  - Query Builder
    - Search Definition 1239
  - Query Methods
    - In Shape Scripts 1158
  - Quick Add
    - Tagged Values 634
  - Quick Linker 610
    - Arrow 474
    - Connector Names, In Definitions 1117
    - Create Connector 476
    - Create Element And Connector 475
    - Default Settings, Hide 1117
    - Definition Format 1113
    - Element Names, In Definitions 1117
    - Example 1115
    - Introduction 474, 1113
    - Options 475
  - Quick Start
    - Add Connectors To UML Model 32
    - Add Diagram To Package 30
    - Add Diagram To UML Model 30
    - Add Element To Diagram 31
    - Add Element To UML Model 31
    - Add Package to UML Model 30

- Quick Start
  - Auditing 271
  - Create A Project In Enterprise Architect 28
  - Define Connector Properties 33
  - Define Element Properties 33
  - Delete UML Model Components 35
  - Generate HTML Report 1647
  - Generate RTF Report 1570
  - Move Project Components 34
  - Project Tasks 37
  - Save Project Changes 36
  - View HTML Report 1647
  
- R -
  
- Rational Rose
  - And XMI 288
  - Export To 293
- Rational Software Architect
  - Models 291
- Rational Software Modeler
  - Import \*.emx Files 290
  - Import \*.uml2 Files 290
- Read-Only Options
  - For Enterprise Architect 15
- Realization
  - Connector, Quick Generation Of 921
- Realization Link
  - Implement Parent Operations 578
  - Override Parent Operations 578
- Realize
  - An Information Flow 866
  - Connector 889
  - Relationship 889
- Realized Interfaces
  - For Class, Show On Diagram 452
- Receive
  - Element 787
  - Event 839
- Recent Discussions
  - Concerning Model View Items 1222
- Recent Post Options Dialog 1224
- Recent Postings
  - Display 1226
- Reception
  - Definition 834
  - Of Signal 834
- Record & Analyze Window 1506
- Record Activity For Class
  - Execution Analysis, Record Sequence Diagram 1497
- Record Activity For Method
  - Execution Analysis, Record Sequence Diagram 1498
- Record Arguments To Function Calls
  - Build Script, Sequence Diagram Recording Tab 1494
- Record Calls To Dynamic Modules
  - Build Script, Sequence Diagram Recording Tab 1495
- Record Calls To External Modules
  - Build Script, Sequence Diagram Recording Tab 1494
- Record Macro
  - In Source Code Editor 1442
- Record Sequence Diagrams
  - Automatic Recording 1504
  - Control Recording 1504
  - Execution Analysis, Advanced Techniques 1497
  - manual Recording 1504
  - Pause Recording 1505
  - Resume Recording 1505
  - Stop Recording 1505
- Record State Changes
  - Visual Execution Analyzer 1511
- Recording Actions
  - Create Sequence Diagram, Call Stack 1480
  - Debugger, Overview 1480
  - Debugger, Step Through Function Calls 1480
  - Save Call Stack 1482
- Recording History
  - Save, Execution Analysis 1507
- Recording Markers
  - Activate, Execution Analysis 1503
  - Breakpoints And Markers Window, Execution Analysis 1503
  - Difference From Breakpoint 1503
  - Disable, Execution Analysis 1503
  - Marker Types, Execution Analysis 1499
  - Place, Execution Analysis 1499
  - Set, Execution Analysis 1502
  - Work With Marker Sets, Execution Analysis 1503
- Recover
  - Controlled Package 299
  - Project 344
- Rectangle Notation
  - Element Menu Option 549
  - For Use Cases 808
- Recursion
  - Connector 890
  - Message 890
  - Relationship 890
- Recursive Builds

- Recursive Builds
  - Visual Execution Analyzer 1446
- Red
  - Border 206
  - Exclamation Mark 206
  - Letter A 597, 599
  - Object Outline 206, 457, 555
  - Triangle 341
- Redefined Port
  - Manage 827
- Redefinition
  - Connector 414
- Redo
  - Last Action, Diagram Edits 458
- Re-entrancy
  - In Add-Ins 1779
- Reference
  - Automation Interface 1671
  - Automation Interface Repository 1705
- Reference Data 644
  - And Version Control 231
  - Cardinality (Multiplicity) 665
  - Clients 651
  - Constraint Status Types 656
  - Constraint Types 655
  - Estimation 659
  - Export 223
  - Export, Introduction 223
  - General Types 653
  - Import Automatically 225
  - Import Manually 225
  - Import, Introduction 223
  - Maintenance 660
  - Metrics 659
  - People 645
  - Problem Types 660
  - Project Author 645
  - Requirement Types 657
  - Resources 650
  - Roles 648
  - Scenario Types 658
  - Share 223
  - Status Types 653
  - Stereotypes 662
  - Tagged Value Types 664
  - Testing Types 661
  - UML Types 662
- Reference Data Tagged Value Type 1169
- Reference Data Tagged Values
  - Create 1170
- Referenced XML Schema
  - Import 1373
- Refresh
  - Diagram 267
  - Image 447
  - Project 267
  - View Of Shared Model 267
- Region
  - Composite State 681
  - Concurrent Substate 681
  - Element 788
  - Expansion, Element 769
  - Interruptible Activity, Element 781
  - On Composite State 790
  - State Machine 681
- Register
  - Add-Ins 1876
  - Enterprise Architect 22
- Registration Key
  - In License Information 1869
- Registry Settings 90
  - User 350
- Related Elements
  - Find 433
  - Insert With Context Menu 551
  - Place On Current Diagram 433
- Relational Database
  - Model Template 377
- Relationship
  - Activity Edge 867
  - Aggregate 854
  - Application 414
  - Archimate 1073
  - Assembly 855
  - Associate 855
  - Association 855
  - Association Class 856
  - Asynchronous Signal 877
  - BPMN 952
  - Communication 859
  - Communication Path 858
  - Compose 858
  - Composite Aggregation 858
  - Connector 859
  - Control Flow 860
  - Create Using Relationship Matrix 1266
  - Data Flow 1076
  - Delegate 861
  - Delete 489
  - Delete Using Relationship Matrix 1266
  - Dependency 861
  - Dependency, Apply Stereotype 862
  - Deployment 862
  - Display Options 364

- Relationship
  - Element (Entity Relationship Diagram) 1077
  - Entity Relationship Diagram 1077
  - Eriksson-Penker 1080
  - Extend 862
  - Extension (Profile Toolbox) 414
  - Generalization 863
  - Generalize 863
  - Generalize (Profile Toolbox) 414
  - Hide 489
  - Implements 889
  - Include 864
  - Information Flow 864
  - Inheritance 863
  - Interrupt Flow 867
  - List, On Context References Tab 506
  - Manifest 867
  - Matrix, In Traceability 1251
  - Message 867
  - Mind Mapping 1087
  - Modify Using Relationship Matrix 1266
  - Nesting 885
  - Notelink 886
  - Object Flow 886
  - Occurrence 888
  - Package Import 888
  - Package Merge 888
  - Pkg Import 888
  - Pkg Merge 888
  - Realize 889
  - Recursion 890
  - Redefinition 414
  - Representation 891
  - Represents 891
  - Role Binding 890
  - Self Message 871
  - Show 489
  - SysML Activity 996
  - SysML Block Definition 992
  - SysML Interaction 998
  - SysML Internal Block 994
  - SysML Model 991
  - SysML Parametric 995
  - SysML Requirement 1001
  - SysML State Machine 999
  - SysML Use Case 1000
  - Tagged Value (Profile Toolbox) 414
  - Trace 892
  - Transition 892
  - Usage 894
  - Use 894
  - Visibility 619
- Window, Context Menu 1269
- Relationship Matrix
  - Access 1262
  - Access From Shortcut 115, 117
  - Access From Shortcut (Direct Definition) 116
  - Create Relationship 1266
  - Delete Relationship 1266
  - Export To CSV 1267
  - Incorporate In HTML Report 1265
  - Incorporate In RTF Report 1265
  - Introduction 1261
  - Link Direction 1263
  - Link Type 1263
  - Locate Elements 1268
  - Manage Display Content 1265
  - Modify Relationship 1266
  - Open 1262
  - Options 1265
  - Print Matrix 1265
  - Print Preview 1265
  - Profile, Delete 1267
  - Profile, Save 1267
  - Profile, Update 1267
  - Review Elements 1268
  - Save As .EMF File 1265
  - Save As .PNG File 1265
  - Scale Printout Width 1265
  - Set Element Type 1262
  - Set Link Direction 1263
  - Set Link Type 1263
  - Set Source Package 1264
  - Set Target Package 1264
- Relationships Window
  - Context Menu 433
- Reload
  - Diagram 267
  - Model (Shared) 267
  - Project 267
  - View 267
- Reload Current Project
  - Menu Option (File Menu) 56
- ReloadType Enumeration
  - Automation Interface 1678
- Remove
  - Package Control 296
  - Recent Project 56
  - Replication 186
- REMOVE\_PREFIX 1422
- Rename
  - Diagram 434
  - Package 388
  - Project .EAP File 348

- Rename
  - Views 384
- Re-Order
  - Messages 880
- Repair
  - Project .EAP File 348
- Replace
  - Linked Document 602
- Replica
  - Create 185
  - Synchronize 186
  - Upgrade 186, 347
- Replication
  - And Version Control 256
  - Change Collisions 184
  - Create Design Masters 185
  - Create Replicas 185
  - Disable 184
  - Introduction 184
  - Merge Rules 184
  - Remove 186
  - Resolve Conflicts 187
  - Synchronize Replicas 186
  - Upgrade Replicas 186
  - Using 184
- Reply
  - To Post In Team Review 214
- Report
  - Dependency 1624
  - HTML 1568, 1647
  - Implementation 1626
  - Open In Microsoft Word 1638
  - Project Issues, Via Project Issues Dialog 334
  - Project Issues, Via Project Issues Tab 334
  - Rich Text Format 1568, 1569
  - RTF 1568, 1569
  - Testing Details 1549
- Report View
  - Now Element List 1255
- Reporting
  - Dependency 929
  - Implementation 929
  - Requirements 929
- Repository
  - Access Permissions For 122
  - Adaptive Server Anywhere, Create 132
  - Attributes 1680
  - Author Collection 1693
  - Automation Interface 1680
  - Client Collection 1694
  - Collection Class 1695
  - Connect To 122
  - Create 122
  - Datatype 1696
  - Encrypt Password 115, 119
  - EventProperties 1697
  - EventProperty 1697
  - Methods 1680
  - ModelWatcher 1698
  - MSDE Server, Create 134
  - Open, Automation Interface Code Example 1765
  - Package 1698
  - Package, Automation Interface 1679
  - Progress OpenEdge, Create 134
  - ProjectIssues 1703
  - ProjectResource 1704
  - PropertyType 1704
  - Reference 1705
  - Set Up Database 122
  - Stereotype 1706
  - Task 1707
  - Term 1708
  - Transfer Data Between 306
  - Use Extras, Automation Interface Code Example 1772
- Representation
  - Connector 891
  - Relationship 891
- Represents
  - Connector 891
  - Relationship 891
- Require User Lock
  - Apply User Lock 205
  - Release User Lock 205
- Require User Lock Policy 190
- Requirement
  - Aggregation 921
  - Analysis 374
  - And Level Numbering 922
  - And Use Cases 922
  - Auditing 928
  - Automation Interface, Element Package 1719
  - Autonumbering 918
  - Baselines 928
  - Change Management 928
  - Changes 928
  - Color Code Status 920
  - Connect On Diagram 921
  - Connect Through Relationship Matrix 921
  - Connectors 921
  - Convert From Responsibility 926
  - Create In Diagram 918
  - Create In Project Browser 918

- Requirement
  - Create SysML Model 1007
  - Dependency Report 929
  - Docked Windows 927
  - Element 846, 922
  - Element Template 920
  - Element, Hide/Show Connectors 621
  - Elements And Connectors 418
  - Extend Properties, Default Format 920
  - External 487, 922
  - Fast Generate Realization Connector 921
  - Functional 485
  - Gather 917
  - Group, Toolbox 418
  - Hide Stereotype Letter 846, 918
  - Hierarchies 922
  - Implementation Report 929
  - Import Via CSV 922
  - Inherited, Show 438
  - Internal 485, 925
  - Internal, Import As Test 1547
  - Internal, In Scenarios & Requirements Window 514
  - Issues 928
  - Manage 927
  - Model 917, 922
  - Model Template 374
  - Model Views 928
  - Modeling 374
  - Non-Functional 485
  - Profile 920
  - Properties, Display On Diagram 921
  - Properties, Extended 920
  - Properties, Standard 919
  - Realization 921
  - Report Template 929
  - Reporting 929
  - Requirements Management 374
  - Review 927
  - Show Stereotype Letter 846, 918
  - Stability 485
  - Status, Color Coded 920
  - Tagged Values 920
  - Tagged Values, Display 921
  - Template 374
  - Trace Through Connectors 921
  - Trace Use Of 928
  - User-Defined Attributes 920
  - View 928
  - What Is A? 917
  - Windows For Tracing Use 928
  - Windows For Viewing 928
- Requirement Type
  - Define 657
- Requirements Diagram
  - Description 736
  - Elements And Connectors 736
  - Example 736
- Requirements Management
  - And Enterprise Architect 917
  - Enterprise Architect 5
  - In Example Model 917
  - Overview 917
- Requirements Model
  - SysML, Create 1007
- Requirements Modeling
  - Enterprise Architect 5
- Reserved Names
  - In Shape Scripts, Connectors 1161
  - In Shape Scripts, Elements 1161
- Reset Options
  - For A Class 1361
  - For All Classes 1361
  - Source Code Language 1212, 1361
- Reset Sort Order
  - In Project Browser 34
- Resize
  - Element 533
  - Element By Increments 533
  - Multiple Elements 533
- Resolve Change Conflicts
  - Between Replicas 187
- Resource
  - Add To Team Review Item 209
  - Allocation 314
  - And Tasking Details Dialog 318
  - Automation Interface, Element Package 1720
  - Delete From Team Review Item 209
  - Report 318
- Resource Document
  - RTF Generator (Enhanced) 1606
  - RTF, Batch Generate Reports 1606
- Resource Management 313
  - Effort Types 319
  - Metric Types 320
  - Risk Types 322
- Resources
  - Define 650
  - Documents 667
  - Favorites Folder 667, 669
  - Matrix Profiles 667
  - MDG Technologies 667
  - Project Management Window 312
  - Scripts 667

- Resources
  - Templates 667
  - UML Patterns 667
  - UML Profiles 667
  - Window 667
  - Window, And MDG Technologies 1067
  - XSL Stylesheets 667
- Resources View
  - Of Patterns 902
- Responsibility
  - Compartment, Element 521
  - Define 925
  - Import As Test 1547
  - Internal 485
  - Move To External Requirement 926
- Result
  - End Event, BPEL 965
- Resume Recording
  - Execution Analysis, Recording Sequence Diagrams 1505
- Resynchronize
  - Package Version Control Status 267
- Reusable Subsystems
  - Systems Engineering Modeling 1011
- Reverse Connector 623
- Reverse Engineer
  - Enterprise Architect 5
  - Source Code 1328
- Reverse Engineering
  - And Auditing 279
  - And MDG Integration 1334
  - Directory Structure 1332
  - Eclipse 1334
  - Handling Classes Not Found During Import 1335
  - Import ActionScript 1331
  - Import Binary Module 1334
  - Import C 1331
  - Import C# 1331
  - Import C++ 1331
  - Import Delphi 1331
  - Import Java 1331
  - Import PHP 1331
  - Import Python 1331
  - Import Source Code 1329, 1335
  - Import Visual Basic 1331
  - Import Visual Basic.Net 1331
  - Initial Code In Operations 576
  - Introduction 1281
  - ODBC Data Sources 1363
  - Source Code, Import Directory Structure 1332
  - Synchronize Model And Code 1327
  - Visual Studio 1334
- Reverse Synchronization
  - Delete Attribute If Not In Code 1341
  - Delete Method If Not In Code 1341
  - Delete Model Aggregations For Attributes Not In Code 1341
  - Delete Model Associations For Attributes Not In Code 1341
  - Include Method Bodies In Model 1341
- Review
  - Package Version Control History 266
  - Requirements 927
- Rich Text Format
  - Copy Bookmark To Clipboard 1216
  - Document 1569
  - Report 1569
- Rich Text Format Generator
  - Enhanced 1573
- Rich Text Format Report
  - Apply Filter (Legacy) 1630
  - Diagram Format (Legacy) 1631
  - Diagram Only 1625
  - Dialog (Legacy) 1628
  - Element-Level 1570
  - Exclude Elements (Legacy) 1630
  - Exclude Objects (Legacy) 1630
  - Exclude Package 1573
  - Generate (Enhanced) 1570
  - Generate (Legacy) 1634
  - Generate From Element List 1255
  - Generate, Quick Start 1570
  - Generator (Legacy) 1628
  - Include Glossary (Legacy) 1631
  - Include Issues (Legacy) 1631
  - Include Package 1573
  - Include Tasks (Legacy) 1631
  - Object Selections (Legacy) 1633
  - Options (Legacy) 1632
  - Save As RTF Document (Enhanced) 1606
  - Save As RTF Document (Legacy) 1636
  - Set Main Properties (Legacy) 1629
  - Single Element (Legacy) 1629
  - Templates, Load (Legacy) 1634
  - Through Element List 1570
  - Through Model Search 1570
  - Wizard (Legacy) 1628
- Rich Text Notes
  - In Legacy RTF Generator Reports 1628
- Rigorous Security Mode
  - Apply User Lock 205
  - Release User Lock 205
- Risk

- Risk
  - Automation Interface, Element Package 1721
  - Management 316
- Risk Types
  - Define 322
  - Global 322
  - Non-Global 316
- Risks
  - Project Management Window 312
- Roadmap
  - ICONIX 1084
- Robustness Diagram 836
  - Generate From Scenario 499, 504
- Role
  - Context Menu 606
  - Define 648
  - Tagged Values 631
- Role Binding
  - Connector 890
  - Relationship 890
- RoleTag
  - Automation Interface, Connector Package 1744
- Rollback Change
  - Options 285
- Round-Trip Engineering
  - Introduction 1281
- RSA
  - Models 291
  - XMI 290
- RSM
  - Import \*.emx Files 290
  - Import \*.uml2 Files 290
- RTF
  - Copy Bookmark To Clipboard 1216, 1220
  - Documentation 1568, 1569
  - Documentation, Other 1624
  - List Overrides 1601
  - Numbered Sections 1601
  - Numbering Levels 1601
  - Numbering List 1601
  - Report 1568, 1569
  - Section Numbering 1601
- RTF Document Options
  - RTF Generator (Enhanced) 425
  - RTF Generator (Legacy) 425
- RTF Generator
  - Document Options (Enhanced) 425
  - Document Options (Legacy) 425
  - Document Options, From Diagram (Enhanced) 1571
  - Document Options, From Diagram (Legacy) 1571
  - Enhanced 1573
- RTF Report
  - Advanced Options 1607
  - Apply Filter (Legacy) 1630
  - Bookmarks 1639
  - Bookmarks, In Master Document Elements 1616
  - Custom Language Settings 1615
  - Custom Language Settings (Legacy) 1637
  - Diagram Format (Legacy) 1631
  - Diagram Only 1625
  - Dialog (Legacy) 1628
  - Document Options (Enhanced Generator) 1607
  - Element Filters 1611
  - Element-Level 1570
  - Exclude Elements (Legacy) 1630
  - Exclude Objects (Legacy) 1630
  - Exclude Package 1573
  - Footers, Add 1643
  - Generate (Enhanced) 1570
  - Generate (Legacy) 1628, 1634
  - Generate From Element List 1255
  - Generate, Quick Start 1570
  - Headers, Add 1643
  - In MS Open Office 1607
  - In Sun Open Office 1573
  - Include Glossary (Legacy) 1631
  - Include Issues (Legacy) 1631
  - Include Package 1573
  - Include Tasks (Legacy) 1631
  - Keywords (Legacy) 1637
  - Object Selections (Legacy) 1633
  - Open Office Display 1607
  - Options (Legacy) 1632
  - Other Filters 1612
  - Project Constants, User Defined 1614
  - Quick Start 1570
  - Save As RTF Document (Enhanced) 1606
  - Save As RTF Document (Legacy) 1636
  - Set Main Properties (Legacy) 1629
  - Single Element (Legacy) 1629
  - Switch Generator 1607
  - Templates, Load (Legacy) 1634
  - Through Element List 1570
  - Through Model Search 1570
  - Update Links In MS Word 1646
  - Wizard (Legacy) 1628
  - Word Substitution 1615
- RTF Report Template



- RTF Report Template
  - Add To MDG Technology 1132
- RTF Style Editor (Legacy) 1634
- RTF Style Template
  - Create 1576
  - Delete 1576
  - Edit 1576
  - Export To Reference File 1576
  - Import From Reference File 1576
  - Normal.rtf 1576
- RTF Style Template Editor
  - Add Content 1586
  - Bookmarks 1597
  - Character Formatting 1592
  - Character Styles 1592
  - Child Sections 1584
  - Columns 1599
  - Commands 1587
  - Constraint Sections 1585
  - Continuous Table 1581
  - Copy Text 1589
  - Cut And Paste 1589
  - Delete Text 1589
  - Description (Enhanced) 1578
  - Drawing Objects 1604
  - Edit Picture 1591
  - Export As RTF Document 1588
  - File Options 1588
  - Fonts 1592
  - Footers 1596
  - Frames 1604
  - Headers 1596
  - Highlight Text 1589
  - Hyperlinks 1597
  - IME Option 1600
  - Import RTF Document 1588
  - Insert RTF File 1591
  - Level Numbering 1600
  - Lists And Overrides 1600
  - Move Text 1589
  - Numbered Lists 1593
  - Page Breaks 1595
  - Page Columns 1599
  - Page Mode 1590
  - Paragraph Formatting 1593
  - Paragraph Numbering 1593
  - Paragraph Styles 1593
  - Paste External Objects 1589
  - Picture Embed 1591
  - Picture Frame 1604
  - Picture Link 1591
  - Print Options 1588
- Redo Edit 1587
- Repagination 1595
- Revert To Previous Copy 1588
- Save File 1588
- Scenario Sections 1585
- Search and Replace Options 1605
- Sections 1599
- Select Model Elements 1579
- Select Text 1589
- Show Headers & Footers 1590
- Special Text 1600
- Split Rows 1581
- Style Sheets 1600
- Tab Support (Enhanced) 1595
- Table Commands 1597
- Table of Contents 1600
- Tabular Sections 1581
- Text Frame 1604
- Text Scrolling 1588
- Undo Edit 1587
- Update Styles 1588
- ValueOf Field 1586
- View Options 1590
- Zoom 1590
- RTF Template
  - Import 1606
- RTF Templates Tab (Enhanced) 1576
- Rule Composer
  - Business Rule Modeling 945
  - Computation Rule Table 945
  - Decision Table 945
  - Rule Table 945
- Rule Flow
  - Activity 939
  - Activity Parameter 942
  - Behavior 939
  - Diagram 939
  - Generate Code From Behavior 951
  - Model 939
- Rule Model
  - Diagram 937
- Rule Task
  - Element 939
- RuleFlow Diagram
  - Generate From Scenario 499, 501
- Run
  - SQL Patches 346
- Run Command
  - Create 1482
  - Introduction 1482
- Run Script
  - Create 1482

- Run Script
    - Introduction 1482
  - Run State 823
    - Add Instance Variable 824
    - Define, Element Context Menu 549
  - Run-Time
    - Variable, Define 824
  - Runtime Object
    - In Script Editor 1439
  - Run-Time State
    - Add Instance Variable 824
    - Delete Instance Variable 824
    - Introduction 823
- S -**
- Save
    - Changes 36
    - Controlled Package 297
    - Diagram As UML Pattern 902
    - Diagram Changes Automatically 359
    - Diagram Image To Disk File 435
    - Diagram, Context Menu Option 394
    - Diagram, Quick Start 36
    - Package with XMI 297
    - Profile From Diagram Context 1107
    - Profile From Package Context 1107
    - RTF Report As RTF Document (Enhanced) 1606
    - RTF Report As RTF Document (Legacy) 1636
    - Tasks Pane Profile 1145
    - UML Pattern 902
  - Save As
    - Copy 115
    - Shortcut 115
  - Save Project As
    - Menu Option (File Menu) 56
  - Save Project As (File Menu Option)
    - Copy 116, 117
    - Shortcut (Capture Current Environment) 117
    - Shortcut (Direct Definition) 116
  - Scale
    - Image To Page Size 456
  - Scale Diagram View 356
  - SCC
    - Providers Dialog 236
    - Version Control Options 236
    - Version Control, Upgrade For Enterprise Architect 4.5 239
  - Scenario
    - Alternate Path 490
    - Alternate Path, Add 495, 496
    - Alternate Path, RTF Reporting 1585
    - Automation Interface, Element Package 1722
    - Basic Path 490
    - Context Menu, Item 496
    - Create 494, 495, 496
    - Create Element 497
    - Delete Path 498
    - Delete Step 495, 496
    - Delete Text 497
    - Description Tab 490
    - Edit Text 497
    - Element 490
    - Entry Points Tab, Context Menu 498
    - Exception Path 490
    - Exception Path, Add 495, 496
    - External Test Cases 505
    - Floating Toolbar 499
    - Generate Activity Diagram From 500
    - Generate Diagram From 499
    - Generate From Activity Diagram 513
    - Generate From Clipboard Text 496
    - Generate Robustness Diagram From 504
    - Generate RuleFlow Diagram From 501
    - Generate Sequence Diagram From 503
    - Generate State Machine Diagram From 501
    - Generate Structure From Notes 490
    - Glossary Reference, Add 497
    - In Scenarios & Requirements Window 514
    - Insert Context Reference 497
    - Internal Test Cases 505
    - Item Context Menu 496
    - Join Scenarios 498
    - Link Step To Use Case 496, 497
    - Link To Element 497
    - Merge Steps 496
    - Move Step 495
    - Move Steps 496
    - Object 490
    - Organization 498
    - RTF Report Template Sections 1585
    - Set Responsible Entity 496
    - Split Step 497
    - Structured Specification Tab 490
    - Structured Specification, Create 494
    - Structured, RTF Reporting 1585
    - Test Cases 505
    - Testing 1543
    - Text Context Menu 497
    - Toolbar 495
    - Type, Define 658
    - Undo Changes 497
    - Use Case 710

- ScenarioDiagramType Enum
  - Automation Interface 1678
- ScenarioExtension
  - Automation Interface, Element Package 1723
- Scenarios & Requirements
  - Toggle Window/View 514
  - Window 514
- ScenarioStep
  - Automation Interface, Element Package 1723
- ScenarioStepType Enum
  - Automation Interface 1679
- ScenarioTestType Enum
  - Automation Interface 1679
- Schema
  - Database 739
  - Database, Import From ODBC 1363
  - DDL, Import From ODBC 1363
  - Owner Tagged Value 1016
  - Set Owner 1016
- Scope
  - Values 1282
- Scope Guides
  - Code Editor, Common 1431
- Screen
  - Element 847
- Script
  - Add To MDG Technology 1131
  - Commands 1663
  - Console 1663
  - Copy 1661
  - Create 1661
  - Default, Set In Visual Execution Analyzer 1428
  - Delete 1661
  - Deploy, Create 1484
  - Deploy, Introduction 1484
  - Engines 1660
  - Execute 1661
  - Group 1660, 1661
  - Group Type 1663
  - Hyperlink To 842
  - JavaScript 1660, 1661
  - JScript 1660, 1661
  - Local 1660, 1661
  - Move 1661
  - Normal 1663
  - Project Browser 1663
  - Run, Introduction 1482
  - Search 1485, 1663
  - Template 1660, 1661
  - Unit Test, Create 1483
  - Unit Test, Introduction 1483
  - User 1660, 1661
  - VBScript 1660, 1661
  - Workflow 1663
  - Workflow Functions 220
  - Workflow, Introduction 220
  - Worklow 1661
- Script Actions
  - Define, Visual Execution Analyzer 1427
- Script Editor
  - Context Menu 1437
- Script Objects 1439
- Scripter Window 1660
  - Console Tab 1663
  - Console Toolbar 1663
  - Context Menu 1661
  - Editor 1439
  - Group Properties Dialog 1663
  - Intellisense 1439
  - Runtime Objects 1439
  - Script Editor 1439
  - Script Objects 1439
  - Scripts Tab 1661
  - Toolbar 1661
  - Type Libraries 1439
- Scripting
  - In Enterprise Architect 1659
- Scripts
  - Build 1443
- SDK
  - Enterprise Architect 1092
- Search
  - A Package 1233
  - Add-In 1781
  - Advanced Options 1238
  - Code Editor Facility 1437
  - Conditions 1243
  - Configure Code Editor Context Menu Options 1437
  - Debugger File Search 1485
  - Definitions 1235
  - Definitions, New 1239
  - Definitions, Predefined 1241
  - Element Features 1235
  - Element Features, RTF Reports 1612
  - Element Filters, RTF Reports 1611
  - Fields 1243
  - File, Introduction 1485
  - Filters 1235
  - List, Predefined Searches 1241
  - Macros, SQL 1239
  - Manage 1235
  - Model 1235
  - Model, Create Search Definition 1239

- Search
  - Other Filters, RTF Reports 1612
  - Project 1233, 1235
  - Query, New 1239
  - Results, Manipulate 1231
  - Scripts 1485, 1663
  - Simple 1235
  - Team Review 217
  - The Model Search 1233
  - User Defined, Storage 1239
  - Within Project Browser 1212
- Search Data Parameter
  - Add-In Search 1782
- Search Filters
  - Add To Search 1242
- Search Project
  - Add Filters 1242
- Section Numbering
  - In RTF Reports 1601
  - In Virtual Documents 1623
- Security
  - Basics 188
  - Change Password 191, 202
  - Disable 189
  - Enable 189
  - Maintain Groups 197
  - Maintain Users 191
  - Policy 190
  - Re-enable 189
  - Require User Lock Mode 190
  - Reset Password 202
  - Rigorous Security 190
  - Set Password 202
  - Standard Security 190
  - Submenu (Project Menu) 64
  - Tasks 188
  - User Permission List 198
  - User/Group Lock Mode 190
  - What Is User Security? 188
- Security Group Permissions 197
- Select
  - Alternative Image 447
  - ODBC Data Source 1365
  - Stereotypes 897
- Select <Item> Dialog 515
- Select All
  - Menu Option (Edit Menu) 57
- Select Attribute Type
  - Data Type 560
  - Dialog 560
- Select By Type
  - Menu Option (Edit Menu) 57
- Select Property Dialog 517
- SELECT Statement
  - SQL Search 1239
- Selectable
  - Element 555
- Self Message
  - Calls 872
- Self-Message
  - Connector 871
  - Hierarchy, Sequence Diagram 712
  - Relationship 871
  - Return 871
- Send
  - Element 789
  - Event 839
- SendSignal Action
  - Signal Tab 745
- Sequence
  - Communication Messages 880
  - Elements and Connectors 410
  - Message, Change Timing Details 874
  - Message, Create 868
  - Message, Timing Details 874
  - Oracle, DDL Options 1367
  - Oracle, DDL Options For Packages 1369
- Sequence Diagram
  - Activation Levels 712
  - And Version Control 710
  - Damage To 710
  - Description 706
  - Diagram Features, Generate Sequence Diagrams 1507
  - Display Options 360
  - Element Activation 711
  - Elements 710
  - Elements And Connectors 706
  - Example 706
  - Generate Code From 1314, 1322
  - Generate From Debugger Call Stack 1480
  - Generate From Recording, Execution Analysis 1505
  - Generate From Scenario 499, 503
  - Generate In Execution Analysis 1491
  - Generate, Execution Analysis 1507
  - Layout 709
  - Lifeline Activation Level 712
  - Messages, Asynchronous Signal 877
  - Messages, Self Message 871
  - Recording History, Execution Analysis 1506
  - Save Recording History, Execution Analysis 1507
  - Self-Message Hierarchy 712

- Sequence Diagram
  - Top Margin, Change 714
- Sequence Diagram Message
  - Examples 873
  - External To Sequence 873
  - General Ordering 876
- Sequence Diagram Recording Tab
  - Build Script, Options 1492
- Sequence Element
  - Inline, Part And Port 714
- Sequence Flow
  - Create 980
  - Model In BPEL 980
- Sequence Message
  - Label Visibility 714
  - Modify Height 709
- Sequence Recording Option 1492
  - Advanced Techniques 1497
  - Enable Diagnostic Messages 1496
  - Enable Filter 1493
  - Limit Auto Recording 1496
  - Record Activity For Class 1497
  - Record Activity For Method 1498
  - Record Arguments To Function Calls 1494
  - Record Calls To Dynamic Modules 1495
  - Record Calls To External Modules 1494
- Sequential Node
  - Structured Activity 796, 798
- Server
  - Apache Tomcat, Debugging 1456
  - JBOSS, Debugging 1456
  - Tomcat, Debugging 1456
- Server Configuration
  - JBOSS 1458
  - Tomcat 1459
- Server Repository
  - Create for Oracle 10g 129
  - Create for Oracle 9i 129
- Service
  - WSDL Diagram 1054
  - WSDL Element 1054
- Service Configuration
  - Tomcat 1460
- Service Oriented Architecture 1039
  - Development 1279
  - Implementing XML-Based, In Enterprise Architect 1279
- Service Oriented Architecture Modeling Language 1089
- Set
  - Activities For Transitions 515
  - Association Specialization 623
  - Classifiers For REFGUID Tagged Values 515
  - Collection Classes 1345
  - Connector Visibility 619
  - Default Diagram, Model 437
  - Default Tree Behavior 1210
  - Diagram Appearance Options 423
  - Diagram Page Size 455
  - Diagram Properties 423
  - Element Classifier 904
  - Element Cross References 527
  - Element Custom References 527
  - Element Parent 526
  - Feature Visibility 438
  - Font For Element Text 556
  - Group Permissions 197
  - Instance Classifier 515
  - Interface For Element 526
  - Main RTF Report Properties (Legacy) 1629
  - Message Source and Target 624
  - Object State 824
  - Operation Parameter Return Type 515
  - Operation Parameter Type 515
  - Operation Return Type 515
  - Parent For Element 526
  - Pattern Element Defaults 515
  - Relationship Visibility 619
  - Set Attribute Dialog 748
  - Set Feature Dialog 748
  - Set Feature Visibility
    - Element Context Menu Option 554
  - Set Function
    - Create As Attribute Property 565
  - Set Operation Dialog 748
  - Set Project Custom Colors
    - For Element 540
  - Set Up
    - Adaptive Server Anywhere ODBC Driver 141
    - Database Model Files 122
    - Debug Session 1447
    - For .NET 1461
    - MySQL ODBC Driver 135
    - ODBC Driver 135
    - PostgreSQL ODBC Driver 138
    - Progress OpenEdge ODBC Driver 145
    - Single Permissions 195
    - User Groups 194
  - Settings
    - Author 645
    - Cardinality (Multiplicity) 665
    - Clients 651
    - Constraint Status Types 656
    - Constraint Types 655

- Settings
  - Default Hours 340
  - Effort Types 319
  - Environment Complexity Factors 337
  - Estimation 659
  - General Types 653
  - Maintenance 660
  - Menu 644
  - Menu, Configure 73
  - Metric Types 320
  - Metrics 659
  - People 645, 650
  - Problem Types 660
  - Project Author 645
  - Project Resources 650
  - Requirement Types 657
  - Risk Types 322
  - Roles 648
  - Scenario Types 658
  - Status Types 653
  - Stereotypes 662
  - Tagged Value Types 664
  - Technical Complexity Factors 336
  - Template Package 542
  - Testing Types 661
  - UML Types 662
- Shallow Copy
  - Of Diagram 436
- Shallow History 777
  - Convert To Deep History 549
- Shape
  - <LabelID> 1161
  - Attributes 1152
  - Decoration 1161
  - Editor 1150
  - Label 1161
  - Main 1161
  - Source 1161
  - Target 1161
- Shape Attributes
  - Shape Scripts 1152
- Shape Editor 664, 1150
- Shape Scripts
  - Add To Profile 1104
  - Arithmetical Operations 1162
  - Assign To Stereotype 1148
  - Basic Shapes 1163
  - Change Font Of Text 1162
  - Cloud Path 1163
  - Color Queries 1158
  - Comments 1162
  - Conditional Branching 1158
  - Connector 1163
  - Create 1148
  - Custom Shapes 1147
  - Display Element Properties 1158
  - Double Line 1163
  - Drawing Methods 1154
  - Editable Field 1163
  - Example Shape Scripts 1163
  - Filled Arrow 1163
  - Fonts 1162
  - Getting Started 1148
  - Introduction 1147
  - Looping 1162
  - Miscellaneous 1162
  - Multiple Condition 1163
  - Override Element Appearance 1148
  - Properties, Connector 1158
  - Properties, Element 1158
  - Query Methods 1158
  - Reserved Names, Connectors 1161
  - Reserved Names, Elements 1161
  - Return Statement 1163
  - Shape Attributes 1152
  - Shape Editor 664, 1150
  - Single Condition 1163
  - Stereotypes 1147
  - String Manipulation 1162
  - Subshape 1163
  - Subshape Layout 1160
  - Syntax Grammar 1151
  - Terminate Execution 1162
  - Variable Declarations 1162
  - Without Stereotypes 1162
  - Writing Scripts 1151
- Share
  - An Enterprise Architect Project 183
  - Project On Network Drive 183
- Shared Key
  - Add 1870
  - Issues 1872
- Shared Model Development
  - Enterprise Architect 5
- Shortcut
  - Clear 117
  - Diagram (Capture Current Environment) 117
  - Keyboard 104
  - Keyboard/Mouse 109
  - Menu, Toolbox 403
  - Model (Capture Current Environment) 117
  - Model Search (Capture Current Environment) 117

- Shortcut
  - Relationship Matrix (Capture Current Environment) 117
  - Team Review (Capture Current Environment) 117
- Shortcut To
  - Diagram 115
  - Diagram (Direct Definition) 116
  - Model 115
  - Model (Direct Definition) 116
  - Model Search 115
  - Model Search (Direct Definition) 116
  - Relationship Matrix 115
  - Relationship Matrix (Direct Definition) 116
  - Team Review 115
  - Team Review (Direct Definition) 116
- Show
  - Code Execution (Project Menu) 62
  - Connectors, All Diagrams 621
  - Connectors, Requirements Element 621
  - Connectors, Single Diagram 621
  - Diagram Caption Bar 59
  - Duplicate Tagged Values 637
  - Element Stereotype 898
  - Feature Stereotype 898
  - Labels 622
  - Package Contents On Diagram 389
  - Project Browser 1209
  - Relationship 489
  - Toolbox 399
  - Usage Of Element 526
  - Use Case Arrowhead 625
- Show Grid
  - Diagram Menu Option 65
- Show Status Colors on Diagrams
  - Menu Option 920
- Show/Hide
  - Connectors 609
  - Labels 609
- Signal
  - Element 834
  - Reception 834
- Simple View 383
- Simulate
  - SysML Parametric Model 1005
- Single Permissions
  - Set Up 195
- Single User 1343
- Size
  - Elements By Increments 70
  - Submenu 70
- Slideshow
  - Diagram Presentations 1222, 1228
  - Model View 1222, 1228
  - Of Diagrams, Automate 1228
  - Properties Dialog, Model View 1228
  - Remove From Model View 1228
  - Run, Diagram View 1228
  - Run, Full Screen View 1228
  - Stop 1228
- Snap to Grid
  - Diagram Menu Option 65
- SOA 1039
  - Development 1279
  - Implementing XML-Based, In Enterprise Architect 1279
  - Modeling Language 1089
- SOA WSDL
  - Elements And Connectors, Enterprise Architect 420
- SOA XSD
  - Elements and Connectors, Enterprise Architect 420
- SoaML
  - Concept 1089
  - Diagrams 1089
  - Disable 1089
  - Elements 1089
  - Enable 1089
  - MDG Technology 1089
  - Toolbox Pages 1089
- SOAP Binding 1057
- Software and Systems Process Engineering Meta-model
  - SPEM 1061
- Software Architect
  - And Enterprise Architect 40
  - Project Role 40
- Software Development
  - Database Engineering 1363
  - MDA Transformations 1385
  - Model Transformations 1385
  - Software Engineering 1281
  - XML Engineering 1373
- Software Development Kit
  - Enterprise Architect 1092
- Software Engineer
  - And Enterprise Architect 41
  - Project Role 41
- Software Product License Agreement 16
- Sort Order
  - Project Browser, Reset 34
- Sorted Lookup Table
  - Create In Data Modeling 1033
- Source

- Source
  - Set for Message 624
- Source Code
  - Add New Features And Elements 1308
  - Control 228
  - Display In Source Code Viewer 1441
  - Display Parameter Information 1442
  - Editor 1441
  - Editor Functions 1442
  - Engineering, Project Browser Options 1212
  - File Parsing In Source Code Viewer 1441
  - Generate For Method In Project Browser 1221
  - Generate For Operation In Project Browser 1221
  - Import, Reverse Engineering 1329
  - Internal Editor Options 1337
  - Open Directory, Project Browser Menu Option 1218
  - Record Macro 1442
  - Reset Language 1212, 1361
  - Reverse Engineer 1328
  - Synchronize 1328
  - Synchronize With Method In Project Browser 1221
  - Synchronize With Operation In Project Browser 1221
  - View For Method In Project Browser 1221
  - View For Operation In Project Browser 1221
  - View, Project Browser Menu Option 1218
  - Viewer 1441
  - Viewer Toolbar 1442
  - XML Structure Tree 1441
- Source Code Engineering
  - Submenu (Element Menu) 69
  - Submenu (Project Menu) 62
- Source Code Generation
  - Class 1308
  - Interface 1308
  - Overview 1308
- Source Object
  - Multiplicity 629
- Source Role
  - Details 629
- Space Evenly
  - Submenu 70
- Sparx Systems
  - Enterprise Architect Community Site 23, 50
  - Website 23
- Specialize Association 623
- Specialized UML Models 917
- Spell Check
  - Correct Words 1553
  - Dictionary 1553
- Languages, Download 1554
- Model 1552
- Perform 1552
- Project 1552
- Single Package 1552
- Spell Checking
  - Automatic, Disable 1552
  - Automatic, Enable 1552
  - Introduction 1552
- Spelling
  - Language (Tools Menu) 70
- SPEM
  - Base Plug-In 1061
  - Concept 1061
  - Diagram 1062
  - Disable 1061
  - Elements 1062
  - Enable 1061
  - MDG Technology 1061
  - Method Content 1061
  - Package 1061
  - Process 1061
  - Software and Systems Process Engineering Meta-model 1061
  - Stereotype Presentation 1062
  - Toolbox Page 1062
- Spring Diagram Layout 466
- SQL
  - Custom Searches 1239
  - Editor 1239
  - Patches, Run 346
  - Search Macros 1239
  - Search, SELECT Statements 1239
  - Server Data Repository, Connect To 150
  - Server Repository, Create 126
- SQL Server
  - Desktop Engine, Upsize To 173
  - Non-Clustered Primary Key 1024
  - Upsize To 176
- Standard Colors
  - Attribute 353
  - Connector Line 353
  - Diagram Background 353
  - Element Fill 353
  - Element Line 353
  - Method 353
  - Note Text 353
  - Operation 353
  - Options 353
  - Screen 353
  - Shadow 353
- Standard Element Stereotypes 899



- Start
  - Application 27
  - Enterprise Architect 27
- Start Event, BPEL
  - Create 962
  - Model 962
  - Types 962
- Start Page
  - Full Description 50
  - Quick Start 28
- State
  - Add To State Lifeline Element 693
  - Chart 678
  - Composite 789, 790
  - Delete On State Lifeline Element 693
  - Diagram 678
  - Edit On State Lifeline Element 693
  - Element 789
  - Entry And Exit Actions 570, 789
  - In Timeline Element 697
  - Locate In State Machine Diagram 689
  - Locate In State Machine Table 689
  - Operation Behavior 573
  - Reposition In State Machine Table 689
  - Simple 789
  - State Machine Table Conventions 689
- State (Machine)
  - Elements and Connectors 411
  - Group, Toolbox 411
- State Changes
  - Capture, Execution Analysis 1508
  - Map, Visual Execution Analyzer 1511
  - Record, Visual Execution Analyzer 1511
  - Set Up To Capture, Execution Analysis 1508
- State Invariant
  - Element 792, 793
- State Lifeline
  - Element 794
- State Lifeline Element
  - Add State 693
  - Add To Timing Diagram 693
  - Add Transition 694
  - Change Transition Time 694
  - Define Name 693
  - Delete State 693
  - Delete Transition 694
  - Edit State 693
  - Edit Transition 694
  - Merge Transitions 694
  - Move Transition 694
  - Set Timeline Start Position 693
  - Sizing and Scale 693
  - Synchronize Transition 694
- State Machine
  - Element 796
  - Entry And Exit Actions 570
  - Model For Hardware Description Languages 1319
  - Regions 681
- State Machine Diagram
  - Code Generated From 1317
  - Description 678
  - Display Format 678
  - Elements And Connectors 678
  - Example 678
  - Execution Analysis 1509
  - Generate Code From 1314, 1316
  - Generate From Scenario 499, 501
  - In Visual Execution Analyzer 1509
  - Locate State In State Machine Table 689
  - Locate Transition In State Machine Table 689
  - Locate Trigger In State Machine Table 689
- State Machine Table
  - Add States 687
  - Add Substates 687
  - Add Triggers 688
  - Cell Color 684
  - Cell Enumeration 684
  - Cell Highlights 684
  - Cell Size 684
  - Change Position In Diagram View 687
  - Change Size 687
  - ChangeTransitions 688
  - Conventions 689
  - Description 682
  - Export To CSV 690
  - Format 682
  - Insert Transitions 688
  - Legend, Add 689
  - Legend, Remove 689
  - Locate State In State Machine Diagram 689
  - Locate Transition In State Machine Diagram 689
  - Locate Trigger In State Machine Diagram 689
  - Operations, Overview 686
  - Options 684
  - Remove Substate Parent Relation 687
  - Reposition States 689
  - Reposition Substates 689
  - Reposition Triggers 689
  - State-Next State 682
  - State-Trigger 682
  - Table Format 684
  - Trigger-State 682

- State Region
  - Composite 681
- State Transitions
  - Add, Visual Execution Analyzer 1507
- State/Continuation
  - Element 792
- Status Bar
  - Element Coordinates 89
  - Enterprise Architect Workspace 89
  - Hide 89
  - Show 89
  - Zoom Control 89
- Status Type
  - Color 653
  - Define 653
  - For Different Elements 653
- Step Into
  - Function Calls 1473
- Step Out Of
  - Functions 1473
- Step Over
  - Lines Of Code 1472
- Step Through
  - Function Calls 1480
- Stereotype
  - Add Shape Script In Profile 1104
  - Add To Profile 1096
  - Add, Automation Interface Code Example 1773
  - Analysis 835
  - And Metafiles 895
  - Apply To Dependency Relationship 862
  - Automation Interface Repository 1706
  - Custom 1093
  - Define As Metatype 1109
  - Definition 895
  - Dialog 1093
  - Extension 835
  - Inbuilt 835
  - Multiple, Restrict Application Of 1110
  - Predefined Tag Types 1099
  - Profile 1113
  - Selector 897
  - Set Default Appearance Of Objects In Profile 1106
  - Settings 662
  - Show On Project Browser 1210
  - SPEM Presentation 1062
  - Standard Element 899
  - Synchronize Element With Profile 910
  - Tagged Values In Profile 1098
  - Tags For Supported Attributes 1100
  - Tags, Define 1098
  - UML Description 895
  - Visibility 898
  - With Alternative Images 900
  - XSD In UML Profile 1041
- Stereotyped Element
  - Table 849
- Stop Recording
  - Execution Analysis, Recording Sequence Diagrams 1505
- Store
  - Image In Enterprise Architect 447
- Stored Procedure
  - As Individual Class 1030
  - Definition 1030
  - Element 1030
  - Select From ODBC Data Source 1366
  - Supported Databases 1030
- Straighten
  - Line At Cursor 615
- Strategic Modeling
  - MDG Technology For, Enterprise Architect 1073
- String Viewer Dialog 1474
- Structural Diagram
  - Elements 809
- Structural Diagrams
  - Overview 719
- Structural Specification
  - Generate From Description 490
- StructuralFeature Action
  - Set Structural Feature 745
- Structured Activity
  - Conditional Node 796, 798
  - Element 796, 798
  - Loop Node 796, 798
  - Nested 796
  - Node 796, 798
  - Sequential Node 796, 798
- Structured Activity Node 798
- Structured Scenario
  - Alternate Path 493
  - Constraints Tab 507
  - Editor 493
  - Entry Points Tab 493
  - Exception Path, 493
  - RTF Report Template Section 1585
  - Structured Specification Tab 493
- Structured Specification
  - Alternate Path 493
  - Alternate Path, Add 495, 496
  - Context Menu, Item 496

- Structured Specification
  - Create 494, 495, 496
  - Create Element 497
  - Delete Path 498
  - Delete Step 495, 496
  - Delete Text 497
  - Edit Text 497
  - Entry Points Tab 493
  - Entry Points Tab, Context Menu 498
  - Exception Path 493
  - Exception Path, Add 495, 496
  - External Test Cases 505
  - Floating Toolbar 499
  - Generate From Activity Diagram 513
  - Generate From Clipboard Text 496
  - Glossary Reference, Add 497
  - Insert Context Reference 497
  - Internal Test Cases 505
  - Item Context Menu 496
  - Join Scenarios 498
  - Link Step To Use Case 496, 497
  - Link To Element 497
  - Merge Steps 496
  - Move Steps 496
  - Of Scenario Steps 493, 494
  - Organization 498
  - Set Responsible Entity 496
  - Split Step 497
  - Test Cases 505
  - Text Context Menu 497
  - Toolbar 495
  - Undo Changes 497
- Structured Tagged Value Type 1166
- Structured Tagged Values
  - Create 1168
- Style
  - For Connectors 608
- Style Template
  - Fragments, HTML 1651
- StyleEx
  - Diagram Profile Attribute Values 1140
- Sub Activity
  - As Hyperlink 842
- Sub-Activity
  - Conditional Node 796, 798
  - Element 753, 796, 798
  - Loop Node 796, 798
- Submachine State
  - Element 789, 796
- Submenu
  - Add-In 72
  - Advanced (Element) 68
  - Alignment 70
  - Appearance (Element) 69
  - Data Management (Tools Menu) 71
  - Database Engineering (Project Menu) 63
  - Documentation (Project Menu) 61
  - Execution Analyzer (Project Menu) 62
  - Execution Analyzer (View Menu) 59
  - Hidden, Create In Toolbox Profile 1135
  - Import/Export (Project Menu) 65
  - Inline Features (Element Menu) 68
  - Make Same 70
  - Manage .EAP File (Tools Menu) 71
  - Model Transformations (Project Menu) 63
  - Model Validation (Project Menu) 64
  - Move 70
  - Online Resources 74
  - Other Element Tools 59
  - Other Project Tools 59
  - Paste Elements (Edit Menu) 58
  - Security (Project Menu) 64
  - Size 70
  - Source Code Engineering (Element Menu) 69
  - Source Code Engineering (Project Menu) 62
  - Space Evenly 70
  - Toolbars 59
  - Version Control (Project Menu) 65
  - Visual Styles 59
  - Web Services (Project Menu) 64
  - XML Schema (Project Menu) 64
  - Zoom 453
  - Z-Order 70
- Subshape
  - Example 1160
  - In Shape Scripts 1160
- Substate
  - Reposition In State Machine Table 689
- Sub-State 790
- Substitute Words
  - In Extended RTF Generator 1615
  - In RTF Report (Legacy) 1637
- Substitution
  - Conditional 1174
  - Direct 1174
  - Macro 1158
- Subtype
  - Relationship 620
- Subversion
  - Caching Client Credentials 247
  - Configure Version Control 250
  - Documentation 247
  - Executables 247
  - Repository URLs 247

- Subversion
  - Setting Up 247
  - TortoiseSVN 252
  - UNIX-Based Client 249
  - Using With Enterprise Architect Under WINE Crossover 249
  - Version Control Options 247
  - Version Control, Create Local Working Copy 249
  - Version Control, Create Repository Subtree 248
  - Windows-Based Client 249
- Support
  - For Registered Users 24
  - For Trial Users 24
- Supported Attribute
  - By XML Element Node 914
  - Create Composite Elements 1111
  - Define Behavior On Creating Instance 1110
  - Define Child Diagram Types 1111
  - In UML Profiles 914
  - Metatype, In Profiles 1108
  - Of Stereotype Tags 1100
  - Stereotype, In Profiles 1108
- Supported Stereotype Attribute Tags 1100
- Supported Tags
  - In UML Profiles 912
- Supress
  - Line Segments 615
- SwimlaneDef
  - Automation Interface, Diagram Package 1751
- Swimlanes
  - Automation Interface, Diagram Package 1751, 1752
  - Manage 450
  - On Diagram 450
  - Orientation 450
- Swimlanes Matrix
  - Activate 444
  - And Matrix Dialog, Matrix Tab 444
  - Create Columns And Rows 444
  - Define Heading 444
  - Delete Items 444
  - Edit Items 444
  - Lock 444
  - Model Profile 444
  - Size 444
- Switch
  - Diagram 396
  - RTF Generator 1607
- Sybase Adaptive Server Anywhere
  - ODBC Driver, Set Up 141
  - Upsize To 170
- Synch
  - Element 802
- Synchronization 184
  - Intial Code In Operations 576
  - Introduction 1281
  - Macros, Code Template Syntax 1190
  - Of Source Code And Model 1328
- Synchronize
  - Batch With Code 69
  - By Dragging Element From Toolbox 910
  - Call Argument With Behavior Parameter 582
  - Class With Code 69
  - Code 1307
  - Elements With Profile 910
  - Existing Code Sections 1308
  - Invocation Argument With Behavior Parameter 582
  - Package With Source, (Project Menu Option) 62
  - Replicas 186
  - Stereotypes From Profile 910
  - Tagged Values And Constraints 910
  - Tagged Values From MDG Toolbox Pages 910
  - Tagged Values From Resources Window 910
  - UML Profile Tagged Values And Constraints 910
- Syntax Check
  - For UML, Option 355
- Syntax Grammar
  - Shape Scripts 1151
- Syntax Highlighting
  - Code Editor Options 1338
  - Code Editor, Common 1429
- SysML
  - Activity Elements, Toolbox Page 996
  - Activity Relationships, Toolbox Page 996
  - Block Definition Elements, Toolbox Page 992
  - Block Relationships, Toolbox Page 992
  - Concepts 989
  - Create Operational Domain Model 1007
  - Design Model 1009
  - Diagrams 989
  - Disable 989
  - Interaction Elements, Toolbox Page 998
  - Interaction Relationships, Toolbox Page 998
  - Internal Block Diagram 1009
  - Internal Block Elements, Toolbox Page 994
  - Internal Block Relationships, Toolbox Page 994
  - MDG Technology 989
  - MDG Technology For, Enterprise Architect 1073

- SysML
    - Model Elements, Toolbox Page 991
    - Model Relationships, Toolbox Page 991
    - Parametric Elements, Toolbox Page 995
    - Parametric Model, Simulate 1005
    - Parametric Models 1002
    - Parametric Relationships, Toolbox Page 995
    - Requirement Elements, Toolbox Page 1001
    - Requirement Extensions, Toolbox Page 1001
    - Requirement Relationships, Toolbox Page 1001
    - Requirements Model, Create 1007
    - Reusable Subsystems 1011
    - State Machine Elements, Toolbox Page 999
    - State Machine Relationships, Toolbox Page 999
    - Toolbox Pages 989
    - Use Case Elements, Toolbox Page 1000
    - Use Case Relationships, Toolbox Page 1000
  - System
    - Project Glossary 323
    - Project Issues 323
    - Project Tasks 323
    - Tabs 323
    - Testing 1541
    - Users 191
    - Window 323
  - System Boundary
    - Element 802
    - Insert New From Toolbar 83
  - System Design,
    - Compose, Systems Engineering Modeling 1009
  - System Engineering Modeling
    - Create Reusable Subsystems 1011
  - System Window
    - Project Glossary Tab 325
    - Project Issues Tab 332
    - Project Tasks Tab 329
  - SystemC
    - Code Generation 1357
    - Enterprise Architect Toolbox Pages 1295
    - Language Options 1357
    - Modeling Conventions 1295
  - Systems Engineering Edition
    - Of Enterprise Architect 12
  - Systems Engineering Model
    - Create 986
  - Systems Engineering Modeling
    - Compose System Design 1009
    - Create SysML Parametric Model 1002
    - Create SysML Requirements Model 1007
    - Overview 986
    - Process 986
    - Simulate SysML Parametric Model 1005
    - SysLM Operational Domain Model, Create 1007
  - Systems Modeling Languages
    - MDG Technology For, Enterprise Architect 1073
  - Systems Modelling Language (SysML) 989
- T -**
- Tab
    - Asterisks 397
    - Audit History In Output Window 102
    - Context Menu 397
    - Context References 506
    - Diagram 397
    - View 397
  - Tab Support
    - RTF Style Template Editor (Enhanced) 1595
  - Tabbed Frame
    - Combine Windows In 76
    - Remove Window From 76
  - Table
    - DDL Script For 1011
    - Detail 849
    - Element 849
    - Owner Tagged Value 1016
    - Properties 849
    - Set Owner 1016
    - Set Properties 1014
    - State Machine 682
  - Table Of Contents
    - MS Word, Add 1641
  - Table Of Figures
    - MS Word, Add 1642
  - Tables in RTF Reports
    - Sections 1581
    - Split Rows 1581
  - Tag
    - Compartment, Element 521
    - Management, Advanced 638
    - Profile 1098
  - Tag Type
    - Predefined, Assign To Stereotype 1099
  - Tagged Value
    - Add 634
    - Add To Operations 577
    - Assign Information To 636
    - Assign To Item 635
    - Behavior Parameters 585

- Tagged Value
  - By Dragging Element From Toolbox 910
  - Connector, Use 1101
  - Custom, Create 1171
  - Duplicate Values 632
  - Element Package, Automation Interface 1724
  - Entity Relationship Diagram 1077
  - For Oracle Table Properties 1017
  - For Schema Owner 1016
  - For Table Owner 1016
  - Fully Qualified, Show 438
  - Fully-Qualified Value 632
  - In UML Profiles 910
  - Inherited, Show 438
  - Macros, Code Template Syntax 1186
  - Masked, Create 1171
  - Model Components And 632
  - Modify 632
  - Modify Value 635
  - Of Attributes 564
  - Quick Add 634
  - Reference Data, Create 1170
  - Show Duplicates 637
  - Structured, Create 1168
  - Supported For UML Profile Stereotypes 912
  - Synchronize, And Constraints 910
  - Synchronize, From MDG Toolbox Pages 910
  - Synchronize, From Resources Window 910
  - Tab, Element Properties Dialog 508
  - Toolbar 632
  - Types 664
  - Types Of Value Field 635
  - View 632
  - What Is A? 632
  - Window 632
- Tagged Value Type
  - Add To MDG Technology 1127
  - Filters 1166
  - Introduction 1166
  - Predefined Reference Data 1169
  - Predefined Structured 1166
- TaggedValue
  - Automation Interface, Element Package 1724
- Target
  - Role 631
  - Set For Message 624
  - Types 1627
- Task
  - Automation Interface Repository 1707
  - Completion 314
  - Details 330
- Task Panel
  - Add To MDG Technology 1126
- Tasks Pane
  - Allocate Toolbox To Contexts 1144
  - Commands, Built In 1142
  - Contexts, Define 1144
  - Getting Started 51
  - Introduction 23
  - Named Contexts 1144
  - Profiles, Create 1141
  - Run Add-In Functions From 1143
  - Save Profile 1145
  - Toolboxes, Define 1141
  - Tools 51
  - Window 51
- TCF
  - Value 336
  - Weighting 336
- TcSE
  - MDG Integration For, Enterprise Architect 1073
- Team
  - Develop Projects In, Introduction 182
  - Development, Introduction 111
  - Development, Project Sharing 182
- Team Deployment
  - And Version Control 232
  - Version Control Branching 232
- Team Foundation Server
  - Connect Enterprise Architect Model For Version Control 253
  - Version Control Option 253
- Team Review
  - Access 208
  - Access From Shortcut 115, 117
  - Access From Shortcut (Direct Definition) 116
  - Add External File Link To Post 216
  - Add New Category 211
  - Add New Post 213
  - Add New Topic 212
  - Add Object Link To Post 216
  - Add Team Review Link To Post 216
  - Capture Diagram Image As Resource 217
  - Connections To Other Team Reviews 218
  - Context Menu Options 209
  - Copy Path To Clipboard 218
  - Create Category 211
  - Create Post 213
  - Create Reply 214
  - Create Topic 212
  - Delete Category 209
  - Delete Item 215
  - Delete Post 209

- Team Review
  - Delete Resource 209
  - Delete Resources 217
  - Delete Topic 209
  - Edit Item 215
  - Editor 215
  - Export Package As Resource 217
  - Hyperlink To 840
  - Icons 208
  - Import Resource Package 217
  - Introduction 208
  - Load Data When Required 218
  - Loading Behavior 218
  - Mark All Posts Unread 218
  - Options 218
  - Postings in Model Views 1222
  - Preload 218
  - Reply To Post 214
  - Resources 217
  - Save Profiler Report As Resource 1519
  - Search 217
  - Tab 208
  - View Diagram Image Resource 217
  - Was Discussion Forum 208
  - Window 208
- Teamcenter Systems Engineering, Siemens PLM
  - MDG Integration For, Enterprise Architect 1073
- Technical Complexity Factor
  - Estimate Project Size 338
  - Value 336
  - Weighting 336
- Technology Developer
  - And Enterprise Architect 46
  - Project Role 46
- Technology Event
  - EA\_OnInitializeTechnologies 1803
- Technology Events
  - Add-In Model 1803
  - EA\_OnDeleteTechnology 1806
  - EA\_OnImportTechnology 1806
  - EA\_OnPostActivateTechnology 1805
  - EA\_OnPreActivateTechnology 1804
  - EA\_OnPreDeleteTechnology 1805
- Technology-Defined Model View
  - Set Up 1226
- Template
  - Behavioral Model 1193
  - Editor In SDK 1202
  - Editor, Code Templates 1305
  - Element 906
  - Fragments, HTML 1651
  - Instantiated 813
  - Model, Incorporate In Technology 1146
  - Package, Settings 542
  - Parameterized Classes 813
  - RTF, Import 1606
  - Script 1660, 1661
  - Transformation, Default 1415
- Term
  - Automation Interface Repository 1708
- Terminate
  - Element 804
- Test
  - Automation Interface, Element Package 1725
  - Copy Between Categories 1544
  - Create Defect From 1548
  - Documentation 1550
  - Generate From Scenario 505
  - Import From Other Element 1546
  - Model Template 380
  - Move Between Categories 1544
  - Report 1550
  - Result Output 1550
  - Script Output 1550
  - Unit, In Execution Analysis 1512
  - Unit, Record Results In Execution Analysis 1514
  - Unit, Run In Execution Analysis 1513
  - Unit, Set Up In Execution Analysis 1512
- Test Case
  - Element 848
- Test Cases
  - Generate From Scenario 505
- Test Details Dialog 1538
- Test Script
  - Introduction 1483
  - JUnit 1512
  - NUnit 1512
- Test Scripts
  - Compartment 1549
- Tester
  - And Enterprise Architect 43
  - Project Role 43
- Testing
  - Acceptance 1542
  - Asterisk On Testing Window Tabs 1537
  - Autonaming 1537
  - Compartment, Element 521
  - Import Element Scenarios 1544
  - Import Internal Constraint 1547
  - Import Internal Requirement 1547
  - Import Package Scenarios 1544
  - Import Responsibility 1547

- Testing
  - Integration 1540
  - MDG Technology For, Enterprise Architect 1073
  - Model Template 380
  - Overview 1536
  - Report, Create 1627
  - Scenario 1543
  - Support 1536
  - System 1541
  - Type, Define 661
  - Unit 1539
  - Window 1537
  - Window, Acceptance Test Tab 1542
  - Window, Integration Test Tab 1540
  - Window, Scenario Test Tab 1543
  - Window, System Test Tab 1541
  - Window, Unit Test Tab 1539
  - Workspace 1537
- Testing Details Report 1549
- Testing Feature
  - Insert In Element 595
- Text Element
  - Create 536
  - Insert New From Toolbar 83
- TFS
  - Connect Enterprise Architect Model For Version Control 253
  - Version Control Option 253
  - Working Folder For Enterprise Architect Version Control 253
  - Workspace For Enterprise Architect Version Control 253
- The Debug Window 1467
- The Open Group Architecture Framework
  - MDG Technology For, Enterprise Architect 1073
- Theme
  - Microsoft Office Styles 101
  - Microsoft Visual Basic Styles 101
  - Options 101
  - Visual Style 59
- Tidy Line Angles 615
- Time Event 787
- Time Interval
  - Compress 700, 703
  - Context Menu 700
  - Copy and Paste 703
  - Create 700
  - Delete 700
  - Description 700
  - Move 700
  - Operations 703
  - Resize 700
  - Select 700
  - Shift Left Or Right 703
  - Transitions 703
- Time Range
  - Set For Timing Diagram 692
- Timeline Element States
  - Add Via Configure Timeline Dialog 697
  - Delete via Configure Timeline Dialog 697
  - Edit Via Configure Timeline Dialog 697
  - Maintain 697
  - Numeric Range Generator 697
- Timeline Range
  - Set For Timing Diagram 692
- Timeline Start Position
  - Set For State Lifeline Element 693
- Timing
  - Constraint 874
  - Details, Change 874
  - Elements and Connectors 410
  - Group, Toolbox 410
  - Message 882
  - Message, Create 883
  - Observation 874
- Timing Diagram
  - Add Value Lifeline Element 696
  - Create 692
  - Description 690
  - Edit Options 692
  - Edit Value Lifeline Element 696
  - Elements And Connectors 690
  - Example 690
  - Set Time Range 692
- TOGAF
  - MDG Technology For, Enterprise Architect 1073
- Tomcat
  - Server, Configuration 1459
  - Server, Debugging 1456
  - Service Configuration 1460
- Toolbar
  - (File) Search, Debugging 1485
  - Add Commands 91
  - Change Command Icon Appearance 91
  - Code Generation 81
  - Console Tab, Scripter Window 1663
  - Create 92
  - Current Connector 84
  - Current Element 84
  - Customize 92
  - Default Tools 80
  - Diagram 83



- Toolbar
  - Display Labels 92
  - Docked 79
  - Element 83
  - Element List 1258
  - Floating Buttons, Display 362
  - Floating, Structural Specification 499
  - Format (Element Appearance) 85
  - Hide 92
  - Large Icons 101
  - Manage Searches 1235
  - Missing Icon 90
  - Model Search 1231, 1234
  - Notes 642
  - Options, Customize Appearance 101
  - Project 81
  - Project Browser 1212
  - Remove 92
  - Remove Commands 91
  - Rename 92
  - Screen Tips 101
  - Scripter Window 1661
  - Show 92
  - Submenu 59
  - UML Elements 83
  - Workspace 79
  - Workspace Layouts 86
- Toolbar Customize Button
  - Show/Hide 59
- Toolbox
  - Activity Group 412
  - Add Stereotype To Diagram Element 399
  - Add To MDG Technology 1125
  - Analysis Group 416
  - Appearance Options 401
  - Archimate Group 1073
  - BPMN Group 952
  - Business Modeling Group 739
  - Class Group 407
  - Collapse Page 399
  - Common Group 405
  - Communication Group 409
  - Component Group 412
  - Composite Group 409
  - Connectors For Extending In Profile 1138
  - Create Elements And Connectors 399
  - Custom Group 417
  - Customize 1134
  - Data Flow Diagram Group 1076
  - Data Modeling Group 421
  - Default, Override In Profile 1136
  - Deployment Group 413
  - Documentation Group 1616
  - Elements For Extending 1137
  - Entity Relationship Diagram 1077
  - Eriksson-Penker Group 1080
  - Expand Page 399
  - Gang Of Four Pattern Group 1083
  - GoF Pattern Group 1083
  - Hide 399
  - Hide Labels 401
  - ICONIX Group 1084
  - Interaction Group 410
  - Maintenance Group 418
  - MDG Technology Groups 1067
  - Metamodel Group 415
  - Mind Mapping Group 1087
  - Object Group 408
  - Override Default In Toolbox Profile 1136
  - Page Attributes 1135
  - Pin Pages 401
  - Profile Group 414
  - Profile, Create For MDG Technology 1134
  - Profiles 1134
  - Requirement Group 418
  - Set Toolbox Visibility 401
  - Shortcut Menu 403
  - Show 399
  - Show Labels 401
  - SoaML Pages 1089
  - SPEM 1062
  - State (Machine) Group 411
  - Synchronize Stereotyped Tagged Values 399
  - SysML Groups 989
  - SystemC Group 1295
  - Tasks Pane, Define 1141
  - Timing Group 410
  - Unpin Pages 401
  - Use Case Group 406
  - User Interface Group 419
  - Verilog Group 1298
  - VHDL Group 1299
  - WSDL Group 420
  - XML Schema Group 420
- Toolbox Profile
  - Connectors For Extending 1138
  - Create Hidden Submenu In 1135
  - Items, Assign Icons For 1136
  - Pages That Can be Overridden 1137
- Tools
  - Custom 96
  - External Applications 96
  - Pass Parameters To External Tools 97
- Tools Menu 70

- Top Margin
  - Sequence Diagram, Change 714
- Topic
  - Add To Team Review 212
  - Create 212
  - Delete 209
- TortoiseSVN
  - In Version Control 252
- Trace
  - Connector 892
  - Relationship 892
- Traceability
  - Diagrams 1250
  - Element Grouping 1246
  - For Diagram 1253
  - For Elements 1253
  - In Requirements Models 736
  - Introduction 1245
  - Model Structure 1246
  - Package Organization 1246
  - Themes 1245
  - Tools 1251
  - Window 1253
  - Window, In Traceability 1251
  - With Dependency Report 1251
  - With Implementation Report 1251
  - With Relationship Matrix 1251
  - With Traceability Window 1251
- Track Changes
  - Auditing 269
  - Baselines 269
  - Introduction 269
- Trademarks 19
- Transfer
  - Project Data Between Repositories 307
- Transform
  - Connector End 1421
  - Connectors 1419
  - Copy Information 1421
  - Duplication Of Connectors 1419
  - Elements, MDA-Style Transformations 1387
  - Model, MDA-Style Transformations 1387
  - Names 1422
  - Objects 1415
- TRANSFORM\_CLASSIFIER
  - Macro 1423
- TRANSFORM\_CURRENT
  - Macro 1421
- TRANSFORM\_REFERENCE
  - Macro 1419, 1423
- Transformation
  - Built In, MDA-Style Transformation 1388
- C# 1389
- Data Model To ERD 1390
- DDL 1393
- Dependencies 1385
- EJB 1397
- Entity Bean 1397
- ERD To Data Model 1399
- Java 1403
- JUnit 1405
- NUnit 1407
- Session Bean 1397
- Write 1414
- WSDL 1408
- XSD 1409
- Transformation Dependency
  - Trace With Traceability Window 1253
- Transformation Template
  - Default 1415
  - Modify 1412
  - Transfer Between Models 1414
- Transition
  - Add To State Lifeline Elements 694
  - Add Via Configure Timeline Dialog 699
  - Change In State Machine Table 688
  - Change Time, State Lifeline Element 694
  - Connector 892
  - Delete On State Lifeline Element 694
  - Delete Via Configure Timeline Dialog 699
  - Edit In Time Intervals 703
  - Edit On State Lifeline Elements 694
  - Edit Via Configure Timeline Dialog 699
  - Effect 892
  - Guard 892
  - Highlight Associated Trigger or State 688
  - Insert In State Machine Table 688
  - Locate In State Machine Diagram 689
  - Locate In State Machine Table 689
  - Merge On State Lifeline Element 694
  - Move On State Lifeline Elements 694
  - Properties 892
  - Relationship 892
  - State Machine Table Conventions 689
  - Trigger 892
- Transitions Collection
  - Automation Interface, ElementFeatures Package 1737
- Translation
  - RTF Report Generation 1615
- Tree Style Hierarchy
  - Create 625
  - Set Default Link Style 625
- Trial Version

- Trial Version
    - Extend Trial Period 10
    - Of Enterprise Architect 10
    - Select Edition To Trial 10
    - Select Workspace Layout 10
  - Triangle
    - Red 341
  - Tricks and Traps
    - Create Add-In 1779
  - Trigger
    - Create 804
    - Create In State Machine Table 688
    - Create In Transition Properties 892
    - Element 804
    - For Transition 892
    - Intermediate Event, BPEL 968
    - Locate In State Machine Diagram 689
    - Locate In State Machine Table 689
    - Operation, What Is A? 1033
    - Ports 804
    - Properties Tab 804
    - Reposition In State Machine Table 689
    - Start Event, BPEL 962
    - State Machine Table Conventions 689
    - Type 892
  - Trigger Operation
    - Create 1033
    - What Is A? 1033
  - Type
    - Element Context Menu 549
  - Type Hierarchy Dialog 526
  - Type Libraries
    - For Script Editor 1439
  - Type Specific Menu Section
    - Connector 607
- U -**
- UAC
    - And Debugging 1448
  - UI Control
    - Element 849
  - Ultimate Edition
    - Of Enterprise Architect 12
  - UML
    - 1.3 288, 289, 344
    - 1.3, Import From XMI 290
    - 1.4 289
    - 1.4, Import From XMI 290
    - 1.5 362
    - 2.0 Migration 344
    - 2.0, Import From XMI 290
    - 2.3 - Definition 5
    - Analysis Tool - Enterprise Architect 4
    - Build Systems 5
    - Connectors 852
    - Data Modeling Profile 1011
    - Definition 672
    - Design Systems 5
    - Design Tool - Enterprise Architect 4
    - Dictionary 672
    - DTD 293
    - Elements 741
    - Enterprise Architect Modeling Platform 370
    - Extend 672
    - Manage Complexity 5
    - Mappings To XSD 1049
    - Model Complexity 5
    - Model Structure, Manage - Enterprise Architect 5
    - Models Under Single Root 291
    - Pattern 901
    - Recommended Reading 672
    - Shared Model Development - Enterprise Architect 5
    - Support - Enterprise Architect 5
    - Syntax Checking Option 355
    - Visualize Systems - Enterprise Architect 5
  - UML Behavioral Diagram
    - Overview 673
  - UML Business Process Model
    - In Enterprise Architect 374
  - UML Class Model
    - In Enterprise Architect 376
  - UML Component Model
    - In Enterprise Architect 378
  - UML Database Model
    - In Enterprise Architect 377
  - UML Deployment Model
    - In Enterprise Architect 378
  - UML Diagram
    - Add To Project 422
    - Copy, Deep 436
    - Copy, Shallow 436
    - Create 422
    - Duplicate 436
    - Extended 673, 733
    - In Enterprise Architect 391
    - MDG Technology 673
    - Overview 673
    - Paste 436
    - Types 673
    - What Is A? 673

- UML Domain Model
  - In Enterprise Architect 376
- UML Element
  - Behavioral Diagram Elements 742
  - Structural Diagram Elements 809
  - Toolbar 83
- UML Maintenance Model
  - In Enterprise Architect 381
- UML Model
  - Add Connectors In Enterprise Architect, Tutorial 32
  - Add Diagram In Enterprise Architect, Tutorial 30
  - Add Element In Enterprise Architect, Tutorial 31
  - Add Element To Diagram, Tutorial 31
  - Add Package In Enterprise Architect, Tutorial 30
  - Add View, Tutorial 29
  - CSV Import And Export In Enterprise Architect 300
  - Define Connector Properties In Enterprise Architect 33
  - Define Element Properties In Enterprise Architect 33
  - Project Roles And Tasks In Enterprise Architect 37
  - Specialized 917
- UML Model Pattern
  - Introduction 373
- UML Model Template
  - In Enterprise Architect 373
  - Introduction 373
- UML Modeling
  - And MDG Technologies 370
  - And Requirements Management In Enterprise Architect 370
  - Build Models 370
  - Business Modeling In Enterprise Architect 370
  - What Is? 370
  - With Enterprise Architect 370
  - With Packages 387
  - With UML Patterns In Enterprise Architect 370
  - With UML Profiles In Enterprise Architect 370
  - With UML Stereotypes In Enterprise Architect 370
- UML Modeling Tool
  - Enterprise Architect - Key Features 8
- UML Pattern
  - Actions 902
  - Add To Diagram 904
  - Create From Diagram 902
  - In Resources View 902
  - Save 902
- Save From Diagram 902
- UML Profile
  - And Element Templates 906, 1093
  - Example File 915
  - Import 908
  - Import From XML 906, 1093
  - Stereotypes 906, 1093
  - Structure 913
  - Supported Attributes 914
  - Synchronize Elements 910
  - Synchronize Stereotypes 910
  - Synchronize Tagged Values And Constraints 910
  - XSD, Stereotypes 1041
- UML Project Model
  - In Enterprise Architect 381
- UML Requirements Model
  - In Enterprise Architect 374
- UML Resources
  - Patterns 901, 904
- UML Structural Diagram
  - Overview 719
- UML Syntax Compliance
  - Turn Off 1530
- UML Testing Model
  - In Enterprise Architect 380
- UML Types
  - Cardinality (Multiplicity) 665
  - Dialog 662
  - Stereotypes 662
  - Tagged Values 664
- UML Use Case Model
  - In Enterprise Architect 375
- UML\_EA.DTD 293
  - File 290
- UML2
  - File Import 291
- Unadjusted Use Case Points 338
- Undo
  - Last Action, Diagram Edits 458
  - Option (Edit Menu) 57
- Unified Modeling Language 672
- Unique
  - Constraint 1033
  - Index 1033
- Unit Test Command
  - Introduction 1483
- Unit Test Script
  - Create 1483
- Unit Testing 1539
  - Create Test Scripts, Execution Analysis 1512
  - Define Tests, Execution Analysis 1512

- Unit Testing 1539
  - Introduction, Execution Analysis 1512
  - JUnit 1512
  - NUnit 1512
  - Record Test Results, Execution Analysis 1514
  - Run, Execution Analysis 1513
  - Set Up, Execution Analysis 1512
- Unlock
  - Connector 200
  - Element 200
- Unpin
  - Toolbox Pages 401
- Update
  - Element Phase, For Package 340
  - Element Status, For Package 340
  - Element Version, For Package 340
  - Package Phase 340
  - Package Status 340
  - Package Version 340
- Upgrade
  - Existing License (v. 6.5 And Earlier) 1873
  - Existing License (v. 7.0+) 1873
  - Model 346, 347
  - Models, Upgrade Wizard 347
  - Project 346
  - Replicas 186, 347
  - Wizard 347
- Upsize
  - From Desktop and Professional Editions 122
  - To Access 2007 169
  - To MySQL 178
  - To Oracle 175
  - To PostgreSQL 173
  - To Progress OpenEdge 171
  - To SQL Server 176
  - To SQL Server Desktop Engine (MSDE) 173
  - To Sybase Adaptive Server Anywhere (ASA) 170
- Usage
  - Connector 894
  - Of Element 526
  - Relationship 894
- Use
  - Classifiers 520
  - Connector 894
  - Pattern 904
  - Profiles 907
  - Relationship 894
  - Spell Checker 1552
- Use Case
  - And Requirements 922
  - Arrowhead, Show 625
  - Element 806
  - Elements and Connectors 406
  - Extension Points 807
  - Group, Toolbox 406
  - Keyword 338
  - Metrics 335
  - Metrics Dialog 338
  - Model Template 375
  - Phase 338
  - Points, Unadjusted 338
  - Rectangle Notation 808
  - Scenarios 710
  - View 383
- Use Case Diagram
  - Description 676
  - Elements And Connectors 676
  - Example 676
- Use Element Extras
  - Automation Interface Code Example 1769
- Use Repository Extras
  - Automation Interface Code Example 1772
- User
  - Default Fonts 357
  - Defined Searches, Storage 1239
  - Dictionary, For Spell Checker 1553
  - Directory 645
  - Forum 24
  - Groups 191
  - ID, Import From Active Directory 192
  - Settings 1343
- User Interface
  - Components 48
  - Control Element 849
  - Design 734
  - Element 849
  - Elements and Connectors 419
  - Group, Toolbox 419
  - Screen Prototype 847
- User Interface Diagram
  - Description 738
  - Elements And Connectors 738
  - Example 738
- User Lock
  - Identify Owner 207
  - Indicators 206
- User Security
  - Add Connector To Locked Element 204
  - Apply User Lock 205
  - Assign User To Group 194
  - Basics 188
  - Change Password 202
  - Disable 189

- User Security
    - Enable 189
    - Identify Lock Owner 207
    - Import User ID From Active Directory 192
    - List Of Permissions 198
    - Lock Elements & Diagrams 204
    - Lock Packages 205
    - Locked Element Indicators 206
    - Maintain Groups 197
    - Maintain Users 191
    - Manage User-level Locks. 207
    - Password Encryption 200
    - Policy 190
    - Re-enable 189
    - Release Elements & Diagrams 204
    - Reset Password 202
    - Set Group Permissions 197
    - Set Password 202
    - Set Up Single Permissions 195
    - Tasks 188
    - View All Permissions 196
    - View And Manage Locks 200
    - What Is User Security? 188
  - User Security Groups
    - Assign User To 194
    - Set Up 194
  - User Settings
    - Options Dialog 90
  - User/Group Lock
    - Release 204
    - Set 204
  - User/Group Lock Policy 190
  - Using Enterprise Architect
    - Application Workspace 48
    - Remove Recent Project 56
    - Start Page 50
  - Utility
    - Compare 279
    - Diff 279
  - UUCP
    - Estimate Project Size 338
- V -**
- Validate
    - Business Rules 950
    - Package Configuration For Version Control 260
    - Rule Composer 950
  - Validation
    - Cancel 64
    - Of Diagram 1528
    - Of Element 1528
    - Of Model, Configure 1530
    - Of Model, Configure For MDG Technology 1145
    - Of Package 1528
    - Rules, Model 1530
  - Validation, Properties
    - Attribute 1532
    - Element 1532
    - Feature 1532
    - Relationship 1532
  - Validation, Well Formedness
    - Attribute 1531
    - Diagram 1531
    - Element 1531
    - Feature 1531
    - Relationship 1531
  - Value Lifeline Element 808
    - Add States 696
    - Add To Timing Diagram 696
    - Add Transitions 696
    - Change Transition Time 696
    - Delete Transitions 696
    - Edit Transitions 696
    - Sizing and Scale 696
    - States 696
    - Transitions 696
  - ValueOf Field
    - RTF Style Template Editor 1586
  - Variable
    - Debug, Break On Change In Value 1477
    - Definitions, Code Template Syntax 1200
    - Definitions, Examples 1200
    - References, Code Template Syntax 1200
    - References, Examples 1200
  - VB
    - Set Up In Automation Interface 1668
  - VB.NET
    - Code Generation 1358
    - Language Options 1358
    - Modeling Conventions 1296
  - VBScript 1660, 1661
  - Verilog
    - Code Generation 1358
    - Enterprise Architect Toolbox Pages 1298
    - Language Options 1358
    - Modeling Conventions 1298
  - Version Control
    - And Reference Data 231
    - And Replication 256
    - And Sequence Diagram 710
    - Apply To Enterprise Architect Model 231

- Version Control
  - Apply To Model Branch 264
  - Basics 230
  - Branching 232
  - Check In and Check Out Packages 261
  - Configuration 229, 233, 234, 265
  - Configuration, Team Deployment 232
  - Configuration, Use Previously-Defined 260
  - Configure Current Package 256
  - Configure In Subversion 250
  - Configure Package 259
  - Connect Model Using TFS 253
  - Considerations 229
  - Controlled Packages 293
  - Copy-Modify-Merge Policy 230
  - CVS Options 240, 244
  - CVS Remote Repository 240
  - Discussion Of File Control 231
  - Export Model Branch 264
  - Features 228
  - File History 257
  - File Properties 257
  - Import Model Branch 265
  - In Team Deployment 232
  - Include Other Users' Packages 263
  - Introduction 229
  - Locking - Necessary? 230
  - Lock-Modify-Unlock Policy 230
  - Manual, With XMI 299
  - Menu (Package) 257
  - Menu (Project) 256
  - Nested Packages 231
  - Offline 268
  - Package Configuration, Validate 260
  - Policies 230
  - Project Browser Indicators 233
  - Recommendations 256
  - Refresh View Of Shared Model 267
  - Resynchronize Package Version Control Status 267
  - Resynchronize Status Of All Packages 256
  - Review Version Control History 266
  - SCC Options 236
  - SCC, Providers Dialog SCC, Providers Dialog 236
  - SCC, Upgrade For Enterprise Architect 4.5 239
  - Set Up 233
  - Settings 234, 256
  - Setup Menu 256
  - Submenu (Project Menu) 65
  - Subversion Options 247
  - Subversion, Create Local Working Copy 249
  - Subversion, Create New Repository Subtree 248
  - Subversion, Setting Up 247
  - Subversion, TortoiseSVN 252
  - Subversion, Using With Enterprise Architect Under WINE Crossover 249
  - System Requirements 229
  - Tasks 256
  - TFS Option 253
  - Usage Scenarios 230
  - Use Nested Version Control Packages 236
  - Using 256
  - Validate Package Configurations 256
  - Who Has Checked Out A Package? 257
  - Work Offline 256
- Version Controlled Package
  - Icon 1213
- VHDL
  - Code Generation 1359
  - Enterprise Architect Toolbox Pages 1299
  - Language Options 1359
  - Modeling Conventions 1299
- View
  - Add To UML Model, Quick Start 29
  - Audit 274
  - Create, Data Modeling 1032
  - Database 1032
  - Element List 1255
  - Element, Data Modeling 1032
  - Locks 200
  - Menu 58
  - Next Diagram 455
  - Of Model 1222
  - Previous Diagram 455
  - Project Statistics 60
  - Report On, Data Modeling 1032
  - Requirements 928
  - Submenus 59
  - Tabs 397
- View Options
  - Diagram View 396
  - Element List 1255
- Views
  - Add 383
  - Class 383
  - Component 383
  - Delete 385
  - Deployment 383
  - Dynamic 383
  - Manage 383
  - Rename 384

- Views
  - Simple 383
  - Use Case 383
- Virtual Document
  - Add Packages As Attributes 1620
  - Change Package Sequence 1622
  - Consecutive Numbering Through 1623
  - Create Master Document For 1618
  - Create Model Document For 1619
  - Delete Package Attributes 1621
  - Delete Packages 1621
  - Document Order 1622
  - Generate RTF Report From 1623
  - Introduction 1616
  - Master Document Element 1616
  - Model Document Element 1616
  - Model Search Sequence 1622
  - Move Package Attributes Between Elements 1622
  - Numbering Through 1623
  - RTF Bookmarking In 1616
  - Sequence of Model Document Elements 1622
  - Sequence of Package Attributes 1622
  - Tagged Values For Master Document 1618
- Visibility Indicators 427
  - Values 1282
- Visibility Of Elements
  - Customize 535
- Visible Class Members
  - Set Diagram Appearance Options 429
- Visio
  - MDG Link For, Enterprise Architect 1073
- Vista
  - Permissions For Enterprise Architect 21
- Visual Basic
  - Code Generation 1360
  - Connect To Automation Interface 1666
  - Import, Reverse Engineering 1331
  - Language Options 1360
  - Modeling Conventions 1301
  - Set Up In Automation Interface 1668
- Visual Basic.Net
  - Import, Reverse Engineering 1331
- Visual Execution Analyzer
  - Access 1488
  - Add State Transitions 1507
  - Advanced Debug Techniques, Java 1454
  - Automatic Recording, Record Sequence Diagrams 1504
  - Availability 1488
  - Break On Variable Changing Value 1477
  - Breakpoint Management 1468
  - Breakpoint Storage 1469
  - Breakpoints And Markers Window, Record Sequence Diagrams 1503
  - Build Script, Create 1444
  - Control Recording, Record Sequence Diagrams 1504
  - Create Sequence Diagram, Call Stack 1480
  - Debug .NET 1460
  - Debug .NET Assembly 1461
  - Debug .NET CLR Versions 1462
  - Debug .NET With COM Interop Process 1463
  - Debug Another Process 1472
  - Debug Apache Tomcat Server Configuration 1459
  - Debug Apache Tomcat Windows Service 1460
  - Debug ASP .NET 1463
  - Debug Java 1452
  - Debug Java Applets In Internet Browsers 1454
  - Debug Java Web Servers 1456
  - Debug JBOSS Server Configuration 1458
  - Debug Symbols, C++ And Native Applications 1452
  - Debugger Frameworks 1446
  - Debugger System Requirements 1447
  - Debugger Windows, Display 1471
  - Debugger, Overview 1446
  - Debugging Actions 1470
  - Deploy Script, Create New 1484
  - Deploy Script, Introduction 1484
  - Diagram Features, Generate Sequence Diagrams 1507
  - Difference Between Recording Marker And Breakpoint 1503
  - Execution Analysis, Introduction 1490
  - File Search, Introduction 1485
  - File Search, Use 1485
  - For C++ Applications 1451
  - For Microsoft Native Applications 1451
  - For WINE Applications 1450
  - General Debug Setup, Java 1453
  - Generate Sequence Diagram 1505, 1507
  - Inspect Process Memory 1476
  - Java Debug Session, Attach To VM 1454
  - Manual Recording, Record Sequence Diagrams 1504
  - Map State Changes 1511
  - Marker Management 1468
  - Marker Storage 1469
  - Marker Types, Record Sequence Diagrams 1499
  - MDDE Basic Setup 1425
  - MDDE External Tools 1425
  - MDDE, Build Scripts 1443



- Visual Execution Analyzer
  - MDDE, Code Editors 1425
  - MDDE, Default Script, Set 1428
  - MDDE, Generate Code 1425
  - MDDE, Package Build Scripts, Manage 1426
  - MDDE, Script Actions, Define 1427
  - MDDE, Synchronize Code 1425
  - Object Workbench, Create Variables 1521
  - Object Workbench, Introduction 1519
  - Object Workbench, Invoke Methods 1522
  - Object Workbench, Overview 1520
  - Object Workbench, Variables 1521
  - Outputs 1488
  - Overview 1488
  - Pause Recording, Record Sequence Diagrams 1505
  - Pin/Unpin A Package 1428
  - Place Markers, Recording Sequence Diagrams 1499
  - Profiler Overview 1514
  - Record Activity For Class 1497
  - Record Activity For Method 1498
  - Record Sequence Diagrams, Advanced Techniques 1497
  - Record Sequence Diagrams, Enable Filter 1493
  - Record Sequence Diagrams, Introduction 1490
  - Record Sequence Diagrams, Overview 1491
  - Record Sequence Diagrams, Prerequisites 1492
  - Record Sequence Diagrams, Recording Options 1492
  - Record Sequence Diagrams, Set Up 1492
  - Record State Changes 1511
  - Record Unit Test Results 1514
  - Recording Actions 1480
  - Recording History 1506
  - Recording Markers, Activate, Record Sequence Diagrams 1503
  - Recording Markers, Disable, Record Sequence Diagrams 1503
  - Recursive Builds 1446
  - Resume Recording, Record Sequence Diagrams 1505
  - Run Script, Create New 1482
  - Run Script, Introduction 1482
  - Run Unit Test 1513
  - Save Call Stack 1482
  - Save Recording History 1507
  - Script Search 1485
  - Search Window 1485
  - Sequence Diagrams, Enable Diagnostic Messages 1496
  - Sequence Diagrams, Limit Auto Recording 1496
  - Sequence Diagrams, Record Arguments To Function Calls 1494
  - Sequence Diagrams, Record Calls To Dynamic Modules 1495
  - Sequence Diagrams, Record Calls To External Modules 1494
  - Set Code Breakpoint 1469
  - Set Data Breakpoint 1470
  - Set Recording Markers, Record Sequence Diagrams 1502
  - Set Up Debug Session 1447
  - Set Up Debug Session For .NET 1461
  - Set Up To Capture State Changes 1508
  - Show Loaded Modules 1478
  - Show Output 1478
  - Start Debugger 1471
  - State Machine Diagram 1509
  - State Transition Diagram 1509
  - Step Into Function Calls 1473
  - Step Out Of Functions 1473
  - Step Over Lines Of Code 1472
  - Step Though Function Calls 1480
  - Stop Debugger 1471
  - Stop Recording, Record Sequence Diagrams 1505
  - Structure 1489
  - Tooltips In Code Editor 1479
  - UAC-Enabled Operating Systems 1448
  - Unit Test Script, Create 1483, 1512
  - Unit Test Script, Introduction 1483
  - Unit Test, Record Results 1514
  - Unit Testing, Introduction 1512
  - Uses Of 1488
  - View Call Stack 1473
  - View Local Variables 1474
  - View Local Variables, Long Values 1474
  - View Variables In Other Scopes 1475
  - Work With Marker Sets, Record Sequence Diagrams 1503
  - Workspace Layouts 1424
- Visual Execution Profiler
  - Attach To Process 1517
  - Getting Started 1516
  - Launch 1517
  - Operation 1517
  - Overview 1514
  - Prerequisites 1516
  - Report, Example 1514
  - Report, Load 1518
  - Report, Save 1518

## Visual Execution Profiler

- Report, Save As Resource In Team Review 1519
- Set Options 1518
- Set Sample Intervals 1518
- Start 1517
- Stop 1517
- Supported Platforms 1516
- System Requirements 1516
- Team Review, Save Report As Resource 1519
- Toolbar 1516

## Visual Execution Sampler

- Attach To Process 1517
- Getting Started 1516
- Launch 1517
- Operation 1517
- Overview 1514
- Prerequisites 1516
- Report, Example 1514
- Report, Load 1518
- Report, Save 1518
- Report, Save As Resource In Team Review 1519
- Set Options 1518
- Set Sample Intervals 1518
- Start 1517
- Stop 1517
- Supported Platforms 1516
- System Requirements 1516
- Team Review, Save Report As Resource 1519
- Toolbar 1516

## Visual Representation

- Of Elements, Introduction 520

## Visual Studio 2005/2008

- MDG Integration For, Enterprise Architect 1073

## Visual Studio.NET

- MDG Link For, Enterprise Architect 1073

## Visual Styles

- Microsoft Office Styles 101
- Microsoft Visual Basic Styles 101
- Options 101
- Select 101
- Submenu 59
- Themes 59
- View Menu Option 58

## Visualize Systems

- Enterprise Architect 5

## VM

- Attach To In Java Debug Session 1454

**- W -**

## W3C XML

- Technologies, Introduction 1039

## W3C XSD

- Elements and Connectors, Enterprise Architect 420

## W3CWSDL

- Elements And Connectors, Enterprise Architect 420

## WAN Optimization

- Enterprise Architect Performance 148, 150, 153, 160, 162, 165
- For ASA Data Repository 162
- For MSDE Server Data Repository 165
- For MySQL Data Repository 148
- For Oracle Data Repository 153
- For PostgreSQL Data Repository 160
- For Progress OpenEdge Data Repository 165
- For SQL Server Data Repository 150

## WAN Optimizer

- Introduction 180
- Performance Of Enterprise Architect 180
- Transmission Diagram 180

## Watched Items

- Debugger 1475

## Watches Window 1475

- Break On Variable Changing Value 1477

## Watermark

- Diagrams 356

## Web

- Page Modeling 851
- Report Style Templates 1649
- Stereotypes 851
- Templates, Reporting 1649

## Web Browser

- Home Website, Access 103
- Internet Email, Access 103
- Web Search Engine, Access 103

## Web Page

- Prototype 847

## Web Server

- Java, Debug 1456

## Web Service

- Create In BPEL 983
- Submenu (Project Menu) 64

## Web Service Definition Language 1049

- Web Services (WSDL) 1049
- Generate WSDL 1379
- Import WSDL Files 1376
- Model WSDL 1050

- Web Services (WSDL) 1049
  - Model WSDL, Binding 1057
  - Model WSDL, Document 1053
  - Model WSDL, Message 1056
  - Model WSDL, Message Part 1060
  - Model WSDL, Namepaces 1051
  - Model WSDL, Port Type 1056
  - Model WSDL, Port Type Operation 1059
  - Model WSDL, Service 1054
- Web Services Business Process Execution Language (WS-BPEL) 958
- Web Site
  - Access Any 103
  - Access Home 103
  - Home, Define Default 351
  - Sparx Systems 23
- Well Formedness Validation
  - Attribute 1531
  - Diagram 1531
  - Element 1531
  - Feature 1531
  - Relationship 1531
- What Is
  - A Check Constraint? 1033
  - A Connector? 852
  - A Foreign Key? 1024
  - A Model? 372
  - A Pattern? 901
  - A Primary Key? 1022
  - A Project? 113
  - A Requirement? 917
  - A Stored Procedure? 1030
  - A Tagged Value 632
  - A Trigger Operation? 1033
  - An Index? 1033
  - Enterprise Architect? 4
  - User Security? 188
  - XMI? 288
- Wide Area Network (WAN) Optimizer
  - Introduction 180
  - Performance Of Enterprise Architect 180
  - Transmission Diagram 180
- Window
  - Add-Ins 58
  - Autohide 78
  - Breakpoints And Markers 1503
  - Bring To Top 74
  - Call Stack 1473, 1479
  - Close All 74
  - Close All Except Current 74
  - Close Current 74
  - Combine In Frame 76
  - Connections 1269
  - Constraints 514
  - Debug 1467
  - Diagram Filter 1272
  - Dock 76
  - Element Browser 510
  - Floating 76
  - Generalized Functions 102
  - Hide 74
  - Layout Tools 458
  - Links 1269
  - Locals 1474
  - Locals, View Long Values 1474
  - Maintenance 1558
  - Make Active 74
  - Memory Viewer 1476
  - Menu 74
  - Model Views 1222
  - Modules 1478
  - Notes 641
  - Output 102
  - Output, Debugger 1478
  - Pan And Zoom 1275
  - Project Management 312
  - Properties (Element) 508
  - Record & Analyze 1506
  - Relationships 1269
  - Reload 74
  - Remove From Frame 76
  - Requirements 514
  - Resources 667
  - Reveal Autohidden 78
  - Scenarios 514
  - Scenarios & Requirements 514
  - Scripter 1660
  - Search, Debugging 1485
  - System 323
  - Tagged Value 632
  - Tasks Pane 51
  - Team Review 208
  - Traceability 1253
  - Watches 1475
  - Watches, Break On Variable Changing Value 1477
  - Workbench 1521
- Windows
  - Authentication 191
  - Service, Apache Tomcat 1460
- Windows 7
  - Use Debugger 1448
- Windows Active Directory
  - Import User Login ID From 192

- Windows Authentication
    - Accept 192
  - Windows Vista
    - Permissions For Enterprise Architect 21
    - Use Debugger 1448
  - WINE
    - Debugging 1450
    - DIB Data Access Violation 1450
  - WINE-Crossover
    - Using Subversion With Enterprise Architect Under 249
  - Word
    - Special Considerations 1641
  - Word Substitution
    - RTF Report Generation 1615
  - Wordpad
    - Open 70
  - Work Flow
    - Monitor With Model Views 342
  - Work With
    - Attributes, Automation Interface Code Example 1773
    - Enterprise Architect 4
    - Methods, Automation Interface Code Example 1774
  - Workbench Variables
    - Constraints 1521
    - Constructors 1521
    - Create 1521
    - Delete 1521
    - Requirements 1521
  - Workbench Window 1521
  - Workflow
    - Data Structures 220
    - Objects 220
    - Script Functions 220
    - Script, Import 1661
    - Scripts 1663
    - Scripts, Introduction 220
  - Working
    - With MDG Technologies 1067
    - With UML Connectors 606
  - Workspace
    - Toolbars, Docked 79
    - Toolbars, Introduction 79
  - Workspace Layout
    - For Execution Analysis 1424
  - Workspace Layouts
    - Apply 86
    - Capture 86
    - Customize 86
    - Delete 86
    - Manage 86
    - Select 86
    - Show/Hide From Toolbar 86
    - System Provided 86
    - Toolbar 86
    - Upgrade Customized 86
    - User Defined 86
    - View Menu Option 58
  - WS-BPEL 958
  - WSDL
    - Binding Diagram 1057
    - Binding Element 1057
    - Document Element 1053
    - Elements And Connectors 420
    - Group, Toolbox 420
    - Import 1376, 1379
    - Message Diagram 1056
    - Message Element 1056
    - Model 1050
    - Namespace Element 1051
    - Overview Diagram 1051
    - Port Type Diagram 1056
    - Port Type Element 1056
    - Port Type Operation 1059
    - Service Diagram 1054
    - Service Element 1054
    - Split Files 1376
    - Toolbox Pages 1050
    - Transformation 1408
    - Web Services 1050
  - WSDL Support
    - Introduction 1049
- X -**
- XMI
    - Export 288, 289
    - Export MOF To 1383
    - Import 288, 290
    - Import And Auditing 279
    - Import MOF From 1383
    - Limitations 293
    - Manual Version Control 299
    - Specifications 288
    - UML DTD 293
  - XMIType Enum
    - Automation Interface 1679
  - XML
    - Code Page 367
    - Default XMI Version 367
    - Documents, Default Editor 367

- XML
  - Import Referenced Schema 1373
  - Package 293
  - Pattern File 901, 902
  - Set Default XML Directory 367
  - Set Default XML Editor 367
  - Specifications, Options Dialog 367
  - Structure Tree In Source Code Viewer 1441
  - Technologies, Introduction 1039
  - XMI 1.0 Prefix 367
- XML Engineering 1373
- XML Schema
  - Elements and Connectors 420
  - Generate In Garden Of Eden Style 1378
  - Group, Toolbox 420
  - Submenu (Project Menu) 64
  - UML Profile For XSD 1041
  - XSD 1039
- XSD
  - Abstract Models 1047
  - Datatype Packages 1047
  - Generate 1376
  - Import 1373
  - Import, Global Element Behaviour 1375
  - Model 1040
  - Transformation 1409
  - XML Schema 1039
- XSDany 1041
- XSDattribute 1041
- XSDattributeGroup 1041
- XSDchoice 1041
- XSDcomplexType 1041
- XSDelement 1041
- XSDgroup 1041
- XSDrestriction 1041
- XSDschema 1041
- XSDsequence 1041
- XSDsimpleType 1041
- XSDtopLevelAttribute 1041
- XSDtopLevelElement 1041
- XSDunion 1041

## - Z -

- Z Order
  - Elements 437
- Zachman
  - Profile 444
- Zachman Framework
  - MDG Technology For, Enterprise Architect 1073
- Zoom
  - Control On Status Bar 89
  - Diagram From Toolbar 83
  - Diagram View 453
  - Submenu 453
- Zooming
  - Code Editor, Common 1432
- Z-Order
  - Submenu 70



# Enterprise Architect User Guide

[www.sparxsystems.com](http://www.sparxsystems.com)